

**CHANGE**

**U.S. DEPARTMENT OF TRANSPORTATION  
FEDERAL AVIATION ADMINISTRATION**

**ORDER  
8260.19H CHG 1**

Effective Date:  
04/26/2018

National Policy

**SUBJ:** Flight Procedures and Airspace

---

**1. Purpose.** This change incorporates the updated Flight Standards organization structure while removing all Flight Standards routing symbols/codes. Also, this change transfers approval authority for special instrument flight procedures from the Flight Technologies and Procedures Division to the Flight Procedure Implementation and Oversight Branch. It assigns the Flight Procedure Implementation and Oversight Branch as the approval authority for instrument flight procedures that require specific approval (as identified in this and other 8260-series orders), or that require waivers to procedure design standards. In addition, the approval authority for Attention All Users Pages (AAUP) have been moved from the Flight Technologies and Procedures Division to the Flight Operations Branch. These changes are intended to reduce administrative redundancies and improve customer response times. Other editorial changes unrelated to policy and/or guidance have been made to correct publishing errors throughout the document.

**2. Who this change affects.** This change affects only the internal processes within Flight Technologies and Procedures Division.

**3. Where You Can Find This Change.** You can find this change on the Directives Management System (DMS) Website: [http://www.faa.gov/regulations\\_policies/orders\\_notices](http://www.faa.gov/regulations_policies/orders_notices).

**4. Explanation of Changes.** Significant areas of new direction, guidance, policy and/or criteria as follows:

**a. General.** Throughout the document, Flight Standards' routing symbols/codes have been removed and replaced with the appropriate organizational title.

**b. Chapter 1.**

(1) Paragraph 1-2-2.a. Deleted last sentence that indicated the division (i.e., Flight Technologies and Procedures Division) is responsible for the approval/disapproval of special instrument flight procedures and waivers.

**c. Paragraph 1-2-2.f.** Revised description of Flight Procedure Implementation and Oversight Branch's responsibilities to be inclusive of having the approval authority for specials, approvals, and waivers.

**d. Chapter 2.**

(1) Paragraph 2-12-1, General. Revised language to reflect the Flight Procedure Implementation and Oversight Branch may permit deviations to standards.

(2) Paragraph 2-12-6.a. Replaced “AFS-400” with “Flight Procedure Implementation and Oversight Branch.”

(3) Paragraph 2-12-6.c. Replaced “AFS-400” with “Flight Procedure Implementation and Oversight Branch.”

e. Chapter 4.

(1) Paragraph 4-5-3.m. Replaced “AFS-400” with “Flight Procedure Implementation and Oversight Branch.”

f. Chapter 8.

(1) Table 8-3-2. In the top two rows related to Form 8260-1, replaced “AFS-400” with “Flight Procedure Implementation and Oversight Branch.”

(2) Paragraph 8-4-1. Replaced “AFS-400” with “Flight Procedure Implementation and Oversight Branch.”

(3) Paragraph 8-4-1.i. Revised text to remove “AFS-400” from the waiver process and to replace with “Flight Procedure Implementation and Oversight Branch.”

(4) Paragraph 8-5-2.t(4). Replaced “AFS-400” with “Flight Procedure Implementation and Oversight Branch.”

(5) Paragraph 8-6-9.j. Replaced “Flight Standards” with “Flight Procedure Implementation and Oversight Branch.”

(6) Paragraph 8-6-9.m. Replaced “Flight Standards” with “Flight Procedure Implementation and Oversight Branch.”

(7) Paragraph 8-6-10.o, Note 1. Replaced “AFS-400” with “Flight Procedure Implementation and Oversight Branch.”

(8) Paragraph 8-6-11.o(2)(h). Replaced “AFS-400” with “Flight Procedure Implementation and Oversight Branch.”

(9) Paragraph 8-6-17. Replaced “AFS-400” with “Flight Procedure Implementation and Oversight Branch.”

(10) Paragraph 8-6-18.b(2). Replaced “AFS-460 Manager” with “Flight Procedure Implementation and Oversight Branch.”

(11) Paragraph 8-10-4. Revised to indicate Flight Operations Branch as the approval authority for AAUPs.

(12) Paragraph 8-10-5. Replaced instances of “AFS-400” with “Flight Operations Branch.”

(13) Paragraph 8-10-9.c. Replaced “AFS-400” with “Flight Operations Branch.”

### PAGE CHANGE CONTROL CHART

Remove Pages	Dated	Insert Pages	Dated
i through ii	07/20/2017	i through ii	04/26/2018
v through viii	07/20/2017	v through viii	04/26/2018
1-11 through 1-20	07/20/2017	1-11 through 1-20	04/26/2018
2-1 through 2-4	07/20/2017	2-1 through 2-4	04/26/2018
2-19 through 2-22	07/20/2017	2-19 through 2-22	04/26/2018
2-27 through 2-28	07/20/2017	2-27 through 2-28	04/26/2018
2-33 through 2-34	07/20/2017	2-33 through 2-34	04/26/2018
2-41 through 2-44	07/20/2017	2-41 through 2-44	04/26/2018
3-9 through 3-12	07/20/2017	3-9 through 3-12	04/26/2018
4-1 through 4-2	07/20/2017	4-1 through 4-2	04/26/2018
4-5 through 4-8	07/20/2017	4-5 through 4-8	04/26/2018
4-13 through 4-14	07/20/2017	4-13 through 4-14	04/26/2018
4-23 through 4-24	07/20/2017	4-23 through 4-24	04/26/2018
4-59 through 4-60	07/20/2017	4-59 through 4-60	04/26/2018
5-1 through 5-2	07/20/2017	5-1 through 5-2	04/26/2018
5-35 through 5-36	07/20/2017	5-35 through 5-36	04/26/2018
5-39 through 5-44	07/20/2017	5-39 through 5-44	04/26/2018
6-1 through 6-2	07/20/2017	6-1 through 6-2	04/26/2018
7-1 through 7-4	07/20/2017	7-1 through 7-4	04/26/2018
7-13 through 7-16	07/20/2017	7-13 through 7-16	04/26/2018
8-1 through 8-4	07/20/2017	8-1 through 8-4	04/26/2018
8-11 through 8-12	07/20/2017	8-11 through 8-12	04/26/2018
8-19 through 8-22	07/20/2017	8-19 through 8-22	04/26/2018
8-33 through 8-34	07/20/2017	8-33 through 8-34	04/26/2018
8-39 through 8-40	07/20/2017	8-39 through 8-40	04/26/2018
8-49 through 8-50	07/20/2017	8-49 through 8-50	04/26/2018
8-61 through 8-66	07/20/2017	8-61 through 8-66	04/26/2018
8-69 through 8-70	07/20/2017	8-69 through 8-70	04/26/2018
8-77 through 8-78	07/20/2017	8-77 through 8-78	04/26/2018
8-83 through 8-88	07/20/2017	8-83 through 8-88	04/26/2018
8-95 through 8-100	07/20/2017	8-95 through 8-100	04/26/2018
8-103 through 8-110	07/20/2017	8-103 through 8-110	04/26/2018
8-113 through 8-114	07/20/2017	8-113 through 8-114	04/26/2018
8-121 through 8-134	07/20/2017	8-121 through 8-134	04/26/2018
A-1 through A-4	07/20/2017	A-1 through A-4	04/26/2018
C-1 through C-2	07/20/2017	C-1 through C-2	04/26/2018

- 4. Distribution.** This change is distributed electronically only.

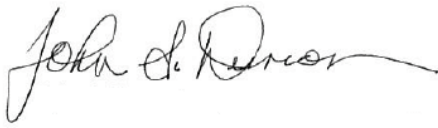
A handwritten signature in black ink, appearing to read "John D. Duncan", with a long, sweeping horizontal stroke extending to the right.

John Duncan  
Executive Director, Flight Standards Service





U.S. DEPARTMENT OF TRANSPORTATION  
FEDERAL AVIATION ADMINISTRATION

**ORDER  
8260.19H**

National Policy

Effective Date:  
07/20/2017

**SUBJ: Flight Procedures and Airspace**

---

This order provides guidance to all FAA personnel for the administration and accomplishment of the FAA Flight Procedures and Airspace Program.

The development of effective and efficient flight procedures is closely related to facility establishment and airport programs. These procedures require active participation by Flight Standards, the applicable Air Traffic Organization (ATO) Service Area, and office of Airports personnel in the planning, programming, and budgeting of navigation facilities and airport development plans. Instrument procedures often determine the alignment and location of navigation facilities as well as the location, marking, and lighting of airport landing and maneuvering areas. Title 14 Code of Federal Regulations (14 CFR) part 95 establishes minimum en route altitude (MEA), minimum reception altitude (MRA), maximum authorized altitude (MAA), minimum obstruction clearance altitude (MOCA), minimum crossing altitude (MCA), and changeover point (COP) are established by the Federal Aviation Administration for instrument flight along Federal airways.

General information and responsibilities are contained in chapter 1 and guidelines and procedures that are common to all instrument flight procedures are in chapter 2. Chapter 3 and 4 contain specific guidelines and procedures for en route and terminal instrument flight procedures, respectively. Chapter 5 contains information concerning airspace - obstruction evaluation (OE); designation of controlled airspace; airport airspace analysis; restricted areas; and establishment, relocation, or discontinuance of radio navigation aids. Chapter 6 provides information concerning Military procedures. Chapter 7 contains planning standards; airway, terminal, and airport planning; safety analysis; private aid, and facilities and equipment (F&E) support. Chapter 8 provides information on instrument approach procedures data transmittal systems as well as the use and preparation of forms.



John S. Duncan  
Director, Flight Standards Service

THIS PAGE IS INTENTIONALLY LEFT BLANK

## Table of Contents

<b>Chapter 1. General Information .....</b>	<b>1-1</b>
<i>Section 1-1. General .....</i>	<i>1-1</i>
1-1-1. Purpose of this order .....	1-1
1-1-2. Audience .....	1-1
1-1-3. Where you can find this order .....	1-1
1-1-4. What this order cancels .....	1-1
1-1-5. Explanation of changes .....	1-1
1-1-6. Effective Date .....	1-10
<i>Section 1-2. Responsibilities .....</i>	<i>1-11</i>
1-2-1. Flight Standards Service .....	1-11
1-2-2. Flight Technologies and Procedures Division .....	1-11
1-2-3. Air Traffic Organization, Flight Program Operations .....	1-14
1-2-4. Air Traffic Organization, Mission Support Services (AJV-0) .....	1-15
1-2-5. Individual .....	1-19
<b>Chapter 2. General Procedures .....</b>	<b>2-1</b>
<i>Section 2-1. General .....</i>	<i>2-1</i>
2-1-1. Requests for public-use IFPs .....	2-1
2-1-2. Air Traffic Letters of Agreement (LOAs) .....	2-1
2-1-3. Airport lighting and visual aids .....	2-1
<i>Section 2-2. Aeronautical Charts .....</i>	<i>2-3</i>
2-2-1. Use of maps and charts .....	2-3
2-2-2. Aeronautical charts and publications .....	2-3
<i>Section 2-3. Environmental Requirements .....</i>	<i>2-5</i>
2-3-1. Noise abatement .....	2-5
2-3-2. Environmental impacts .....	2-5
<i>Section 2-4. Facility Utilization and Monitoring .....</i>	<i>2-6</i>
2-4-1. Frequency Service Volumes .....	2-6
2-4-2. ATC usable distance and altitude limitations .....	2-6
2-4-3. Requests for Expanded Service Volumes .....	2-8
2-4-4. Utilization of localizers .....	2-9
2-4-5. Monitoring of navigation facilities .....	2-9
2-4-6. Utilization of monitoring categories .....	2-10
2-4-7. Utilization of 75 MHz markers .....	2-10
<i>Section 2-5. Implementing Epoch Year Magnetic Variation (MV) .....</i>	<i>2-12</i>
2-5-1. General .....	2-12
2-5-2. Responsibilities .....	2-12
2-5-3. Guidelines for Magnetic Variation (MV) revisions .....	2-17

<i>Section 2-6. Notices to Airmen (NOTAMs)</i> .....	2-20
2-6-1. General .....	2-20
2-6-2. United States NOTAM System .....	2-20
<i>Section 2-7. Quality/Standardization of Instrument Flight Procedures</i> .....	2-21
2-7-1. Aeronautical Information Services action .....	2-21
2-7-2. Flight Procedure Implementation and Oversight Branch's action .....	2-21
<i>Section 2-8. Periodic Review of Instrument Flight Procedures</i> .....	2-22
2-8-1. General .....	2-22
2-8-2. Reviewing organization action .....	2-23
<i>Section 2-9. Communications and Weather</i> .....	2-25
2-9-1. Communications requirements .....	2-25
2-9-2. Use of UNICOM .....	2-25
2-9-3. Automatic altimeter setting and weather reporting systems .....	2-25
<i>Section 2-10. Navigational Fixes</i> .....	2-26
2-10-1. General .....	2-26
2-10-2. Reporting points .....	2-26
2-10-3. Unplanned holding at designated reporting points .....	2-26
2-10-4. Requests for navigational fixes .....	2-26
2-10-5. Naming navigational fixes.....	2-27
2-10-6. Documenting navigational fixes.....	2-29
2-10-7. Correlation of navigational fixes and changeover points .....	2-29
2-10-8. Minimum reception altitudes.....	2-30
2-10-9. Flight inspection .....	2-30
2-10-10. Maximum authorized altitudes .....	2-31
<i>Section 2-11. Obstacle Data</i> .....	2-32
2-11-1. General .....	2-32
2-11-2. Obstacle application and data sources .....	2-32
2-11-3. Obstacle data accuracy standards .....	2-33
2-11-4. Accuracy standards application .....	2-34
2-11-5. Controlling obstacles.....	2-35
2-11-6. Datums.....	2-40
<i>Section 2-12. Waiver of Standards/Approval Requests</i> .....	2-42
2-12-1. General .....	2-42
2-12-2. Waiver processing .....	2-42
2-12-3. Waivers for Special Instrument Approach Procedures .....	2-43
2-12-4. Safety Management System (SMS) requirements.....	2-43
2-12-5. Periodic review of waivers .....	2-44
2-12-6. Cancellation.....	2-44

<b>Chapter 3. Route Procedures .....</b>	<b>3-1</b>
<i>Section 3-1. General .....</i>	<i>3-1</i>
3-1-1. General .....	3-1
3-1-2. Publication.....	3-1
<i>Section 3-2. Criteria Application and Development.....</i>	<i>3-2</i>
3-2-1. Criteria application.....	3-2
3-2-2. Development of criteria.....	3-2
<i>Section 3-3. Establishment of En Route Airspace.....</i>	<i>3-3</i>
3-3-1. Relationship of COPs to airspace dimensions.....	3-3
3-3-2. Relationship of MEAs to controlled airspace floors .....	3-3
<i>Section 3-4. Substitute En Route Flight Procedures.....</i>	<i>3-4</i>
3-4-1. General .....	3-4
3-4-2. Format .....	3-4
3-4-3. Facilities used .....	3-4
3-4-4. Controlled airspace.....	3-4
3-4-5. Flight Inspection.....	3-4
3-4-6. Planning and coordination.....	3-5
3-4-7. Processing.....	3-8
3-4-8. Periodic review .....	3-8
3-4-9. Distribution.....	3-8
<i>Section 3-5. Off-Airway Routes.....</i>	<i>3-10</i>
3-5-1. Establishment .....	3-10
3-5-2. Listing.....	3-10
3-5-3. Off-airway data.....	3-10
3-5-4. Processing data to NFDC .....	3-11
<i>Section 3-6. New or Revised National Airspace System Routes .....</i>	<i>3-12</i>
3-6-1. Definition - Route.....	3-12
3-6-2. Coordination Procedures .....	3-12
3-6-3. Publication of procedural data.....	3-12
<i>Section 3-7. Minimum Vectoring Altitude (MVA) and Minimum IFR Altitude (MIA) Charts... </i>	<i>3-13</i>
3-7-1. Chart preparation .....	3-13
3-7-2. Obstacle clearance .....	3-13
3-7-3. Controlled airspace.....	3-13
3-7-4. Chart review and approval .....	3-13
3-7-5. Emergency Obstruction Video Map (EOVM) .....	3-14
<b>Chapter 4. Terminal Procedures .....</b>	<b>4-1</b>
<i>Section 4-1. General .....</i>	<i>4-1</i>
4-1-1. General .....	4-1
4-1-2. Categories of Instrument Approach Procedures.....	4-1
4-1-3. Airspace requirements .....	4-1
4-1-4. Contractual use of private facilities.....	4-2

4-1-5.	TERPS application .....	4-2
4-1-6.	Sidestep maneuvers .....	4-3
4-1-7.	Temporary displaced threshold procedures .....	4-4
<i>Section 4-2. Standard Instrument Approach Procedures (SIAP) .....</i>		<i>4-5</i>
4-2-1.	General .....	4-5
4-2-2.	Coordination of Terminal Instrument Procedures .....	4-5
4-2-3.	Radar Instrument Approach Procedures .....	4-5
<i>Section 4-3. Category II and III ILS .....</i>		<i>4-6</i>
4-3-1.	General .....	4-6
4-3-2.	Action .....	4-7
4-3-3.	NOTAM requirements .....	4-8
<i>Section 4-4. Departure Procedures (DP) .....</i>		<i>4-9</i>
4-4-1.	General .....	4-9
4-4-2.	Diverse Vector Area (DVA) .....	4-9
<i>Section 4-5. Standard Terminal Arrival (STAR) .....</i>		<i>4-10</i>
4-5-1.	General .....	4-10
4-5-2.	Roles and responsibilities .....	4-16
4-5-3.	Preparation of Form 8260-17.1 .....	4-20
4-5-4.	Preparation of Form 8260-17.2 .....	4-45
<i>Section 4-6. RNAV Procedure Development .....</i>		<i>4-55</i>
4-6-1.	General .....	4-55
4-6-2.	RNAV Approach Procedure design .....	4-55
4-6-3.	Developing RNAV waypoint .....	4-57
4-6-4.	RNAV leg types .....	4-59
4-6-5.	RNAV leg type descriptions .....	4-59
4-6-6.	Final Approach Segment (FAS) data .....	4-60
4-6-7.	Remote altimeter setting for Baro-VNAV .....	4-60
4-6-8.	Critical temperature .....	4-60
4-6-9.	DME/DME screening model .....	4-60
4-6-10.	Additional documentation with Baro-VNAV .....	4-61
<b>Chapter 5. Airspace .....</b>		<b>5-1</b>
<i>Section 5-1. Obstruction Evaluation (OE) .....</i>		<i>5-1</i>
5-1-1.	General .....	5-1
5-1-2.	Responsibility and Processing of Form 7460-1 .....	5-1
5-1-3.	Review of Notices .....	5-1
5-1-4.	Adjustments to Instrument Flight Procedures .....	5-1
<i>Section 5-2. Designation of Controlled Airspace .....</i>		<i>5-2</i>
5-2-1.	General .....	5-2
5-2-2.	Air Traffic Responsibility .....	5-2
5-2-3.	Aeronautical Information Services action .....	5-2
5-2-4.	Terminal Airspace .....	5-3

*Section 5-3. Airport Airspace Analysis* ..... 5-39

5-3-1. General ..... 5-39

5-3-2. Service Area OSG-FPT/Flight Standards inputs ..... 5-39

5-3-3. Flight Standards performs the flight safety review of airport proposals ..... 5-39

5-3-4. Service Area OSG-FPT is responsible for evaluation ..... 5-39

5-3-5. Alterations of airports or heliports ..... 5-40

5-3-6. Deactivation of airports or heliports ..... 5-40

5-3-7. Assistance in zoning problems ..... 5-41

*Section 5-4. Restricted Areas* ..... 5-42

5-4-1. General ..... 5-42

5-4-2. Letter of procedures ..... 5-42

*Section 5-5. Establishment, Relocation, or Discontinuance of Radio Navigation Aids* ..... 5-43

5-5-1. Criteria and guidelines ..... 5-43

5-5-2. OSG-FPT action ..... 5-43

5-5-3. Flight Standards action ..... 5-43

**Chapter 6. Military Procedures** ..... **6-1**

6-1-1. General ..... 6-1

6-1-2. Review and coordination ..... 6-1

6-1-3. FAA acceptance ..... 6-1

6-1-4. Assistance ..... 6-1

**Chapter 7. Planning** ..... **7-1**

*Section 7-1. General* ..... 7-1

7-1-1. General ..... 7-1

*Section 7-2. Planning Standards* ..... 7-2

7-2-1. Planning standards ..... 7-2

7-2-2. Determination of operational benefits/improvements ..... 7-2

*Section 7-3. Safety Analysis* ..... 7-4

7-3-1. Performing a Safety Analysis ..... 7-4

*Section 7-4. Airway Planning* ..... 7-7

7-4-1. General ..... 7-7

*Section 7-5. Terminal Planning* ..... 7-8

7-5-1. General ..... 7-8

7-5-2. Requirements for outer compass locators ..... 7-8

*Section 7-6. Airport Planning* ..... 7-13

7-6-1. General ..... 7-13

*Section 7-7. Private Aid* ..... 7-14

7-7-1. General ..... 7-14

*Section 7-8. Facilities and Equipment (F&E) Support* ..... 7-15

7-8-1. Support ..... 7-15

**Chapter 8. Instrument Approach Procedures Data Transmittal System ..... 8-1**

<i>Section 8-1. General</i> .....	8-1
8-1-1. General .....	8-1
<i>Section 8-2. FAA Form Use and Preparation</i> .....	8-2
8-2-1. Use of FAA forms .....	8-2
8-2-2. FAA form preparation .....	8-3
8-2-3. Course and distance information .....	8-4
8-2-4. Communications data .....	8-4
8-2-5. Terminal routes - General .....	8-5
8-2-6. Terminal fixes .....	8-9
<i>Section 8-3. Certification, Processing, and Review</i> .....	8-11
8-3-1. General .....	8-11
8-3-2. Certification and processing of SIAPs .....	8-11
8-3-3. Cancellation/Suspension of Instrument Approach Procedures .....	8-11
8-3-4. Revisions to IFPs .....	8-12
8-3-5. Aeronautical Information Services review of SIAPs and charts .....	8-17
8-3-6. Processing .....	8-17
8-3-7. Distribution .....	8-17
8-3-8. Special procedures printing and distribution .....	8-17
<i>Section 8-4. Flight Procedures Standards Waiver, FAA Form 8260-1</i> .....	8-21
8-4-1. Preparation of Form 8260-1 .....	8-21
<i>Section 8-5. Radio Fix and Holding Data Record, FAA Form 8260-2</i> .....	8-24
8-5-1. Introduction .....	8-24
8-5-2. Preparation of Form 8260-2 .....	8-24
<i>Section 8-6. Completion of FAA Forms 8260-3/4/5/7A</i> .....	8-35
8-6-1. General .....	8-35
8-6-2. Basic information .....	8-35
8-6-3. Terminal Arrival Area (TAA) .....	8-38
8-6-4. Terminal routes .....	8-40
8-6-5. Radar terminal area maneuvering sectors and altitudes .....	8-43
8-6-6. Missed Approach .....	8-43
8-6-7. Profile - Lines 1 through 8 .....	8-48
8-6-8. Equipment requirements notes for conventional .....	8-55
8-6-9. Notes .....	8-57
8-6-10. Additional flight data .....	8-65
8-6-11. Minimums .....	8-70
8-6-12. Changes and reasons .....	8-82
8-6-13. Coordinated with .....	8-82
8-6-14. Submitted by .....	8-83
8-6-15. Flight checked by Inspection/validation official .....	8-83
8-6-16. Developed by .....	8-84
8-6-17. Recommended by .....	8-84



8-6-18.	Approved by .....	8-84
8-6-19.	FAS Data Block Information .....	8-84
<i>Section 8-7. Standard Instrument Approach Procedure Data Record, FAA Form 8260-9 .....</i>		<i>8-85</i>
8-7-1.	Preparation of Form 8260-9 .....	8-85
<i>Section 8-8. Transmittal of Airways/Route Data Record, FAA Form 8260-16 .....</i>		<i>8-95</i>
8-8-1.	Preparation of Form 8260-16 .....	8-95
<i>Section 8-9. Simultaneous Close Parallel (SCP) and Simultaneous Offset Instrument Approach (SOIA) Procedure Attention All Users Page (AAUP) .....</i>		<i>8-121</i>
8-9-1.	Attention All Users Page .....	8-121
8-9-2.	Site Implementation Team .....	8-121
8-9-3.	AAUP preparation .....	8-121
8-9-4.	AAUP processing .....	8-121
8-9-5.	AAUP publication .....	8-121
8-9-6.	Forms processing .....	8-122
8-9-7.	Title line .....	8-122
8-9-8.	Text .....	8-122
8-9-9.	Administrative information .....	8-125
<b>Appendix A. Administrative Information .....</b>		<b>A-1</b>
<b>Appendix B. Flight Procedures References .....</b>		<b>B-1</b>
<b>Appendix C. Obstacle Accuracy Standards, Codes, and Sources .....</b>		<b>C-1</b>
<b>Appendix D. FAA Form 8260-2, Data Worksheet .....</b>		<b>D-1</b>
<b>Appendix E. Radio Fix and Holding Data Record Form .....</b>		<b>E-1</b>
<b>Appendix F. ILS and RNAV Standard Instrument Approach Procedure Form .....</b>		<b>F-1</b>
<b>Appendix G. Radar – Standard Instrument Approach Procedure Form .....</b>		<b>G-1</b>
<b>Appendix H. Standard Instrument Approach Procedure Form .....</b>		<b>H-1</b>
<b>Appendix I. Special Instrument Approach Procedure and Special Instrument Procedure Authorization .....</b>		<b>I-1</b>
<b>Appendix J. Standard Instrument Approach Procedure .....</b>		<b>J-1</b>
<b>Appendix K. FAS Data Block Requirements .....</b>		<b>K-1</b>
<b>Appendix L. FAS Data Block Requirements for Helicopter Operations .....</b>		<b>L-1</b>
<b>Appendix M. Instrument Flight Procedures (IFP) Lifecycle .....</b>		<b>M-1</b>

THIS PAGE IS INTENTIONALLY LEFT BLANK

## Chapter 1. General Information

### Section 1-1. General

**1-1-1. Purpose of this order.** This order provides guidance to all FAA personnel for the administration and accomplishment of the FAA Flight Procedures and Airspace Program. Additionally, this order provides guidance for the military and other government agencies to use when interacting with the FAA regarding instrument flight procedures. This order contains guidance that is pertinent to 14 CFR Parts 71, 91, 95, 97, 121, and 135.

**1-1-2. Audience.** The primary audience for this order is the Air Traffic Organization (ATO) Mission Support Services (MSS) (hereafter referred to as “AJV”), all service providers (as defined in appendix A), and elements of the Armed Forces described in Title 10 of the United States Code (hereafter referred to as “military”) who have the responsibility to develop instrument flight procedures (IFPs). The secondary audience includes all other Air Traffic organizations, Flight Standards Service, and other organizations who have responsibilities related to IFP development.

**Note:** Users of this order can refer to appendix A for an alphabetical listing of frequently used acronyms and abbreviations.

**1-1-3. Where you can find this order.** You can find this order on the [FAA’s web site](#).

**1-1-4. What this order cancels.** Order 8260.19G, Flight Procedures and Airspace, dated 07/14/2015, is canceled.

**1-1-5. Explanation of changes.** Significant areas of new direction, guidance, policy, and criteria as follows:

**a. General.**

- (1) Changed all references from “AIS” to “Aeronautical Information Services.”
- (2) Changed all references from “Flight Inspection Services” and “AJW-3” to “Flight Program Operations.”
- (3) Changed all references from “Airport/Facility Directory (A/FD)” to “Chart Supplement.”
- (4) Changed all references from Regional Flight Standards Division (RFSD) to All Weather Operations (AWO) to reflect changes being made regarding Flight Standards Realignment organizational changes.
- (5) Deleted requirement throughout this directive, including the former appendix N, which addressed documentation of waypoint description codes on 8260-series forms. This now permits database developers to establish/code them when required.

- (6) Added “/validation” following “flight inspection” where a flight validation is appropriate for procedures developed by non-FAA service providers.
  - (7) Removed references to “OTA” that were previously missed and replaced with “non-FAA service provider.”
  - (8) Deleted section 1-3, Instrument Procedure Development Software Responsibilities. These responsibilities are specified in applicable 1100-series directives and organizational agreements that are subject to constant internal organizational changes.
  - (9) Per discussion at Aeronautical Charting Forum, Instrument Procedures Group (ACF-IPG) meeting 16-01, all Fahrenheit temperatures have been removed. All temperatures will be specified in Celsius only.
  - (10) Removed all items pertaining to documenting “All affected procedures reviewed” in an 8260-series form block; this block has been removed from the revised forms. Review requirements are specified in section 2-8, “Periodic Review of Instrument Flight Procedures.”
  - (11) Removed references to ARINC and ARINC 424 and replaced with appropriate text to refer to the database coding used by aircraft navigation systems.
  - (12) Changed all “turbojet” references to just “jet.”
- b.** Table of Contents. Updated to coincide with the pages changed.
  - c.** Chapter 1.
    - (1) Added Regulatory reference to comply with Order FS 8000.96, Flight Standards Service Guidance Document Development, paragraph 3.7.
    - (2) Paragraph 1-2-4.c. Inserted new paragraph to address Air Traffic Standards & Procedures Directorate (AJV-8) responsibilities and up-lettered the following paragraphs.
  - d.** Chapter 2.
    - (1) Paragraph 2-2-2. Updated office contacts.
    - (2) Paragraph 2-4-3.a. Clarified intent of the requirement by stating that there is a need for an expanded service volume for aircraft navigating outside both the lateral and vertical boundaries shown for each navigational aid (NAVAID) type.
    - (3) Paragraph 2-4-4. Editorial changes for clarity and added guidance to address Flight Program Operations’ concerns over proper use of localizers for missed approach procedures.
    - (4) Paragraph 2-5-3.b and 2-5-3.c. Per the Performance-based Operations Aviation Rulemaking Committee (PARC) recommendation to AVS-1 dated April 22, 2016, “VOR/VORTAC” magnetic variation tolerance changed from three degrees to five degrees.

- (5) Section 2-6. Moved all Flight Data Center (FDC) Notices to Airmen (NOTAM) policy to Order JO 7930.2, Notices to Airmen. Retained select information that will point the reader to where instrument flight procedures FDC NOTAM guidance can be obtained.
- (6) Paragraph 2-7-2.b. Deleted last sentence as it was considered redundant; previous paragraph cover the task.
- (7) Paragraph 2-8-2(2)(e). Deleted “Verify continued need for IFPs and cancel IFPs that are no longer required” as procedure use is not tracked and there is no clear way to make this determination.
- (8) Paragraph 2-8-2.b(3). Deleted paragraph.
- (9) Paragraph 2-10-4.a(6). Added Note to resolve problems being experienced when processing fix/holding pattern changes that impact both public and Special instrument procedures.
- (10) Paragraph 2-10-4.b. Deleted requirement to use waypoints for area navigation (RNAV) standard instrument approach procedures (SIAP) on Victor Airways; See ACF IPG agenda item 14-01-316.
- (11) Paragraph 2-10-5.a(4)(d). Deleted paragraph.
- (12) Paragraph 2-11-1. Established guidance to not require obstacle assessments to be conducted for operations above 18,000 feet in the contiguous U.S. or above 23,000 feet for Alaska and Hawaii.
- (13) Paragraph 2-11-2.a. Editorial changes to responsibilities and added guidance to allow data to be accepted from additional methods/sources.
- (14) Paragraph 2-11-3. Removed the word “code” following the word “accuracy” where used; i.e., where “accuracy code adjustment” was used, it will state “accuracy adjustment,” where appropriate. Intent is to prevent procedure developer from believing that the “code” value specified in the appendix C tables must be used in all cases when an assigned accuracy value may be provided and used where digital terrain elevation data (DTED) and digital elevation model (DEM) information is used.
- (15) Paragraph 2-11-3.b(1). Changed 1A accuracy requirement for missed approach to only apply to section 1 of the missed approach.
- (16) Paragraph 2-11-3.b(3). Added sloping surface for visual climb over airport (VCOA).
- (17) Paragraph 2-11-3.b(4). Added reference to climb-in-holding.
- (18) Paragraph 2-11-3.b(5). Added reference to “DPs” to be consistent with previous paragraph.
- (19) Paragraph 2-11-3.b(6) thru (9). Deleted. Moved guidance to paragraph 2-11-4.

(20) Paragraph 2-11-4. Editorial and added statement to not apply accuracy adjustment to departure procedure controlling obstacles defined for determining ceiling and/or visibility.

(21) Paragraph 2-11-4.a. Editorial change to refer to the “applicable FAA Form,” as opposed to just the Form 8260-9, Standard Instrument Approach Procedure Data Record.

(22) Paragraph 2-11-4.c. Added sentence to ensure accuracy value is applied when evaluating proposed obstruction information impact on instrument flight procedures.

(23) Paragraph 2-11-4.d. Editorial revision for clarity and added guidance to address accuracy adjustments when there are multiple controlling obstacles.

(24) Paragraphs 2-11-5.b(2)(a) Exception and 2-11-5.c(1)(b). Removed the word “lateral.”

(25) Paragraph 2-11-5.d. Inserted new paragraph to address controlling obstacle for VCOA procedures. Following paragraph up-lettered.

(26) Paragraph 2-12-6. Removed reference to “waiver” in beginning sentence and added paragraph to address the Flight Standards “approval” process when the approval is no longer applicable.

**e. Chapter 3.**

(1) Paragraph 3-5-2. Updated guidance to support off-airway routes developed by non-FAA service providers.

(2) Paragraph 3-5-3. Updated guidance to support off-airway routes developed by non-FAA service providers.

(3) Paragraph 3-5-4. Updated guidance to support off-airway routes developed by non-FAA service providers.

**f. Chapter 4.**

(1) Paragraph 4-1-6. Removed all terminal instrument procedures (TERPS)-related criteria for the sidestep maneuver that is now located in Order 8260.3, U.S. Standard for Terminal Instrument Procedures (TERPS), chapter 2. Retained only guidance pertaining to documenting and publishing sidestep information.

(2) Paragraph 4-5-1.b(5). Added note stating not to reference an altitude as one that can be *expected* to be assigned by air traffic control (ATC) due to proven misapplication and confusion this has caused that resulted in unintended consequences.

(3) Paragraph 4-5-1.b(8)(b). Added new paragraph to support request from ACF-IPG agenda item 15-01-293, STAR Terminus Point Standardization.

(4) Paragraph 4-5-1.b(10). Removed reference to “Bottom Altitude” as it will not be specifically annotated as such on the chart. Paragraph rewritten to refer to the altitude required at

the standard terminal arrival route (STAR) termination point, per Order 8260.3, paragraph 2-2-1.f(6).

(5) Paragraph 4-5-1.d(3)(f). Added that an airport name, airport identifier, and/or city/state change can be done by abbreviated amendment.

(6) Paragraph 4-5-3.j(5). Deleted paragraph pertaining to “Bottom Altitude.”

(7) Paragraph 4-5-3.n. Consolidated “changes” and “reasons.”

(8) Paragraph 4-5-4.i, table 4-5-2. Added indicator for block altitude.

(9) Paragraph 4-6-2.a(1). Removed the word “all” from the sentence.

(10) Paragraph 4-6-2.a(5). Removed “or any point prior to the PFAF” to be consistent with criteria established in Order 8260.3, section 2-2.

(11) Paragraph 4-6-2.e note. Added statement that the Terminal Arrival Area concept not be used on instrument landing system (ILS)/localizer (LOC) procedures containing a conventional missed approach.

(12) Paragraph 4-6-4.c. Deleted, no longer required.

(13) Paragraph 4-6-5.d. Removed course-to-altitude (CA) leg guidance that has been moved to Order 8260.58, U.S. Standard for Performance Based Navigation (PBN) Instrument Procedure Design.

(14) Paragraph 4-6-10.e. Paragraph revised to remove chart note: “DME/DME RNP-0.3 NA” and other related chart notes in this paragraph. Added requirement to specify the applicable navigation specification (NAVSPEC) which will appear in the PBN requirements box.

(15) Paragraph 4-6-10.f. Added guidance to clarify that the *lowest* RNP value is what is charted for situations where there is more than one that is less than the standard value.

**g.** Chapter 5. Paragraph 5-2-3.c. Editorial change made to support changes made to Form 8260-9 that now contains a “Part D” dedicated to “airspace.”

**h.** Chapter 8.

(1) Due to the changes needed to support the changeover to the “report format” for Forms 8260-3/4/5/7A, and the removal of Form 8260-10, numerous changes involving the rearrangement of sentences and paragraphs has been made. Changes made that are significantly different from previous versions of this order are noted below.

(2) Paragraph 8-2-5.e. Removed “En route obstacle clearance criteria apply to feeder routes”; this is addressed in Order 8260.3.

(3) Paragraph 8-3-2.a(2). Editorial change.

- (4) Paragraph 8-3-2.a(3). Added “ILS glideslope angle changes” to conditions when “hard dates” can be used.
- (5) Paragraph 8-3-3. Updated paragraphs to support new forms formatting.
- (6) Paragraph 8-3-4. Aeronautical Information Services, Instrument Flight Procedures Team, responsibilities uniquely identified throughout this paragraph.
- (7) Paragraph 8-3-4.b(1). Heliport and airport ID added to text since they will now be entered on the new 8260-3/4/5/7A forms and removed table 8-3-1 the authority to use the P-NOTAM capability for these changes.
- (8) Paragraph 8-3-5. Editorial change.
- (9) Paragraph 8-4-1.h. Expanded guidance to address whom must sign waiver requests for instrument procedures developed by the FAA and non-FAA service providers.
- (10) Paragraph 8-5-1.a. Removed “approved” prior to “non-FAA service providers” and added reference to section 2-10.
- (11) Paragraph 8-5-2.g(3). Added “Note” to state that Magnetic and True Bearings are not to be entered when only distance measuring equipment (DME) (i.e., no crossing radials) is used for fix make-up.
- (12) Paragraph 8-5-2.g(5). Editorial change for clarity.
- (13) Paragraph 8-5-2.h(2). Added guidance to include airspace evaluation to the primary area.
- (14) Paragraph 8-5-2.h(2)(h). Revised guidance and added a “Note” to ensure the policy is consistent with Order 8260.3, paragraph 17-2-2, that indicates holding patterns are developed to support time or distance and if the holding pattern serves both, two independent entries will be made on the form.
- (15) Paragraph 8-5-2.h(2)(h)2 note. Added note to make it clear that the block title “DME” also applies to RNAV holding pattern leg length distance.
- (16) Paragraph 8-5-2.h(2)(j)2. A note was added to address using template used for climb-in-hold, if applicable.
- (17) Paragraph 8-5-2.h(6)(c). Editorial; changed “Fix” to “Holding.”
- (18) Paragraph 8-5-2.j(1). Added “Special DP” and “Special IAP.”
- (19) Paragraph 8-5-2.k. Added “Special DP,” “Controller High,” “Controller Low,” and deleted Note relating to controller charts.
- (20) Paragraph 8-6-2.g(1). Updated source for touchdown zone elevation (TDZE) and provided rounding rules.



(21) Paragraph 8-6-4.b(3). Deleted requirement to establish a computer navigation fix for dead reckoning segments on conventional instrument approach procedures; this was originally established to accommodate coding of conventional instrument procedures and is no longer required.

(22) Paragraph 8-6-6.d(7). Added “RNAV” reference based on changes made in Order 8260.58.

(23) Paragraph 8-6-6.h(1). Removed the word “must” and made several editorial changes.

(24) Paragraph 8-6-7.b(2). Expanded guidance and example to include maximum holding altitude when a hold in-lieu-of procedure turn is used.

(25) Paragraph 8-6-7.g(3). Added 20:1 surface block to document whether clear or not clear.

(26) Paragraph 8-6-7.h(1). Added example of minimum safe/sector altitude (MSA) based on the airport reference point.

(27) Paragraph 8-6-7.h(5). Added “and altitudes” to sentence for clarity.

(28) Paragraph 8-6-8. Establishes guidance to support a separate section on approach charts dedicated for equipment requirements notes for conventional instrument procedures and performance based navigation as a result of recommendations addressed at the ACF-IPG, per agenda item 13-02-312.

(29) Paragraph 8-6-9.f. A number of comments were received from the Aviation Weather & Aeronautical Services Programs Group, AJM-33, that were accepted regarding the most current policy relating to automated weather systems.

(30) Paragraph 8-6-9.g note. Added “GLS” and “ILS and/or LOC” to exception.

(31) Paragraph 8-6-9.m. Added reference to see Order 8260.3 for additional guidance when Flight Standards approval may be required.

(32) Paragraph 8-6-9.p. Removed “Procedure Not Authorized when Glideslope not available” to support future criteria application that no longer prohibits localizer only operations when conducting precision runway monitor (PRM) operations.

(33) Paragraph 8-6-9.q. Added statement to prohibit publication of localizer minimums on SOIA PRM procedures.

(34) Paragraph 8-6-10.o. Added guidance on documenting block altitudes.

(35) Paragraph 8-6-10.p(1). Removed text regarding vertical descent angle (VDA)/threshold crossing height (TCH) exceptions that is now addressed in Order 8260.3. Consolidated remaining text from subparagraph “(a)” and “(b)” into the main paragraph.

(36) Paragraph 8-6-10.q. Removed text at end of the sentence to eliminate ties to paragraph 8-6-4.b(3), that no longer requires a computer navigation fix for dead reckoning segments.

(37) Paragraph 8-6-11.b(4), 8-6-11.b(5), & 8-6-11.b(6). Updated notes to remove use of symbols.

(38) Paragraph 8-6-11.i(3). Removed stipulation when localizer performance (LP) minima will be established; determination will be driven by PBN criteria or as needed and determined through Regional Airspace and Procedures Team (RAPT) process.

(39) Paragraph 8-6-11.k(3). Revised note that applied when reduction of visibility by helicopters is authorized when using Category A minimums on instrument approach procedures.

(40) Paragraph 8-6-11.o(2)(h). Added sample chart note to indicate the potential application for straight-in procedures.

(41) Paragraph 8-6-11.o(6)(d). Changed “Decision Altitude” to read “Altitude specified by Flight Inspection.”

(42) Paragraph 8-6-12. Added statement to ensure FAS Data Block change information is included (requested by Flight Inspection).

(43) Paragraph 8-6-13. Added two “Notes” and made editorial changes to clarify in this paragraph the requirements regarding coordination with affected ATC facilities and that this paragraph also applies to departure procedures.

(44) Paragraph 8-6-13.c. Made several editorial changes for clarity.

(45) Paragraph 8-6-18.a(2). Removed “publication” from the text as it can be considered part of processing.

(46) Paragraph 8-7-1. Added guidance explaining that if the form is used for helicopter procedures, the copter boxes in the upper left portion of the form must be filled out to activate the block headers associated with helicopter procedures.

(47) Paragraph 8-7-1.b(2). Added guidance to support copter point in space (PinS) procedures.

(48) Paragraphs 1-1-1.a(1). Added note to clarify that the height of missed approach surface (HMAS) entry will only appear in the segment pertaining to the missed approach.

(49) Paragraph 1-1-1.a(1). Due to automation advancements and constraints, the last sentence was revised to make repeated coordinate entries as being optional to support programs that auto-populate all data from previous entries.

(50) Paragraphs 1-1-1.a(1) & 1-1-1.a(1). Expanded guidance for clarity; added guidance for use of DTED and DEM assigned accuracy values.

(51) Paragraph 8-7-1.b(14). Added “raw value” to indicate the data to be entered is before rounding for publication.

(52) Paragraph 8-7-1.b(24). Added guidance to indicate that bearings provided will be in whole degrees.

(53) Paragraph 8-7-1.c(3). Editorial for clarity.

(54) Paragraph 8-7-1.c(9). Added text to include geographical coordinates when adding this information in Part C.

(55) Paragraph 8-7-1.d(13). Added paragraph to support Order 8260.3, section 16-2, requirement to document a reference to the applicable report (e.g., safety study) that allowed for unique operating situations.

(56) Paragraph 8-8-1.d. Added text for clarity and properly document that controlled airspace was considered; i.e., document airspace floor and buffer used.

(57) Paragraph 8-8-1.i. Deleted statement that said “MRA not applicable for low altitude RNAV routes” and editorial change to clarify documentation action involving minimum turning altitudes (MTA).

(58) Paragraph 8-9-9. Added an “Approved By” block and consolidated “Changes and Reasons” blocks.

**i. Appendix C.**

(1) Paragraph 2a. Added guidance to, when provided, permit use of assigned accuracy values for DTED and DEM postings.

(2) Paragraph 2b(1)(i). Removed all references to World Aeronautical Charts (WACs); i.e., no longer published.

(3) Table 4. Changed accuracy values for “owner marked positions” of obstacles depicted on 1:20,000 and 1:24,000 maps based on recommendation from Aeronautical Information Services’ Obstacles Team manager and the new methods used to verify the placement of these obstacles.

**j. Appendix K.**

(1) Paragraph 4d note 1. Deleted; Order 8260.58 does not allow LP to support Circling operations.

(2) Paragraph 4i note 2. Deleted; Order 8260.58 does not allow LP to support Circling operations.

(3) Paragraph 4o. Added guidance to indicate that zeros are entered into this block when a TCH will not be established for an LP procedure.

(4) Paragraph 4q. Expanded guidance to indicate that zeros are entered into this block when a VDA is not specified for an LP procedure.

(5) Paragraph 4x. Added “For an LP procedure, the vertical alert limit (VAL) must always be entered as zero (00.0)” for clarification.

**1-1-6. Effective Date.** This order and subsequent changes are effective on the dates shown in the upper left corner of each page. Implementation of changes must commence no later than 24 months from the published effective date. Previous editions may be used until implementation has commenced, not to exceed 24 months from the new effective date.

## Section 1-2. Responsibilities

**Note:** Applicable FAA 1100-series directives address organizational responsibilities and functions. Responsibilities specified in this section are provided for information only and for the purpose of assisting instrument procedure developers in knowing whom to contact for assistance and/or information in the performance of their duties. Do not interpret this section as a substitute or supplement to any other FAA directive.

### 1-2-1. Flight Standards Service.

a. Flight Standards Service is responsible for the use of air navigation facilities, appliances, and systems by aircraft operating in established environments and the National Airspace System (NAS). Responsibility includes governing policy and oversight of manual and automated development and maintenance of terminal and en route flight procedures. The executive director has final authority to issue, amend, and terminate rules and regulations relating to instrument procedures, minimum en route altitudes, flight procedures, operational weather minimums, and minimum equipment requirements.

b. Responsibility for the overall management of the Flight Procedures and Airspace Program is vested in the Flight Technologies and Procedures Division. This order is primarily concerned with those offices having direct responsibility for the accomplishment of the Flight Procedures and Airspace Program. The following is a brief description of their activities.

### 1-2-2. Flight Technologies and Procedures Division.

a. This division is the principal element of the Flight Standards Service governing policies, criteria, and standards for establishing and maintaining terminal and en route flight procedures; for using air navigation facilities, appliances, and systems; and for validation of FAA instrument procedure design software. This office is designated as the final authority to issue, amend, and appeal minimum en route instrument flight rules (IFR) altitudes and associated flight data under 14 CFR part 95; and standard instrument approach procedures and obstacle departure procedures under 14 CFR part 97.

b. Flight Operations Branch. This branch is the principal element of the division with respect to concepts, policies, systems, and programs associated with the operational and flight technical aspects of all-weather operations. This branch develops concepts for design, evaluation, and approval of category (CAT) I, II, and III approach and landing operations, as well as lower than standard takeoff minimums. This branch develops instrument flight operational concepts, policies, standards, criteria, requirements, specifications, and limitations for new and existing aircraft (all categories) and new and existing airborne, ground-based and space-based systems used in instrument flight operations, and develops and issues Form 8260-7B, Special Instrument Procedure Authorization, as required, through the Procedures Review Board (PRB). This branch provides technical representation to International Civil Aviation Organization (ICAO) on matters related to instrument flight operations, and maintains liaison with foreign civil aviation operational and technical authorities to encourage the acceptance of U.S. instrument flight operations standards and to foster standards with a level of safety consonant with those of the United States. In coordination with original equipment manufacturers (OEMs), Aircraft

Certification (AIR), and Aircraft Evaluation Groups (AEGs), identifies explicit operational credit for pilots using new-technology products. This branch provides specific Operations Specification (OpsSpec) language and inspector guidance regarding low visibility operations (CAT II/III) procedures and minima.

**c. Flight Procedure Standards Branch.** This branch is the principal element within the division, with respect to the rulemaking process of the flight procedures program; also with respect to the development, application, and oversight of national policies and directives for the administration of the National Flight Procedures Program; and development of criteria pertinent to the design of instrument flight procedures. This branch serves as the focal point within Flight Standards for all matters relating to airspace, cartographic programs, instrument flight procedure (IFP) Notices to Airmen (NOTAMs), and is the primary interface for industry on matters relating to instrument procedures criteria. The branch assists the Flight Procedure Implementation and Oversight Branch, providing technical advice and assistance to other FAA elements, government agencies, and industry on the interpretation and application of criteria. It analyzes and evaluates execution of flight procedure programs within the FAA to determine compliance with National policy.

**d. Flight Operations Simulation Branch.** This branch is the principal element within the division which provides simulation and human-in-the-loop analysis of new, emerging, or modified Communications, Navigation, and Surveillance (CNS) technologies and procedures in support of flight safety. This simulation and analysis is accomplished through computer modeling, human-in-the-loop observation in flight and air traffic control (ATC) simulators, and/or industry aircraft. This branch manages the Flight Operations Simulation Laboratory comprised of flight simulators and ATC controller stations that can be linked to provide real time pilot/controller interface and data collection to meet the safety studies' and risk analyses' data requirements. These simulations are used to support Flight Standards' offices, ATO, airports, the aviation industry, and FAA executives who seek objective and subjective human factors safety analysis and assessments to enhance flight operations, standards, capacity, and aviation safety within the NAS and international organizations such as ICAO.

**e. Flight Systems Laboratory.** This branch is the principal element within the division that analyzes and quantifies the levels of risk probabilities associated with the implementation of new, emerging, and modified flight operational concepts and navigation systems. This branch conducts safety studies for client-proposed changes to the NAS or international standards for other Flight Standards' offices, ATO, airports, the aviation industry, and FAA executives who seek objective safety assessments to improve flight operations, standards, capacity, aviation safety within the NAS, and international organizations such as ICAO. This branch also develops Flight Systems Laboratory tools software applications [RNAV-Pro, RDVA-Pro, and the Engine Out Surface Evaluator (EOSE)] for use in area navigation/required navigation performance (RNAV/RNP) procedure design and implementation.

**f. Flight Procedure Implementation and Oversight Branch.** This branch is the principal element within the division, with respect to FAA Instrument Flight Procedures and Flight Inspection policy oversight. This branch develops policy and provides oversight of the IFP development process for government and non-FAA Service Providers. This oversight includes clarifying procedure criteria, confirming procedure development data, conducting simulator

evaluations, developing policy for flight validation of IFPs, and monitoring validation flights. This branch manages the program for the review and approval of all special IFPs. Also manages the program to review approval/waiver requests of procedure design standards, and functions as the final approving authority for those requests. This branch is responsible for coordinating non-government procedure developer NOTAM authority and access to the Federal NOTAM System (FNS) with ATO Mission Support Services, Aeronautical Information Services. This branch develops standards to ensure the orderly processing of all approved IFPs and evaluates the implementation of these standards and practices to determine compliance with established policy. This branch works with other government agencies, the military, aviation industry leaders, and the international community to improve aviation safety by assisting in the IFP development process worldwide.

**g. Performance Based Navigation Branch.** This branch is the principal element within the division, with respect to performance based navigation across all domains. This branch develops performance based navigation concepts, policies, standards, criteria, requirements, specifications, and limitations for new aircraft and new and existing airborne, ground-based and space-based systems used in instrument flight operations. This branch develops and issues Form 8260-7B, as required. In coordination with original equipment manufacturers, AIR, and AEGs, identifies and enunciates explicit operating procedures for pilots using new-technology products. This branch provides guidance to develop OpsSpec requirements (including parts C and H) related performance based navigation, operating minimums, equipment, and training. This branch is responsible for developing concepts, programs, and system requirements necessary to implement performance based navigation and procedures necessary to implement futuristic communications and surveillance capabilities for oceanic, remote area, domestic en route, and terminal area operations, and for nonprecision and precision instrument approaches. Flight Standards All Weather Operations (AWO) manages and directs air carrier, general aviation, and all weather operations programs for a specified local area. Each AWO provides the local implementation of national concepts, policies, standards, systems, procedures, and programs with respect to the operational and flight technical aspects of the all-weather operations program. AWO responsibilities include but are not limited to the following:

(a) Establishing local requirements for and managing distribution of, special instrument approach procedures. Receiving and resolving user/industry comments on new and revised special instrument approach procedures. Executing national programs such as the Required Navigation Performance/Authorization Required (RNP/AR) instrument approach procedure (IAP) program.

(b) Providing technical evaluations in support of local airspace programs to determine the effect on operational safety and visual flight operations. Specific study responsibilities for AWOs are specified in Order JO 7400.2, Procedures for Handling Airspace Matters, and dictate involvement in a broad range of technical evaluations (i.e., determining feasibility for CAT II/III operations utilizing AWO missed approach tool, assessing operational safety for taxiway/runway separation, and configuration relative to a proposed CAT II/III, etc.).

(c) Coordinating the AWO portion of assigned foreign instrument approach procedures programs as specified in Order 8260.31, Foreign Terminal Instrument Procedures (FTIPs).

- (d) Approving CAT II and III operation and coordinating continuity of service assurance with the ATO Service Area. Local focal point for coordinating inter-service Surface Movement Guidance Control System (SMGCS) activities, site inspections, and the approval of the associated SMGCS plan and periodic reviews.
- (e) Providing the operational input on matters related to local capacity studies and airport operational safety initiatives.
- (f) Performing Obstruction Evaluation and Airport/Airspace Analysis (OE/AAA) evaluations to address the effect of obstacles on visual flight operations and instrument flight operations (e.g., OE studies) relative to AAA studies, assess operational safety and safety of persons and property on the ground in coordination with the Airports division, as necessary.
- (g) Review of charted visual flight procedures and RNAV visual flight procedures.
- (h) Coordinating with Airports Division in the approval or denial of modifications to airport standards, providing written safety assessment of end-around taxiway (EAT) proposals/use, and declared distance concepts (see Order JO 7400.2).
- (i) Providing operational review and comments for Air Traffic Technical Operations Service Area's submission of a NAS change proposal (NCP), evaluation of new ATC towers and similar ATO projects. This activity includes participation in the associated Safety Risk Management Document (SRMD) analysis and acceptance processes.
- (j) Assists in developing the equivalent level of safety for an Aeronautical Information Services originated procedures waiver.
- (k) Provides local level support for activities related to non-FAA service providers.

### **1-2-3. Air Traffic Organization, Flight Program Operations.**

**a.** Flight Program Operations is the principal element directly responsible for the flight inspection of electronic signals-in-space from ground-based navigational aids, and/or flight validation that support aircraft departure, en route, and arrival flight procedures in the NAS. Flight procedures are also evaluated for accuracy, aeronautical data, human factors flyability, and obstacle clearance; this includes the evaluation of avionics database code which represents the IFP in the Flight Management System (FMS). Flight Program Operations supports flight inspection for the Department of Defense (DoD) on foreign navigational facilities that have been designated as essential to the defense of the United States. Flight Program Operations is also responsible for input (when solicited) to the Air Traffic Technical Operations Service Areas Facilities and Equipment (F&E) budget submission with respect to terminal air navigation aids (other than radar) and visual approach aids.

**b.** Flight Program Operations, Flight Inspection Scheduling is responsible for scheduling flight inspections. Flight Inspection Scheduling maintains liaison with Aeronautical Information Services, as well as other FAA offices, civil and military interests, to ensure consideration of all



requirements relating to the procedural use of navigation facilities. Flight Inspection Scheduling's responsibilities include but are not limited to:

- (1) Issuing NOTAM D in accordance with Order 8200.1, United States Standard Flight Inspection Manual.
- (2) Managing, processing, and coordinating flight inspection procedure packages.
- (3) Scheduling special requests for flight inspections.
- (4) Maintaining suitable record system reflecting the status of each flight.
- (5) Managing the requirements and technology for Flight Inspection Report System, Flight Operations Management System, and Flight Management Daily Flight Log.
- (6) Focal point for all PBN Policy and Support Office generated (CSV) files as well as the KSN DME/DME directory.
- (7) Providing Flight Inspection Reports (FIR) containing data pertinent to the AIRNAV database and resolving AIRNAV data discrepancies.
- (8) Ground evaluation (validation) of coded IFPs.
- (9) Initiating and completing investigative remedial action with respect to any deficiency or reported hazard, including restrictions or emergency revisions to procedures.

c. Aircraft Operations is the principal element within Flight Program Operations responsible for flight inspection of navigation aids and instrument flight procedures in support of the NAS. Flight Program Operations has multiple facilities that support the flight inspection mission.

#### **1-2-4. Air Traffic Organization, Mission Support Services (AJV-0).**

a. Aeronautical Information Services (AJV-5) is directly responsible for managing the agency's program to provide Aeronautical Information Services to ensure the flow of information necessary for safety, regularity, and efficiency of air navigation. This office is charged with the responsibility for collecting, collating, validating, maintaining, and disseminating aeronautical data regarding the U.S. and its territories. It is also a source for database accuracy standards, content, and format.

(1) The National Flight Data Center (NFDC) is one element within AJV-5 with respect to maintaining the National Airspace System Resources (NASR) database and for disseminating information relating to the NAS. NFDC is also responsible for maintaining proposed data within the AIRNAV database for the development of instrument flight procedures. NFDC responsibilities include but are not limited to:

- (a) Publishing the daily National Flight Data Digest (NFDD) and 56-day subscriber files to promulgate additions, changes, and deletions to non-regulatory elements of the

NAS. Respective changes are also published in Order JO 7340.2, Contractions, and Order JO 7350.8, Location Identifiers.

(b) Conducting pre-publication review of aeronautical data contained in standard instrument approach and departure procedures, standard terminal arrivals, standard instrument departures, military training routes, navigational aids, airport data, and airspace changes submitted for action, and to identify and correct items in non-conformance with applicable directives.

(c) Validating submitted data with the NASR Database and resolving contradictions.

(d) Managing the development and assignment of five-letter fix names and navigational aid (NAVAID)/airport identifiers.

(e) Issuing, on a predetermined schedule, amendments to 14 CFR part 95.

(f) Maintaining copies of 8260- and 7100-series forms that support public use standard instrument approach procedures (SIAPs), fixes, airways, standard terminal arrival routes (STARs), and departure procedures (DPs).

(2) Aeronautical Information Services is the principal element responsible for developing, directing, and recommending national policy and criteria for aeronautical information. This group serves as the Mission Support Services focal point for developing and managing Geographic Information Systems for the NAS. They are also responsible for collecting, validating, and maintaining obstacle data to support instrument flight procedure development including minimum vectoring altitude (MVA) and minimum IFR altitude (MIA) charts as well as minimum safe altitude warning (MSAW) data creation. Responsibilities include but are not limited to:

(a) Establishing the U.S. position for AIM and Aeronautical Information Services through the ICAO.

(b) Collecting, validating, managing, and disseminating as-built obstacle data reported under 14 CFR part 77.

1. Providing the publically-available Digital Obstacle File (DOF), which contains a record of all as-built man-made obstructions that effect domestic aeronautical charting products.

2. Providing Obstacle Repository System (ORS) data to other FAA offices on a timely basis.

(c) Verifying source data for as-built obstacles and assigning accuracy codes that reflect the reliability of the reported obstacle's vertical height and horizontal position.

(d) Managing the verification/validation of airport survey safety critical data.

(e) Managing the requirements and technology to support database needs and infrastructure.

**b.** Aeronautical Information Services (AJV-5) is also responsible for the development, maintenance, quality assurance, and technical approval of public-use flight procedures, production, and distribution of aeronautical charts and related publications and products. Responsibilities include but are not limited to the following:

- (1) Development, publication, and maintenance of SIAPs.
- (2) Development, publication, and maintenance of obstacle departure procedures (ODPs) and standard instrument departure procedures (SIDs). Development and maintenance of diverse vector areas (DVA).
- (3) Development, publication, and maintenance of Air Traffic Service (ATS) routes.
- (4) Review and publication of STAR Airport diagrams and special graphics.
- (5) Responsible for quality assurance of items produced by Aeronautical Information Services.
- (6) Operations support, as requested, for NAS-related products.
- (7) Selecting and evaluating source data for final chart compilation.
- (8) Validating geographical positions, distances, and bearings of items produced by Aeronautical Information Services.
- (9) Maintaining liaison with elements of FAA to support safe and accurate portrayal of charting data.
- (10) Providing civilian charts in support of military requirements.
- (11) Providing international charting support to selected foreign countries.
- (12) Establishing procedures to ensure operational data are included in the NASR database.
- (13) Analyzing obstruction evaluations to determine the effects on current and planned instrument flight operations, minimums, and/or flight altitudes of all civil, joint-use, and U.S. Army instrument procedures in accordance with current policy.
- (14) Promulgating SIAPs, ODPs, and permanent FDC NOTAMs relating to IFPs with assigned effective dates in a bi-weekly transmittal letter and completing necessary requirements for publication in 14 CFR part 97.

**c.** Air Traffic Standards & Procedures Directorate (AJV-8) provides support to air traffic operations through policy, procedures, separation standards, equipment, software, and other operations related to air traffic activities across the NAS. AJV-8 serves as the primary point of

contact for the Service Areas, Service Centers and field facilities for Terminal, En Route and Oceanic/Offshore operations, standards, and procedures issues. AJV-8 has the following responsibilities regarding ATC policies, standards, and procedures:

(1) Develop and maintain procedural changes to the NAS in support of new systems or new technologies, or capacity and efficiency improvements, or for the purposes of risk mitigation. These procedural changes are normally accomplished by creating or revising an existing air traffic order.

(2) Effectuate NAS changes through the document change process, issuance of a notice, or the creation of a new air traffic order.

(3) Assess and approve Air Traffic Procedural Waivers, including waivers to separation minima as defined Order 1100.161, Air Traffic Oversight, paragraph 4.2.d.3.

(4) Prepare air traffic procedural interpretations.

(5) Assess and approve letters of authorization for airshows and fly-ins and other procedures in accordance with existing orders.

**d.** Service Center, Operational Support Group, Flight Procedures Teams (OSG-FPTs), responsibilities include but are not limited to:

(1) Evaluating and responding to industry and user comments relating to instrument procedures.

(2) Serving as Chairperson of the Regional Airspace and Procedures Team (RAPT) under Order 8260.43, Flight Procedure Management Program.

(3) Coordinating requests for new instrument procedures service with the respective Air Traffic Service Area and other concerned offices, and conducting instrument procedures feasibility studies.

(4) Coordinating submission by responsible offices of all pertinent data and supporting documents required for procedures development and assignment of priority when further procedures action is required.

(5) Planning and coordinating new or relocated NAS facilities.

(6) Coordinating with applicable Air Traffic Service Areas to select a charting date consistent with priorities and workload when a component of the NAS is to be commissioned, de-commissioned, or altered.

(7) Coordinating the input for the planning and development of regional and Air Traffic Service Area F&E budget submissions and programming actions.

(8) Evaluating regional airport and airspace changes for impact on instrument flight procedures.

(9) Determining the necessity for environmental impact studies as required by current policy.

(10) Acting as the focal point for flight inspection issues within the region.

**1-2-5. Individual.** Personnel working within the Flight Procedures Program are responsible for maintaining professional knowledge in a technical, complex, and specialized field, and for the application of the knowledge to assure safety and practicality in air navigation. Where directives are deficient, each individual must take the initiative to seek an acceptable method of resolution and to inform the responsible office of any recommended change to policy, procedures, etc. that is cost beneficial and/or provides increased operational safety.

THIS PAGE IS INTENTIONALLY LEFT BLANK

## Chapter 2. General Procedures

### Section 2-1. General

**Note:** This chapter provides guidelines and procedures that are common to all instrument flight procedures. Specific guidelines and procedures for en route and terminal instrument flight procedures are contained in chapters 3 and 4, respectively.

#### 2-1-1. Requests for public-use Instrument Flight Procedures (IFPs).

a. Requests for approval and/or establishment of instrument flight procedures may originate from many different sources (see Order 8260.43). It may be a request from a state, city, airport manager, or an individual. It may also be from an air carrier, air taxi, military, commercial operator, ATC, or Flight Standards' personnel. General information on the lifecycle process associated with IFPs can be found in appendix M.

b. Requirements for approval of IFPs are contained in Order 8260.3, chapter 1.

c. Procedures with specific effective dates, and other urgent projects, will be assigned priorities by Aeronautical Information Services. All other projects will be processed as workload permits, by Aeronautical Information Services in order of receipt.

**2-1-2. Air Traffic Letters of Agreement (LOAs).** When LOAs affect or include flight procedures, they must be coordinated between ATC facilities and Aeronautical Information Services.

a. When these letters are received, Aeronautical Information Services must review them to ensure compatibility with published or planned flight procedures.

b. Copies of LOAs received in Aeronautical Information Services must be made a part of the procedure files, to serve as a reference when developing or amending flight procedures.

c. When the terms of the LOAs and flight procedures are not compatible, or if it is determined that the terms do not comply with criteria, Aeronautical Information Services must return the LOAs to the ATC facility with a memorandum that explains the findings. When appropriate and practical, consideration should be given to adjusting the procedures to accommodate the terms of the agreement.

d. Normally, an LOA is an agreement between two or more ATC facilities. Unless Aeronautical Information Services is a party to the agreement, it is not a signatory and does not approve or disapprove the agreement.

#### 2-1-3. Airport lighting and visual aids.

a. Operation of airport lighting and visual aids is contained in the following orders:

- (1) Order JO 7110.10, Flight Services.

- (2) Order JO 7110.65, Air Traffic Control.
- (3) Order JO 7210.3, Facility Operation and Administration.
- b.** Installation criteria are contained in Order 6850.2, Visual Guidance Lighting Systems.
- c.** Refer to appendix B, Flight Procedures References, for other applicable orders and advisory circulars.



## Section 2-2. Aeronautical Charts

### 2-2-1. Use of maps and charts.

a. Aeronautical Information Services should maintain an adequate supply of current charts, or electronic equivalent, to support the development of instrument procedures within its area of responsibility. For manual application, the largest scale charts available should be used to develop final, circling, and the first part of the missed approach segment. For precision approach procedures, survey information or an equivalent plan and profile chart is recommended for use. For all approach procedures, the 7 1/2 and 15-minute quadrangle topographic charts (Quads) produced by the U.S. Geological Survey provide an excellent source for determining terrain elevation. For efficiency in procedure design and flight inspection, 1:100,000 scale planimetric/topographical (topo) charts are also authorized. Use other data sources such as Digital Obstruction File (DOF), AIRNAV database, Aeronautical Information Services Weekly Obstacle Memo, Digital Terrain Elevation Data (DTED), Digital Elevation Model (DEM), etc., in addition to on-site obstacle assessment evaluations, where necessary. The Sectional Aeronautical Chart (scale 1:500,000) and the visual flight rules (VFR) Terminal Area Chart (scale 1:250,000) are good supporting source documents; however, they may not depict all current information because of the extended charting cycle.

b. Map requirements for inclusion in a flight inspection package are determined by Flight Program Operations (see Order JO 8200.44, Coordination of Flight Inspection Procedure Packages).

### 2-2-2. Aeronautical charts and publications.

a. Aeronautical charts used for air navigation are generally of two groups: VFR charts and IFR charts. The VFR charts are the Sectional charts, VFR Terminal Area charts, and the visual navigation chart. IFR charts include the En Route Low and High Altitude and Area charts as well as the Terminal Procedures Publication (TPP), which includes SIAP, textual and graphic DP, STAR, and Charted Visual Flight Procedure charts.

b. The primary publication, which contains basic flight information related to instrument operations in the NAS, is the AIM. The primary publication serving as a pre-flight and planning guide for use by U.S. nonscheduled operators, business, and private aviators flying outside of the U.S. is the Aeronautical Information Publication (AIP). Flight Technologies and Procedures Division's personnel should conduct periodic surveillance of the AIM and AIP to verify the accuracy and appropriateness of the information. AIM and AIP discrepancies and errors should be forwarded to the Air Traffic Procedures, Process Support Group (AJV-81).

c. Aeronautical Information Services personnel should monitor charts or publications released by the FAA that provide informative material, recommended or mandatory, to determine that safe operating practices and conditions are accurately described for aviation users.

d. Aeronautical Information Services is responsible for the accuracy and completeness of flight data submitted by that office for publication. Procedure specialists should review the resulting published U.S. Government charts to ensure correct portrayal. Aeronautica Information

Services serves as the focal point for questions regarding the procedural data published on these charts.

**e.** Aeronautical Information Services is responsible for ensuring that U.S. Government Aeronautical Charts conform to Interagency Air Cartographic Committee (IACC) specifications.

**f.** The National Flight Data Center (NFDC) serves as the focal point for questions regarding other non-procedural data; e.g., airport/runway data, frequencies, etc. NFDC will resolve questions through the appropriate data source steward.

**g.** Any FAA personnel who find or are notified of aeronautical chart discrepancies and/or errors should send notification to [9-amc-aerochart@faa.gov](mailto:9-amc-aerochart@faa.gov).

### **Section 2-3. Environmental Requirements**

**2-3-1. Noise abatement.** The establishment of noise abatement procedures is the responsibility of the ATO. However, the Flight Standards Service has an input from an aircraft operational standpoint. These procedures should be coordinated between the appropriate AWO and the OSG-FPT. The AWO must review noise abatement procedures for aircraft performance characteristics and operational safety considerations. The OSG-FPT must review these procedures for practicality and adherence with applicable criteria, and has the primary responsibility for resolving conflicts between IFR procedures and existing or proposed noise abatement procedures.

**2-3-2. Environmental impacts.** Compliance with the following directives: Order 1050.1, Policies and Procedures for Considering Environmental Impacts, and Order JO 7400.2, chapter 32 is required to meet the environmental compliance requirements of the Agency under the National Environmental Policy Act (NEPA).

## Section 2-4. Facility Utilization and Monitoring

**2-4-1. Frequency Service Volumes.** In establishing instrument flight procedures, consideration must be given to the type of navigation facilities available and to their limitations.

**a.** All electronic navigation facilities are installed in accordance with frequency separation specified in distances and altitudes. Specific frequency protected service volumes are contained in Order 6050.32, Spectrum Management Regulations and Procedures Manual. The Regional Frequency Management Officer (RFMO) primarily uses this order. Order 6050.32 also contains information to facilitate understanding and coordination of operational considerations associated with expanded service volumes.

**b.** Operational service volume includes the standard service volume (SSV) and expanded service volumes (ESVs). The operational service volume must not extend outside the frequency protected service volume on any radial, at any distance, or at any altitude.

**2-4-2. ATC usable distance and altitude limitations.** When flight procedures are developed which reach outside of the standard service volumes listed below, the submission and processing of an ESV Request, is mandatory. Flight check measurements must not be used as a substitute for an approved ESV [see figure 2-4-1, figure 2-4-2, and figure 2-4-3].

**a.** DME/VOR/VORTAC/TACAN.

Facility Class	Usable Height Above Facility	Usable Distance (NM)
T	12000 and below	25
L	18000 and below	40
H	60000-45000	100
	Below 45000-18000	130
	Below 18000-14500	100
	Below 14500	40

**Note:** All elevations shown are with respect to the station's site elevation.

**Figure 2-4-1. Standard High Altitude Service Volume**

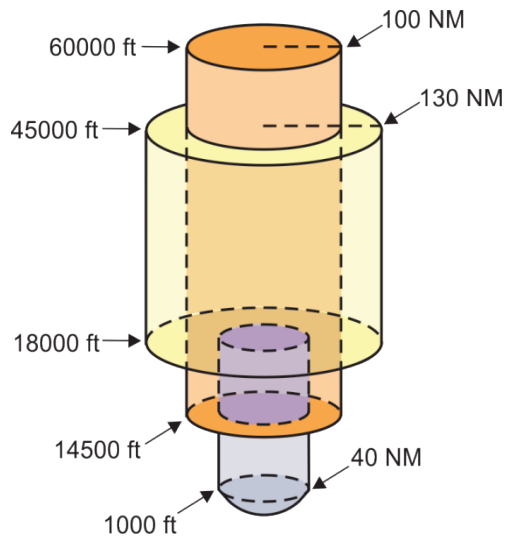

**Figure 2-4-2. Standard Low Altitude Service Volume**

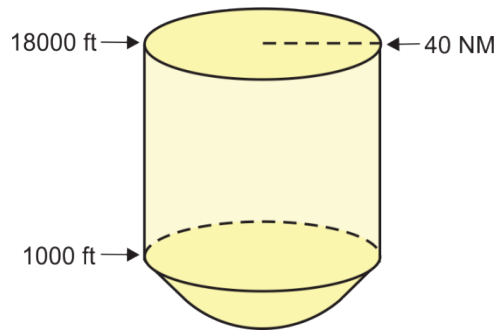

**Figure 2-4-3. Standard Terminal Service Volume**

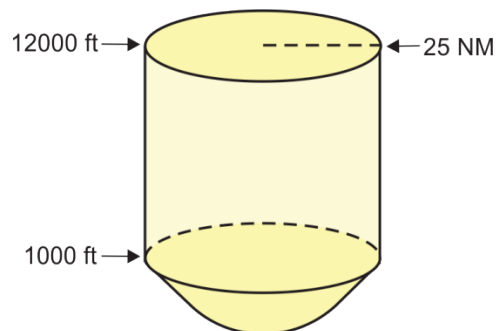

**b. Nondirectional beacon (NDB).**

Facility Class	Height Above Facility	Distance (Nautical Miles)
COMLO	<b>Note:</b> <i>Low frequency beacons have no standard height limitations</i>	15
MH		25
H		50
HH		75

**Note:** The COMLO is an NDB of low power, strategically located on an instrument landing system (ILS) approach path to provide L/MF azimuth guidance to an airport, in addition to the more precise guidance of the ILS LOC. COMLOs are normally collocated with ILS Outer Markers (OM) and Middle Markers (MM), and referred to as “LOM” and “LMM,” respectively.

**c. Instrument Landing System (ILS).**

Facility	Height Above Facility	Distance (Nautical Miles)
Localizer (FC)	4500 and below	18
Localizer (BC)	4500 and below	18
Glide Slope	(2°-4°) varies with angle	10

**2-4-3. Requests for Expanded Service Volumes.**

**a.** When ATC requires use of NAVAIDs outside (i.e., laterally and/or vertically) the limitations cited in paragraphs 2-4-2.a through 2-4-2.d, ATC submits an ESV request, with a description of the flight procedure requiring it. The Frequency Management Officer (FMO) first reviews this request. The FMO applies the criteria contained in Order 6050.32. If the FMO disapproves the request, it is returned to the originator without further action. FMO approved or restricted ESVs are then reviewed by Aeronautical Information Services.

**b.** Aeronautical Information Services is responsible for accuracy, clarity, and practicality of the data. If the ESV request is unclear, or if the FMO approved request has restrictions or restrictive comments, it may be necessary to coordinate changes with the FMO and/or the originating office. FAA flight inspection determines if the facility supports the procedure. The flight inspector may utilize facility files and approve the ESV based on supporting data, providing the data was taken within the last five years. If sufficient data are not available, accomplish a flight check of the procedure before Aeronautical Information Services approval.

**c.** The procedures specialist when developing an instrument procedure may determine a requirement for an ESV; e.g., the instrument procedure is proposed beyond SSV. In this case, the procedures specialist processes an ESV electronically via the Expanded Service Volume Management System (ESVMS website) to obtain the FMO and, in turn, flight inspection approval. An ESV request *must* not be used as a substitute for proper instrument procedure design.

**d.** Facility rotation due to magnetic variation change should have no effect on coverage; however, radials used will change. Aeronautical Information Services initiates a change action via the spectrum management web site (ESVMS) on the date the rotation is effective.

e. For holding patterns, process an ESV request for the holding fix. Describe holding fix by radial, distance, altitude.

f. An ESV is prepared and processed electronically via the ESVMS via the FAA Intranet web site. An ESV can be placed on any very high frequency omnidirectional range (VOR), instrument landing system–distant measuring equipment (ILS-DME), or tactical air navigation (TACAN). When a DME or TACAN and VOR are paired, both must have identical ESVs for safety reasons [except in those cases where the DME ESV supports DME/DME area navigation (RNAV) operations]. ESVs may be added to any class of NAVAID facilities, including NDBs.

#### **2-4-4. Utilization of localizers.**

a. A localizer must not be used for lateral course guidance on an ATS route. However, a localizer may serve as a crossing facility to define a fix on an ATS route where it is essential to air traffic control.

b. A localizer must not be used for lateral course guidance within a missed approach segment, except a localizer may be used that utilizes a straight-ahead course which crosses over the localizer antenna and then outbound on the localizer back course, provided that a back course is available.

#### **2-4-5. Monitoring of navigation facilities.**

a. Monitors. It is FAA policy to provide a monitoring system for all electronic navigation facilities used in support of instrument flight procedures. Internal monitoring is provided at the facility through the use of executive monitoring equipment that causes a facility shutdown when performance deteriorates below established tolerances. A remote status indicator may also be provided through the use of a signal-sampling receiver, microwave link, or telephone circuit. VOR, VORTAC, and ILS facilities as well as new NDBs and marker beacons installed by the FAA, are provided with an internal monitoring feature. Older FAA NDBs and some non-Federal NDBs do not have the internal feature and monitoring is accomplished by other means.

b. Monitoring categories. Navigational facilities are classified in accordance with the manner in which they are monitored.

(1) Category 1. Internal monitoring plus a status indicator installed at control point. Reverts to a temporary category 3 status when the control point is unmanned/monitoring not available.

(2) Category 2. Internal monitoring with status indicator at control point inoperative, but pilot reports indicate the facility is operating normally. *This is a temporary situation that requires no procedural action.*

(3) Category 3. Internal monitoring only.

(4) Category 4. Internal monitor not installed. Remote status indicator provided at control point. This category is applicable only to nondirectional beacons.

**2-4-6. Utilization of monitoring categories.**

- a. Category 1 facilities may be used for instrument flight procedures without limitation.
- b. Category 2 is a temporary condition not considered in instrument procedure development. The ATO is responsible for issuing NOTAMs on these out-of-service facilities when pilot reports indicate facility malfunction.
- c. Category 3 facilities may be used in accordance with the following limitations:
  - (1) Alternate minimums must not be authorized if facility provides final approach course (FAC) guidance; is required for procedure entry; is used to define the final approach fix (FAF); or is used to provide missed approach guidance [see also paragraph 8-6-11.b].
  - (2) Consider denying or adjusting terminal routes that require reception of succeeding category 3 facilities to avoid obstacles.
  - (3) Dogleg airways or routes must not be predicated on these facilities.
  - (4) Navigational fixes developed from crossing radials of category 3 facilities must not be used to break a MEA to higher MEA (can be used as a break to a lower MEA).
- d. Category 4 facilities may be used in accordance with the following limitations:

- (1) Alternate minimums may be authorized when the remote status indicator is located in an FAA ATC facility, and then only during periods the control point is attended.
- (2) If the control point is other than an FAA facility, a written agreement must exist whereby an ATC facility is notified of indicated changes in facility status.

**Note:** Failure of this category 4 status indicator or closure of the control point will render the facility and the approach procedure unusable during the outage.

**2-4-7. Utilization of 75 MHz markers.** The 75 MHz markers may be used as the sole source of identification with the following limitations:

- a. Missed approach point (MAP). Markers may be authorized as missed approach points for nonprecision approaches, provided a remote status indicator (RSI) is installed at an ATC facility.
- b. Final approach fix. As a non-precise final approach fix, the marker must be monitored if alternate minimums are authorized. The marker need not have an RSI if collocated with a compass locator with a remote status indicator.
- c. Course reversals. Procedure turns and holding must not be authorized from a 75 MHz marker.
- d. Breaks in MEAs. The 75 MHz markers must *not* be used to define the point where an en route climb to a higher altitude is required (may be used as a break to a lower altitude).



e. DP turn points. The 75 MHz markers must not be used to identify turn points on departure procedures. See Order 8260.46, Departure Procedure (DP) Program, paragraph 2-1-1.d.

## Section 2-5. Implementing Epoch Year Magnetic Variation (MV)

**2-5-1. General.** This section establishes the MV program, identifies participating offices, assigns responsibilities, and provides guidelines for accomplishing the tasks necessary for implementing, maintaining, and systematically updating epoch year MV values.

**a. Background.** The National Oceanic and Atmospheric Administration (NOAA), National Ocean Service (NOS), and the National Geodetic Survey (NGS), for all areas of the U.S. and its territories for application to navigation charts and maps, is the source for MV information and tools for establishing MV. Changing values for MV are tabulated and published on a five-year epoch basis; e.g., 00, 05, 10, 15, 20, etc. In order to assist in stabilizing the NAS, a fixed value of MV is assigned to each NAVAID and airport as the MV of record. This value is applied to true directions to obtain the magnetic values for radials, courses, bearings, and headings published in instrument flight procedures. Periodic updating of the MV assigned to navigation facilities is required to maintain reasonable proximity of alignment with the earth's ever-changing magnetic field. It is possible that the magnetic course displayed by the aircraft's RNAV system is different than the magnetic course portrayed on the IFP chart.

**Note:** RNAV systems, unlike IFP designs, generally apply the MV value stored in their navigational database, though other values are sometimes applied. As such, it is entirely possible that the MV applied by the RNAV system is different than the MV used by the procedure designer when the IFP chart was last updated. Thus, the magnetic course displayed by the RNAV system may not match the magnetic course charted on the IFP plate. Despite this difference, an RNAV system should still navigate properly as these systems use true north for navigation and only display magnetic course for pilot reference.

**b. Participating offices.** Management and control of epoch year MV values require action by the following offices:

- (1) Aeronautical Information Services.
- (2) Military organizations.
- (3) National Flight Data Center.
- (4) Western, Central, and Eastern Technical Operations.
- (5) Western, Central, and Eastern OSG-FPTs.
- (6) Regional Airports Divisions.

### 2-5-2. Responsibilities.

**a. Aeronautical Information Services.**

(1) Publish isogonic lines or segments on appropriate aeronautical charts based on current epoch year values.

- (2) Revise en route aeronautical charts and Chart Supplements to reflect revised MV assignments to navigation facilities in accordance with information published in the NFDD.
- (3) Revise en route charts to apply yearly MV change values to RNAV (“Q” and “T”) route Magnetic Reference Bearings (MRB) during the first airspace charting cycle of each calendar year.
- (4) Function as the focal point for all information relating to application of MV to the following elements of the NAS: NAVAIDs, airports, instrument flight procedures; and for coordination and liaison between Aeronautical Information Services and the applicable Air Traffic Service Center OSG-FPTs.
- (5) Function as the focal point for FAA and all NAS Facilities Flight Inspection coordination. Terminal facilities (other than VOR, VOR/DME, TACAN, VORTAC, and radar systems) do not require flight inspection of MV changes.
- (6) Determine whether NOTAM action is necessary when required procedural adjustment action or MV change is not accomplished by the effective date of amended instrument procedures or revised en route charts.
- (7) For FAA and all NAS facilities, assign and maintain MVs of record for navigational facilities and airports in whole degree increments. MVs of record are available in the AIRNAV facility database. For new or relocated facilities, and new or revised instrument procedures, apply the appropriate MV. Analyze each facility identified as a candidate for revised MV assignment to determine if facility rotation and/or re-designation of radials are required.
- (8) Establish a process to record the assigned magnetic variation and epoch year of NAVAIDs and airports by geographical location and the projected MV for the next epoch year. The process must also include the ability to identify those candidate navigational aids and airports with a difference of two degrees or more between the MV of record and the nearest future epoch year value.
- (9) Notify NFDC of changes to assigned MV and the effective date of those changes for publication in the NFDD; notify other concerned offices having related responsibilities to ensure timely implementation of necessary actions. The effective date selected must allow sufficient time for procedures processing in accordance with established schedules. MV changes, which affect only terminal instrument procedures, may have an effective date concurrent with publication of a specific procedural amendment.
- (10) Amend instrument flight procedures as required, predicated on NAVAIDs or airports undergoing a change of MV of record. Conduct a thorough review survey to determine the full impact the MV change will have on any instrument procedures. Such reviews must include high and low altitude ATS routes, direct routes, air carrier off-airway routes, fixes in both high and low altitude structures, terminal routes and fixes, ODPs, SIDs, STARs, and any other application to instrument flight procedures. Use the MV of record (or as officially changed) to develop instrument flight procedures - regardless of the MV shown on the airport diagram chart or similar product being used.

(11) VOR, VOR/DME, and VORTAC facilities supporting the en route structure (which may or may not have instrument procedures predicated on them):

(a) Modify all fixes and instrument approach procedures (IAPs). Modify all 14 CFR part 95 direct and off-airway (non-14 CFR part 95) routes with documented radial(s) or bearing(s). Change ESVs. Make all modifications to meet an effective date that coincides with the en route change cycle.

**Note:** A listing of affected fixes, holding patterns, DPs, SIDs, STARs, military training routes, preferred routes, and ATS routes may be obtained from NFDC.

(b) Coordinate changes with the OSG-FPT (OSG-FPTs are expected to coordinate with the applicable ARTCC and/or approach control) in an attempt to eliminate routes, fixes, and instrument procedures that are no longer required.

(12) NAVAIDs *not* supporting en route structure:

(a) Initiate implementation of the nearest future epoch year MV in accordance with paragraph 2-5-3.a, whenever any instrument procedure is established or amended. The nearest future epoch year MV will become effective concurrent with publication of the amendment [see paragraphs 8-6-2.1 and 8-6-10.1].

(b) Amend and process multiple instrument procedures to simultaneously become effective concurrent with the instrument procedure specified in the MV change notification to NFDC.

(c) Submit revisions of all affected fixes with the instrument procedure(s).  
Change ESVs.

(d) Amend radar procedures when the airport MV of record is changed.

(13) Army facilities.

(a) Accomplish MV changes for U.S. Army facilities in the same manner as for civil facilities; however, obtain the installation commander's prior approval.

(b) Notify the appropriate military representatives, in writing, when the need to change the MV of other military facilities is identified.

**b. United States Air Force (USAF).**

(1) Function as the focal point for all USAF applications of MV for USAF facilities within and outside the NAS to include; NAVAIDs, airports, instrument flight procedures.

(2) Function as the focal point for USAF non-NAS facility flight inspection requirements and coordination. Terminal facilities (other than VOR, VOR/DME, TACAN, VORTAC, and radar systems) do not require flight inspection of MV changes.

(3) Determine whether NOTAM action is necessary when required procedural adjustment action or MV change is not accomplished by the effective date of amended instrument procedures or revised en route charts.

(4) Assign and maintain MVs of record for USAF non-NAS navigational facilities and airports in whole degree increments. For new or relocated facilities, and for new or revised instrument procedures, apply the appropriate MV. Analyze each facility identified as a candidate for revised MV assignment to determine if facility rotation and/or re-designation of radials are required.

(5) Maintain a listing/record of USAF navigational aids and airports by geographical location. Indicate the currently assigned MV of record and the projected MV for the next epoch year. For the purpose of planning and implementation, maintain a current listing of those candidate navigational aids and airports with a difference of two degrees or more between the MV of record and the nearest future epoch year value.

(6) Notify Aeronautical Information Services of changes to USAF non-NAS facilities assigned MV and the effective date of those changes in order to generate a letter to NFDC for publication in the NFDD; notify other concerned offices having related responsibilities to ensure timely implementation of necessary actions. The effective date selected must allow sufficient time for procedures processing in accordance with established schedules. MV changes, which affect only terminal instrument procedures, must have an effective date concurrent with publication of a specific procedural amendment.

(7) Amend instrument flight procedures as required, predicated on navigational aids or airports undergoing a change of MV of record. Conduct a thorough survey to determine the full impact the MV change will have on any instrument procedure. Such surveys must include high and low altitude airways/jet routes, direct routes, air carrier off-airway routes, fixes in both high and low altitude structures, terminal routes and fixes, ODPs, SIDs, STARs, ESV's, and any other application to instrument flight procedures. Use the MV of record (or as officially changed) to develop instrument flight procedures - regardless of the MV shown on the airport diagram or similar product being used.

(8) USAF navigational facilities within the NAS:

(a) Maintain official listing of USAF facilities that are part of the NAS.

(b) Notify Aeronautical Information Services when MV changes are required.

Allow sufficient time for modification of FAA fixes and IAPs as necessary.

(9) USAF navigational facilities *not* within the NAS:

(a) Initiate implementation of the nearest future epoch year MV, as per paragraph 2-5-3.a, whenever any instrument procedure is established or amended. The nearest future epoch year MV must become effective concurrent with publication of the amendment [see paragraphs 8-6-2.1 and 8-6-10.1].

(b) Amend and process multiple instrument procedures to simultaneously become effective concurrent with the instrument procedure specified in the MV change notification to NFDC.

(c) Submit revisions of all affected fixes with the instrument procedure(s). Change ESVs, as required.

(d) Amend all procedures as, required, when the airport MV of record is changed.

**c. United States Navy.**

(1) Contact Aeronautical Information Services to obtain the MV of record or MV assignments for new or relocated facilities to be applied to navigational aids or airports under U.S. Navy jurisdiction.

(2) Coordinate with Aeronautical Information Services to determine impact of MV changes for both military and public facilities.

(3) U.S. Navy flight procedure development work generally follows the same requirements as Aeronautical Information Services' flight procedure development work as outlined in paragraphs 2-5-2.b(3) through 2-5-2.b(9). Aeronautical Information Services will remain the office of primary responsibility for paragraphs 2-5-2.b(1), 2-5-2.b(2), 2-5-2.b(4), and 2-5-2.b(5) functions.

(4) Notify Aeronautical Information Services of changes to U.S. Navy, non-NAS facilities, assigned MV and the effective date of those changes in order to allow Aeronautical Information Services to publish them in the NFDD; notify other concerned offices having related responsibilities to ensure timely implementation of necessary actions. The effective date selected must allow sufficient time for procedures processing in accordance with established schedules. MV changes, which affect only terminal instrument procedures, must have an effective date concurrent with publication of a specific procedural amendment.

(5) U.S. Navy navigational facilities within the NAS:

(a) Maintain official listing of U.S. Navy facilities that are part of the NAS.

(b) Notify Aeronautical Information Services when MV changes are required. Allow sufficient time for modification of FAA fixes and IAPs as necessary. National Flight Data Center, when notified by Aeronautical Information Services of any change to MV of Record, publish a notice of change in the NFDD. An effective date of change must be included in the NFDD.

**d. OSG-FPT.**

(1) Notify Aeronautical Information Services of MV changes when informed by non-FAA service providers maintaining instrument procedure(s) they are responsible for.

(2) The OSG-FPTs will coordinate with the regional airports and Air Traffic offices with respect to matters pertaining to change in navigational aid or airport MV of record and its effect on instrument flight procedures.

e. Western (AJW-W), Central, (AJW-C), and Eastern (AJW-E) Technical Operations. Coordinate with the respective OSG-FPT to obtain the appropriate MV of record for assignment to newly installed or relocated navigational aids.

f. Regional Airports Division/Airports District Office (ADO). Coordinate with the applicable OSG-FPT prior to establishing or revising runway designator numbers for an airport having one or more instrument approach or departure procedures, to determine the appropriate MV to be applied to the runway true bearing. Determination of the runway designator number should be a matter of joint agreement with Aeronautical Information Services, and be accomplished sufficiently in advance to allow for procedural amendments. Take appropriate NOTAM action if repainting of an affected runway has not been accomplished on the required date.

**2-5-3. Guidelines for Magnetic Variation (MV) revisions.** The identification and selection of NAVAIDs or airports, as candidates for revision of MV of record require careful consideration and evaluation of a number of factors - as the impact of MV changes can be considerable. The applicable Air Traffic Service Area Office may have to initiate or revise published air traffic procedures; the Technical Operations Service (AJW-0) is directly involved in NAVAIDs/radar rotations and requires proper coordination. The Airports Division, or appropriate military authority, may have to arrange for repainting of runway designator numbers [see paragraph 8-3-4.b(5)].

**Note:** Guidelines pertaining to runway designation marking relative to magnetic changes can be found in AC 150/5340-1, Standards for Airport Markings.

a. MV versus epoch year value. The NOAA World Magnetic Model (WMM) is used to determine the current MV at a location and to calculate the future MV for use in procedure design and publication. The model estimates the MV at any location and day within the five-year validity window of the model. For example, the WMM released in December 2009 provides MV values for all locations for January 1, 2010 through December 31, 2014. The nearest future epoch year value calculated using that model would be specified as 2015, and the MV based on the December 31, 2014 value, except as indicated in paragraph 2-5-3.c. The assigned MV is listed as using the 2015 epoch year even when the value is associated with a date earlier in the validity period of the model.

b. Standard MV limits for airports and NAVAIDs. When the difference between the MV of record and the nearest future epoch year value of any NAVAID, or the assigned airport MV of record, will exceed three (3.0) degrees [five (5.0) degrees for VORs and VORTACs], the MV of record must be changed to the nearest future epoch year value and applied to airport reference point (ARP) and all on-airport NAVAIDs. Consider implementing the change earlier in cases where revisions of multiple procedures are required for other reasons, such as when other nearby airports are being updated or when weather, or other factors, would preclude the change being accomplished at the time the MV would actually exceed three (3.0) degrees. Off-airport

NAVAIDs must be maintained within three (3.0) degrees [five (5.0) degrees for VORs and VORTACs], especially when they support instrument procedures.

c. MV limits for airports with SA CAT II or CAT II/III approach procedures. The intent is to keep the NAVAID and procedure MV closely aligned with the actual (as predicted by the WMM) MV at the airport. Maintain the assigned MV value for these airports, NAVAIDs, and procedures within  $\pm 1$  degree of the current computed airport MV. At locations with SA CAT II or CAT II/III instrument procedures, do not apply future epoch year MV values that would create a rounded whole number MV of record that exceeds one (1.0) degree of the current, computed airport MV. At airports with SA CAT II or CAT II/III instrument procedures, the one-degree tolerance effectively applies to the airport MV, the MV for NAVAIDs on the airport, and the MV for all RNAV procedures required to use the aerodrome MV as indicated in paragraph 2-5-3.g(2). An “on airport” VOR or NDB at CAT II/III airports may exceed the one-degree tolerance, but must not exceed three (3.0) degrees [five (5.0) degrees for VORs and VORTACs] from the airport MV of record. The difference between the “on airport” VOR or NDB and ILS or GLS MV must not exceed four (4.0) degrees. Larger differences may cause issues for avionics used to fly coupled and autoland approaches.

d. Runway magnetic azimuth must be based on the assigned MV of record for the airport.

**Note:** Runway headings and MV are published on airport diagrams to allow pilots to obtain a compass bearing check during runway line-up. These values may differ from the airport MV of record, and are not used in procedure design.

e. MV for RADAR facilities. The ARP MV of record at the designated controlling airport may be used in determining the MV applied to all airports, NAVAIDs, and RADARs serving the terminal areas.

f. Coordination of MV updates. MV updates are coordinated by the Regional Airspace and Procedures Team (RAPT). Factors to consider include when the MV will exceed the required tolerance, whether the navigational aid is isolated, or in close proximity to one or more other NAVAIDs, whether on-airport or off-airport, and the impact on instrument flight procedures.

g. Standard rules for applying MV to true radials, bearings, courses, and headings.

(1) Ground-based NAVAIDs and radar.

(a) Utilize the NAVAIDs MV of record to determine magnetic tracks, and courses.

(b) Runways that have SA CAT II or CAT II/III approach procedures must have the charted final course conforming to the runway heading updated when the difference is greater than one (1.0) degree.

(2) RNAV.

(a) Instrument approach procedures (IAPs)/DPs/STARs, including GLS. MV is applied to any track/course used in an RNAV instrument procedure and it must be the MV of the



aerodrome of intended landing or departure. When a SID/STAR serves multiple airports, a primary airport must be selected for the MV that will be used. Some aircraft navigation systems use a “reference NAVAID” for obtaining MV information based on course (Cx) leg types and track from fixes (Fx) leg types. For IAPs, specify in the database record [for RNAV Departure Procedures, specify in the “Remarks” section of Form 8260-15C, Departure (Data Record)], a NAVAID that has the *same* assigned MV as the airport MV. For STARs, see paragraphs 4-5-3 and 4-5-4 for documentation requirements.

(b) Holding on RNAV IAPs/DPs/STARs. To determine the magnetic track/course, apply the published MV of the aerodrome, or the en route VOR or NDB assigned variation when proceeding “to” the NAVAID used as part of a procedure/holding pattern fix to the procedure true track/course.

(c) Holding on RNAV routes or stand-alone. For RNAV only holding patterns not associated with an instrument procedure or a VOR or NDB used as the holding fix, determine the MV by using the magnetic declination (variation) for the holding fix latitude/longitude. This information may be calculated using the WMM.

(3) Diverse Vector Area (DVA). Use airport MV of record when defining DVA heading limitations.

## **Section 2-6. Notices to Airmen (NOTAMs)**

**2-6-1. General.** NOTAMs provide timely knowledge to flyers and other aviation interests regarding information or conditions which are essential to safety of flight. NOTAMs pertaining to IFPs are effective upon issuance and must remain in effect until the pertinent aeronautical charts are amended or the condition requiring the NOTAM ends. Management and operational guidance is contained in Order JO 7930.2, Notices to Airmen (NOTAMs).

**2-6-2. United States NOTAM System.** The United States NOTAM System (USNS) has been established to provide aviators with the current status of the NAS. This system is under the purview of FAA's Air Traffic Organization, Vice President of System Operations Services, Flight Services, Safety and Operations Policy Group (AJR-B1). The following describes the use of FDC NOTAMs and related issues due to IFP changes, NAVAID outages, and government aeronautical chart corrections.

**a.** FDC NOTAMs are normally used to disseminate safety of flight information relating to regulatory material as well as to all IFPs and are issued through the United States NOTAM Office (USNOF). See Order JO 7930.2, chapter 7, for specific FDC NOTAM policy.

**b.** NOTAM Ds. See Order JO 7930.2, chapter 4, for NOTAM D policy.

## **Section 2-7. Quality/Standardization of Instrument Flight Procedures**

### **2-7-1. Aeronautical Information Services action.**

**a.** Aeronautical Information Services is responsible for the accuracy of instrument flight procedures it develops, and for establishing and conducting a system of quality control that ensures such procedures conform to applicable criteria, standards, and policy.

**b.** Aeronautical Information Services' system of quality control must ensure that all flight procedures and NOTAMs submitted to NFDC are of a professional quality that will not require corrections or changes following release.

**c.** When unusual circumstances exist, for which policy is not clear or is nonexistent, request a policy determination from the Flight Procedure Implementation and Oversight Branch prior to submission for publication. Appropriate instructions will be issued as necessary.

**d.** Instrument charts produced by Aeronautical Information Services must be reviewed for variations from information submitted for publication and for clarity of the graphic portrayal. Charting errors detected must be immediately corrected by NOTAM [see section 2-6]. Charts that do not clearly portray the procedure(s) as designed should be referred to the Flight Procedure Implementation and Oversight Branch and Aeronautical Information Services, Quality Assurance and Standards Team, with recommendations for charting improvements.

### **2-7-2. Flight Procedure Implementation and Oversight Branch's action.**

**a.** The Flight Procedure Implementation and Oversight Branch is responsible for providing oversight of non-FAA service provider's Quality Assurance (QA) process to determine conformance with applicable criteria, standards, and policy.

**b.** Preliminary reviews may be conducted by the Flight Procedure Implementation and Oversight Branch upon request of a non-FAA Service Provider.

## Section 2-8. Periodic Review of Instrument Flight Procedures

### 2-8-1. General.

a. This section prescribes the minimum frequency of review of instrument procedures. When deemed necessary, and in the interest of safety or for other proper justification, make more frequent reviews. Review all instrument procedures to ensure that requirements for obstacle clearance, navigational guidance, safety, and practicality are met. When directed by Flight Standards, immediately comply with changes to criteria. Use the review to determine if the procedure must be amended to support changes to new/revised criteria and policy. These changes include, but are not limited to such items as obstacle assessment areas (i.e., to ensure proper OE actions are being administered), procedure naming, requirements to add/remove/modify chart notes, etc. Consideration must also be given to the impact of OEs, F&E, and AIP projects pertinent to the procedure review process. Reviews will be completed within the timeframes specified in paragraph 2-8-2. Document all required changes, including criteria/policy and how they affect the current procedure during the review.

b. The date for determining when a periodic review is due is based on the procedure original or last full amendment "Approved by" date indicated on the applicable 8260-series form. Subsequent periodic reviews must be based on the completion date documented for the previous periodic review. An abbreviated amendment and P-NOTAM dates must not be used in calculating periodic review requirements.

c. A periodic review is considered completed if it occurs in the period from one month prior to one month after the month in which the periodic review is due; e.g., if the periodic review is due in July, the window is June 1 to August 31. If the window is met, the month it is due remains unchanged. However, if the periodic review occurs outside of the specified window, the next review is due in the month in which the review was actually completed.

d. Document periodic reviews to show the date when review was conducted and include a synopsis of review results based on items mentioned in paragraph 2-8-2, specifying what action, if any, was taken. The method (spreadsheet, memorandum, etc.) used to document the periodic review is at the discretion of the procedure development authority.

#### **Example:**

NEED TO APPLY CURRENT RULE OF VEGETATION/AAO TO ALL RUNWAYS. RWY 4: REQUIRES A TEXTUAL DEPARTURE PROCEDURE CLIMB HEADING 040.51 TO 1500 BEFORE TURNING LEFT DUE TO NEW OBSTRUCTION IN DIVERSE A AREA 55-000821. RWY 22: SATISFACTORY. RWY 9: SATISFACTORY. RWY 27: PREVIOUSLY DOCUMENTED ICA OBSTRUCTION IS NOT IN THE DATA BASE. MAP STUDY SHOWS IT APPEARS TO BE STILL THERE AND ORS TEAM CONTACTED. OBS EVALUATED AT 4D WHICH REQUIRES NEW CLIMB GRADIENT. TRUE COURSE ON AIRNAV APPEARS TO BE INCORRECT AND EMAIL SENT TO FPT TO VALIDATE. NOTAM ISSUED FOR RWY 4 DIVERSE DEPARTURE AND RWY 27 CLIMB GRADIENT.

e. When facility restrictions are established or changed, review all associated flight procedures. Take particular care to evaluate unpublished procedures such as off-airway, direct, and substitute routes.

### **2-8-2. Reviewing organization action.**

**a. SIAPs, SIDs, ODPs, DVAs, and STARs.**

(1) Review at least once every two years, approach procedure final (to include the visual portion), circling, missed approach, and ODPs and DVAs for any changes required, including procedure naming, an adjustment to visibility minimums, a flight altitude, descent gradient, and/or climb gradient.

**Note 1:** When applying the new circling area to a given procedure, evaluate all IAPs at the airport to ensure uniformity of circling minima. New circling criteria dimensions may require a revision to controlled airspace boundaries.

**Note 2:** When reviewing ODPs, ensure all SIDs to the same runways are also reviewed for any impact due to ODP changes.

(2) In addition to the policy action in paragraph 2-8-2.a(1), review at least once every four years the STARs, SIDs and all approach procedure segments for any required changes that would require an adjustment to a flight altitude descent gradient and/or climb gradient. Continue to comply with the following:

(a) To avoid proliferation of conflicting data on IFPs at an airport, all other procedures at the airport must be considered for possible impact and revision(s).

(b) Ensure all procedures are contained within controlled airspace as prescribed in chapter 5.

(c) Ensure approach/departure minimums meet criteria. Review IFP forms for conformance to current standards. Check published IFP charts and text for correct portrayal of source data.

(d) Verify current magnetic variation values.

(e) Verify the validity of existing waivers and cancel waivers no longer required.

(f) If the results of the review indicate a need to amend an IFP, coordinate proposed changes (including Notices to Airmen) in advance with the applicable OSG-FPT. The FPT will coordinate with airport management, the RAPT and servicing air traffic control facility when application of new or revised criteria raises minimum procedure altitudes and/or increases takeoff/landing minimums. The FPT must be provided a copy of the documentation required by paragraph 2-8-1.d.

**b. Airways, airway segments, and routes.**

(1) Review at least once every four years.

(2) Verify controlling obstacles and assure that authorized altitudes meet obstacle clearance requirements. Use current en route charts as airway checklists.

**c.** Fixes.

(1) Review all fixes in conjunction with the associated IFPs, airways, or routes [see section 2-10]. Assure that Form 8260-2, Radio Fix and Holding Data Record, entries for facility type, class, radial/course/bearing, distances, and charting requirements are correct. Verify holding requirements and controlling obstructions.

(2) Cancel fixes and holding which are no longer needed.

**d.** All procedures.

(1) Establish and maintain a system of control to assure that reviews are accomplished.

(2) Take remedial action by NOTAM or revised 8260-series form.

(3) Review all associated waivers in conjunction with any procedure review.

(4) Annotate and incorporate editorial changes noted during the review in the next revision. Do *not* make IFP amendments solely to correct a minimum safe altitude (MSA) except when the MSA provides less than 950 feet of obstacle clearance.

## Section 2-9. Communications and Weather

**2-9-1. Communications requirements.** Order 8200.1, chapter 8, defines communication tolerances and flight inspection procedures. Even though gaps in navigation course guidance may be approved, reliable communications coverage over the entire airway or route segment at minimum en route IFR altitudes must be available.

a. MEAs or MAAs are predicated upon continuous approved communications capability for the entire designated segment. All available resources must be explored before restricting the use of altitudes of an airway or route due to a lack of acceptable communications coverage. Coordination must be effected with ATC for determination of the acceptability of communications coverage in a particular area.

b. Mandatory communications with the appropriate ARTCC are not required; communications with other ATC facilities are allowable. Where necessary, in order to provide direct communications with a center, appropriate recommendations for a peripheral site should be made.

c. Communications requirements for non-14 CFR part 95 routes certified for a particular air carrier are the responsibility of appropriate AWO.

**2-9-2. Use of UNICOM.** UNICOM may be used to satisfy the communications requirements of Order 8260.3, chapter 1; however, there are limitations on its use that must be considered. According to FCC rules and regulations, part 87, Subpart C, UNICOM stations are not authorized for ATC purposes other than the relay of the following information between the pilot and controller:

a. Revision of proposed departure time.

b. Time of takeoff, arrival, or flight plan cancellation.

c. ATC clearances *provided* a LOA is consummated by the licensee of the advisory station (UNICOM) with the FAA.

d. Weather information. Only if there is no FAA control tower or Flight Service Station, or during periods when an FAA unit is not in operation. Direct transmission of approved altimeter setting to the pilot is authorized provided the procedure states an alternate course of action if UNICOM is not contacted.

**Note:** FCC regulation places the responsibility for the LOA on the licensee, but Order JO 7210.3 suggests that an ATC facility prepare the agreement. A communication capability between the UNICOM station and ATC is necessary to meet requirements of Order 8260.3, chapter 1.

**2-9-3. Automatic altimeter setting and weather reporting systems.** Approved devices for automatically reporting altimeter settings and weather may be used to satisfy the requirements of Order 8260.3, chapter 1. Special notes will be required on the approach charts. Examples of standard notes can be found in paragraph 8-6-11.h.

## Section 2-10. Navigational Fixes

**2-10-1. General.** Criteria for navigational fixes are contained in Order 8260.3, chapters 2 and 15. When using a VORTAC or VOR/DME, fixes should be defined by DME from the facility providing course guidance in addition to radials or course intersections.

**2-10-2. Reporting points.** Reporting points are established for use by the ATO in the movement and separation of aircraft. Reporting points are divided into two categories, which are:

**a.** Compulsory reporting points are designated by regulation and; therefore, require rulemaking action. It is the ATO's responsibility to initiate airspace rule making action for the designation of compulsory reporting points. Unless the reporting point can be identified at the lowest operational altitude, it must not be designated a compulsory reporting point.

**b.** Non-compulsory reporting points may be established by the ATO without the requirement for rule making action.

**2-10-3. Unplanned holding at designated reporting points.**

**a.** Where required for aircraft separation, ATO may request aircraft to hold at any designated reporting point in a standard holding pattern at the MEA or MRA, whichever altitude is the higher, at locations where a minimum holding altitude has not been requested. For this reason, the conditions to be considered for holding (obstacle clearance, communications, and facility performance) must be reviewed whenever reporting points are established or revised, even though specific holding authorization has not been requested by the ATC facility.

**b.** Unplanned holding at en route fixes may be expected on airway or route radials, bearings, or courses. If the fix is a facility, unplanned holding could be on any radial or bearing. Where standard holding cannot be accomplished at the MEA or MRA, any necessary limitations must be clearly indicated on Form 8260-2.

**2-10-4. Requests for navigational fixes.**

**a.** Form 8260-2 is the vehicle used to transmit requests for the establishment, revision, or cancellation of navigational fixes, holding patterns, and/or reporting points. All fix requests must be processed to the NFDC, AJV-53, for publication in the NFDD. See section 8-5 and appendix D for guidance on filling out Form 8260-2 and requesting additions/deletions to existing fixes that are under the control of a different office of responsibility (OPR).

(1) Aeronautical Information Services is responsible to initiate and maintain Form 8260-2 for those navigational fixes that are required for the development of all 14 CFR part 95 routes and those 14 CFR part 97 FAA-developed and maintained instrument procedures for which they are responsible.

(2) The requesting ATC facility is responsible for initiating and maintaining (i.e., update the form and process changes when they occur) a Form 8260-2 on those ATC operationally required navigational fixes including charted visual flight procedures (CVFPs). The requesting ATC facility is responsible for coordinating with adjacent ATC facilities as deemed necessary, and



then processing the form through the appropriate Service Center OSG-FPT to NFDC. A Form 8260-2 submitted with a request for area navigation visual flight procedures (RVFPs) also require OSG-FPT approval and submission to NFDC.

(3) “Service Providers,” also referred to as “non-FAA Service Providers,” of instrument flight procedures are responsible for initiating and maintaining the Form 8260-2 for those fixes that will not be used by the FAA on other instrument or air traffic procedures. These Form 8260-2s must be submitted to the Flight Procedure Implementation and Oversight Branch with the instrument procedure package, prior to forwarding to NFDC. See appendix D for processing guidelines when using an existing fix that has an FAA OPR.

(4) The military is responsible for initiating and maintaining the Form 8260-2 for those fixes that are for military operations that are not a part of a 14 CFR part 95 route and/or 14 CFR part 97 instrument flight procedures.

(5) Transferring OPR to Aeronautical Information Services is required when a fix used solely for ATC purposes or in a non-FAA Service Provider-developed procedure, or military fix is re-designated for use in an FAA-developed instrument flight procedure. When this occurs, Aeronautical Information Services will first coordinate with the current OPR, then generate a new Form 8260-2 showing them as the OPR for that fix.

(6) All OPRs are responsible for coordinating any fix/holding pattern changes with all organizations that are responsible for procedures identified under “Fix Use.” In order to prevent extensive, costly, and time consuming procedure changes, fix movement and/or changes to holding patterns, or cancelations must not occur until all affected fix users have agreed to the change.

**Note:** When establishing effective dates for changes of a Form 8260-2 that also affects Special instrument flight procedures (IFPs), consideration must be given to processing times required to update and distribute these revised procedures to the users/operators. The processing time for Special IFPs is considerably longer than the time required for processing the same change that affects public IFPs due to the special procedure approval and operator authorization processes. If Aeronautical Information Services is the OPR, they must coordinate the effective date of an amended Form 8260-2 utilized in special instrument procedures with the appropriate AWO, prior to processing through NFDC, to minimize the impact on the users/operators.

**b.** Every effort should be made to use established fixes or NAVAIDs wherever possible in lieu of creating new fixes. Do *not* create a new waypoint over an existing fix or NAVAID. Do not use any VOR/DME or VORTAC where the VOR coordinates and DME source coordinates are not identical to 0.01 second in RNP AR procedures. Additionally, when establishing new fixes that will be placed on Victor Airways or Jet Routes solely to support RNAV instrument procedures, define them using crossing radials or a DME fix. Additionally, if ATC uses an existing fix for ATC purposes, Form 8260-2 must be updated accordingly [see paragraph 8-5-2.j].

**2-10-5. Naming navigational fixes.** In order to satisfy the requirements of the Flight Management System (FMS), the following applies for all procedures:

a. All navigational fixes must be named except as noted below. Named fixes collocated with a facility retain the same name as the facility [see Order JO 7400.2, Procedures for Handling Airspace Matters]. Navigational fix names consist of a five-letter combination and are obtained from NFDC. Unless otherwise stated in this section, “fix” means a non-RNAV fix, RNAV waypoint, or CNF. Determine fix names as follows:

- (1) Fixes not to be named.
  - (a) VDPs.
  - (b) Radar fixes used on ASR and/or PAR procedures.
  - (c) MAP at LTP (e.g., DME used at the MAP, FAF to MAP timing where the MAP is the LTP).
  - (d) Lead radials or lead bearings.
  - (e) COPTER RNAV. PinS approach annotated “PROCEED VISUALLY”: Any ATD fix located between the MAP and visual segment descent point.

(2) Pronounceable fix names. Except as stated in paragraph 2-10-5.a(3), all fix names serving any IFP must be pronounceable. Additionally, a non-RNAV Glidepath Intercept Point (GPIP) located prior to the non-precision FAF on the same chart, by one nautical mile (NM) or greater, must be a pronounceable five-letter name. This naming requirement also applies to the GPIP of a stand-alone vertically-guided procedure absent of non-precision minima on the same chart. These instances do not require documentation of fix makeup in the facility block(s) on the Form 8260-2.

- (3) Non-pronounceable fix names. The following fixes should be non-pronounceable:
  - (a) Fixes located between the FAF and MAP and No-FAF stepdown fixes.  
Exception: RADAR fix names must be pronounceable.
  - (b) MAP. Where the MAP is *not* at the LTP *and* FAF to MAP timing is not used.

(4) Computer navigation fixes (CNFs). These are non-pronounceable fix names used solely to aid in computer navigation. CNFs are not used in ATC communications, are not flight-inspected, and do not employ any type of fix makeup. CNFs are charted in parentheses and must begin with the letters “CF” followed by three-consonants; e.g., “(CFWBG)”, except the letter “Y” is not used. Use a CNF for the following fixes:

- (a) Non-RNAV MAP *not* at the LTP. Establish the MAP as a CNF *only* if FAF to MAP timing is used.
- (b) RF center fixes.
- (c) En route dog leg changeover points when required by paragraph 8-8-1.h.

**Note:** Earlier versions of CNF's include any combination of five-letter non-pronounceable fix names. Currently "charted" CNF's that do not meet the "CFXXX" naming methodology must be converted to meet this standard when identified at the next periodic review or scheduled amendment, whichever occurs first.

(5) VFR waypoints. These are five-letter names beginning with "VP." *Do not* use fixes beginning with the letters "VP" for flight procedures and/or routes.

**Example:** VPXYZ

**b.** Coordinate with NFDC and the appropriate ARTCC when a fix name change is required. Document the change on Form 8260-2. Canceled fix names must be reserved again at NFDC and cannot be re-used until six months after cancellation.

**c.** When a fix must be moved, refer to Order JO 7400.2 for guidance on whether the five-letter name may be retained or must be changed.

#### **2-10-6. Documenting navigational fixes.**

**a.** All named civil and military fixes must be documented and approved on Form 8260-2. Chapter 8 of this order contains instructions for entering data and submitting Form 8260-2.

**b.** Military fixes are also maintained in the national database and are used to support the air traffic system. Therefore, the requirement to document and flight inspect military fixes must receive the same priority as the fixes that support civil procedures.

**2-10-7. Correlation of navigational fixes and changeover points.** The designation of navigational fixes should be directly related to COPs. Care should be taken to avoid designating navigational fixes that require the use of a facility beyond the COP. Figure 2-10-1 is an example of the proper and the improper method of designating a navigational fix in relation to COPs.

**Note:** These diagrams illustrate a problem encountered when handling intersections and changeovers. Make certain the entire complex is reviewed to prevent establishing procedures that are in conflict with the usability of the facilities involved.

**Figure 2-10-1. Proper and Improper Method of Designating a Navigational Fix**

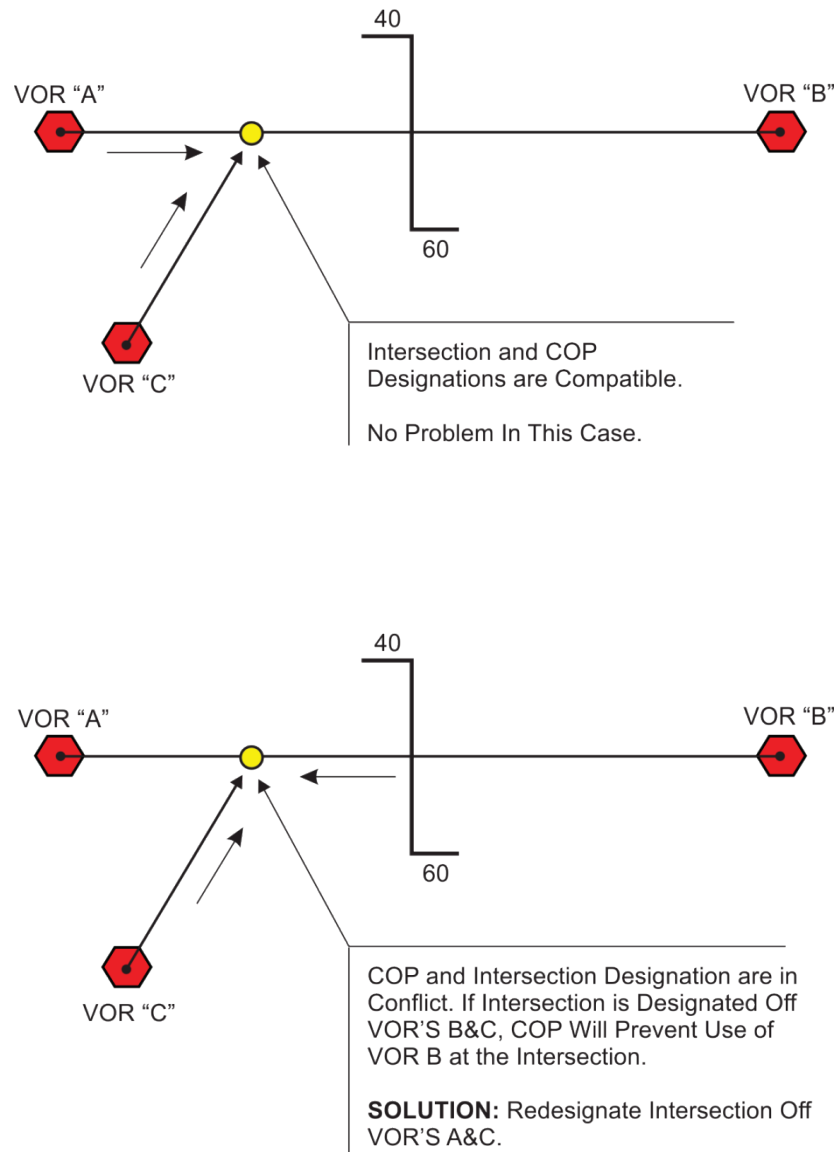

**2-10-8. Minimum reception altitudes.** At certain navigational fixes, VOR reception from an off course facility may not be adequate at the lowest MEA associated with the route segment. In such cases when the MRA at the fix is higher than the MEA for instrument flight, the MRA must be established for the fix and indicated on Forms 8260-2 and 8260-16. Once established, an MRA will not be revised unless the reception altitude is changed by 200 feet or more [see paragraph 8-5-2.g(3)(j)]. MEAs at each designated compulsory reporting point must not be lower than the MRA for the fix. Where necessary, dual MEAs may be utilized to meet this requirement.

**2-10-9. Flight inspection.** After completion of required coordination, flight inspection personnel must confirm facility performance at the proposed operational altitudes. Where

possible, determinations are to be predicated on current facility performance records; otherwise, a flight check must be accomplished.

**2-10-10. Maximum authorized altitudes.** MAAs are procedural limits that might be determined by technical limitations or such other factors as limited airspace or compatibility with other procedures. Where MAAs are required in connection with the publication of flight procedures, they are included on Forms 8260-2 and 8260-16, or worksheets used to process the data [see also paragraph 8-5-2.g(3)(k)].

## Section 2-11. Obstacle Data

**2-11-1. General.** The primary purpose of obstacle evaluation is to determine how an object will affect instrument flight procedures. The evaluations provide accurate, consistent, and meaningful results and determinations only if procedure specialists apply the same rules, criteria, and processes during development, review, and revision phases. Do not conduct an *obstacle* evaluation for instrument flight procedure operations above 18,000 feet in the contiguous United States (CONUS) or above 23,000 feet for Alaska and Hawaii. This section also provides basic information regarding obstacle data sources; establishes the minimum accuracy standards for obstacle data and its application in the development, review, or revision of instrument procedures; and provides information on the application of the minimum accuracy standards. The minimum standards, regardless of the data source, are to be applied by instrument procedure specialists in all instrument procedure obstacle evaluations. See Order 8260.3 for obstacle definition.

### 2-11-2. Obstacle application and data sources.

**a.** The Aeronautical Information Services' Obstacle Data Team (ODT) maintains as-built manmade obstructions data reported under 14 CFR part 77 which may have an effect on the safe and efficient use of the navigable airspace. The data is maintained in the Obstacle Authoritative Source database which also contains obstructions reported through various other sources, such as: Flight Inspection; OE/AAA; NOAA/NGS photogrammetric assessments; Federal Communications Commission (FCC); Airports Geographic Information System (GIS); Third Party Survey System (TPSS); FAA instrument procedure flight validation (IFPV) authorized personnel conducting ground obstacle assessment (GOA) and airborne obstacle assessment (AOA); and the general public. From this database, the Obstacle Data Team generates numerous digital obstacle data products such as the Digital Obstruction File (DOF) and the Daily Digital Obstruction File (DDOF). The Obstacle Data Team will provide obstacle data as necessary for procedure development and to other FAA offices. Requests for obstacle data should: identify the DOF obstacle number e.g., 01-00103 and/or the Aeronautical Study Number; identify the area desired by geographical coordinates or a specified radius from an ARP or navigation facility; and be accompanied by any source and/or survey documentation available.

**b.** Absence of obstacle data in an electronic database and/or lack of survey data specified in AC 150/5300-13, Airport Design, do not preclude development of an instrument procedure. Lack of survey data may not permit lowest possible minima. Lack of a vertical guided survey per Advisory Circular 150/5300-18 may preclude a vertically guided approach.

**c.** Determine obstacle height additives required for traverse ways when manually generating obstacle data for instrument procedure development. Use 17 feet for an interstate highway, 15 feet for a non-interstate highway/road, 10 feet for a private road (unless the highest mobile object expected to use that road exceeds 10 feet, then the actual height of the object would be used), and 23 feet for a railway. For other traverse ways, such as waterways, light rail, etc., the actual height of the highest object expected to use the traverse way would be added. These are all considered "transitory obstacles" that could penetrate a TERPS surface. These, and other "transitory obstacles" may be ignored and/or the heights adjusted (as applicable) when means are

established to control its height, location, or both. The control method must be documented in the “Additional Flight Data” portion of the applicable 8260-series form.

**2-11-3. Obstacle data accuracy standards.** This paragraph identifies the *minimum* requirement for accuracy of obstacle data used in the development of MVA/MIAs and instrument procedures; providing the minimum accuracy standards for each.

**a.** Concept. Obstacle data accuracy is not absolute, and the accuracy depends on the data source. The magnitude of the error does not preclude the use of these data, provided it is identified and accounted for. In some cases, upgrading obstacle accuracy can provide relief from operational restrictions in an instrument procedure. This will allow expenditure of funds for obstacle surveys in areas where benefit to the aviation community would result. In no case; however, will the application of obstacle data accuracy preempt the requirement for the flight check of an instrument procedure for discrepancies. For sources of obstacle data accuracy, see appendix C.

**b.** Standards. The minimum accuracy standards in this order are for use in the development, review, and revision of instrument procedures. They must be applied to all new procedures and to existing procedures at the next revision or periodic review, whichever occurs first. The minimum accuracy standards are listed in paragraphs 2-11-3.b(1) through 2-11-3.b(5). *Adjust* the location and/or elevation of the segment-controlling obstacle by the actual accuracy value assigned to the obstacle *only*, if the horizontal and/or vertical accuracy assigned to the obstacle does not meet or exceed the standards listed below. For example, if the nonprecision final segment controlling obstacle has an assigned accuracy of 250 feet horizontal and 50 feet vertical (4D), artificially adjust its location by 250 feet laterally, and increase its elevation by 50 feet; this is because 250/50 does not meet or exceed the minimum accuracy requirement of 50 feet horizontal and +20 feet vertical (2C) as required by a nonprecision final segment. Conversely, if the assigned accuracy is 60 feet horizontal and 15 feet vertical, adjust only the obstacle location by 60 feet; do not increase the obstacle elevation by 15 feet because the assigned vertical accuracy exceeds the vertical accuracy requirement for a nonprecision final segment.

(1) +20 feet horizontal and +3 feet vertical accuracy (1A). Precision and APV final and section 1 of the missed approach segment.

(2) +50 feet horizontal and +20 feet vertical accuracy (2C). Nonprecision final segments; missed approach 40:1 surface evaluation; circling areas; Visual Climb Over Airport (VCOA) level surface; and the initial climb area (ICA) for all DPs.

(3) +250 feet horizontal and +50 feet vertical accuracy (4D). Intermediate segment. For DPs: all areas outside of the ICA, including VCOA sloping surface.

(4) +500 feet horizontal and +125 feet vertical accuracy (5E); [1000 feet ROC and Special required obstacle clearance (ROC) {e.g., MVA/MIA reduced ROC in mountainous areas}]; (non-mountainous). Initial segments; feeder segments; en route areas; missed approach holding and climb-in-holding level surface evaluation; MSA; ESA; MVA; EOVM; MIA. For DPs and SIDs: level route portion.

(5) +1000 feet horizontal and +250 feet vertical accuracy (6F); (2000 feet ROC) (mountainous). Feeder segments; en route areas; ESAs; MVA; EOVM; MIA. For DPs and SIDs: level route portion.

c. Automated obstacle database. The obstruction database file contains obstacle location and elevation data. The data contains both verified and unverified obstacles. Discrepancies in the obstacle database found in the development, review, and revision of instrument procedures must be identified to Aeronautical Information Services. Obstacles contained in the DOF marked as “Dismantled” are not to be used in obstacle assessment of instrument procedures.

**2-11-4. Accuracy standards application.** Adjust the instrument procedure to meet the requirements of the minimum accuracy standards. Accuracy adjustments are not applied to obstacles evaluated relative to Order 8260.3, paragraph 2-9-10 (Obstacles Close to PFAF or Final Approach Segment SDF), visual portion of final and/or when evaluating the vertical guidance surface (VGS). Additionally, do not apply an accuracy adjustment to low close-in obstacles or when determining ceiling and/or visibility for departure procedures. When an altitude adjustment is required which would adversely affect the procedure minimum altitudes, evaluate the nature, magnitude, and rationale for the adjustment; and then review records to identify an existing source validating a higher level of accuracy that could preclude the need for adjustment. Where the review fails to produce an improved accuracy source, notify the appropriate Airports division for assistance relative to existing obstructions; or notify the appropriate Air Traffic Organization office when the review involves a proposed structure or modification to an existing structure being studied in the OE program. Aeronautical Information Services need not delay further processing of affected procedures pending receipt of higher-level accuracy data except *only* where operationally prudent. Horizontal and vertical accuracy adjustments must not be applied to restricted airspace containing tethered balloons.

a. Manual. When manually developing the procedure, identify all controlling obstacles on the applicable FAA Form in coordinates to the second, and assign the highest order of accuracy known for the data source [see paragraph 8-7-1].

b. Automation. When using automation to develop the procedure, apply the accuracy standards as follows:

(1) Obstacle accuracy standards must be applied when determining the altitude(s) to be charted. Additionally, apply the accuracy standard in the evaluation of a proposed obstruction and in the development/revision of any affected procedures.

(2) If segment altitude adjustments are made to meet the requirements of the minimum accuracy standards, state the reason for the adjustment on the applicable menu.

(3) Non-RNP (AR) procedure evaluation sequence. In either paragraph 2-11-5.b or 2-11-5.c, first determine the controlling obstacle(s) *using raw obstacle data only* (i.e., accuracy adjustments not applied), then apply horizontal/vertical accuracy adjustments to the raw values. [see Order 8260.58, United States Standard for Performance Based Navigation (PBN) Instrument Procedure Design, chapter 3, for LNAV/VNAV final]. The adjustment(s) must be applied in the most critical direction; e.g., applied in the horizontal and/or vertical direction which most adversely



affects the procedure. Take no further action if the controlling obstacle elevation plus accuracy adjustment does not affect a SIAP minimum altitude or gradient. If the controlling obstacle elevation plus accuracy adjustments affects a minimum altitude or gradient, and a higher order of accuracy could reduce an adverse operational effect, then take action to have the accuracy improved; or adjust the procedure accordingly.

**Note:** The most critical horizontal direction applicable to a departure or missed approach sloping segment is the direction that would result in the highest climb gradient. Normally this will be the location with the shortest distance to the OCS origin. If a climb gradient termination altitude is applicable, calculate using the same location as was used for calculating the climb gradient, that is, do not adjust in one direction for determining the climb gradient and adjust in another direction for determining a climb gradient termination altitude.

c. RNP (AR) procedure evaluation sequence. Except for those excluded obstacles (see paragraph 2-11-4), apply horizontal and vertical accuracy adjustments to obstacles in any segment/leg based on RNP AR APCH. See Order 8260.58, chapter 4.

d. Multiple controlling obstacles (non-RNP AR departure/missed approach). In those cases where there are multiple controlling obstacles and after applying accuracy adjustments (where required), the controlling obstacle for the climb gradient termination altitude (CGTA) requires a higher climb gradient than that of the climb gradient (CG) controlling obstacle, then the CGTA obstacle becomes the controlling obstacle for both CG & CGTA. In all cases, the highest published CG and CGTA will include adjustments, if applicable.

**2-11-5. Controlling obstacles.** Pursuant to the provisions of 14 CFR part 77.9, an Adverse Assumption Obstacle (AAO) of 200 feet AGL is assumed to exist at and beyond a specified distance (radius) from the nearest landing surface at a given airport/helipad [see figure 2-11-1]. As applied to runways, the specified distance is dependent upon runway length [see paragraph 2-11-5.a(2)]. Additionally, where airports/helipads underlie the OEA(s) of a given IFP resulting in multiple AAO exempt areas, do not apply an AAO within any exempt area. Use the following process to determine the controlling obstacle within a given procedure segment:

**Figure 2-11-1. AAO Example**

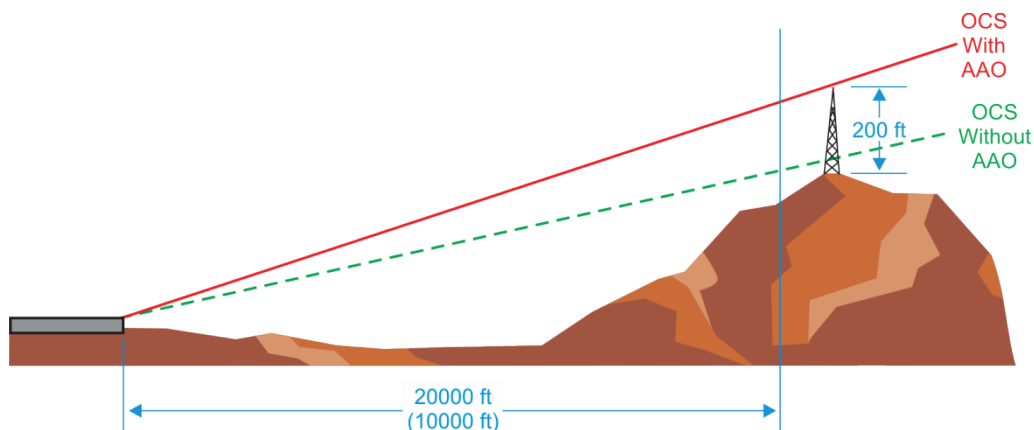

a. For each airport/helipad, establish the AAO exempt area within which 200 feet AAO is not to be considered.

(1) Scribe an arc of specified radius [see figure 2-11-2] centered on the geographical end of each runway or helipad center. As applied to runways, enclose the area by connecting a line tangent to each adjacent arc, identical to the method used to construct a TERPS circling area. The enclosed area is considered the AAO exempt area, and is not subject to 200 feet AAO consideration.

(2) AAO exempt area radius:

(a) No runway longer than 3200 feet: 10000 feet radius from all runway ends.

**Figure 2-11-2. AAO Exempt Area, Runway Length  $\leq$  3200 feet**

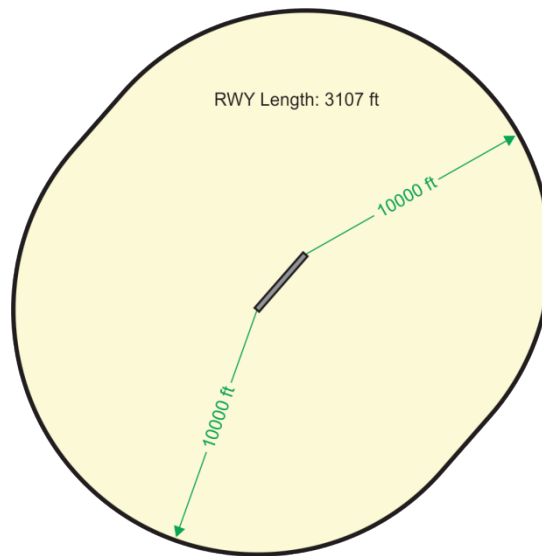

(b) One runway longer than 3200 feet: 20000 feet radius from all runway ends [see figure 2-11-3].

**Figure 2-11-3. AAO Exempt Area, Runway Length > 3200 feet**

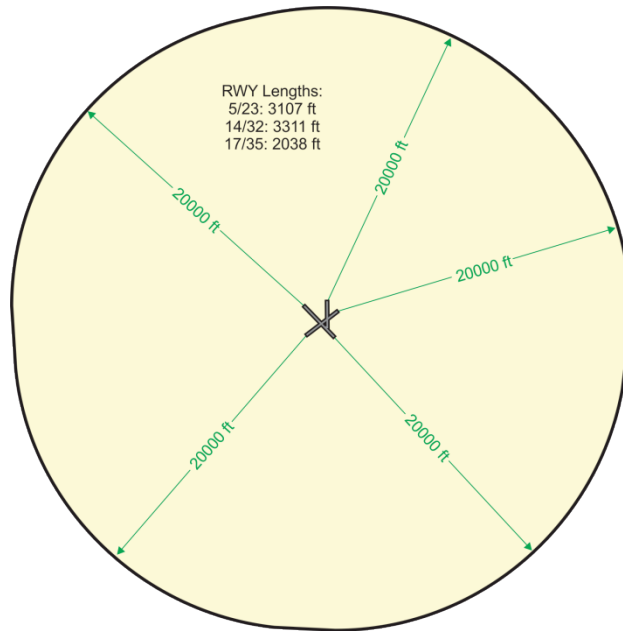

(c) Helipad: For heliports with one helipad, use radius of 5000 feet from the center of the helipad [see figure 2-11-4]. When multiple helipads exist, use the center of each helipad, and then join the extremities of the adjacent arcs with lines drawn tangent to the arcs.

**Figure 2-11-4. AAO Exempt Area, Helipad**

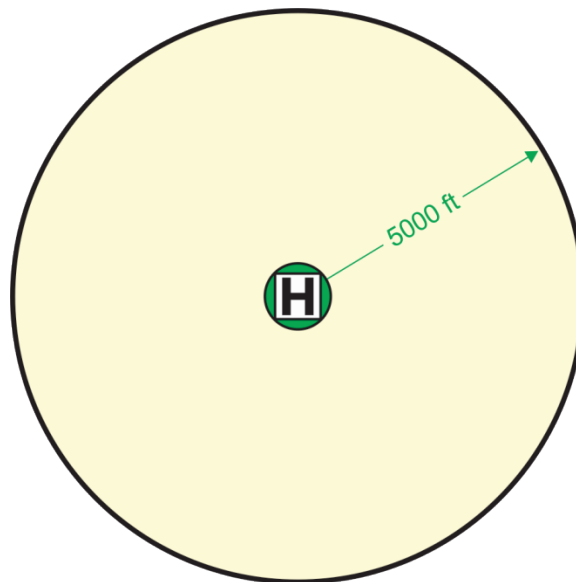

(d) Helicopter (copter) point-in-space (PinS). For the copter PinS “Proceed VFR Transition Area,” this is an AAO exempt area; however, vegetation must be considered and added to the terrain value, as appropriate.

**b.** Level surface evaluations. For all segments except precision (PA) and APV final segments, and missed approach and departure 40:1 evaluations, determine the controlling obstacle as follows [see Order 8260.58 chapter 3 for LNAV/VNAV final]:

(1) Identify the highest (MSL) database obstacle within the primary area (or secondary equivalent).

**Note:** As applied throughout paragraph 2-11-5, “database” is defined as all obstacle data obtained from all available sources; e.g., ORS, DTED, DEM data, etc.

(2) Segment portions overlying the AAO exempt area [see figure 2-11-5]:

(a) Identify the highest terrain within the primary area (or secondary area equivalent) and add worst-case vegetation height.

**Exception:** For runways supported by AC 150/5300-18, General Guidance and Specification for Submission of Aeronautical Surveys to NGS: Field Data Collections and Geographic Information System (GIS) Standards, use the database; however, terrain database information, such as DTED, DEM, etc., may be inhibited for evaluation of obstacles located within the confines of the vertically-guided approach surface (VGAS) area specified in the survey. Outside the VGAS area, use the database and worst-case vegetation.

**Figure 2-11-5. Controlling Obstacle Identification**

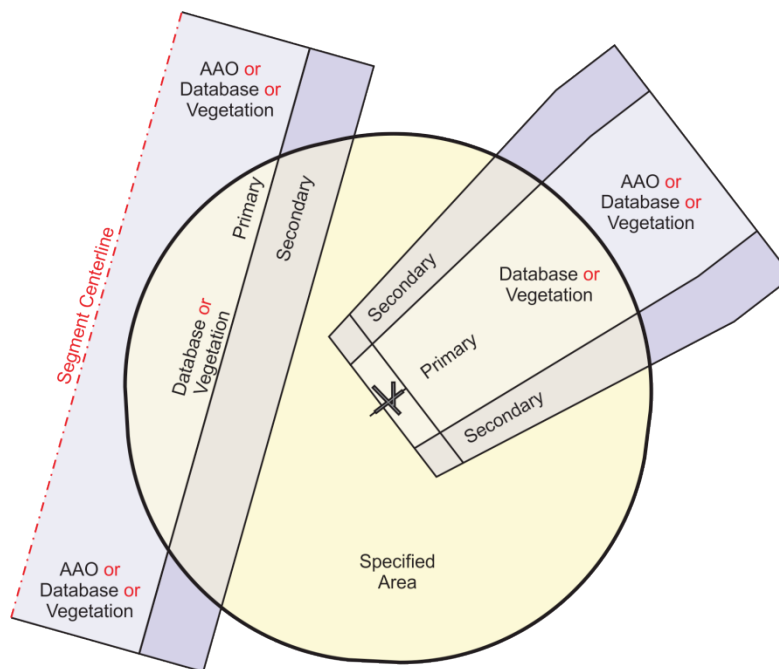

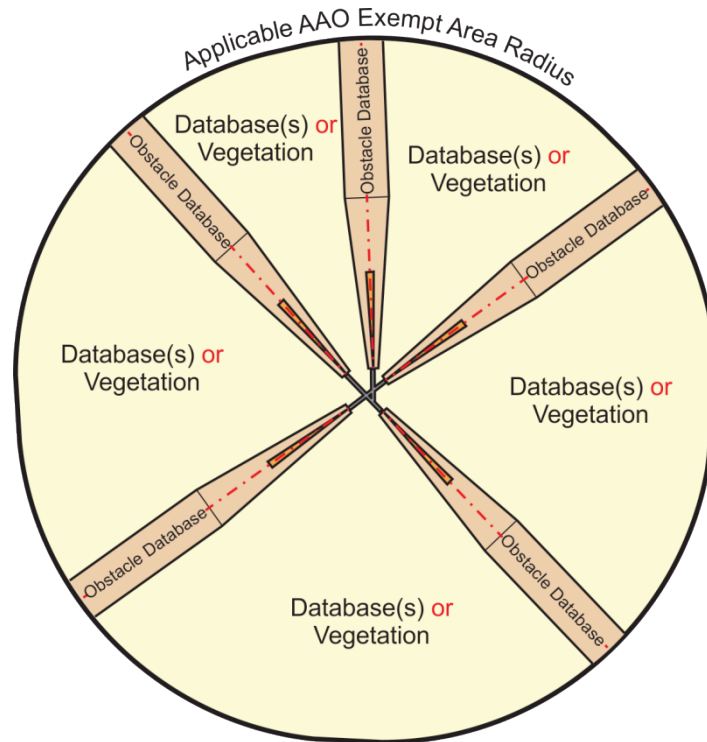
**Figure 2-11-6. Controlling Obstacle Identification with AC 150/5300-18 Survey Areas**

(3) Segment portions not overlying the AAO exempt area:

(a) Identify the highest terrain within the primary area (or secondary area equivalent) and add 200 feet (or worst-case vegetation height if higher).

**Note:** When using U.S. Geological Survey (USGS) 7 ½ minute (and 15 minute) quadrangle series topographical maps and adding an AAO to terrain (excluding vegetation additives) is necessary, the practice of adding the next higher contour line minus one unit of elevation (e.g., 20-foot contour minus one foot equals a 19-foot addition to the lower contour value, etc.) *is not* required.

(4) The controlling obstacle is the highest of the obstacles identified under paragraph 2-11-5.b(1) thru 2-11-5.b (3).

**c.** Sloping surface evaluations. For PA and APV final segments, and missed approach and departure 40:1 evaluations, determine the controlling obstacle as follows [see Order 8260.58 chapter 3 for LNAV/VNAV final]:

(1) Segment portions overlying the AAO exempt area:

(a) Use the obstacle database and worst-case vegetation height to determine the controlling obstacle.

(b) Exception: For runways supported by Advisory Circular 150/5300-18, use the database; however, terrain database information, such as DTED, DEM, etc., may be inhibited for

evaluation of obstacles located within the confines of the VGAS area specified in the survey. Outside the VGAS area, use the database and worst-case vegetation.

(2) Segment portions not over-lying the AAO exempt area use the obstacle and terrain databases and 200 feet AAO (or worst-case vegetation if higher) to determine the controlling obstacle.

(3) Determine the controlling obstacle as follows:

(a) For PA and APV final segments, the controlling obstacle is that obstacle which, having penetrated the obstacle clearance surface requires the highest glidepath angle (GPA) above three degrees and/or causes, the most adverse decision altitude (DA).

(b) For missed approach segments, the controlling obstacle is that obstacle which, having penetrated the 40:1 obstacle clearance surface (OCS) causes one of the following:

1. Highest DA/minimum descent altitude (MDA);
2. Most adverse MAP relocation;
3. Highest climb gradient and climb gradient termination altitude (may be different obstacles).

(c) For departure areas, the controlling obstacle is that obstacle (or obstacles) that penetrate the 40:1 OCS which require:

1. The highest climb gradient and climb gradient termination altitude (may be different obstacles); and if applicable.
2. The most adverse ceiling and visibility to be published (may be different obstacles).

**d.** A VCOA requires an assessment of both a level and sloping surface to determine the controlling obstacle. The controlling obstacle is one which determines the “climb-to” altitude (see Order 8260.3) and is located either within the visual climb area (VCA) or is the obstacle outside the VCA that is creating the need to raise the 40:1 surface.

**e.** When an existing procedure is affected by new application of the AAO standard, see paragraph 2-8-2.

**2-11-6. Datums.** Use the following guidance relating to geodetic datums:

**a.** The FAA’s vertical obstruction file and airport surveys are populated with NAD-83 latitude and longitude values and elevations based on the NAVD-88 datum. These values are used in TERPS evaluation.

**b.** Satellite based instrument procedures should be designed and evaluated using data based on the WGS-84 datum. When developing Wide Area Augmentation System (WAAS)/Ground

Based Augmentation System (GBAS) instrument procedures, the value of the landing threshold point (LTP) height above the ellipsoid (HAE) is provided in the FAA's database. These values may be referenced to the NAD-83 or WGS-84 ellipsoids. For Localizer Performance with Vertical guidance (LPV) and GBAS Landing System (GLS) procedures use WGS-84 height above ellipsoid (ellipsoidal height) values if available. Where WGS-84 ellipsoidal values are not available, use the NAD 83 value. NAD-83/NAVD-88 data may be considered equivalent to WGS-84 where the vertical path resulting from its use falls within the TCH tolerance of  $\pm 3$  feet. For LPV and GLS procedures only, document with the FAS data block information the datum on which the LTP/FTP latitude and longitude and ellipsoidal height values are based.

**Examples:**

LTP/FTP LATITUDE (WGS-84)	332731.8700N
LTP/FTP LONGITUDE (WGS-84)	0935931.8200W
LTP/FTP ELLIPSOIDAL HEIGHT (WGS-84)	+00834
	or
LTP/FTP LATITUDE (NAD 83)	332731.8710N
LTP/FTP LONGITUDE (NAD 83)	0935931.8190W
LTP/FTP ELLIPSOIDAL HEIGHT (NAD 83)	+00836
	or
LTP/FTP LATITUDE (NAD 83)	332731.8710N
LTP/FTP LONGITUDE (NAD 83)	0935931.8190W
LTP/FTP ELLIPSOIDAL HEIGHT (WGS-84)	+00834

The LTP/FTP HAE and its reference datum must be reported on Form 8260-3/7A, for procedures developed in the CONUS [see paragraph 8-6-10.j(4)].

## Section 2-12. Waiver of Standards/Approval Requests

**2-12-1. General.** The waiver request is used to officially document the nonstandard application of criteria, and serves as a means to identify criteria that may require further refinement or to identify problem areas. Those items identified in 8260-series orders that require approval by Flight Standards Service (e.g., GP angle above 3.00 degrees, climb gradient in excess of 500 ft/NM, etc.) are not to be interpreted as a requirement for a waiver and do not require completion of a Form 8260-1, Flight Procedures Standards Waiver. Additionally, on request, the Flight Procedure Implementation and Oversight Branch may permit a deviation from a policy standard for situations where a waiver would not be practicable (e.g., an equivalent level of safety is not warranted) on a case-by-case basis and can be authorized through the approval process. Approval requests of these types must be made in plain text by memorandum and submitted to the Flight Procedure Implementation and Oversight Branch for approval. All documentation and supporting data must accompany the approval request so reviewing offices (i.e., Procedure Review Board) can conduct an evaluation without additional research. Submit appropriate 8260-series forms with each request to include charts depicting the procedure and all items that are the subject of the approval request. Instrument procedures must not be submitted for publication until waiver approval and/or approval request action has been completed.

**2-12-2. Waiver processing.** Request waivers by completing the front of Form 8260-1. Enter only one waiver request on the waiver form. Detailed instructions for completing the form are contained in section 8-4. Figure 8-4-1 provides an easy reference for waiver form processing and routing requirements.

**a.** Submit a request for a waiver on a Form 8260-1. Each waiver request will be considered *only* when there is no other suitable way to resolve a procedural problem, or to provide a required service.

**b.** Complete documentation and supporting data must accompany the waiver request so reviewing offices can conduct an evaluation without additional research. Submit appropriate 8260-series forms with each request. Include charts depicting the procedure and/or obstacles that are the subject of the waiver.

**c.** When a procedure is amended, reprocessing of an existing waiver is not necessary unless the reason for the amendment directly affects the basis for the waiver.

**d.** Forward the original Form 8260-1 and supporting data for approval to the Flight Procedure Implementation and Oversight Branch. For U.S. Army procedures, forward waiver requests for approval to the United States Army Aeronautical Services Agency (USAASA) or United States Army Aeronautical Services Detachment-Europe (USAASDE). Use the automated version of the Form 8260-1 for U.S. Army waiver processing.

**e.** The Flight Procedure Implementation and Oversight Branch processes all waiver requests and schedules a PRB to gain consensus on approval/disapproval. If the PRB recommends approval, then the Flight Procedure Implementation and Oversight Branch will endorse the Form 8260-1. When necessary, the Flight Procedure Implementation and Oversight Branch will annotate the Form 8260-1 that approval is contingent upon a successful flight inspection report.



f. Aeronautical Information Services is responsible for ensuring that an approved waiver of standards is on file for each instrument procedure requiring waiver action. Flight Standards waiver approval must be obtained before submitting the procedure for publication.

**2-12-3. Waivers for Special Instrument Approach Procedures.** Except for proponent-developed procedures, when a waiver is approved for a special instrument approach procedure, Flight Standards must coordinate with the appropriate FSDO concerning any special conditions that may be imposed on the use of a special authorization. This action is necessary to establish required supervision to ensure user compliance with equivalent level of safety provisions. For example, special aircrew training may be required as an equivalent level of safety.

**2-12-4. Safety Management System (SMS) requirements.**

a. The FAA's SMS policy (i.e., Order 8040.4 and Order 8000.369) must be adhered to, and safety risk management (SRM) procedures, documentation requirements and monitoring activities in that policy must be followed to ensure that all SMS requirements are met. A SRM process ensures that:

- (1) Safety-related changes are documented.
- (2) Risk is assessed and analyzed.
- (3) Unacceptable risk is mitigated.
- (4) The effectiveness of the risk mitigation strategies is assessed through a hazard tracking/monitoring plan.

b. All relevant factors are considered when conducting a safety risk assessment, including:

- (1) Navigation capabilities and navigation performance.
- (2) Suitable weather reporting facilities.
- (3) Operator certification and training.
- (4) Systems and/or subsystems intended function and flight or ground environment in which the system is to perform that function.
- (5) Traffic density and distribution.
- (6) Airspace complexity, route structure, and classification of the airspace.
- (7) Airport layout, including runway configurations, runway lengths, and taxiways.
- (8) Types of aircraft and their performance characteristics, including aircraft configurations.
- (9) Human factors issues.

**2-12-5. Periodic review of waivers.** Aeronautical Information Services must review approved waivers at the time of the periodic review [see paragraphs 2-8-1 and 2-8-2] to determine whether the waivers are still required. Cancel unnecessary waivers.

**2-12-6. Cancellation.**

**a.** Cancellation of waivers must include a reason in the comments block. Such termination may be directed by the Flight Procedure Implementation and Oversight Branch. Aeronautical Information Services is responsible for planning ways to eliminate waivers through the modification, addition, or relocation of navigation facilities.

**b.** Distribution of a canceled waiver must be made to the same organizations that received the approved waiver [see paragraph 8-4-1].

**c.** An approval granted by the Flight Procedure Implementation and Oversight Branch [see paragraph 2-12-1] does not require cancellation. Approvals are valid for future amendments, provided no conditions have changed, and are self-cancelling when the procedure is canceled.

## Chapter 3. Route Procedures

### Section 3-1. General

#### 3-1-1. General.

**a.** The en route airspace structure of the NAS consists of three strata. The first, or lower, stratum consists of conventional navigation (Victor) and area navigation [RNAV] (Tango) ATS routes that extend from the floor of controlled airspace up to but not including 18000 feet mean sea level (MSL). The second stratum contains conventional navigation (Jet) and RNAV (“Q”) ATS routes and extends from 18000 feet MSL up to and including flight level (FL) 450. The third stratum allows random operations above FL 450. Federal airways, jet routes, and RNAV routes are designated by rulemaking action under 14 CFR part 71.

**b.** The standards in Order 8260.3, chapter 15 are used to develop conventional (i.e., non-RNAV) airway and off-airway routes in the lower stratum, and for designated and non-designated jet routes in the second stratum. Order 8260.58, chapter 2 is used to develop RNAV routes (i.e., Q and T routes). These criteria establishes obstacle clearance limit standards applicable to the segments of each airway or route, and to the turning areas required to transition from one airway or route to another. Consideration is also given to communications requirements and to the use of radar to fill navigation “gaps.” In areas outside the continental U.S. that do not have the airway structure divided as above, the criteria apply to the corresponding altitude levels in the development of en route procedures.

#### 3-1-2. Publication.

**a.** En route minimum altitudes. MEA, MRA, MAA, MOCA, MCA, and COP are established by the FAA for instrument flight along Federal airways in 14 CFR part 95. They may be established for off-airway routes within the U.S. and its territories. The altitudes are established after it has been determined that the navigation aids to be used are adequate and so oriented on the airways or routes that signal coverage is acceptable, and that flight can be maintained within prescribed route widths.

**b.** Altitudes and changeover points are published regularly in the Federal Register as 14 CFR part 95. The master lists of 14 CFR part 95, COPs, direct routes, intersections, holding patterns, and off-airway routes (non-part 95) are maintained by NFDC.

## Section 3-2. Criteria Application and Development

**3-2-1. Criteria application.** The criteria contained in Order 8260.3, chapter 15, have been developed primarily for application to the very high frequency (VHF) navigation system. When en route flight procedures using the low frequency (LF) or integrated (VHF-LF) navigation are required, standards have been included in the appropriate sections for application to the use of these systems during the remaining life of the LF system. However, since the navigation system is based upon the VORTAC, the use of LF navigation facilities will be considered a system deficiency and must be limited to those cases where no other course of action is possible and where a definite operational requirement can be justified.

**3-2-2. Development of criteria.** To assist in understanding the criteria, the methods used in its development are being included. An en route segment involving flight between two points is a flight procedure. As such, it must be provided with characteristics that result in safety and practicality in all aspects. Safety and practicality in a flight procedure are dependent upon the pilot, the aircraft, and the navigation system being used. The operational characteristics of all three were evaluated collectively, and the results of the evaluation applied to the operating environment. In the development of en route criteria, the total problem was broken into two parts: first, the pilot/aircraft combination; and second, the navigation system. Data considered essential in these areas were assembled and combined to find a total system accuracy factor.

**a. Pilot/Aircraft.** Most of the work in this area was done in the Aeronautical Center flight simulator, but some tracking data were obtained from actual flight. Two types of information were required: pilot habits in tracking the specified course, bearing, and/or radial and the flight track resulting from turns at various speeds and altitudes under various wind conditions. The more critical turn tracks were lifted from simulator tracings and incorporated in the criteria for direct application through the use of turning area templates.

**b. Navigation system.** Quantitative values were developed to determine the probable aircraft displacement resulting from the combination of navigation facility radial alignment displacement, transmitter monitor tolerance, receiver accuracy, and finally, the previously determined pilot/aircraft tracking accuracy. These factors were processed using the Gaussian (normal) curve, and probability factors determined.

**c. Probability.** System accuracy resulting from these computations is at 95 percent probability, a system accuracy of plus-or-minus 4.5 degrees, and a 99 percent probability for a system accuracy of plus-or-minus 6.7 degrees (for VOR/VORTAC facility signals). The 4.5-degree figure became the basis for primary area obstacle clearance criteria, airway and route widths, and the ATC separation procedures. The 6.7-degree value provides secondary obstacle clearance area dimensions.

### Section 3-3. Establishment of En Route Airspace

**3-3-1. Relationship of COPs to airspace dimensions.** Application of these criteria considers the location of the COP for determining the dimensions of the required associated airspace. When it is anticipated that the COP will be established beyond 51 NM from the facility, the location of the COP should be determined by Aeronautical Information Services during the development of airspace proposals within the Air Traffic Service Area. On new facilities, a reasonably accurate estimate of the COP should be obtained during the site survey. Other data, such as MEA, MOCA, MRA, etc., should also be obtained at this time. This information will assure the completion of necessary airspace planning in the Air Traffic Service Area, and will permit the description of all required airspace in the notice of proposed rulemaking (NPRM).

**3-3-2. Relationship of MEAs to controlled airspace floors.**

**a. Buffers.** MEAs for routes wholly within controlled airspace will normally provide for a buffer above the floor of controlled airspace. This buffer will be at least 300 feet within class E airspace containing terminal instrument procedure segments (feeder, initial, intermediate, final, missed approach) and 500 feet within the low altitude airway structure. However, exceptions may be made which provide only 300-foot buffer below these airways where the lesser buffer area will permit retaining a cardinal altitude or otherwise result in a definite operational advantage. Establish these buffers to the nearest 100-foot increments: e.g., 1049.99 feet becomes 1000 feet and 1050.00 feet becomes 1100 feet. Refer to Order JO 7400.2, Procedures for Handling Airspace Matters (latest edition).

**b. Rounding.** Where rounding off MEAs to the nearest 100 feet results in a vertical separation between the floor of controlled airspace and the MEA of not less than 451/251 feet, consider such separation as being in practical compliance with that of 500/300 feet specified in applicable criteria.

**Note:** The above rounding process is for airspace application only and must not create a situation where less than the required obstacle clearance is afforded.

## Section 3-4. Substitute En Route Flight Procedures

### 3-4-1. General.

a. Air Route Traffic Control Centers (ARTCCs) are responsible for specifying essential substitute airway or route segments (sub-routes) and fixes for use during scheduled or unscheduled VOR/VORTAC shutdowns.

b. Aeronautical Information Services, in coordination with ARTCCs, determines when the length of outages or other factors require publication of sub-routes.

c. Flight Program Operations provides flight inspection services, obstacle clearance verification, certification, and final approval of substitute routes.

**3-4-2. Format.** ARTCCs can use a format similar to that shown in figure 3-4-4 in preparing substitute routes for scheduled or unscheduled facility shutdowns, and for submission of the sub-route to Aeronautical Information Services for approval. Substitute routes must be described from navigational fix to navigational fix, to accurately define the route to be used. An MEA and an MAA must be provided for each route segment. Temporary reporting points should be substituted for the out-of-service facility and only those other reporting points that are designated as essential by the Air Traffic Organization. Normally, temporary reporting points over intersections will not be necessary where center radar coverage exists. An MRA must be established for each temporary reporting point. Where a substitute route cannot be developed for an existing route or reporting point, indicate none under the substitute column.

**3-4-3. Facilities used.** Substitute routes should normally be based on VOR/VORTAC aids established and published for use in the altitude strata concerned. However, in the case of substitute routes in the upper airspace stratum, it may be necessary to establish routes by reference to VOR/VORTAC facilities utilized in the low altitude system. NDB facilities may only be utilized where VOR/VORTAC coverage is inadequate and ATC requirements necessitate use of such aids. Where operational necessity dictates, process an ESV request [see paragraph 2-4-2]. Temporary reporting points may be established in connection with the substitute routes and, where possible, a temporary reporting point will be established over the facility being shutdown.

**3-4-4. Controlled airspace.** Substitute routes may be approved as long as the centerline of the route is contained within controlled airspace. Designation of additional controlled airspace to contain substitute routes need not be accomplished because of the temporary nature of the routes. Substitute routes for off-airway (non-14 CFR part 95) routes need not be in controlled airspace [see figure 3-4-1 and figure 3-4-2].

**3-4-5. Flight Inspection.** Substitute routes are flight inspected in accordance with Order 8200.1. If substitute routes do not overlie existing routes, or are wider than existing routes [see figure 3-4-3], map studies are required to identify controlling obstacles. Aeronautical Information Services must document controlling obstacles on Form 8260-16, Transmittal of Airways/Route Data Record. Retain these forms locally for future review. Flight inspection verifies controlling obstacles.

**3-4-6. Planning and coordination.** The Air Traffic Technical Operations Service Areas will provide the dates of proposed scheduled shutdowns to Aeronautical Information Services, who must maintain a schedule of shutdowns and the estimated duration of the outages. Aeronautical Information Services must act on this information as far in advance as possible to enable timely submission of the sub-routes to NFDC for publication. Aeronautical Information Services should be prepared for the eventuality when publication of sub-routes is not related to scheduled outage.

**Figure 3-4-1. FAR 14 CFR part 95 Sub-Route**

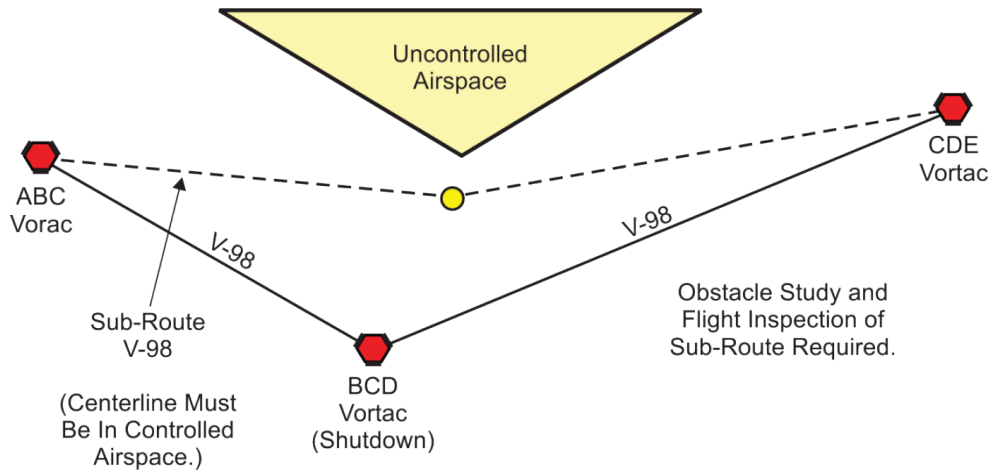

**Figure 3-4-2. Non-14 CFR part 95 Sub-Route**

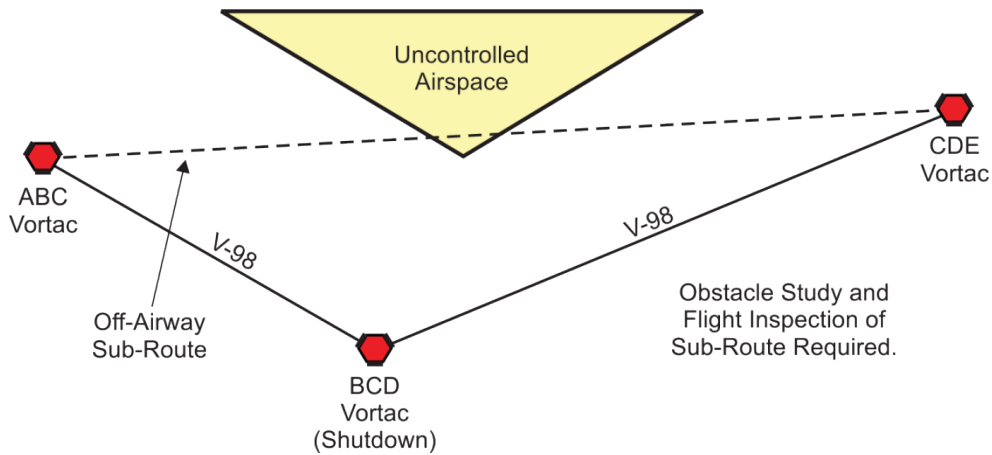
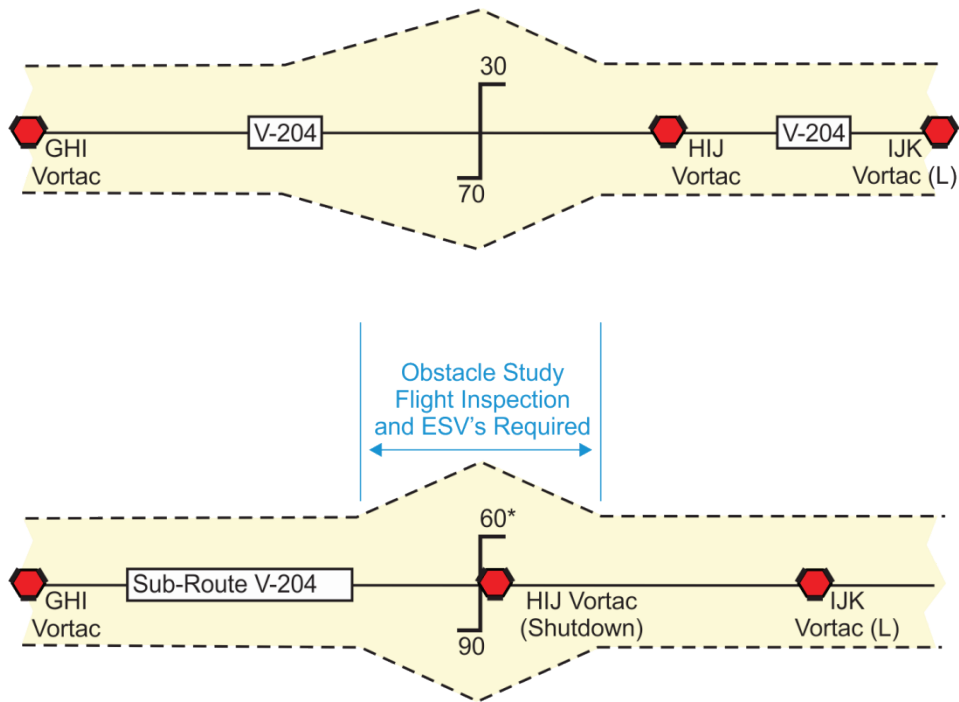

Figure 3-4-3. Sub-Route Wider than Existing Route



\*COP's are normally established over the shutdown facility; however, they may be established at any point for operational reasons: terrain, facility restriction, MRA, airspace, etc., providing flight inspection requirements are met.



**Figure 3-4-4. Substitute Route Structure**

Snowflake, CO, VORTAC shutdown, scheduled or unscheduled. For substitute routes, MEAs, and Reporting Points, use the following:

<b>LOW ALTITUDE</b>			
	<b>Existing Airways</b>	<b>Substitute Routes</b>	<b>MEA/MAA</b>
V220	SKI VORTAC to SNO VORTAC	SKI VORTAC to Temp SNO Int via SKI R-340	10000/17500
V220	SNO VORTAC to MTN VORTAC	Temp SNO Int to MTN VORTAC via MTN R-152	11000/17500
Direct	SNO VORTAC to ASPEN Int	None	
Off-Airway	SNO VORTAC to VAL VOR	Temp SNO Int to VAL VOR via SBT R-259 to SBT, SBT R-040 & VAL R-220	15000/37000
	<b>Existing Reporting Point</b>	<b>Temporary Reporting Point</b>	<b>MRA</b>
	SNO VORTAC	Temp SNO Int: SKI R-340/82 & SBT R-259/85	10000
	RUTHY	SKI R-340/43	8500
	SARDY	Temp SARDY Int: MTN R-152/80 & SBT R-270	11000
	SILVR	None	
<b>HIGH ALTITUDE</b>			
	<b>Existing Routes</b>	<b>Substitute Routes</b>	<b>MEA/MAA</b>
J233	BRR VORTAC to SNO VORTAC	BRR VORTAC to Temp SNO DME via BRR R-314	20000/45000
J233	SNO VORTAC to FUN VORTAC	Temp SNO DME to FUN VORTAC via FUN R-148	20000/45000
	<b>Existing Reporting Point</b>	<b>Temporary Reporting Point</b>	<b>MRA</b>
	SNO VORTAC	Temp SNO DME: BRR R-314/159 & FUN R-148/133	20000
	HILAN	BRR R-314/82	18000

Approved: \_\_\_\_\_, Date \_\_\_\_\_  
 (Name), Manager  
 Aeronautical Information Services, AJV-XX

**3-4-7. Processing.**

**a.** Lead time. Process data concerning substitute routes sufficiently in advance of the effective date of the facility shutdown to assure publication when charting is required. To provide necessary lead time, the substitute routes must be forwarded to NFDC nine weeks prior to the chart's effective date. If the lead time cannot be provided, delay the shutdown or consider printing a special graphic NOTAM. Normally, shutdown of facilities scheduled for 28 days (half the life of the en route chart) or less will not be charted; however, traffic considerations at major terminals may make charting necessary for the short-term shutdowns.

**b.** Submissions.

(1) ARTCC submitted substitute routes [see figure 3-4-4] require the signature of the Aeronautical Information Services manager, or a delegated representative. This signature thereby indicates operational approval of these sub-routes for unscheduled use. This approval must be submitted directly to the ARTCC concerned [see paragraph 3-4-9.b].

(2) When Aeronautical Information Services determines that publication is required for a scheduled or extended unscheduled outage, Aeronautical Information Services forwards the ARTCC submitted substitute routes to NFDC for publication [see paragraph 3-4-9.a].

**3-4-8. Periodic review.**

**a.** The ARTCC must review substitute en route flight procedures at least once every four years and any time that changes occur in the airway structure. The ARTCC must submit any required modifications to Aeronautical Information Services for certification and approval.

**b.** Aeronautical Information Services.

(1) Notify the responsible ARTCC and withdraw approval when:

(a) Frequency protection can no longer be provided to support the sub-route procedure.

(b) Flight inspection data is not available to support continued certification and approval of the sub-route procedure.

(2) Review existing and proposed sub-routes for required obstacle clearance at least once every four years.

(3) Notify the ARTCC of any amendments necessary.

**3-4-9. Distribution.**

**a.** For publication. List the shutdown dates in the cover letter.

AWO	1 copy
NFDC	2 copies
ARTCC	1 copy
Aeronautical Information Services	Original

**b. Non-publication.**

AWO	1 copy
ARTCC	1 copy
Aeronautical Information Services	Original

### Section 3-5. Off-Airway Routes

**3-5-1. Establishment.** Establish off-airway routes in the same manner, and in accordance with the same criteria, as airways and jet routes. Off-airway routes predicated on public navigation facilities and wholly contained within controlled airspace will be published as direct 14 CFR part 95 routes. Routes predicated on privately owned navigation facilities or not contained wholly within controlled airspace will be published as off-airway routes.

**a. Process.** A scheduled air carrier operator, through its Principal Operations Inspector (POI), may initiate a request for the establishment of off-airway routes. Upon receipt of a request for an off-airway route, the POI forwards the request to the AWO for review and coordination via the RAPT. If approved, the request will be sent to Aeronautical Information Services for action. The applicable Air Traffic Service Area will process the route in accordance with Order JO 7400.2 to ascertain that there is no conflict in use of the airspace. Following Air Traffic coordination and RAPT approval, Aeronautical Information Services must evaluate the adequacy of off-airway routes. Consider the following:

- (1) Type of aircraft and the navigation systems used.
- (2) Proximity to military bases, training areas, and low-level military routes.
- (3) Adequacy of communications along the route.

**b. Aeronautical Information Services documentation.** Document MEAs and related procedural data on Form 8260-16. Return a copy of the form to the FSDO indicating approval or disapproval of its request.

**3-5-2. Listing.** Pursuant to the responsibility of the Air Transportation Division for surveillance of all authorized navigation facilities and routes, a requirement exists for maintaining a current listing of off-airway routes that have been assigned to air carriers by Flight Standards operations personnel. Routes developed by the FAA are documented in the NFDD that is published by NFDC when changes occur. See exceptions in paragraphs 3-5-3 and 3-5-4 for when off-airway routes are developed by non-FAA Service Providers.

**3-5-3. Off-airway data.** When off-airway routes are developed and maintained by the FAA, Aeronautical Information Services should establish arrangements for obtaining and maintaining complete off-airway route information. The following is suggested:

**a.** FSDOs provide Aeronautical Information Services with copies of all proposed changes or cancellations to IFR off-airway route authorizations.

**b.** Aeronautical Information Services uses this information for coordination of flight inspection requirements and for maintaining current records.

**c.** Off-airway routes developed and maintained by non-FAA Service Providers are considered proprietary and will be processed through the Flight Standards Service (i.e., Flight Procedure Implementation and Oversight Branch) for approval and processing.

**3-5-4. Processing data to NFDC.** Use Form 8260-16 to forward IFR off-airway data to for processing all off-airway routes. Do not designate off-airway, non-part 95 routes as special routes even though associated with special instrument approach procedures.

**a.** Off-airway routes developed by the FAA will be submitted to NFDC to be documented in the NFDD.

**b.** Off-airway routes developed by non-FAA Service Providers will be submitted by the Flight Procedure Implementation and Oversight Branch to NFDC for information and record keeping purposes, but *will not* be documented in the NFDD nor entered into NASR.

**Note 1:** *Existing fixes* will require the Form 8260-2, Radio Fix and Holding Data Record, “Fix Use” block updated to show that the fix makes up a part of the non-Part 95 off-airway route (see paragraph 8-5-2.j).

**Note 2:** *New fixes* created in support of non-FAA Service Provider developed, non-Part 95 off-airway routes, must also be submitted to NFDC on Form 8260-2 and the information published in the NFDD to ensure they are incorporated into ATC and avionics systems databases.

### **Section 3-6. New or Revised National Airspace System Routes**

**3-6-1. Definition - Route.** For the purpose of this section, a route includes all charted en route depictions requiring 14 CFR part 71 airspace actions and/or 14 CFR part 95 procedural data application.

**3-6-2. Coordination procedures.**

**a.** The applicable Air Traffic Service Area provides Aeronautical Information Services with the NPRM for new or revised routes. Revisions to currently published routes will be handled on an individual basis. When a currently published route will be revised by a final rule without an NPRM, the applicable Air Traffic Service Area will provide the details of the change to Aeronautical Information Services to request flight inspection and to coordinate the planned effective date.

**b.** Aeronautical Information Services action. Aeronautical Information Services requests flight inspection to furnish a copy of the preliminary evaluation and forwards the results to the applicable Air Traffic Service Area. If the proposal is satisfactory, include changeover point information. If the route is not satisfactory, provide alternate recommendations.

**3-6-3. Publication of procedural data.**

**a.** Aeronautical Information Services must forward final route data, with the NPRM docket number, to NFDC on Form 8260-16. This form must be submitted within the comment period specified in the NPRM. Conditions found during surveillance inspections of established routes, which would require a change to MEA, MOCA, MAA, or COP from the previously published data, must be brought to the attention of the procedures specialist for corrective action.

**b.** The ARTCC, in conjunction with the applicable Air Traffic Service Area, is responsible for developing airspace requirements for the routes published in 14 CFR part 71; and Aeronautical Information Services is responsible for developing the related procedural data published in 14 CFR part 95.

### **Section 3-7. Minimum Vectoring Altitude (MVA) and Minimum IFR Altitude (MIA) Charts**

**3-7-1. Chart preparation.** MVA and MIA charts are developed by air traffic control facilities for areas where there are numerous minimum altitude requirements due to variable terrain features and/or manmade obstacles. The responsible ATC facility determines the area of consideration and chart design based on topography, obstruction data, and operational requirements in accordance with instructions contained in Order JO 7210.3, Facility Operations and Administration; Order JO 7210.37, En Route Minimum IFR Altitude (MIA) Sector Charts; and Order 8260.3, chapter 11. Aeronautical Information Services personnel may be requested to participate in original chart development at the option of the ATC facility.

**3-7-2. Obstacle clearance.** Required obstacle clearance and associated additives and/or reduction are as specified in Order 8260.3, chapter 11.

**3-7-3. Controlled airspace.** Controlled airspace (and associated buffers) and considerations required by Order 8260.3, chapter 11 are the responsibility of ATC facilities.

#### **3-7-4. Chart review and approval.**

##### **a. Civil vectoring charts.**

(1) ATC action. The ATC facility forwards a memorandum through the Service Area Operational Support Group, Flight Procedures Team, stating that a MVA/MIA chart package derived from the Sector Design and Analysis Tool (SDAT) has been completed. This memo includes a statement that the MVAC was developed in SDAT, the SDAT project file name, and that it is available on the SDAT repository. One Form 7210-9, Minimum IFR Altitude/Minimum Vectoring Altitude Obstruction Documentation, Vectoring Altitude Obstruction Documentation [see Order JO 7210.3, chapter 3, section 9] with the Air Traffic Manager's (ATM) signature is to be attached. Additionally, the project file must have a scanned/digital copy of Form 7210-9 with the ATM's signature imported into the SDAT project file. The ATC facility updates, as required, and/or reviews the MVA/MIA chart to ensure accuracy, and jointly approves any amendment or review with Aeronautical Information Services.

(2) Aeronautical Information Services action. Review MVA/ MIA chart submissions (including automated data submissions) to ensure that obstacle clearance and controlled airspace requirements are met. Coordinate any recommended adjustments in chart design, or necessary changes in MVAs/MIAs or controlling obstructions, with the originating ATC facility. Upon completion of a satisfactory review, approve the chart over the signature of the Aeronautical Information Services manager, or his/her designated representative, on the Form 7210-9, and return it to the ATC facility. The returned copy must be the original signed copy or a digital copy of the original with required signatures to ensure quality representation of the form.

**Note:** It is not required to maintain/file a graphic depiction of the MVA/MIA chart when completed with SDAT and stored in the SDAT repository.

**b. Military MVA charts.** The FAA has no responsibility for the technical review of military MVA charts, with the exception of U.S. Army charts, which are reviewed in accordance with the

NAT 127 Agreement and Order 8260.15. The FAA may honor other military requests on a time-available basis in accordance with guidelines contained in chapter 6.

**3-7-5. Emergency Obstruction Video Map (EOVM).**

**a.** Establishment. An EOVM is established by ATC at all terminal radar facilities that have radar coverage in designated mountainous areas, and is intended to facilitate advisory service to aircraft in an emergency situation wherein appropriate terrain/obstacle clearance minimum altitude cannot be maintained. Order JO 7210.3 specifies EOVM design, preparation, production, and verification requirements.

**b.** Aeronautical Information Services review. Limit review of EOVMs provided by the AT facilities to ensure the minimum design features are included. Verify contour elevations, mountain peaks, and other obstructions that are selected and depicted on a sectional chart. Ensure a 200-foot additive has been included in all terrain values to assure clearance over natural vegetation and AAOs.



## Chapter 4. Terminal Procedures

### Section 4-1. General

**4-1-1. General.** The FAA has the responsibility to establish instrument procedures used for terminal operations at civil airports within the U.S. and its possessions. The FAA also provides or approves instrument procedures used by U.S. flag carriers at foreign airports.

**4-1-2. Categories of Instrument Approach Procedures.** Procedures published in the Federal Register under 14 CFR part 97 are identified as “standard instrument approach procedures.” These procedures are available to all users. Instrument flight procedures authorized for use only by air carriers or some other segment of the aviation industry are not published in the Federal Register and are identified as “Special procedures.” Special procedures may be developed for public and private use based on aircraft performance, aircraft equipment, or crew training, and may also require the use of landing aids, communications, or weather services not available for public use [see paragraph 8-2-1.b].

#### **4-1-3. Airspace requirements.**

**a.** Public-use procedures and Special procedures at part 139 airports must be contained within controlled airspace to the maximum extent possible as specified in Order JO 7400.2.

**b.** Where an airport does not qualify for a class B/C/D/E surface area, designate 700-foot class E airspace. In the latter case, landing minimums may be established below the floor of controlled airspace [see Order JO 7400.2].

**c.** Designate 1200-foot class E airspace as necessary to transition aircraft to/from the terminal or en route environment to the instrument flight procedure. This includes all arrival terminal routes and departure transitions [see Order JO 7400.2].

**d.** Requirements for minor adjustment to existing controlled (class B/C/D/E) airspace, to fully encompass an instrument procedure, will not form the basis for withholding procedure publication provided no less than the basic required 700-foot/1200-foot class E airspace is in place. An approach procedure may be published prior to obtaining the optimum configuration of controlled airspace when the following conditions exist [see Order 8260.26, Establishing Submission Cutoff Dates for Civil Instrument Flight Procedures]:

- (1) The centerline of all terminal routes is located within existing controlled airspace.
- (2) The course reversal (procedure turn, hold-in-lieu of procedure turn, or teardrop) maneuvering area out to the appropriate distance specified in chapter 5 is contained within existing controlled airspace.
- (3) The final approach fix is contained within existing controlled airspace.

**e.** Special procedures other than those noted in paragraph 4-1-3.a, should, where possible, be contained within controlled airspace in accordance with Order JO 7400.2. Special procedures may be established and approved outside of controlled airspace where it is not possible to

designate controlled airspace. In such cases, annotate the procedure: “Procedure not contained within controlled airspace,” and advise the appropriate FSDO that controlled airspace will not be provided. Do *not* use special procedures as a temporary measure pending designation of controlled airspace for public use procedures.

**4-1-4. Contractual use of private facilities.** An air operator may arrange for the use of a privately owned NAVAID. The arrangement requires a contractual agreement between the sponsor and the user regarding facility use. Flight Standards must coordinate all requests for contractual use of private NAVAIDs with the sponsor. Approval of special instrument procedures for an operator is contingent upon the AWO receiving a copy of an acceptable contractual agreement. See paragraph 7-7-1 for processes related to non-Federal NAVAIDs.

**4-1-5. TERPS application.** Develop all instrument approach procedures, except foreign procedures developed in accordance with Order 8260.31 under the provisions of Order 8260.3, associated 8260-series orders, and the guidelines in this document. The following special provisions and guidelines apply to selected paragraphs of Order 8260.3 criteria. *The paragraph numbers refer to identically numbered paragraphs in Order 8260.3.*

**a.** Order 8260.3, paragraph 1-6-1, General. Military operators have stated a requirement for TACAN instrument approach capability to a limited number of airports. These airports have a prescribed VOR procedure, based on a VOR collocated with tactical area navigational (VORTAC) facility, where TACAN-equipped aircraft are expected to operate will be identified by the military. TACAN-equipped aircraft may execute VOR procedures at these locations when the procedure is identified as “VOR or TACAN.” This informs both the pilot and the controller that an approach may be executed with aircraft equipped with only VOR or with only TACAN. Approval for the use of individual VOR procedures by TACAN-equipped aircraft is subject to review for compliance with Order 8260.3 and flight-check criteria. Take the following actions to implement this program:

(1) Designate VOR/DME procedures, predicated upon the use of VORTAC, as “VOR or TACAN” provided flight inspection has determined that the TACAN and VOR components will support the procedure. These procedures require DME. Establish the missed approach clearance limit at a radial/DME fix in lieu of the VORTAC facility to accommodate aircraft equipped with only TACAN.

(2) Establish a VOR-type procedure when a VOR procedure (no TACAN requirements) is required to accommodate non-DME-equipped aircraft, and is predicated upon a VORTAC facility. However, establish combination VHF/DME fixes, where possible, for optional use by DME-equipped aircraft.

(3) Make provision for TACAN-only equipped aircraft to use VOR approach procedures when requested by the appropriate military authority and procedure design and facility performance will permit. Where approval can be authorized, rename VOR procedures based on VORTAC facilities in accordance with the following examples: “VOR or TACAN RWY 30, or VOR or TACAN-A.” Before this identification is used, flight inspection must determine that the TACAN azimuth alignment is satisfactory. Review and modify the procedure as necessary to fully support its use by TACAN-equipped aircraft:

- (a) Establish the missed approach clearance limit at a combination VHF/DME fix for TACAN aircraft.
- (b) Add DME fix capability to VHF intersections where required for TACAN use.
- (c) Ensure that the procedure can be flown satisfactorily by reference to TACAN-only equipment.
- (d) Ensure that the procedure can be flown satisfactorily by reference to VOR-only equipment.
- (e) Ensure that holding is not authorized for TACAN-equipped aircraft at the VORTAC. This also applies to VOR or TACAN procedures.

**b.** Order 8260.3, paragraph 3-1-2.b. RVR must be authorized in accordance with Order 6560.10, Runway Visual Range (RVR).

(1) The Service Area OSG-FPT must determine in conjunction with the Technical Operations Service the following:

- (a) Planned RVR installations, proposed commissioning dates, and runways to be served.
- (b) Runways that meet the requirements for authorizing RVR.
- (c) RVR installations that are to be used to report RVR for adjacent runways and the effective date of the procedures.

(2) Aeronautical Information Services must revise affected procedures by the normal abbreviated or full amendment process.

**c.** Order 8260.3, paragraph 3-1-2.b. If runway markings are removed or obliterated subsequent to the commissioning of the RVR, the RVR minimums may require adjustment. However, before an adjustment is made to the minimums, Aeronautical Information Services should advise the appropriate Service Area OSG-FPT who will advise the airport sponsor of the proposed course of action. Where corrective action cannot be accomplished within a reasonable length of time, Aeronautical Information Services must submit a revised procedure reflecting the adjustment to landing minimums.

**4-1-6. Sidestep maneuvers.** See Order 8260.3, chapter 2, for guidance on developing instrument approach procedures to permit a sidestep maneuver. Sidestep minimums must be published in accordance with the examples below:

Minimums block:

S-ILS 27L	LPV DA
S-LOC 27L	LNAV/VNAV DA
SIDESTEP 27R	LNAV MDA
CIRCLING	SIDESTEP 27R
	CIRCLING

**4-1-7. Temporary displaced threshold procedures.** Temporarily displacing or moving the threshold may have an adverse effect on instrument approach/departure procedures. If an instrument procedure to the affected runway is required during the time of threshold displacement, evaluate existing instrument procedures as follows:

**a.** Once the new threshold/departure end has been established, obstacles that lie within the displaced area (machinery, vehicles, etc.) must be evaluated to ensure the procedure continues to meet Order 8260.3 criteria. If used at night or in IFR conditions, runway lighting must include threshold lighting for the displaced threshold.

**b.** For procedures authorized straight-in minima, re-compute visibility based on the revised “MAP-to-threshold” distance and the NALS facility class.

**c.** Suspend vertically-guided approach operations by NOTAM. This includes RNAV procedures that contain LPV and/or lateral navigation/vertical navigation (LNAV/VNAV) minima. Technical Operations Service, AJW-0, is responsible for turning off the instrument landing system (ILS) glide slope until the normal runway configuration is restored.

(1) There may be situations where the threshold is displaced only a short distance without affecting vertically-guided approach capability. To determine if such procedures can remain useable, the relocated TCH must be computed and be in compliance with Order 8260.3, table 10-1-2. Consideration must also be given to what may be located in the closed portion of the runway and the TERPS obstacle identification surface (OIS) must be evaluated to ensure proper obstacle clearance.

(2) Special instrument procedures must also be afforded the same assessment as standard instrument procedures. The results must be provided to the AWO so that the change information is provided to all the recipients of the Special procedure affected.

**d.** Visual glide slope indicator systems (VASI/PAPI/PLASI) may be unavailable for the same reason as the vertically guided approach.

**e.** The elevation of the new threshold and airport will more than likely change. In this case, evaluate the revised HAT/HAA for visibility impact and NOTAM changes accordingly.

**f.** Evaluate departure procedures for use during threshold displacement from the new departure end of runway (DER) to ensure compliance with Order 8260.3.

**Section 4-2. Standard Instrument Approach Procedures (SIAP)**

**4-2-1. General.** SIAPs must be established in accordance with Order 8260.3, other specific 8260-series orders, and the policies set forth in this order. FAA policy and instructions for completing 8260-series forms are contained in this order.

**4-2-2. Coordination of Terminal Instrument Procedures.** Coordination requirements for terminal instrument procedures are set forth in Order 8260.3, paragraph 1-5-1 [also see paragraph 8-6-12].

**4-2-3. Radar Instrument Approach Procedures.** ATC personnel determine which runways require radar instrument approach procedures and coordinate these requirements through Aeronautical Information Services.

### Section 4-3. Category II and III ILS

#### 4-3-1. General.

**a.** Guidance. The following directives (latest editions) contain criteria/guidance to be used to determine whether an airport/runway is suitable to support ILS CAT II and III procedures:

- (1) AC 120-28, Criteria for Approval of Category III Weather Minima for Takeoff, Landing, and Rollout.
- (2) AC 120-29, Criteria for Approval of Category I and Category II Weather Minima for Approach.
- (3) AC 120-57, Surface Movement Guidance and Control System (SMGCS).
- (4) AC 150/5300-13, Airport Design.
- (5) Order 6750.24, Instrument Landing System and Ancillary Electronic Component Configuration and Performance Requirements.
- (6) Order 8200.1, United States Standard Flight Inspection Manual.
- (7) Order 8400.13, Procedures for the Evaluation and Approval of Facilities for Special Authorization Category I Operations and All Category II and III Operations.

**Note:** There are other orders and Advisory Circulars that apply to specific runway equipment, placement of hold signs/lines, etc. as well as navigational aid installation requirements. The above list would, in most cases, lead the reader to the other references. A full list of reference documents for all aspects of the procedures function is contained in appendix B of this order.

**b.** Advise the general public of airports authorized CAT I, II, and III minimums by publishing the appropriate 14 CFR part 97 SIAP.

**c.** A detailed explanation of the characters used to identify a facility's class of performance is contained in Order 6750.24, appendix 2. The first character (I, II, or III), ILS ICAO standards, is determined jointly by flight inspection and engineering personnel. The second character (A, B, T, D, or E), localizer course structure, is determined solely by flight inspection personnel. The third character (1, 2, 3, or 4), ILS integrity and continuity, is determined solely by engineering personnel.

**d.** Irregularities on pre-threshold terrain or HUD/autoland system/radio altimeter characteristics might adversely affect radio altimeter indications and thus affect autoland performance of some aircraft. Until or unless these aircraft demonstrate normal radio altimeter readings and acceptable HUD/autoland operations on that runway and this fact is listed in their operations specifications, they cannot conduct CAT III HUD/autoland operations. The Flight Operations/Performance-Based Flight Operations branches act as the clearing house for listing which combinations of HUD/autoland systems/runways are or can be approved, and is positioned for receipt of information from Flight Inspection, AJW-0, ATC, Airports, and airport

authorities regarding irregular underlying terrain situations at new runways or runways at which future CAT III procedures are proposed.

#### **4-3-2. Action.**

##### **a. Services Areas/Flight Standards.**

(1) Applicable Technical Operations Service Areas and Aeronautical Information Services coordination is essential. Aeronautical Information Services, having been informed of the need for (and suitability of a runway to support) CAT II and III must assure obstacle clearance requirements.

(2) AWO coordinates the procedure request with the RAPT. The AWO is also responsible for coordinating the CAT II/III checklists and will notify Flight Operations/Performance-Based Flight Operations branches when CAT II or III checklists are complete. Notification must contain the information obtained from Aeronautical Information Services [see paragraph 4-3-2.b(1)].

##### **b. Aeronautical Information Services.**

(1) Aeronautical Information Services must advise the AWO when a CAT II or III system has passed flight inspection. Notification must contain the following information:

- (a) Airport.
- (b) Runway.
- (c) Flight inspection completion date.
- (d) Facility classification.
- (e) Minimums:

CAT II DA and RA.  
CAT III RVR  
(as appropriate).

- (f) Date approach procedure will be available.

(2) Amend ILS SIAPs when CAT II and III minimums are authorized [see paragraph 8-6-11.m].

(3) Flight Program Operations is responsible to take action when performance class data in AIRNAV needs to be corrected or updated. Flight Program Operations will take immediate NOTAM action if needed and submit a data change request (Form 8240-20) to update the AIRNAV Database. The applicable Technical Operations Service Area must notify the AWO and Flight Program Operations, Technical Services Team, of individual ILS facility performance

classification determinations, and any change in the performance class of a facility, so that changes in CAT III authorizations can be made.

c. Flight Operations Branch/Performance-Based Flight Operations Branch's CAT II/III status list web site. This notification will provide operators with the planned availability of the new minimums for preparation of operations specifications prior to publication of the SIAP.

**4-3-3. NOTAM requirements.** When any component of the ILS system fails to meet the appropriate performance tolerances, the Air Traffic Vice President of Technical Operations issues a NOTAM D for suspension of CAT II/III minimums. If the suspension will exist longer than 224 days or will be permanent, Aeronautical Information Services must submit an abbreviated or full amendment [see Order 7930.2 for all NOTAM requirements and limitations].



**Section 4-4. Departure Procedures (DP)**

**4-4-1. General.** Use Order 8260.46 for guidance and standardization for initiating, developing, documenting, processing, and managing the DP program.

**4-4-2. Diverse Vector Area (DVA).** A DVA must be reviewed by Aeronautical Information Services (AJV-5) for accuracy and currency whenever the ODP for the same runway is reevaluated due to a change of the airport or runway data. A DVA based on a climb to an initial MVA/MIA must also be reviewed when the associated Form 7210-9 (or military equivalent) is revised. See paragraph 2-8-2.a for Periodic Review requirements. See Order 8260.46 for DVA documentation requirements.

## Section 4-5. Standard Terminal Arrival (STAR)

### 4-5-1. General.

**a.** Request for STARs. STARs may be requested by Air Traffic Control facilities [see Order JO 7100.41] or by proponents. Proponents requesting STARs should contact/coordinate with the appropriate facility to address their request and justification for the procedure.

(1) Requests must be initiated and coordinated as stated in Order 7100.41 and be submitted to Aeronautical Information Services [see paragraph 4-5-2].

(2) Requests for RNAV and RNP STARs must include a description of the STAR, including the ground track, fixes, Waypoints (WPs), and altitude/speeds.

(3) Requests for conventional STARs must include a description of the STAR, including the proposed ground track with navigational aids (NAVAID)/fixes, courses, radials, and altitudes/speeds.

**b.** STAR development and charting. For conventional STARs, use criteria specified in Order 8260.3, section 2-2. For RNAV and RNP STARs, also use criteria specified in Order 8260.58. Additionally:

(1) Do not combine conventional and RNAV STARs on the same chart.

(2) Develop STARs using the fewest number of NAVAIDs, fixes and/or WPs (existing, when possible) consistent with the requirements for the application of the procedure.

(3) Use existing NAVAIDs, fixes, and WPs whenever possible [see section 2-10].

(4) Consider the combined impact of altitude/airspeed and course changes on a STAR. Use a *minimum* number of fixes, turns, and speed or altitude changes/crossing restrictions necessary along the route.

(5) NAVAID, fix, and WP crossing altitudes must be defined as “at,” “at or above,” or “at or below,” or as a block altitude. Whenever an “at or below” altitude is specified for ATC purposes, also include a minimum altitude to ensure obstacle clearance. When an altitude range at a waypoint is needed, use a block altitude (i.e., “At or Above 12000 and At or Below 16000” or “Between 12000 and 16000”).

**Note:** Do not define an *altitude* as one that could be *expected* to be assigned by ATC. Past use of this concept has shown that “expect” altitudes have caused confusion and misinterpretation that could lead to unintended consequences.

(6) A chart note may be used to control transition from Mach number to airspeed. Do not use a fix or altitude in this case.

**Example:**

“Chart note: Jet aircraft descend via Mach number until xxxK, if unable, advise ATC.”

- (7) STARs must be contained within controlled airspace.
- (8) Do not include items of an ATC clearance in notes.
  - (a) Notes specifying runway transition use for a specific traffic flow are acceptable.
  - (b) At the end of the STAR (i.e., terminus), provide information to describe the runways and/or airports accessible from that end point. This information will be documented in the Additional Flight Data portion of Form 8260-17.1.

**Examples:**

CHART AT NLAND TERMINUS: KPDK LDG RWY 03L/R

CHART AT SLAND TERMINUS: KPDK LDG RWY 21R/L

CHART AT COVTN TERMINUS: LDG KCVC

CHART AT NORHY TERMINUS: LDG KRYYY AND KVPC

- (c) With complex runway configurations notes specifying how the pilot is to select the runway transition to load may be developed. With the note advise where to expect the specific runway assignment.

**Example:**

“Landing South use runway 19L transition. Expect runway assignment from TRACON prior to JOHNN”

- (9) When a STAR terminates at the Intermediate Fix (IF) or any fix prior to the IF, but may also allow for radar vectors, provide that information in the procedure description.
- (10) The STAR termination point must have an altitude specified (see Order 8260.3, section 2-2, “STAR termination”).
- (11) Include in the graphic depiction holding patterns referenced in the narrative of the STAR.
- (12) Publish fixes and associated holding patterns on en route low-altitude and high-altitude charts when they are used for en route ATC.
- (13) Publish fixes and holding patterns on arrival charts when they are used for the control of arrival traffic into a specified area.
- (14) Chart at least one very high frequency (VHF), one ultra-high frequency (UHF), (where available) and the Automatic Terminal Information System (ATIS) frequency at each airport served by the STAR.
- (15) The maximum number of airport frequencies that may be charted may not exceed one VHF and one UHF (where available) for tower and ground control.

(16) Include one VHF and one UHF air route traffic control center frequency only when there is no terminal facility involved.

(17) Do not include control frequencies in the arrival text.

(18) For STARs that terminate at a fix that is not part of an IAP, publish lost communication procedures if the standard guidance provided for in 14 CFR part 91.185 is not adequate. Unique operating conditions (i.e., terrain, special use airspace, etc.) may require explicitly defined lost communications procedures. When the potential for confusion exists, publish specific guidance on the chart.

(a) The local air traffic facility is responsible for determining the adequacy of lost communications procedures.

(b) The guidance must provide specific instructions that permit the aircraft to proceed to an IAF for the approach in use and/or provide an appropriate fix or fixes to proceed to and hold prior to executing an instrument approach.

(c) Ensure lost communications guidance is compatible with the type of navigation equipment on aircraft anticipated to use the procedure. For example, do not limit lost communications approach options to RNAV (GPS) type approaches when DME/DME/IRU is also authorized for an RNAV STAR; for STARs that permit use of DME/DME/IRU, provide a routing that can be flown with conventional navigation.

(d) Lost communications procedures on STARs are not coded into the FMS. Do not describe the lost communication procedure using terms or verbiage that could be mistaken for a coded route; i.e., “track to RUSSH.”

(19) A STAR must be named to correspond with a waypoint, fix, or NAVAID on the common route, normally where the common route begins, (i.e., “NASCR ONE ARRIVAL”). RNAV and RNP STARs will contain RNAV in parenthesis following the STAR name [i.e., “TOEZZ ONE ARRIVAL (RNAV)”. See paragraph 4-5-1.b(33) for guidance on the chart note required for either RNAV 1 or RNP 1.

(20) Number each original STAR as “ONE.” Number subsequent amendments in numerical sequence through NINE and then start over with ONE [see paragraph 4-5-1.d(1) for the amendment process].

(21) The STAR computer code will be assigned by using the NAVAID, fix, or WP identifier where the STAR common route begins, followed by a dot, and then the name of the procedure, followed by a revision number (1-9), e.g., “(NASCR.NASCRI).”

(22) En route transitions also require a computer code. En route transitions are assigned by using the NAVAID, fix, or WP identifier name where the en route transition begins, separated by a dot, followed by the name of the STAR, and suffixed with a number (1-9), e.g., “(FLO.NASCRI).”

(23) All runways served by a STAR must be coded when developing runway transitions. For seldom used runways, consider developing RNAV procedures that end with a radar vector.

(24) If the STAR or any of its transitions cannot be named in compliance with this paragraph, Aeronautical Information Services, the ATC facility, and the OSG/FPT must collaborate to determine an acceptable name.

(25) Use procedural data notes when limitations are necessary.

**Examples:**

“RADAR REQUIRED”

(26) The following applies to RNAV and RNP STARs only:

(a) RNAV 1 is the default designation for RNAV STARs. Annotate procedures with a standard note: “RNAV 1” on Form 8260-17.1.

(b) RNP 1 (in lieu of RNAV 1) is used when a STAR contains an RF leg or when surveillance (radar) monitoring is not acceptable to ATC for when DME/DME/IRU will be used. Annotate the procedure with a standard note: “RNP 1” on Form 8260-17.1.

(c) For RNAV and RNP STARs that terminate on a heading at a fix not on an IAP, annotate on the chart that radar vectors will be provided; e.g., expect radar vectors to final.

(d) For RNP STARs that contain an RF leg, use: **Note:** RF REQUIRED” if the RF leg is applicable to the entire procedure. If an RF leg is unique to a particular runway transition, incorporate “(RF Required)” into the arrival route description.

(27) All RNAV STARs will contain a note that describes the equipment sensor limitations. Notes as appropriate are as follows:

**Examples:**

**Note:** DME/DME/IRU or GPS REQUIRED

**Note:** GPS REQUIRED

(28) A note may be required to address the need for specific DME facilities to be operational. These are referred to as “critical DME facilities.”

**Examples:**

**Note:** FOR NON-GPS EQUIPPED AIRCRAFT, ABC, JKL, AND XYZ DMES MUST BE OPERATIONAL

**Note:** FOR NON-GPS EQUIPPED AIRCRAFT USING MNO TRANSITION, ABC, JKL, AND XYZ DMES MUST BE OPERATIONAL

(29) All RNAV STARs that are annotated “DME/DME/IRU or GPS REQUIRED” must be annotated as follows:

**Example:****Note:** RADAR REQUIRED FOR NON-GPS EQUIPPED AIRCRAFT

(30) Depict conventional STAR routing(s) on a VFR Sectional Chart. When use of a Sectional Chart is not viable, a Terminal Area Chart may be used. The depiction must include the STAR primary and secondary obstacle clearance areas and identification of the controlling obstacle or terrain used to establish the minimum altitude for each segment published. Depiction of turn expansion areas where two segments are joined is not required on this chart. The turn expansion areas will be added during processing by Aeronautical Information Services. Charts produced electronically are acceptable and must accurately reflect the scale of the type of chart used and be similar in quality to the original printed version to facilitate use by the flight inspection crew in-flight.

(31) For RNAV and RNP STARs, use the Terminal Area Route Generation, Evaluation and Traffic Simulation (TARGETS) software tool to produce depictions of the obstacle clearance areas and the controlling obstacles/terrain. The depiction must include the STAR obstacle clearance areas and identification of the controlling obstacle or terrain used to establish the minimum altitude for each segment published. Where two segments are joined, TARGETS will calculate and display the required turn expansion areas. The chart depiction must accurately reflect the chart scale and be similar in quality to the original printed version to facilitate use by the flight inspection crew in-flight. See Order JO 8200.44, Coordination of Flight Inspection Procedure Packages, for guidance on what must be submitted for Flight Inspection.

(32) Complete and forward the applicable forms and procedure depictions to the OSG. For a STAR complete Forms 8260-17.1, 8260-17.2, and Form 8260-2 worksheet.

(33) When ATC has determined that they do not want pilots to “Flight Plan” or file a particular STAR (i.e., use will be determined by ATC), ATC will request that a chart note be placed on the STAR. In the “Procedural Data Notes” section of Form 8260-17.1, use: “Chart Note: Do Not File – To Be Assigned by ATC.”

**c.** Waivers/Approval requests. Requests for waivers/approval requests to design (i.e., TERPS) criteria and/or deviation to the requirements specified in this section are processed per section 2-12.

(1) Requests for deviation from non-criteria items outside the scope of this order, e.g., ATC waivers/approvals, are processed through the service area OSG.

(2) Mission Support Services, PBN Integration Group, AJV-14, reviews RNAV and RNP STAR waiver/approval requests and will participate in the Procedure Review Board with Flight Standards Service as needed.

**d.** STAR amendments. STARs may be amended using either the full amendment or an abbreviated amendment process as specified below. An amendment must ensure periodic review requirements have been met for the procedures and documented. A full amendment requires a complete procedure package (i.e., all necessary forms, maps, and supporting documentation) be developed and submitted for processing. An abbreviated amendment only requires submission of

the Form 8260-17.1 (and Form 8260-17.2 for RNAV STARs) for processing. See Order JO 8200.44 for guidance on what must be submitted for Flight Inspection.

(1) Both the full and the abbreviated amendment processes require the number in the procedure title to be increased; e.g., "EAGUL THREE ARRIVAL" increases to "EAGUL FOUR ARRIVAL" by updating Forms 8260-17.1 and 8260-17.2 Arrival Name, Number, STAR Computer Code, Superseded Number and Date.

(2) A full amendment and procedure submission package is required whenever a change is made to the following items:

- (a) Arrival Route Description,
- (b) Transition Routes (Adding/revising),
- (c) Airports Served (only when airports are added), and
- (d) Holding Patterns (Adding/revising).

(3) An abbreviated amendment may be submitted when a change is made to the items listed below as specified on Form 8260-17.1 (and Form 8260-17.2 for RNAV procedures). A P-NOTAM must not be used to effect an abbreviated amendment for STARs.

- (a) Transition Routes (only when removing),
- (b) Procedural Data Notes (e.g., changes to charted speeds, critical DMEs, etc.),
- (c) Lost Comm Procedures,
- (d) Controlling Obstacle,
- (e) Additional Flight Data,
- (f) Airports Served (only when an airport name, airport identifier, city/state has changed or an airport is deleted),
- (g) Communications,
- (h) Fixes and/or NAVAIDs. (Only those requested for charting purposes, but *are not* included in the textual description of the arrival or entered in the transition route data),
- (i) Remarks (that will require a change to what is charted on the procedure),
- (j) Altitude changes (RNAV procedures require RNAV-PRO assessment when altitude changes are made),
- (k) Heading/course/track number changes made to support a magnetic variation update that *does not* alter the ground track of the existing procedure, and

(l) Holding Patterns (only when removing).

(4) Whenever the “Arrival Name” changes the procedure must be canceled and a new procedure developed.

e. Reviews. Reviewing the operational need for procedures by air traffic is a continuous process.

(1) Procedures no longer valid, needed, or used, should be considered for cancellation.

(2) Continuously review procedures for operational need, accuracy, and initiate NOTAM action when required.

(3) Forward requests for changes to the OSG.

f. Cancellation. A proponent recommendation to cancel a STAR requires notification of the ATC facilities involved and coordination with the RAPT. ATC facilities requesting cancellation of STARs must prepare Form 8260-17.1 [see paragraph 4-5-3.c(3)] and Form 8260-2 (worksheets) and forward to the OSG with a cover letter requesting cancellation. Forward copies to all affected ATC facilities.

g. Military STAR procedures. The FAA will develop STARs at joint-use airfields. STARs developed by military proponents for military airfields are coordinated, processed, and charted in the same manner as civil STARs. Military proponents are responsible for ensuring coordination with the RAPT and affected ATC facilities.

#### **4-5-2. Roles and responsibilities.**

a. The Service Center Operations Support Group (OSG) must:

(1) Review each new or revised STAR to ensure accuracy and compliance with the provisions of this order. For RNAV or RNP STARs, the OSG will form a working group, designate a project facilitator as TARGETS operator, and begin the procedure development process. The review must include, as a minimum: Database integrity checks (WP, fix, etc.) to ensure accuracy of the data and coordination of WP/fix names. RNAV and RNP STARs developed with validated software may be submitted directly to Aeronautical Information Services Quality Assurance for processing.

(2) Ensure that the proposed procedure has been evaluated for potential environmental impacts in accordance with Order 1050.1. The Service Center environmental specialist assesses the preliminary environmental package to validate that proper environmental guidance has been applied to the proposed procedure.

(3) Complete an initial distance measuring equipment (DME) infrastructure assessment in accordance with Order 7470.1. This is not required when use of an RNAV or RNP procedure is intended to be limited to GPS-equipped aircraft. When required, request an ESV through the ESV Management System (ESVMS). If an acceptable DME/DME screening cannot be obtained the



procedure must be annotated “GPS Required.” Assistance in completing the DME/DME screening is available from the PBN Policy and Support Group.

(4) Evaluate for impact of airport airspace analysis, facilities and equipment, national change proposals or other applicable projects.

(5) Identify items requiring specific approval or waiver [see section 2-12]. Provide supporting documentation as needed, e.g., flight simulator results, etc.

(6) Forward procedure documentation to the respective Service Center OSG-FPT. The documentation includes:

- (a) Original signed and two copies of Form 8260-17.1.
- (b) Form 8260-17.2 (RNAV STARs).
- (c) Applicable Form 8260-2 data worksheet(s).
- (d) TARGETS software tool Distribution Package (required for RNAV and RNP STARs).
- (e) DME/DME infrastructure assessment results derived from RNAV Pro (RNAV and RNP STARs only); including DME limitations based upon line-of-sight or altitude restrictions.” GPS performance is not included as a function of the RNAV-Pro screening model; DME/DME assessment is not necessary for “GPS required” procedures.
- (f) The results of the Service Center environmental review.
- (g) Include a VFR sectional chart depicting the STAR off-airway routing and the route protected areas. Depict the controlling obstacles or terrain for each segment published for use at or below 18000 feet MSL in the contiguous United States (CONUS) and at or below FL230 for Alaska and Hawaii. A terminal area chart may be used when it is not possible to develop the procedure on a VFR sectional chart.
- (h) For RNAV and RNP STARs, a TARGETS-generated depiction of the route, protected areas, and controlling obstacles or terrain for each segment of the procedure may be submitted in lieu of a sectional chart.
- (i) The facility point of contact name and contact information.
- (j) For abbreviated amendments, up number, review and submit Form 8260-17.1 and Form 8260-17.2 to Aeronautical Information Services via the FPT.

**Note:** An electronic copy of the procedure package should also be forwarded to Aeronautical Information Services. At the discretion of Aeronautical Information Services, subsequent modifications to RNAV and RNP procedures must be coordinated through the OSG using the

electronic document. Procedure revisions require new copies of the appropriate forms, worksheets, and/or TARGETS distribution package to effect changes.

(7) Forward copies of completed documentation received from Aeronautical Information Services to all affected ATC facilities.

**b.** The AWO must:

(1) When requested by the OSG, assist in developing an equivalent level of safety for procedure waivers.

(2) Provide technical assistance on the development of new or significantly modified existing STARS.

**c.** Aeronautical Information Services must review STARS to ensure obstacle clearance requirements; accuracy of courses, distances, and coordinates; clarity and practicality of the procedures; and assurance of navigational guidance adequacy. Coordinate any discrepancies, required adjustments, or improvements noted during the review process and/or flight inspection with the sponsoring air traffic facility. Additionally:

(1) Ensure that the STAR commences at a charted high or low altitude en route fix.

(2) Ensure, in conjunction with flight inspection, that Transition Route MEAs and Minimum Obstruction Clearance Altitudes (MOCAs), where required, meet MRA, communication, and airspace requirements. Notify the appropriate ARTCC if NOTAM action is required.

(3) Ensure obstacle clearance requirements are met for lost communications instructions using the obstacle clearance criteria for a STAR that is specified in Order 8260.3 and/or Order 8260.58 for the applicable type of route and navigation guidance. If it is determined that obstacles/terrain present a potential problem, coordinate with the applicable controlling facility or facilities for resolution of the matter.

(4) Ensure entry in MAA from available documentation; e.g., flight inspection reports, ESV reports, etc.

(5) Ensure the accuracy of courses, distances, and coordinates.

(6) When required, complete and update fix and waypoint databases based on the submitted Form 8260-2 data worksheets.

(7) Review all waiver/approval requests to ensure compliance with paragraph 4-5-1.c.

(8) Advise the RAPT and OSG of any charting issues or publication delays.

(9) After a STAR is complete, forward STAR documentation or data to Flight Inspection.

(10) Forward documentation or data of the flight inspection and original forms or digitally signed data to NFDC for further processing and a copy to the originating Service Center. Critical DME facilities must be annotated on the Form 8260-17.1.

(11) Following Flight Inspection, return the signed form to the applicable Air Traffic Service Area for further processing.

(12) Retain a copy of each approved form with charts, computations, and supporting data to facilitate future reviews.

(13) Include normal distribution copies of Form 8260-2 for Mission Support Services, Aeronautical Information Services, AJV-5330, and ARTCC in the package forwarded to the applicable Air Traffic Service Area.

(14) Submit abbreviated STAR amendments to NFDC for charting in the next available chart cycle. Forward a copy of Form 8260-1 (if required) and Form 8260-17.1 to Flight Inspection for review.

**d. Flight Program Operations must:**

(1) Flight inspect/validate STARs to ensure obstacle clearance requirements, accuracy of courses, distances, coordinates, clarity and practicality of the procedures and assurance of navigational guidance adequacy.

(2) Ensure that transition route MEAs provide minimum obstruction altitudes (MOCAs) where required and meet MRA, communication, and airspace requirements.

(3) Review all procedures for accuracy of course, distance, and coordinates, flyability, human factors and to ensure the STAR is as simple as possible.

(4) Ensure the facility performance will support the procedure.

(5) Forward the results of flight inspection/validation to Aeronautical Information Services.

**e. NFDC must:**

(1) Conduct a pre-publication review of submitted forms to resolve data conflicts with Aeronautical Information Services and the OSG.

(2) Verify that fix names are not duplicated.

(3) Assign an effective date and publish the STAR and associated fixes/WP in the NFDD authorizing charting agencies to publish the STAR.

(4) File and maintain the original signed copy of the forms or digitally signed data.

(5) When a STAR or WP is canceled, ensure names are made available for future use.

**4-5-3. Preparation of Form 8260-17.1, Standard Terminal Arrival (STAR).****a. Title line.**

- (1) Arrival name. Enter the name of the STAR [i.e., CALEB, LACEE (RNAV)].
- (2) Number. Enter the STAR revision number spelled out (i.e., TWO).
- (3) STAR computer code. Enter the computer identification code.
- (4) Superseded number. STAR revision number superseded by this STAR. If original, insert "None."
- (5) Dated. Published or revision date of superseded STAR or date of the STAR that is being canceled. Format: MM DD YYYY (i.e., 03/12/2015).
- (6) Effective date. Leave blank. The effective date will normally be completed by NFDC. Enter an effective date only when a specific effective date is required (i.e., Magnetic Variation rotation). If the procedure is a "Special," enter "Special" on this line. Date Format: MM DD YYYY

**b. Transition routes.**

- (1) Transition name. Enter the name of each en route transition according to the fix or NAVAID where the en route transition(s) begins. For a transition starting at an existing NAVAID, use the NAVAID name and not the three-letter location identifier. Do not include the word "transition."
- (2) Transition computer codes. Enter computer code [see paragraph 4-5-1.b(29)].
- (3) From Fix/NAVAID. Enter the identifier/name of fix/NAVAID where each en route transition begins. Also, include the NAVAID type (i.e., CETUV or OLM VORTAC).
- (4) To Fix/NAVAID. Enter the identifiers/name(s) of all fix/NAVAID(s) that describe the en route transition after the first point, to and including the common point. Also, include the NAVAID type (i.e., CETUV or OLM VORTAC).

**Note 1:** If a transition has multiple segments, use one line for each segment.

**Note 2:** Document the transition starting fix/NAVAID in the To Fix/NAVAID column for each transition route.

- (5) Course. Enter the magnetic course for the transition segment. Specify the magnetic course to the hundredth of a degree; i.e., 354.24. Aeronautical Information Services will round entries to the nearest whole degree for publication. For conventional procedures also include the radials (i.e., TWN R-077 & WSN R-260).

- (6) Distance. Enter the distance for each transition segment. Specify the distance to the hundredth of a nautical mile (i.e., 72.48).

(7) MEA. Enter the MEA along each en route transition segment. En route transitions sharing a common segment should have the same MEA. If it is the intention to have different MEAs on a common segment, note this in the Remarks section of the forms.

(8) MOCA. Enter the MOCA along the route segment. To reduce chart clutter, do not publish MOCAs less than 500 feet below the MEAs.

(9) Enter the MAA along each en route transition, if required.

(10) Crossing altitudes/fixes. Enter altitude at specified fix when necessary for traffic flow requirements and/or vertical descent profile (i.e., AT/ABOVE FL210). The altitude must not be lower than the MEA.

c. Arrival route description. Provide a clear and concise textual description of the STAR from the common route starting point to the ending point on the STAR. Include only information pertinent to the arrival procedure. If the arrival route can be clearly understood from a graphic depiction, a complete textual description is not necessary. Describe the first segment then state, "...thence as depicted to" the last point on the route.

(1) Document all courses, headings, tracks, and distances to the nearest hundredth unit of measurement.

**Note:** The arrival route description entries will be published verbatim on the chart, with the exception of courses, headings, tracks, and distance which will be rounded by the charting organization to the nearest whole unit.

(2) RNAV and RNP STARs. The textual description of RNAV and RNP STARs requires specific narrative wording to match the leg type information depicted on associated Form 8260-17.2, STAR (Data Record) [see table 4-5-1 for required wording]. For RNAV and RNP STARs that contain runway specific routing specify the landing runway (i.e., Landing Runway 16L):

(a) Ensure courses, tracks, headings, distances, altitude, and speed entered on Form 8260-17.1, STAR – Standard Terminal Arrival, match the equivalent values and distances entered on Form 8260-17.2.

(b) Turn directions must be specified as either "left" or "right" for all RF legs. Turn directions must be specified as either "left" or "right" for all TF legs when the course change exceeds 90 degrees [see table 4-5-1].

**Table 4-5-1. Leg Type Wording and Required Information**

Form 8260-17.2 Leg Type	Form 8260-17.1 Wording	Form 8260-17.1 Required Information
TF	Track	Course/ distance/ turn direction*
RF	Radius	Distance/ turn direction
FM	Track	Course
VM	Heading	Heading

\* Only specify turn direction for TF legs when amount of turn exceeds 90°

(3) When a STAR is canceled [see paragraph 4-5-1.f], enter “Procedure Canceled Effective (Date)” in this section.

**d.** Procedural data notes. Enter any information that will appear in note form on the published chart; i.e., RADAR Required.

(1) List expected speed restrictions (e.g., CHART: Expect to Cross OLM at 280 KIAS).

(2) RNAV STARs must indicate “RNAV 1.” RNP STARs must indicate “RNP 1.” RNAV or RNP STARs limited to use by GPS-equipped aircraft must include a note indicating “GPS Required.” RNAV or RNP STARs designed for DME/DME/IRU equipped aircraft require a note indicating “RADAR Required.”

(3) List critical DMEs if they exist (i.e., BTG Transitions: For non-GPS equipped aircraft OLM must be operational).

(4) List equipment restrictions (i.e., “Jet aircraft only”).

(5) See paragraph 4-5-1.b(26)(d), for “RF REQUIRED” Note application.

(6) STARs that require radar vectors must have a note “RADAR Required.”

**e.** Fixes and/or holding patterns. Enter those fixes and/or NAVAIDs for which charting is requested but are not included in the textual description of the STAR or entered into transition route data. Also, enter those fixes and/or NAVAIDs at which holding is required and enter the applicable holding instructions. Ensure the accompanying Form 8260 2, Data Worksheet, contains the same charting instructions.

**f.** Communications. Enter the name of all radio communications to be charted; i.e., ATIS, AWOS, APP CON. Specify the frequency only if different than what is currently published.

**g.** Airports served. Enter all airports served by the STAR. List the city and two letter state code for each airport listed, followed by the airport ICAO ID.

**h.** Lost communication procedure. ATC is responsible for determining the content of lost communications instructions.

(1) Where potential for confusion exists (i.e., a procedure terminating on a heading), it is preferable to publish specific lost communication guidance on the chart. The guidance should provide specific instructions that permit the aircraft to proceed to an IAF for the approach in use. In order to provide for contingencies, instructions should also provide an alternate procedure with the appropriate fix/WP to proceed to and hold prior to executing an instrument approach. Do not describe the lost communication procedure using terms or verbiage that could be mistaken for a coded route; i.e., “track to RUSSH.”

(2) This may be left blank when lost communication procedures are the same as in 14 CFR part 91.185 (standard) and there is no potential for confusion. However, it is preferable to provide an appropriate fix to proceed to and hold prior to executing an instrument approach.

**i.** Remarks. List information/data that is not to be charted; i.e., administrative data or notes for controller information (requested by air traffic control). These items will not be seen in the National Flight Data Digest.

**j.** Additional flight data. List any additional charting instructions, items essential to clarify charting, or information a specialist has determined needs charting as other than a note.

(1) Data may include items such as terrain features, Special Use Airspace, or landing obstacles. Airports not served by the procedure should not be charted unless accompanied by a note in (Procedure Data Notes) indicating the reason for charting; i.e., “FTR jet arrivals below 5000 MSL.”

(2) For RNAV and RNP STARs place the procedure design (arrival airport) magnetic variation of record used to develop the STAR in this section; i.e., MAG VAR: KSEA 17E/2010.

(3) Enter the results of the DME/DME Assessment after completion of the flight inspection. Results will be recorded as: “DME/DME ASSESSMENT: SAT (RNP 1.0 OR 2.0 AS APPROPRIATE)”, “DME/DME ASSESSMENT: UNSAT (RNP 1.0), SAT (RNP 2.0)”, or “DME/DME ASSESSMENT: UNSAT.”

(4) If the DME/DME assessment indicates “UNSAT” or “NOT CONDUCTED,” the note “GPS Required” must be entered in (Procedure Data Notes).

(5) Enter terminus point information [see paragraph 4-5-1.b(8)(b)].

**k.** Flight Inspected by. Leave blank. Flight inspection will enter the name of the airspace system inspection pilot who conducted the flight inspection and date.

**l.** Developed by. Enter the name of the procedure specialist. This individual must sign in the “developed by” space and enter the date.

**m.** Approved by. Enter the name of the Aeronautical Information Services’ manager, or his/her delegated representative. This individual must sign in the “approved by” space and enter the date signed. If the procedure is a “Special,” this line will contain the name of and be signed by the Flight Procedure Implementation and Oversight Branch.

- n.** Changes/Reasons. List changes and reasons relating to data entries.
- o.** Graphic depiction. Include a graphic depiction of the STAR. Identify on the depiction the WPs, navigational aids, and holding patterns.



Figure 4-5-1. Form 8260-17.1 – STAR

FEDERAL AVIATION ADMINISTRATION  
FLIGHT STANDARDS SERVICE  
STANDARD TERMINAL ARRIVAL (STAR)

Bearings, headings, courses, tracks and radials are magnetic. Elevations and altitudes are in feet, MSL. Altitudes are minimum altitudes unless otherwise indicated. Ceilings are in feet above airport elevation. Distances are in nautical miles. Visibilities are in statute miles or feet RVR, unless otherwise indicated.

Arrival Name	Number	STAR Computer Code	Superseded Number	Dated	Effective Date
EAGUL (RNAV)	FIVE	EAGUL.EAGUL5	FOUR	MM/DD/YYYY	MM/DD/YYYY

TRANSITION ROUTES:

Transition Name	Transition Computer Code	From FIX/NAVAID	To FIX/NAVAID	Course	Distance	MEA	MOCVA	MAA	Crossing Altitude/Fixes
WINSLOW	INW.EAGUL5	INW.VORTAC	INW.VORTAC						
		EAGUL	EAGUL	182.43	57.49	FL 180	10300		AT/ABOVE FL 180 AT/BELOW FL 230
		DOJOE	DOJOE	234.19	26.00	FL 200	8400		
		SLIDR	SLIDR	233.91	12.00	FL 200	8400		
		TINIZ	TINIZ	233.80	31.00	FL 200	8400		AT/BELOW FL 330
		PAYSO	PAYSO	233.47	20.07	FL 180	8400		AT/ABOVE FL 240 AT/BELOW FL 280
		EAGUL	EAGUL	215.09	19.56	FL 180	8400		AT/ABOVE FL 180 AT/BELOW FL 230

ARRIVAL ROUTE DESCRIPTION:

FROM EAGUL ON TRACK 214.99/22.00 TO CROSS HOMRR AT OR BELOW 16000 AND AT 250 KIAS.  
LANDING RWY 08: FROM HOMRR ON TRACK 225.88/4.22 TO CROSS SMAAK BETWEEN 14000 AND 15000 AND AT 250 KIAS. THEN ON TRACK 225.87/13.98 TO CROSS GEENO AT 10000 AND AT 250 KIAS. THEN ON TRACK 255.03/12.50 TO CROSS QUENY AT 9000 AND AT 210 KIAS. THEN ON TRACK 228.12/8.11 TO CROSS HINEY AT 7000 AND AT 210 KIAS. THEN ON TRACK 258.35/6.36 TO OBASE. THEN ON TRACK 258.19/5.71 TO CROSS BASBL AT 7000. THEN ON TRACK 258.20. EXPECT RADAR VECTORS TO FINAL APPROACH COURSE.  
LANDING RWY 26: FROM HOMRR ON TRACK 203.86/4.08 TO CROSS VNNOM BETWEEN 10000 AND 11000 AND AT 250 KIAS. THEN ON TRACK 203.28/6.70 TO CROSS DERVL AT 210 KIAS. THEN ON TRACK 203.22/3.32 TO CROSS JAGAL AT OR ABOVE 4500. EXPECT ILS OR LOC RWY 26.

PROCEDURAL DATA NOTES:

NOTE: RADAR REQUIRED.  
NOTE: RNAV 1.  
NOTE: DME/DME/IRU OR GPS REQUIRED.  
NOTE: TURBOJET AIRCRAFT ONLY.  
NOTE: CROSS EAGUL AT 270 KIAS. CROSS TINIZ AT 270 KIAS. CROSS PAYSO AT 270 KIAS. CROSS HOMRR AT 250 KIAS. CROSS SMAAK AT 250 KIAS. CROSS GEENO AT 250 KIAS. CROSS QUENY AT 210 KIAS. CROSS HINEY AT 210 KIAS. CROSS VNNOM AT 250 KIAS. CROSS ESDEE AT 210 KIAS. CROSS BASBL AT 210 KIAS. CROSS DERVL AT 210 KIAS.

FEDERAL AVIATION ADMINISTRATION  
FLIGHT STANDARDS SERVICE  
STANDARD TERMINAL ARRIVAL (STAR)

Bearings, headings, courses, tracks and radials are magnetic. Elevations and altitudes are in feet, MSL. Altitudes are minimum altitudes unless otherwise indicated. Ceilings are in feet above airport elevation. Distances are in nautical miles. Visibilities are in statute miles or feet RVR, unless otherwise indicated.

Arrival Name	Number	STAR Computer Code	Superseded Number	Dated	Effective Date
EAGUL (RNAV)	FIVE	EAGUL.EAGUL5	FOUR	MM/DD/YYYY	MM/DD/YYYY

**FIXES AND/OR HOLDING PATTERNS:**

CHART HOLDING AT ZUN: E, LT, 253.00 INBOUND, 10 NMI LEGS.  
CHART HOLDING AT HOMRR: W, RT, 214. 00 INBOUND, 8 NMI LEGS.

**COMMUNICATIONS:**

PHX ATIS, PHOENIX APPROACH CONTROL

**AIRPORTS SERVED:** AIRPORT NAME  
Phoenix Sky Harbor International (KPHX)

CITY	Phoenix
STATE	AZ

**LOST COMMUNICATIONS PREFERENCES:**

LANDING RWY 34L, 34C, AND 34R AT BECHR LEFT TURN, INTERCEPT AND EXECUTE RWY 34L ILS APPROACH.

**REMARKS:**

**ADDITIONAL FLIGHT DATA:**

DME/DME ASSESSMENT: SAT (RNP 1.0)  
MAGNETIC VARIATION: KPHX 12E/2015  
CHART AT BASBL TERMINUS: LDG RWY 08  
CHART AT JAGAL TERMINUS: LDG RWY 28

**FLIGHT INSPECTED BY:**

**ORGANIZATION:** AJV-XXX  
**DATE:** Flight Inspected Signature:

**DEVELOPED BY:**

XXX ARTCC  
Developed By Signature:

**APPROVED BY:**

XXX-XXX  
Approved By Signature:

**CHANGES - REASONS:**

FAA Form 8260-17.1 (12/16)

Electronic Version

FEDERAL AVIATION ADMINISTRATION  
FLIGHT STANDARDS SERVICE  
STANDARD TERMINAL ARRIVAL (STAR)

Bearings, headings, courses, tracks and radials are magnetic. Elevations and altitudes are in feet, MSL. Altitudes are minimum altitudes unless otherwise indicated. Ceilings are in feet above airport elevation. Distances are in nautical miles. Visibilities are in statute miles or feet RVR, unless otherwise indicated.

Arrival Name	Number	STAR Computer Code	Superseded Number	Dated	Effective Date
EAGUL (RNAV)	FIVE	EAGUL.EAGUL5	FOUR	MM/DD/YYYY	MM/DD/YYYY

1. Added holding at ZUN and HOMRR - ATC Requested.
2. Revised altitude and speed constraints - ATC Requested.

FEDERAL AVIATION ADMINISTRATION  
FLIGHT STANDARDS SERVICE  
STANDARD TERMINAL ARRIVAL (STAR)

Bearings, headings, courses, tracks and radials are magnetic. Elevations and altitudes are in feet, MSL. Altitudes are minimum altitudes unless otherwise indicated. Ceilings are in feet above airport elevation. Distances are in nautical miles. Visibilities are in statute miles or feet RVR, unless otherwise indicated.

Arrival Name	Number	STAR Computer Code	Superseded Number	FOUR	Dated	Effective Date
EAGUL (RNAV)	FIVE	EAGUL.EAGUL5			MM/DD/YYYY	MM/DD/YYYY

Remove Graphic	+
Insert Graphic	-

Title: Graphic Depiction 1

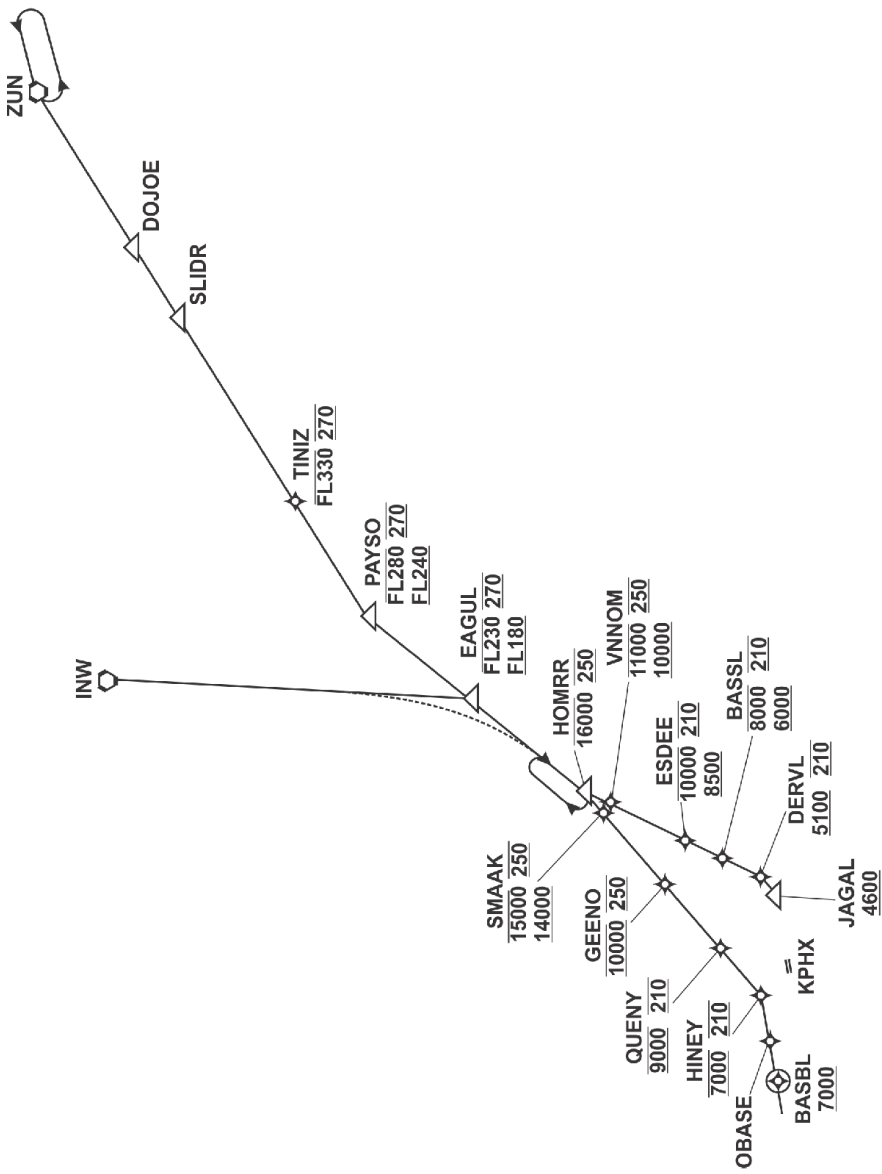

Figure 4-5-2. Form 8260-17.1 – STAR

FEDERAL AVIATION ADMINISTRATION  
FLIGHT STANDARDS SERVICE  
STANDARD TERMINAL ARRIVAL (STAR)

Bearings, headings, courses, tracks and radials are magnetic. Elevations and altitudes are in feet, MSL. Altitudes are minimum altitudes unless otherwise indicated. Ceilings are in feet above airport elevation. Distances are in nautical miles. Visibilities are in statute miles or feet RVR, unless otherwise indicated.

Arrival Name	Number	STAR Computer Code	Superseded Number	Dated	Effective Date				
	FIVE	DQO.DYLN5	FOUR	MM/DD/YYYY	MM/DD/YYYY				
<b>DYLN</b>									
<b>TRANSITION ROUTES:</b>									
Transition Name	Transition Computer Code	From FIX/NAVAID	To FIX/NAVAID	Course	Distance	MEA	MOCA	MAA	Crossing Altitude/Fixes
FLAT ROCK	FAK.DYLN5	FAK VORTAC	FAK VORTAC						
			SHONA	41.69 (FAK R-042)	20.00	6000		FL 450	
			OTT VORTAC	41.84 (FAK R-042)	67.24	6000			
			PALEO	51.96 (OTT R-052)	26.01	6000			
			PEEDS	52.19 (OTT R-052)	09.20	6000			
			FUBRR	52.28 (OTT R-052)	10.07	6000			AT FL 270
			DOO VORTAC	52.37 (OTT R052)	33.53	6000			AT FL 200
GORDONVILLE	GVE.DYLN5	GVE VORTAC	GVE VORTAC						
			OTT VORTAC	53.39 (GVE R-064 & OTT R-0248)	78.38	6000		FL 450	
			PALEO	51.96 (OTT R-052)	26.01	6000			
			PEEDS	52.19 (OTT R-052)	09.20	6000			
			FUBRR	52.28 (OTT R-052)	10.07	6000			
			DOO VORTAC	52.37 (OTT R-052)	33.53	6000			
PATUXENT	PXT.DYLN5	PXT VORTAC	PXT VORTAC						

+ -

FEDERAL AVIATION ADMINISTRATION  
FLIGHT STANDARDS SERVICE  
STANDARD TERMINAL ARRIVAL (STAR)

Bearings, headings, courses, tracks and radials are magnetic. Elevations and altitudes are in feet, MSL. Altitudes are minimum altitudes unless otherwise indicated. Ceilings are in feet above airport elevation. Distances are in nautical miles. Visibilities are in statute miles or feet RVR, unless otherwise indicated.

Arrival Name	Number	STAR Computer Code	Superseded Number	Dated	Effective Date
DYLN	FIVE	DQO.DYLN5	FOUR	MM/DD/YYYY	MM/DD/YYYY
PEEDS	18.30 (PXT R-018)	51.73	6000	FL 450	
FUBRR	52.28 (OTT R-052)	10.07	6000	AT FL 270	
DOO VORTAC	52.37 (OTT-052)	33.53	6000	AT FL 200	

**ARRIVAL ROUTE DESCRIPTION:**

FROM DOO VORTAC ON DOO R-063 TO STEFE. THEN ON ARD R-233 TO ARD VOR/DME. THEN ON ARD R-057 TO DYLN. THEN ON ARD R-057 TO MERSR, THEN ON ARD R-057 TO CROSS METRO AT OR ABOVE 4000.  
LANDING RWYS 4L, 4R: APPROACHING METRO EXPECT RADAR VECTORS TO FINAL.  
LANDING RWYS 22L, 22R, 11: CROSSING METRO EXPECT RADAR VECTORS TO FINAL.

**PROCEDURAL DATA NOTES:**

NOTE: RADAR REQUIRED.  
NOTE: TURBOJET AIRCRAFT ONLY.

**FIXES AND/OR HOLDING PATTERNS:**

CHART HOLDING AT PALEO: SW, LT, OTT R-051.96 INBOUND  
CHART HOLDING AT STEFE: SW, TR, DOO R-052.87 INBOUND, 210 KNOTS  
CHART HOLDING AT ARD VOR/DME: SW, RT, ARD R-053.32 INBOUND 210 KNOTS  
CHART HOLDING AT MERSR: SW, RT, ARD R-057.01 INBOUND 210 KNOTS  
CHART HOLDING AT METRO: SW, LT, ARD R-075.01 INBOUND, 210 KNOTS

**COMMUNICATIONS:**

NEWARK ATIS 115.7/134.82  
WASHINGTON CENTER 132.52/307.25  
NEW YORK APP CON 128.55/379.9

**AIRPORTS SERVED:**

AIRPORT NAME  
Newark Liberty International (KEWR)

CITY STATE  
Newark

+	-
---	---

**LOST COMMUNICATIONS PREFERENCES:**

**REMARKS:**

Publication to be concurrent with changes to the PHLBO RNAV Arrival.

FEDERAL AVIATION ADMINISTRATION  
FLIGHT STANDARDS SERVICE  
STANDARD TERMINAL ARRIVAL (STAR)

Bearings, headings, courses, tracks and radials are magnetic. Elevations and altitudes are in feet, MSL. Altitudes are minimum altitudes unless otherwise indicated. Ceilings are in feet above airport elevation. Distances are in nautical miles. Visibilities are in statute miles or feet RVR, unless otherwise indicated.

Arrival Name	Number	STAR Computer Code	Superseded Number	Dated	Effective Date
DYLN	FIVE	DQO.DYLN5	FOUR	MM/DD/YYYY	MM/DD/YYYY

**ADDITIONAL FLIGHT DATA:**

CHART - RIC R-334 AT SHONA, AML R-091 AT PALEO, BAL R-133 AT PALEO, BAL R-088 AT FUBRR, PTW R-147 AT STEFE, PTW R-113 AT SOMTO, RBV R-297 AT DYLN, RBV R-303 AT MERSR, SBJ R-171 AT METRO  
CHART AT METRO TERMINUS: LDG RWYS 4LR, 22L/22R, 11

**FLIGHT INSPECTED BY:**

**ORGANIZATION:** AJW-XXX  
**DATE:** MM/DD/YYYY  
Flight Inspected Signature:

**DEVELOPED BY:**

XXX-ARTCC  
MM/DD/YYYY  
Developed By Signature:

**APPROVED BY:**

XXX-XXX  
MM/DD/YYYY  
Approved By Signature:

**CHANGES - REASONS:**

1. Added SHONA on the FAK transition -To be used as a fix, ATC can short cut arrivals to or have A/C rejoin the arrival route following vectors for sequencing.
2. Changed crossing restriction at FUBRR, from at or above FL270 to cross at FL270 - Request from user group (United Airlines) to assist crew in complying with ATC crossing restrictions.
3. Raised MEA through STEFE INT from 5000 to 6000 - Crossing Radial from PTW/VORTAC was restricted to 6000. ATC agreed to change.
4. Changed Note "RADAR Required above FL290" to "RADAR REQUIRED" - Procedure ends in mandatory Radar Vectors.

FEDERAL AVIATION ADMINISTRATION  
FLIGHT STANDARDS SERVICE  
STANDARD TERMINAL ARRIVAL (STAR)

Bearings, headings, courses, tracks and radials are magnetic. Elevations and altitudes are in feet, MSL. Altitudes are minimum altitudes unless otherwise indicated. Ceilings are in feet above airport elevation. Distances are in nautical miles. Visibilities are in statute miles or feet RVR, unless otherwise indicated.

Arrival Name	Number	STAR Computer Code	Superseded Number	Dated	Effective Date
DYLIN	FIVE	DQO.DYLIN5	FOUR	MM/DD/YYYY	MM/DD/YYYY

Title: Graphic Depiction 1

Remove Graphic	+
Insert Graphic	-

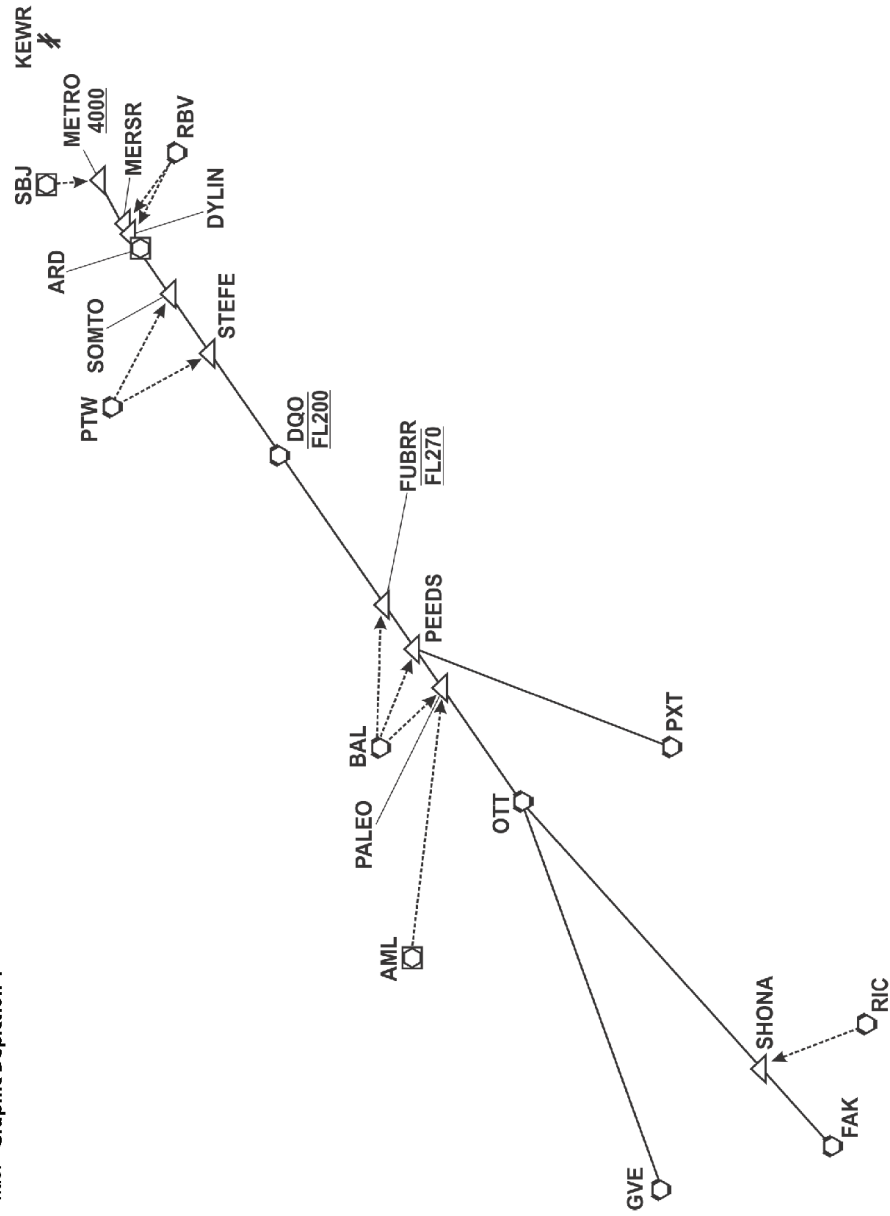

Electronic Version



Figure 4-5-3. Form 8260-17.1 - STAR

FEDERAL AVIATION ADMINISTRATION  
FLIGHT STANDARDS SERVICE  
STANDARD TERMINAL ARRIVAL (STAR)

Bearings, headings, courses, tracks and radials are magnetic. Elevations and altitudes are in feet, MSL. Altitudes are minimum altitudes unless otherwise indicated. Ceilings are in feet above airport elevation. Distances are in nautical miles. Visibilities are in statute miles or feet RVR, unless otherwise indicated.

Arrival Name	Number	STAR Computer Code	Superseded Number	Dated	Effective Date
COMPT (RNAV)	ONE	OLM.COMPT1	NONE	MM/DD/YYYY	MM/DD/YYYY

TRANSITION ROUTES:

+	-
---	---

Transition Name	Transition Computer Code	From FIX/NAVAID	To FIX/NAVAID	Course	Distance	MEA	MOCA	MAA	Crossing Altitude/Fixes
BATTLE GROUND	BTG.COMPT1	BTG VORTAC	BTG VORTAC						
		MALAY		333.16	41.12	FL 190	5200		AT/ABOVE FL 210
		TONNO		333.03	16.68	16000	4900		
		OLM VORTAC	OLM VORTAC	332.98	16.78	14000	4900		AT/ABOVE 14000, AT/BELOW 17000
CETUV	CETUV.COMPT1	CETUV	CETUV						
		OLM VORTAC		22.83	29.12	14000	4900		AT/ABOVE 14000, AT/BELOW 17000

ARRIVAL ROUTE DESCRIPTION:

FROM OLM VORTAC ON TRACK 024.00/6.00 TO LACEE, THEN ON 024.07/9.00 TRACK TO COMPT.

LANDING RWY 16R (RF REQUIRED): FROM COMPT ON TRACK 024.18/5.00 TO CROSS ARVAD AT 12000 AND AT 250 KIAS, THEN ON 024.24/6.00 TRACK TO FOURT, THEN ON 340.06/26.16 TRACK TO CROSS RWYEP AT 6000 AND AT 210 KIAS, THEN RIGHT TURN RADIUS TO WATEL, THEN ON 163.33/2.90 TRACK TO CROSS AGANE AT 6000. EXPECT ILS OR LOC RWY 16R.

LANDING RWY 34L, 34C, AND 34R: FROM COMPT ON TRACK 024.18/5.00 TO ARVAD AT 12000 AND AT 250 KIAS, THEN ON 024.24/6.00 TRACK TO FOURT, THEN ON 069.78/4.99 TRACK TO CROSS BECHR AT 6000, THEN ON 050.00 HEADING OR AS ASSIGNED BY ATC. EXPECT RADAR VECTORS TO FINAL APPROACH COURSE.

PROCEDURAL DATA NOTES:

- NOTE: RADAR REQUIRED.
- NOTE: RNP 1.
- NOTE: DME/DME/IRU OR GPS REQUIRED.
- NOTE: TURBOJET AIRCRAFT ONLY.
- NOTE: CROSS OLM AT OR BELOW 280 KIAS, CROSS ARVAAD AT 250 KIAS, CROSS RWYEP AT 210 KIAS.

FIXES AND/OR HOLDING PATTERNS:

**FEDERAL AVIATION ADMINISTRATION  
FLIGHT STANDARDS SERVICE  
STANDARD TERMINAL ARRIVAL (STAR)**

Bearings, headings, courses, tracks and radials are magnetic. Elevations and altitudes are in feet, MSL. Altitudes are minimum altitudes unless otherwise indicated. Ceilings are in feet above airport elevation. Distances are in nautical miles. Visibilities are in statute miles or feet RVR, unless otherwise indicated.

<u>Arrival Name</u>	<u>Number</u>	<u>STAR Computer Code</u>	<u>Superseded Number</u>	<u>Dated</u>	<u>Effective Date</u>
COMPT (RNAV)	ONE	OLM.COMPT1	NONE	MM/DD/YYYY	MM/DD/YYYY

COMMUNICATIONS:

ATIS, APP CON

AIRPORTS SERVED:

AIRPORT NAME

Seattle-Tacoma International (KSEA)

CITY

STATE

+	-
---	---

LOST COMMUNICATIONS PREFERENCES:

LANDING RWY 34L, 34C, AND 34R AT BECHR LEFT TURN, INTERCEPT AND EXECUTE RWY 34L ILS APPROACH.

REMARKS:

ADDITIONAL FLIGHT DATA:

DME/DME ASSESSMENT: SAT (RNP 1.0)  
MAGNETIC VARIATION: KSEA 17E/2015  
CHART AT AGANE TERMINUS: LDG RWY 16R  
CHART AT BECHR TERMINUS: LDG RWYS 34L/34C/34R

FLIGHT INSPECTED BY:

ORGANIZATION: DATE:

Flight Inspected Signature:

DEVELOPED BY:

Developed By Signature:

APPROVED BY:

Approved By Signature:

CHANGES - REASONS:

FEDERAL AVIATION ADMINISTRATION  
FLIGHT STANDARDS SERVICE  
STANDARD TERMINAL ARRIVAL (STAR)

Bearings, headings, courses, tracks and radials are magnetic. Elevations and altitudes are in feet, MSL. Altitudes are minimum altitudes unless otherwise indicated. Ceilings are in feet above airport elevation. Distances are in nautical miles. Visibilities are in statute miles or feet RVR, unless otherwise indicated.

Arrival Name	Number	STAR Computer Code	Superseded Number	Dated	Effective Date
COMPT (RNAV)	ONE	OLM.COMPT1	NONE	MM/DD/YYYY	MM/DD/YYYY

Remove Graphic	+
Insert Graphic	-

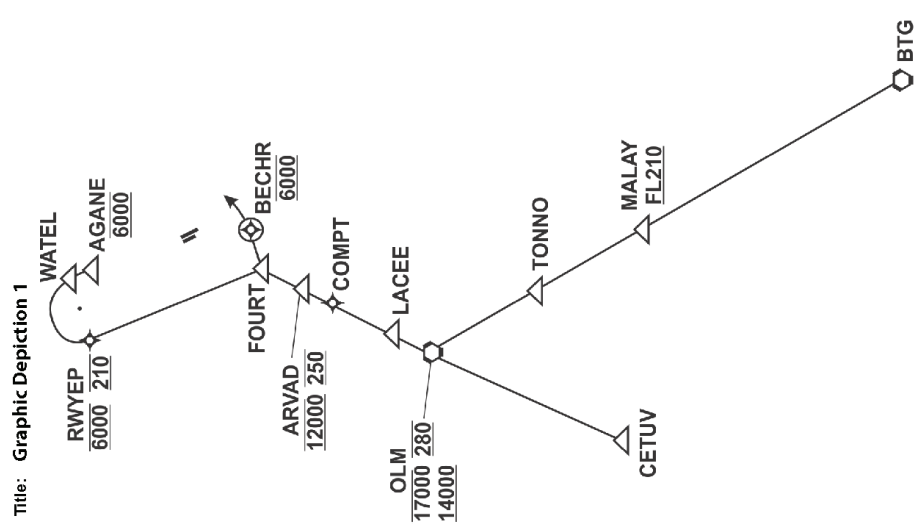

THIS PAGE IS INTENTIONALLY LEFT BLANK

Figure 4-5-4. Form 8260-17.1 - STAR

FEDERAL AVIATION ADMINISTRATION  
FLIGHT STANDARDS SERVICE  
STANDARD TERMINAL ARRIVAL (STAR)

Bearings, headings, courses, tracks and radials are magnetic. Elevations and altitudes are in feet, MSL. Altitudes are minimum altitudes unless otherwise indicated. Ceilings are in feet above airport elevation. Distances are in nautical miles. Distances are in statute miles or feet RVR, unless otherwise indicated. Visibilities are in nautical miles.

Arrival Name	Number	STAR Computer Code	Superseded Number	Dated	Effective Date				
RNTIN (RNAV)	ONE	RNTIN.RNTIN1	NONE	MM/DD/YYYY	MM/DD/YYYY				
<b>TRANSITION ROUTES:</b>									
Transition Name	Transition Computer Code	From FIX/NAVAID	To FIX/NAVAID	Course	Distance	MEA	MOCA	MAA	Crossing Altitude/Fixes
APPLS	APPLS.RNTIN1	APPLS	APPLS	195.58	28.18	10000	7700		
		AABBC							
		HELIN		194.89	26.20	9000	6900		
		RNTIN		195.08	32.55	9000	6600		BETWEEN 13000 AND 17000
FOOTHILLS	ODF.RNTIN1	ODF VORTAC	ODF VORTAC						
		RNTIN		254.41	36.38	9000	6600		BETWEEN 13000 AND 17000
SCNRY	SCNRY.RNTIN1	SCNRY	SCNRY						
		TRALZ		211.88	68.18	10000	8800		
		RNTIN		211.58	34.24	9000	7000		BETWEEN 13000 AND 17000
VIEWS	VIEWS.RNTIN1	VIEWS	VIEWS						
		RNTIN		234.60	102.27	9000	8500		BETWEEN 13000 AND 17000

**ARRIVAL ROUTE DESCRIPTION:**

KPK: FROM RNTIN ON TRACK 208.91/10.72 TO DEHAN, THEN ON TRACK 207.82/3.84 TO DIVDR, THEN ON TRACK 211.86/8.16 TO PTRREE  
 LANDING KPDK RWY 03R/L: FROM PTRREE ON TRACK 240.48/9.55 TO DWIND, THEN ON TRACK 205.40/12.19 TO CROSS NLAND AT OR ABOVE 4000, THEN ON TRACK 205.40. EXPECT RADAR VECTORS TO FINAL APPROACH COURSE.  
 LANDING KPDK RWY 21R/L: FROM PTRREE ON TRACK 210.34/4.51 TO CROSS SLAND AT OR ABOVE 3000. EXPECT ILS OR LOC TO RWY 21.  
 LANDING KCVC: FROM RNTIN ON TRACK 208.91/10.72 TO DEHAN, THEN ON TRACK 207.82/3.84 TO DIVDR, THEN ON TRACK 163.61/24.29 TO CROSS COVNTN AT OR ABOVE 4000, THEN ON TRACK 161.56. EXPECT RADAR VECTORS TO FINAL APPROACH COURSE.  
 LANDING KRYV/KVPC: FROM RNTIN ON TRACK 208.91/10.72 TO DEHAN, THEN ON TRACK 207.82/3.84 TO DIVDR, THEN ON TRACK 248.35/18.56 TO CROSS NORHY AT OR ABOVE 5000, THEN ON

FEDERAL AVIATION ADMINISTRATION  
FLIGHT STANDARDS SERVICE  
STANDARD TERMINAL ARRIVAL (STAR)

Bearings, headings, courses, tracks and radials are magnetic. Elevations and altitudes are in feet, MSL. Altitudes are minimum altitudes unless otherwise indicated. Ceilings are in feet above airport elevation. Distances are in nautical miles. Visibilities are in statute miles or feet RVR, unless otherwise indicated.

Arrival Name	Number	STAR Computer Code	Superseded Number	Dated	Effective Date
RNTIN (RNAV)	ONE	RNTIN.RNTIN1	NONE	MM/DD/YYYY	MM/DD/YYYY

TRACK 254.50. EXPECT RADAR VECTORS TO FINAL APPROACH COURSE.

**PROCEDURAL DATA NOTES:**

- NOTE: RADAR REQUIRED.
- NOTE: RNAV 1.
- NOTE: DME/DME/IRU OR GPS REQUIRED.
- NOTE: CROSS RNTIN AT/BELOW 250 KIAS.
- FIXES AND/OR HOLDING PATTERNS:**

CHART HOLDING AT TRALZ: W, RT 211.88 INBOUND, 10 NM LEGS

**COMMUNICATIONS:**

DEKALB-PEACHTREE ATIS 128.4, 126.975 ATL APPROACH CONTROL

**AIRPORTS SERVED:**

AIRPORT NAME	CITY	STATE
COVINGTON MUNI	ATLANTA	GA
DEKALB-PEACHTREE	ATLANTA	GA
COBB COUNTY-MCCOLLUM FIELD	ATLANTA	GA
CARTERSVILLE	CARTERSVILLE	GA

**LOST COMMUNICATIONS PREFERENCES:**

REMARKS:

FEDERAL AVIATION ADMINISTRATION  
FLIGHT STANDARDS SERVICE  
STANDARD TERMINAL ARRIVAL (STAR)

Bearings, headings, courses, tracks and radials are magnetic. Elevations and altitudes are in feet, MSL. Altitudes are minimum altitudes unless otherwise indicated. Ceilings are in feet above airport elevation. Distances are in nautical miles. Visibilities are in statute miles or feet RVR, unless otherwise indicated.

Arrival Name	Number	STAR Computer Code	Superseded Number	Dated	Effective Date
RNTIN (RNAV)	ONE	RNTIN.RNTIN1	NONE	MM/DD/YYYY	MM/DD/YYYY

**ADDITIONAL FLIGHT DATA:**

DME/DME ASSESSMENT: SAT (RNP 1.0).  
REFERENCE MAGNETIC VARIATION = KPDK 05W/2015  
CHART AT NLAND TERMINUS: KPDK LDG RWY 03L/R  
CHART AT SLAND TERMINUS: KPDK LDG RWY 21R/L  
CHART AT COVTN TERMINUS: LDG KCVC  
CHART AT NORHY TERMINUS: LDG KRYV AND KVPC

**FLIGHT INSPECTED BY:**

**ORGANIZATION:** XXX-XXX  
**DATE:** Flight Inspected Signature:

**DEVELOPED BY:**

XXX-ARTCC  
Developed By Signature:

**APPROVED BY:**

XXX-XXX  
Approved By Signature:

**CHANGES - REASONS:**

FEDERAL AVIATION ADMINISTRATION  
FLIGHT STANDARDS SERVICE  
STANDARD TERMINAL ARRIVAL (STAR)

Bearings, headings, courses, tracks and radials are magnetic. Elevations and altitudes are in feet, MSL. Altitudes are minimum altitudes unless otherwise indicated. Ceilings are in feet above airport elevation. Distances are in nautical miles. Visibilities are in statute miles or feet RVR, unless otherwise indicated.

Arrival Name	Number	STAR Computer Code	Superseded Number	Dated	Effective Date
RNTIN (RNAV)	ONE	RNTIN.RNTIN1	NONE	MM/DD/YYYY	MM/DD/YYYY

Title: Graphic Depiction 1

Remove Graphic	+
Insert Graphic	-

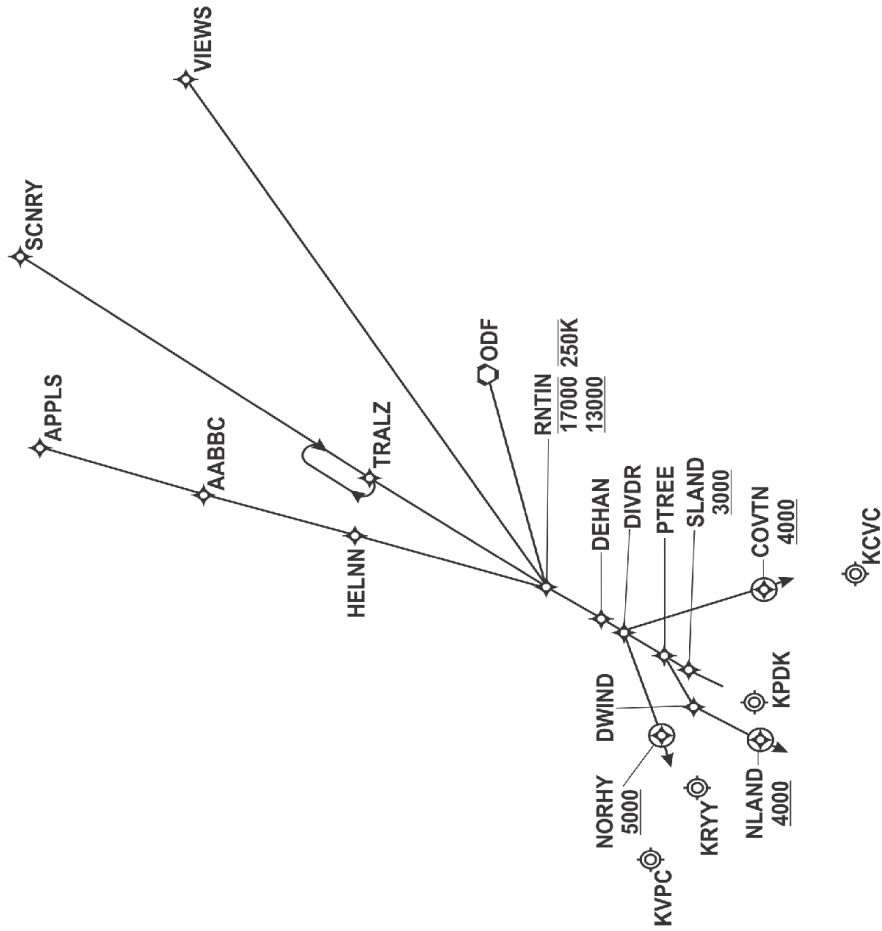



Figure 4-5-5. Form 8260-17.1 – STAR (Canceled)

FEDERAL AVIATION ADMINISTRATION  
FLIGHT STANDARDS SERVICE  
STANDARD TERMINAL ARRIVAL (STAR)

Bearings, headings, courses, tracks and radials are magnetic. Elevations and altitudes are in feet, MSL. Altitudes are minimum altitudes unless otherwise indicated. Ceilings are in feet above airport elevation. Distances are in nautical miles. Visibilities are in statute miles or feet RVR, unless otherwise indicated.

Arrival Name: EAGUL (RNAV)      Number: FIVE      STAR Computer Code:      Superseded Number:      Dated: MM/DD/YYYY      Effective Date: MM/DD/YYYY

TRANSITION ROUTES:

Transition Name	Transition Computer Code	From FIX/NAVAID	To FIX/NAVAID	Course	Distance	MEA	MOCA	MAA	Crossing Altitude/Fixes

ARRIVAL ROUTE DESCRIPTION:

**PROCEDURE CANCELED EFFECTIVE: MM/DD/YYYY**

PROCEDURAL DATA NOTES:

FIXES AND/OR HOLDING PATTERNS:

COMMUNICATIONS:

AIRPORTS SERVED:

AIRPORT NAME      CITY      STATE

LOST COMMUNICATIONS PREFERENCES:

REMARKS:

ADDITIONAL FLIGHT DATA:

**FEDERAL AVIATION ADMINISTRATION  
FLIGHT STANDARDS SERVICE  
STANDARD TERMINAL ARRIVAL (STAR)**

Bearings, headings, courses, tracks and radials are magnetic. Elevations and altitudes are in feet, MSL. Altitudes are minimum altitudes unless otherwise indicated. Ceilings are in feet above airport elevation. Distances are in nautical miles. Visibilities are in statute miles or feet RVR, unless otherwise indicated.

Arrival Name EAGUL (RNAV)      Number FIVE      STAR Computer Code Superseded Number      Dated MM/DD/YYYY      Effective Date MM/DD/YYYY

**FLIGHT INSPECTED BY:**

**ORGANIZATION:**      **DATE:**

Flight Inspected Signature:

**DEVELOPED BY:**

Developed By Signature:

**APPROVED BY:**

XXX-XXX

MM/DD/YYYY

Approved By Signature:

**CHANGES - REASONS:**

**FEDERAL AVIATION ADMINISTRATION  
FLIGHT STANDARDS SERVICE  
STANDARD TERMINAL ARRIVAL (STAR)**

Bearings, headings, courses, tracks and radials are magnetic. Elevations and altitudes are in feet, MSL. Altitudes are minimum altitudes unless otherwise indicated. Ceilings are in feet above airport elevation. Distances are in nautical miles. Visibilities are in statute miles or feet RVR, unless otherwise indicated.

Arrival Name EAGUL (RNAV) Number STAR Computer Code Superseded Number Dated Effective Date  
FIVE MM/DD/YYYY MM/DD/YYYY

Title:

Remove Graphic	+
Insert Graphic	-

THIS PAGE IS INTENTIONALLY LEFT BLANK

**4-5-4. Preparation of Form 8260-17.2, STAR (Data Record).****a. Title line.**

- (1) Enter the name of the STAR (i.e., LACEE RNAV or JOEHE RNP).
- (2) Number. Enter the STAR revision number spelled out (i.e., TWO).
- (3) STAR computer code. Enter the computer identification code.
- (4) Superseded number. STAR revision number superseded by this STAR. If original, insert "None."
- (5) Dated. Published or revision date of superseded STAR. Format: MM DD YYYY (i.e., 03/12/2009).
- (6) Effective date. Leave blank. The effective date will normally completed by NFDC. Enter an effective date only when a specific effective date is required (i.e., Magnetic Variation rotation). If the procedure is a "Special," enter "Special" on this line. Date Format: MM DD YYYY.

**b. Fix/NAVAID. Enter the name of the fix or navigational aid (NAVAID) as follows:**

- (1) Enter transition type prior to the first Fix or NAVAID for each transition type (i.e., En Route Transition, Common Route, or Runway Transition).
- (2) Enter the approved five-letter pronounceable name (i.e., CETUV).
- (3) Enter the three letter facility identification and type (i.e., OLM VORTAC).
- (4) For procedures with runway transitions, enter the transition runway in the final box after the last fix or NAVAID along with the ICAO airport code (i.e., KSEA: RWY34L).

**c. LAT/LONG.** Enter the latitude followed by the longitude (separated by a "/") associated with the item listed in in degrees, minutes, seconds, and hundredths of a second; i.e., 401900.22N / 0785030.21W. When using a VM or FM termination leave blank.

**d.** Enter a "Y" (yes) if the item in the Fix/NAVAID is to be charted. Enter an "N" (no), if charting is not required. When using a VM or FM termination leave blank.

**Note:** All fixes or NAVAIDs requiring a change in altitude speed or direction (heading), require charting.

- e. FO/FB.** Enter "FB" to indicate a fly-by waypoint or "FO" to indicate a fly-over waypoint.
- f. Leg type.** Enter the two-letter leg-type code (i.e., IF, TF, RF, DF, VM or FM).
- g. TC.** Enter the true course (TC) to the nearest hundredth of a degree (i.e., 164.12).

**h.** DIST. Enter the distance to the nearest hundredth of a nautical mile; i.e., 24.64. Do not enter distances for leg type ending in an “M.” e.g., FM, VM legs

**i.** Altitude. Enter the altitude rounded to the nearest 100 feet or flight level (FL) in 1000-foot increments. Label each altitude restriction with the appropriate indicator as listed in table 4-5-2.

**Table 4-5-2. Altitude Indicator**

Altitude Indicator	Example
AT/ABOVE	AT/ABOVE FL210
AT	AT 12000
AT/BELOW	AT/BELOW 5000
B	13000B17000

**j.** Speed. Enter speed restrictions where necessary for procedure containment or traffic flow requirements. Label each speed restriction with the appropriate indicator as listed in table 4-5-3 followed by K.

**Table 4-5-3. Speed Indicator**

Speed Indicator	Example
AT	AT 240K
AT/BELOW	AT/BELOW 280K

**k.** Remarks. Enter the en route transition computer code and any other pertinent information that would clarify the reason for a data entry.

- (1) Enter en route transition and common route computer code.
- (2) Enter RF leg radius, turn direction [clockwise (CW) or counter-clockwise (CCW)], arc center waypoint, and latitude/longitude; i.e., 7.5 NM RADIUS CCW ARCWP (474412.10N / 1222500.21W).
- (3) Reference NAVAID for CF and FM legs [see section 2-5], etc.

Figure 4-5-6. Form 8260-17.2 – STAR (Data Record)

FEDERAL AVIATION ADMINISTRATION  
FLIGHT STANDARDS SERVICE  
STAR (DATA RECORD)

Arrival Name	Number	STAR Computer Code	Superseded Number	Dated	Effective Date							
EAGUL (RNAV)	FIVE	EAGUL.EAGUL5	FOUR	MM/DD/YYYY	MM/DD/YYYY							
FIX/NAVAID	LAT/LONG	C	F	O	FB	TYPE	TC	DIST (NM)	ALTITUDE	SPEED	REMARKS	
En Route Transition												+
INW VORTAC	350341.76N/1104742.07W	Y				IF					INW.EAGUL5	-
EAGUL	340754.25N/1110457.74W	Y				TF	194.43	57.49	AT/ABOVE FL180 AT/BELOW FL230	AT 270K		+
En Route Transition												-
ZUN VORTAC	345756.71N/1090916.23W	Y				IF					ZUN.EAGUL5	+
DOJOE	344722.57N/1093809.16W	Y				TF	246.19	26.00				-
SLIDR	344227.42N/1095126.39W	Y				TF	245.91	12.00				+
TINIZ	342938.87N/1102538.95W	Y				TF	245.80	31.00	AT/BELOW FL330	AT 270K		-
PAYSO	342116.04N/1104742.05W	Y				TF	245.47	20.01	AT/ABOVE FL240 AT/BELOW FL280	AT 270K		+
EAGUL	340754.25N/1110457.74W	Y				TF	227.09	19.56	AT/ABOVE FL180 AT/BELOW FL230	AT 270K		-
Common Route												+
EAGUL	340754.25N/1110457.74W	Y				IF			AT/ABOVE FL180 AT/BELOW FL230	AT 270K	EAGUL.EAGUL5	-
HOMRR	335249.72N/112416.01W	Y				TF	214.93	22.00	AT/BELOW 16000	AT 250K		+
Runway Transition												-
HOMRR	335249.72N/112416.01W	Y				IF			AT/BELOW 16000	AT 250K		+

FEDERAL AVIATION ADMINISTRATION  
FLIGHT STANDARDS SERVICE  
STAR (DATA RECORD)

Arrival Name EAGUL (RNAV)		Number FIVE		STAR Computer Code EAGUL.EAGUL5		Superseded Number FOUR		Dated MM/DD/YYYY		Effective Date MM/DD/YYYY	
FIX/NAVAID	LAT/LONG	C	FO/FB	LEG TYPE	TC	DIST (NM)	ALTITUDE	SPEED	REMARKS		
SMAAK	335034.02N/112832.92W	Y	FB	TF	237.68	04.22	AT/ABOVE 14000 AT/BELOW 15000	AT 250K			+
GENNO	334309.59N/114238.37W	Y	FB	TF	237.87	13.88	AT 10000	AT 250K			+
QUENY	333820.03N/115511.74W	Y	FB	TF	237.03	12.50	AT 9000	AT 210K			+
HINEY	333130.40N/1120427.13W	Y	FB	TF	238.12	09.11	AT 7000	AT 210K			+
OBASE	333132.53N/1121203.56W	Y	FB	TF	270.35	06.36					+
BASBL	333133.43N/1121853.33W		FO	TF	270.18	05.71			REFERENCE MAGVAR: KPHX 12E/2015		+
KPHX: RWY 08				FM	270.20						+
Runway Transition											+
HOMRR	335249.72B/112416.01W	Y		IF			AT/BELOW 16000	AT 250K			+
VNNOM	334930.20N/112707.51W	Y	FB	TF	215.66	04.08	AT/ABOVE 10000 AT/BELOW 11000	AT 250K			+
ESDEE	333838.66N/113627.09W	Y	FB	TF	215.71	13.31	AT/ABOVE 8500 AT/BELOW 10000	AT 250K			+
BASSL	333333.95N/114042.04W	Y	FB	TF	215.02	06.19	AT/ABOVE 6000 AT/BELOW 8000	AT 210K			+
DERVL	332804.92N/1144519.77W	Y	B	TF	215.28	06.70	AT/ABOVE 5100	AT 210K			+
JAGAL	332625.74N/114846.39W	Y	FB	TF	240.22	03.32	AT/ABOVE 4500				+
KPHX: RWY 26											+



Figure 4-5-7. Form 8260-17.2 – STAR (Data Record)

FEDERAL AVIATION ADMINISTRATION  
FLIGHT STANDARDS SERVICE  
STAR (DATA RECORD)

Arrival Name		Number		STAR Computer Code		Superseded Number		Dated		Effective Date	
COMPT (RNAV)		ONE		OLM.COMPT		NONE		MM/DD/YYYY		MM/DD/YYYY	
FIX/NAVAID	LAT/LONG	C	F	LEG TYPE	TC	DIST (NM)	ALTITUDE	SPEED	REMARKS		
En Route Transition											+
BTG VORTAC	454452.12N/1223529.53W	Y		IF					BTG.COMPT1		+
MALAY	462521.99N/1224539.29W	Y		TF	350.16	41.12	AT/ABOVE FL 210				+
TONNO	464146.95N/1224950.85W	Y		TF	350.03	16.68					+
OLM VORTAC	465817.90N/1225406.60W	Y		TF	349.98	16.78	AT/ABOVE 14000 AT/BELOW 17000	AT/BELOW 280K			+
En Route Transition											+
CETUV	4635559.91N/1232120.75W	Y		IF					CETUV.COMPT1		+
OLM VORTAC	465817.90N/1225406.60W	Y		TF	039.83	29.12	AT/ABOVE 14000 AT/BELOW 17000	AT/BELOW 280K			+
Common Route											+
OLM VORTAC	465817.90N/1225406.60W	Y		IF			AT/ABOVE 14000 AT/BELOW 17000	AT/BELOW 280K	OLM.COMPT1		+
LACEE	470249.33N/1224821.23W	Y		TF	041.00	06.00					+
COMPT	470935.92N/1223941.35W	Y		TF	041.07	09.00					+
Runway Transition											+
COMPT	470935.92N/1223941.35W	Y		IF							+
ARVAD	471321.49N/1223451.60W	Y		TF	041.18	05.00	AT 12000	AT 250K			+

FEDERAL AVIATION ADMINISTRATION  
FLIGHT STANDARDS SERVICE  
STAR (DATA RECORD)

Arrival Name		Number		STAR Computer Code		Superseded Number		Dated		Effective Date	
COMPT (RNAV)		ONE		OLM.COMPT		NONE		MM/DD/YYYY		MM/DD/YYYY	
FIX/NAVAID	LAT/LONG	C	FO/FB	LEG TYPE	TC	DIST (NM)	ALTITUDE	SPEED	REMARKS		
FOURT	471751.95N/1222902.93W	Y	FB	TF	041.24	06.00					+
RWYEP	474358.51N/1223102.17W	Y	FB	RF	357.06	26.16	AT 6000	AT 210K			+
WATEL	474425.08N/1221855.79W	Y	FB	RF		12.82			4.11 NM RADIUS CW ARCWP (4744412.10N/1222500.21W)		-
AGANE	474131.46N/1221857.28W	Y	FB	TF	180.33	02.90					+
KSEA: RWY 16											-
Runway Transition											+
COMPT	470935.92N/12223941.35W	Y		IF							-
ARVAD	471321.49N/1223451.60W	Y	FB	TF	041.18	05.00	AT 12000	AT 250K			+
FOURT	471751.95N/1222902.93W	Y	FB	TF	041.24	06.00					-
BECHR	471808.51N/1222144.07W	Y	FO	TF	086.78	04.99					+
KSEA: RWY 34L, 34C, and 34R				VM	067.00						-

FEDERAL AVIATION ADMINISTRATION  
FLIGHT STANDARDS SERVICE  
STAR (DATA RECORD)

Arrival Name		Number		STAR Computer Code		Superseded Number		Dated		Effective Date	
RNTIN (RNAV)		ONE		RNTIN.RNTIN1		NONE		MM/DD/YYYY		MM/DD/YYYY	
FIX/NAVAID	LAT/LONG	C	FO/FB	LEG TYPE	TC	DIST (NM)	ALTITUDE	SPEED	REMARKS		
En Route Transition											+
APPLS	355431.07N / 0834021.17W	Y		IF					APPLS.RNTIN1		+
AABBC	352646.57N / 0834641.05W	Y	FB	TF	190.58	28.18					+
HELNN	350055.11N / 0835209.85W	Y	FB	TF	189.89	26.20					+
RNTIN	342849.16N / 0835903.45W	Y	FB	TF	190.08	32.55	13000B17000	AT/BELOW 250K			+
En Route Transition											-
ODF VORTAC	344145.14N / 0831751.58W	Y		IF					ODF.RNTIN1		+
RNTIN	342849.16N / 0835903.45W	Y	FB	TF	249.41	36.38	13000B17000	AT/BELOW 250K			+
En Route Transition											-
SCNRY	360030.95N / 0830300.24W	Y		IF					SCNRY.RNTIN1		+
TRALZ	345930.79N / 0834031.59W	Y	FB	TF	206.88	68.18					+
RNTIN	342849.16N / 0835903.45W	Y	FB	TF	206.58	34.24	13000B17000	AT/BELOW 250K			+
En Route Transition											-
VIEWS	353549.52N / 0822450.69W	Y		IF					VIEWS.RNTIN1		+
RNTIN	342849.16 / 0835903.45W	Y	FB	TF	229.60	102.27	13000B17000	AT/BELOW 250K			+

FEDERAL AVIATION ADMINISTRATION  
FLIGHT STANDARDS SERVICE  
STAR (DATA RECORD)

Arrival Name		Number		STAR Computer Code		Superseded Number		Dated		Effective Date	
RNTIN (RNAV)		ONE		RNTIN.RNTIN1		NONE		MM/DD/YYYY		MM/DD/YYYY	
FIX/NAVAID	LAT/LONG	C	FO/FB	LEG TYPE	TC	DIST (NM)	ALTITUDE	SPEED	REMARKS		
Common Route											+
RNTIN	342849.16N / 0835903.45W	Y		IF			13000B17000	AT/BELOW 250K	LANDING KPDK RNTIN.RNTIN1		+
DEHAN	341900.25N / 0840418.09W	Y	FB	TF	203.91	10.72					+
DIVDR	341527.62N / 0840605.84W	Y	FB	TF	202.82	03.84					+
PTREE	340810.24N / 0841032.15W	Y	FB	TF	206.86	08.16					+
Common Route											+
RNTIN	342849.16N / 0835903.45W	Y		IF			13000B17000	AT/BELOW 250K	LANDING KVPC RNTIN.RNTIN1		+
DEHAN	341900.25N / 0840418.09W	Y	FB	TF	203.91	10.72					+
DIVDR	341527.62N / 0840605.84W	Y	FB	TF	202.82	03.84					+
COVTN	335247.75N / 0835527.56W	Y	FO	TF	158.61	24.29	AT/ABOVE 4000				+
KVVC				FM	156.56				RECOMMENDED NAVAID. PDK VOR/DME		+
Common Route											+
RNTIN	342849.16N / 0835903.45W	Y		IF			13000B17000	AT/BELOW 250K	LANDING KVPC RNTIN.RNTIN1		+
DEHAN	341900.25N / 0840418.09W	Y	FB	TF	203.91	10.72					+
DIVDR	341527.62N / 0840605.84W	Y	FB	TF	202.82	03.84					+

FEDERAL AVIATION ADMINISTRATION  
FLIGHT STANDARDS SERVICE  
STAR (DATA RECORD)

Arrival Name RNTIN (RNAV)	Number ONE	STAR Computer Code RNTIN.RNTIN1	Superseded Number NONE	Dated MM/DD/YYYY	Effective Date MM/DD/YYYY				
FIX/NAVAID	LAT/LONG	C	FO/FB	TYPE	TC	DIST (NM)	ALTITUDE	SPEED	REMARKS
NORPHY	340722.94N / 0842615.24W	Y	FO	TF	244.35	18.56	AT/BELOW 5000		
KRYV.KVPC				FM	249.50				RECOMMENDED NAVAID: PDK VOR/DME
Runway Transition									
PTREE	340810.24N / 0841032.15W	Y		IF					
DWIND	340244.65N / 0842000.08W	Y	FB	TF	235.48	09.55			
NLAND	335117.57N / 0842506.38W	Y	FO	TF	200.40	12.19	AT/ABOVE 4000		
KPK: RWY 03, RWY 03				FM	200.40				RECOMMENDED NAVAID: PDK VOR/DME
Runway Transition									
PTREE	340810.24N / 0841032.15W	Y		IF					
SLAND	340405.00N / 0841251.71W	Y	FB	TF	205.34	04.51	AT/ABOVE 3000		
KPK: RWY 21, RWY 21									

THIS PAGE IS INTENTIONALLY LEFT BLANK

## Section 4-6. RNAV Procedure Development

**4-6-1. General.** This section contains supplementary guidance for the development of RNAV instrument procedures. RTCA DO-201A, Standards for Aeronautical Information, has established operational requirements and standards that aviation authorities, procedure designers, and airspace planners must consider when developing en route, arrival, approach, departure, and aerodrome environments. This guidance provides a standardized method of processing RNAV instrument procedures using information from this RTCA document.

**4-6-2. RNAV Approach Procedure design.** Criteria for the development of RNAV instrument procedures can be found in Order 8260.58 and other related 8260-series orders.

**a.** All RNAV instrument approach procedures *should* be connected to the en route airway system in order to provide a seamless transition into the Terminal Area. Accomplish this by one of the following methods:

**Note:** This policy is recommended but not required and may not be practicable for helicopter procedures.

(1) Establish a feeder route from the en route airway to initial approach fixes (IAFs) not on an airway.

(2) Extend the “T” leg initial segment to place the IAF on an en route airway. Do not extend the “T” leg more than 10 nautical miles from the intermediate fix.

(3) Use a modified form of the basic “T” (L or I) or a route type approach.

(4) Establish a Terminal Arrival Area (TAA) as prescribed in Order 8260.58, chapter 2.

(5) In lieu of the above, use a STAR that terminates at an IAF or IAF/IF.

**b.** The RNAV procedure should, whenever and wherever possible, match the ILS at the same runway in the following respects: final and intermediate segment procedure ground track, missed approach, altitudes, fix locations/names, GPAs, and TCHs. Nothing in this policy requires an RNAV procedure to emulate a procedure turn used on an underlying ILS procedure. Due to the many variables involved in procedure design, especially relating to the very different aspects of ILS and RNAV design, it is impractical to set standards for all possible ILS/RNAV designs; therefore, in lieu of hard and fast design standards, use the following design guidelines:

(1) When designing an RNAV procedure at an ILS equipped runway, the RNAV procedure should emulate the ILS procedure to the maximum extent possible. In other words, if the ILS needs updating (i.e., PFAF placement to meet new/current standards), publish updated ILS and RNAV procedures concurrently. In emulating an ILS, do not include either a basic “T” or TAA in the RNAV IAP unless specifically requested by Air Traffic.

(2) If the ILS PFAF occurs at the LOC FAF, emulation of the ILS by the RNAV procedure may be a simple matter. In this case, the RNAV PFAF can be placed at the LOC FAF location and thus coincidence will have been achieved for the ILS PFAF, LOC FAF, and RNAV

PFAF. Use the LOC FAF name for the RNAV PFAF name. Revising the ILS procedure will, in all likelihood, not be necessary.

(3) For a variety of reasons, the situation described in paragraph 4-6-2.b(2) is seldom found in practice. Where the ILS PFAF is not collocated with the existing LOC FAF, the associated LOC portion of the ILS procedure may have to be revised at the same time the new RNAV IAP is developed.

(a) If the present LOC FAF is defined by DME, intersection or radar, revise the ILS procedure by relocating the LOC FAF to coincide with the RNAV PFAF which can be placed at the vertical descent angle interception point for the given ILS glide slope angle/TCH and LOC FAF altitude. Use the LOC FAF name for the RNAV PFAF name.

(b) If the present LOC FAF is defined by a facility such as an OM or locator outer marker (LOM) and localizer DME is available, define the LOC FAF using DME and collocate the LOC FAF and RNAV PFAF as in the option of paragraph 4-6-2.b(3)(a). If possible, retain the present facility name for use at the LOC/RNAV FAF.

c. Establish an LNAV FAF for all new RNAV procedures at a location that will support a collocated PFAF for future RNP, LNAV/VNAV, and/or WAAS/GBAS procedures.

d. RNAV RNP procedures may be designed to support minimums with different RNP values in the final approach segment. The largest RNP value is the one that will be coded into the avionics database (pilots will have the ability to enter the lower values if their equipment permits).

e. ILS and/or LOC procedures may be combined with RNAV (GPS) procedures provided the additional requirements established in paragraph 8-2-2.c are met. This will permit use of an ILS/LOC with the same ground track as the RNAV (GPS) procedure. When combining procedures, consideration must be given to the number of lines of minima that are possible and the potential human factors implications.

**Note:** There are also options to publish separate ILS/LOC approaches using strictly conventional criteria, using strictly RNAV criteria for initial, intermediate, and missed approach segments, or using a combination of both conventional and RNAV “Initial segment” criteria. A Terminal Arrival Area (TAA) must not be used on ILS/LOC procedures containing a conventional missed approach. See paragraphs 8-6-3 for TAA instructions and 8-6-8 for chart annotations.

(1) Procedure naming will be in accordance with Order 8260.3, paragraph 1-6-2.

(2) No more than five lines of minima can be published. For example, the following are several of possible options:



S-ILS 36	S-ILS 36	S-ILS 36
LPV DA	LNAV/VNAV DA	LNAV MDA
LNAV/VNAV DA	LNAV MDA	CIRCLING
LNAV MDA		CIRCLING
CIRCLING		

#### 4-6-3. Developing RNAV waypoint.

**a.** In establishing the position of a waypoint fix, determine which category of fix will best meet the airspace, route of flight, obstacle clearance, and operational requirements. Fly-by and fly-over fixes are the two basic types of waypoint fixes that are used in transitioning from one route segment to another when conducting instrument approach, en route arrival, or departure procedures.

(1) Fly-by (FB) waypoint fixes identify a position where a change in course occurs from one specified route segment to another. Turn anticipation is required and expected as the aircraft executes the turn maneuver. The FB waypoint fix is the most desired and useful type for use in RNAV procedure design due to the conservation of airspace. Unless otherwise required by the procedure design, all waypoint fixes defining a course change must be coded in the navigation database as FB.

(2) Fly-over (FO) waypoint fixes may or may not identify a change in course from one specified route segment to another. Turn anticipation is not permitted. FO fixes require substantially more airspace to protect for the turn than FB fixes, and should be used only where special design problems necessitate.

**b.** FAA 8260-series forms must document waypoint type for all waypoint fixes used in RNAV procedure design. Because of the different obstacle assessments conducted, FO and FB information is critical to flight crews and should be consistently displayed on aeronautical charts and in navigational databases. The waypoint type (FO/FB) is documented on Forms 8260-3/5/7A as applicable [see paragraph 8-6-4.a(6)].

**c.** En route. Do *not* establish RNAV WPs at NAS en route facilities. Do *not* establish RNAV WPs at conventional en route fixes when used as feeder fixes for RNAV procedures.

**d.** Terminal. Develop terminal use RNAV WPs based on usage as follows:

(1) Missed approach point. Normally the MAP is at the threshold but may be located prior to the threshold, on or off runway centerline.

(2) MAP located at threshold. The landing threshold is contained in the runway file in the RNAV database. Do *not* document a MAP located at the landing threshold on a Form 8260-2.

(a) MAP not located at threshold. The landing threshold will be the reference point. True bearing is from reference point to MAP. If the MAP is on runway centerline extended, use the reciprocal of the landing runway true bearing. Distance is from reference point to MAP.

- (3) Final approach fix. Establish the location of the FAF as a true bearing and distance as follows:
  - (a) Final approach course aligned through threshold. Use landing threshold as reference point.
  - (b) Final approach course not aligned through threshold. Use MAP as reference point.
- (4) Intermediate fix (IF). Establish the location of the IF as a true bearing and distance as follows:
  - (a) No course change at FAF. Utilize the same reference point used to establish the FAF.
  - (b) Course change at the FAF. Use the FAF as the reference point.
- (5) Initial approach fix. Establish the location of the IAF as a true bearing and distance as follows:
  - (a) No course change at the IF or FAF. Utilize the same reference point used to establish the FAF.
  - (b) No course change at the IF, with a course change at the FAF. Use the FAF as the reference point.
  - (c) Course change at the IF. Use the IF as the reference point.
- (6) Feeder fix. If a WP is required for use as a feeder fix, and will *not* be an en route fix, establish the location of the feeder fix as a true bearing and distance as follows:
  - (a) No course change at the IAF. Utilize the same reference point used to establish the IAF.
  - (b) Course change at the IAF. Use the IAF as the reference point.
- (7) Missed approach. For all WPs in the missed approach, after the MAP, use the preceding WP as the reference point.
- (8) Stepdown fixes within segments. Establish the location of waypoints used as stepdown fix(es) within a segment as a bearing and distance *from* the waypoint/fix that marks the beginning of the next segment in the procedure sequence (e.g., IAF, IF, FAF, etc.). For example, the forward true bearing from IF to IAF is 290.34 degrees. Establish the coordinates for stepdown fix waypoints on bearing 290.34 degrees from the IF at the desired distance(s) between the IF and IAF.

**Note:** Use this method to determine stepdown fixes in *all* segments.

**4-6-4. RNAV leg types.**

**a.** Different types of arrival, approach, departure, and en route segments are required for RNAV. Consideration of these requirements during procedure design will result in a more efficiently designed flight path for all operators using airspace; particularly those equipped with computer-based navigation systems. These systems require encoding RNAV route segment flight paths into a format usable in navigation databases.

**b.** The aviation industry has adopted a route segment definition called “path and terminator.” This concept is used for transforming arrival, approach, and departure procedures into coded flight paths that can be interpreted and used by a computer-based navigation system. A path terminator instructs the aircraft to navigate from a starting point along a defined path to a specified point or terminating condition. The path terminators are identified by a set of two alpha-characters, each of which has a meaning when describing a flight maneuver to a navigation computer. The first character indicates the types of flight path to be flown, and the second indicates where the route segment terminates. For example, a designated route from a NAVAID to a fix would be coded as “TF.” The “T” indicates that a track is to be flown, and the “F” indicates that the segment terminates at a fix. There are over twenty different path and terminator sets (“leg types”) used by the aviation industry to accommodate the coding of procedure route segments. However, only a limited few are suitable for use in RNAV procedure design.

**4-6-5. RNAV leg type descriptions.**

**a.** Initial fix. This is the point or fix where a flight segment begins. An IF is not a route segment and does not define a desired track in and of itself. It is used in conjunction with other leg types such as a TF leg in order to define the desired segment.

**Note:** “IF” in this context is not to be confused with IAF or IF; however, it may be located at one of these locations for coding purposes.

**b.** Track-to-fix (TF) leg. This designates a track or geodesic path between two fixes. If the TF leg is the first route segment of a flight path, the TF leg begins at an IF; otherwise, the first fix of the TF leg is the termination fix of the previous route segment. The TF leg is the primary straight route segment for RNAV.

**c.** Constant radius to a fix (RF) leg. An RF leg defines a curved path route segment about a defined turn center that terminates at a fix. The RF leg begins at the termination fix of the previous route segment. The previous segment is tangent to the arc of the RF leg at that fix. Waypoints defining the beginning *and* end point of the RF turn must be designated as “Fly-by.”

**d.** Course-to-altitude (CA) leg. A CA leg defines a specified path terminating at an altitude. A CA leg must specify a course and altitude. See Order 8260.58 for conditions when use of a CA leg required.

**e.** Direct-to-fix (DF) leg. A DF leg is used to define a route segment (geodesic path) that begins at an aircraft present position, or unspecified position, and extends to a specified fix.

**f.** Heading-to-an-altitude (VA) leg. The VA leg is used in a departure route segment where a heading rather than a track has been specified for climb. The VA segment terminates at a specified altitude without a terminating position defined.

**g.** Course-to-fix (CF) leg. The CF leg is defined as a magnetic course that terminates at a fix.

**h.** Heading to a manual termination (VM) leg. A VM leg is a manual termination leg used for whenever a departure or arrival route description specifies a course or heading to fly in expectation of a radar vector.

**i.** Heading to an intercept (VI) leg. A VI leg defines a specified heading to intercept the subsequent leg at an unspecified position.

**j.** Fix to a manual termination (FM) leg. A course from a fix to a manual termination leg used in departure or arrival procedures when a route segment is expected to be terminated by radar vectors.

#### **4-6-6. Final Approach Segment (FAS) data.**

**a.** FAS data is described and attained using established TERPS criteria in Order 8260.58, chapter 3. This data is compiled and formed into what is called the FAS data block. The method of protection required for this flight data is known as the cyclic redundancy check (CRC).

**b.** Document FAS data block information on either Form 8260-3 or 8260-7A, whichever is applicable. Guidance on producing data that are placed on this form is located in appendix L.

**c.** FAS data block coordinates must be in same coordinate system as the ground survey data (WGS-84 preferred).

**4-6-7. Remote altimeter setting for Baro-VNAV.** Baro-VNAV systems cannot fly to approach minimums based on a remote altimeter setting. Therefore, when the *primary* altimeter source is from a remote location, LNAV/VNAV is not authorized to be flown using Baro-VNAV. When the primary altimeter source is local and a *secondary* altimeter source is remote, LNAV/VNAV minimums must be noted as not authorized (NA) to be flown with Baro-VNAV when the secondary altimeter is in use. See paragraph 8-6-9.e(8) for applicable chart note to use.

**4-6-8. Critical temperature.** Temperature limits above and below which Baro-VNAV operations are not authorized are published on RNAV instrument approach procedures. Current RNAV criteria standards provide the formulas to compute the critical temperatures for the airport of intended landing. See paragraphs 8-6-9.s and 8-7-1.c(10) for charting and documentation requirements.

#### **4-6-9. DME/DME screening model.**

**a.** Apply the RNAV-Pro DME screening model to ensure satisfactory availability and geometry of DME navigation signals for RNAV arrivals, instrument approaches (when requested) and departure procedures, and RNAV “Q” routes to support use of FMS-equipped

aircraft that are DME/DME capable. A valid DME/DME coverage prediction tool (e.g., RNAV-Pro) may be used in lieu of flight inspection for coverage verification on procedure and route segments at and above FL 180. Below FL 180, a valid DME/DME coverage prediction tool and flight inspection is required [see Order 8200.1 for more detailed information regarding flight inspection requirements].

**b.** The AIRNAV database is continually updated and NAVAID facility locations, which are identified via latitude, longitude, and elevation, periodically change due to survey updates or physical relocation. Differences between NAVAID facility locations identified in RNAV-Pro results and the AIRNAV database during procedure development are acceptable if within the following tolerance limits:

- (1) A 300-foot or less difference in NAVAID facility latitude/longitude; and
- (2) A 75-foot or less difference in NAVAID facility elevation.

**4-6-10. Additional documentation with Baro-VNAV (LNAV/VNAV and RNP), GBAS, and/or WAAS Instrument Approach Procedures.**

**a.** Enter a 5-digit WAAS/GBAS channel number into the Additional Flight Data block of the 8260-series form [see paragraph 8-6-10.j(2)]. A block of WAAS channel numbers is allocated to the Aeronautical Information Services by the National Flight Data Center. GBAS channel numbers must be calculated using a specific frequency that is currently obtained from Region Spectrum Management Office. This paragraph does not apply to RNAV RNP procedures.

**b.** Enter approach ID, e.g., W09A/G18A into the Additional Flight Data block of the 8260-series forms [see paragraph 8-6-10.j(2)]. This is the same as the Reference Path Identifier described in appendix L and is part of the FAS data block. This paragraph does not apply to RNAV RNP procedures.

**c.** Enter “Critical Temp” data as specified in paragraph 4-6-8.

**d.** Due to limited WAAS coverage at certain locations, a restriction may be required on procedures where WAAS can be used for vertical navigation on a procedure containing LNAV/VNAV minima. This restriction is portrayed on the instrument procedure chart with a negative-type “W” icon that signifies WAAS signal outages may occur daily and that these outages will not appear in a NOTAM. At locations where LNAV/VNAV minima are published and it has been determined that there is no WAAS coverage whatsoever, a note will be placed on the approach plate that reads “WAAS VNAV NA.” Document this in the “Notes” section of the Form 8260-3/7A as: “Chart note: WAAS VNAV NA.”

**e.** Document the applicable performance based navigation (PBN), navigation specification (NavSpec) required on the chart. See paragraph 8-6-8.b.

**f.** Document the RNP value (e.g., RNP 1.0 or RNP 0.15) used for each segment (except the final segment) in the “To” block of the “Terminal Routes” section on Form 8260-3 [see paragraph 8-6-4.a(6)]. Additionally, when the RNP for feeder, initial and/or intermediate

segments are less than standard (RNP 2.0 for feeder, RNP 1.0 for initial and/or intermediate), a note stating the required RNP value must be placed adjacent to the applicable fix at the beginning of the Feeder Route for less than standard RNP along the route to the IAF only; or IAF (IF, if there is not an Initial segment prior to the IF) for less than standard RNP from the IAF (or IF) to the PFAF. If there is more than one RNP value within these portions of the procedure, the lowest RNP value is to be charted at the beginning fix. Document this in the “Notes” section of Form 8260-3. Use “Chart planview note at (fix name): (RNP 0.X or 0.XX).”

**g.** RNAV speed restrictions [see Order 8260.58, chapter 1] must be noted on the chart. Use “Chart speed icon in planview at LUCIG: Max 190 KIAS.” For an RF turn, specify the point where the restriction starts and the point at which the restriction is no longer required. Use “Chart planview note at NILCI: Max 200 KIAS until HIVUD.” A speed restriction that applies to the missed approach procedure will be specified in parenthesis at the beginning of the missed approach instructions [see paragraph 8-6-6.d(11)] and must not appear in the planview of the chart.

**h.** Certain RNAV equipped aircraft may not be capable of flying procedures that contain RF turns, so the entire procedure or segment of the procedure must be annotated with a “RF required” to alert the pilot of this limitation. Use either the note specified in paragraph 4-6-10.h(1) or 4-6-10.h(2):

(1) Use “Chart PBN requirement note: RF Required” when *one* of the following conditions exist:

- (a) Single Intermediate fix.
  - 1. ALL terminal routes leading to the intermediate fix require an RF turn.
  - 2. The intermediate, final, or missed approach segments require an RF turn.
- (b) Multiple intermediate fixes.
  - 1. ALL terminal routes leading to the PFAF require an RF turn.
  - 2. The final or missed approach segment requires an RF turn.

OR

(2) If an RNAV procedure can be flown from an IAF without RF turns in any segment (including missed approach) and there are RF turns required when initiating the approach from other IAFs on the chart, a note must be placed adjacent to the IAF(s) affected. Use “Chart planview note adjacent to (name) IAF: RF Required.”

**i.** RNP criteria require a wing (semi) span value for narrow and wide body aircraft to be used when calculating the vertical error budget (VEB). When the narrow body value is used, a note must be placed on the approach chart to alert the pilot of this limitation. Use “Chart note: Procedure NA for aircraft with wingspan greater than 136 feet.”

## Chapter 5. Airspace

### Section 5-1. Obstruction Evaluation (OE)

**5-1-1. General.** 14 CFR part 77 requires that the Administrator be notified prior to the construction or alteration of structures that might present a hazard to flight. Form 7460-1, Notice of Proposed Construction or Alteration, is the medium for that notification of construction or alteration.

**5-1-2. Responsibility and processing of Form 7460-1.** The Obstruction Evaluation Group, AJV-15, has the responsibility to process all Forms 7460-1 in accordance with 14 CFR part 77 and Order JO 7400.2. In this regard, Aeronautical Information Services must ensure a complete evaluation of the effect the proposed construction or alteration will have on IFR procedures, including the visual portion of a final approach segment, is provided to Air Traffic. The complete evaluation includes evaluation of the effect upon existing and proposed instrument flight procedures and the effects of airport plans on file to instrument flight procedures as they relate to the proposed object. Aeronautical Information Services must also assist Air Traffic in reconciling possible discrepancies in IFR findings made by the military services. Aeronautical Information Services must limit their response to findings of “IFR Effect” or “No IFR Effect.” The process of an obstacle evaluation is captured within the Internet Obstacle Evaluation/Airport Airspace Analysis (iOE/AAA) system. All comments and evaluations should be captured within this system to ensure consideration.

**5-1-3. Review of Notices.** Aeronautical Information Services and Flight Standards Service personnel, when becoming involved in the evaluation of Notices of Construction or Alteration, should be thoroughly familiar with applicable parts of Order JO 7400.2. The AWO evaluates OE cases for effect in accordance with the Code of Federal Regulations and policies set forth in Order 8900.1, Flight Standards Information Management Systems (FSIMS); 8260-series orders; Order JO 7400.2, and other applicable directives. The effect of a proposed structure on aircraft operations must be fully stated. Consultation with the appropriate FSDO and/or FIOG may be helpful in formulating comments/recommendations. In all cases, the primary responsibility and the first consideration is set forth in 14 CFR part 77, which states: “Evaluate the effect of the proposed construction or alteration on safety in air commerce and the efficient use and preservation of the navigable airspace and of airport traffic capacity at public use airports” [see 14 CFR part 77.5].

**5-1-4. Adjustments to Instrument Flight Procedures.** When requested, Flight Standards specialists may provide recommendations regarding what procedure adjustments to mitigate the effect. Aeronautical Information Services will be notified of when construction will begin and appropriate action (e.g., NOTAM action) will be initiated. Aeronautical Information Services must not amend a procedure until receipt of the “Actual Notice of Construction,” or other notification relative to an obstacle that will have a procedural effect.

## Section 5-2. Designation of Controlled Airspace

### 5-2-1. General.

a. To afford separation from other aircraft, all instrument flight procedures, to include the TAA, must be contained in controlled airspace to the maximum extent possible within the capabilities of the ATC system. For special procedures, refer to paragraph 4-1-3.e.

b. Order JO 7400.2 clarifies that a 300-foot buffer should be taken into consideration when computing airspace requirements for IFR procedures. Therefore, a 300-foot buffer has been included in the references to the 1000-foot and 1500-foot points in paragraph 5-2-4.

**5-2-2. Air Traffic responsibility.** It is the responsibility of the applicable Air Traffic Service Area to determine the type and amount of controlled airspace that can be established to encompass instrument flight procedures, including departures from the airport.

a. If the TAA overlies class B airspace, in whole or in part, the ATC facility exercising control responsibility for the airspace may recommend minimum TAA sector altitudes. It is the responsibility of the ATC facility providing approach control service for the airport to resolve TAA altitude and overlapping airspace issues with adjoining ATC facilities. Modify the TAA to accommodate controlled/restricted/warning areas as appropriate.

b. When notified that an RNAV approach and a standard TAA are being initiated for an airport not underlying controlled airspace, the applicable Air Traffic Service Area must initiate rulemaking action to establish a 1200 feet above ground level class E airspace area with an appropriate radius of the ARP to accommodate the TAA. If a modified TAA is proposed, the airspace will be sized to contain the TAA. The TAA will not be charted or implemented until controlled airspace actions are completed.

### 5-2-3. Aeronautical Information Services action.

a. Determine airspace requirements for all original IAPs. Analyze IAP amendments, which affect any fix, course, or altitude to determine if existing airspace must be extended or can be reduced. Similarly, analyze IAP cancellations to determine if existing airspace can be reduced. Aeronautical Information Services must coordinate with the applicable Air Traffic Control facility to determine if further procedure development needs to be delayed pending any airspace action.

b. Aeronautical Information Services analysis, in accordance with the provisions of this section, must include, in part, a determination of the minimum required length and width of the class B/C/D/E surface area extensions, and/or any class E 700-foot airspace extension.

c. Document data, as described in paragraph 5-2-4.k, on the Form 8260-9, Standard Instrument Approach Procedure Data Record, supports the IAP being designed. See paragraph 8-7-1.e "Part d: Airspace" for forms completion guidance. Forward this data to the appropriate Air Traffic Service Area.



**Note:** This information must also be submitted to the Air Traffic Service Area by any acceptable method for processing. However, to avoid loss of historical data, it is still required that Aeronautical Information Services make the entry in Form 8260-9, “Part D: Airspace,” for permanent record.

**5-2-4. Terminal airspace.** The following criteria must be used to determine the required minimum length and width of class B/C/D/E surface area and/or class E 700-foot airspace extensions.

- a. The requirement to designate controlled airspace is contained in Order JO 7400.2.
- b. The nearest 100-foot principle must be applied to determine the height of the controlling terrain.

**Example:** A terrain elevation of 249.99 feet MSL would be considered as 200 feet; 250.00 feet MSL as 300 feet.

**Note:** Use of the following computation methods *must* consider the primary area of all applicable segments of any IAP under analysis. Any arrival extensions must be the result of “worst-case scenario” analyses, reflecting the greatest amount of controlled airspace required.

- c. Class B/C/D/E surface area extensions. Establish an extension of the class B/C/D/E surface area whenever an IAP authorizes descent to an altitude less than 1000 feet above the surface at a point outside the basic surface area. Where multiple approach procedures are established utilizing the same approach course, the extension length and/or width must be based on the approach, or approach combinations, requiring the greatest length and/or width respectively. When designing instrument procedures at airports with class B airspace, it is important to note the requirements of Order JO 7400.2, paragraph 15-2-3, which states that the class B vertical limit “...*may be adjusted to coincide with runway alignment, adjacent airports, other regulatory airspace, etc., but must encompass, as a minimum, all final approach fixes and minimum altitudes at the final approach fix.*” This requirement includes the glide slope/glide path intercept point for vertically guided procedures. Any deviation to this requirement must be approved by Airspace Services, AJV-1.

(1) Procedures with vertical guidance. Where ILS, WAAS (LPV), GBAS, LNAV/VNAV, etc. procedures are involved, the 1000-foot point is established as follows:

- (a) Determine the elevation of the highest terrain in the final approach (primary area, or the “W” and “X” surfaces, as appropriate).
- (b) Add 1000 feet to the terrain as described in figure 5-2-1. and subtract the MSL elevation of the TCH.
- (c) Divide the result by the GS tangent using formula 5-2-1.

**Formula 5-2-1.**

$$d = \frac{a - (b + c) + 1000}{\tan(\theta)}$$

Where:

a = highest terrain

b = THRe

c = TCH

$\theta$  = Glidepath Angle

d = Dist (feet) THR to 1000-foot point

**Example 5-2-1.**

$$22896.39 = \frac{500 - (250 + 50) + 1000}{.05241}$$

$$22896.39 = 3.77\text{NM} = 1000 \text{ feet}$$

**Note:** To compute the 1500-foot point, substitute 1500 for 1000 in formula 5-2-1.

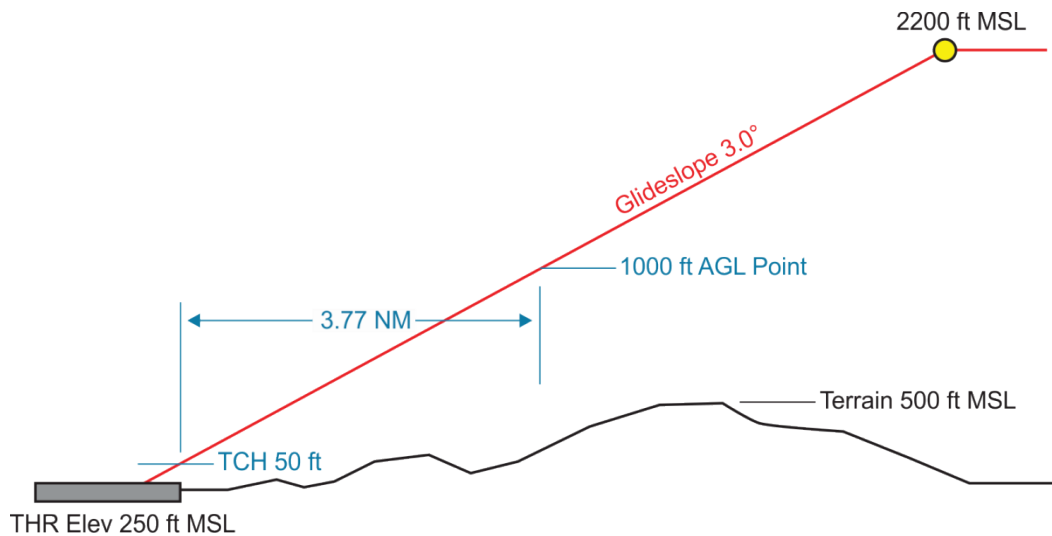
**Figure 5-2-1.**

(d) When the GS (or EL) is inoperative, the altitude for flying the LOC-only (or AZ-only) may require an additional class B/C/D/E surface area extension. Therefore, the 1000-foot point for LOC-only (or AZ-only) should be determined in the same manner as for nonprecision SIAPs [see paragraphs 5-2-4.c(2) through 5-2-4.c(4)].

(e) To locate a 1000-foot point in a segment prior to the FAF, apply the provisions of paragraphs 5-2-4.c(2) through 5-2-4.c(5).

(2) Nonprecision approach procedures (NoPT w/FAF):

(a) When the SIAP specifies a minimum altitude at the FAF greater than 1000 feet above the highest terrain in the final segment, the 1000-foot point is assumed to be inbound from the FAF at a distance determined by application of a descent gradient of 500 ft/NM for distances in excess of 7 NM from runway threshold, and 300 ft/NM for distances at/less than 7 NM from the runway threshold; i.e., use both gradients to compute the 1000-foot point when the final segment is longer than 7 NM [see figure 5-2-2 and figure 5-2-3].

**Example 5-2-2.**

1000 feet AGL + 200 feet Terrain = 1200 feet MSL  
 2100 feet MSL - 1200 feet = 900 feet  
 900 feet / 300 feet/NM = 3 NM  
 7(FAF) - 3 = 4 NM = 1000-foot Point

**Figure 5-2-2.**

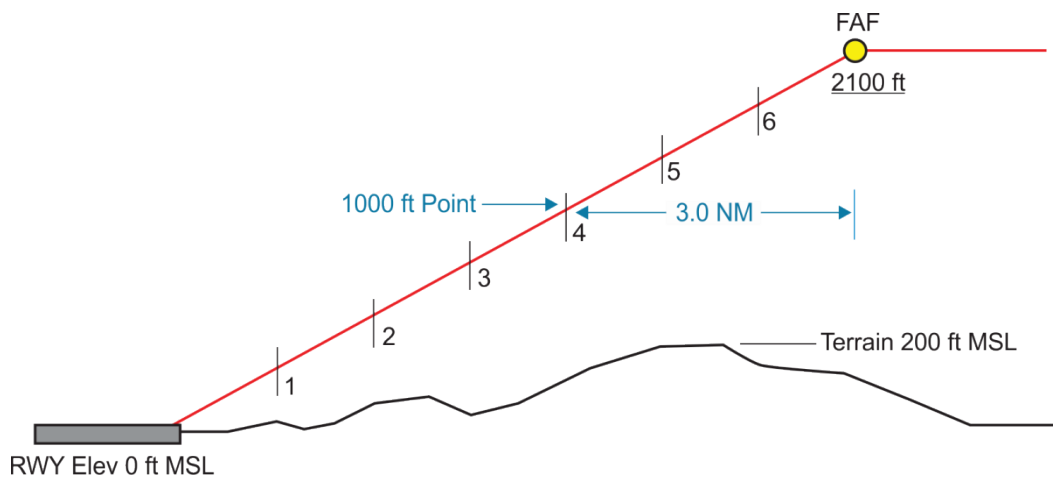

**Example 5-2-3.**

$1000 \text{ feet AGL} + 500 \text{ feet Terrain} = 1500 \text{ feet MSL}$   
 $3000 \text{ feet MSL} - 1500 \text{ feet} = 1500 \text{ feet}$   
 $9(\text{FAF}) - 7 = 2 \text{ NM} \times 500 \text{ feet per NM} = 1000 \text{ feet}$   
 $1500 \text{ feet} - 1000 \text{ feet} / 300 \text{ feet per NM} = 1.67 \text{ NM}$   
 $7 \text{ NM} - 1.67 \text{ NM} = 5.33 \text{ NM} = 1000\text{-foot Point}$

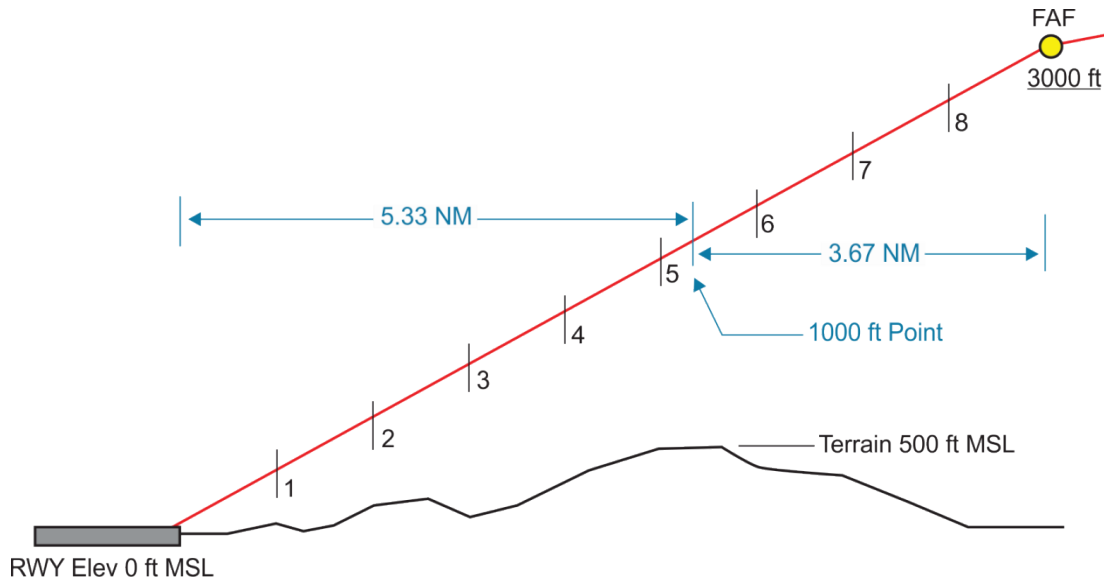
**Figure 5-2-3.**

(b) When the SIAP specifies a minimum altitude at the IF greater than 1000 feet above the highest terrain in the intermediate segment, the 1000-foot point is assumed to be inbound from the IF at a distance determined by application of a 500 ft/NM descent from the IF [see figure 5-2-4].

**Example 5-2-4.**

$1000 \text{ feet AGL} + 1000 \text{ feet Terrain} = 2000 \text{ feet MSL}$   
 $3500 \text{ feet (IF)} - 2000 \text{ feet} = 1500 \text{ feet}$   
 $1500 \text{ feet} / 500 \text{ feet per NM} = 3 \text{ NM}$   
 $11 \text{ NM} - 3 \text{ NM} = 8 \text{ NM} = 1000\text{-foot Point}$

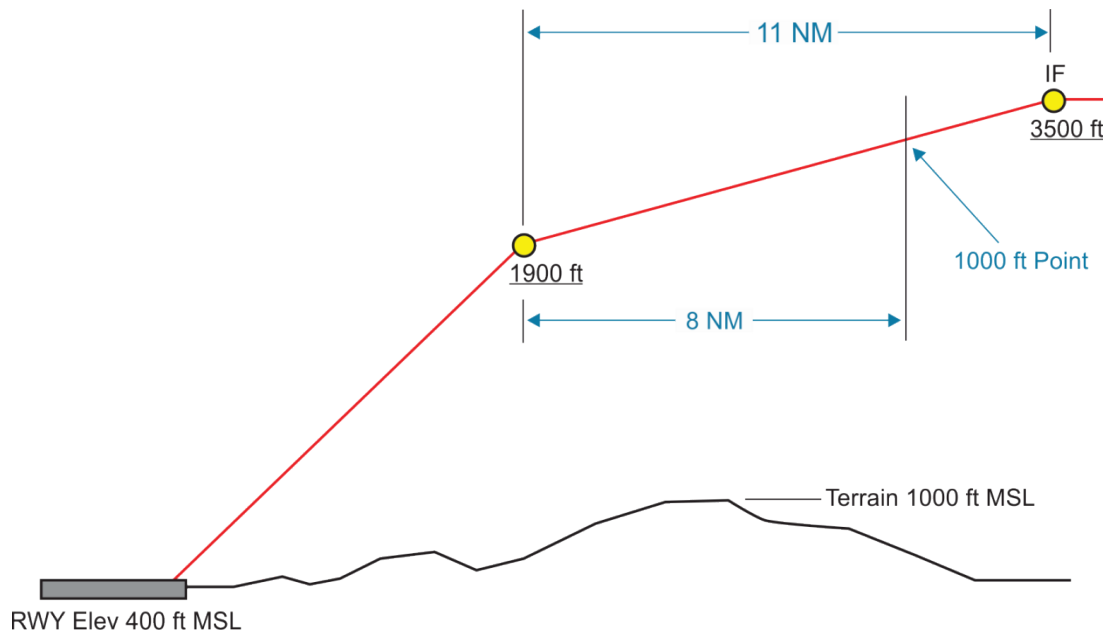
**Figure 5-2-4.**

## (3) Nonprecision approach procedures with procedure turn (PT):

(a) Procedure turn over facility (on-airport, no-FAF): Where a facility is located on the airport (NDB, VOR, VORTAC) and the SIAP does not incorporate FAF, the 1000-foot point is assumed to be on the PT inbound leg, 7 NM from the facility for a 10 NM PT, or 5 NM from the facility for a 5 NM PT [see figure 5-2-5].

Figure 5-2-5.

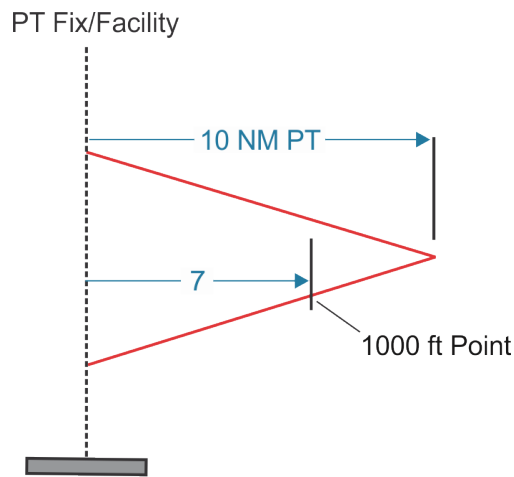

(b) PT over FAF:

1. When the SIAP specifies a minimum altitude at the FAF less than 1000 feet above the highest terrain in the intermediate segment, the 1000-foot point is assumed to be 7 NM outside the FAF on the PT inbound leg for a 10 NM PT, and 5 NM on the PT inbound leg for a 5 NM PT [see figure 5-2-6].

Figure 5-2-6.

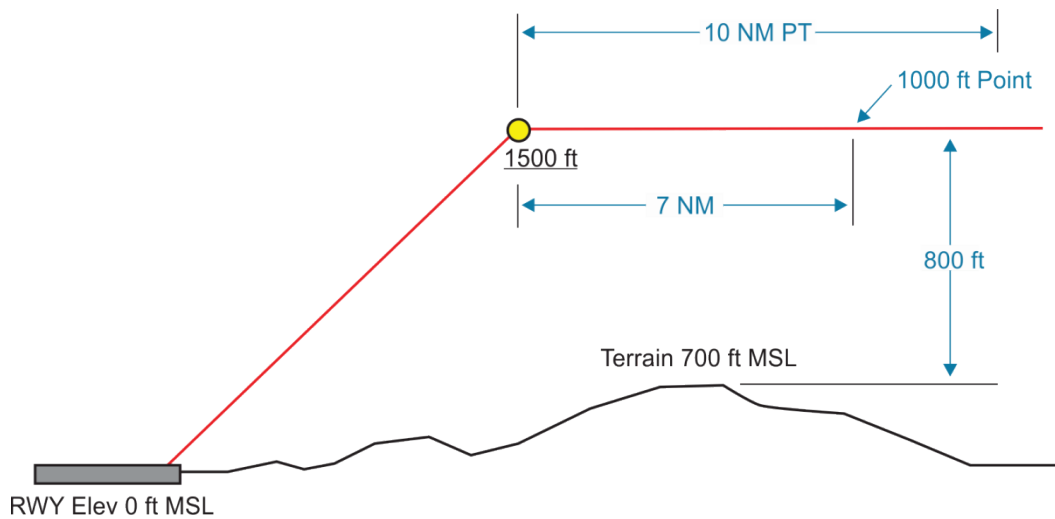

2. When the SIAP specifies a minimum altitude at the FAF less than 1000 feet above the highest terrain in the final segment, *but* greater than 1000 feet above the highest terrain in the intermediate segment, establish the 1000-foot point at the FAF.

3. When the SIAP specifies a minimum altitude at the FAF greater than 1000 feet above the highest terrain in the final segment, establish the 1000-foot point as per paragraph 5-2-4.(2)(a).

(c) PT over facility/stepdown fix *after* the FAF:

1. Where the SIAP specifies a minimum altitude at the FAF less than 1000 feet above the highest terrain in the intermediate segment, the 1000-foot point is assumed to be outside the FAF on the PT inbound leg at a distance determined by application of a 200 ft/NM descent to the FAF [see figure 5-2-7].

**Example 5-2-5.**

1000 feet AGL + 600 feet Terrain = 1600 feet MSL

1600 feet - 1100 feet (FAF) = 500 feet

500 feet / 200 feet per NM = 2.5 NM

5 NM (FAF) + 2.5 = 7.5 NM = 1000-foot Point

**Figure 5-2-7.**

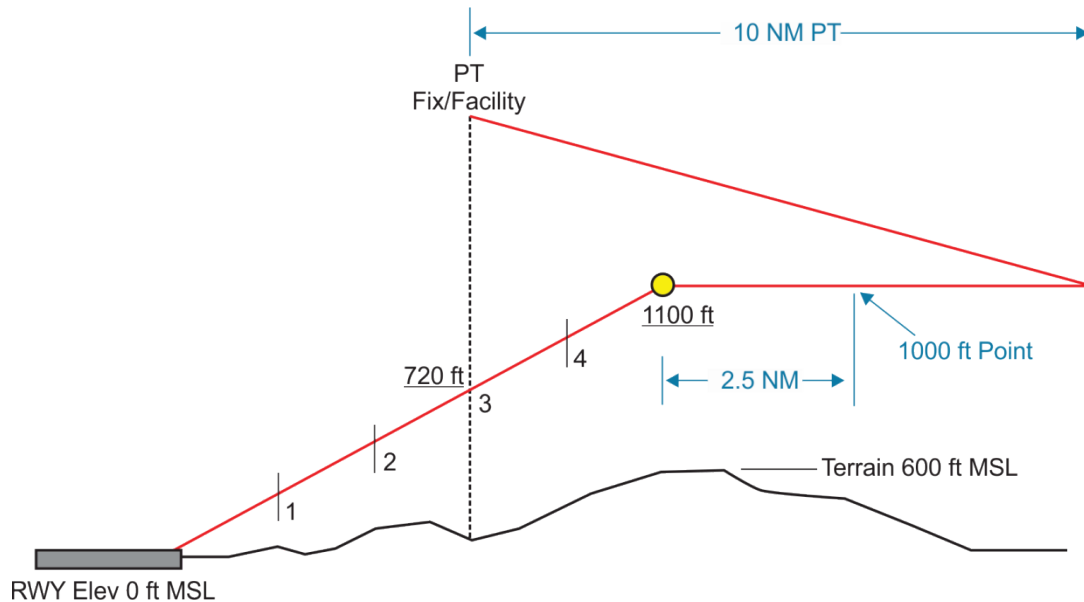

2. Where the SIAP specifies a minimum altitude at the final stepdown fix less than 1000 feet above the highest terrain in the final segment, while specifying a minimum altitude at the FAF greater than 1000 feet above the highest terrain in the intermediate segment, the 1000-foot point is assumed to be inbound from the FAF at a distance determined by application of a 300 ft/NM descent gradient from the FAF. Use 500 ft/NM descent gradient for the distance that the FAF exceeds 7 NM from the threshold [see figure 5-2-8].

**Example 5-2-6.**

$1000 \text{ feet AGL} + 670 \text{ feet Terrain} = 1670 \text{ feet MSL}$   
 $2000 \text{ feet (FAF)} - 15670 \text{ feet} = 330 \text{ feet}$   
 $330 \text{ feet} / 300 \text{ feet per NM} = 1.1 \text{ NM}$   
 $5 \text{ NM (FAF)} - 1.1 \text{ NM} = 3.9 \text{ NM} = 1000\text{-foot Point}$

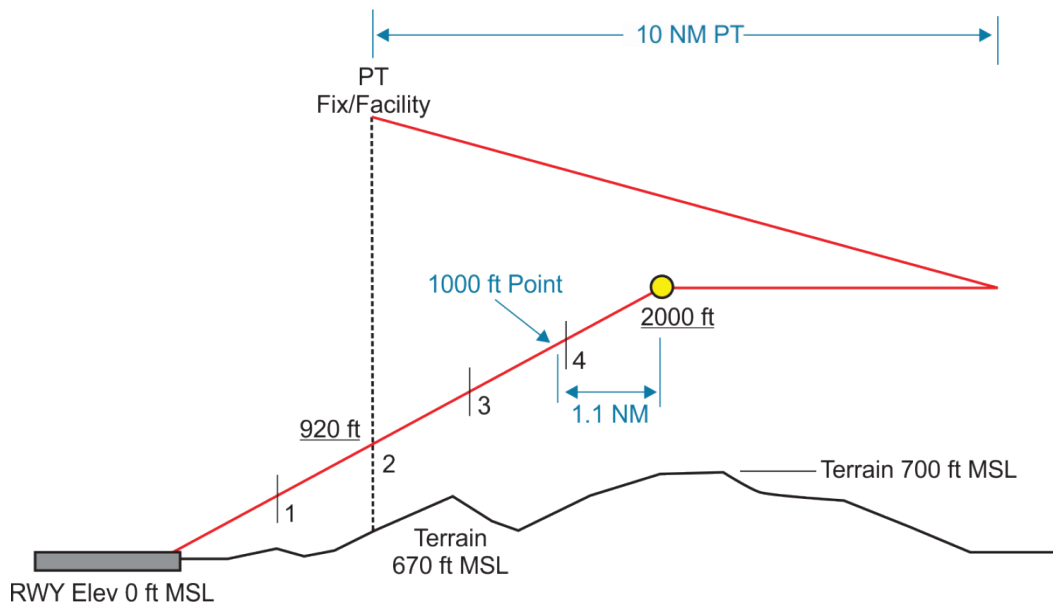
**Figure 5-2-8.**

3. Where the SIAP specifies a minimum altitude at the final stepdown fix greater than 1000 feet above the highest terrain in the final segment, the 1000-foot point is assumed to be inbound from the final stepdown fix at a distance determined by application of a 300 ft/NM descent gradient from the final stepdown fix. Use 500 ft/NM descent gradient for the distance that the stepdown fix exceeds 7 NM from the threshold [see figure 5-2-9].



**Example 5-2-7.**

$1000 \text{ feet AGL} + 300 \text{ feet Terrain} = 1300 \text{ feet MSL}$   
 $1700 \text{ feet (Stepdown)} - 1300 \text{ feet} = 400 \text{ feet}$   
 $400 \text{ feet} / 300 \text{ feet per NM} = 1.3 \text{ NM}$   
 $5 \text{ NM (S/D)} - 1.3 \text{ NM} = 3.7 \text{ NM} = 1000\text{-foot Point}$

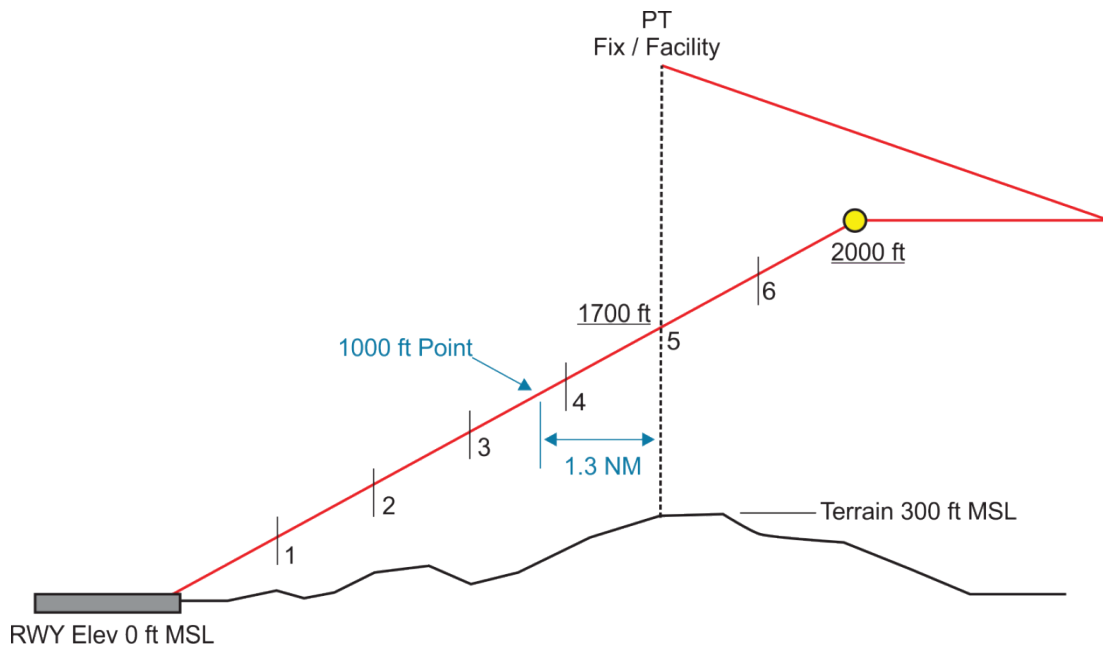
**Figure 5-2-9.**

(d) PT over stepdown *prior* to the FAF:

**Condition:** Distance between the stepdown fix/facility and the FAF less than 5 NM [see Order 8260.3].

1. If the PT completion altitude is equal to or greater than, *but* the minimum altitude at the stepdown fix/facility is less than 1000 feet above the highest terrain in the segment underlying the course reversal, the 1000-foot point is assumed to be 7 NM from the stepdown fix/facility on the PT inbound leg [see figure 5-2-10].

Figure 5-2-10.

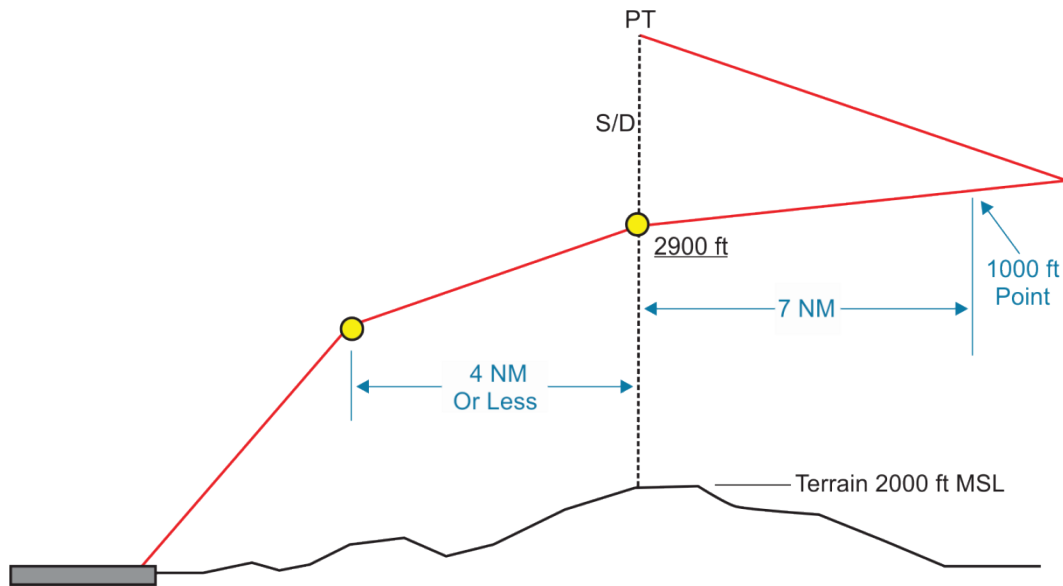

2. If the minimum altitude at the stepdown fix/facility is greater than 1000 feet above the highest terrain in the segment between the fix/facility and the FAF, the 1000-foot point is assumed to be inbound from the fix/facility at a distance determined by application of a 300 ft/NM descent from the stepdown fix/facility [see figure 5-2-11].

**Example 5-2-8.**

$1000 \text{ feet AGL} + 2000 \text{ feet Terrain} = 3000 \text{ feet MSL}$   
 $3100 \text{ feet (Stepdown)} - 3000 \text{ feet} = 100 \text{ feet}$   
 $100 \text{ feet} / 300 \text{ feet per NM} = 0.3 \text{ NM}$   
 $4 \text{ NM (S/D)} - 0.3 \text{ NM} = 3.7 \text{ NM} = 1000\text{-foot Point}$

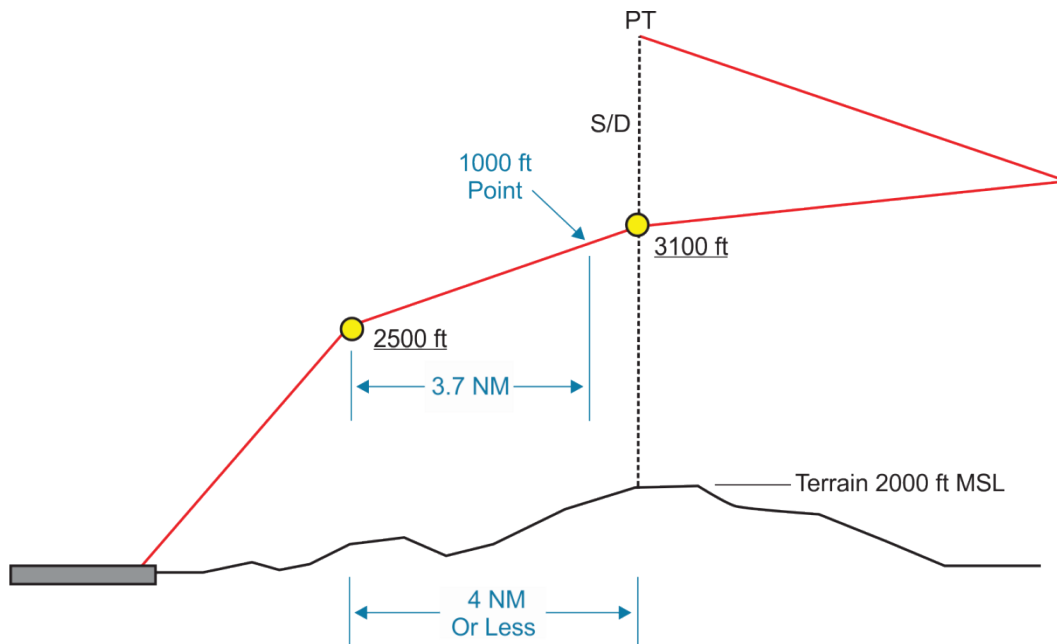
**Figure 5-2-11.**

3. If the 1000-foot point is inside the FAF, apply methodology in paragraph 5-2-4.(2)(a).

**Condition:** Distance between the stepdown fix/facility and the FAF greater than 5 NM [see Order 8260.3]. Since the fix/facility becomes the IF in this case, apply methodology in paragraph 5-2-4.c(3)(e).

**Note:** Where the distance between the stepdown fix/facility and the FAF equals 5 NM, Order 8260.3 chapter 2 may be applied; use the appropriate guidance above or below accordingly.

(e) PT over the IF (intermediate fix).

1. If the PT completion altitude is less than 1000 feet above the highest terrain in the segment underlying the course reversal, the 1000-foot point is in the PT maneuvering area.

2. If the PT completion altitude is greater than or equal to 1000 feet above the highest terrain in the segment underlying the course reversal, the 1000-foot point is assumed to be 7 NM from the PT fix/facility on the PT inbound leg [see figure 5-2-12].

Figure 5-2-12.

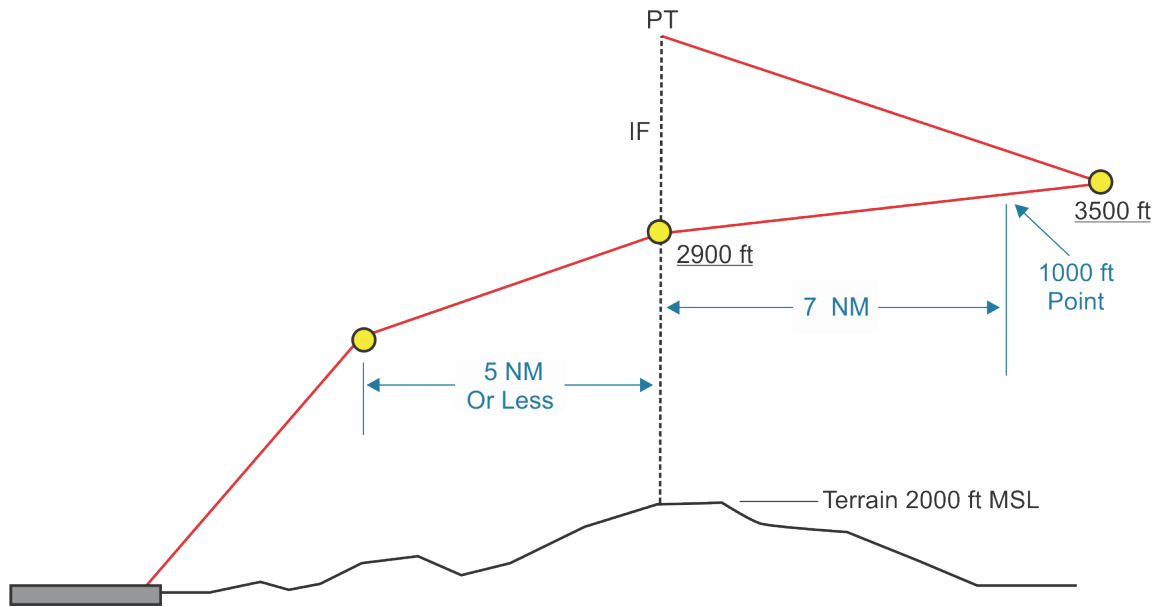

3. If the minimum altitude at the IF is greater than 1000 feet above the highest terrain in the segment underlying the course reversal, *but* less than or equal to 1000 feet above the highest terrain in the intermediate segment, the 1000-foot point is at the IF [see figure 5-2-13].

Figure 5-2-13.

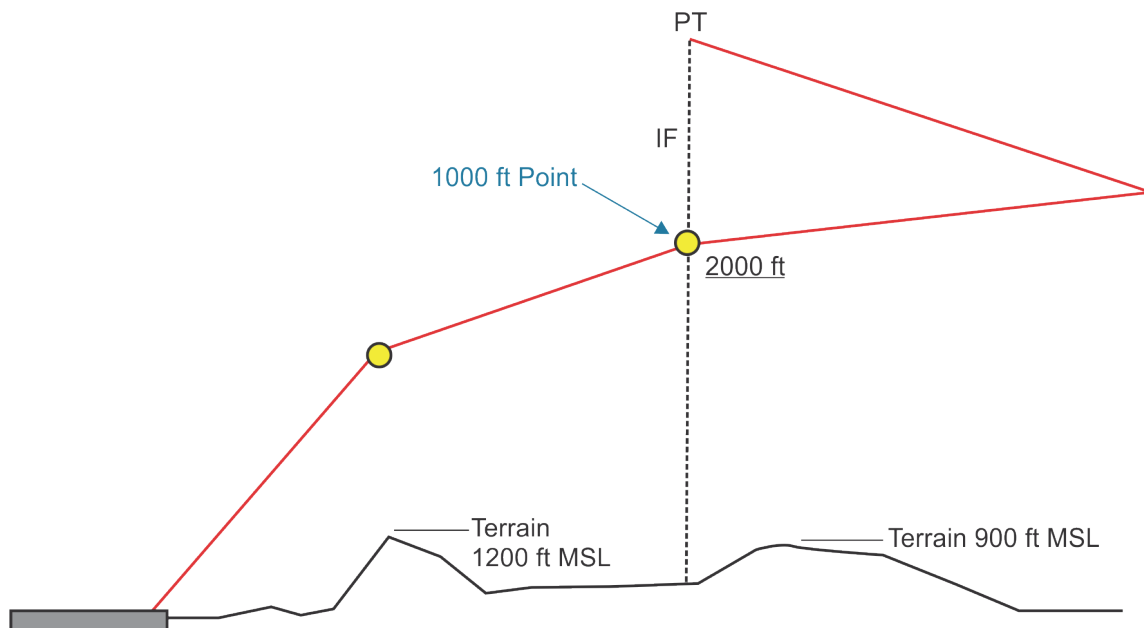

4. If the minimum altitude at the IF is greater than 1000 feet above the highest terrain in the intermediate segment, the 1000-foot point is assumed to be inbound from the IF at a distance determined by application of a 500 ft/NM descent from the IF [see figure 5-2-14].

**Example 5-2-9.**

1000 feet AGL + 2000 feet Terrain = 3000 feet MSL  
 3500 feet (IF) - 3000 feet = 500 feet  
 500 feet / 500 feet per NM = 1 NM  
 6 NM (S/D) - 1 NM = 5 NM = 1000-foot Point

**Figure 5-2-14.**

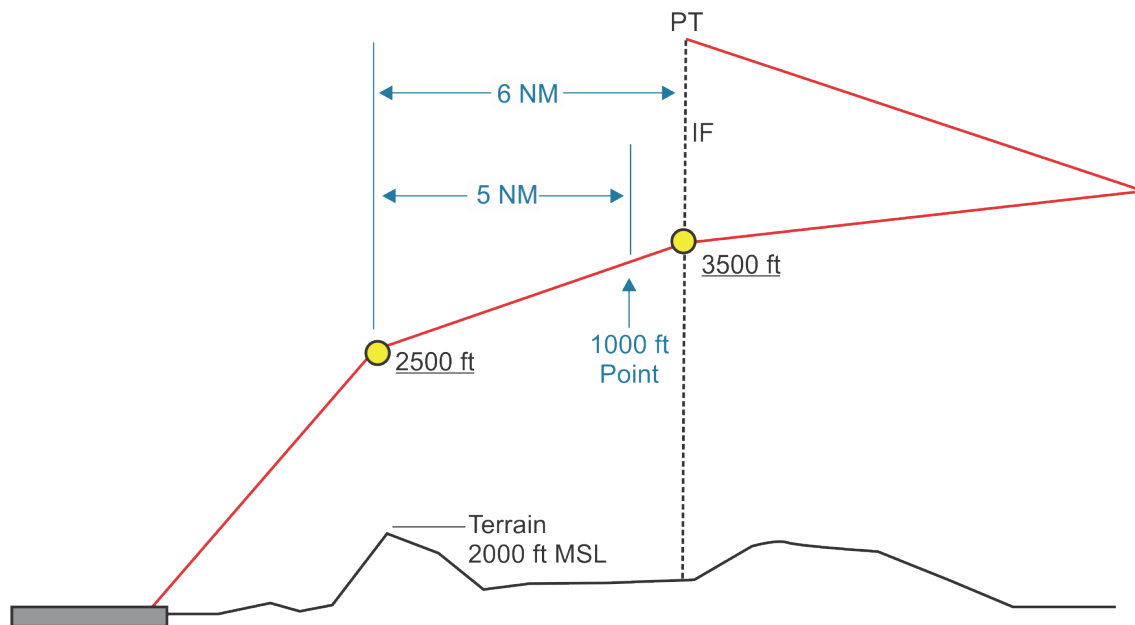

5. If the 1000-foot point is inside the FAF, apply methodology in paragraph 5-2-4.c(2)(a).

(4) Hold-in-lieu-of PT:

(a) At the FAF:

1. If the minimum altitude at the FAF is 1000 feet above the highest terrain in the final segment, the 1000-foot point is at the FAF [see figure 5-2-15].

Figure 5-2-15.

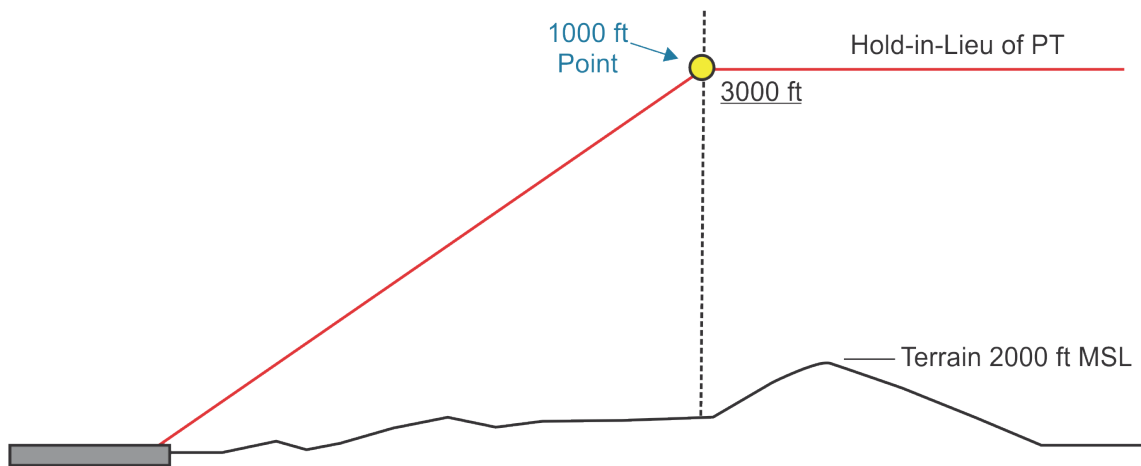

2. If the minimum altitude at the FAF is greater than 1000 feet above the highest terrain in the final segment, apply the methodology in paragraph 5-2-4.c(2)(a).

3. If the minimum hold-in-lieu-of PT altitude is equal to or greater than 1000 feet above the highest terrain underlying the course reversal, *but* the minimum altitude at the FAF is less than 1000 feet above the highest terrain underlying the course reversal, the 1000-foot point is assumed to be in the holding pattern area. The class B/C/D/E surface Area extension must encompass the entire holding pattern primary area [see figure 5-2-16].

Figure 5-2-16.

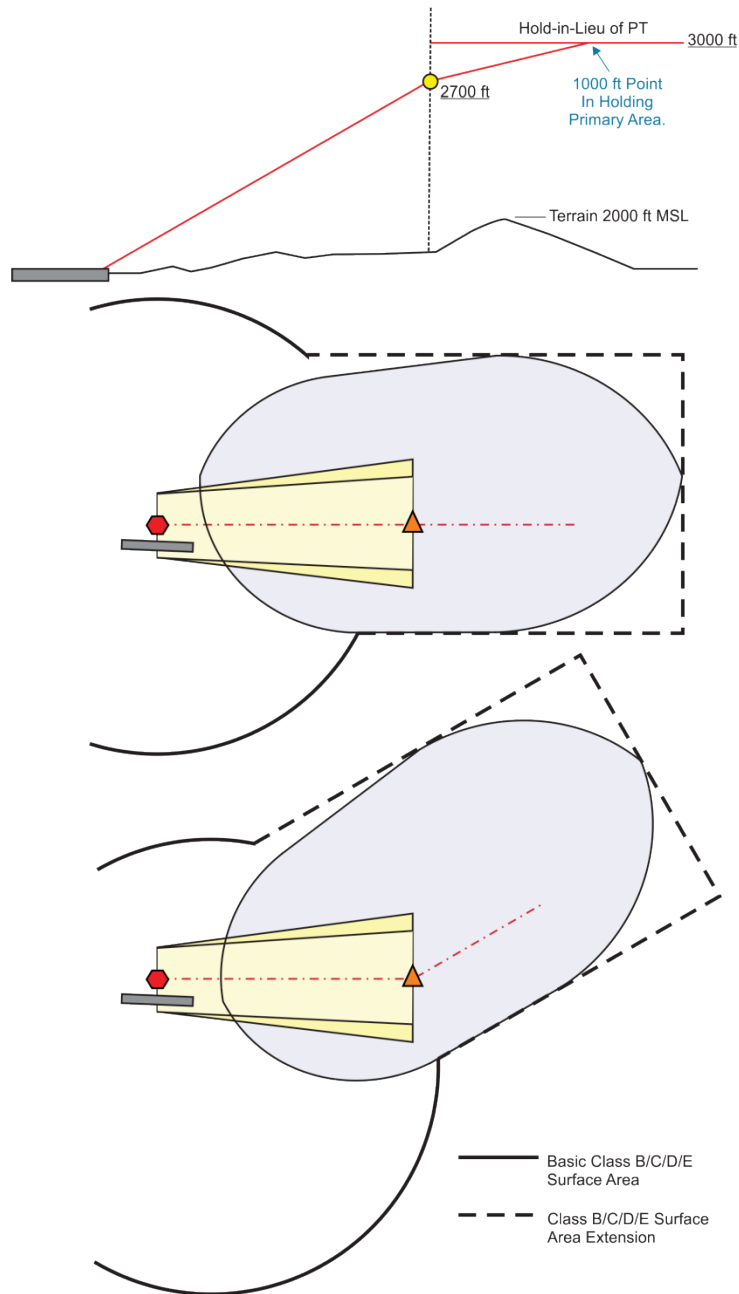

(b) At the IF.

1. If the minimum altitude at the IF is less than or equal to 1000 feet above the highest terrain in the intermediate segment, the 1000-foot point is at the IF [see figure 5-2-17].

**Figure 5-2-17.**

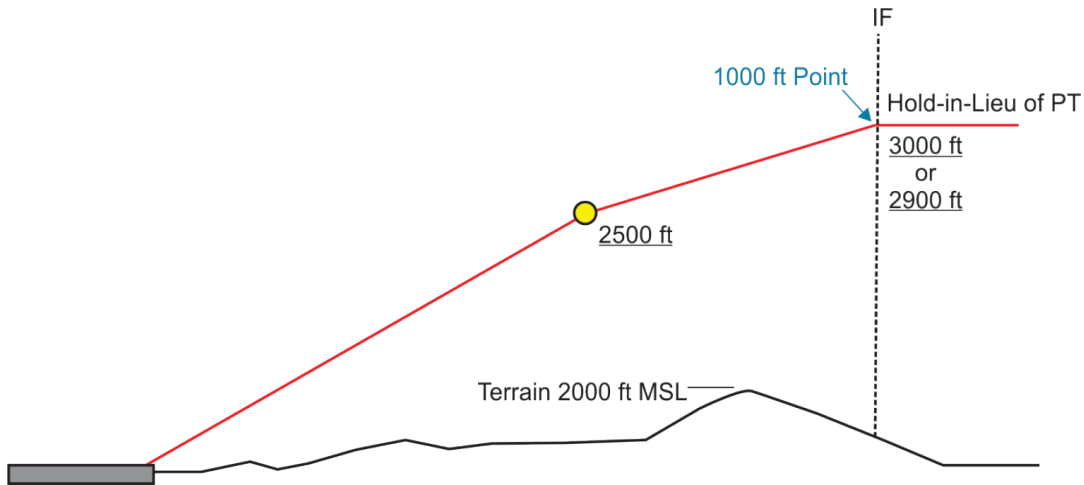

2. If the minimum altitude at the IF is greater than 1000 feet above the highest terrain in the intermediate segment, the 1000-foot point is assumed to be inbound from the IF at a distance determined by application of a 500 ft/NM descent from the IF [see figure 5-2-18].

**Example 5-2-10.**

$$\begin{aligned}
 &1000 \text{ feet AGL} + 2000 \text{ feet Terrain} = 3000 \text{ feet MSL} \\
 &3100 \text{ feet (IF)} - 3000 \text{ feet} = 100 \text{ feet} \\
 &100 \text{ feet} / 500 \text{ feet per NM} = 0.2 \text{ NM} \\
 &5 \text{ NM (IF)} - 0.2 = 4.8 \text{ NM} = 1000\text{-foot Point}
 \end{aligned}$$

**Figure 5-2-18.**

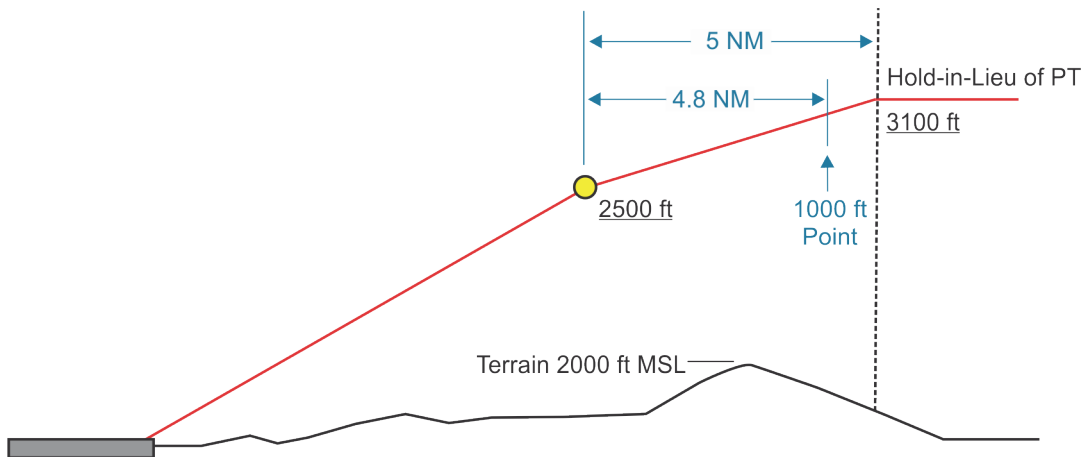

3. If the minimum altitude at the IF *and* at the FAF are greater than 1000 feet above the highest terrain in the intermediate segment, apply the methodology in paragraph 5-2-4c(2).



(5) General. For PT distances greater than 10 NM (out to 15 NM maximum), increase the distance to the assumed 1000-foot point 1 NM for each mile in excess of 10 NM.

**d.** Class B/C/D/E surface area extension width.

(1) ILS, WAAS, GBAS, LNAV/VNAV. The width of the class B/C/D/E surface area extension for ILS, WAAS, GBAS, LNAV/VNAV is established by determining the width of the final approach primary TERPS area at the point the aircraft reaches 1000 feet AGL [see paragraph 5-2-4.c(1)]. The width of the extension must not be less than 2 NM (1 NM each side of the localizer/azimuth course) regardless of the width of the precision primary area at the 1000-foot point.

(a) Refer to figure 5-2-19. If the aircraft reaches 1000 feet AGL at point A, the width of the surface area at point A is the same as the measured width of the procedure trapezoid at this point. Apply the provisions of paragraph 5-2-4. c(1) to determine the distance from the threshold to the 1000-foot point; then subtract 200 feet. The resultant figure is then used as “D” in the precision area for determining the half-width of the precision primary area:  
 $1/2W = .10752D + 700$  feet.

**Formula 5-2-2.**

$$D = d - 200 \text{ feet}$$

Where:

$d$  = Dist (feet) THR to 1000-foot point

**Example 5-2-11.**

$$1/2 \text{ Width} = .10752D + 700 \text{ feet}$$

(1/2 Width is not less than 1 NM)

**Figure 5-2-19.**

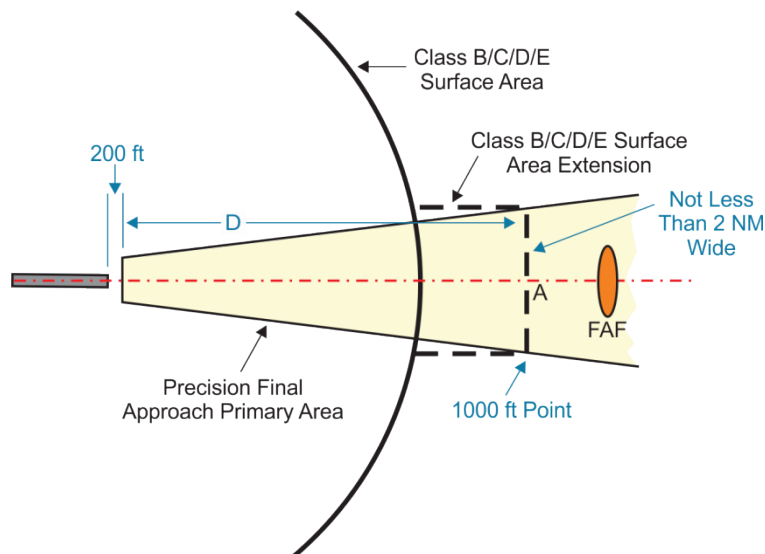

(b) Where the 1000-foot point is located in the intermediate segment, additional analysis is required. Since the ILS FAF and the underlying LOC FAF may not be collocated, the respective intermediate segments may have different widths at any particular distance from the FAF. The width of the class B/C/D/E surface area extension at the 1000-foot point must be the greater of the two segment widths. Use the guidance in Order 8260.3, chapter 8 (LOC) and chapter 10 (ILS) for calculating the respective widths.

(2) Nonprecision. The width of the class B/C/D/E surface area extension for other than ILS is established by measuring the width of the final approach primary area at the widest point between the surface area boundary and the 1000-foot point. For final segments that expand toward the basic surface area boundary, the width is measured perpendicularly to centerline at the point where the course crosses the surface area boundary. Where class B/C/D/E surface area has not been established prior to IAP development, obtain a tentative surface area dimension from the applicable Air Traffic Service Area for application of this paragraph. The width of the extension must not be less than 2 NM (1 NM each side of segment centerline) [see figure 5-2-20].

**Example 5-2-12.**

$$\begin{aligned} \text{Centerline Dis NDB to SA} &= D \text{ (NM)} \\ \frac{1}{2} \text{ Width} &= .0833D + 1.25 \text{ NM} \\ (\frac{1}{2} \text{ Width is not less than } 1 \text{ NM}) \end{aligned}$$

**Figure 5-2-20.**

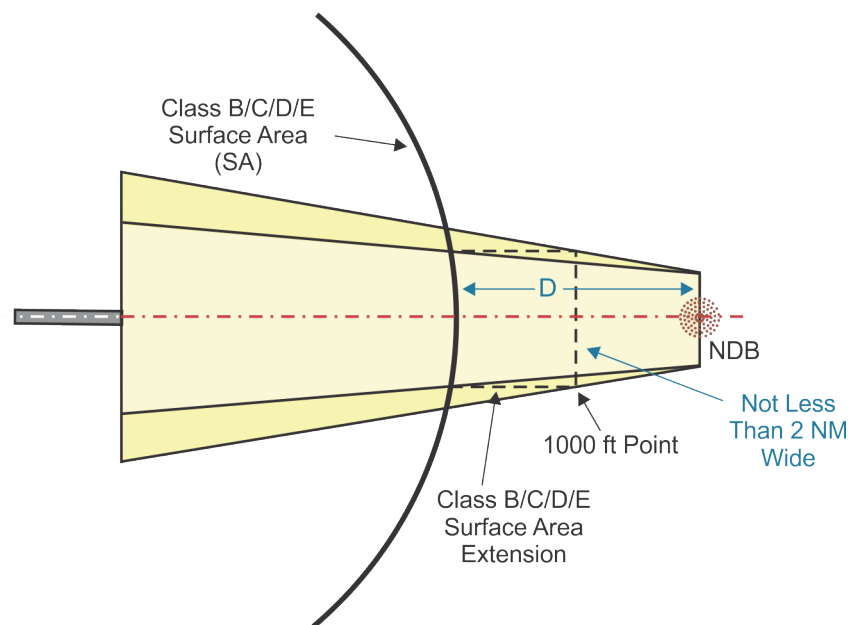

Where the 1000-foot point is located in the intermediate segment, determine the segment width abeam the 1000-foot point using the appropriate guidance in Order 8260.3, chapter 2.

e. Class E 700-foot airspace arrival extensions. A 700-foot class E airspace extension should be established whenever a SIAP authorizes descent to less than 1500 feet AGL. The width of the class E 700-foot airspace extension is established equal to the width of the initial,

intermediate, or final primary area at the widest point between the basic class E 700-foot airspace and the point where the aircraft descends below 1500 feet AGL. The methods used to locate the 1500-foot point in a precision final are similar to those used to locate the 1000-foot point. Refer to paragraph 5-2-4.c(1) and use 1500 feet in place of 1000 feet. For other precision segments, or for LOC/AZ, refer to paragraphs 5-2-4.e(1) through 5-2-4.e(3).

(1) No PT: Apply the methodology contained in paragraphs 5-2-4.c(2)(a) and 5-2-4.c(2)(b); except, where a 300 ft/NM descent gradient was used, apply a 500 ft/NM for the 1500 feet determination. In figure 5-2-21, the aircraft will reach 1500 feet AGL at 6 NM prior to the FAF using a 500-foot/NM descent gradient from the IF [see figure 5-2-21].

**Example 5-2-13.**

$$\begin{aligned} 3000 \text{ feet MSL} - 1500 \text{ feet} &= 1500 \text{ feet} \\ 1500 \text{ feet} / 500 \text{ feet per NM} &= 3 \text{ NM} \\ 9 \text{ NM (IF)} - 3 &= 6 \text{ NM} = 1500\text{-foot Point} \end{aligned}$$

**Figure 5-2-21.**

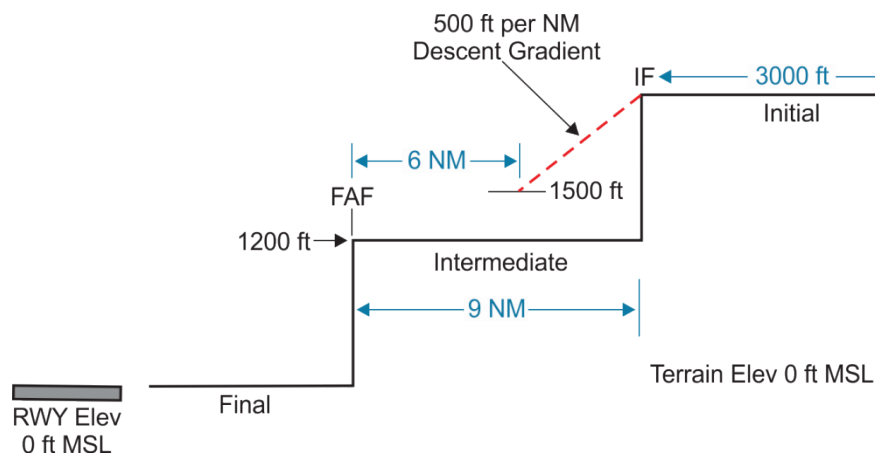

(2) Procedure turn:

(a) On-airport no FAF. For a 10 NM PT, the 1500-foot point is assumed to be 7 NM from the PT fix or facility on the PT inbound leg. Similarly, for a 5 NM PT, the 1500-foot point is assumed to be 5 NM from the PT fix or facility. *However*, if the PT completion altitude is less than 1500 feet above the highest terrain in the final segment underlying the course reversal, then the 1500-foot point is in the PT maneuvering area [see paragraph 5-2-4.k(7) and figure 5-2-22].

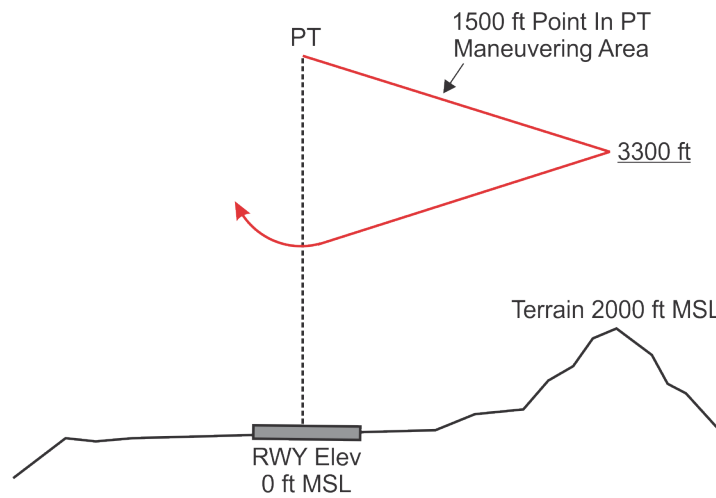
**Figure 5-2-22.**

(b) PT over the FAF.

1. If the PT completion altitude is less than 1500 feet above the highest terrain in the intermediate segment, the 1500-foot point is in the PT maneuvering area [see paragraph 5-2-4.k(7) and figure 5-2-23].

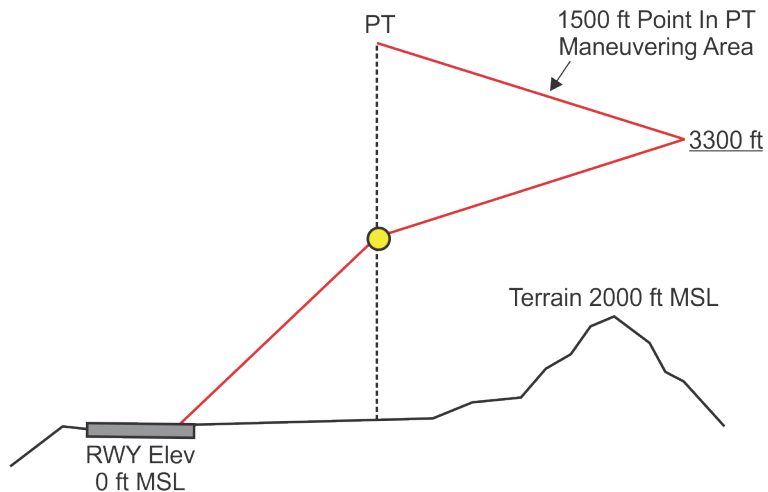
**Figure 5-2-23.**

2. If the PT completion altitude is 1500 feet or more above the highest terrain in the intermediate segment, the 1500-foot point is assumed to be seven nautical miles from the PT fix or facility on the PT inbound leg (5 NM for a 5 NM PT) [see figure 5-2-24].

**Figure 5-2-24.**

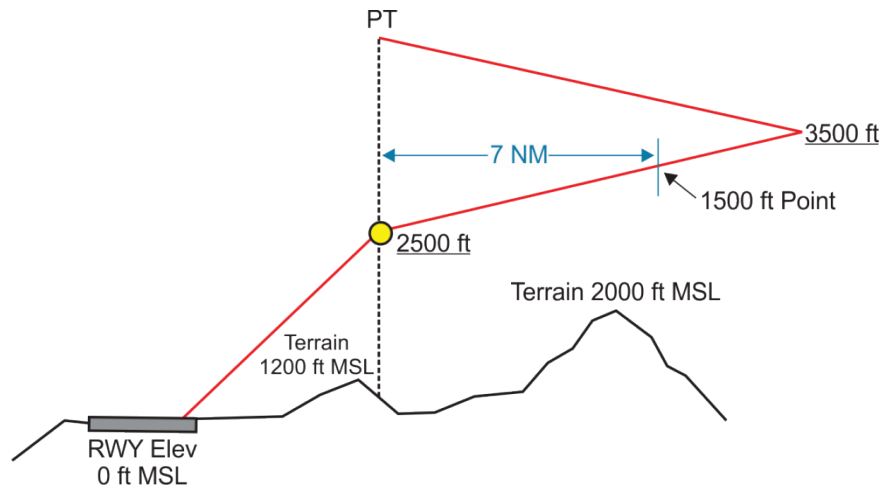

3. If the FAF altitude is greater than 1500 feet above the highest terrain in the final segment, the 1500-foot point is assumed to be inbound from the FAF at a distance determined by application of a 500 ft/NM descent gradient [see figure 5-2-25].

**Example 5-2-14.**

1500 feet AGL + 800 feet Terrain = 2300 feet MSL  
 2800 feet (FAF) - 2300 feet = 500 feet  
 500 feet / 500 feet per NM = 1 NM  
 6 NM (FAF) - 1 NM = 5 NM = 1500-foot point

**Figure 5-2-25.**

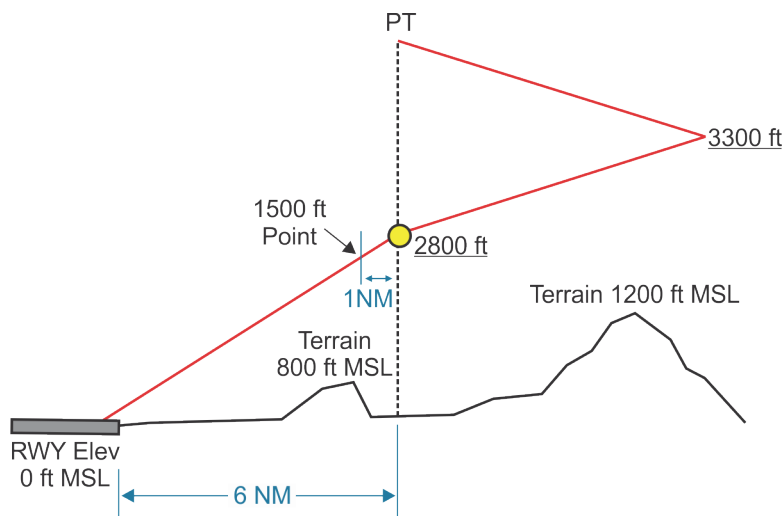

(c) PT over a stepdown fix *after* the FAF.

1. If the PT completion altitude is less than 1500 feet above the highest terrain in the segment underlying the course reversal, the 1500-foot point is in the PT maneuvering area [see paragraph 5-2-4.k(7) and figure 5-2-26].

**Figure 5-2-26.**

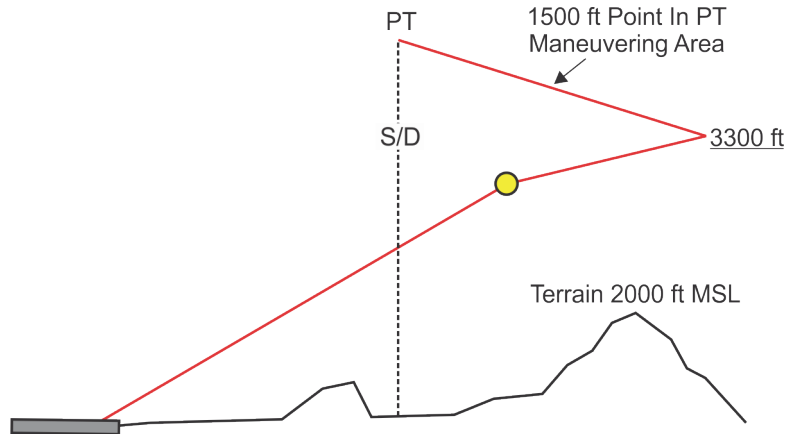

2. If the PT completion altitude is 1500 feet or more above the highest terrain in the segment underlying the course reversal, the 1500-foot point is assumed to be seven nautical miles from the PT fix or facility on the PT inbound leg (5 NM for a 5 NM PT) [see figure 5-2-27].

**Figure 5-2-27.**

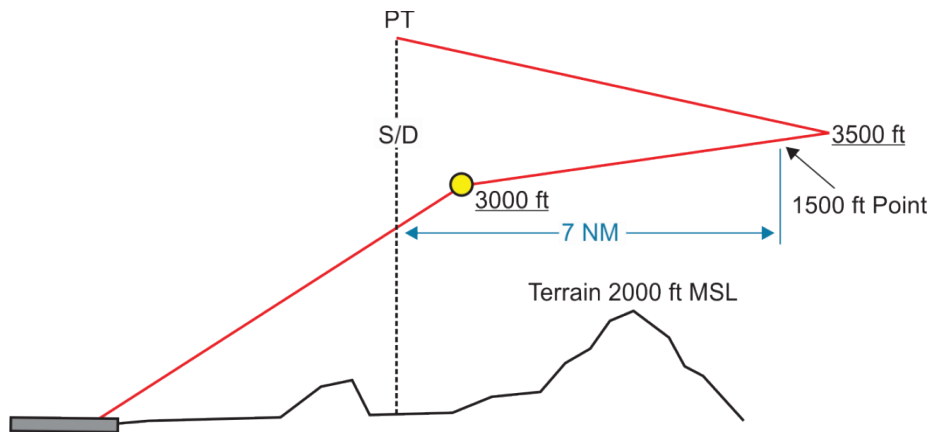

3. If the FAF altitude is 1500 feet or more above the highest terrain in the segment underlying the course reversal or the final segment, the 1500-foot point is assumed to be inbound from the FAF at a distance determined by application of a 500 ft/NM descent gradient [see figure 5-2-28].

**Example 5-2-15.**

1500 feet AGL + 1100 feet Terrain = 2600 feet MSL  
 2700 feet (FAF) - 2600 feet = 100 feet  
 100 feet / 500 feet per NM = 0.2 NM = 1000-foot Point

**Figure 5-2-28.**

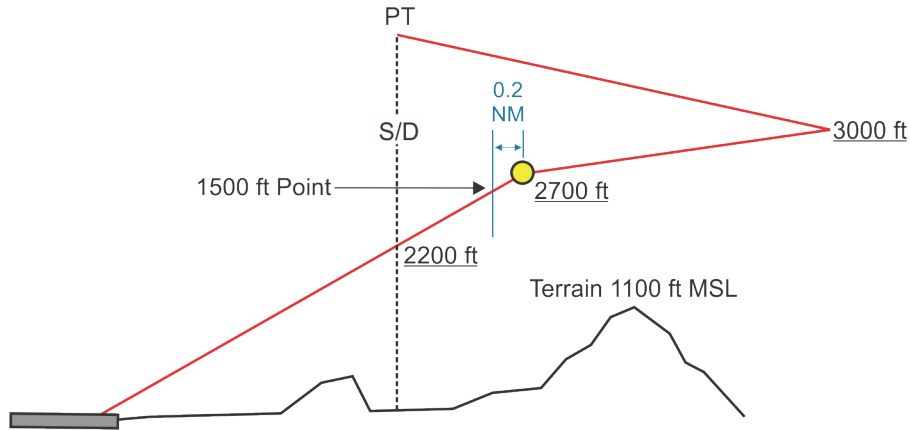

4. If the stepdown fix/facility altitude is 1500 feet or more above the highest terrain in the final segment, the 1500-foot point is assumed to be inbound from the stepdown fix/facility at a distance determined by application of a 500 ft/NM descent gradient [see figure 5-2-29].

**Example 5-2-16.**

1000 feet AGL + 2000 feet Terrain = 3000 feet MSL  
 3100 feet (IF) - 3000 feet = 100 feet  
 100 feet / 500 feet per NM = 0.2 NM  
 5 NM (IF) - 0.2 = 4.8 NM = 1000-foot Point

**Figure 5-2-29.**

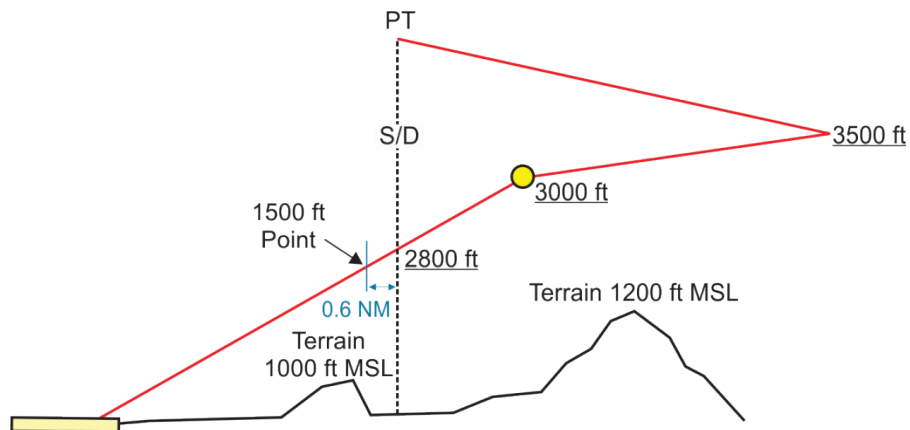

(d) PT over a stepdown fix *prior* to the FAF:

Condition: Distance between the stepdown fix/facility and the FAF less than 5 NM [see Order 8260.3, paragraph 2-5-5.d].

1. If the PT completion altitude is less than 1500 feet above the highest terrain in the segment underlying the course reversal, the 1500-foot point is in the PT maneuvering area [see paragraph 5-2-4.k(7) and figure 5-2-30].

Figure 5-2-30.

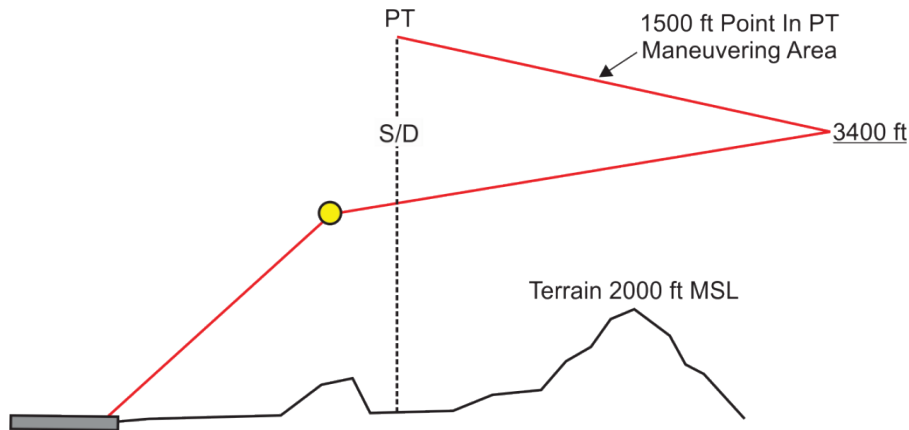

2. If the PT completion altitude is equal to or greater than 1500 feet above the highest terrain in the segment underlying the course reversal, *but* the minimum altitude at the stepdown fix/facility is less than 1500 feet above the highest terrain in the segment underlying the course reversal, the 1500-foot point is assumed to be seven nautical miles from the stepdown fix/facility on the PT inbound leg [see figure 5-2-31].

Figure 5-2-31.

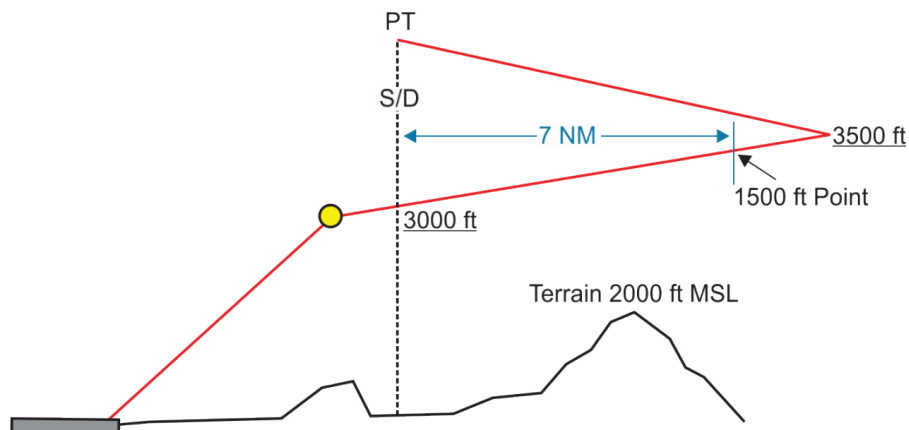

3. If the stepdown fix/facility altitude is 1500 feet or more above the highest terrain in the segment between the fix/facility and the FAF, the 1500-foot point is assumed to be



inbound from the fix/facility at a distance determined by application of a 500 ft/NM descent gradient from the stepdown fix/facility [see figure 5-2-32].

**Example 5-2-17.**

$$\begin{aligned} 1500 \text{ feet AGL} + 2000 \text{ feet Terrain} &= 3500 \text{ feet MSL} \\ 3600 \text{ feet (Stepdown)} - 3500 \text{ feet} &= 100 \text{ feet} \\ 100 \text{ feet} / 500 \text{ feet per NM} &= 0.2 \text{ NM} = 1500\text{-foot Point} \end{aligned}$$

**Figure 5-2-32.**

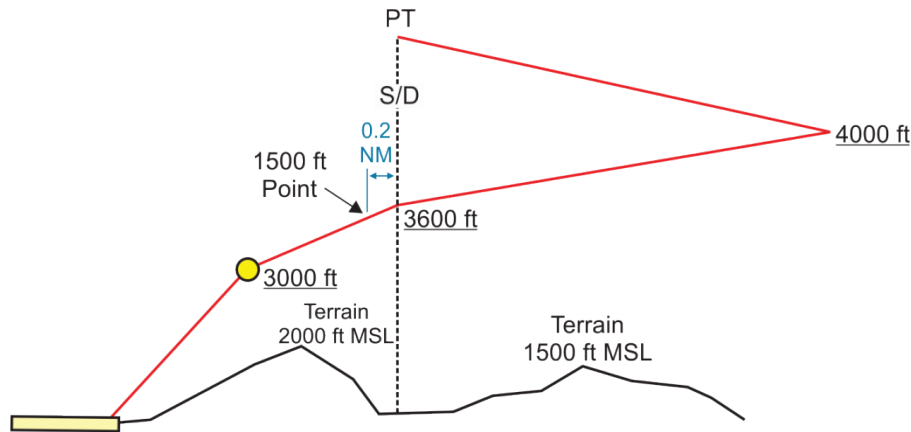

4. If the 1500-foot point is inside the FAF, apply the methodology in paragraph 5-2-4.c(2)(a) using a 500 ft/NM descent gradient.

**Condition:** Distance between the stepdown fix/facility and the FAF greater than 5 NM [see Order 8260.3, paragraph 2-5-5.d]. Since the fix/facility becomes the IF in this case, apply methodology for PT over the IF [see paragraph 5-2-4.e(2)(e)].

**Note:** Where the distance between the stepdown fix/facility and the FAF equals 5 NM, either Order 8260.3, paragraph 2-5-5.d or 2-5-5.e may be applied; use the appropriate guidance in paragraph 5-2-4.e(2)(d) or 5-2-4.e(2)(e) accordingly.

(e) PT over the IF.

1. If the PT completion altitude is less than 1500 feet above the highest terrain in the segment underlying the course reversal, the 1500-foot point is in the PT maneuvering area [see paragraph 5-2-4. k(7) and figure 5-2-33].

**Figure 5-2-33.**

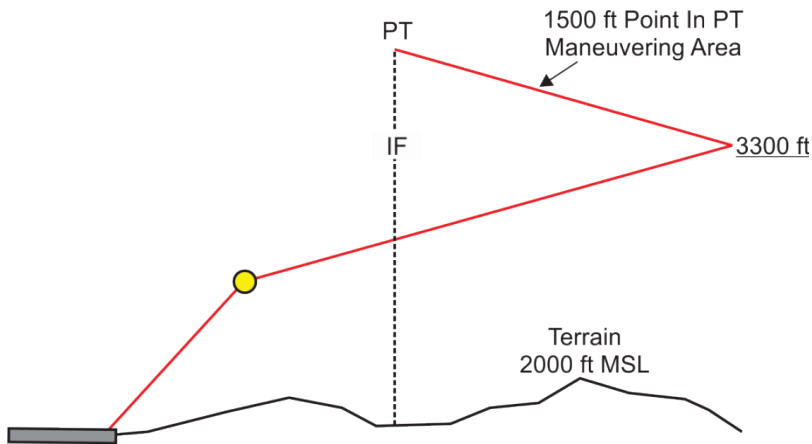

2. If the PT completion altitude is equal to or greater than 1500 feet above the highest terrain in the segment underlying the course reversal, the 1500-foot point is assumed to be seven nautical miles from the IF on the PT inbound leg [see figure 5-2-34].

**Figure 5-2-34.**

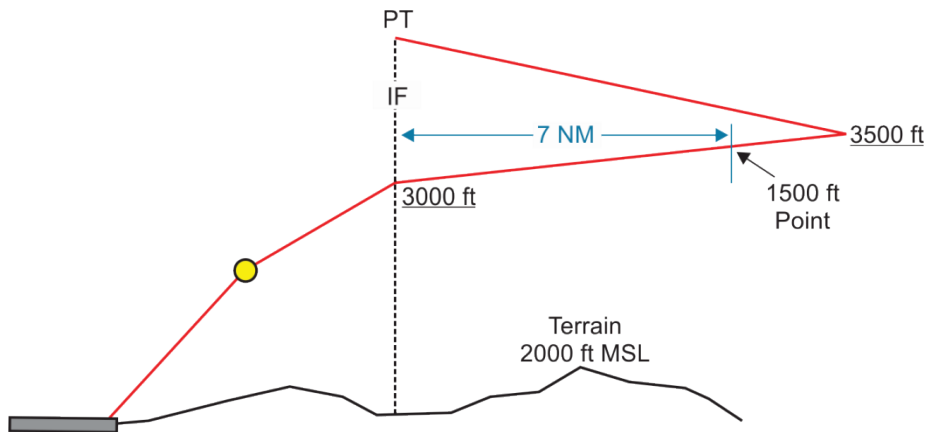

3. If the minimum altitude at the IF is equal to or greater than 1500 feet above the highest terrain underlying the course reversal, *but* less than 1500 feet above the highest terrain in the intermediate segment, the 1500-foot point is at the IF [see figure 5-2-35].

**Figure 5-2-35.**

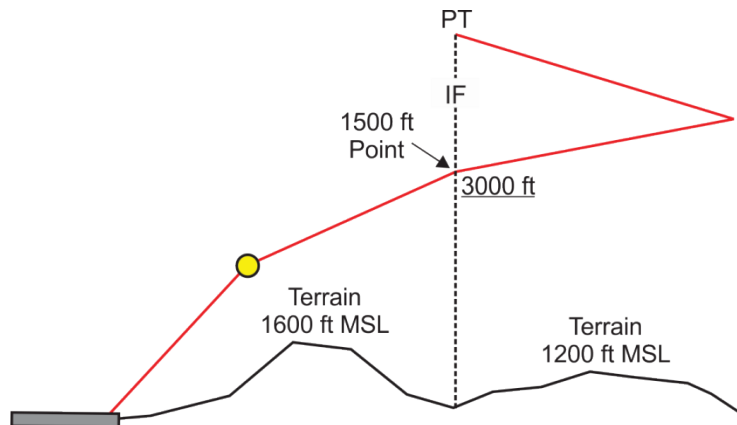

4. If the minimum altitude at the IF is greater than 1500 feet above the highest terrain in the intermediate segment, the 1500-foot point is assumed to be inbound from the IF at a distance determined by application of a 500 ft/NM descent gradient [see figure 5-2-36].

**Example 5-2-18.**

$$1500 \text{ feet AGL} + 2000 \text{ feet Terrain} = 3500 \text{ feet MSL}$$

$$3600 \text{ feet (IF)} - 3500 \text{ feet} = 100 \text{ feet}$$

$$100 \text{ feet} / 500 \text{ feet per NM} = 0.2 \text{ NM} = 1500\text{-foot Point}$$

**Figure 5-2-36.**

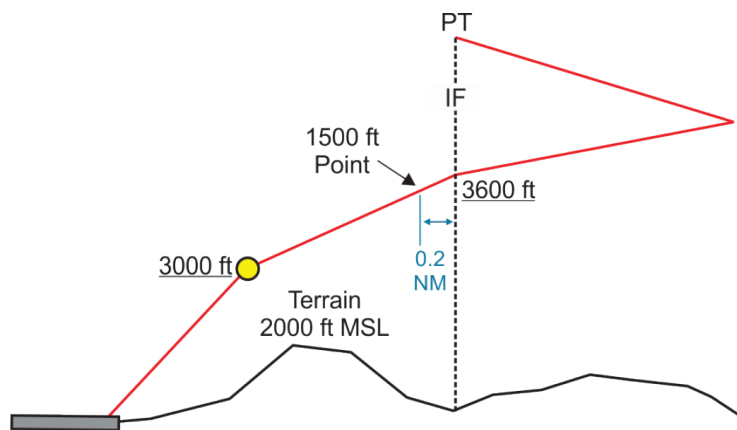

5. If the 1500-foot point is inside the FAF, apply the methodology in paragraph 5-2-4.c(2)(b) using a 500 ft/NM descent gradient.

(3) Hold-in-lieu of PT:

(a) At the FAF:

1. If the minimum altitude at the FAF is 1500 feet above the highest terrain in the final segment, the 1500-foot point is at the FAF [see figure 5-2-37].
2. If the minimum altitude at the FAF is greater than 1500 feet above the highest terrain in the final segment, apply the methodology in paragraph 5-2-4.c(2)(a) using a 500 ft/NM descent gradient.
3. If the minimum hold-in-lieu-of PT altitude is equal to or greater than 1500 feet above the highest terrain in the segment underlying the course reversal, *but* the minimum altitude at the FAF is less than 1500 feet above the highest terrain in the segment underlying the course reversal, the 1500-foot point is assumed to be in the holding pattern area. The class E 700-foot airspace (transition area) extension must encompass the entire holding pattern primary area. Use the pattern size appropriate to the highest holding speed at the published holding altitude [see paragraph 5-2-4.k(11) and figure 5-2-37 and figure 5-2-38].

**Figure 5-2-37.**

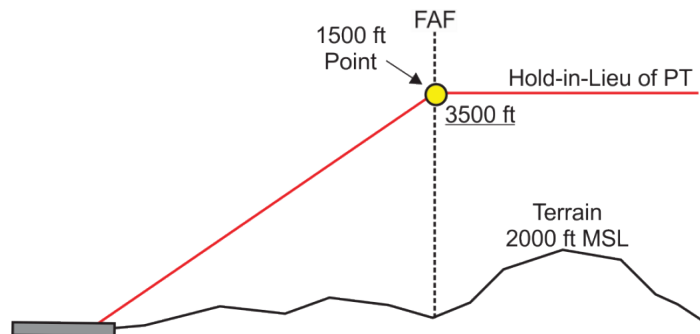
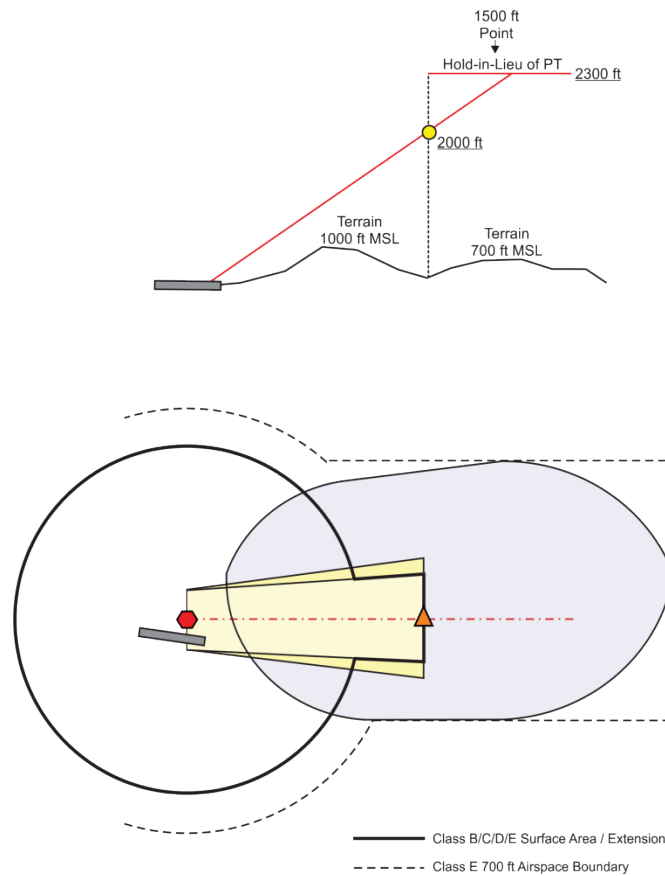

Figure 5-2-38.



(b) At the IF.

1. If the minimum altitude at the IF equals 1500 feet above the highest terrain in the intermediate segment, the 1500-foot point is at the IF.

2. If the minimum altitude at the IF is less than 1500 feet above the highest terrain underlying the holding pattern, the 1500-foot point is in the holding pattern area. The class E 700-foot airspace extension must encompass the entire holding pattern primary area. Use the pattern size appropriate to the highest holding speed at the published holding altitude [see paragraph 5-2-4.k(7) and figure 5-2-39]. Provide the appropriate AT office a drawing clearly depicting the airspace required [see paragraph 5-2-4.k(11)].

**Note:** In this case, controlled airspace requirements can be minimized by increasing the hold-in-lieu of PT minimum altitude to greater than or equal to 1500 feet above the highest terrain underlying the holding pattern area; apply paragraph 5-2-4.e(3)(b)1 or 5-2-4.e(3)(b)2 as appropriate.

**Figure 5-2-39.**

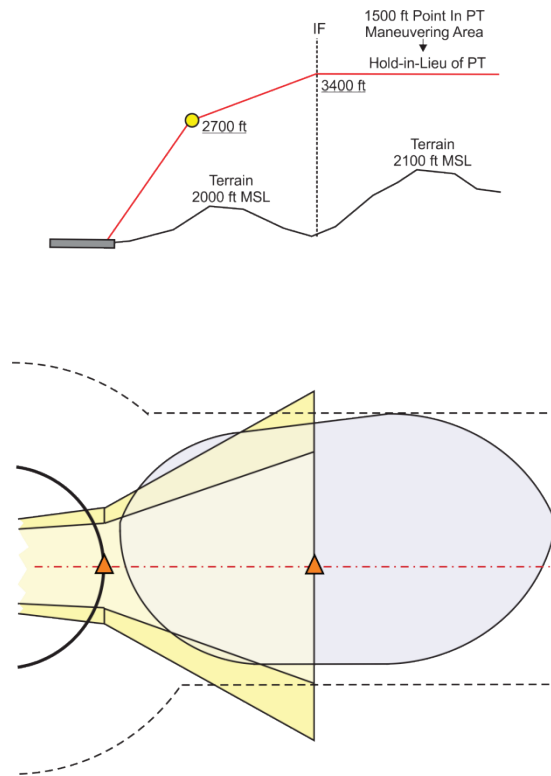

3. If the minimum altitude at the IF is greater than 1500 feet above the highest terrain in the intermediate segment, the 1500-foot point is assumed to be inbound from the IF at a distance determined by application of a 500 ft/NM descent gradient from the IF [see figure 5-2-40].

**Example 5-2-19.**

$$1500 \text{ feet AGL} + 2000 \text{ feet Terrain} = 3500 \text{ feet MSL}$$

$$3600 \text{ feet (IF)} - 3500 \text{ feet} = 100 \text{ feet}$$

$$100 \text{ feet} / 500 \text{ feet per NM} = 0.2 \text{ NM} = 1500\text{-foot Point}$$

**Figure 5-2-40.**

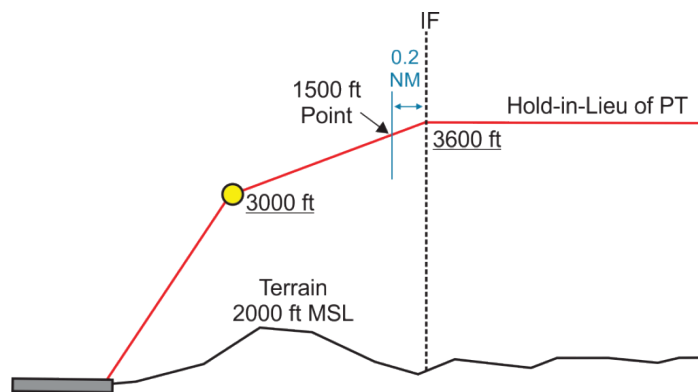

f. Missed approach. Normally, it can be expected that the airspace required to encompass the IAPs or DPs at an airport will be sufficient to encompass that airspace required for missed approach procedures. This particularly applies to any need for class B/C/D/E surface area extensions. Determine required airspace as follows:

(1) Draw the IAP missed approach segment areas on a sectional chart (or any other chart depicting controlled airspace).

(2) Establish a 700-foot class E airspace area whenever an IAP authorizes aircraft operation at/below 1500 feet AGL outside the basic class B/C/D/E surface area. Where the clearance limit is reached prior to the 1500-foot point, ensure the entire missed approach primary area is contained within class E 700-foot airspace, including clearance limit holding, if required [see figure 5-2-41].

**Example 5-2-20.**

$$2470 \text{ feet MSL} + 1500 \text{ feet Terrain} = 3970 \text{ feet MSL}$$

$$3970 \text{ feet MSL} - 2720 \text{ feet (MDA)} = 1250 \text{ feet}$$

$$1250 \text{ feet} / 152 \text{ feet per NM} = 8.22 \text{ NM} = 1500\text{-foot Point}$$

**Figure 5-2-41.**

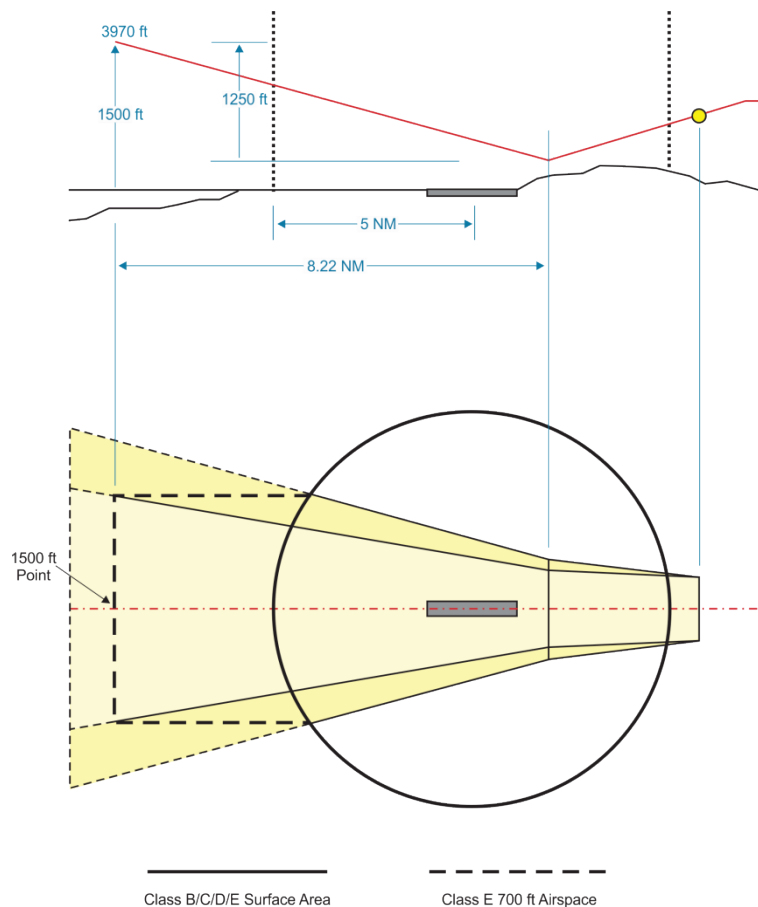

**g.** HI-VOR or NDB (no FAF).

## (1) 1000-foot point:

(a) If the penetration turn completion altitude is equal to 1000 feet above the highest terrain in the area prior to the 10 NM point, the 1000-foot point is at the 10 NM point.

(b) If the penetration turn completion altitude is greater than 1000 feet above the highest terrain in the area prior to the 10 NM point, the 1000-foot point is assumed to be inbound from the turn completion point at a distance determined by application of a 500 ft/NM descent gradient.

(2) 1500-foot point: Refer to Order 8260.3, table 2-4-6. The distance to the point of penetration turn completion and the “distance turn commences” from table 2-4-6 are assumed to be equal.

(a) If the penetration turn completion altitude is less than 1500 feet above the highest terrain underlying the penetration turn, the 1500-foot point is in the penetration turn area. Transition area boundaries must encompass the entire penetration turn area. Provide the appropriate ATC office a drawing clearly depicting the airspace required [see paragraph 5-2-4.k(10)].

**Note:** In this case, controlled airspace requirements can be minimized by increasing the penetration completion turn altitude to greater than or equal to 1500 feet above the highest terrain underlying the penetration turn area; apply paragraph 5-2-4.g(2)(b) or 5-2-4.g(2)(c) as appropriate.

(b) If the penetration turn completion altitude is greater than or equal to 1500 feet above the highest terrain underlying the penetration turn, *and* less than 1500 feet above the highest terrain in the straight segment prior to the 10 NM point, the 1500-foot point is at the turn completion point.

(c) If the penetration turn completion altitude is greater than 1500 feet above the highest terrain underlying the penetration turn in the straight segment prior to the 10 NM point, the 1500-foot point is assumed to be inbound from the turn completion point at a distance determined by application of a 500 ft/NM descent gradient.

(d) If the penetration turn completion altitude is greater than 1500 feet above the highest terrain inside the 10 NM point, apply the methodology in paragraph 5-2-4.c(2)(a) using a 500 ft/NM descent gradient from the 10 NM point.

**h.** HI-TACAN or VOR (with FAF).

## (1) 1000-foot point:

(a) If the penetration turn completion altitude is greater than 1000 feet above the highest terrain in the segment prior to the IF (or presumed IF location per Order 8260.3), the



1000-foot point is assumed to be inbound from the turn completion point at a distance determined by application of a 500 ft/NM descent gradient.

(b) If the penetration turn completion altitude equals 1000 feet above the highest terrain in the segment prior to the IF, the 1000-foot point is at the IF.

(c) If the IF altitude is greater than 1000 feet above the highest terrain in the intermediate segment, the 1000-foot point is assumed to be inbound from the IF at a distance determined by application of a 500 ft/NM descent gradient.

(d) If the FAF altitude is greater than 1000 feet above the highest terrain in the final segment, apply the methodology in paragraph 5-2-4.c(2)(a).

(2) 1500-foot point:

(a) If the penetration turn completion altitude is less than 1500 feet above the highest terrain between the turn completion point and the IF, the 1500-foot point is in the penetration turn area. Transition area boundaries must encompass the entire penetration turn area. Provide the appropriate ATC office a drawing clearly depicting the airspace required [see paragraph 5-2-4.k(10)].

**Note:** In this case, controlled airspace can be minimized by increasing the penetration completion turn altitude to greater than or equal to the turn completion point and the IF; apply paragraph 5-2-4.h(2)(b) or 5-2-4.h(2)(c) as appropriate.

(b) If the penetration turn completion altitude equals 1500 feet above the highest terrain between the turn completion point and the IF, the 1500-foot point is at the turn completion point.

(c) If the penetration turn completion altitude is greater than 1500 feet above the highest terrain between the turn completion point and the IF, the 1500-foot point is assumed to be inbound from the turn completion point at a distance determined by application of a 500 ft/NM descent gradient.

(d) If the IF altitude is greater than 1500 feet above the highest terrain in the intermediate segment, the 1500-foot point is assumed to be inbound from the IF at a distance determined by application of a 500 ft/NM descent gradient.

(e) If the FAF altitude is greater than 1500 feet above the highest terrain in the final segment, apply the methodology in paragraph 5-2-4.c(2)(a) using a 500 ft/NM descent gradient from the FAF.

i. Radar vector to FAF (radar required).

(1) If the FAF altitude is greater than 1000 feet above the highest terrain in the final segment, apply the methodology in paragraph 5-2-4.c(2)(a).

(2) If the FAF altitude is less than 1000 feet above the highest terrain in the final segment, the 1000-foot point is located PRIOR to the FAF [see paragraph 5-2-4.k(4)].

(3) If the FAF altitude is greater than 1500 feet above the highest terrain in the final segment, apply the methodology in paragraph 5-2-4.c(2)(a) using a 500 ft/NM descent gradient from the FAF.

(4) If the FAF altitude is less than 1500 feet above the highest terrain in the final segment, the 1500-foot point is located *prior* to the FAF [see paragraph 5-2-4.k(7)].

**j.** Radar vector to IF (radar required).

(1) If the IF altitude is greater than 1000 feet above the highest terrain in the intermediate segment, apply the methodology in paragraph 5-2-4.c(2)(b).

(2) If the IF altitude is less than 1000 feet above the highest terrain in the intermediate segment, the 1000-foot point is located *prior* to the IF [see paragraph 5-2-4.k(4)].

(3) If the IF altitude is less than 1500 feet above the highest terrain in the intermediate segment, the 1500-foot point is located *prior* to the IF [see paragraph 5-2-4.k(7)].

(4) If the 1500-foot point is at/inside the IF, apply the methodology in paragraph 5-2-4.e(1).

**k.** Information to be forwarded to ATC. Include the following information to be forwarded to ATC in a standard letter from Aeronautical Information Services to the appropriate Air Traffic Service Area (or backside of Form 8260-9 if applicable). The airspace requirements stated in this chapter are detailed. An Airspace Section may be added to the report version of Form 8260-9 in order to separate the ATC Airspace Information from other remarks [see paragraphs 5-2-3.c and 8-7-1.e].

(1) ARP coordinates; threshold coordinates (if straight-in authorized).

(2) FAF or IF coordinates. List FAF and IF coordinates and any other pertinent fix coordinates (RF or TF fixes to include direction CW or CCW and center-point fixes if applicable) for segments with turns or multiple segments. List fix coordinates which aid in describing the final and intermediate areas, etc., which are not considered straight.

**Example:**

FAF: TEXET 323323.33N/1024354.23W

TEXET 323323.33N/1024354.23W 9.22 NM CW from TZRFT 323326.22N/1024352.33W

IF: POBOY 323422.12N/1024356.44W

(3) List distance from ARP (for circling only), list distance from runway threshold (for straight-in), or list distance from a named fix to the 1000-foot point for procedures with multiple turning segments. If RF turns are used in a segment where the 1000-foot point is located, provide a depiction of the segment(s) which define the start of the segment. Include the named fixes and coordinates of the fixes along the route; include the calculated distance from the FAF, IF, IAF or

fix to the 1000-foot point. If multiple occurrences appear within a procedure, list the distance from a fix to the first 1000-foot point occurrence separately (first point a pilot encounters 1000 feet above terrain on the procedure). *For example:* If EDCBA IAF to the beginning of the IF segment has the 1000-foot point in the initial segment and ZYXWV IAF has the 1000-foot point in the initial also, list both 1000-foot points. If the 1000-foot point is in the common intermediate segment or final segment, list only once.

(4) Width of the segment primary area at the widest point between the class B/C/D/E surface area and the 1000-foot point; and the highest terrain elevation in the segment containing the 1000-foot point [see paragraph 5-2-4.d(2) and figure 5-2-19]. For segments containing RF turns, document the width of the segment primary area, and describe the points (latitude/ longitude) where a line perpendicular to the centerline at the 1000-foot point corresponds with the width of the primary area. For segments with more than one RF turn, or complex turning areas, attach a simple depiction of the area showing the 1000-foot point and highlight/display the required airspace.

(5) True course (to the hundredth of a degree) of the segment in which the 1000-foot point is located. When RF turns are contained within a segment where the 1000-foot point is located, leave blank and add description of the segment [fix name and coordinates of the RF center point and radius as listed in paragraph 5-2-4.k(2) examples].

(6) List distance from ARP (for circling-only), list distance from runway threshold (for straight-in), or list distance from the named fix to the 1500-foot point for procedures with multiple turning segments. If applicable, state: “1500-foot point located in the PT maneuvering area;” or “1500-foot point located in holding pattern area;” or “1500-foot point located in (name of start fix) intermediate segment” or “1500-foot point is located in (name) feeder segment.” *The applicable Air Traffic Service Area will then establish the transition area in accordance with Order JO 7400.2.* If the 1500-foot point is located in an initial or feeder segment and additional airspace is needed, describe the fixes (latitude/longitudes of start/end fixes as in paragraph 5-2-4.k(2) examples). If RF turns are used in a segment where the 1500-foot point is located, provide a depiction of the segment(s) which define the start of the segment. Include the named fixes and coordinates of the fixes along the route; include the calculated distance from the FAF, IF, IAF or fix to the 1500-foot point. If multiple occurrences appear within a procedure, list the distance from a fix to the first 1500-foot point occurrence separately (first point a pilot encounters 1500 feet above terrain on the procedure). *For example:* If EDCBA IAF to the beginning of the IF segment has the 1500-foot point in the initial segment and ZYXWV IAF has the 1500-foot point in the Initial also, list both 1500-foot points. If the 1500-foot point is in the common intermediate segment or final segment, list only once.

(7) Width of the segment primary area at the widest point between the class E 700-foot airspace (transition area) and the 1500-foot point; and the highest terrain elevation in the segment containing the 1500-foot point [see paragraph 5-2-4.e]. For segments containing RF turns, document the width of the segment primary area, and describe the points (latitude/longitude) where a line perpendicular to the centerline at the 1500-foot point corresponds with the width of the primary area. For segments with more than one RF turn, or complex turning areas, attach a graphic depiction of the area showing the 1500-foot point and highlight/display the required airspace.

(8) True course (to the hundredth of a degree) of the segment in which the 1500-foot point is located. When RF turns are contained within a segment where the 1500-foot point is located, leave off true course and add a description (fix name and coordinates of RF center point and radius, as listed in 5-2-4.k(2) examples) of the segment.

(9) Highest terrain elevation in the each segment containing the 1000-foot and 1500-foot point(s), if necessary. If the highest documented terrain falls within the PT (including entry zone) or hold-in-lieu of PT, include the appropriate pattern size. Include holding pattern size.

(10) For high-altitude penetrations, see paragraphs 5-2-4.k(1) through 5-2-4.k(9), except paragraph 5-2-4.k(2), apply. If applicable, state: "1500-foot point located in the penetration turn area," and leave 5-2-4.k(8) blank.

(11) For TAA application, Aeronautical Information Services should, when necessary, provide the appropriate Air Traffic Service Area with information describing the TAA boundaries so that an appropriately sized radius from the ARP can be established to contain the TAA. If not known at that time, provide the information to the appropriate Air Traffic Service Area when it is available. The appropriate Air Traffic Service Area is allowed to establish whatever radius from the ARP is necessary to contain the TAA. Along with the standard information provided from paragraph 5-2-4.k to the appropriate Air Traffic Service Area, provide the TAA boundary radii values and the radii center points in terms of fix names and coordinates with a description of the respective areas. Include a simple drawing to help the appropriate Air Traffic Service Area in visualizing the TAA airspace requirements.

**l.** SIAP adjustment. Where the SIAP will not be derogated, consideration should be given to adjusting altitudes whereby the designation of unnecessary controlled airspace can be eliminated. The adjustment of altitudes should not be made where the descent gradients are increased above optimum.

**m.** Review. Aeronautical Information Services must review airspace dockets to determine that the proposed airspace encompasses the appropriate portions of the IAP consistent with the data forwarded in accordance with paragraph 5-2-4.k.

### Section 5-3. Airport Airspace Analysis

#### 5-3-1. General.

a. Public Law 103-272, Sections 40103b.1 and 44502, contain the basic authority for the FAA to conduct airport airspace analysis studies, which culminate in an FAA determination. In order for the FAA to fulfill its obligations pursuant to the Public Law, part 157, Notice of Construction, Alteration, Activation and Deactivation of Airports, was promulgated. This regulation requires proponents of the civil airport projects not involving federal funds to give the Administrator reasonable prior notice of such proposals so that he/she may be advised as to the effects the proposal will have upon the safe and efficient use of airspace by aircraft.

b. Other airport projects which are subject to airport airspace analysis studies include those eligible for airport improvement programs which are submitted to the FAA pursuant to Order 5100.38, Airport Improvement Program (AIP) Handbook; the Military Construction Program (MCP), submitted to the FAA for review pursuant to Public Law, and Department of Defense Directive 5030.17; the designation of instrument landing runways normally associated with airports under AIP agreements; changes in airport operating status from VFR to IFR; and changes to airport traffic patterns.

c. The provisions of Order JO 7400.2, part 3, are applicable to all participating offices. Therefore, all Flight Standards and Service Area OSG-FPT personnel directly involved in airport airspace analysis must be familiar with Order JO 7400.2, and those general responsibilities specified in section 1-2, of this document.

**5-3-2. Service Area OSG-FPT/Flight Standards inputs in establishment of airports and heliports.** Since the term “airports” includes small isolated airports (including ultra-light flight parks), heliports, seaplane bases, and large airports, the problems associated with proposed establishment of airports are varied. However, it may be stated that Service Area OSG-FPT and Flight Standards studies of all proposed airports or heliports relate mainly to the safety aspects involved, the feasibility of proposed anticipated operations, and the practicality of establishing reasonable instrument approach and VFR flight procedures, where required. Any proposed nonstandard installation or facility must be thoroughly reviewed to determine if an adequate level of safety can be achieved.

**5-3-3. Flight Standards performs the flight safety review of airport proposals to determine whether aircraft operations can be conducted safely considering the proposal’s effect on the safety of persons and property on the ground.** When requested by the Airports Division, Flight Standards provides an operational safety review for Airports Division approval of a modification of an airport standard. Flight Standards determinations, including studies referred by Service Area OSG-FPT, will be provided to the OPR.

**5-3-4. Service Area OSG-FPT is responsible for evaluation and comment on all airport proposals related to IFR impact.** Routine coordination with the Flight Standards point of contact is expected on joint studies.

a. Questions to be considered in Service Area OSG-FPT/Flight Standards Analysis. It is not intended that the study be confined to these questions. It is recognized that some proposals will

present unique problems that cannot be anticipated. Rather, the questions are outlined here to stimulate thinking (some of them are not applicable to all proposals):

- (1) Where is the closest landing area? Is it depicted on aeronautical charts?
- (2) What type of activity is contemplated for the proposed landing area? Will a conflict with established instrument approach procedures result? With other airports?
- (3) Will existing obstructions result in unrealistic minimums? Unrealistic effective runway lengths? Will existing or proposed man-made and/or natural objects in the vicinity of the airport affect the safety of flight operations?
- (4) What is the proximity of the closest city or town? Are runways aligned to avoid populated areas, schools, hospitals, and to minimize noise complaints? Other airports in close proximity?
- (5) Are runways aligned in consonance with wind rose data? Is instrument runway aligned with IFR wind rose data?

**b. Heliport establishment.** All proposals for the establishment of heliports must be given an on-site operational evaluation as specified in Order 8900.1, Volume 8, chapter 3, section 3. Proposed heliports to be located in congested areas, or any rooftop heliport, should be evaluated by helicopter qualified operations inspectors, or a qualified procedure evaluation pilot (PEP).

**c. Study requirements.** It must be recognized that some proposals will be acceptable from an airspace utilization point of view, but may be totally unacceptable from an operational safety standpoint. It is; therefore, important that a thorough study be performed and that Service Area OSG-FPT and Flight Standards positions are developed and forwarded to the appropriate Airports divisions/ branches. A copy of this position should be forwarded to the other appropriate division or branch. This position should clearly state any operational limitations and restrictions that would be required, e.g., ingress/egress routes.

**5-3-5. Alterations of airports or heliports.** For the purpose of this order, “alteration” means realignment, activation, or deactivation of any runway layout, and/or associated taxiways, or any other substantial change to the surface of that part of an airport that is used or intended to be used for aircraft landing and taking off. Generally speaking, the contents of the previous paragraphs of this section are also applicable to proposed alterations. However, there is the additional consideration of effects on existing instrument approach procedures previously established for the airport. There is also the possibility of the need for relocation of associated navigation facilities.

**5-3-6. Deactivation of airports or heliports.** For the purpose of this order, “deactivation” means the discontinuance of use of an airport or landing area permanently, or for a temporary period of one year or more. The FAA requires notice of deactivation of airports. However, Service Area OSG-FPT and Flight Standards have no authority to recommend approval or disapproval of such actions. It may be necessary in some cases to cancel approach procedures, or to recommend the relocation of previously associated airspace. Appropriate NOTAMs should, if

required, be published and the closed airports should be marked in accordance with existing standards.

**5-3-7. Assistance in zoning problems.** It is FAA policy to advocate state and local legislation of airport zoning in accordance with model acts prepared in cooperation with other national agencies, such as the Council of State Governments, the National Association of State Aviation Officials, and the National Institute of Municipal Law Offices. From time to time, Service Area OSG-FPT or Flight Standards personnel may receive requests for assistance in the development of airport zoning acts (state) or ordinances (local). Such inquiries should be referred to airports personnel, and to the appropriate airport engineer. Airports personnel are well versed with the model legislation that has been developed, and have been instructed in the dissemination of the material contained therein.

## Section 5-4. Restricted Areas

### 5-4-1. General.

**a.** A restricted area is airspace designated under 14 CFR part 73 within which the flight of aircraft, while not wholly prohibited, is subject to restriction. No person may operate an aircraft within a restricted area between the designated altitudes and during the time of designation without the permission of the using or controlling agency.

**b.** Obstacle clearance. Areas which contain restricted entry (e.g., restricted areas, prohibited areas, etc.) are not considered obstacles to the establishment of instrument flight procedures. However, obstacle clearance must be provided over terrain and/or manmade obstacles within the restricted area that underlies the flight procedure clearance area. The lateral and vertical boundary of the restricted area must be used to define the obstacle location when tethered balloons are within; do not evaluate the obstacle itself.

**5-4-2. Letter of procedures.** A letter of procedure between the using agency of a joint-use restricted area and the ATC facility (controlling agency) may be promulgated to allow non-participating aircraft to transit the restricted area when the area is not being used for its designated purpose.



### **Section 5-5. Establishment, Relocation, or Discontinuance of Radio Navigation Aids**

**5-5-1. Criteria and guidelines.** The criteria and guidelines for the establishment, relocation, or discontinuance of navigational aids affecting airspace are contained in Order 7031.2, Airway Planning Standard Number One Terminal Air Navigation Facilities and ATC Services.

**5-5-2. OSG-FPT action.** Conduct studies to determine the effect of the proposed action on existing or proposed IFR flight operations.

**5-5-3. Flight Standards action.** Conduct studies to determine the effect of the proposed action on operational safety as relates to existing or proposed visual flight operations. Flight Standards will provide input to the appropriate Air Traffic Service Area OSG-FPT relating to operational impact, and to other interested divisions on request.

THIS PAGE IS INTENTIONALLY LEFT BLANK

## Chapter 6. Military Procedures

**6-1-1. General.** Order 8260.3 specifies that the U.S. Army, Navy, Air Force, and Coast Guard are responsible for the establishment and approval of instrument procedures as well as the review and approval of radar MVA charts for airports under their respective jurisdiction. This responsibility also applies to the approval of deviations from standards. Order 8260.3 also states that the FAA will accept responsibility for the development and/or publication of military procedures when requested to do so by the appropriate military service through an interagency agreement.

**a.** U.S. Army procedures. Under National Agreement 127 (NAT-127), the FAA provides worldwide terminal instrument procedures service for the U.S. Army. Army procedural requirements must be processed in accordance with Order 8260.15.

**b.** U.S. Air Force (USAF) procedures. USAF procedural requirements must be processed in accordance with Order 8260.32.

**c.** U.S. Navy (USN) procedures. There is no formal agreement for FAA support of USN procedure development. Questions concerning U.S. Navy procedures must be directed to: Deputy Head, Naval Flight Information Group (NAVFIG); Code 525E0; SPAWARSYSCEN Atlantic; P.O. Box 190022; North Charleston, SC 29419-9022.

### 6-1-2. Review and coordination.

**a.** Military procedures. Military instrument procedures are reviewed and coordinated in accordance with applicable military directives prior to submission for flight inspection. Review of the procedure to determine compliance with Order 8260.3 criteria or other approved 8260-series orders (except as noted in paragraph 6-1-1) is *not* an FAA responsibility. Flight Program Operations must forward flight inspection comments regarding procedure design, flyability, etc., to the attention of the authority submitting the procedure(s).

**b.** Military fixes. Military fixes are maintained in the NASR database, which is accessed by FAA air traffic system computers for radar display, and used to develop aeronautical charts and avionics databases. Therefore, it is imperative that the requirement to document and name fixes supporting military operations/procedures receive the same priority as Forms 8260-2 that support civil procedures. See paragraph 8-5-1.a for processing requirements.

**6-1-3. FAA acceptance.** FAA accepts military procedures for civil use unless the note “Not for Civil Use” is annotated on the procedure by the military. The “not for civil use” annotation should only be used when a military procedure deviates from standards and an equivalent level of safety is not achieved.

**6-1-4. Assistance.** Military commands may contact the Flight Procedure Standards Branch for technical assistance regarding instrument procedure design, criteria, use of FAA forms, and in determining an equivalent level of safety related to a waiver. Aeronautical Information Services will provide assistance in completing and processing forms, waivers, and procedures submitted for flight inspection, commensurate with present workload.

THIS PAGE IS INTENTIONALLY LEFT BLANK

## Chapter 7. Planning

### Section 7-1. General

#### 7-1-1. General.

**a.** The development of effective and efficient flight procedures is closely related to the facility establishment and airport programs, and requires active participation by Flight Standards, the applicable Air Traffic Organization Service Area, and Office of Airports personnel in the planning, programming, and budgeting of navigation facilities and airport development plans. Instrument procedures often determine the alignment and location of navigation facilities as well as the location, marking, and lighting of airport landing and maneuvering areas.

**b.** The allocation of funds frequently depends on the determination that efficient procedures can be developed and can be justified based on operational benefits (landing minimums) or safety improvements. Therefore, the operational planning associated with facility installations and airport development, particularly in large terminal areas, is one of the most important responsibilities of the Flight Standards, Flight Procedures, and Airspace Programs.

**c.** General design requirements. Instrument approach procedures must provide a smooth transition from the en route structure, and provide the pilot with sufficient information to effect a safe instrument approach to a landing or missed approach. In the interest of safety, these charts must be easy to interpret. The speed of modern aircraft demands that greater simplicity, minimum cockpit workload, and ease of interpretation be incorporated in the design of the instrument procedure. Criteria used in the design of standard instrument procedures are contained in Order 8260.3 and other specific 8260-series orders.

**Note:** Attempts to apply all possible options permitted by criteria to obtain lowest possible minimums should not be made if the resultant procedure is overly complex and only a minor operational benefit is gained.

**d.** Give full consideration to the environmental impact of procedures on local communities. Consider locations containing plume emitting devices (i.e., smoke stacks, cooling towers, and other systems emitting a vertical exhaust) and their effect on aircraft operations over these locations. Avoid schools, churches, hospitals, stadiums, rest homes, populous residential areas, and other noise-sensitive areas whenever possible due to the potential for adverse environmental impact. Where the location of facilities and/or the flow of air traffic will permit, use the highest possible altitudes consistent with optimum descent angles/rates in all segments of approach procedures to provide the least noise interference.

## Section 7-2. Planning Standards

### 7-2-1. Planning standards.

**a.** Facility establishment. Airway Planning Standards contain the criteria for the establishment of air navigation facilities. These criteria are based, in part, on air traffic demand since the volume of traffic provides a measurable indication of the need for air navigation facilities and other aeronautical services.

**b.** Standards limitations. Airway Planning Standards do not; however, cover all situations which may arise and are not to be used as a sole determination in denying a service where there is a demonstrated operational or ATC requirement. An aeronautical requirement may exist for facilities that cannot be adequately measured by a consideration of air traffic demand alone. Similarly, air traffic demand does not in itself always constitute a requirement for an air navigation facility. These situations must be individually evaluated to determine whether the benefits to be gained are commensurate with the cost of the facility or service.

**c.** Benefit/cost ratios have been established by the Office of Aviation Policy and Plans (APO-1). Phase I deals with determining the traffic activity using Airway Planning Standard number one (APS-1). Phase II criteria are a comparison of the present value quantitative benefits of installing an air navigation facility, with the present value of the costs for establishing the aid. Phase II includes other factors such as weather, etc. In most instances, the establishment criteria, in addition to the traffic volume, require an operational improvement in the form of lower altitudes or reduced visibilities with respect to IFR operations or a safety benefit with respect to visual aids that are required to resolve known safety problems.

**d.** Responsibility. The primary responsibility for determining that a location meets the air traffic volume requirements rests with Vice President of System Operations. The responsibility for identifying improvements to operational minimums or for establishing safety requirements is jointly shared by the Air Traffic Safety Organization, Aeronautical Information Services, and Flight Standards Service. Specific areas of responsibility are delineated in chapter 1. However, each organization has unique skills and expertise that must, in many situations, be combined in a teamwork approach in the area of airport and navigational facility planning. Aeronautical Information Services personnel serve in a team leadership role in developing and recommending improvements to IFR procedures, operational minimums, and associated facilities.

### 7-2-2. Determination of operational benefits/improvements.

- a.** General. An operational benefit and/or improvement are considered to exist:
- (1) When IFR operations can be authorized where none existed previously;
  - (2) Where a reduction of IFR minimums on existing procedures can be achieved;
  - (3) Where an additional NAVAID will provide lower minimums than those authorized on existing adjacent facilities; or

(4) Where a reduction in minimums cannot be achieved, an improvement in operational safety can be demonstrated.

**b. Criteria.** A reduction of at least 100 feet in descent altitude or a reduction of  $\frac{1}{4}$  SM in visibility requirements should be indicated to adequately support an operational benefit. Where a reduction of less than 100 feet in descent altitude is anticipated, additional justification should be provided to show that other improvements in the overall operation could be achieved with the additional facilities. Such improvements might include simplification of operating procedures; reduction of flight time; improved course guidance; improved runway alignment; or elimination of criteria waiver, etc. Flight Standards Service and Aeronautical Information Services personnel are expected to provide this type of supporting information during the planning phases for new NAVAIDs.

**c. Determination.** A final determination that the anticipated benefits can actually be achieved is necessarily dependent upon the demonstrated performance of the facility at the time of commissioning; however, a reasonable evaluation can be made for planning purposes based on the best information available at the time.

## Section 7-3. Safety Analysis

### 7-3-1. Performing a Safety Analysis.

**a.** The Airway Planning Standards consider the programming of precision approach path indicator (PAPI) and runway end identifier lights (REIL) as visual aids provided the runway meets a minimum number of landings and a reasonable safety benefit versus cost can be established. Although not specifically considered in the planning standards for VFR use, an economy approach light system may be considered to resolve a safety problem where the cost of the system is commensurate with the improvement desired, and the REIL or PAPI will not provide the necessary service.

**b.** In those cases where visual aids are considered essential to operational safety but the runway does not meet the traffic volume requirement, additional justification should be developed highlighting the visual deficiencies, as they exist and the improvements that will be achieved. Aeronautical Information Services personnel will recommend to, or assist, the Airports division and Air Traffic Technical Operations Service Areas in developing the principal justification for programming visual aids at IFR airports.

**c.** Personnel will provide input to the planning teams through the AWO for visual aids to correct deficiencies identified during their flight program activity, contact with the public, or during incident/accident investigations. Flight Standards will provide primary support for the planning of visual aids for safety improvements at VFR public use airports. The AWO will review all inputs for appropriateness and develop recommendations for the regional airports and facilities planning groups.

**d.** Determining visual aids safety benefits. Orders 7031.2 and Order JO 7400.2 provide FAA personnel with the basic guidance for establishment and justification [see paragraph 7-8-1.c].

(1) There are a number of operational and environmental situations where visual reference deficiencies exist, and where improvements can be made by the installation of a visual aid system to enhance safety. Typical deficiencies include:

(a) Deceptive approach area. A situation in which the topography, landmarks, or lights underlying the approach path do not provide the pilot with an adequate visual reference plane on which to establish a proper approach to a runway. This includes open water, featureless terrain, dense tree growth, deceptive lights, or rapidly rising or falling terrain that presents an unbroken or indefinite surface lacking the contrast for depth perception and glide angle maintenance.

(b) Obstruction clearance. A situation in which natural or man-made obstructions under, or penetrating, the approach surface makes pilot judgment of obstruction clearance difficult due to their orientation, irregular pattern, or obscurity due to inability to provide appropriate marking or lighting.

(c) Runway identification. A situation in which environment surrounding an airport derogates the pilot's ability to instantaneously establish and maintain runway



identification at two nautical miles or less from the runway threshold within 90 degrees of the runway centerline extended. One of the following conditions may hamper identification:

1. Overriding lights. A general preponderance of metropolitan or area lighting located within two nautical miles of the circling approach area to the runway.

2. False lights. A configuration of non-aviation lighting, underlying the approach surface, which presents to the pilot false runway identification such as a well-lighted boulevard, expressway, or railroad yard that crosses the approach area at 45 degrees or less to the runway centerline extended.

(d) Runway alignment. A situation in which the runway lighting fails to provide alignment information sufficiently in advance to assure correct intercept of the extended runway centerline and subsequent approach. This situation may be divided into two types:

1. Intercept guidance. Where straight-in visual approach to the runway is at an angle of 15 degrees or more to the runway centerline extended and the line of sight to the runway lights is obstructed.

2. Circling guidance. Where, due to terrain or technical considerations, the primary approach is aligned mainly downwind and the subsequent circling to the upwind requires positive alignment reference to preclude overrunning the runway centerline extended.

(e) Nonprecision straight-in approach. A runway to which a nonprecision straight-in approach has been authorized. Vertical guidance is necessary for stabilized descent from the MDA to the runway. The vertical guidance assists the pilot in maintaining a safe flight path to the runway, thus avoiding premature descent, which may result in landing short of the runway during weather visibility conditions at or near the authorized straight-in minimums.

e. Flight Standards Service and Aeronautical Information Services personnel will frequently be involved in airport planning studies in their respective areas of responsibility, which require analysis of the merit of adding various visual aids [see table 7-3-1]. In addition to the specialist's experience or input from other knowledgeable persons, the following should be considered in recommending a particular visual aid:

**Table 7-3-1. Visual Aids Usage**

<b>Operational Problem</b>	<b>PAPI/VASI</b>	<b>REIL</b>	<b>MALS</b>	<b>LDIN</b>
Deceptive Approach Area	Very Effective	Ineffective	Effective	Very Effective
Obstruction Clearance	Very Effective	Ineffective	Ineffective	Limited Effectiveness
Runway Identification	Limited Effectiveness	Effective	Effective	Very Effective
Runway Alignment	Ineffective	Limited Effectiveness	Very Effective	Very Effective
Vertical Guidance	Very Effective	Ineffective	Ineffective	Ineffective
Jet Operations	Very Effective	Ineffective	Limited Effectiveness	Effective
Circling Guidance	Ineffective	Limited Effectiveness	Limited Effectiveness	Very Effective

**Note:** Omni-directional REIL may be considered for improving guidance to a circling runway if the unbaffled lights would not create a greater problem for operations on other runways.

## Section 7-4. Airway Planning

### 7-4-1. General.

**a.** The primary responsibility for the establishment, amendment, or deletion of airways, RNAV routes, and jet routes rests with the ATO Mission Support Services (AJV-0) based on air traffic demand and user requirements. Aeronautical Information Services and applicable Service Area Flight Procedures Teams must participate in airway planning with respect to navigational signal coverage over designated routes, development of MEAs and related data, and the siting of electronic facilities. Frequently, terrain factors or site availability dictate the siting of an electronic facility; however, there are instances where the en route facility can be located so as to provide a terminal instrument approach capability in addition to the en route service.

**b.** Aeronautical Information Services should be cognizant of operational requirements and environmental conditions in the en route and terminal areas that need to be considered in order to develop sound recommendations for optimum facility siting. Situations will arise where Aeronautical Information Services considers that a change in airway planning is necessary or desirable. Such changes could result from facility restrictions, lack of facility coverage, need for lower MEAs, improvement in airway alignment, and elimination of criteria waivers, etc. Every effort should be made to develop recommendations in coordination with the appropriate Air Traffic Technical Operations Service Area and ATC so that full consideration of local problems will be reflected in Service Area planning.

## Section 7-5. Terminal Planning

### 7-5-1. General.

**a. Responsibility.** The primary responsibility for identifying airport locations that qualify for new terminal navigational facilities (except radar) rests with the regional airports division. Proposed actions must be coordinated with Aeronautical Information Services and all other associated lines of business. Aeronautical Information Services is required to participate in terminal planning with respect to the type of facilities required for the intended operations, development of instrument procedures, operational minimums, and the establishment of priorities for procurement and installation of planned facilities. The applicable Service Area Flight Procedures Team personnel should be cognizant of operational requirements and environmental conditions in the terminal areas that need to be considered in order to develop sound recommendations for facility selection and optimum facility siting. The AWO will provide technical assistance to applicable planning teams developing low weather (CAT II/III) facilities, applying emerging technologies, or requiring expertise in determining if a waiver to a flight procedure is practical.

**b. Planning recommendations.** The applicable Service Area Flight Procedures Team personnel should identify potential improvements to IFR terminal operations to appropriate Air Traffic Service Areas and Airports division planners. Such recommended improvements could occur as a result of new facility restrictions, changes in airport operations, and the need for improved instrument procedures, safety considerations, and elimination of criteria waivers.

**c. Waiver action.** If waiver action is required to support new construction in the planning/pre-construction phase, a pre-approval waiver package must be submitted in accordance with section 1-1-1. A cover letter must accompany the Form 8260-1 that includes an explanation for the need to request early waiver action. If the proposed deviation has been found acceptable, a temporary waiver approval will be issued. A permanent waiver request must be submitted 180 days prior to the beginning of the operation that the waiver supports.

**7-5-2. Requirements for outer compass locators for new ILS installations.** In achieving the goals of reducing the total establishment costs for instrument landing systems, emphasis has been placed on providing only those components and services that are essential to the basic operational need. In this respect, the compass locator has not been considered a required item for many new ILS locations and will be included as a component only where it is properly justified. These criteria specify conditions that must be considered to properly justify the installation of compass locators in conjunction with new ILS facilities. The term “transition” is used for convenience throughout this section in lieu of feeder route and initial approach segment associated with instrument approach procedure construction.

**a. General criteria.**

(1) Compass locators are not required at locations where satisfactory transitions can be established to the LOC course from supporting NAVAIDs unless holding at the compass locator is required.

(2) Compass locators are not required in ASR environment where radar service can be provided on a continuous basis. Where radar service is used for transitioning to the ILS, vectors to a point within the normal ILS clearance area are required to eliminate the procedure turn (NoPT). This does not impose a radar-fixing requirement as a condition for executing the approach procedure.

(3) An OM by itself must not be used to identify the point from which holding or a procedure turn is to be executed [see paragraph 2-4-6].

(4) A PT may be authorized from an intersection that overlies the OM or is established outside of the OM location. For planning purposes, the accuracy of the intersection should not exceed plus or minus one nautical mile.

(5) Transitions must not be established from outside of the normal clearance and buffer areas unless they have been flight checked and the minimum localizer clearance requirements are met. Where such a flight check is unsuccessful, an intersection must be established on the localizer course, or a lead-radial established within localizer coverage. When established on the localizer course, the transition route from a VOR or non-directional radio beacon (NDB) must be predicated on a NAVAID or fix which does not utilize the localizer; i.e., the fix must stand alone on a localizer course for definition [see paragraph 8-5-2.g(3) and figure 7-5-4]. Order 8260.3, paragraph 2-9-8.a applies.

(6) Transitions to the localizer (LOC) course, which permit a straight-in approach (NoPT), will be established in accordance with criteria for localizer intercept angles and length of intermediate segment described in Order 8260.3, paragraph 10-1-3.b, and depicted in figure 7-5-3. Although criteria permit localizer intercept of 15 degrees at one nautical mile from the OM, it is recommended that all intercepts be established no less than three nautical miles nor more than 10 nautical miles from the OM. In no case, will a straight-in approach be authorized from a transition that proceeds from a facility/fix directly to an OM or compass locator at outer marker (LOM) unless the facility/fix is established on the localizer course.

**b.** Satisfactory transitions. The standard for localizer usable distance/coverage is 18 nautical miles within  $\pm 10$  degrees of the localizer course, and 10 nautical miles for that area between 10 degrees and 35 degrees either side of the course. In determining the need for a compass locator, facility performance data may not be available for the development of transitions. Figure 7-5-1, figure 7-5-2, figure 7-5-3, and figure 7-5-4 depict normal clearance areas with a 2 NM buffer area established around the perimeter. These figures will be used for determining the need for a compass locator during initial facility planning and for the development of original procedures when flight check data is not available. The following general guidelines will apply:

(1) When a VOR or NDB fix exists, within the shaded area shown in figure 7-5-1, transitions may be established to a fix on the localizer course from which a procedure turn can be executed.

(2) When a VOR or NDB is located, within the shaded area shown in figure 7-5-2, and a fix can be established at the OM location in accordance with paragraph 7-5-2.a(4), a transition may be established to the fix from which a procedure turn can be executed.

(3) When a VOR, NDB, or satisfactory fix exists or can be established within the shaded area shown in figure 7-5-3, a transition may be established to the localizer course and a procedure turn is not required.

**Figure 7-5-1. Transition to Localizer Fix for PT**

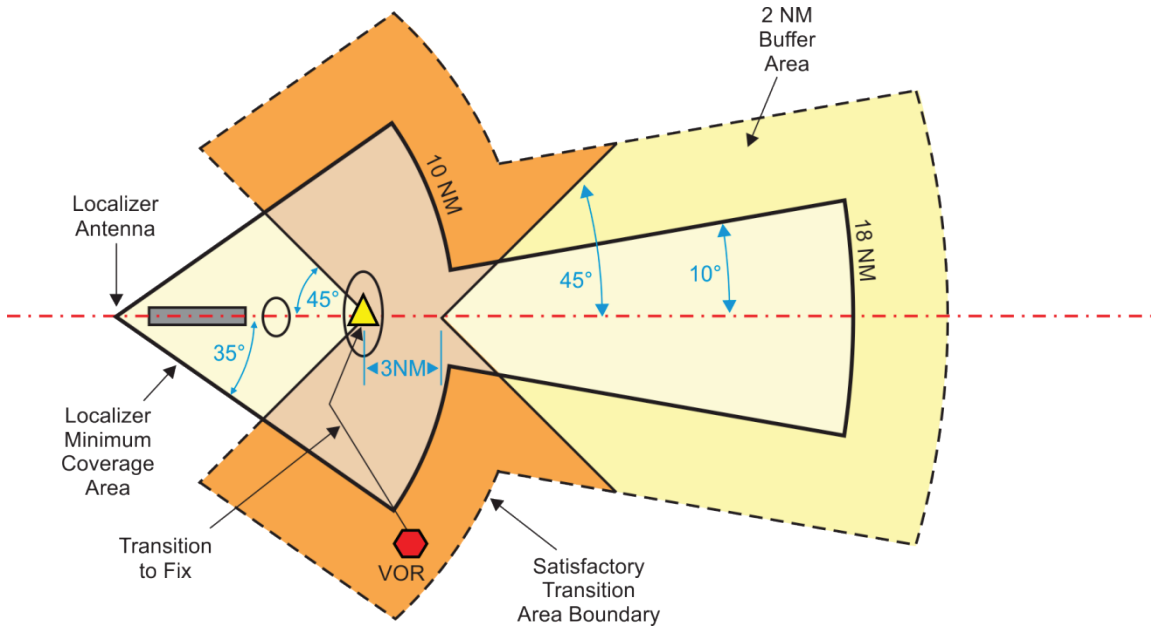

**Figure 7-5-2. Transition to OM for PT**

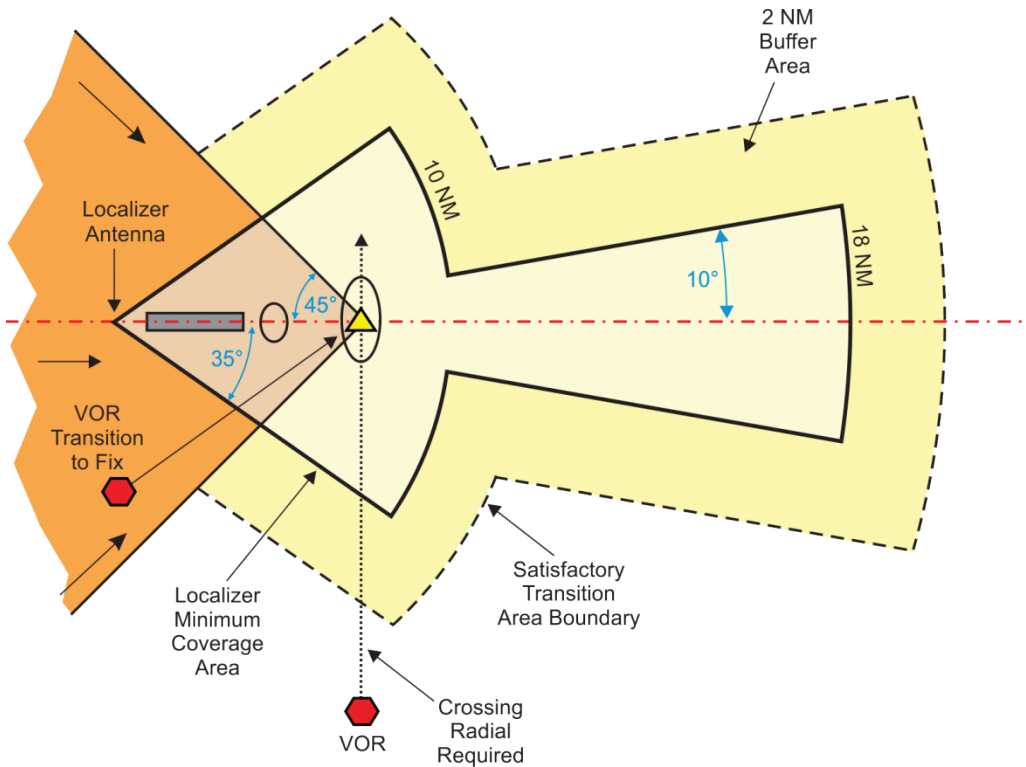

**Figure 7-5-3. Transition to LOC Course (NoPT)**

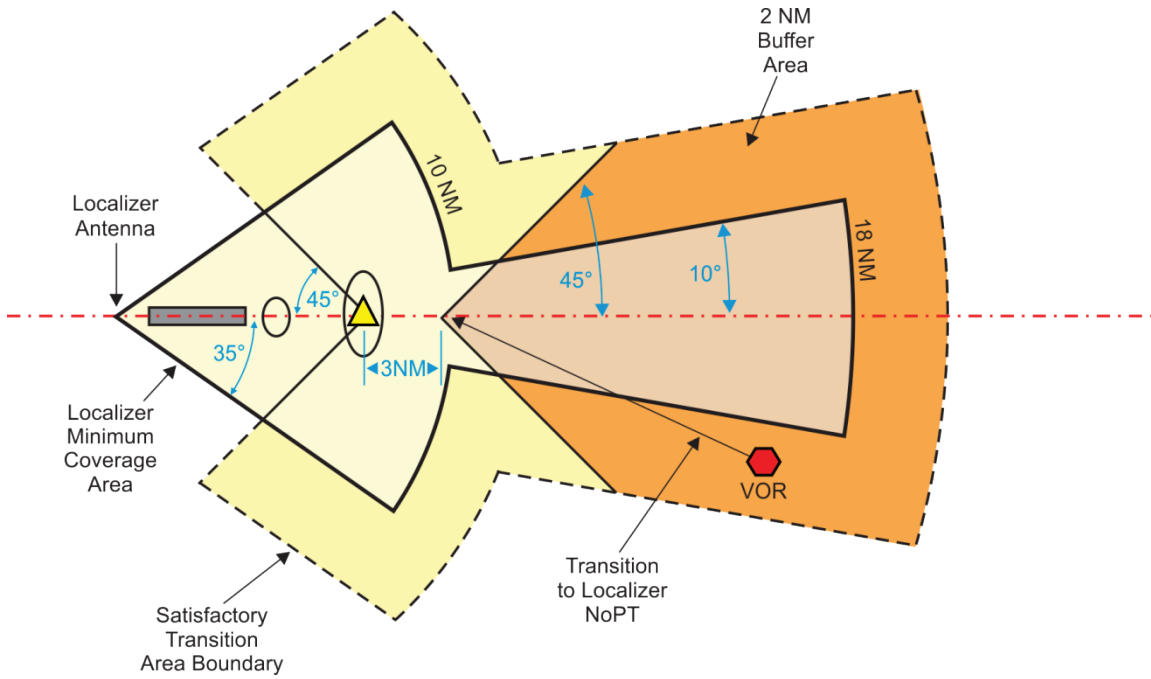

**Figure 7-5-4. Stand-Alone Fix on LOC Course**

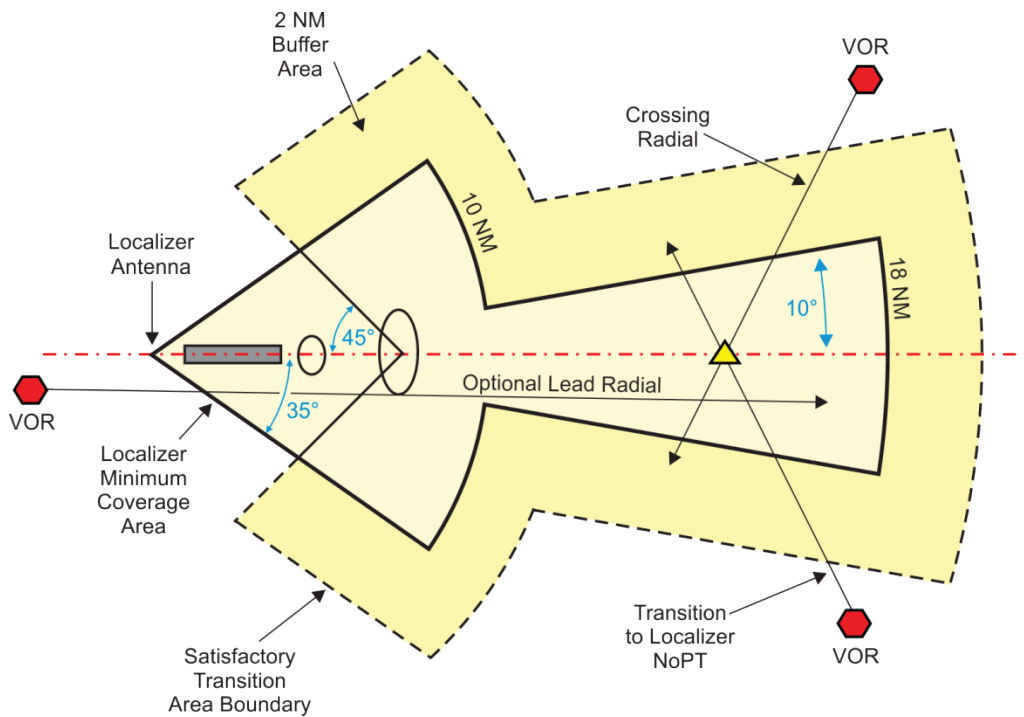

(4) Criteria for fix accuracy are contained in Order 8260.3, paragraph 2-9-8.a. Minimum divergence angle for PT fix is 45 degrees.

**c.** Locations that qualify for a compass locator. In determining the need for a compass locator, the local traffic flow, location of supporting facilities, and local terrain features must be considered. A compass locator may be planned for new ILS installations where one or more of the following conditions exist:

(1) In a non-radar environment where a transition cannot be established in accordance with paragraph 7-5-2.b.

(2) In non-radar environment where satisfactory transitions can be established in accordance with paragraph 7-5-2.b, but the flow of traffic is such that operational requirements cannot be satisfied and the lack of a compass locator would result in an unacceptable delay to arriving aircraft.

(3) In a radar environment where radar service cannot be provided on a continuous basis or where radar service will result in a prohibitive controller workload or would require additional positions and personnel to provide the radar service.

(4) In an area of precipitous or unusual terrain where special procedural design is required.

**d.** Approach procedure design. To the extent possible, ILS approach procedures must be designed to eliminate the compass locator as a required facility for the execution of the approach. Transitions must be established in accordance with the following:

(1) Original procedures. In designing original procedures prior to ILS commissioning, transitions must be limited to those that can be established in accordance with the general guidelines contained in paragraph 7-5-2.b unless a compass locator is programmed.

(2) Revised procedures. Following facility commissioning, additional transitions originating outside of the normal clearance and buffer areas may be established if they are found to be satisfactory through flight inspection evaluation.

(3) Use of DME. The use of DME to provide arc transitions or to provide additional means of identifying fixes can provide flexibility for users that are DME equipment. However, DME arc initial segments are not encouraged for reasons stated in paragraph 8-2-5.g(4). DME fixes established where an arc transition intersects the ILS course must be named. If DME is the only means of providing transitions or fixes, a compass locator should be provided.

**e.** Action. Applicable Service Area Flight Procedures Team personnel should make a map study at all planned or programmed ILS locations to determine if a compass locator is required. Priority should be given to approve ILS projects. Following this determination, all requirements for locators must be included in the F&E budget or submitted as a reprogramming action. Justification for each locator must be provided by Aeronautical Information Services by including an appropriate statement for each location as follows:

(1) Non-radar location. Conforms to paragraphs 7-5-2.c(1) and 7-5-2.c(2).

(2) Radar location. Conforms to paragraph 7-5-2.c(3).



## **Section 7-6. Airport Planning**

### **7-6-1. General.**

**a.** Familiarity. Since runway location, configuration, and alignment with respect to associated navigation facilities determine the IFR capability of an airport, applicable Service Area Flight Procedures Team personnel should be thoroughly familiar with all airports existing or planned in their areas of responsibility. Aeronautical Information Services specialists should have access to all available material relative to airport planning and development and be familiar with the AIP projects for which they are responsible. The AWO will participate as an ad hoc team member for airport-planning issues at IFR airports desiring improved low weather operations, or where safety issues dictate Flight Standards involvement.

**b.** Airport master plans or layout plan changes coordinated by the Office of Airports should be routed through AWOs and applicable Service Area Flight Procedure Team personnel for review and comment. Aeronautical Information Services should develop necessary coordination procedures with Airports division personnel.

## Section 7-7. Private Aid

### 7-7-1. General.

**a.** Informal discussions. The AWO and applicable Service Area Flight Procedures Team personnel will be called upon frequently by municipalities, private interests, or other government agencies for recommendations relative to the location and type of instrument approach facilities most practicable. This type of cooperation is encouraged. However, it should be made clear that informal discussions with sponsors of private facilities (non-federal) are advisory in nature and do not necessarily represent the FAA's official position nor commit it to a particular course of action. Flight Program Operations personnel should be familiar with the guidance in Order 6700.20, Non-Federal Navigational Aids and Air Traffic Control Facilities, regarding establishment of non-federal NAVAIDs.

**b.** Proposal process. Before private facilities can be installed and operated for private or public IFR procedural use, the proposal must be processed for airspace analysis and frequency allocation study. Also, agreements for the inspection and acceptance must be drawn in accordance with 14 CFR part 171 or other applicable administration directives. Requests received for establishment of non-federal electronic air navigational aid facilities must be forwarded to the appropriate Air Traffic Technical Operations Service Areas for initial processing [see Order 6700.20, paragraph 13].

**c.** Sponsor advice. Occasions will arise where a sponsor will seek advice concerning the use of a new type of navigational facility or a type that is not approved for use by the FAA. In these situations, the AWO and FPFO personnel must make no commitment with respect to the acceptability, installation, or procedural use of such facilities. Refer inquiries of this nature to the Washington Program Office for information and advice concerning appropriate handling of such matters. Sponsors of private facilities should be advised to direct formal requests or inquiries, relating to the approval and use of private facilities, to the appropriate Air Traffic Technical Operations Service Area for necessary review and processing. Contact the Flight Technologies and Procedures Division, for advice regarding the impact of new/emerging technologies on the facility proposal.

**Section 7-8. Facilities and Equipment (F&E) Support****7-8-1. Support.**

**a.** The responsibility for identifying improvements to operational minimums or for establishing safety requirements is jointly shared by the applicable Service Area OSG-FPT and the respective AWO. Section 1-2 specifies primary responsibilities of each organization. Additionally, each organization has unique skills and expertise that, in many situations, can be combined in a teamwork approach in the area of airport and navigational facility planning. FPT personnel serve in a team leadership role developing and recommending improvements to IFR procedures, operational minimums, and associated facilities.

**b.** It is expected that a Flight Program Operations/Flight Standards Service team approach will provide a method for AWO input on behalf of system users and operators, which addresses operation and safety concerns. Each team should establish a means of submitting its respective organization's input to the F&E budget.

**c.** The AWO also submits written justification for visual aids (not associated with IFR airports) and provides technical advice for IFR studies or recommendations that may not meet established standards; e.g., require Flight Standards' approval for waiver or NCP.

THIS PAGE IS INTENTIONALLY LEFT BLANK

**Chapter 8. Instrument Approach Procedures Data Transmittal System****Section 8-1. General****8-1-1. General.**

**a.** FAA forms. 8260-series forms are used for the documentation and publication of instrument flight procedures. Aeronautical Information Services and other charting agencies publish instrument flight charts based on data contained on these forms. Documentation examples provided throughout this order are to be used to promote standardization and clarity for chart producers and product users. However, these examples do not cover every situation. When these situations occur, contact Aeronautical Information Services QA staff for guidance.

## Section 8-2. FAA Form Use and Preparation

### 8-2-1. Use of FAA forms.

**a.** Procedures published under 14 CFR part 97. Standard instrument approach procedures, fixed-wing, and helicopter, authorized for public use are approved by Aeronautical Information Services and published as rules in the Federal Register by Flight Standards Service using reference to FAA standard forms. An index of all original SIAPs, amendments, and cancellations is published in the Federal Register to provide public notice of the rulemaking actions. Instrument approach procedures must be prepared on the forms listed below or approved computer generated equivalents, as suitable for reproduction.

(1) Form 8260-3, ILS Standard Instrument Approach Procedure, [ILS, GLS, RNAV (GPS or RNP), and LDA (when associated with a glide slope)].

(2) Form 8260-4, Radar Standard Instrument Approach Procedure.

(3) Form 8260-5, Standard Instrument Approach Procedure, (LOC, LDA, VOR, VOR or TACAN, NDB, SDF, RNAV (VOR/DME), and other nonprecision procedures).

**b.** Special use procedures. Special use instrument approach procedures are documented on Form 8260-7A. A Form 8260-7B must also accompany the Form 8260-7A when issued to an operator. These procedures are developed for individual operators and are issued to the user through Operations Specifications or Letters of Authorization [see Order 8260.60, Special Instrument Procedures].

(1) Radar special procedures. If there is a requirement for a radar special procedure, use Form 8260-4 in lieu of Form 8260-7A. Delete reference to 14 CFR part 97.31 and add the word "Special." Use the Form 8260-7B to document the approval and to provide for incorporation in the Operations Specifications.

(2) Completing Form 8260-7A. Instructions for completion of Forms 8260-3 are also applicable to Form 8260-7A, except as follows [see paragraphs 8-6-11.o(10)]:

(a) If a newly established fix is required for the Special procedure, the fix must be documented on a Form 8260-2 and processed in the normal manner [see paragraph 8-5-2]. The FPT must provide a copy to the user. When an existing fix will be used for a Special instrument procedure, the current Form 8260-2 for that fix must be updated to reflect current fix use [see paragraph 8-5-2.j].

(b) IFR departure procedure/takeoff minimums. At locations where a diverse departure evaluation to each runway authorized for IFR takeoff [see Order 8260.3, current edition, for departure procedure criteria requirements] reveals that standard takeoff minimums cannot be authorized and an ODP does not already exist, an ODP must be established. A special ODP and/or SID must be documented on the appropriate 8260-15 series form under the latest edition of Order 8260.46. The Form 8260-7A for the approach procedure will indicate the need to "See Form 8260-15A for this airport," so a Form 8260-15A must accompany the Special

approach procedure when charted and/or disseminated. If a public SIAP exists for the airport, the published public ODP, if one was required, applies.

(3) Completing Form 8260-7B. This form will accompany all Special instrument procedures and be incorporated as an amendment to the operations specifications of the certificate holder. The form may also be issued with a Letter of Agreement (LOA) to part 91 operators. A separate Form 8260-7B is required for issuance of each Special ODP and/or SID. The requirements documented on this form will be developed and approved by either the Flight Operations Branch or the Performance-Based Flight Operations Branch (as appropriate).

c. Departure Procedures/Takeoff Minimums. Use 8260-15-series forms to document DPs and takeoff minimums. Refer to Order 8260.46 for instructions.

### **8-2-2. FAA form preparation.**

a. Preparation. All entries may be in upper case letters or as defined in the examples in this chapter. Form 8260-3 has the title information and appropriate 14 CFR part 97 subpart pre-printed. When other procedures are documented, delete the term “ILS” and substitute the desired equipment acronym in its space. Form 8260-4 has the title information and appropriate 14 CFR part 97 subpart pre-printed. On Form 8260-5, enter the type of procedure, as listed below, in the space preceding the phrase “Standard Instrument Approach Procedure.” For instrument procedures developed by the FAA for the military that are not processed under 14 CFR part 97, in place of the 14 CFR part 97 subpart portion on the applicable FAA Form, insert the applicable abbreviation for the service component; i.e., “USA” for U.S. Army, “USAF” for U.S. Air Force, and “USN” for U.S. Navy. See Order 8260.15 for processing of USA procedures and Order 8260.32 for processing of USAF procedures.

b. Appropriate 14 CFR part 97 subparts for individual types of procedures are:

- (1) 97.23 VOR, TACAN, and VOR or TACAN.
- (2) 97.25 LOC, LDA, and SDF.

**Note:** LDA includes those that also may have a glideslope.

- (3) 97.27 NDB.
- (4) 97.29 ILS and GLS.
- (5) 97.31 RADAR.
- (6) 97.33 RNAV [includes (GPS), (VOR/DME), and (RNP)].
- (7) 97.35 COPTER (includes all Copter SIAPs, regardless of navigation sensor).
- (8) 97.37 Takeoff Minima and Obstacle Departure Procedures.

c. Combined charting. Certain instrument approach procedures can be combined on one chart where procedural data are compatible. Where an NDB or compass locator is established at an ILS outer marker site, the individual ILS and NDB procedures should be developed in a manner that will permit combined charting, provided TERPS criteria can be complied with for both procedures. Different types of civil instrument approach procedures must not be combined on SIAP forms except for “ILS or LOC” and “VOR or TACAN” SIAPs predicated on VORTAC facilities. SA CAT I and SA CAT II procedures may be combined on the same chart. CAT II and CAT III procedures may be combined on the same chart. Where military offices request combined procedures based on different types of facilities, document separate but compatible procedures on the appropriate forms. Combining of instrument approach procedures on military charts will then be accomplished as a cartographic function of the National Geospatial-Intelligence Agency (NGA). RNAV approach procedures may only depict a single procedure track from the IF through the missed approach. If different tracks are required inside the IF (e.g., for different aircraft categories), separate procedures must be published. See paragraph 8-6-7.b(3)(b) for an exception where RNAV (RNP) procedures could have multiple intermediate segments.

### **8-2-3. Course and distance information.**

a. Application. Assigned magnetic variation must be applied to terminal routes as follows [see paragraph 8-6-2.1]:

- (1) Facility to facility: Variation of the first facility applies.
- (2) Dog leg: Variation of each facility forming the route applies to its segment.
- (3) Fix to facility or facility to fix: Variation of the facility applies.
- (4) RNAV routes: See paragraph 2-5-3.g(2).
- (5) Dead reckoning: Variation of the next facility providing course guidance applies.

b. Calculations must be made using the most accurate data available (bearings and distances to two decimal places). Magnetic variation of record, in whole degrees, is then applied.

c. Data elements. Except where otherwise noted, enter data elements relating to course, bearing, and distance to the nearest hundredth value. Final results are rounded by Aeronautical Information Services.

d. Rounding. Where rounding to the “nearest” value is appropriate, and except where otherwise required, round numerical values .01 through .49 DOWN, and .50 through .99 UP. This applies to distances, elevations, altitudes, degrees, etc. For example, 1100.49 feet becomes 1100 feet, while 1100.50 feet becomes 1101 feet. Similarly, 131.49 degrees becomes 131 degrees, while 131.50 degrees becomes 132 degrees.

### **8-2-4. Communications data.**



**a.** Communications requirements and frequencies for inclusion on instrument approach procedures charts will be provided by NFDC.

**b.** Where specific local communication requirements exist for published instrument approach procedures, enter one of the following under “Additional Flight Data:”

(1) Where approach control service is provided by ARTCC through a remote site: “Chart Indianapolis Center frequency.”

(2) Where approach control service is provided through the controlling Flight Service Station (FSS) by LRCO or RCO. The controlling FSS will be indicated: “Chart Indianapolis Radio LRCO (RCO).”

(3) Where the primary altimeter source is obtained from a remote (different airport location) Automated Weather Observing System (AWOS)/Automated Surface Observing System (ASOS), chart the airport location: “Chart Flippin Muni AWOS-3.”

**8-2-5. Terminal routes - General.** Terminal routes consist of feeder, initial, and intermediate approach segments. They provide aircraft guidance from the en route airway structure to the final approach fix. Specify a minimum number of routes required to satisfactorily transition the aircraft to the terminal environment. See paragraph 8-6-4 for instructions on adding this information to the applicable 8260-series form.

**a.** Non-radar routes. Since radar vectoring is an approved method of providing procedure entry, limit the number of non-radar routes where radar vectoring is provided on a 24-hour basis. Where practical, provide at least one non-radar route to ensure transition from the en route structure in the event of radar/communications failure. Radar vectoring may be provided through any approach segment up to and including the final approach fix (intermediate fix with ARSR) [see paragraphs 4-1-5.c and 8-6-9.g].

**b.** Transition. Do *not* develop instrument approach procedures that require “DME or Radar” as the sole means for procedure entry if any other type of transition is available, unless specifically requested by ATC. It is not necessary to designate terminal routes which coincide with segments of the en route structure; however, these routes must be designated when a lower altitude is authorized or when clarity is essential. With the exception of arc feeder segments, terminal routes (including arc initial approach segments) originating on an airway at other than a navigation facility require the establishment of a named fix to identify the starting point of the route. The fix must be common to the en route structure and instrument approach procedure [see paragraph 8-6-9.g].

**c.** Turn limitation. When a procedure turn or holding pattern entry is not authorized, and airways or routes, which are not specified as terminal routes lead to the fix where the intermediate segment begins, the procedure must ensure that the angular limitation on turns over the intermediate fix is not exceeded. This is not mandatory when ATC agrees to provide full-time radar vectoring service for these routes.

**d.** Charting. All terminal routes listed in the “Terminal Routes” section of the 8260-series forms must be charted or identified in the planview of the instrument approach chart.

e. Feeder routes. Where feeder routes are established to transition from the en route structure, they must terminate at another feeder fix, or an initial approach fix, or at the facility from which a procedure turn or holding pattern entry is authorized. Additionally, when feeder routes *do not* meet the alignment criteria specified in Order 8260.3 or Order 8260.58, the routes must be annotated to deny use when arriving from a specified direction.

**Examples:**

When a feeder fix is over a facility:

“Chart planview note: Procedure NA for arrival on ABC VORTAC airway radials 233 CW 338.”

When feeder fix is on an airway:

“Chart planview note: Procedure NA for arrivals at RUDVE on V140 Westbound, and arrivals at MCJEF on V140 Eastbound.”

f. Multiple DME sources. When an ILS (or LOC or LDA) facility has collocated DME, it is necessary to reduce the potential for confusion with other DME sources in the terminal area. Failure to tune to the ILS DME when inbound can result in incorrect fix indications. Apply the following guidance:

(1) Delete the requirement to use two DME facilities on ILS or LOC/LDA procedures wherever possible.

(2) Delete DME arcs to LOC/LDA courses at locations where radar vectoring is possible. In some locations, this may require a note: “Radar Required.” See paragraph 8-6-8. Where radar is not available, delete DME arcs where an alternate means of procedure entry is available.

(3) On procedures using two DME facilities, one of which is associated with a LOC or LDA, and both of which are forward of an aircraft on the LOC/LDA course, the following is required: “Chart profile note: Use I-XXX DME when on the localizer course.” This applies to front and back course procedures regardless of glide slope availability.

**g. Initial approach segments.**

(1) Initial approach segments not requiring a course reversal. Evaluate the flow of air traffic to determine the need for routes that do not require a course reversal, i.e., fixes, STARS, airways, waypoints. Where a route can meet alignment and descent gradient requirements, a course reversal should not be established. Where a course reversal has been established on an instrument approach, initial segments which meet alignment and descent gradient requirements for a straight-in approach must have a designation of “NoPT” for that applicable route [see paragraph 8-6-4.a(3)]. When a STAR terminates at an IF/IAF and alignment and descent gradient requirements are met that do not require a course reversal, in the “Notes” section of the 8260-series form use: “Chart planview note: NoPT at (fix name) for arrival on [procedure(s) name] Arrival” (this may result in more than one note for NoPT authorization). If a course reversal is not authorized for any of the terminal routes, the NoPT designation is not appropriate; indicate instead that a procedure turn is not authorized [see paragraph 8-6-4.a(3)].

(2) Specify an arrival sector from which course reversal must not be made when NoPT designations will result in an excessive number of terminal routes. Place an applicable statement in the “Notes” section of the 8260-series form.

**Examples:**

When a course reversal is over a facility:

“Chart planview note: NoPT for arrival on ABC VORTAC airway radials R-302, R-355, and R-096.”

When a course reversal is over a fix:

“Chart planview note: NoPT for arrival at NICOL on V244 Westbound, V230 Southwest bound.”

When an IAF is over a facility:

“Chart planview note: Procedure NA for arrival on ABC VORTAC airway radials 233 CW 338.”

When an IAF is over a fix on an airway:

“Chart planview note: Procedure NA for arrivals at RUDVE on V140 Westbound, and arrivals at MCJEF on V140 Eastbound.”

(3) Initial approach segments based on straight courses. All initial approach segments that meet criteria for angle of intercept between the initial and intermediate segments [see Order 8260.3, paragraphs 2-4-3.a(1) and 2-4-3.a(2)] must join the intermediate segment at a common intermediate fix where possible. Where more than one segment joins at a common fix, a common altitude should be selected whenever descent gradient is not compromised.

(4) Arc initial approach segment. Requirements for arc initial approach segments must be fully evaluated to determine if this type of procedure entry is essential to the local traffic flow. Experience indicates that arc initial segments have been established at locations where they are used on a very limited basis or have not been fully accepted by the user. Long arcs and/or multiple arcs have contributed to undesirable chart clutter with minimum operational advantage.

(a) An arc initial segment in a radar environment must not be authorized unless it is operationally required.

(b) When a DME arc segment of an approach lies along an arc that traverses an area of unusable radial information, the provisions of Order 8200.1 apply.

(c) Arc initial segments should be authorized via the shortest routing when flight time can be reduced.

(d) Arc initial segments must be designated by CW for clockwise and CCW for counter-clockwise.

(e) Arc initial segments must be designed to satisfy requirements for executing the instrument approach. They must *not* be established for the convenience of routing aircraft around a terminal area.

(f) Arc initial segments less than three nautical miles in length are not recommended. Use of aircraft heading to intercept the intermediate course should be considered as an alternate action in lieu of short arc segments.

(g) DME Arc courses must be predicated only on collocated facilities providing azimuth and DME information. Arc initial segments must not be authorized on DME collocated with ILS or localizer facilities due to the lack of constant azimuth information. See Order 6050.32 for collocation parameters.

(5) An arrival holding pattern may be established at the beginning of an initial segment when requested by ATC to support local operational needs. An arrival holding pattern must not be used to function as a “hold-in-lieu of procedure turn” in order to accommodate descent gradient requirements and/or used to mandate a course reversal.

**Note:** A hold-in-lieu-of-PT is only permitted at a FAF (non-RNAV procedure) or at the beginning of the intermediate segment [see Order 8260.3, paragraph 2-4-5.e].

**h.** Lead radials. In addition to the angle of interception requirements of Order 8260.3, paragraph 2-4-2.a(1), a 2 NM lead radial (1 NM for Copter procedures) must be published with arc initial approaches when the DME is not collocated with the facility providing the procedural course guidance. The lead radial provides information for aircraft with single receiving equipment to change the receiver to the localizer or other facility providing the course guidance and to ensure the aircraft is within the clearance coverage area of localizer (LOC) facilities before changing frequency or accepting on-course indication.

**i.** Intermediate segments.

(1) When a procedure turn or holding pattern entry is authorized at the FAF and a straight-in intermediate segment (without initial) is also authorized, data on the intermediate segment must be included in the terminal routes block. In this situation, add (IF) and (NoPT) to the intermediate segment.

(2) When the course reversal fix is outside the FAF, the segment(s) from the course reversal fix to the FAF must be included in terminal routes, unless both fixes are marked by DME from the same source or LOC minimums are not authorized.

(3) When a procedure turn or holding pattern in-lieu-of-PT is not authorized, enter pertinent data in the “Terminal Routes” section and on lines two and four of the 8260-series form [see paragraph 8-6-7.b(2)].

(4) Develop intermediate segments for all IAPs except “hold-in-lieu-of-PT” and “PT No-FAF” procedures. Where an intermediate fix has been established, it will be defined on the procedure in the planview and profile view. See paragraph 8-6-7.b(3) exceptions for profile view charting when there are multiple intermediate segments in the instrument approach procedure (IAP).

**j.** RNAV procedures must have a hold-in-lieu-of PT course reversal maneuver established at the waypoint designated as “IF/IAF” (when one is established) on all procedures based on the

“Basic T” design and its derivations. If the waypoint is identified only as “IF,” a hold-in-lieu-of PT is not required.

**8-2-6. Terminal fixes.** Name terminal fixes in accordance with paragraph 2-10-5 and document on Form 8260-2. Named facilities do not require this documentation unless holding is established.

**a.** Computer navigation fixes. Name CNFs using a five-alpha character non-pronounceable name. To distinguish CNFs from conventional reporting points, fixes, and intersections, enclose the name in parenthesis; e.g., (CFWBG) on 8260-series forms other than the Form 8260-2.

**b.** Audit trail. List terminal procedures using a fix in the “Fix Use” section of the Form 8260-2. This helps ensure that affected procedures are not overlooked when the fix is modified.

**c.** DME references. When designating fixes on Forms 8260-3, 8260-4, 8260-5, and 8260-7A include DME references to the hundredth of a NM when DME is appropriate and available. Provide the fix name and DME distance as follows:

(1) DME fix, with course and DME from the same facility: JOANI/7.00 DME

(2) DME fix, with DME not paired with course facility, identify fix and facility providing DME: JOANI/ABC 7.00 DME. If both facilities have the same three-letter identifier, fully identify the DME facility: JOANI/XYZ VORTAC 7.00 DME.

(3) Intersection fix, with DME available from more than one facility forming the fix, identify the intersection and the facility providing the required DME information: JOANI INT/ABC 7.00 DME. If both facilities have the same three-letter identifier, fully identify the DME facility: JOANI INT/XYZ VORTAC 7.00 DME.

**d.** A full description of a fix must be documented on the form. For RNAV procedures, describe a fix by name only. Aeronautical Information Services will chart fixes under what is known as the “hierarchy concept.” This means if no NAVAID or ground-based fix exists, the point will be charted as a waypoint. Except for RNAV procedures, when a fix is included in the missed approach instructions, use a full description of a fix appropriate to its use in the missed approach procedure.

**Example:**

Fix name: MORIS LOM/INT/7.00 DME. “CLIMB TO 3600 DIRECT MORIS LOM/INT/7.00 DME AND HOLD.”

Fix name: DAVEE INT/16.00 DME. “CLIMB TO 3600, THEN CLIMBING RIGHT TURN TO 4000 on ABC VORTAC R-180 TO DAVEE INT/16.00 DME AND HOLD.”

**RNAV Example:**

“Climb to 2000 direct DAKEY and hold.”

**e.** When no fix overlies an LOM, the identifier or the five-letter name may be used: AB LOM or ABBAH LOM.

**f.** An alternate method of identifying an LOM, such as an INT or DME, is often helpful in ILS or LOC SIAPs but an INT is not appropriate in NDB SIAPs.

**g.** Along track distance references. Include ATD fix values with respect to the MAP on all named and unnamed (VDP) fixes *within a RNAV final approach segment* [see paragraph 8-6-10.n for VDP application].

**Example:**

MAP at LTP: “IDEDE/3.50 NM TO RW16”

MAP not at LTP: “BARBB/3.50 NM TO CORDL”

**h.** RNAV must not have a hold-in-lieu-of-PT (course reversal) or missed approach holding established at the FAF.

### Section 8-3. Certification, Processing, and Review

**8-3-1. General.** Certifying, processing, and reviewing instrument approach procedures must be accomplished as outlined in this section.

**8-3-2. Certification and processing of SIAPs.** Certification of instrument approach procedures must be accomplished on the reverse side of the appropriate 8260-series form. Instructions for completion of the entries are contained in section 8-6 and as follows:

**a.** Required effective date. The effective date must be either “Routine,” “Concurrent,” or “Hard.” See Order 8260.46 for guidance regarding effective date entries for departure procedures.

(1) Routine dates. If a specific effective date is not required, enter the word “ROUTINE.”

(2) Concurrent dates. If the SIAP is part of a large package and/or publication is to be concurrent with another event, as when it is associated with an airspace case, enter the word “Concurrent.” Use the following standard note in the “Required Effective Date” block: “Concurrent with KOKC ILS or LOC RWY 17R Amdt 8,” or “Concurrent with [enter Airspace Docket name/number].”

(3) Hard dates. Hard dates apply to procedures based on navigation facilities receiving a magnetic variation rotation, all other associated procedure changes based on a magnetic variation change will use the concurrent date, see paragraph 8-3-2.a(2). For example, a VOR is rotated and the VOR approach will have the hard date, but the RNAV approaches at that location would use the concurrent publication date. Additionally, hard dates may be applied to runway construction projects and ILS glideslope angle changes when necessary. When a hard date is required, enter the applicable AIRAC cycle date the procedure must be published on, e.g., 12/10/15. Use of hard dates requires updating the NFDC database and publication in the NFDD 51 days prior effective date for en route data and 34 days for non-en route data. Hard dates are not to be used as an “easy to use” option.

(4) Deviations. Refer to Order 8260.26 when deviations to the above guidance, procedure submission cutoff suspenses, and effective date assignment are required.

**8-3-3. Cancellation/Suspension of Instrument Approach Procedures.** Cancellation/suspension of instrument approach procedures must be accomplished on the same form number as required for documentation of the SIAP.

**a.** Cancellation of a SIAP. All items on the forms must be left blank, except Airport, Airport ID, Procedure Name, Original/Amendment, City, State, Airport Elevation, TDZE, Superseded, Original/Amendment, Dated, Required Effective Date. This line must duplicate the currently effective SIAP. The following notation must be typed in the “Terminal Routes” section: “Procedure *canceled* effective \_\_\_\_\_.” (Aeronautical Information Services will fill in the date). Complete the “Coordinated with,” “Developed by,” and the “Approved by” blocks. If applicable, enter in the Changes-Reasons block, for example: “Concurrent with VOR RWY 18, Original.”

**b.** Suspension of a SIAP. If a procedure must be removed from a publication temporarily due to the 224-day time limit for Temporary NOTAMs, it can be suspended for an indefinite time period. These “Suspended” procedures will continue to be maintained (to include periodic flight inspection, *if possible* (see Note, below), and OE applications). Document on the applicable 8260-series form, “Procedure *suspended* effective \_\_\_\_\_” in the “Terminal Routes” block (i.e., the same process as if it were a cancellation, including signature blocks) and in the Changes-Reasons block, provide a reason for the suspension and an *estimated* publication return date, if unknown, state “Indefinite.” When the procedure is ready to be re-published, attach a copy of the suspended procedure to a new form that will serve as a cover sheet that must contain, “Procedure reinstated effective \_\_\_\_\_” in the “Terminal Routes” block. However, if the procedure has to be Amended at the time of reinstatement, process the procedure as if it were a regular Amendment and as the first (top) entry in the “Additional Flight Data” block, enter: “Reinstated Procedure-Amended.” The suspension and reinstatement must be published in the TL with all the other procedures to ensure charting agencies react accordingly.

**Note:** If Flight Inspection determines that it is not possible or practical to conduct the periodic flight inspection during the procedure suspended time period, they may delay conducting it until such time it is needed. When doing so, they must inform Aeronautical Information Services that it is being delayed and coordinate the date of intended reinstatement [see Order JO 8200.44, current edition, chapters 2 and 5 for Aeronautical Information Services and Flight Inspection responsibilities].

**8-3-4. Revisions to IFPs.** Some amendments to SIAPs and textual ODPs may qualify to be administered via P-NOTAM as specified in Order JO 7930.2. When a P-NOTAM is not used, complete, and process revisions to IFPs using the applicable 8260-series form. The guidelines listed below apply. Table 8-3-1 is provided to assist in the application of the guidance identified below. See paragraph 4-5-1.d for STAR revisions and Order 8260.46, chapter 2, for revisions to departure procedures.

**Note:** The purpose of the procedure amendment process is to provide an expeditious means to incorporate changes to IFPs. Cancellation and reissue of an IFP is permitted when deemed necessary and for reasons other than listed below.

**a.** Cancellation of an existing procedure and establishment of an original procedure is required when:

(1) The 14 CFR part 97 subpart changes as a result of a change in equipment required to fly the procedure; e.g., “LOC” to “ILS or LOC;” “ILS” to “LOC;” etc. [see paragraph 8-2-2.b].

(2) The procedure ID is changed from “VOR-A” to “VOR-B,” etc.

(3) When “L,” “C,” or “R” designation is added or removed from the procedure title; e.g., “VOR RWY 18L/R” is changed to “VOR RWY 18L.”

(4) The navigational aid (NAVAID) providing final course guidance is relocated and the relocation changes the published final approach course ground track.



(5) The reference NAVAID is changed to another facility on a RNAV (VOR/DME) procedure.

(6) Straight-in minimums are added or deleted that require change to the procedure ID; e.g., “NDB RWY 28” to “NDB-A” or “NDB-A” to “NDB RWY 28.”

(7) When a Special procedure is converted to a public, 14 CFR part 97, procedure.

(8) When a runway is re-located and the parameters exceed the values in paragraph 8-3-4e(2)(a), and the current numbering is retained; e.g., runway 14/32 is moved 400 feet NE of its current position.

**Note:** This paragraph does not apply to a runway where the length has been extended or reduced; e.g., Runway threshold displaced or existing runway extended 200 feet.

**b.** Procedure amendments. When a procedure is amended, the amendment number must be advanced and periodic review requirements met for all the procedures documented on the specific form being completed [see paragraph 2-8-2]. Amendment of a procedure is required when:

(1) The airport/heliport identifier and/or name is changed.

(2) The associated city name/state is changed.

(3) The name, facility type, and/or identifier of any NAVAID is changed, including those mentioned in the “Additional Flight Data” and “Missed Approach” blocks of the 8260-series form.

(4) Any NAVAID or marker beacons used in the procedure are decommissioned.

(5) The runway numbering is changed.

(6) A secondary equipment requirement is added to or deleted from the procedure and the procedure ID does not change; e.g., adding “DME Required” Note.

(7) The Procedure ID changes; e.g., from “GPS” to “RNAV (GPS)”;

“VOR/DME to VOR;” “VOR” to “VOR or TACAN”; “ILS” to “ILS or LOC.” This includes the addition/deletion/modification of any straight-in procedure suffix; e.g., from “RNAV (GPS) RWY 36” to “RNAV (GPS) Z RWY 36.”

(8) Adding a segment to an instrument procedure [see paragraph 8-3-4.c].

(9) Deleting a segment of an instrument procedure.

(10) Changing runway threshold/end location and/or any published fix location or makeup [see paragraph 8-3-4.c].

(11) Changing any published fix name only.

(12) Changing a charted “magnetic” course/bearing/heading that does not alter the existing ground track.

(13) Changing a charted course/bearing/heading that would alter the existing ground track [see paragraph 8-3-4.c].

(14) Increasing an altitude.

(15) Lowering an altitude [see paragraph 8-3-4.c].

(16) Any published distance is changed which:

(a) Requires a change to the time/distance table.

(b) Is 0.1 NM or greater for distances inside the FAF.

(c) Is 0.5 NM or greater for distances outside the FAF.

**Note:** For non-RNAV procedures only, when any published distance is changed which is less than 0.5 NM for distances outside the FAF, or less than 0.1 NM for distances inside the FAF, the change may be delayed until the procedure is next amended.

(17) Any minimums change to include adding another line of minimums (including CAT II/III and SA CAT II), deleting minimums, increasing minimums, lowering minimums, and returning minimums to their previous value after a temporary condition. An amendment is also required when adding SA CAT I minimums to a runway where standard CAT II minimums have not been established [see paragraph 8-3-4.c].

(18) The airport elevation or touchdown zone elevation is changed and minimums are affected. When published minimums are not affected, include these changes in the next amendment [see paragraph 8-3-4.e(2)].

(19) Frequencies are changed in notes on the Forms 8260-3/4/5/7A, or military equivalent.

(20) Lighting changes occur that affect published visibility and/or renders a procedure unusable at night.

(21) Changes to plan view, profile view, or briefing strip chart notes [this includes adding the chart note specified in paragraph 8-6-11.k(1)].

(22) Changes to charted obstacles that are identified on the 8260-series form, in the “Additional Flight Data” block.

**c.** Abbreviated amendments. An abbreviated amendment differs from an amendment in that not all forms are re-accomplished and in some cases, flight inspection/validation is not required. See Order JO 8200.44, Coordination of Flight Inspection Procedure Packages, for guidance on what must be submitted. All of the items in paragraph 8-3-4.b may be promulgated via an abbreviated amendment except those listed in paragraph 8-3-4.b(8), 8-3-4.b(10), 8-3-4.b(13), and

8-3-4.b(15). Regarding paragraph 8-3-4.b(17), an abbreviated amendment may not be used to establish another line of minimums or lower minimums. An abbreviated amendment may be used to remove, increase, or return minimums to their previously published level at the end of a temporary condition, or to add SA CAT I minimums to runway with an existing standard CAT II procedure. When required, first promulgate the changed condition via T-NOTAM and follow up with only the source 8260-series form(s). When completing the 8260-series form to support an abbreviated amendment, apply the following:

(1) Revise the amendment number to an alphanumeric format by adding an alphabetical suffix following the amendment number; e.g., Amdt 3B; Orig-A.

(2) Update the 8260-series form to reflect all previous P-NOTAM amendments not yet incorporated on the form.

(3) Complete the “Changes and Reasons” block of the form indicating the changes in the T-NOTAM as well as those of previous P-NOTAMs incorporated. Include cancellation of the T-NOTAM. Be specific in indicating the changes and reasons, e.g., “MDA changed from 880 to 820 feet”; “MDA returned to previous altitude; temporary crane removed.”

(4) Enter “Routine” as the required effective date.

(5) Coordinate changes with appropriate organizations, as necessary.

**d.** No amendment is required when:

(1) Frequencies are changed which were *not* entered in notes on the Forms 8260-3, 8260-4, 8260-5, 8260-7A, or military equivalent.

(2) When the name of an airport mentioned in the “Notes” block of the 8260-series forms is changed; e.g., “Use Batesville/Batesville Regional Altimeter setting.”

(3) Changes to uncharted obstacles, names of secondary airports shown in the Planview, lighting and communications items included in the “Additional Flight Data” block of the 8260-series form.

(4) Lighting changes occur that do *not* affect published visibility.

(5) Fix coordinates are changed, which do not require a change to the procedure chart or any FAS data block items on LPV or LP SIAPs that may affect the CRC remainder code [see paragraph 8-3-4.b(11)].

**e.** Changes to the NAS infrastructure that require procedure amendments under subparagraphs 8-3-4.b and 8-3-4.c must be pre-coordinated with the Aeronautical Information Services, Instrument Flight Procedures Team, by the NFDC to become effective on a 56-day AIRAC charting date and must be effective concurrent with procedure amendments. Every effort must be made to allow changes to be effective as soon as possible, but no later than one year after the receipt or as coordinated. This will ensure instrument procedure availability to the

maximum extent possible, lessen impact on airport IFR operations, and ensure chart/database harmonization.

(1) When uncoordinated physical changes have been made; e.g., runways have been re-numbered, NFDC will not publish (e.g., in the NFDD) such changes until an agreed upon date. Aeronautical Information Services, Instrument Flight Procedures Team, will promulgate the information affecting the instrument procedure via the applicable NOTAM type, pending assignment of a coordinated effective date.

(2) Aeronautical Information Services, Instrument Flight Procedures Team, must be notified immediately of changes to airport reference points, airport field elevations, touchdown zone elevations, and runway threshold locations/elevations to assess the impact on instrument procedures. Aeronautical Information Services, Instrument Flight Procedures Team, is allowed 28 calendar days to evaluate reported changes, surveys, etc., and respond to the NFDC. If Aeronautical Information Services, Instrument Flight Procedures Team, does not respond to reported changes within 28 days, changes within the following tolerances may be promulgated via NFDD when verified.

(a) The following runway threshold parameter changes are deemed to have no impact on instrument approach procedures:

± 50 feet or less longitudinally

± 10 feet or less laterally

± 3 feet or less vertically

(b) Changes that exceed the tolerances above require immediate NOTAM action to ensure safety and procedural currency. Procedure amendments will be made within the specified timelines defined in section 2-8.

(3) All NAVAID position changes must be evaluated for impact by Aeronautical Information Services, Instrument Flight Procedures Team, prior to promulgating the revised information.

(4) Changes to airport identifiers must also be coordinated with Aeronautical Information Services, Instrument Flight Procedures Team, to assess the impact on instrument procedures. Airport identifier changes affect avionics coding for procedures and in some cases require procedure amendments.

**f.** Aeronautical Information Services, Instrument Flight Procedures Team, may change the following chart related products without supporting procedure amendments; i.e., P-NOTAM or 8260-series form:

(1) Marker beacons decommissioned and not identified as a FAF, stepdown fix, or MAP on the procedure source document may be removed from chart depiction based on NFDD publication.

(2) Lighting changes may be made to airport sketches and the Chart Supplement when published in the NFDD.

- g. Graphic ODPs and SIDs. See Order 8260.46 for limitations when making chart changes.

**8-3-5. Aeronautical Information Services review of SIAPs and charts.** Aeronautical Information Services must review and check Forms 8260-3/4/5, and the associated aeronautical charts published for variations from information submitted for publication. If any variance or charting discrepancies are identified, appropriate action must be taken to correct the discrepancy as soon as possible.

**8-3-6. Processing.** When Aeronautical Information Services quality review is completed, Aeronautical Information Services must include the procedure in the Transmittal Letter for publication. Distribution must be in accordance with table 8-3-2. Additionally, forward a copy to users specified in paragraph 8-6-13.a. [Refer to paragraph 8-3-8 for Special procedure distribution channels].

**8-3-7. Distribution.**

- a. FAA forms routing provides easy routing reference for Aeronautical Information Services forms processing. Specific directive references are included for further guidance.

- b. Aeronautical Information Services must process Army forms as required by Order 8260.15.

- c. Aeronautical Information Services must process U.S. Air Force procedures using FAA forms as required by Order 8260.32.

**8-3-8. Special procedures printing and distribution.** The AWO must provide for reproduction of the special procedure forms and must provide copies in accordance with the following recommended distribution. Modify intra-regional distribution as required:

- a. Principal Operations Inspector for the air carrier or air taxi operator with additional copies to the FSDO having jurisdiction over the airport of concern.

- b. For other operators, copies to the requesting user through the associated FSDO.

- c. Applicable Service Area.

- d. Air Traffic facility exercising control at the airport of concern.

- e. ALPA/APA if intended for air carrier use.

- f. Courtesy copy to cartographic agencies that may request copy service.

- g. National Flight Data Center, AJV-53.

- h. Aeronautical Information Services or procedure developing organization.

- i. Airport manager.

Table 8-3-1.

Para #	C = Cancel & Reissue P = P-NOTAM	A = Amendment	B = Abbreviated Amdt	P	N	
						C
8-3-4.a(1)	Title 14 CFR, part 97 subpart changes as a result of a change in equipment required to fly the procedure; e.g., "LOC" to "ILS or LOC"; "ILS" to "LOC", etc. [see paragraph 8-2-2.b].	X				
8-3-4.a(2)	Procedure ID changed from "VOR-A" to "VOR-B", etc.	X				
8-3-4.a(3)	An "L", "C", or "R" runway designation is added or removed from the procedure title; e.g., "VOR/DME RWY 18L/R" is changed to "VOR/DME RWY 18L."	X				
8-3-4.a(4)	NAVAID providing final course guidance relocated and causes final approach course ground track to change.	X				
8-3-4.a(5)	Reference NAVAID is changed on a VOR/DME RNAV procedure.	X				
8-3-4.a(6)	Straight-in minimums added or deleted that require change to the procedure ID; e.g., "NDB RWY 28" to "NDB-A", or "NDB-A" to "NDB RWY 28."	X				
8-3-4.a(7)	Special procedure converted to a public, 14 CFR part 97 procedure.	X				
8-3-4.a(8)	Runway moved and parameters exceed the values in paragraph 8-3-4.e(2)(a), and the current numbering is retained; e.g., Runway 14/32 is moved 400 feet NE.	X				
8-3-4.b(1)	Airport identifier and/or name change.		X	X		
8-3-4.b(2)	Airport associated city name or state is changed.		X	X	X	
8-3-4.b(3)	Name, facility type, and/or identifier of NAVAIDs are changed, including those mentioned in the "Additional Flight Data" and "Missed Approach" blocks of procedure forms.		X	X	X	
8-3-4.b(4)	NAVAIDs/marker beacons are decommissioned.		X	X	X	
8-3-4.b(5)	Runway numbering is changed.		X	X		
8-3-4.b(6)	Equipment added/deleted, procedure ID does not change; e.g., adding "DME Required" note.		X	X	X	
8-3-4.b(7)	Procedure ID changes; e.g., from "GPS" to "RNAV (GPS)"; "VOR/DME" to "VOR;" "VOR/DME" to "VOR/DME or TACAN"; "ILS" to "ILS or LOC/DME." Includes addition/deletion/modification of any straight-in suffix; e.g., from "RNAV GPS RWY 36" to "RNAV (GPS) Z RWY 36."		X	X		
8-3-4.b(8)	Add procedure segment [see paragraph 8-3-4.c].		X			
8-3-4.b(9)	Delete procedure segment.		X	X	X	
8-3-4.b(10)	Change runway threshold/end location and/or published fix location or makeup [see paragraph 8-3-4.c].		X			
8-3-4.b(11)	Change fix name only.		X	X		
8-3-4.b(12)	Change in charted "magnetic" course/bearing/heading/track that does not alter ground track.		X	X		
8-3-4.b(13)	Change in charted course/bearing/heading/track that alters ground track [see paragraph 8-3-4.c].		X			
8-3-4.b(14)	Increase a procedure altitude.		X	X	X	
8-3-4.b(15)	Lower a procedure altitude [see paragraph 8-3-4.c].		X			
8-3-4.b(16)(a)	Change to Time/Distance table.		X			
8-3-4.b(16)(b)	Published distances inside the FAF change by 0.10 NM or greater.		X			
8-3-4.b(16)(c)	Published distances outside the FAF change by 0.50 NM or greater.		X			
8-3-4.b(17)	Add new line of minimums [see paragraph 8-3-4.c].		X			
8-3-4.b(17)	Remove minimums.		X	X		
8-3-4.b(17)	Restore minimums to previous state following the end of a temporary condition [see paragraph 8-3-4.c].		X	X	X	
8-3-4.b(17)	Increase minimums.		X	X	X	

8-3-4.b(17)	Decrease minimums [see paragraph 8-3-4.c].		X			
8-3-4.b(18)	Airport, threshold, or touchdown zone elevation changes that affect visibility minimums [see paragraph 8-3-4.e(2)].		X	X	X	
8-3-4.b(19)	Frequency notes are changed on procedure forms.		X	X	X	
8-3-4.b(20)	Lighting changes that affect visibility minimums and/or renders a procedure unusable at night.		X	X	X	
8-3-4.b(21)	Changes to planview, profile view, or briefing strip chart notes.		X	X	X	
8-3-4.b(22)	Changes to charted obstacles identified on 8260-series forms in the "Additional Flight Data" block.		X	X	X	
8-3-4.d(1)	Frequencies changed which were not entered in notes section of procedure forms.					X
8-3-4.d(2)	Airport name mentioned in notes section of 8260-series forms is changed; e.g., "Use Batesville/Batesville Regional Altimeter Setting."					X
8-3-4.d(3)	Changes to uncharted obstacles, names of secondary airports, lighting, and communications items included in the "Additional Flight Data" block of the 8260-series forms.					X
8-3-4.d(4)	Lighting changes that do <i>not</i> affect published visibility.					X
8-3-4.d(5)	Fix coordinates change that do not affect the procedure chart or any FAS data block items on LPV or LP SIAPs that affect the CRC remainder code [see paragraph 8-3-4.b(11)].					X

Table 8-3-2.

FAA Form	NFDC	Flight Standards <sup>1</sup>	OSG-FPT	ARTCC	ATC Terminal Facility	A4A ALPA APA AOPA NBAA HAI	AJV-5 Work File
8260-1 (except Army)	Aeronautical Information Services originates. Send to Flight Procedure Implementation and Oversight Branch; maintains original copy. A copy is forwarded Aeronautical Information Services.						1
8260-1 (cancellation)	Aeronautical Information Services or Flight Procedure Implementation and Oversight Branch cancels, giving date and reason. Flight Procedure Implementation and Oversight Branch maintains original copy. A copy is forwarded to Aeronautical Information Services.						1
8260-2 (except Army)  *AWO distributes to users.	Electronic Copy	If Special	1	1	1	*	1
8260-3/4/5/ 15A/B/C	Orig.		1	1	1	1	1
8260-15D			1	Orig to control facility	Orig to control facility	1	1
8260-7A/B	Distribute as specified in Order 8260.60, paragraph 2-1-10.						
8260-9		If Special	1				Orig
8260-16  * For Off-Airway routes. Applicable Service Area FPT distributes to users.	Orig		1	1		*	1
8260-17.1/17.2	STAR package returned thru the Applicable Service Area ATC.						1
ARMY Procedure Forms	Aeronautical Information Services originates. Send package to USAASA or USAASDE.						1
USAF Procedure Forms	Orig package to the Major Command TERPS Office.						1
Substitute Routes Letter Format	ORIG						1

<sup>1</sup> Flight Procedure Implementation and Oversight Branch.



**Section 8-4. Flight Procedures Standards Waiver, FAA Form 8260-1**

**8-4-1. Preparation of Form 8260-1, Flight Procedures Standards Waiver.** All waivers to Order 8260.3 and other TERPS-related FAA directives, must be initiated by the developer, and forwarded to the Flight Procedure Implementation and Oversight Branch. See figure 8-4-1 for sample Form 8260-1. Itemized instructions for completing Form 8260-1 are as follows:

**a.** Control number. Flight Standards will enter a control number that will be used for tracking.

**b.** Item 1. Flight Procedure identification. Enter the city name and state, official airport name, and the flight procedure identification (excluding amendment number).

**c.** Item 2. Waiver required and applicable standard. Identify clearly and accurately what standard is requested to be waived; e.g., “Missed Approach Section 1 is not aligned with the Final Approach course. Order 8260.3, chapter 10.” Request only *one* waiver of standards on each form, and address the applicable standard(s) to be waived (**Note:** More than one reference may be applicable to what is being waived). When a procedure is amended, reprocessing of an existing waiver is not necessary unless the amendment directly impacts the basis for the waiver.

**d.** Item 3. Reason for waiver. The reason for the waiver must be clear and concise. If the waiver for an existing procedure is being revised, the effective date of the original procedure must be included. Include full justification for the waiver; e.g., “To avoid obstructions that would require raising the DA 180 feet.”

**e.** Item 4. Equivalent level of safety provided. Complete this item in all cases with as many points as is germane to the equivalent level of safety. Clearly state the equivalent level of safety which would mitigate the nonstandard condition.

**Note 1:** The fact that the procedure has existed for a number of years or that the procedure conforms to CFRs is not considered to be sole justification for an equivalent level of safety.

**Note 2:** Satisfactory flight inspection/validation in and of itself does not constitute an equivalent level of safety.

**Note 3:** Consultation with the AWO responsible for the geographic area the procedure is located in is recommended.

**f.** Item 5. Alternative actions deemed not feasible. Enter statements in this item to indicate consideration has been given to alternatives and why they were ultimately deemed as not feasible to eliminate the requirements of the waiver condition. Alternatives may include the consideration of new and/or relocated navigational aids, alternative routes/tracks/radials that were considered, removal of obstacles, etc. These entries must result in a description of why the waiver is the only reasonable alternative.

**g.** Item 6. Coordination with user organizations. Indicate the FAA offices and other organizations with which this waiver will be coordinated.

**h. Item 7. Submitted by.** For FAA developed instrument procedures, the Aeronautical Information Services manager or his/her designated representative, must sign and date all waiver requests, and forward to the Flight Procedure Implementation and Oversight Branch for further action. Waivers for instrument procedures developed by non-FAA service providers will be signed by the designated representative of the service provider. The waiver package (paper/electronic) submitted to the Flight Procedure Implementation and Oversight Branch must include such technical data (sketches, maps, computations, supporting database information, documentation) as necessary for Flight Standards analysis and understanding of the situation. Packages submitted with insufficient supporting technical data are subject to return to the originating office, or may be held pending receipt of such information.

**i. Item 8. Flight Standards action.**

(1) The Flight Procedure Implementation and Oversight Branch processes all waiver requests and schedules a PRB to gain consensus on approval/ disapproval. If the PRB recommends approval, then the Flight Procedure Implementation and Oversight Branch will endorse the Form 8260-1. When necessary, the Flight Procedure Implementation and Oversight Branch will annotate the Form 8260-1 that approval is contingent upon a successful flight inspection/validation report. SRM compliance for the PRB will be implemented as a Quality Management System (QMS) process and documented as part of the online PRB package.

(2) The Flight Procedure Implementation and Oversight Branch retains the original for file, provides a copy of the completed waiver to Aeronautical Information Services, and makes further distribution as necessary.

**j. U.S. Army waivers.** Aeronautical Information Services completes Form 8260-1 per the instructions provided in this order, as supplemented by Order 8260.15. U.S. Army procedures requiring waivers, for joint civil/military use, are sent to the Flight Procedure Implementation and Oversight Branch per the provisions in paragraph 8-4-1.h.

**k. Cancellation of a waiver** may be initiated by Aeronautical Information Services [see paragraph 2-12-6] or by the Flight Procedure Implementation and Oversight Branch. The initiating office must enter a signed statement to that effect, with the effective date and reason for cancellation. The Flight Procedure Implementation and Oversight Branch will distribute copies to the same organizations that received the approved waiver.

**Example:**

This waiver is canceled effective February 2, 2002.

Order 8260.3, now permits multiple DME fixes.

(Signature) \_\_\_\_\_

(Title, Office Symbol)\_\_\_\_\_

**Figure 8-4-1. Flight Procedures Standards Waiver**

US Department of Transportation  
Federal Aviation Administration

**FLIGHT PROCEDURE STANDARDS WAIVER**

FLIGHT STANDARDS USE ONLY  
CONTROL NO.

**1. FLIGHT PROCEDURE IDENTIFICATION:**

Mohall, ND  
Mohall Muni (HBC)  
VOR/DME-A

**2. WAIVER REQUIRED AND APPLICABLE STANDARD:**

To permit a VOR final approach that is more than 30 miles from the facility. FAA Order 8260.3B, Volume 1, paragraph 513B, "Final approaches may be made to airports which are a maximum of 30 miles from the facility."

**3. REASON FOR WAIVER (JUSTIFICATION FOR NONSTANDARD TREATMENT):**

To have a VOR type approach originating from Minot (MOT) VORTAC to RWY 31 at Mohall Muni. The runway threshold is 31.85 NM from the facility and obstacle clearance must be maintained to this point. Criteria limits the maximum distance from the facility to 30 NM. Minot (MOT) VORTAC is the closest and only usable facility that supports ground-based procedures at Mohall Muni. The VOR/DME-A approach is the only ground-based procedure at Mohall Muni.

**4. EQUIVALENT LEVEL OF SAFETY PROVIDED:**

1. DME is required.
2. The missed approach point for the procedure is at the 30.0 DME point.
3. The final approach obstacle evaluation area was extended between the MAP and RWY 31 and the entire area was evaluated as primary area.
4. The procedure will be charted "NA at night."

**5. ALTERNATIVE ACTIONS DEEMED NOT FEASIBLE:**

The installation of an on-airport facility would eliminate a need for a procedure from Minot (MOT) VORTAC, but funding is not available.

**6. COORDINATION WITH USER ORGANIZATIONS (SPECIFY):**

XXX-XXX \_\_\_\_\_

**7. SUBMITTED BY:**

DATE	OFFICE IDENTIFICATION	TITLE
XX/XX/XXXX	XXX-XXX	XXXXXXXXXX

**SIGNATURE**

James P.  
Doe

Digitally signed by James P. Doe  
DN: cn=James P. Doe, o=FAA,  
email=james.p.doe@faa.gov,  
c=US  
Date: 2015.06.02 14:40:27 -0500

**8. AFS ACTIONS:**

- APPROVED**    **DISAPPROVED**    **NOT REQUIRED**

**COMMENTS:**

Approved based on equivalent level of safety in Block 4.

DATE	ROUTING SYMBOL
XX/XX/XXXX	XXX-XXX

**SIGNATURE**

John T.  
Smith

Digitally signed by John T. Smith  
DN: cn=John T. Smith, o=FAA,  
ou=AFS-400,  
email=john.t.smith@faa.gov, c=US  
Date: 2015.06.02 14:48:41 -0500

**Section 8-5. Radio Fix and Holding Data Record, FAA Form 8260-2****8-5-1. Introduction.**

**a. General.** All civil and military named fixes and holding patterns must be documented on Form 8260-2. Navigation facilities do not require this documentation unless holding is established [see paragraph 8-2-1.b(1)]. Form 8260-2 may be initiated by Aeronautical Information Services, military organizations, Air Traffic Facilities, Flight Standards Service, or non-FAA service providers. Form 8260-2 action may also be initiated by Air Traffic facilities using the Form 8260-2 worksheet [see appendix E] for fixes associated with STAR, SID, and 14 CFR part 95 route projects. The worksheet is submitted to the applicable Air Traffic Service Area office for coordination with the RAPT and then forwarded to Aeronautical Information Services for processing. When initiated by military organizations, the forms are coordinated with the controlling FAA Air Traffic facility and then (USAF: See applicable Air Force directives for processing) forwarded to the NFDC. The forms must be distributed in accordance with. All other initiators must coordinate the establishment, alteration, or change in fix use with the controlling FAA Air Traffic facility. All initiators must coordinate any modification of holding and fix use of any 14 CFR part 95 route or 14 CFR part 97 instrument procedures with Aeronautical Information Services or the company maintaining the 14 CFR part 97 procedures. See section 2-10 for additional navigational fix guidance and processing information.

**b. Entries.** All radial/course/bearing entries are magnetic unless otherwise noted. Distances less than one nautical mile must have a zero before the decimal.

**c. Storage.** All domestic and certain foreign named fixes and holding requirements are entered into NFDC's computer for permanent storage, and are published in Order JO 7350.8.

**d. Fix name change.** A fix name change requires a revised Form 8260-2. Annotate in the "Remarks" section; e.g., "Name Changed From LESLI to WALLS." Fix name changes must be kept to an absolute minimum and must be made only for safety of flight reasons; e.g., similar sounding names in close proximity, name duplication, etc.

**Note:** A name change for fixes used on procedures contained in the National Flight Database (NFD) will require the procedure to be amended to reflect the changed fix name.

(1) Fix name changes associated with instrument flight procedures require that the procedure(s) be amended for the same effective date to ensure chart/database harmonization is not compromised.

(2) When a fix must be moved, refer to Order JO 7400.2 for guidance on whether the five-letter name may be retained or must be changed.

**8-5-2. Preparation of Form 8260-2.**

**a. Name.** Enter the name of the fix. Do *not* enter "INT" or "WP" after the name of the fix. See paragraphs 2-10-8 and 8-5-2.g. When an RNAV waypoint is collocated with another type of fix, use the same name for both. When documenting holding for a navigation facility, use the facility name and facility type.

**Example:**

OKIE  
DENVER VORTAC  
JACKSON VOR  
AVON NDB  
ARUBA LOM

**b. State.** Enter the two-letter identifier of the state in which the fix or navigation facility is located. The state is left blank if the country is other than the U.S. For offshore fixes at or inside the U.S. 12 NM territorial limit, name of the nearest state must be used.

**c. Country.** Enter the two-letter identifier of the country in which the fix or navigation facility is located.

**d. ICAO region code.** Enter the one or two character code of the ICAO region in which the fix or navigation facility is located. In the Continental U.S. and within the 12 NM territorial limits, the region code will begin with a “K” followed by a numeric character obtained from appendix L. For Alaska “PA” is used and for Hawaii “PH” is used within the 12 NM territorial limit. For all other U.S. Territories as well as countries within the U.S. FIR boundary and within the 12 NM territorial limit of the country or territory and where the U.S. establishes a fix, the code is as identified in the ICAO Doc. 7910. Outside the 12 NM limit in the Pacific a “P” must be used. Outside the 12 NM limit in the Atlantic and Gulf of Mexico a “K” must be used. Outside the 12 NM limit but within the San Juan FIR boundary “TJ” must be used.

**e. Latitude/Longitude.** Enter the fix or navigation facility latitude and longitude. Compute the coordinates using the primary means of identifying the fix. Enter to the hundredth of a second. Include the compass point of the latitude and longitude. En route fixes must be calculated using the true courses (to the hundredth of a degree) between the facilities making up the airway/route segment. If the fix is also used in a terminal procedure, then terminal priorities must prevail.

**Example:**

482921.83N / 1064810.92W

(1) If the fix can be formed in more than one manner, show the facilities used to calculate the coordinates given in the “Remarks” section, and record only one set of coordinates on the form.

**Example:**

OKLAHOMA CITY (FAC1) AND WILL ROGERS (FAC2) USED TO ESTABLISH FIX COORDINATES

(2) Facilities (NDB, OM/MM/IM and LOM/ LMM/LIM) used as fixes on IAPs are compatible with database referenced navigation systems only when located on the FAC of the NAVAID providing FAC guidance. To ensure compatibility and consistency, use actual coordinates only when the facility resides on the actual FAC. Otherwise, whenever the actual location of the facility is within the commissioned width of the FAC facility; establish marker/locator coordinates where the marker major axis intersects the actual FAC. Where the actual location of the facility is outside the commissioned width of the actual FAC, establish a

separate suitable intersection or fix on the actual FAC. In situations where IAPs are established to adjacent parallel runways and the facility is located within the commissioned FAC width for both runways, use the marker/locator on one IAP, and establish a separate fix for the other IAP. Use the actual coordinates of the NDB (LOM/LMM/LIM) for NDB approach procedures. In those instances where the coordinates on the Form 8260-2 reflect the intersection of the marker major axis and the actual FAC, make the following entry in Remarks. "Coordinates reflect location on LOC/AZ centerline abeam the [Facility Name and Type]. Actual facility location is 123456.78N / 0123456.78W."

**f.** Airspace docket number. Enter the docket number when the request is associated with an airspace action. If no docket number, leave blank. A docket number is required only when a compulsory reporting point is established; location/fix makeup is modified, or canceled. A docket number is not required when an existing fix, not a compulsory reporting point, is moved [see paragraph 2-10-5.c] or amended due to other reasons.

**g.** Fix.

(1) Type. List the fix type(s) for the various uses of the fix. If the Form 8260-2 is for a navigation facility, leave blank. Available Fix Types are WP, INT, DME, CNF, and RADAR. A combination of fix types may be used when applicable; e.g., "INT, DME, WP, RADAR" or "DME, CNF" or "INT, DME."

(2) Type of Action. Enter the type of action being taken. The types of action are: Establish, Modify, Cancel, or No Change. This is applicable to fix only, and *not* to be confused with Holding.

**Note 1:** Fix cancellation. When a fix is canceled, a copy of the current (to include all the existing data) Form 8260-2 will be generated. Type of Action will have "Cancel" placed on this line. Complete the Approval line for the individual approving the cancellation.

**Note 2:** Instrument procedure cancellation. Whenever an instrument procedure is canceled, update Fix use or process a cancellation, as necessary, of Form 8260-2s for fixes associated with the procedure. ATC facility(s) must be coordinated with prior to cancelling a fix. If the fix will be retained for other than instrument procedure use (e.g., ATC use), see paragraph 8-5-2.r, for transferring the OPR.

(3) Fix Make-Up Facilities. Enter all navigation facilities used for fix make-up. RADAR and RNAV [except RNAV (VOR/DME)] fixes, leave blank. En route: Where a crossing radial/bearing establishes a fix along an airway, list the on-course facility as Facility 1, and the off-course facility as Facility 2. Where a fix is established at the intersection of two or more airways, list the source facility farthest from the fix as Facility 1. Terminal: If the fix is an intersection, list the facility providing positive course guidance as Facility 1, and the crossing course facility as Facility 2. If the fix is DME, list the DME source, if other than Facility 1, as Facility 2. For a RNAV (VOR/DME) waypoint, list the reference facility as Facility 1.

**Note:** If *only* DME is used from a fix make-up facility (i.e., crossing radial cannot be used as part of the Facility 2 fix make-up), leave the Facility 2 "Magnetic Bearing" and "True Bearing"

entries blank. However, if the bearing is required for other fix makeup, indicate in the fix use remark to not chart the bearing for the particular fix use.

(a) Facility Number. Enter the Fix Make-up Facility Number, beginning with "1." Continue the number list for all navigation facilities used for fix make-up.

(b) Name. Enter the name of the navigation facility.

**Example:**

KANSAS CITY  
TRUTH OR CONSEQUENCES

(c) Ident. Enter the identifier of the navigation facility.

**Example:**

MCI  
TOC  
I-OKC  
BO

(d) Type. Enter the facility type.

**Example:**

VORTAC  
LOC  
LOC/DME  
VOR  
VOR/DME  
OM

(e) Class. Enter the SSV class. VOR, VORTAC, VOR/DME, TACAN, (T, L, H), NDB (HH, H, MH), other facilities leave CLASS blank.

(f) Magnetic bearing. Enter the magnetic bearing from the navigation facility to the fix. Enter values to the nearest hundredth of a degree.

(g) True bearing. Enter the true bearing from the navigation facility to the fix. Enter values to the nearest hundredth of a degree.

(h) DME. If the navigation facility provides DME for the fix, enter the DME value. Enter values to the nearest hundredth of a NM.

(i) Distance from facility.

1. NM. Enter the distance in NM from the navigation facility to the fix. Enter values to the nearest hundredth of a NM.

2. Feet. When the fix being defined is a FAF or PFAF, enter the distance in feet from the navigation facility to the fix. Enter values to the nearest whole foot.

(j) MRA. See also paragraph 2-10-8. The MRA is usually based on electronic signal strength determined by flight inspection of the navigation facility. The developer must consider all possible uses of the fix, request flight inspection of the lowest authorized altitude, and ensure procedure design is compatible with any limitations imposed. MRAs assigned must be consistent with signal strength, facility service volume, air traffic requirements, air/ground communications, and airspace structure. For fixes located inside the FAF, establish an MRA 100 feet below the lowest published procedural altitude at the fix. Values are entered in whole feet.

**Note:** When an MCA is assigned in order to meet flight check signal reception requirements, ensure the applicable facility MRA matches the MCA.

(k) MAA. See also paragraph 2-10-10. The MAA is the highest altitude authorized for use of the fix. The developer must consider all possible uses of the fix, request flight inspection of the highest authorized altitude, and ensure procedure design is compatible with any limitations imposed. MAAs assigned must be consistent with signal strength, facility service volume, air traffic requirements, air/ground communications, and airspace structure. Values are entered in whole feet.

(4) ESV. Enter all ESV required for fix make-up. Enter navigation facility identification, facility type, radial or bearing, distance, minimum altitude, and maximum altitude.

(5) Fix restriction(s). List all fix restrictions that are applicable, e.g., en route MRA or MCA, military only, Special only, etc.

**Examples:**

MCA V3 5000 NORTHBOUND  
MRA V5-47-182 3800  
MILITARY ONLY  
SPECIAL ONLY

**h. Holding.**

(1) Type of action. Enter the type of action being taken. The types of action are: establish, modify, cancel, or no change. This is applicable to holding only, and *not* to be confused with fix. When no action is being taken, leave blank on originals or enter no change on revisions. Revise the Form 8260-2 when holding pattern cancellations are necessary. If canceling all holding at the fix or navigation facility, enter cancel in type of action. When more than one holding pattern is established and you wish to cancel an individual holding pattern and retain the other(s), enter modify in type of action, delete the appropriate holding information, and identify the modification in reason for revision.

(2) Holding patterns. Analyze holding patterns incrementally for all altitudes requested by ATC and for all speed categories. Do *not* use less than pattern template number 4. Apply



appropriate obstacle clearance to all obstacles within each template area and airspace requirements to only the primary portion of the template area. Some time may be saved by initially evaluating the patterns for the highest speed group. If the same controlling obstruction or minimum holding altitude results, document the obstruction and the associated smaller pattern template number; the evaluation is then complete. If the minimum holding altitudes differ, a more detailed incremental analysis is necessary. When a specific holding pattern is not required, leave blank. Specific holding patterns at ground based navigation facilities that support only RNAV use must be documented [see paragraph 2-5-3.g(2)(a)].

(a) Pattern number. Enter the number for a specific holding pattern beginning with number "1." Continue the number sequence for all specific holding patterns associated with the fix or navigation facility.

(b) Direction. Enter the holding direction based on magnetic inbound course [see table 8-6-1].

(c) Ident. If holding is based on a navigation facility, enter the identification of the facility providing course guidance. If RNAV, leave IDENT blank.

(d) Type. Enter the type of navigation facility. If RNAV, enter "WP."

(e) RAD/CRS/BRG. Enter the radial/course/bearing in hundredths of a degree magnetic from the facility or waypoint on which holding is based.

(f) CRS inbound. Enter the course of the inbound leg of the holding pattern in hundredths of a degree magnetic.

(g) Turn (L or R). Enter the direction of turn. Enter "L" for left turn, "R" for right turn.

(h) Leg length. Either time or DME values may be entered for a specific holding pattern.

**Note:** When both time and distance are applicable to the same holding pattern, patterns must be specified as two individual entries; e.g., PAT 1 and PAT 2.

1. Time. Enter the time leg length outbound from the fix based on minimum holding altitude.

2. DME. Enter the DME leg length outbound from the fix based on minimum holding altitude. Enter the DME value to the whole NM.

**Note:** This block will also be used for entering the leg distance for RNAV holding, when applicable.

(i) Holding altitudes. Authorized altitudes must be no lower than the lowest altitude requested by ATC. Evaluate up to the maximum altitude operationally requested.

1. Minimum. Enter the minimum holding altitude authorized for the holding pattern. Value is entered in whole feet.

2. Maximum. Enter the maximum holding altitude authorized for the holding pattern. Value is entered in whole feet.

(j) Templates. See Order 8260.3 for the holding pattern template information.

1. Minimum. Enter the holding pattern template used for controlling obstruction evaluation based on the minimum holding altitude.

2. Maximum. Enter the holding pattern template used for controlling obstruction evaluation based on the maximum holding altitude.

**Note:** When a Climb-in-hold (CIH) pattern is documented for the minimum holding altitude, the maximum altitude CIH pattern size should also be the one specified.

(3) Controlling obstructions.

(a) Pattern number. Enter the holding pattern number to which the controlling obstruction is applicable. When documenting the controlling obstruction for unplanned holding, enter "UPN." When documenting the controlling obstruction for a climb-in-hold evaluation on a holding pattern already listed, make a separate entry, repeating the holding pattern number.

(b) Airspeed. Enter the maximum holding airspeed used based on the minimum holding altitude for the pattern [see Order 8260.3, table 17-2-1].

**Example:**

230

(c) Obstruction. Enter the description of the controlling obstruction. Enter the obstruction identifier, if available, in parenthesis.

**Example:**

TOWER (KORD0045)

(d) Coordinates. Enter the latitude and longitude, with compass points, of the obstruction to the nearest hundredth of a second.

**Example:**

573129.97N/0701658.77W

(e) Elevation. Enter the MSL elevation of the obstruction to the nearest foot.

(f) Accuracy code. Enter the applicable accuracy code (if available) of the controlling obstruction.

(4) Precipitous terrain additions. List by pattern number any required precipitous terrain addition used with the required obstacle clearance to determine the minimum holding altitude.

- (a) Pat. List the holding pattern number.
- (b) Addition. List the precipitous terrain addition to the whole foot.

(5) Reason for nonstandard holding. When holding with left turns, identify the holding pattern number and the reason. If standard, leave blank.

**Example:**

PAT 1 TERRAIN

PAT 3 TRAFFIC DECONFLICTION

- (6) Holding restriction(s).

(a) Unplanned holding at en route fixes may be expected on airway or route radials, courses, or bearings. If a navigation facility, unplanned holding could be on any radial or bearing. Holding approval for en route fixes indicates approval of unplanned holding.

(b) En route fixes which also serve as missed approach clearance limits must permit holding and en route flight.

(c) When unplanned holding is not recommended, holding should be restricted. When planned or unplanned holding is restricted, add an appropriate note in the "Holding Restrictions" section.

**Example:**

HOLDING LIMITED TO ESTABLISHED PATTERN(S)

UNPLANNED HOLDING NA 090 CW 220

UNPLANNED HOLDING NA ON R-120 CW R-272

UNPLANNED HOLDING AUTHORIZED AT OR ABOVE 5000

PRIOR COORDINATION REQUIRED WITH CONTROLLING AGENCY FOR HOLDING OVER R-5503A/B

(7) Procedures requiring climb-in-hold. Evaluate the climb-in-hold as appropriate, in accordance with Order 8260.3, chapter 17. Enter all procedures that require a climb-in-hold evaluation for a listed holding pattern. Enter the holding pattern number, procedure title, airport identifier, city name, and state.

**Note:** If other than 310 KIAS climb-in-hold speed is used (i.e., 200/230 KIAS used for holding patterns restricted to 175 KIAS), the procedure must be annotated with the maximum airspeed allowed to conduct a climb-in-holding [see paragraph 8-6-6.g].

**Example:**

PAT 1, VOR RWY 19, MCI, KANSAS CITY, MO

**i.** Remarks. The foregoing instructions contain several uses for this section. Additional uses are as follows:

- (1) Precipitous terrain. Enter a remark stating precipitous terrain evaluation completed.

**Example:**

PRECIPITOUS TERRAIN EVALUATION COMPLETED.

(2) When holding is over a NAVAID, document the assigned magnetic variation of the NAVAID.

(3) Other remarks. Enter remarks necessary to clarify fix make-up, holding patterns, etc.

**j.** Fix use. List the uses of the fix. List the use type, use title, fix make-up (if applicable), pattern (if applicable), airport identifier (if applicable), city name, and state (if applicable). List both procedure and non-procedure fix use in use type and use title. When a specific facility or holding pattern needs to be charted for a fix use, enter the facility number(s) in fix make-up and/or pattern number(s) in pattern.

(1) Use type. Use types are:

(a) DP - Used for SIDs and ODPs.

(b) Special DP – Used for Special departure procedures.

(c) En route - Used for airways, jet routes, Q routes, T routes, etc.

(d) IAP - Used for standard and special approach procedures.

(e) Special IAP – Used for Special approach procedures.

(f) Other - Used for non-procedure fix uses, e.g., ATC coordination fix, pitch/catch point, restricted area entry/exit point, sub-route, etc.

(g) STAR - Used for standard terminal arrival.

(2) Whenever the “Fix Use” section is changed (i.e., addition, deletion, or modification), this is considered to be a revision and the revision number must be changed.

**k.** Required charting. List the flight publication products the fix is to be charted on. The publication products are sectional, VFR terminal area, VFR flyway planning, helicopter route, DP, STAR, IAP, military DP, military STAR, military IAP, Special IAP, Special DP, area, Controller High, Controller Low, en route low, and en route high, IFR GOM vertical flight.

**Example:**

DP, IAP, CONTROLLER LOW, EN ROUTE LOW

**l.** Compulsory reporting point. If the fix is a compulsory reporting point, enter the airspace structure(s) applicable to the reporting point, e.g., low, high, low/high. If the fix is not a compulsory reporting point, enter No [see also paragraph 8-5-2.a].

**m.** Record revision number. Enter the revision number. When the Form 8260-2 is an original, enter “Orig” [see paragraph 8-5-2.j].

n. Date of revision. Enter the effective date of the new/revised holding pattern and/or fix.

**Note:** If the fix/holding pattern serves only a Special instrument procedure, this date must be the same as the effective date established for the procedure [see paragraph 8-6-2.o].

o. Reason for revision. List the reason(s) for the revision. Make “concurrent with” entries if needed.

**Example:**

ADDED FACILITY 3 TO FIX MAKE-UP RAISED PATTERN 4 MINIMUM HOLDING ALTITUDE FROM 3000 FT TO 4000 FT CONCURRENT WITH JACKSON HOLE, WY, VOR RWY 36, AMDT 3

p. ATC coordination. Enter the date, air traffic facility Ident and type, and name of the ATC individual that coordinated the fix request.

q. Initiated by. For Aeronautical Information Services or ATC developed fixes, leave blank. For all other developed fixes, enter the date, organization/company, and name of the individual initiating the fix.

r. Office of primary responsibility. Enter the name and office symbol of the office that is the focal point for any changes/modifications to this fix and/or holding pattern(s). See appendix D for guidance when submitting changes/modifications to the OPR. The OPR is subject to change based on changes that may occur regarding “fix use.” For example, if the fix were used by a non-FAA service provider or ATC and it will now be used for an instrument flight procedure developed by the FAA; the OPR will be transferred to Aeronautical Information Services [see paragraphs 2-10-4.a(5) and 2-10-4.a(6)].

s. Approved by. Enter the date, office, name, and signature of the approving authority. Aeronautical Information Services is the approval authority for fixes required by FAA-developed instrument flight procedures and/or airways. The Flight Procedure Implementation and Oversight Branch is the approval authority for fixes associated with “Special” instrument flight procedures *not* developed by the FAA. Non-FAA service providers approved to develop 14 CFR part 97 instrument procedures have approval authority for those fixes used solely for procedures they have developed. The military may sign and approve fixes that are for military operations and have no impact on FAA-developed instrument procedures and/or airways. The applicable Service Area OSG-FPT is the approval authority for fixes created solely for ATC use.

t. Distribution.

(1) Distribute the approved Form 8260-2s for instrument procedure fixes, including military fixes as defined in table 8-3-2.

(2) Enter the office symbol, abbreviation, or facility Ident. Enter each ARTCC, ATC Facility, or other if sent to more than one of that type.

(3) For U.S. Army fixes, distribute Form 8260-2s in accordance with Order 8260.15.

(4) Send the Form 8260-2s (electronic submission preferred) on Specials to the NFDC when notified that the Special has been approved by the Flight Procedure Implementation and Oversight Branch.

**Section 8-6. Completion of FAA Forms 8260-3/4/5/7A**

**8-6-1. General.** This section contains information applicable to the completion of Forms 8260-3/4/5/7A. Guidance is referenced to each separate area of the forms. Begin at the top/center of the form by selecting whether it will be an FAA, Army, or Air Force procedure. Then select the type of procedure (e.g., RNAV), and whether it will be “Standard” or “Special.” Once those are selected, additional selection options will appear in the upper left corner of the form; select all those that are appropriate and the correct form will be generated to support all those items selected and will now be ready to begin making entries into those blocks that will be filled out.

**8-6-2. Basic information.**

- a. Airport/Heliport. Enter the official airport/heliport name as derived from NASR.
- b. Airport ID. Enter the applicable ICAO or FAA airport identifier as derived from NASR.
- c. Procedure name. Enter procedure identification as determined by Order 8260.3 and paragraph 8-2-2 of this order.
  - (1) For RNAV (or FMS for which GPS is required) procedures, use RNAV (GPS) RWY 22.
  - (2) When a procedure also contains CAT II/III minima or SA CAT I/II minima, include the name of the additional procedure(s).

**Examples:**

ILS or LOC RWY xx  
ILS RWY xx (CAT II) ILS RWY xx (CAT III)

ILS or LOC RWY xx  
ILS RWY xx (SA CAT I) ILS RWY xx (SA CAT II)

ILS or LOC RWY xx  
ILS RWY xx (SA CAT I)

ILS or LOC RWY xx  
ILS RWY xx (SA CAT I) ILS RWY xx (CAT II)

ILS or LOC RWY xx  
ILS RWY xx (SA CAT I) ILS RWY xx (CAT II) ILS RWY xx (CAT III)

- (3) When a procedure contains “PRM” in the title (e.g., ILS PRM RWY 30L), on the line below it, include the text “Close Parallel” in parenthesis.

**Example:**

ILS PRM RWY 30L  
(CLOSE PARALLEL)

(4) When an instrument procedure has been designed to support “Converging” operations, on the line below the procedure title, include the text “Converging” in parenthesis.

**Example:**

ILS V RWY 31R  
(CONVERGING)

(5) Radar procedures must be numbered in sequence; e.g., “Radar 1, Radar 2, etc.”

**d.** Original/Amendment. Enter “ORIG” for an original procedure or “AMDT” with the applicable amendment number/letter. The amendment number must be advanced or the alphabetical suffix added/advanced whenever the procedure is revised. The type of revision will determine whether an amendment may be made or whether the procedure must be canceled and an original established [see paragraph 8-3-4].

**e.** City and State. Enter associated city name and state name as derived from NASR. Use the official two-letter state abbreviations.

**f.** Elevation. Enter the official airport/heliport/surface elevation as derived from NASR.

**g.** TDZE.

(1) Enter TDZE [as stated in the AIRNAV/NASR databases, rounded to the nearest foot] for the runway designated in the procedure title. Enter the sidestep runway and TDZE, if applicable, below the first entry e.g.,

TDZE: 28L 2854

TDZE: 28R 2858

Leave the TDZE *blank* if straight-in minimums are not authorized or if the procedure is a Copter PinS procedure [see paragraph 8-6-10.m].

(2) For Copter PinS procedures noted to “proceed VFR” to the landing site, enter “Surface Elevation.” Then enter the highest terrain/surface elevation within a 5200-foot radius of the MAP. For a Copter PinS instrument approach procedure serving multiple heliports, enter the name of the primary heliport and list each heliport in the “Additional Flight Data Block.”

**Note:** Paragraph 8-6-10.l also requires each heliport to be identified in the “Additional Flight Data Block.”

**h.** Superseded. Enter the identification of the superseded procedure if the name has changed.

**i.** Original/Amendment. If the procedure is original, enter “None”; otherwise, enter “Orig” or amendment number as appropriate.

**j.** Dated. If the procedure is original, leave *blank*; otherwise, enter previous amendment date.



**k.** Magnetic variation. Except as provided in paragraph 8-2-3, enter the magnetic variation value upon which the procedure design and documentation is based.

(1) For non-RNAV SIAPs, enter the officially assigned variation value of the facility providing final approach course guidance.

(2) For all RNAV SIAPs, see paragraph 2-5-3.g(2).

**l.** Epoch Year. Enter the epoch year of the variation value as designated by the Aeronautical Information Services [see paragraph 2-5-2]. Enter this value in four digits; e.g., 2015

**m.** Facility. Enter facility identification. On procedures predicated on proposed facilities and when an identification has not been assigned, leave this space *blank* and NFDC will enter the identification. For RNAV (VOR/DME) procedures, enter the identification of the SIAP reference facility. For RNAV, GLS, or FMS procedures, insert RNAV, GLS, or FMS as applicable. For radar procedures, enter the identifier of the controlling facility and the type of radar; e.g., “COS ASR,” “TBN ASR/PAR.”

**n.** Coordinates of facilities. When a facility is referred to on a procedure for the first time, enter the facility coordinates. The source data for the coordinates must be identified; e.g., AF survey, ALP, OC, Map Study, Flight Program Operations, NOS, etc. If sufficient space is not available to list coordinates of all new facilities, the space under “Changes” must be used. Leave blank for RNAV procedures.

**o.** Actual effective date.

(1) Enter the AIRAC cycle date the procedure will become available for public use.

(2) The actual effective date of the Special procedure will be entered by the AWO. The AWO must coordinate this date with the affected ATC facility to ensure they have adequate time to train controllers and incorporate the procedure into electronic data systems prior to implementation. Effective dates must be based on 28-day AIRAC cycle dates (or 56-day AIRAC cycle dates if en route chart changes are required) as published in Order 8260.26.

**p.** Required effective date. The required effective date of the procedure will normally be entered by Aeronautical Information Services. Due to the heavy workload associated with the 56-day airspace charting dates, Aeronautical Information Services will normally schedule routine procedure amendments for charting dates commensurate with NFDC and Aeronautical Information Services workload. When an effective date is required which is *earlier* than can be routinely assigned by NFDC, Aeronautical Information Services, and Aeronautical Information Management Group (AIMG) must coordinate with NFDC to determine the appropriate course of action to expedite publication. This block will be left blank for Special instrument procedures.

(1) Original procedures. The effective date of original procedures must be in accordance with Order 8260.26; except that the 28-day change notice will not be published for Alaskan or Pacific procedures or for procedures that require en route charting changes.

(2) Routine amendments. Routine amendments to SIAPs are made effective based on the time required to process and distribute the SIAP, plus the time required for charting and distribution to subscribers. Procedures that contain an en route fix name change or re-identification must be made effective on the 56-day cycle charting date, to coincide with the publication of en route charts. Amendments to procedures pending flight inspection/validation must be held by Aeronautical Information Services/non-FAA service provider until the flight inspection/validation is complete.

q. Cancel/Suspend. If applicable, indicate if the procedure is being cancelled, suspended, or reinstated.

### 8-6-3. Terminal Arrival Area (TAA).

a. Documenting the TAA. When the TAA box located at the top, left of the form is selected, the TAA section will appear on the Form. Enter all normal terminal route and TAA information on the appropriate 8260-series forms. For TAA entries, the “From” and “To” entries do not describe routes of flight, but rather describe a volume of airspace within which an aircraft will proceed inbound from the 30 NM arc boundary toward an associated “T” IAF or IF/IAF. Enter the data in the specified standardized format detailed below to assist cartographers in developing the desired published display. Each entry must coincide with the corresponding entry on Form 8260-9 to provide correlation between terrain/obstacle data and the minimum altitude associated with the appropriate TAA area. Provide a graphic depiction of the TAA with areas defined and indicate the minimum altitude associated with each area/sector. Do not establish minimum altitudes that will require aircraft to climb while inbound toward the respective “T” IAF. Comply with existing instructions in this order relative to terminal routes (also see paragraph 4-6-2.e note), except as noted below:

(1) From. For TAA entries, begin at the outermost boundary and work inward toward the respective “T” IAF. Enter an area/sector description beginning with the inbound magnetic course that is used as the sector boundary between the right base and straight-in sectors and proceed in a clockwise direction. Enter the magnetic value of the straight-line boundary (or its extension) described “To” the associated “T” IAF, followed by the arc boundary distance (NM) for that point, and separate the entries by a “/”; e.g., 090/30. Then enter “CW” followed by a point along the same arc boundary intersected by the next straight-line boundary; e.g., 270/30. Thus, in a basic “T” configuration without stepdown sectors, the straight-in “From” entry would appear as “090/30 CW 270/30.” Enter data in a similar manner to describe other areas and sectors.

(a) Sequentially number (1, 2, etc.) the first line entry describing the area/sector for which different minimum altitudes are established. It is possible for an area/sector to be irregularly shaped, but have only one minimum altitude. Enter the associated data for such an area together as a group of sequential line entries.

(b) Enter “NoPT” following each line entry that contains the specific 30 NM arc boundary for which that label is appropriate. If a course reversal is required, make no entry regarding PT requirements on the line entry describing the 30 NM arc boundary.

(2) Fix Type. Enter the fix type as applicable; e.g., IAF, NoPT, etc.

(3) To. Enter area/sector straight-line/arc boundary descriptions as above, which in combination with the associated entry in the “From” block, encloses the area being documented. For example, the “To” stepdown arc entry associated with the “From” entry above for a basic “T” configuration without stepdown sectors would be the “T” IAF; therefore, enter the appropriate fix name and fix type; e.g., POPPS IAF, MAACH IAF, etc. If the area has been sectorized, the “To” entry could be “090/22 CW 180/22.”

(4) Fix Type. Enter the fix type as applicable; e.g., IAF, NoPT, etc.

(5) Altitude. Enter the minimum altitude of the area/sector on each line.

b. Form 8260-9, Standard Instrument Approach Procedure Data Record. Comply with instructions in paragraph 8-7-1.b for documenting controlling/terrain, coordinates, minimum altitudes, etc.

Figure 8-6-1. Example #1

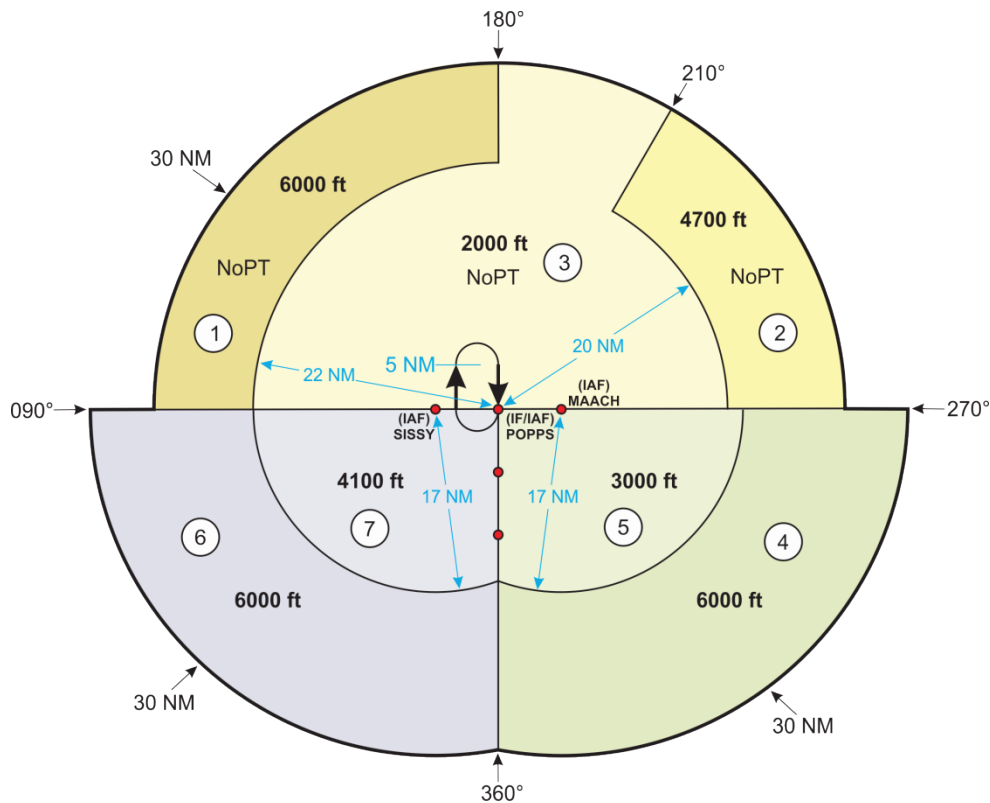
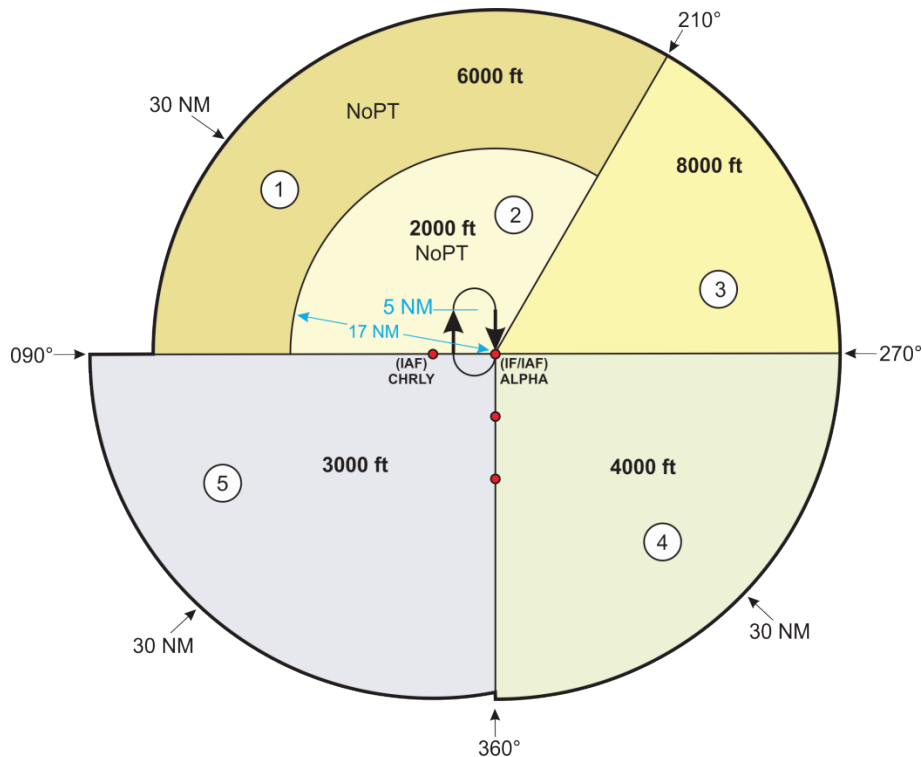

Figure 8-6-2. Example #2



**8-6-4. Terminal routes.** This information is used to develop the planview of the instrument approach chart. For RNAV (GPS and RNP) procedures, document all segments of the procedure, including the final and missed approach segments. See paragraph 8-2-5 for guidance regarding the establishment of terminal routes.

**a. From-Fix Type and To-Fix Type columns.** List routes from fix to fix. Establish terminal routes that require a course reversal direct to the fix or facility from which the course reversal is authorized. Signify dual-use fixes (e.g., where hold-in-lieu-of-PT is established at the FAF or IF) as (FAF/IAF) or (IF/IAF).

(1) Enter IAF designations “(IAF)” in the “From,” “Fix Type,” column after each fix satisfying the requirements of the parenthetical initial approach fix [see paragraph 8-2-5.j].

(2) Enter intermediate fix designator “(IF)” in the “From,” “Fix Type,” column after the fix satisfying the requirements of the parenthetical intermediate fix [see paragraph 8-2-5.i(4)].

(3) Enter NoPT in the “To” “Fix Type,” column for initial segments that permit elimination of the procedure turn. Designate the intermediate segment NoPT only if necessary to clarify the procedure. Do *not* designate as NoPT a segment after a course reversal fix [see paragraph 8-2-5.g(2)].

(4) Enter CW for clockwise or CCW for counter-clockwise in the “From” column for arc segments. When entered, this information must precede the “(IAF)” as applicable. Enter the name of the fix to which an arc segment connects in the “To” column.

(5) Describe feeder or initial routes based on dogleg segments as fix-to-fix. For a dogleg to a fix on the extended FAC, enter the heading and FAC in the course/distance column. Specify each segment on a separate line. Establish common initial segment altitudes. Where not possible, establish separate procedures. The DR initial is one segment.

(6) For RNAV (GPS and RNP) IAPs, and ILS/LOC procedures containing RNAV segments, document:

(a) PFAF name followed “(FAF).”

(b) The RNAV leg type and waypoint type [fly-by (FB) or fly-over (FO)] for all approach as well as missed approach segments, in the “TO” column, as appropriate; e.g., UNAVY (NOPT) (TF) (FB); ECCHO (DF) (FO).

(c) The RNP value for each segment for RNAV (RNP) designated instrument procedures in the “TO” column; e.g., (RNP 1.00). Use a leading zero for RNP values less than 1.00; e.g., (RNP 0.50) [see paragraph 4-6-10.f].

(d) The LTP, *or* for offset procedures, the FTP in the “TO” column; e.g., RW18R for the LTP or a CNF for the FTP. Normally, the LTP/FTP will be designated as a fly-over waypoint; e.g., RW36R (MAP) (TF) (FO) or (CFWTY) (MAP) (TF) (FO). However, when RNP is required for the missed approach course and the RNP necessary is less than 1.0 [see Order 8260.58, chapter 4], the LTP/FTP must be coded as a fly-by waypoint; e.g., RW08R (MAP) (TF) (FB) or (CFYWZ) (MAP) (TF) (FB).

(e) The missed approach holding waypoint (clearance limit) as a FO waypoint. However, the missed approach holding waypoint will not be charted as a fly-over waypoint in order to avoid confusion when the fix is used for other purposes and treated as a fly-by waypoint.

**b. Course/Distance columns.** Specify the course and distance for each route segment, except for RNAV DF legs. For RNAV (GPS) final approach stepdown segments, use the final approach course as computed from the PFAF to LTP/FTP for the stepdown segment(s) course entry. Enter the actual magnetic course to the hundredth of a degree, and distance to the hundredth of a NM. Aeronautical Information Services or other charting authority will round for publication.

(1) Where course guidance is apparent (fix to facility, facility to a fix, or facility to facility): 090.17/10.03.

(2) Where course guidance must be specified (fix-to-fix): Specify NDB bearings “FROM” the facility.

090.44/7.12 (I-ABC).  
 090.11/8.20 (ABC R-270).  
 090.34/10.56 (XXX Brg 090).  
 251.33/7.89 (M-AVE).

(3) Where there is a DR route defined from fix to fix via two segments (dogleg), and there is no altitude change between segments, the course, distance, and guidance must be identified for each segment in one single entry.

130.49/7.10 (ABC R-130) & 185.01/4.33 (XYZ R-185).  
 005.21/3.60 (Hdg) & 296.36/4.82 (I-MSP).  
 130.28/4.12 (Hdg) & 180.18/7.45 (ABC R-360).

(4) Enter the DME arc used in an arc segment: 14.00 DME Arc.

(5) When a lead radial or bearing is required, enter the data in parentheses immediately below the course and distance data in the following manner:

(ABC LR-300)  
 (ABC LBRG 300)

(6) For RF leg types, document the radius, direction (clockwise or counter-clockwise), and the CNF point used to define this arc segment followed by the arc distance in the following manner:

(4.72 NM RADIUS CW (CFYUQ))/2.68

**Note:** The arc radius, direction, and CNF used to make up the RF leg are shown in parenthesis will not be published on the chart. This information is provided for database use only. Only the RF track distance and altitude will be published on an RF turn.

c. Altitude column. Enter the altitude authorized for the route, except for an RNAV (GPS or RNP) missed approach segment from the MAP to a turn fix.

(1) When the routing requires a course reversal, the altitude authorized must not be lower than the course reversal altitude.

(2) The altitude authorized for any terminal route must be no lower than the altitude authorized for succeeding segments. Where more than one segment joins at a common fix, a common altitude should be selected.

(3) Where a localizer segment fix minimum altitude differs from that required for ILS, enter the ILS minimum altitude. Directly below this value, enter the LOC minimum altitude followed by the same attention symbol used in paragraph 8-6-7.d(1) so that both plan and profile views are identically annotated.

(4) When mandatory or maximum altitudes are an operational necessity, document the limitations in "Additional Flight Data" [see paragraph 8-6-10.o].

**8-6-5. Radar terminal area maneuvering sectors and altitudes (Form 8260-4).** When an MVA chart for these areas has been approved for ATC use by Aeronautical Information Services, do not repeat this data on the Form 8260-4. In such cases, enter a note describing the source of the data as follows: “As established by the current (facility name) ASR Minimum Vectoring Altitude Chart.”

**a.** Where the MVA at the FAF is equal to/less than the FAF altitude, document the final segment on Form 8260-9 [see also paragraph 8-6-9.t(1)].

**b.** Where the MVA at the FAF or at fixes preceding the FAF is greater than the FAF altitude, document those segments prior to the FAF on Form 8260-9 [see also paragraph 8-6-9.t(2)].

**8-6-6. Missed Approach.**

**a.** General. The missed approach represents a critical phase of flight; therefore, the missed approach should be designed with a minimum of complexity. The instructions on the form must reflect the actual design. The straight-ahead missed approach is the most desirable. Each non-radar missed approach must terminate at a clearance limit (fix or facility) and *should* terminate/connect to the en route structure.

**Note:** For helicopter procedures, it is recommended that the missed approach terminate/connect to the en route structure, but it is not required.

**b.** Clearance limit altitudes specified in missed approach instructions may be rounded to nearest 100-foot increments, provided Required Obstacle Clearance (ROC) is maintained. Other altitudes used in the missed approach should also use 100-foot increments. If this causes SIAP construction difficulties, use of 50-foot increments is the preferred alternative, with use of 20-foot increments the last resort.

**c.** Missed approach point. On vertically guided procedures the DA establishes the MAP. On nonprecision approach procedures, the MAP is established at a specified fix or at a specified distance from the FAF/PFAF. For ILS combined with LOC procedures, identify both the ILS and LOC MAPs.

(1) Form 8260-3/7A. For the precision portion of the ILS procedure, enter: “ILS: DA.” For RNAV (GPS) enter as appropriate: “LPV: DA,” “LNAV/VNAV: DA,” “LP: (Fix Name),” “LP: RWXX,” “LNAV: (Fix Name),” “LNAV: RWXX.” For RNAV (RNP) enter “RNP: DA.” Designate the LOC MAP as a specific distance after the FAF/PFAF, or at a fix/facility. When FAF to MAP timing is used, specify the distance to the nearest 0.01 NM. In addition to FAF to MAP timing, DME (if available) should be used as an additional means to identify the MAP *only* if the DME source is associated with the localizer (i.e., LOC/DME facility). Specify the DME value to the nearest 0.01 NM: “LOC: X.XX NM AFTER (FAF NAME/fix makeup) OR AT I-XXX X.XX DME”

(2) Forms 8260-4/5. In the box, titled “MAP,” identify the missed approach point as a distance after the FAF/PFAF or at a fix/facility,” as appropriate. If FAF to MAP timing is used, DME (if available) should be provided as an additional means to identify the MAP, provided the

DME source is the same as the final approach course facility. Specify the DME value to the nearest 0.01 NM. “MAP: X.XX NM AFTER (FAF NAME/fix makeup) OR AT XXX X.XX DME.”

(3) RNAV. Do *not* list MAP coordinates for GPS or radial/DME for RNAV (VOR/DME). Enter the name of the MAP WP as follows:

BONLI (MAP not at threshold)

RW16L (MAP at threshold)

**d.** Missed approach instructions.

(1) Where possible, develop missed approach procedures (except radar) using the same type of navigation guidance utilized for the final approach segment.

(2) Normally, a missed approach course/heading should be specified. If no course/heading is specified, the aircraft is expected to maintain the last established course/heading. Do *not* use the terminology “Climb runway heading” or “Climb straight ahead”; e.g., use “Climb to 2800...” For turning missed approach procedures, specify the direction of turn; e.g., “Climb to 3100 then left turn direct XYZ VOR/DME and hold.”

**Note 1:** To standardize and clarify altitudes and the meaning of “and” or “then” when used as connecting words between segments of the missed approach, “and” means a continuous climb to the stated altitude; “then” means the altitude condition must be reached at the point prior to the connecting word “then”, and either is maintained through the remaining missed approach or a second altitude will be stated.

**Note 2:** When using the word “direct” in the missed approach instructions, ensure that all categories of aircraft are evaluated; i.e., CAT A is not encompassed in CAT D missed approach area and vice versa. On RNAV procedures, use the term “direct” *only* when design incorporates a DF leg.

(3) Where the missed approach course differs from the final course: “Climb to 2800 on ABC R-180 to ABC VORTAC and hold.”

(4) When the missed approach point is also the missed approach holding fix and straight-ahead climb is not practical: “Climbing right turn to 2500 in ABC VOR holding pattern.” In some cases, a straight-ahead climb, or climb via a specified course/heading to an altitude, prior to returning to the holding fix, may be necessary for aircraft with larger turning radii. When this occurs, use the terminology in paragraph 8-6-6.d(5).

(5) When obstacles in a turning missed approach area require an initial straight-ahead climb: “Climb to 3100 then climbing left turn to 4000 direct ABC VOR and hold” or “Climb to 3100 on ABC R-180 then climbing left turn to 4000 direct ABC VOR and hold.”

(6) When circumstances (terrain, obstructions, special use airspace, etc.) require an immediate turn: “Immediate climbing right turn to 4000 direct ABC VOR” or “Immediate climbing right turn to 4000 on heading 070 then direct ABC VOR and hold.”



**Note:** The word “immediate” is an emotion-laden word and should only be used when deemed absolutely necessary by the procedure designer and/or flight inspection/validation pilot to enhance safety. If used, document Form 8260-9 with reason this was used.

(7) Missed approach procedures requiring a turn of more than 15 degrees (except for helicopter procedures; RNAV procedures, see Order 8260.58, chapter) must specify an altitude that is at least 400 feet above the TDZE prior to commencing a turn. Round the resulting altitude to the next higher 100-foot increment: “Climb to 1200 then climbing left turn to 3100 on heading 070 and ABC R-167 to ABC VOR and hold.” Alternatively, a specific point (fix, waypoint, etc.) that will allow sufficient distance, at an assumed 200 feet per NM (400 feet per NM for helicopter operations) or specified gradient rate of climb to reach 400 feet above TDZE may be used: “Climb on ABC R-090 to 9 DME, then climbing left turn to 5000 direct XYZ VORTAC and hold.” See also paragraph 8-6-6.b for rounding guidance.

(8) If the procedure serves VOR as well as TACAN equipped aircraft, address TACAN requirements also: “Climb to 5500 on ABC R-111 then climbing right turn to 6000 direct ABC VORTAC and hold (TACAN aircraft continue on ABC R-280 to CAROL 10 DME and hold W, LT, 100 inbound.)”

(9) LOC courses are specified in compass points, and NDB courses as “courses to” or “bearings from.” “Climb to 3000 on I-ABC Localizer NE course (030) and course 350 to DEF NDB and hold.”

(10) When the missed approach requires no specific direction of turn: “Climb to 7000 on ABC R-197 then direct ABC VOR and hold.”

(11) Detailed RNAV missed approach instructions may not be required when the missed approach being depicted in the planview of approach chart clearly conveys what is coded in the database loaded into the aircraft’s navigation system. However, the procedure specialist may, elect to publish detailed RNAV missed approach instructions when deemed necessary to ensure turning and/or altitude limitations are clearly understood by the pilot. When doing so, those instructions must convey the intended wording to the employed leg type. For example, the word “course” reflects a CF leg design; “track” reflects a TF leg design; “direct” indicates DF leg. However, when an RF leg is used, specify only the direction of the turn, (i.e., do not use “radius” as part of the instructions). Include speed restrictions, if required, at the beginning of the missed approach text to include the name of the fix where the speed restriction ends [see paragraph 4-6-10.g].

**Examples:**

“Climb to 5000 on the RNAV missed approach route to LVD VOR and hold” or,

“Climb to 8000 on the RNAV missed approach route to JAGUR and hold, continue climb-in-hold to 8000” or,

“Climb to 5000 on track 080.22 to SANDY and track 104.56 to GINGR and hold” or,

“Climbing left turn to 5000 direct CHERL and hold” or,

“Climb on course 098.32 to JARID, then climbing right turn to 6000 direct BOYCA and hold,” or,

“(Do not exceed 240 KIAS until WODVU) Climb to 4000 on track 281.06 to FIKOG, right turn to WODVU, then track 011.23 to BTG VORTAC and hold” or,

Climb to 2500 direct CRAZY then climbing right turn to 5000 direct INSAN and direct LOONY and hold.

(12) RNAV (RNP) missed approach procedures require a note in the briefing strip that informs the pilot when the missed approach segment requires the use of RNP less than 1.0. Use “Chart note: Missed approach requires RNP less than 1.0.”

**Note:** This note is required when the final approach segment (FAS) RNP is carried into the missed approach segment, i.e., missed approach *does not* splay at 15 degrees from the FAS RNP area.

e. Radar missed approach point and missed approach instructions. A missed approach point and missed approach instructions must be provided for each runway authorized radar straight-in landing minimums. A missed approach point and missed approach instructions must also be provided when only circling minimums are authorized. This data must be included in the “Missed Approach” section of Form 8260-4. When feasible, provide a non-radar missed approach procedure. Radar missed approach instructions are issued to the pilot by ATC and will not be charted.

f. Missed approach climb gradient (CG). When missed approach climb gradient in excess of 200 feet per NM (400 feet per NM for rotary wing) has been established, the following items must be accomplished:

(1) The required gradient must be published on the chart. Immediately following the missed approach instructions, enter the required gradient as follows: “\*Missed Approach requires minimum climb of (number) feet per NM to (altitude).”

**Note:** An asterisk (\*) or other attention symbol, as appropriate, will be used to indicate which line of minima requires the use of the climb gradient greater than the minimum standard.

**Examples:**

LPV DA\*  
LNAV/VNAV DA\*\*  
LPV DA  
LNAV/VNAV DA  
RNP 0.15 DA@  
RNP 0.22 DA@@

(2) In addition to the lower minima that require the use of the climb gradient greater than the minimum standard, minima will be published to support the minimum standard climb gradient for the same type of minima [see examples above]. It is preferred that both minima be placed on the same chart; however, an alternative is to publish a second chart containing the same type minima as the first chart that will permit the use of a standard missed approach climb gradient. If the “second chart” method will be used, reference to the alternative must be placed on the chart containing the climb gradient greater than the minimum standard, referring to the procedure with

the standard climb gradient. In addition to the text specified in paragraph 8-6-6.e(1), add at the end: “; if unable to meet climb gradient, see {procedure name}.”

(3) Do not establish a greater than standard climb gradient for Circling minimums.

**g.** Missed approach holding. Holding must be established at the clearance limit. When holding is specified as part of the missed approach instructions, include holding details under “Additional Flight Data.” Do not enter holding details under “Additional Flight Data” when the missed approach is to the FAF or IF where a holding pattern is used in lieu of PT. When charting of the missed approach holding pattern is not required by ATC, include the evaluated holding pattern information in the “Additional Flight Data” with the note “Do Not Chart.” Additionally, document on the Form 8260-9 a reason for not charting.

(1) When a missed approach climb-in-holding is required, include this information in the missed approach instructions: “Climb to 8000 on course 015 to DIXIE and hold, continue climb-in-hold to 8000.” If the 200/230 KIAS climb-in-hold speed has been applied for holding patterns restricted to 175 KIAS [see paragraph 8-5-2.h(7) note], include that speed restriction in the missed approach instructions: “Climb to 8000 on course 015 to DIXIE and hold, do not exceed 230 KIAS when continuing climb-in-hold to 8000.”

(2) When a missed approach holding altitude has been established that does not permit a return to the IAF or allow for en route flight, include in the missed approach instructions the altitude that can be climbed to in the holding pattern to reach the en route structure: “Climb to 4000 on course 270 to BONZO and hold, continue climb-in-hold to 9000.”

**Note 1:** Adequate communication and radar coverage must be considered when climb-in-hold is dependent on ATC authorization.

**Note 2:** Climb-in-holding guidance also applies when the missed approach holding is collocated with a “hold-in-lieu” approach segment.

(3) Where a holding pattern is established at a final approach fix in lieu of a conventional procedure turn, the minimum holding altitude must meet the altitude limitation requirements of Order 8260.3.

**Note:** Holding in-lieu-of PT at the FAF is not authorized for RNAV procedures.

(4) Where a holding pattern is established at an intermediate fix in lieu of a conventional procedure turn, the rate of descent to the final approach fix must meet the descent gradient requirements of Order 8260.3.

(5) Where a holding pattern is established for the missed approach at an intermediate or final approach fix, and a holding pattern is used in lieu of a procedure turn, the MHA for the missed approach must conform to the altitude or descent gradient requirements of paragraph 8-6-6.g(1) or 8-6-6.g(2). Missed approach holding must not be established at the FAF for RNAV procedures.

(6) Where a holding pattern is established for the missed approach at an intermediate or final approach fix, and a holding pattern is *not* used in lieu of a procedure turn, establish a conventional procedure turn to permit pilot flexibility in executing a course reversal and descent to final approach fix altitude. The missed approach holding pattern must be situated on the maneuvering side of the procedure turn to permit this to occur. This paragraph is not applicable to RNAV procedures.

**h. Alternate missed approach.**

(1) Establish alternate missed approach procedures (when possible) when the instrument procedure navigation facility for the final and missed approach course differ. Additionally, alternate missed approach procedures may be established when requested by Air Traffic. Do not establish alternate missed approach instructions for RNAV procedures. *Alternate missed approach instructions must not be charted and will either be issued by ATC or specified by NOTAM.* When alternate missed approach instructions are established, they immediately follow the primary missed approach instructions as a separate entry.

**ALTERNATE MISSED APPROACH (DO NOT CHART):**

CLIMB TO 3000 THEN TURN RIGHT DIRECT DD LOM AND HOLD.

(2) The alternate missed approach termination facility/fix and holding pattern must be charted in the planview. If the alternate missed approach termination facility/fix and holding pattern is not already used in the procedure, then add a note in “Additional Flight Data.”

**Examples:**

Chart in planview: (facility/fix name).

Chart in planview: ALTERNATE MA HOLDING, HOLD SW DD LOM, RT, 051 INBOUND.

**i. NAVAID outages.** When temporary NAVAID outages (planned or unplanned) prohibit the use of the primary missed approach for a procedure, Aeronautical Information Services has the responsibility to ensure an IFR missed approach procedure is published, either on the chart or by NOTAM in the event of lost communications. This does not preclude Air Traffic from issuing alternate climb-out instructions.

**8-6-7. Profile - Lines 1 through 8.**

**a. Line 1.**

(1) Enter PT side of course as left or right of the outbound course; i.e., the large side of the template. Enter the outbound course to the hundredths of a degree, procedure turn altitude, procedure turn distance, and name of fix from which the procedure turn is authorized as follows:

PT L SIDE OF COURSE 018.13 OUTBOUND 2300 FT WITHIN 10 NM OF MELIS INT (IAF)

(2) When an obstacle in the PT entry zone precludes early descent to PT altitude, enter the altitude restriction in Additional Flight Data as “Chart (altitude) prior to (PT Fix) in profile.”

(3) Leave line 1 blank when there is no PT, or where hold-in-lieu-of-PT or a teardrop course reversal maneuver is established.

**b. Line 2.**

(1) Where a SIAP requires a teardrop course reversal maneuver, enter the data in accordance with the following examples:

(a) Collocated facility: Teardrop R-160 outbound, R-180 inbound, 4300 within 15 NM of ABC VORTAC (IAF).

(b) Non-collocated facility: Teardrop R-160 (ABC VORTAC) (IAF) outbound to NIXON/19.00 DME, 355.00 (I-XYZ) inbound, 3000 to KENNY OM/INT.

(c) Non-collocated facility, altitude at turn point or high altitude teardrop: Teardrop R-220 (ABC VORTAC) (IAF) outbound to NIXON/19.00 DME, 5000, 257.28 (I-XYZ) inbound, 4500 to KENNY OM/INT.

(d) Non-collocated NAVAID – IAF after NAVAID – altitude at turn point or high altitude teardrop - IAF after NAVAID: Teardrop R-220 (ABC VORTAC) START/7.00 DME (IAF) outbound to NIXON/19.00 DME, 5000, 257.28 (I-XYZ) inbound, 4500 to KENNY OM/INT.

(e) Non-collocated NAVAID – IAF at NAVAID – altitude at turn point – stepdown fix(es) or high altitude teardrop - IAF at NAVAID - stepdown fix(es) (*example with three stepdown fixes in outbound segment of the teardrop*): Teardrop R-220 (ABC VORTAC) (IAF) outbound, MANNY INT 10000 MOOEE INT 9200, JACCK INT 7500 feet to PEEPP INT 6800, R-257 (ABC VORTAC) inbound, 6000 to BOYZS INT.

(f) Non-collocated NAVAID – IAF after NAVAID – altitude at turn point – stepdown fix(es) or high altitude teardrop - IAF after NAVAID - stepdown fix(es) (*example with three stepdown fixes in outbound segment of the teardrop*): Teardrop R-220 (ABC VORTAC) CARRS/7.00 DME (IAF) outbound, MANNY INT 10000, MOOEE INT 9200, JACCK INT 7500 to PEEPP INT 6800, R-257 (ABC VORTAC) inbound, 6000 to BOYZS INT.

(2) Where an IAP requires a holding pattern in-lieu-of-PT [see Order 8260.3, chapter 2, section 2-4], establish the direction of holding based on the inbound course as shown in table 8-6-1. Information will also include the minimum and maximum holding altitudes. Enter holding data in accordance with the following examples:

(a) Hold SE OMEGA LOM, RT, 313.09 inbound, 1600 in lieu of PT (IAF), Max 4000.

(b) Hold W FIXXR, LT, 103.28 inbound, 3000 in lieu of PT (IAF), Max 8000.

**Table 8-6-1. Holding Pattern Directions**

<b>Magnetic Course (Inbound)</b>	<b>Magnetic Course (Based on Inbound Course)</b>
338-022	S
023-067	SW
068-112	W
113-157	NW
158-202	N
203-247	NE
248-292	E
293-337	SE

(3) On procedures that do not authorize a PT or a hold-in-lieu of PT at the PFAF, enter the fix/facility at which the profile view is to start.

(a) For procedures with a single IF, the profile must include the IF. If required for clarity, the profile view may be extended to depict any fix outside the IF provided the intermediate fix and preceding fixes are located on the final approach course extended.

#### Profile starts at STING

(b) For procedures with multiple intermediate fixes (applicable only to RNAV (RNP) AR procedures), the profile starts at the first common fix encountered inbound between the IF and PFAF; otherwise, the profile starts at the PFAF. In addition, use the following note: “Chart profile note: See Planview for Multiple IF locations.”

#### c. Line 3.

(1) Enter the FAC on all procedures. Enter the exact electronic course to a hundredth of a degree. Aeronautical Information Services will chart to the nearest whole radial/course for publication. The FAC is determined as follows:

(a) ILS, LOC, SDF, and LDA procedures - enter the official course alignment based on antenna location and orientation.

(b) RNAV procedures - enter the course established by Aeronautical Information Services computation. For RNAV procedures that contain RF turns in the final segment, place an asterisk here. An asterisk will then be placed prior to the fix names that make up the final approach segment in the terminal routes “To” block.

(c) NDB, VOR, and TACAN procedures - enter the computed magnetic radial/course/bearing or reciprocal unless flight inspection establishes otherwise [see paragraph 8-6-10.h]. If other than the computed value, enter both values in the “Remarks” section of the Form 8260-9 [see paragraph 8-7-1.c(8)].

(2) Select FAF for all procedures, except those procedures without a FAF that use on-airport facilities, or ILS procedures that do not authorize LOC/AZ-only or circling.

**Note 1:** For ILS procedures that do not contain localizer minima select PFAF.

**Note 2:** For RNP, LPV and LNAV/VNAV procedures that do not contain LNAV minima, select PFAF.”

(a) Vertically guided procedures will normally have the PFAF collocated or within one NM of the FAF; however, when the PFAF is 1 NM or greater from the FAF, a separate named PFAF is required. Document this following the FAF name as follows:

FAF: SKIPI LOM PFAF: NACON

**Note:** The PFAF distance to the FAF will be calculated and charted.

(3) Enter the distance from the FAF to the MAP in nautical miles and hundredths. For all non-RNAV procedures, leave blank when the time/distance table is not required for determination of the MAP, such as when the MAP is a facility or fix. All RNAV procedures must have the FAF to MAP distance specified (a time/distance table will not be published on RNAV procedures).

**Note:** It may be necessary to define MAP with a time/distance table when criteria do not permit use of DME to define the MAP (e.g., DME satisfactory to define FAF but MAP signal source exceeds 23 degrees angular divergence).

(4) Enter the distance from the FAF to the LTP/FTP if straight-in minimums are authorized, to the nearest hundredth of a NM. Leave blank for circling-only and on-airport No-FAF SIAPs, Copter point-in-space approaches, and vertically guided procedures that do not incorporate a non-vertically guided procedure FAF; e.g., ILS without a LOC procedure or RNAV procedures that do not have LNAV minimums.

**d.** Line 4. Enter fixes and minimum altitudes that are to be depicted on the profile view. On procedures that do not authorize a procedure turn or holding pattern, the facility or fix designated as the start of the profile in line two must be the first fix/facility entered on line four [see paragraph 8-2-5.i(3)]. Where radar vectors are required for procedure entry, ensure the relevant minimum altitude shown is no lower than the MVA at the IF.

(1) Fix altitudes established on ILS procedures for LOC use only, annotate it as follows:

MIN ALT: CAROL 1600\*

\*LOC only

**Note 1:** When the nonprecision FAF altitude is the same as GS intercept altitude, an annotation like this is not required.

**Note 2:** Do not establish altitude restrictions at fixes located between the PFAF and RWT on vertically guided approach procedures unless they are applicable to a non-vertically guided procedure published on the same approach chart (Example: ILS chart with a localizer procedure that requires publication of a stepdown fix) and the fix altitude is annotated for use on the non-vertically guided procedure only.

(2) If a stepdown fix is required on a chart with LNAV and LP minimums, the stepdown fix applies to both LNAV and LP. Do not establish a stepdown fix applicable only to LNAV or only to LP.

(3) For RNAV (GPS) procedures, if a stepdown fix for an LNAV procedure is required and an LPV and/or LNAV/VNAV procedure is published on the same chart, annotate that the stepdown fix only applies to the LNAV procedure; document as follows:

MIN ALT: MIZZU 1260\*

\*LNAV only

(4) Enter all fixes and minimum altitudes after completion of procedure turn, including any fixes associated with the procedure turn or intermediate segment, and including the FAF and any final stepdown fixes. Enter the IAF and minimum altitude when required for obstruction clearance in the PT entry zone [see paragraph 8-6-5.b].

**Note:** Do not enter a fix on line 4 that is positioned on the profile prior to the procedure turn or holding point unless the fix is required for obstacle clearance or noise abatement after completion of the PT.

(5) Make no entry on line 4 for on-airport facilities with a single set of minimums and no stepdown fix, except as noted in paragraph 8-6-5.d(2), since the minimum altitude over the facility is determined by the MDA.

(6) For procedures with a FAF, an entry on line 4 is required for the FAF and the stepdown fix(es), if established.

(7) For procedures with a final segment stepdown fix, when a secondary remote altimeter setting is available and an MDA adjustment is necessary, the stepdown fix must also be annotated to reflect the necessary altitude adjustment as follows:

MIN ALT: PAULA 1420\*

\*1540 when using (location) altimeter setting.

e. Line 5. (Form 8260-3). Enter distance in nautical miles and hundredths to the LTP/FTP from the PFAF (for RNAV, ILS, or GLS procedures that do not contain nonprecision minima [i.e., LNAV, LOC, or Azimuth Only]), FAF, or OM, whichever is applicable.

(1) On SA CAT I procedures, enter the distance in feet to the threshold from the 150-foot HAT point.

(2) On CAT II and III procedures, enter distance in feet to the threshold from the inner marker (IM) and 100-foot HAT points (as applicable).

(3) RNP, LPV, and LNAV/VNAV. Specify the distance to threshold from the lowest DA. Enter the HAT value and distance to threshold.



(4) On CAT I, II, III procedures, enter distance in feet from the threshold to a point abeam the glide slope (GS) antenna (for ILS). This entry will not appear on RNAV procedures.

**f.** Line 6. (Form 8260-3). Applicable to vertically guided procedures only.

(1) Enter minimum glide slope/glide path (GS/GP) intercept altitude. The GS/GP intercept point is considered to be the PFAF for vertically guided procedures.

(2) For RNAV (RNP) procedures that contain RF turn fixes located between the PFAF and LTP/FTP, enter the computed glidepath altitude at each fix.

**Example:**  
NUDCI 1716

(3) If a fix or facility is located on the final approach course between the precise FAF (GS/GP intercept) and the nonprecision FAF (no OM/LOM installed), enter the name of the fix or facility and the GS/GP elevation in feet. Where nonprecision minimums are not published, establish a fix, and associated GS/GP altitude.

(4) Enter the altitude of the GS/GP in feet at the OM/PFAF. For procedures where the OM exists but no longer serves as the LOC FAF (moved to coincide with PFAF), an ILS “gross error” check altitude will still be depicted at the OM. When this situation occurs, in the “Additional Flight Data” block, enter “Chart OM in half-tone.”

(5) Enter the altitude of the GS in feet at the MM, and the IM for ILS procedures only. If not installed, leave blank.

**Note:** GS/GP altitude computations contained in Order 8260.3, chapter 10 include earth curvature (EC) values.

**g.** Line 7. (Form 8260-3).

(1) Enter the computed VNAV angle, LPV angle, or the commissioned ILS angle (as appropriate) to the nearest hundredth of a degree. This angle must be used to make calculations entered in lines 5, 6, and 7.

**Note:** For charting, use “GS” for ILS procedures and “GP” for RNP, GLS, LPV, and LNAV/VNAV procedures.

(2) Enter the threshold crossing height (TCH) to the nearest tenth (.1) of a foot. When a threshold is displaced, enter the TCH over the displaced threshold, but do not identify it as such. If the TCH over the displaced threshold is below the minimum value specified in Order 8260.3 table 10-1-2, enter the TCH values at the displaced threshold and runway end as shown in the following example:

TCH 32.4 at displaced THLD; 67 at runway end.

**Note:** Flight inspection/validation, as well as instrument procedure databases, must be based upon the same GP orientation elevation. Use AIRNAV as the official data source.

(3) For RNAV procedures, state whether the 34:1 and 20:1 obstacle assessment [see Order 8260.3, chapter 3] surfaces are clear or not; e.g., 34:1 is clear or 34:1 is not clear; 20:1 is clear or 20:1 is not clear. If the 34:1 and 20:1 surfaces are not clear, those obstacles will be identified on Form 8260-9.

**h. Line 8.**

(1) Enter the identification and type of facility from which the MSA is computed. Leave blank for procedures that contain a TAA. On ILS and LOC procedures, an NDB or VOR facility located on the localizer course must be used to provide MSA information when available. If an omni-directional NAVAID is not available on the LOC course, the primary omni-directional NAVAID serving that area must be used. If there are none, the Airport Reference Point (ARP) may be used when all other options have been exhausted. For RNAV, enter the named MAP waypoint, or, if at threshold, the appropriate identifier; e.g., RW16 or RW16R. For RNAV (VOR/DME), enter the named RWY WP for straight in, or named APT WP for circling. For an MSA based on an ARP, use the airport identifier followed by the minimum altitude.

MSA from: “ARP (Airport ID) 4000”

(2) Enter the MSA information clockwise by sectors, if used. Do *not* establish sectors for MSAs on RNAV procedures or MSAs based on an ARP. Sectors are referenced to bearings from the primary omni-directional NAVAID as follows:

MSA from OAK VORTAC 360-170  
4900, 170-360 3700.

(3) Provide a single MSA only when the altitude difference between all sectors does not exceed 300 feet as follows:

MSA from XYZ VORTAC 7700.

MSA from RW16R 7700.

MSA from WGNUT 7700.

(4) Enter the radius of the sector if more than 25 NM; and when the facility-to-airport distance exceeds 25 NM, use a radius of up to 30 NM maximum to include the airport landing surfaces as follows:

MSA from ABC VORTAC 060-150 2300,  
150-240 3000, 240-330 3600, 330-060 4200 (28 NM).

(5) Where more than one procedure for an airport is established on the same facility, the MSA sector divisions and altitudes must be identical for each procedure.

- (6) Amend procedures anytime the MSA value does not provide the minimum ROC.

**8-6-8.** Equipment requirements notes for conventional instrument procedures and performance based navigation (PBN) instrument flight procedures.

**a.** Conventional instrument procedure equipment requirements notes. Determine the need for equipment notes after evaluating all SIAP segments, including procedure entry and missed approach. There may be multiple or a combination of notes necessary to support varying requirements. When appropriate, state the particular portion(s) of the instrument procedure to which the equipment requirement applies in an easy to understand format. The following are several examples that are not all inclusive of options available that can be used depending on each circumstance. These notes will appear on the approach chart in a portion dedicated specifically for additional equipment required to conduct the procedure or portions thereof.

**Note:** To avoid proliferation of equipment requirement notes, all IFR aircraft are assumed to have at least one VOR receiver. Therefore, the note “VOR required” is not appropriate.

(1) In addition to what is specified in paragraph 8-6-9.g(2), where Radar systems may provide assistance in conducting an instrument approach, other equipment may be used with those Radar systems, or individually, for procedure entry from the en route environment; enter:

- (a) Equipment requirements note: “ADF Required For Procedure Entry;” or
- (b) Equipment requirements note: “DME Required For Procedure Entry;” or,
- (c) Equipment requirements note: “ADF OR DME Required For Procedure Entry;” or
- (d) Equipment requirements note: “RNAV 1-DME/DME/IRU or GPS or Radar or DME Required For Procedure Entry;” or
- (e) Equipment requirement note: “RNAV 1-GPS or RADAR Required For Procedure Entry;” or
- (f) Equipment requirements note: “RNAV 1-DME/DME/IRU or GPS or RADAR Required For Procedure Entry.”

(2) Where other navigation equipment is required to complete the approach, including missed approach; e.g., VOR, ILS, or other non-ADF approaches requiring ADF or DME for the intermediate and/or missed approach segments, enter:

- (a) Equipment requirements note: “DME Required” (i.e., DME is required for the intermediate segment or both the intermediate and missed approach segments), or
- (b) Equipment requirements note: “ADF Required” (i.e., ADF is required for the intermediate segment or both the intermediate and missed approach segments), or
- (c) Equipment requirements note: “DME Required For LOC Only.” (i.e., LOC procedure published on the same chart with an ILS and DME is required for defining the FAF).

(3) When an ATC surveillance system is also available for vectoring an aircraft to a segment of an instrument approach, use:

(a) Chart equipment requirements note: “ADF or Radar required for (segment of approach),” (i.e., if ADF is required for the segment of the approach and/or Radar is available.)  
or

(b) Chart equipment requirements note: “ADF or DME or Radar required for (segment of approach), (i.e., if ADF or DME is required for the segment of the approach and/or Radar is available).

(4) Where radar is the *only* method of determining or defining a terminal fix, use “Chart equipment required note: Radar Required To Define {fix name(s)}.”

(5) ILS/LOC procedures that require RNAV for *all* other segments must have an equipment requirements note stating the PBN requirements [see paragraph 8-6-8.b] for the PBN segments. The procedure, including missed approach, must be evaluated to determine if all the segments support DME/DME/IRU operations.

(a) If there are no restrictions (i.e., no critical DMEs), enter an equipment requirements note: “RNAV 1-DME/DME/IRU or GPS Required.”

(b) If there are critical DME facilities identified during the evaluation, equipment requirements note: “RNAV 1-GPS Required.” See section 4-6 for additional requirements when mixing RNAV with ILS/LOC procedures.

(6) ILS/LOC procedures that contain both conventional and RNAV segments must have an equipment requirements note stating the PBN requirements (see paragraph 8-6-8.b) for the PBN segment. These segments must have been evaluated to ensure the route(s) support DME/DME/IRU operations.

(a) If there are no restrictions (i.e., no critical DMEs), enter an equipment requirements note: “From {fix name(s)}: RNAV 1-DME/DME/IRU or GPS Required.”

(b) If there are critical DME facilities identified during the evaluation, enter an equipment requirements note: “From {fix name(s)}: RNAV 1-GPS Required.” See section 4-6 for additional requirements when mixing RNAV with ILS/LOC procedures.

(c) Additionally, if the procedure does not contain a means for aircraft that are not RNAV equipped to get to the final approach course and the procedure contains a conventional missed approach, in addition to either “(a)” or “(b)” above, enter an equipment requirements note: “Aircraft Not DME/DME/IRU or GPS Equipped - Radar Required For Procedure Entry” or, if applicable, “Aircraft Not GPS Equipped - Radar Required For Procedure Entry.”

**b.** PBN requirements notes. This information will be entered into a block on the approach chart referred to as the “PBN Requirements Box.” These notes will appear on the approach chart in a portion dedicated specifically for PBN requirements to conduct the procedure or portions thereof.

(1) All PBN, including GLS and RNAV to ILS/LOC approach procedures require an annotation of the PBN navigation specification (NavSpec) used for the navigation on the procedure to indicate the appropriate qualification required to conduct the instrument procedure. Use “Chart PBN NavSpec requirement note: “RNAV 1” or “RNP 1” or “A-RNP” or “RNP APCH” or “RNP AR APCH” or “RNP 0.3”; see Order 8260.58 for determining the proper NavSpec application.

(2) When PBN approach procedures contain advanced PBN functions, which are in addition to what is required in the PBN NavSpec, the procedure must be annotated with the advanced function; Example, enter PBN requirements note: “RF Required.” See paragraph 4-6-10.h for specific guidelines and placement of the “RF Required” notation.

(3) GLS procedures require the use of GPS to navigate to the GLS final approach segment and execute the missed approach. Enter PBN requirements note: “GPS REQUIRED.”

### 8-6-9. Notes.

**Note:** See also paragraphs 2-9-3, 4-1-5, 8-2-4.b, 8-2-5.f, 8-6-11.b, 8-6-11.k, 8-6-11.m, 8-6-11.n, 8-6-11.o(1) through 8-6-11.o(13), 8-6-6.e, 8-6-9.t, and 8-2-18-2-1.b.

#### a. General.

(1) Data entered in this section of Forms 8260-3/4/5/7A are items that should appear on the published procedure chart as a note; e.g., notes pertaining to conditional use of a procedure, notes restricting the use of a procedure, and other notes required for procedure clarification.

(2) Unless dictated by IACC specifications, or specified as “Chart planview note” or “Chart profile note,” all notes will be charted the briefing strip, “Notes” section, of the procedure chart.

(3) When multiple notes are required, they may be combined under a single heading; e.g., “Chart planview notes,” “Chart profile notes,” or “Chart notes” followed by the actual notes.

(4) When a note on a chart applies only to a particular navigation system or line of minima, that specific information may be added to precede any type of chart note, as applicable; e.g., “Chart Note: LOC Only: (condition)” or “Chart Note: LNAV Only: (condition).”

(5) When documenting multiple approaches (e.g., CAT II/III) on a single 8260-series form that will be charted separately, notes that do not pertain to all procedures must indicate which procedure it is to be charted on; e.g., “CAT I Chart note: Circling NA North of Rwy 10L-28R” or “CAT II Chart Note: RVR 1000 authorized with specific OPSPEC, MSPEC, or LOA Approval and use of autoland or HUD to touchdown.”

**Note:** For “Special” instrument procedures that are charted by the proponent or agent hired by the proponent, placement of chart notes may be left up to the procedure development authority. However, chart note placement may be determined unacceptable by the Flight Standards PRB and require different placement or compliance with what is specified in this order.

**b.** Note restriction. Except as specified in paragraph 8-6-11.o(7), SIAPs must *not* contain notes that may be construed as regulating traffic or providing traffic advisory service. Notes containing text such as "...when assigned by ATC..." are considered to be regulating traffic and must not be used. Notes such as "VFR practice approaches NA," "Parachute operations southwest of airport," "Glider activity near airport," etc. if required, should be in the "Airport Remarks" section of the Chart Supplement. Notes regarding delays due to traffic also belong in the Chart Supplement.

**c.** Avoid caution notes about obstacles. Notes such as: "High Terrain all quadrants;" "Steeply rising terrain to 5300, 4 NM SW of approach course;" or "50 feet unlighted trees south of RWY 9 THLD" are *not* appropriate.

**d.** Avoid listing specific times in notes whenever possible, since a change in hours of operation would require amended procedures. Instead, refer to the situation directly relating to the cause. Use "Chart note: When control tower closed" or "at night." When there is *no alternative*, times may be used if the airport operator provides assurance that the hours will not change. Most operators adjust UTC hours of operation so that local hours remain the same whether or not daylight saving time is in effect. In such cases, it is appropriate to use local time in notes.

**e.** When a local altimeter setting is available at an uncontrolled airport, including those with part-time towers, the setting will be obtained on the established CTAF for that airport whenever possible. The NFDC is responsible for designating and publishing the CTAF [see AC 90-42 and AIM chapter 4]. In such cases, a note may be required. Some operators provide approved weather reporting services, full-time or part-time, to their own company aircraft or on a contract basis to others. Conditions that require notes and the associated entry for the "Notes" section are as follows:

**Note:** The phrase "except for operators with approved weather reporting service" is used only when such service is available.

(1) At airports with a part-time tower and an FSS, the CTAF will be a tower frequency and will be monitored by the FSS whenever the tower is closed. No note should be needed if full-time altimeter setting service is provided.

(2) At airports with an FSS and no tower, the CTAF is an FSS frequency. No note is needed for a full-time FSS. For a part-time FSS, use "Chart note: Obtain local altimeter setting on CTAF; when not received, use (location) altimeter setting and increase all MDAs 80 feet, and all visibilities ½ SM." Where appropriate, define application to DH and/or MDA, or address when visibility is *not* affected in all categories, within the standard note [see paragraphs 8-6-11.n(1)(a)1 and 8-6-11.n(1)(a)2]. If a remote altimeter source cannot be approved, end the note: "...; when not received, procedure NA."

(3) At airports with a part-time tower and no FSS, the CTAF will be a tower frequency even when the only altimeter source is UNICOM. In such cases use of UNICOM is authorized provided the note gives an alternate course of action if UNICOM is not contacted. In this instance, use "Chart note: When control tower closed, obtain local altimeter setting on UNICOM; when not received, (alternate action)."

**Note:** Automated UNICOM (AUNICOM) systems do not qualify as a weather reporting system, nor can they be used as an altimeter source when using instrument flight procedures. AUNICOMs are “advisory” systems only.

(4) At airports with no tower or FSS, with the altimeter setting available on UNICOM, the CTAF is UNICOM. An alternate course of action is required. Use “Chart note: Obtain local altimeter setting on CTAF; when not received, (alternate action).”

(5) At airports with no tower, part-time FSS and UNICOM are not available, use the following when the FSS is shut down: “Chart note: Obtain local altimeter setting from ATC; when not available, procedure NA.”

(6) When using remote CTAF altimeter, use “Chart note: Obtain West Allis altimeter setting on CTAF (122.8); when not received, (alternate action).”

(7) Multiple altimeter sources must not result in more than two sets of minimums. If the chosen combination of local and/or remote sources does not provide full-time coverage, deny use of the procedure when no altimeter setting is available. Use the following: “Chart note: When control tower closed, obtain local altimeter setting on CTAF; when not received, use Smith altimeter setting and increase all MDAs 140 feet, and all visibilities  $\frac{1}{2}$  SM; when neither received, procedure NA.” Where appropriate, define application to DA and/or MDA, or address when visibility is *not* affected in all categories, within the standard note [see paragraphs 8-6-11.n(1)(a)1 and 8-6-11.n(1)(a)2].

(8) When LNAV/VNAV minimums are based on remote altimeter setting and/or there is precipitous terrain in the final segment, Baro-VNAV is not authorized. Where a remote altimeter setting is primary and/or there is precipitous terrain in the final segment, use “Chart note: Baro-VNAV NA.” Where the remote altimeter setting is secondary, use “Chart note: Baro-VNAV NA when using (location) altimeter setting.”

(9) When a VDP has been established and a back-up *remote* altimeter source is provided, use “Chart note: VDP NA when using (location) Altimeter Setting.”

**f.** Automated Surface Observing System (ASOS); Automated Weather Observing System (AWOS).

(1) Automated Surface Observing System (ASOS) are automated surface weather observing stations developed through joint FAA/ National Weather Service (NWS)/ DoD agreement. ASOS are installed at designated airports and are maintained by the NWS to meet FAA requirements. ASOS report altimeter setting, wind, visibility, precipitation type/intensity (present weather), cloud/ceiling data, temperature, dew point, and precipitation accumulation. Some ASOS can also report freezing rain, thunderstorms, and/or lightning information. ASOS use commercial telephone access, may have a discrete VHF air-to-ground frequency, and are connected to the Weather Message Switching Center Replacement (WMSCR) for further dissemination.

(2) Automated Weather Observing System (AWOS) are automated surface weather observing stations certified and commissioned by the FAA. AWOS are in service, owned either by

FAA, or by non-Federal (Non Fed) operating authorities (State, local, tribal Governments and private entities). Non Fed AWOS used for aviation must be certified and commissioned by the FAA in accordance with FAA Advisory Circular AC 150/5220-16. There are many types of AWOS used throughout the Advisory Circular and recognized in other FAA orders.

- (a) AWOS-A measures and reports altimeter setting only.
- (b) AWOS-1 measures and reports wind (speed, direction, and gusts), temperature, dew point, altimeter setting and density altitude.
- (c) AWOS-2 measures and reports all the parameters of AWOS-1 system plus visibility.
- (d) AWOS-3 measures and reports all the parameters of AWOS-2 system plus precipitation accumulation (rain gauge) and cloud height. Some AWOS-3 are equipped with optional sensors for precipitation type/intensity (present weather) "P", or a thunderstorm / lightning sensor "T," or both. AWOS-3 enhanced configurations include "AWOS-3 P," "AWOS-3 T," and "AWOS-3 P/T."
- (e) AWOS-4 measures and reports all AWOS-3 P/T parameters plus freezing rain (Z) and/or runway surface condition (R). The addition of optional sensors changes the designation to "AWOS-4 Z," "AWOS-4 R," or "AWOS-4 Z/R."

**Note 1:** FAA owned and maintained AWOS stations will meet at least AWOS-3, AWOS-3 P, or AWOS-3 P/T level service. Weather and altimeter information is forwarded to the pilot via a discrete VHF radio frequency, or on a NAVAID, and may be available via commercial telephone access. All FAA AWOS are connected to the Weather Message Switching Center Replacement (WMSCR) weather distribution network for further dissemination.

**Note 2:** Some Non-Fed AWOS have a frequency and phone number only and do not go directly into the WMSCR. However, weather from many Non-Fed AWOS-3 (or better) are put on WMSCR by commercial providers per an agreement with the FAA.

(3) ASOS/AWOS/Non-Fed AWOS that transmit to WMSCR, do not require a published backup altimeter source. No notes are required on the procedure. However, a suitable backup source must be determined and adjustment computed for contingency purposes; annotate this data in "Remarks" on Form 8260-9. Each OSG-FPT must determine if a procedure requires a full time remote altimeter setting note to be published, based on reliability of the ASOS or AWOS.

(4) Backup altimeter sources are required for Non-Federal AWOS that do not transmit to WMSCR. Non-Federal AWOS not transmitted to WMSCR *do* require backup altimeter sources. Do *not* publish backup altimeter source information as a second set of minimums for the AWOS backup altimeter source. Instead, use "Chart note: When local altimeter setting not received, use (location) altimeter setting and increase all MDAs 100 feet and all visibilities ½ SM." Where appropriate, define application to DA and/or MDA within the standard note [see paragraphs 8-6-11.n(1)(a)1 and 8-6-11.n(1)(a)2]. If a suitable backup altimeter source is not available, deny use of the SIAP via the following note: "Chart note: When local altimeter setting not received, procedure NA." Use these standard notes where AWOS is broadcast.



(5) AWOS may be used as a remote secondary altimeter source when data is available to FSS specialists and ATC facilities through WMSCR.

(6) ASOS/AWOS at a remote location may be used as a primary altimeter source for an airport. In this instance, use “Chart note: Use (location) altimeter setting.” However, Non-Federal AWOS not transmitted to WMSCR still require backup altimeter setting sources. In these cases use “Chart note: Use (location) altimeter setting; when not received, use (location) altimeter setting and increase all MDAs 100 feet and all visibilities ½ SM.” Where appropriate, define application to DA and/or MDA within the standard note [see paragraphs 8-6-11.n(1)(a)1 and 8-6-11.n(1)(a)2]. When an airport uses a remote AWOS/ASOS/AWSS that is not available from a FSS to be used as a primary altimeter source, flight inspection ensures AWOS/ASOS/AWSS/non-Federal AWOS discrete frequency reception at the IAFs of that airport.

(7) ASOS/AWOS-3 (or better) may be used as a remote secondary altimeter source and to support alternate minimums at an airport when:

(a) They are installed and commissioned.

(b) Their data are available to FSS specialists and ATC through WMSCR for flight planning purposes.

(8) When the ASOS/AWOS information is transmitted over a discrete frequency (not CTAF) or the voice portion of a local NDB or VOR, AWOS is receivable within 25 NM of the AWOS site, at or above 3000 feet and below 10000 feet AGL. If ASOS/AWOS is located on the voice portion of a NAVAID, flight inspection checks for interference. This check is performed prior to test transmissions.

**g.** ASR or ARSR may be available to provide assistance in vectoring to the approach course, identifying fixes, or to provide instrument approaches. Include applicable notes to inform the pilot of these capabilities and applicability to the instrument approaches [see paragraph 8-2-5].

(1) When ASR and/or PAR approaches are published for the airport, enter the following: “Chart Note: ASR” or “Chart Note: ASR/PAR,” whichever is applicable.

(2) Where use of Radar is the only acceptable method for procedure entry from the en route environment, enter the following: “Chart equipment required note: Radar Required For Procedure Entry.” See paragraph 8-6-8, for additional equipment that may be used in addition to, or in-lieu-of Radar.

**Note:** Paragraph 8-6-9.g(2) does not apply to GLS, RNAV (GPS), and RNAV (RNP) procedures. This paragraph also does not apply to ILS and/or LOC procedures where RNAV is used for procedure entry.

**h.** Approach light plane penetrations. Do *not* publish notes advising of approach light plane penetrations. When there are penetrations of the approach light plane, the responsible Air Traffic Service Area and regional airports division must jointly take action to either remove the obstacle or modify the system to accommodate the obstacle. If this is not possible, the appropriate Technical Operations office processes an installation waiver. Existing notes referring to approach

light penetrations must be removed from the approach procedure when an appropriate waiver has been approved.

i. The use of notes to prohibit a final approach from a holding pattern has been *discontinued* [see paragraph 8-6-6.g(3)].

j. When the “Fly Visual” from MAP to landing area provisions of Order 8260.3, chapter 3, have been applied, annotate the chart as stated in the Flight Procedure Implementation and Oversight Branch’s approval documentation.

k. DME frequencies are paired with the frequencies of the VOR or localizer. When a non-paired DME is used in a VOR, LOC, etc., procedure, simultaneous reception of both facilities must be assured. This requires a note indicating the DME location and the identification of both facilities: “Chart note: DME from XYZ VORTAC. Simultaneous reception of I-ABC and XYZ DME required.” DME frequencies are not paired with NDBs; and DME antennas may or may not be collocated with the NDB. For NDB SIAPs, use “Chart note: Simultaneous reception of ABC NDB and XYZ DME required.” See paragraphs 8-2-6.c, and 8-6-11.n(1)(a)1.

l. Copter procedures require notes relating to missed approach instructions, as well as airspeed limitations on certain segments.

(1) For PinS “Proceed VFR” approach procedures, use: “Chart planview note: Proceed VFR from (MAP) or conduct the specified missed approach.”

(2) For PinS “Proceed Visually” approach procedures, use: “Chart planview note: Proceed visually from (MAP) or conduct the specified missed approach.”

(3) Use the following note for feeder (when applicable), initial, and intermediate approach segment speed restrictions: “Chart planview note: Limit feeder, initial, and intermediate approach to XX KIAS.” See paragraph 8-6-9.l(4), Note 2.

(4) Use the following note for final and missed approach segment speed restrictions: “Chart planview note: Limit final and missed approach to XX KIAS.”

**Note 1:** For procedures designed to support USA/USAF/USN/USCG operations, the note should read: “Limit all segments to 90 KIAS.”

**Note 2:** These speeds are left to the discretion of the procedure developer based on the predominant helicopter model that will use this procedure and/or as limited by the criteria standards used for procedure development.

(5) Holding airspeed is also restricted for containment based on the unique wind affect when holding at slow airspeeds. This requires the airspeed to be increased upon reaching the missed approach altitude. When the chart note in paragraph 8-6-9.l(4) is applied and missed approach holding has been established, use the following note: “Chart planview note: Increase to 90 KIAS (or greater) upon reaching the missed approach altitude; Maintain 90 KIAS (or greater) while in holding.

**m.** VGSI and IAP glidepath angles/vertical descent angles should be coincidental (angles within 0.20 degrees and TCH values within three feet). See Order 8260.3, section 2-6, for conditions that require approval from the Flight Procedure Implementation and Oversight Branch. Whenever a published glidepath/ descent angle or TCH is not coincidental with the VGSI angle for a runway, use the applicable note below.

(1) Where precision/APV approach (ILS, or RNAV) glidepath angles and/or TCH values are not coincidental with published VGSI values, use “Chart profile note: VGSI and (ILS/RNAV as appropriate) glidepath not coincidental (VGSI Angle {angle}/TCH {feet}).”

(2) Where nonprecision vertical descent angles (VDAs) and/or TCH values are not coincidental with published VGSI values, use “Chart profile note: VGSI and descent angles not coincidental (VGSI Angle {angle}/TCH {feet}).”

**Note:** Do not enter the VGSI angle/TCH numerical values; this information will be obtained by chart producers from the applicable source.

**n.** Where DME/DME RNP-0.3 is not authorized, use “Chart Note: DME/DME RNP-0.3 NA.” Where DME/DME RNP-0.3 is authorized, use “Chart note: DME/DME RNP-0.3 Authorized.” Where DME/DME RNP-0.3 is authorized only when required facilities are necessary for proper navigation solution, use “Chart note: DME/DME RNP-0.3 Authorized; ABC and XYZ must be Operational.”

**o.** LDA instrument procedures with a glide slope must be identified as such with note in the planview, use “Chart planview note: LDA/GLIDE SLOPE.”

**p.** Instrument approach procedures with “PRM” in the title (e.g., ILS PRM RWY 12R, LDA PRM RWY 22L, RNAV (GPS) PRM RWY 18R, etc.). The procedure must have an accompanying “Attention All Users Page (AAUP)” [see section 8-9] and must contain an instructional note that reads as follows:

“Chart note: SIMULTANEOUS APPROACH AUTHORIZED. USE OF FD OR AP REQUIRED DURING SIMULTANEOUS OPERATIONS. DUAL VHF COMM REQUIRED. SEE ADDITIONAL REQUIREMENTS ON AAUP.”

**q.** Simultaneous Offset Instrument Approach (SOIA) procedures with “PRM” in the title (e.g., ILS PRM RWY 12R, LDA PRM RWY 22L, RNAV (GPS) RWY 28R, etc.) the following applies in addition to what is required in paragraph 8-6-9.p:

- (1) Do not include non-vertically guided procedure minimums on SOIA procedures.
- (2) Specify the distance between centerlines of the adjacent runway, use the following:

“Chart note: RWY (number) and (number) separated by (number) feet centerline to centerline.”

(3) Specify “Radar and DME Required” on LDA PRM approach plate: “Chart note: Radar and DME Required.”

(4) For the offset course procedures, aircraft database coding of SOIA RNAV, GLS, and LDA approach procedures are different than other RNAV, GLS, and LDA approach coding. The charted MAP and the database coded MAP (FTP) are not collocated. The charted approach must identify the MAP as determined by the SOIA design tool. The approach coding must identify the FTP as the MAP, so that vertical guidance is available to the runway threshold. Notes on the charted approach plate and on the AAUP must describe the procedures to be followed based on this database coding necessity.

(5) When the offset course procedure has been evaluated for a go-around that could be executed after passing DA and it would require a climb gradient that is greater than 200 ft per NM, a minimum climb gradient must be published as a chart note. Use “Chart Note: If go-around executed after passing (fix name), go-around requires minimum climb of XXX feet per NM to (altitude).”

**r. Helicopter RNAV approach procedures.**

(1) For documentation purposes, consider Copter GPS approaches to be grouped into three categories:

(a) Approach to a runway. COPTER RNAV (GPS) RWY XX approach procedure, not associated with a heliport.

(b) Approach to a heliport. COPTER RNAV (GPS) XXX approach procedures that are either straight-in to a heliport, or constructed using PinS criteria or noted “Chart Planview Note: PROCEED VISUALLY...;” i.e., visual segment evaluated from MAP to heliport.

(c) Approach to a PinS. COPTER RNAV (GPS) XXX approach procedures constructed using PinS criteria and noted “Chart Planview Note: PROCEED VFR...;” i.e., visual segment evaluated only at the MAP.

(2) When the procedure has been evaluated to permit both “PROCEED VISUALLY” and “PROCEED VFR” operations, “Proceed Visually” will be published on the chart and the option to use “Proceed VFR” may be implemented via NOTAM. Document this information in the following format:

“Proceed VFR” area evaluated and may be initiated by NOTAM when required.

(3) Document one destination airport or heliport on Form 8260-3/5/7A for approaches to a runway, and approaches to a heliport, or a PinS approach to a heliport noted “PROCEED VISUALLY.” PinS approach procedures noted “PROCEED VFR” may serve more than one destination.

(4) The visual segment is based on the premise that the pilot will maintain level flight at the MDA until the helicopter is in a position to initiate a descent to the heliport. When obstacles preclude an immediate descent at the MAP to the final approach and takeoff area (FATO) area and an ATD fix has been established to provide a descent point to the FATO, use the following: “Chart profile note: Maintain (MDA altitude) until (distance) NM past (MAP Fix Name).”

s. Baro-VNAV critical temperatures. For RNAV (GPS) procedures, use “Chart note: For uncompensated Baro-VNAV systems, LNAV/VNAV NA below \_\_\_\_°C or above \_\_\_\_°.” For RNAV (RNP) procedures, use “Chart note: For uncompensated Baro-VNAV systems, Procedure NA below \_\_\_\_°C or above \_\_\_\_°C.” See paragraph 8-7-1.c(10) for Form 8260-9 documentation requirements.

t. Radar notes (Form 8260-4). These notes will not be charted except where annotated with “Chart Note” specified prior to the note:

(1) Establish a FAF, minimum altitude (glidepath intercept altitude for PAR), and final approach course for each runway for which radar procedures are established. Runway designation may be omitted if only one runway has a radar approach.

(2) For ASR, provide recommended altitudes for each mile on final, but not below the lowest MDA.

**Example Form 8260-4 entry:**

“RWY 17: FAF 7.8 NM from threshold (at LACKI OM), minimum altitude 9000; minimum altitude 3 NM fix 7300; final approach course 168. Recommended altitude: 7 NM 8720; 6 NM 8360; 5 NM 8000; 4 NM 7660; 3 NM 7300; 2 NM 6920.”

(3) When segments prior to the FAF are required, establish the fixes and minimum altitudes in a note preceding the note cited above: “9.4 NM from threshold, minimum altitude 9000.”

(4) Define the final approach course in the “Notes” section when circling is the only minimum authorized: “FAF 6 NM from runway intersection, minimum altitude 8000; final approach course 060 aligned to intersection of Runways 2 and 15.”

(5) If radar availability is limited, use standard note: “Chart Note: When control tower closed, ASR NA.” (This is a radar SIAP note only - not to be used on other SIAP types.)

(6) Lost communications instructions must be entered as follows: “As directed by ATC on initial contact.”

**u. Limitations notes required on the use of Special procedures.**

(1) Where a special procedure requires the use of private facilities, e.g., landing area or navigational facility, the following statement must be added to the Form 8260-7A restricting the use of that procedure; use: “Chart Note: Use of [name of private facility] requires permission of the owner; use of this procedure requires specific authorization by FAA Flight Standards.”

(2) Where there are no private aspects to a special instrument procedure, the following statement must be to the Form 8260-7A restricting the use of that procedure; use: “Chart Note: Use of this procedure requires specific authorization by FAA Flight Standards.”

**8-6-10. Additional flight data.** When additional information or data is essential to clarify the charting of a procedure or when the procedures specialist wants information charted, but does

not want it to appear on the chart as a note, the necessary information/data must be entered in the “Additional Flight Data” section. Preface specific items to be charted with the term “Chart.” Specific instructions to chart data must be held to a minimum [see also paragraphs 8-2-4.b and 8-6-6.g].

**Note:** Do *not* document takeoff obstacles on the Form 8260-9 or in “Additional Flight Data.”

**a.** Items such as holding information, restricted area data, final approach course alignment, primary remote automated altimeter setting source, etc., must be retained when amending a procedure.

**b.** Enter holding Instructions as follows:

(1) When primary missed approach instructions provide for holding, enter additional flight data as follows: “Hold SE, RT, 313.09 inbound” [see paragraph 8-6-6.g].

(2) Where alternate missed approach holding is established, enter the description as described in paragraph 8-6-6.h(2).

(3) Where arrival holding is operationally advantageous, enter: “Chart arrival holding at PUGGY: Hold SE, RT, 313.09 inbound, 4000.”

**c.** The nonprecision controlling obstacle in the primary and/or secondary area of the FAS must be shown as the FAS Obstacle. In the event a stepdown fix is used in the final approach segment, the controlling obstacle between the stepdown fix and the runway must be shown as the FAS obstacle. If there is more than one FAS obstacle (e.g., LNAV and LP) list both. Enter the obstacle description, elevation in Mean Sea Level (MSL), and location to the nearest second. For a single FAS obstacle or two that are the same, list the obstacle(s) as: “Chart FAS Obst: 317 Tower 364227N/ 0891523W.” For multiple FAS obstacles, list the obstacles as: “Chart FAS Obst: 317 Tower 364227N/ 0891523W, 143 Trees 364210N/0891501W.”

**Note:** When the FAS Obstacle is an AAO, do not chart it. Enter the data as follows: “FAS Obst: 529 AAO 365029N/0871234W.”

**d.** To identify certain significant obstacles, other than AAOs, in or near the instrument approach area, include locations and MSL heights under additional flight data. If, in the opinion of the procedures specialist, these obstacles could be critical to flight safety, they should be prefaced by the word “Chart.” However, if the data is being furnished only as information, it must *not* be prefaced by the word “Chart.” Charting agencies will chart any item marked “Chart.” Any item listed without indicating “Chart” will be reviewed by the charting agencies and will be charted if it meets their charting specifications. List obstacles as follows:

“Chart 2674 antenna 372219N/0941657W” or “2674 antenna 372219N/0941657W.”

**e.** Obstacles close to a final approach or stepdown fix considered under Order 8260.3 chapter 2 must be accomplished as follows:

(1) When chapter 2 is applied to multiple obstacles, document only highest obstacle in the 7:1 (3.5:1 for helicopter procedures) area.

(2) List the obstacle under “Additional Flight Data” as: “Chart 374 antenna 352416N/0881253W.” Do not chart if the obstacle is an AAO; document as noted in paragraph 8-6-10.c note. Additionally, make the following entry in the “Remarks” section of the Form 8260-9: “Order 8260.3 chapter 2 applied to 374 antenna 352416N/0881253W.”

**f.** Installed visual aids will be shown on the aerodrome sketch. NASR is the source for this information, which will be obtained and maintained by Aeronautical Information Services for TPP airport sketch charting purposes. Changes are published in the NFDD.

**g.** Final approach course alignment, when required, is specified in “Additional Flight Data” as follows:

(1) For offset (ILS, LOC, LDA, LDA w/GS, RNP, LPV, LNAV, and LNAV/VNAV) approaches document the amount of offset of the final approach course relative to the runway centerline extended as follows:

“Chart Planview Note: LOC offset X.XX degrees” or “Chart Planview Note: Final Approach Course offset X.XX degrees.”

(a) For conventional procedures, compute the amount of offset to the nearest hundredth of a degree (0.01) by measuring the difference between the true bearing of the FAC and the landing runway true bearing. True bearing values are as recorded in the “Facility Data Record.”

(b) For RNAV (GPS) or RNP procedures, compute the amount of offset as specified in Order 8260.58, chapter 1.

(2) To assist charting agencies in the final approach depiction, for approach procedures not aligned on the runway centerline (+/-0.03 degrees), document the final approach course alignment relative to the runway centerline as follows:

“FAC crosses RWY C/L extended 3180 feet from THLD”; or “FAC 450 feet L of RWY C/L extended 3000 feet from THLD.” (Left or right as used in the latter case is as viewed by the pilot.)

(3) For circling approaches, document the final approach course alignment relative to the on-airport facility, or to the airport reference point. If the facility is off-airport, enter the point where the FAC crosses the landing surface as follows:

“FAC crosses intersection of RWYs 9-27 and 18-36” or “FAC crosses midpoint of RWY 13-31.”

**h.** When a flight check value is used for the final approach course instead of the plotted radial/course/bearing, add the following: “FAC is a flight check value” [see also paragraph 8-6-7.c(1)(c)].

**i.** When a procedure planview area encompasses Special Use Airspace (SUA), use the following note as deemed necessary: “Chart P-56.”

**j.** RNAV data. Publish the following data for RNAV procedures:

(1) For RNAV (VOR/DME), enter the reference facility elevation; e.g., “Reference facility elevation XYZ VORTAC 1160.”

(2) For LPV and LP, enter the WAAS channel number, and reference path identifier (approach ID) using the following example.

WAAS CHANNEL #43210  
REFERENCE PATH ID: W17A

(3) For LNAV/VNAV. Enter “Chart WAAS Symbol” when it has been determined that a WAAS signal may be unreliable for vertical navigation use.

(4) For WAAS/GBAS procedures, document the height above ellipsoid (HAE) and the reference datum used in calculations [see paragraph 2-11-6.b].

(5) For GBAS procedures, enter the GBAS channel number, and reference path identifier (approach ID) using the following example [see paragraph 4-6-10].

GBAS CHANNEL #20662  
REFERENCE PATH ID: GSTU

**k.** ASR and/or PAR approach availability. When ASR and/or PAR approaches are published for the airport, enter the following: “Chart: ASR” or “Chart: ASR/PAR” – as appropriate.

**l.** For Copter PinS procedures:

(1) List the heliport name, facility identifier, landing area elevation, the courses in hundredths of a degree from MAP to heliport, and the distance in hundredths of a NM from MAP to heliport as follows:

ST MARYS HOSPITAL, MN33, 860, 193.00/0.86

(2) For procedures noted to “Proceed VFR” that serve more than one landing area, list each landing area as follows:

East 34<sup>th</sup> Street Heliport, 6N5, 10, 257.02/13.81  
Port Authority-Downtown-Manhattan Wall Street Heliport, JRB, 7, 246.03/15.51

**m.** For Copter PinS procedures that have obstacle penetrations identified in the VFR transition area surface evaluation, those obstacle penetrations that exist outside the OCS-1 and OCS-2 areas, but are within the OIS area [see Order 8260.42, chapter 5], these obstacles must be annotated on the chart; e.g., “Chart 2674 antenna 372219N/0941657W.”



n. Where a VDP is established on a SIAP, identify the location of the VDP as follows:

(1) Non-RNAV: Specify the VDP DME fix and distance to threshold.

Chart VDP at \_\_\_\_\_ DME;  
Distance VDP to THLD \_\_\_\_\_ NM.

**Note:** If the VDP is for a localizer procedure on an “ILS or LOC” approach plate, indicate the VDP as applicable to LOC Only.

Chart VDP at \_\_\_\_\_ DME\*;  
Distance VDP to THLD \_\_\_\_\_ NM.  
\*LOC only

(2) RNAV and LNAV: Indicate the VDP distance to MAP.

Chart VDP at \_\_\_\_\_ NM to RW16.  
Chart VDP at \_\_\_\_\_ NM to SUSIE.

(3) RNAV/VNAV: Indicate the VDP as applicable to LNAV only.

Chart VDP at \_\_\_\_\_ NM to RW16\*  
\* LNAV only.

o. Enter charting instructions for maximum, mandatory or block altitudes; e.g., “Chart mandatory 5000 at DAVID,” or “Chart at or below 14000 and at or above 12000 at CATTTS.”

**Note 1:** Maximum or mandatory altitudes should be avoided where possible, especially in the final approach segment. Maximum, mandatory, or block altitudes in the intermediate, final and/or missed approach segment requires Flight Standards approval from the Flight Procedure Implementation and Oversight Branch, prior to forwarding for publication.

**Note 2:** Until such time formal obstacle clearance criteria has been established to address maximum, mandatory, or block altitudes, a waiver will also be required when applying this to the missed approach segment.

p. Vertical descent angle (VDA)/TCH.

(1) For straight-in aligned nonprecision SIAPs (except for procedures that already have a GS/GP angle established for the vertically guided procedure on the same chart and surveillance (ASR) approach procedures), enter the descent angle for the appropriate fix in the final approach segment, and the appropriate TCH: NIXON to RW15: 3.26/55. Where straight-in minimums are not authorized due to an excessive descent angle, enter the straight-in descent angle (may exceed maximum when compliant with circling descent angle). Where the VDA values are not coincident with published VGSI values, see paragraph 8-6-9.m. Only one angle and TCH will be published on the chart. When a flight inspection/validation has determined that a VDA/TCH must not be specified on the chart, a chart note must be placed in the profile view of the chart; use “Chart profile note: Visual Segment – Obstacles.”

(2) For Copter PinS procedures, except those annotated “proceed VFR...” enter the visual segment descent angle (VSDA) (to the hundredth of a degree) from the specified descent point (MAP or ATD after MAP) to a specified hover height (20-foot maximum) which is known and documented as a heliport crossing height (HCH). Data entry format:

(MAP Name) TO HELIPORT: 7.30/5 feet HCH or 0.2 NM after (MAP Name) TO HELIPORT: 7.50/20 feet HCH.

**Note:** Except for Copter procedures to runways, do not publish vertical descent angle data from FAF to MAP.

**q.** Computer navigation fixes (CNF). Enter charting instructions for CNFs; e.g., “Chart (CFABC) at (location).”

**r.** Arc IAFs. Enter the radial that defines the beginning of the arc initial segment; e.g., “Chart ABC R-060 at WERNR.”

**s.** DME facility. When a DME is used and is not associated with the facility providing final course guidance and station passage occurs within the final segment, the facility must be shown in the profile view; e.g., “Chart in profile view: I-XYZ DME antenna” or “Chart in profile view: ABC VOR/DME.”

**t.** Circling icon. Document that the Circling icon must be charted when Order 8260.3, new circling criteria has been applied as follows: “Chart Circling icon.” See paragraph 8-7-1.d(12) for Form 8260-9 documentation.

**u.** Secondary airports. When there is another airport(s) in the vicinity of the final approach course that may be confused with the airport to which the approach is designed, request the airport be depicted in the plan and profile views of the procedure chart; e.g., “Chart (airport four-letter ID) in plan and profile views.”

**v.** Non-FAA service provider instrument procedures. Document “Non-FAA Procedure” when a 14 CFR part 97 procedure is developed by a non-FAA service provider.

**w.** Radar procedures.

(1) Enter the TDZE in the preprinted area for each runway authorized straight-in minimums.

(2) Enter the GS angle, TCH, and distance from RWT to RPI in feet for PAR approach procedures.

### **8-6-11. Minimums.**

**a.** Takeoff. Takeoff minimums will be documented on Form 8260-15A in accordance with Order 8260.46.

**b.** Alternate. See Order 8260.3, chapter 3. Additionally:

(1) Chapter 2 of this order defines facility monitoring categories (1, 2, 3, and 4) and utilization of these categories. Alternate minimums must not be denied on precision SIAPs if the OM or authorized substitute does not have a remote status indicator. This is because the ILS is monitored, and the GS/GP provides intercept and descent guidance. However, this does not apply to nonprecision SIAPs or the LOC portion of an ILS SIAP; i.e., deny alternate minimums on a nonprecision SIAP if the facility is not monitored.

(2) Enter alternate minimums in the space provided.

(3) Alternate minimums *are* authorized on RNAV (GPS) and RNAV (RNP) SIAPs. However, procedures that only contain LPV minimums cannot be used for determining an Alternate; therefore, an “X” must be placed in the “NA” box.

(4) When alternate minimums are standard, enter the word “Standard”; when not authorized, place an “X” in the “NA” box. When part-time, or higher than standard for some categories, enter “Standard” and annotate the appropriate condition by separate standard note: “NA WHEN CONTROL TOWER CLOSED; CAT D 1000-3; NA WHEN LOCAL WEATHER NOT AVAILABLE” [When applying paragraph 8-6-9.f(4)].

(5) When alternate minimums are non-standard; e.g., higher than standard for each category available for certain users, etc., do *not* place an X in the NA box. Enter the appropriate condition by separate standard note: “NA EXCEPT STANDARD FOR OPERATORS WITH APPROVED WEATHER REPORTING SERVICE; CAT A, B 900-2, CAT C 900-2 1/2, CAT D 1000-3.”

(6) Make separate entries for the complete ILS and for the LOC on the Form 8260-3;. Use standard note: “ILS: CAT A, B, C 800-2, CAT D 800-2 ½; LOC: CAT D 800-2 ½.”

**c.** Minimums boxes. Enter straight-in minimums starting with the lowest HAT as the first (top) line of minima followed by the next lowest HAT as the second line of minima and so forth in sequential order followed by circling minimums. A maximum of six lines (maximum five lines where dual minimums are published) of any combination of authorized minima may be published on a single chart. Enter “NA” in the applicable box(s) when a specific aircraft category(s) is not authorized, except as noted in paragraph 8-6-11.h. Make no entry in the minima blocks when minimums are not authorized for *all* aircraft categories. Do *not* deny or cancel straight-in minimums in order to circumvent grant agreements that have been established under airport development programs. If criteria do not permit straight-in minimums, publish circling minimums only.

**d.** When a 10 NM procedure turn (or greater) is established, CAT A, B, C and D minimums may be authorized.

**e.** When a procedure turn less than 10 NM is established, only CAT A minimums are authorized; enter NA in the VIS column for CAT B, C, and D aircraft. For Copter procedures, delete the letter “A” and insert the word “Copter,” and leave B, C, and D blank.

**f.** When specific minimums are not authorized, enter NA in the VIS column for the appropriate category.

**g.** See Order 8260.3, chapter 3, for guidance to use when determining what categories to evaluate for and chart.

**h.** Make no entry in the CAT E boxes, except where a valid requirement exists.

**i.** Final Type. Enter the types of minimums on Forms 8260-3/4/5/7A as follows:

(1) For non-RNAV instrument procedures, enter “S- (Runway No.) for VOR and NDB procedures straight-in to a runway. For other straight-in procedures, enter as “S- (ILS; LOC; LDA; LDA/GS; as applicable) (Runway No.)”, “Circling” for circling minimums, and “Sidestep (Runway No.)” for sidestep minimums.

(2) For Copter procedures, enter “H- (Runway No.) for VOR and NDB procedures straight-in to a runway. For other Copter procedures straight-in to a runway,” enter “H-(ILS; LOC; LDA; LDA/GS; as applicable) (Runway No.)” For all other Copter procedures, enter “H- (numerical identification of the final approach course).” For COPTER RNAV (GPS) procedures, apply paragraph 8-6-11.i(3).

(3) For RNAV (GPS) procedures, document minimums for LPV, LP, LNAV/VNAV, and LNAV and Circling, as applicable. LP must never be published on the same chart as LPV or LNAV/VNAV. Insert the term “DA” after the labels LPV and LNAV/VNAV. Insert the term “MDA” after the labels LP, and LNAV. “Circling” for circling minimums, and “Sidestep (Runway No.)” for sidestep minimums.

**Note:** When “LPV DA” or “LP MDA” has been entered, the “FAS Data Block Information” portion will appear at the end of the form.

(4) For RNAV (RNP) procedures, use the minima blocks normally reserved for dual minimums and enter “Authorization Required” in the title line. Establish minimums for RNP 0.30 as specified in Order 8260.58, chapter 4. A maximum of four lines of minima may be established. The lowest DA will be the top (first) line of minima followed by the next lowest DA (second line) and so on, in sequential order. There could be cases where an RNP value appears out of sequence; e.g., “RNP 0.15 DA” (first line; climb gradient allows for lower DA), “RNP 0.30 DA” (second line; lesser climb gradient), “RNP 0.15 DA” (third line; lesser climb gradient), and “RNP 0.30 DA” (fourth line, no climb gradient). Nonprecision (e.g., circling and sidestep minimums) are not published on RNAV (RNP) procedures.

**Note 1:** There may be situations where an RNP 0.3 cannot be achieved due to Special Use Airspace/terrain constraints and only a lesser value can be published. This is permitted along with the reason this was necessary to document in the “Remarks” section of the Form 8260-9.

**Note 2:** Only the largest RNP value will be coded into the database.

(5) For GLS procedures, establish only one line of minimums. Insert the term “DA” after GLS.

(6) For radar procedures, specify the runway numbers. PAR w/out glidepath (GP) minimums may be established where necessary.

**j.** DA/MDA. Enter the DA or MDA authorized by criteria as an MSL value in each of the appropriate DA/MDA boxes by category of aircraft.

**k.** VIS. Enter the visibilities authorized by Order 8260.3, chapter 3. RVR authorized on runways to which straight-in minimums are published must be entered in feet; e.g., 4000; 2400; 1800, etc. Procedures located in a foreign country where Meters is the value used for visibility, enter an “m” following the number; e.g., 1200m; 800m; 550m; etc.

(1) See Order 8400.13. When it has been determined that a procedure qualifies for 1800 RVR under the guidelines in this order, place in the “Notes” section of the 8260-series form: “Chart Note: RVR 1800 authorized with use of FD or AP or HUD to DA.” This chart note must be referenced to the straight in minima it applies to. If the note applies to the entire line of minima, the attention symbol must be placed following the minima type (i.e., S-ILS 19L\*). If the note applies only to certain aircraft categories, the attention symbol must be associated with the numerical DH/MDA value (i.e., 502\*) for those categories.

(2) See paragraph 4-1-5 of this order for guidance on using RVR on adjacent runways.

(3) A note is required to prevent helicopters from reducing straight-in CAT A visibility for procedures other than “copter-only” when the straight-in or offset (as appropriate) visual area is penetrated. For 20:1 penetrations, specify the runway to which the FAC is aligned to and use: “Chart Note: Rwy XX helicopter visibility reduction below 1 SM (or RVR 5000 as appropriate) not authorized.” If only the 34:1 surface is penetrated, then specify the runway to which the FAC is aligned to and use Chart Note: Rwy XX helicopter visibility reduction below 3/4 SM (or RVR 4000 as appropriate) not authorized.” Do not apply this note to RNAV (RNP) “Authorization Required” approach procedures.

#### **I.** HAT/HAA.

(1) HAT. Enter height above touchdown zone elevation (TDZE) when straight-in minimums to a runway (including Copter) are authorized. For Copter straight-in and point-in-space (PinS) SIAPs noted to “proceed visually” to the landing site, enter “HAL.” For Copter PinS IAPs noted to “proceed VFR” to the landing site, enter “HAS” [see paragraphs 8-6-2 and 8-6-10.m]. When evaluating foreign terminal instrument procedures and the threshold elevation is not available, use airport elevation.

**Note:** Helicopter procedures to elevated heliports (e.g., heliport on the roof of a hospital) and point-in-space (proceed VFR) procedures pose unique circumstances when calculating weather minimums. Consideration must be given to the elevation of the source providing the ceiling information. For example, if the weather source providing the ceiling information is considerably lower than the heliport on top of the building, a much higher ceiling value must be established when the HAL value is provided.

(2) HAA. Enter height above airport elevation for circling minimums.

**m.** ILS CAT II/III or Special Authorization CAT I/II ILS. When applicable, enter CAT II/III or SA CAT I/II ILS minimums in the “Notes” section immediately below the minimums boxes. SA CAT I is an option at runways with standard CAT II or III, at runways with SA CAT II, or at

CAT I runways. Establish only one set of either SA CAT II minimums or (standard) CAT II minimums in the 100-foot to 199-foot range with the applicable radio altimeter (RA) and RVR established by TERPS criteria (i.e., SA CAT II must not be published if there is a standard CAT II or III). CAT II RVR may be reduced to as low as 1000 where authorized by Flight Standards per Order 8400.13 and documented in the “Notes” section. At locations where ILS CAT II procedures have been established, a separate Copter ILS CAT II procedure may be developed that contains a HAT less than 200 feet but no lower than 100 feet above touchdown zone elevation. These Copter ILS CAT II procedures are separate and use the standard Copter (CAT I) ILS naming convention, are documented on a separate Form 8260-3, and may contain localizer minimums on the same chart. A RA height must also be provided for publication with the DA. For copter procedures, the DA and HAT will be entered in the minima boxes and the RA will be entered in the “Notes” section adjacent to the CAT II note. Enter these items as follows:

(1) For SA CAT I: SA CAT I ILS - Special Aircrew and Aircraft Certification Required; S-ILS 32L: CAT A, B, C, D, RA 154, RVR 1400, HAT 150, DA 806 MSL.”

**Note:** A SA CAT I with a HAT not lower than 150 feet may be developed under Order 8400.13. The following entry must be made in the “Notes” section for publication on the approach chart:

“SA CAT I Chart Note: Requires specific OPSPEC, MSPEC, or LOA Approval and use of HUD to DH.”

(2) For SA CAT II: “SA CAT II ILS - Special Aircrew and Aircraft Certification Required; S-ILS 32L: CAT A, B, C, D, RA 104, RVR 1200, HAT 100, DA 756 MSL” or “SA CAT II ILS - Special Aircrew and Aircraft Certification Required; S-ILS 32L: CAT A, B, RA 104, RVR 1200, HAT 100, DA 756 MSL; CAT C, D, RA 124, RVR 1400, HAT 120, DA 776 MSL.”

**Note:** The SA CAT II procedure is developed under Order 8400.13, at a location that is lacking ALSF and/or TDZ/CL lighting systems and/or other limiting requirements, and the following entry must be made in the “Notes” section for publication on the approach chart:

“SA CAT II Chart Note: Reduced Lighting: Requires specific OPSPEC, MSPEC, or LOA Approval and use of Autoland or HUD to touchdown.”

(3) “CAT II ILS - Special Aircrew and Aircraft Certification Required; S-ILS 32L: CAT A, B, C, D, RA 104, RVR 1200, HAT 100, DA 756 MSL” or “CAT II ILS - Special Aircrew and Aircraft Certification Required; S-ILS 32L: CAT A, B, RA 104, RVR 1200, HAT 100, DA 756 MSL; CAT C, D, RA 124, RVR 1400, HAT 120, DA 776 MSL.”

**Note:** CAT II procedures to a minimum of 1000 RVR using autoland or HUD to touchdown may be authorized under Order 8400.13. The following entry must be made in the “Notes” section for publication on the approach chart:

“CAT II RVR 1000 Chart Note: RVR 1000 authorized with specific OPSPEC, MSPEC, or LOA approval and use of autoland or HUD to touchdown.”

(4) “Copter ILS CAT II - Special Aircrew and Aircraft Certification Required; RA 104.”

(5) “CAT III ILS - Special Aircrew and Aircraft Certification Required; S-ILS 32L: CAT III CAT A, B, C, D, RVR.” (Insert RVR value from CAT II/III checklist; see paragraph 4-3-2.a.)

(6) If the ATCT does not provide continuous service, publish a note on the chart indicating the applicable procedure is not authorized when the control tower is closed; for example, use: “CAT II/III Chart note: Procedure NA when tower closed.”

(7) When informed that the CAT III procedure facility is identified as having class III/D/3 performance, a chart note is required to inform the pilot that the localizer cannot be used for rollout guidance. Use “Chart note: Localizer not suitable for Electronic Rollout Guidance.”

**n.** Dual minimums. Enter dual minimums, when authorized. Do not publish dual minimums unless a 60-foot operational advantage is obtained or a reduction in visibility can be achieved. To avoid proliferation of dual minimums, all IFR aircraft are assumed to have at least one VOR receiver. Dual minimums based on a stepdown fix combined with local and remote altimeter settings could result in four sets of minimums. When two remote sources are used, treat the source resulting in lower minimums as the “Local” altimeter setting source in the following paragraphs. Document only two sets of minimums. The combinations authorized are minimums with and without a stepdown fix; or minimums with local and remote altimeter settings.

(1) When authorizing minimums with and without a stepdown fix and which also require local and remote altimeter settings enter the minimums with and without the stepdown fix based on the Local altimeter in the two sets of minimums boxes. Address the minimums with and without the stepdown fix based on the Remote altimeter setting source in a note and include the applicable visibility increases. Establish the required visibility as stated in paragraph 4-1-5.

**Note:** Normally an airport with an ILS does not have a remote altimeter setting. But where this does occur, the MDA adjustment might not be suitable for DA adjustment; i.e., the adjustment might be too great, and the visibility adjustments might differ.

(a) Compare visibilities to determine note format:

1. Where precision and nonprecision visibility adjustment is the same, enter the following in the “Notes” section: “Chart note: When local altimeter setting not received, use (location) altimeter setting and increase all DAs/MDAs 60 feet, and all visibilities ½ SM.” Use this note also when visibility is affected in *all* categories; apply the greatest visibility increase.

2. Where precision and nonprecision visibility adjustments differ and visibility is affected in all categories, apply the greatest visibility increase to all categories and define application as follows in the “Notes” section: “Chart note: When local altimeter setting not received, use (location) altimeter setting: increase DA to 287 feet and all visibilities 1/4 SM; increase all MDAs 60 feet and all visibilities ½ SM.”

3. Where precision and nonprecision visibility adjustments differ and visibility is *not* affected in all categories, apply the greatest visibility increase only to those categories which are affected and define application as follows in the “Notes” section: “Chart note: When local altimeter setting not received, use (location) altimeter setting: increase DA to

287 feet and visibility CAT D ¼ SM; increase all MDAs 60 feet and visibility CATs C and D ½ SM.”

**Note:** CAT A is not affected until the HAT is more than 880 feet; CAT B is not affected until the HAT is more than 740 feet.

(2) When dual minimums are appropriate with local and remote altimeter settings, enter the title: “(LOCATION) ALTIMETER SETTING MINIMUMS” over the second set.

(a) When a procedure *does* contain a stepdown fix, but has only local or only remote altimeter setting minimums, enter the straight-in and circling minimums required without the stepdown fix in the first set of boxes. Enter the straight-in and circling minimums required with the stepdown fix in the second set of boxes.

(b) When a procedure does *not* contain a stepdown fix, but has both local and remote altimeter setting minimums, enter the local altimeter setting minimums in the first set of boxes and the remote altimeter setting minimums in the second set of boxes. Use the following note: “Chart note: When local altimeter setting not received, use (location) altimeter setting.”

**Note:** When the situation in paragraph 8-6-11.n(1)(a)1 applies, a note is preferable to a second set of minimums.

(c) When a procedure does *not* contain a stepdown fix, but has two sets of part-time remote altimeter setting minimums, enter the lower minimums in the first set of boxes, and the higher minimums in the second.

(3) Stepdown fixes.

(a) On procedures where the course guidance and stepdown fix are obtained from different VOR facilities, publish two sets of minimums.

(b) On procedures where the course guidance and stepdown fix are obtained from different NDB facilities, publish two sets of minimums.

(c) Where paired DME is used, use the fix name in the title: “NIXON FIX MINIMUMS.”

(d) Where non-paired DME is used, as above, place an attention symbol (\*) next to the title (e.g., NIXON FIX MIMIMUMS\*), and enter the following in Additional Flight Data: “\*DME from XYZ VORTAC.”

(e) On procedures where the course guidance and the stepdown fix are obtained from facilities, which are of different types [except as noted in Order 8260.3], publish two sets of minimums. Use one of the following titles to identify the dual minimums:

1. On procedures where the fix is predicated on DME only: “DME MINIMUMS.”



2. On procedures where a fan marker is used for the stepdown fix: “FM MINIMUMS.”

3. On procedures where the stepdown fix is identified by radar only: “RADAR MINIMUMS.”

**Note:** When radar fixes are specified, ATC must agree to provide the radar service on a continuous basis and the fix must be identified on the video map or map overlay.

(f) On procedures where course guidance and a stepdown fix use the same type of receiver, annotate in the minimums box that dual receivers are required; e.g., “AGNES FIX MINIMUMS (Dual VOR receivers required)” or “AGNES FIX MINIMUMS (Dual VOR receivers or DME required).”

**o.** Landing minimums limitations. Minimums are affected by a number of different circumstances and conditions. Examples are enumerated below indicating the appropriate action to be taken.

(1) Day and night minimums. The authorized minimums apply to both day and night conditions unless otherwise restricted. Aeronautical Information Services must determine the availability of *all* lighting aids *prior* to permitting night minimums. Permanently installed runway edge lights (including threshold/runway end lights), defining the lateral and longitudinal boundaries of the runway, must be operating to support night minimums [see AC 150/5340-30]. Airport or runway boundary lights are *not* adequate for night landing minimums unless the entire area between such lighting is suitable for landing. In special cases, portable runway lights may be used temporarily as described in AC 150/5345-50.

(2) Restriction of night minimums. When night minimums are not authorized or are higher than day minimums, a restriction must be entered in the “Notes” section to deny night minimums or to specify increased night minimums.

(a) If unable to authorize night minimums (e.g., when both straight-in and circling minimums are not authorized at night), use: “Chart note: Procedure NA at night.” See also paragraph 8-6-11.o(14).

(b) If increased night visibility is required by environmental conditions, such as extraneous lighting, use: “Chart note: Night visibility minimum\_\_SM.”

(c) When straight-in minimums are published to an unlighted runway, but another runway is lighted, use: “Chart note: Straight-in minimums NA at night.”

(d) When only circling minimums are published and at least one runway is lighted, a note is not required for non-lighted runways. When no runways are lighted, use: “Chart note: Procedure NA at night.”

(e) At an airport with multiple runways where straight-in minimums are authorized to a lighted runway, but the other runway(s) is/are unlighted, a note is not required for the unlighted runways.

(f) When only circling minimums are published and circling is not authorized at night, use: “Chart note: Procedure NA at night.”

(g) When aircraft are prohibited from circling to a runway at night, use one of the following options: “Chart note: Circling NA at Night” or “Chart note: Circling Rwy X, XX NA at Night.”

(h) When the Flight Procedure Implementation and Oversight Branch has approved use of the VGSI in lieu of obstruction lighting, use the following: “Chart note: Straight-in Rwy XX at Night, operational VGSI required, remain on or above VGSI glidepath until threshold” or “Chart note: When Circling to Rwy X, XX at Night, operational VGSI required, remain on or above VGSI glidepath until threshold.”

**Note:** A combination of paragraphs 8-6-11.o(2)(c) and/or 8-6-11.o(2)(g) and/or 8-6-11.o(2)(h) can be used when applicable and may appear as: “Chart note: Straight-in Rwy XX NA at Night, Circling Rwy X, XX NA at Night, Circling Rwy X, XX at Night, operational VGSI required, remain on or above VGSI glidepath until threshold.”

(3) Inoperative components and visual aids. The inoperative components and visual aids table informs the pilot how much to increase published minimums when certain components or visual aids are known to be inoperative. When the inoperative table adjustment is not compatible with the credit that has been authorized, add notes to the procedure specifying the necessary adjustment. Enter one of the following in the “Notes” section:

(a) When credit has not been given to a visual aid to reduce visibility, use: “Chart note: Inoperative table does not apply to ALS RWY 30.”

(b) In many instances, reference to a particular component or visual aid is not necessary as no portion of the inoperative table is applicable. In this case, use: “Chart note: Inoperative table does not apply.”

(c) When the inoperative table applies only to a few cases, use: “Chart note: Inoperative table does not apply to CAT D;” or “Chart note: Inoperative table does not apply to S-LOC-31 CATs A and B.”

(d) The inoperative table, in certain circumstances, does not provide a sufficient increase to minimums. When this situation occurs, use: “Chart note: For inoperative ALS, increase S-7 CAT D visibility to 1 ¾;” or “Chart note: For inoperative ALS, increase S-LOC-7 CAT D visibility to RVR 5000, and CAT E to RVR 6000.”

(e) Where two sets of minimums are published, specify the applicable minimums affected. For example, on a VOR approach with DME minimums published as the second set, use: “Chart note: VOR Minimums: Inoperative table does not apply to S-30 CATs C and D. DME Minimums: For inoperative ALS, increase S-30 CAT D visibility to 1 ¼ SM.” Where the note applies equally to both sets of minimums, do not specify the minimums.

(f) Where a heliport approach lighting system is installed and credit for lights has been taken, annotate the procedure to indicate the minimum no-light visibility applicable if the ALS become inoperative; e.g., “Chart note: For inoperative ALS, increase visibility to 1 SM.”

## (4) Weather reporting/altimeter setting.

(a) In accordance with Order 8260.3, an altimeter setting (local or remote) is required to authorize landing minimums. Terminal weather observation and reporting facilities (in addition to remote facility status monitoring) must be available for the airport to serve as an alternate airport. Some airports do not have any weather reporting while others provide this service on a part-time basis. A number of airports have the capability to report altimeter settings only on a full-time or part-time basis. Some operators provide approved weather reporting services, full-time or part-time, to their own company aircraft or on a contract basis to others. Evaluate these factors to determine the type of notation that may be required to support landing and/or alternate minimums. Enter these restrictions in the “Notes” section.

**Note:** The phrase “except for operators with approved weather reporting service” is used only when such service is available.

(b) When a remote altimeter setting source is available on a 24-hour basis, use of a remote altimeter setting on a part-time basis will normally coincide with the loss of the local altimeter source; e.g., control tower closed, FSS closed, local weather office closed, etc. In these instances, use: “Chart note: When local altimeter setting not received, except for operators with approved weather reporting service, use Oakland altimeter setting and increase all MDAs 120 feet, and all visibilities  $\frac{1}{2}$  SM.” Use city name unless more than one source is available in the city; then use the airport name; e.g., “Chart note: When local altimeter setting not received, use Miami Int’l altimeter setting...” Where appropriate, define application to DA and/or MDA, or address when visibility is *not* affected in all categories, within the standard note [see paragraphs 8-6-11.n(1)(a)1 and 8-6-11.n(1)(a)2].

(c) State identifiers. Include state identifiers *only* if confusion is possible; i.e., more than one city with the same name in close proximity, e.g., “Chart note: When local altimeter setting not received, use Springfield, MO altimeter setting and increase all MDAs 80 feet, and all visibilities  $\frac{1}{2}$  SM.”

(d) When an altimeter setting is provided at uncontrolled airports, use standard notes described in paragraph 8-6-9.e.

(e) When use of remote altimeter setting cannot be authorized, use: “Chart note: When Valle altimeter setting not received, procedure NA.”

(f) The adjustment for a remote altimeter setting source is cumulative; i.e., it is additional to any inoperative component adjustment, terminal segment MRA adjustment, or altitude increase to ensure communication reception.

(g) When a MDA adjustment is published by note, the adjustment value is the difference between the MDA values based on primary and secondary sources. For example, if the MDA for primary altimeter is 660 and the MDA for secondary altimeter is 720, specify to increase all MDAs by 60 feet (720-660=60).

**Note:** Descent angle/gradient is calculated using values based on primary altimeter only.

(5) Circling conditions and restrictions. Publish one circling MDA (CMDA) for each aircraft category. Where obstructions/terrain would yield excessively high CMDAs or environmental concerns would prohibit over-flight of specified areas, portions of the circling obstruction evaluation area may be eliminated through sectorization if instructions clearly define the areas where circling maneuvering is not allowed. Identify sectors by reference to runway centerlines by entering the applicable restriction in the “Notes” section as follows:

(a) When a 180-degree sector is defined by restricting circling from one side of a runway, use “Chart note: Circling NA E of RWY 17-35.”

(b) When a sector less than 180 degrees is defined by restricting circling between two runways, use “Chart note: Circling NA NW of RWYs 9 and 18.”

(c) When a sector of more than 180 degrees is defined by restricting circling from one side of each of two runways, use: “Chart note: Circling NA E of RWY 18 and SW of RWY 12.”

(d) When Circling minimums are restricted by aircraft category and runway combinations, use: “Chart note: Circling NA for CATs C and D NW of RWY 6-24.”

(e) When Circling to a specific runway is restricted, use: “Chart note: Circling NA to RWYs 18 and 12.”

(6) ILS/GLS restrictions. For GLS approaches, pending further evaluation by the FAA, autoland using GBAS is prohibited; use “Chart note: Autopilot coupled approach NA below (Decision Altitude).” Where flight inspection/validation or Aircraft Certification Services establishes a restriction to the ILS/GLS approach, a NOTAM will be issued, and the restriction will be published in the Chart Supplement. Where the restriction affects landing minimums or the MAP, issue an appropriate NOTAM. Publish a note using the same wording as stated in the flight inspection/validation report; e.g., “Chart profile note: ILS unusable inside DA.” No note is required for an unusable LOC back course, or for a LOC lateral coverage restriction with no terminal route through the restricted area.

(a) If the LOC will not provide adequate course guidance in the area between the MM and runway threshold, use: “Chart profile note: ILS unusable from MM inbound.” Where an MM is not installed, flight inspection/validation authority may provide a NM distance from threshold, or altitude, at which the ILS is not usable.

(b) When the GS will not provide satisfactory vertical guidance, restrict its use above or below a specific altitude. Use: “Chart profile note: GS unusable below/above (altitude).”

(c) When GS indications can be received on a LOC back course approach, use “Chart profile note: Disregard GS indications.”

(d) When the rate of reversal in the GS exceeds the tolerances of Order 8200.1 establish a restriction for autopilot coupled approach 50 feet above the point (MSL) where the out-of-tolerance condition exists. Use: “Chart note: Autopilot coupled approach NA below

(altitude specified by Flight Inspection/validation).” Flight inspection/validation may also determine and request that an autopilot coupled approach not be allowed at all. If that is the case, use: “Chart note: Autopilot coupled approach NA.”

(e) When terrain, obstacles, descent gradient, etc., do not allow the use of a LOC procedure associated with the ILS when the GS is not used, place NA in the visibility column for each LOC category affected. If, in such an instance, another procedure must be used instead, enter the following in the “Notes” section: “Chart planview note: When GS not used, use LOC RWY 26 procedure.”

(f) When informed that a radar altimeter (RA) height is NA for CAT II operations, document “RA NA” for the RA value to be charted [see paragraph 8-6-11.m]. See Order 6750.24 for RVR restrictions.

(7) Simultaneous dependent and independent approach operations. When ATC has determined that certain instrument approach procedures meet the requirements to support either of these operations, the chart must be annotated to indicate that the approach is authorized to be conducted simultaneously with another runway.

(a) When informed by an ATC facility that simultaneous approach operations will be conducted with another runway, the approach chart must be annotated to indicate that simultaneous approach operations are authorized. Enter in the “Notes” section: “Chart Note: Simultaneous Approach Authorized.”

(b) When informed by an ATC facility that simultaneous operations will be conducted using the provisions in Order JO 7110.308, Simultaneous Dependent Approaches to Closely Spaced Parallel Runways, use of vertical guidance is required. In the “Notes” section enter: “Chart note: Simultaneous Approach Authorized. Simultaneous operations require use of vertical guidance; maintain last assigned altitude until established on glideslope (for RNAV procedures use ‘glidepath’).” In unique cases where ATC has determined a runway can be used simultaneously with multiple parallel runways, one of which qualifies for Order JO 7110.308 procedures and the other runway(s) qualify for basic simultaneous operations, in the “Notes” section enter: “Chart note: Simultaneous approach authorized with Rwy (number). Simultaneous approach authorized with ILS Rwy (number) requires use of vertical guidance; maintain last assigned altitude until established on glideslope/glidepath.”

(c) For RNAV (GPS) procedures with LNAV minima published on the same chart with LPV or LNAV/VNAV minima, include the following in the “Notes” section: “Chart note: LNAV procedure NA during simultaneous operations.”

(d) For GLS and RNAV (GPS) procedures used for simultaneous approach operations, enter the following in the “Notes” section: “Chart note: Use of FD or AP required during simultaneous operations.” This chart note may be required on ILS procedures under certain conditions specified in Order 8260.3 and ATO Directives, based on the type of ATC operations being conducted. The ATC facility and/or the applicable OSG will provide this information, when required, to the applicable procedure development specialist.

**Note:** Document the applicable chart notes in paragraphs 8-6-11.o(7)(a) through 8-6-11.o(7)(c) in the order they appear above to ensure they are placed in that sequence on the chart.

(8) Simultaneous converging approach operations. When ATC has determined that simultaneous converging approach operations will be conducted, a note must be placed on the chart to indicate authorization. In the “Notes” section enter: “Chart note: Simultaneous Approach Authorized.”

(9) Radio controlled lights. At many locations, lighting aids are radio controlled by the pilot. The standard keying system to activate the lights is described in AC 150/5340-27. AC 90-42 establishes common traffic advisory frequencies (CTAF) to be used at uncontrolled airports including those with part-time towers. Radio control of airport lighting systems from aircraft should be used only at airports where ATC facilities are not in operation. Existing systems that use frequencies other than the CTAF may continue to be used.

(10) PCL note charting. Pilot control lighting (PCL) is depicted on Aeronautical Information Services SIAP charts by the use of negative symbology. Aeronautical Information Services obtains information for adding the symbology to SIAPs from NFDC’s NFDD. AJV-21 must review each published procedure to ensure that PCL charting is correct.

(11) All Special IAPs at locations that have PCL must have light activation notes documented on Form 8260-7A. Use “Chart note: Activate MALSR RWY 25, MIRL RWY 7-25 (as appropriate) - CTAF” (or designated frequency).

(12) Lights by prior arrangement. When the operation of lights must be arranged for before flight, enter the following in the “Notes” section: “Chart note: Procedure NA at night except by prior arrangement for runway lights.”

(13) Lights on request. When lights are only available by radio contact with an FBO, airport manager, etc. use “Chart note: Request MIRL RWY 7/22, and VASI RWY 22 - CTAF” (or appropriate frequency if other than CTAF).

(14) Night landing minimums must *not* be authorized unless the requirements of AC 150/5340-27 are met. See also paragraphs 8-6-11.o(1) and 8-6-11.o(2). Use: “Chart note: Procedure NA at night.”

**8-6-12. Changes and reasons.** The purpose of these entries is to keep charting agencies and coordinating offices advised of major procedural changes. The listing of changes must include all revisions (except clerical) and the reasons should contain sufficient details so that the cause for the procedural amendment will be clear to the reviewing offices. Also ensure changes made to the FAS Data Block are specified.

**8-6-13. Coordinated with.** In order to avoid conflicts and protect the rights of all airspace users, coordinate all original processing and revisions to public instrument approach and departure procedures with appropriate civil aviation organizations (e.g., Aircraft Owners and Pilots Association and the National Business Aviation Association), affected military and civil ATC facilities, and the airport owner or sponsor.

**Note 1:** Affected military and civil ATC facilities not only include the IFR controlling facility, but also includes those facilities where the instrument procedure enters airport traffic areas at airports with a control tower.

**Note 2:** These paragraphs also apply to all public departure procedures; see Order 8260.46, Departure Procedure (DP) Program, latest edition.

**a.** Coordinate with appropriate FSDO according to the type of operations conducted at the airport. Coordinate with other interested organizations as necessary. A copy of the graphic sketch required by paragraph 8-7-1.e must be included in all procedure packages that are submitted for coordination. Coordinate procedures with Airlines for America (A4A) if the airport is served by scheduled air carriers. Coordinate all 14 CFR part 97 SIAPs and *all* DPs (see Order 8260.46) with the Air Line Pilots Association (ALPA). Coordinate with Allied Pilots Association (APA) for procedures at airports used by American Airlines. Coordinate helicopter procedures with Helicopter Association International (HAI).

**b.** This coordination action is required to provide advance notice to the user organizations that a change to an instrument approach or departure procedure is being initiated. These instrument procedures will be posted on Aeronautical Information Services web site. Civil aviation organizations that are requested to coordinate on these procedures will receive an e-mail alerting them of the procedure posting. Those receiving this notification then have 20 working days in which to review the procedures and respond to the indicated actions during the period that the procedure is being processed. Any substantive adverse user comments during this period permit sufficient time to amend or withdraw the paperwork prior to publication. Evaluation and disposition of user comments are the responsibility of; and all comments must be considered before the procedure is forwarded for publication.

(1) Enter “X” in the appropriate aviation organization spaces.

(2) Designate additional organizations or offices if additional coordination is to be accomplished.

**c.** Coordination conflicts that cannot be resolved with the FAA organization responsible for IFP development will be submitted to the RAPT for resolution prior to submission of the procedure for publication [see also paragraph 4-2-2]. Make every effort to thoroughly evaluate the comments/objections, determine the validity and scope of each issue, and if necessary determine the appropriate course of action to resolve the conflict.

**8-6-14. Submitted by.** Enter the name, signature, company name, and date authorized by the non-governmental entity that designed the procedure. This block is only found on the Form 8260-7A.

**8-6-15. Flight checked by.** Enter the name of the airspace system inspection pilot (ASIP)/validation pilot who conducted the flight inspection/validation and date flight inspection/validation completed. The flight inspection/validation procedures control form must be maintained with the procedure package. The 8260-series forms supporting IFPs require the signature of the flight inspection/validation pilot or other authorized Flight Program Operations/non-FAA service provider designated representative signifying flight

inspection/validation completion. If a flight inspection/validation is *not* required, enter “Flight inspection not required” and the name, title, and signature of the flight Inspection/validation official who makes that determination. Include the date of the most recent flight inspection/validation of the instrument procedure. Use the word “pending” only if the procedure is submitted prior to flight check under Order 8260.26 or if publication is required on a specific charting cycle date. An entry in this block indicates the procedure:

- (1) Was flight checked/validated in accordance with applicable directives and standards.
- (2) Is approved for further processing and publication.

**8-6-16. Developed by.** Enter the name, office symbol, and signature of the person responsible for developing the IFP, and the date developed.

**8-6-17. Recommended by.** This section only appears on Form 8260-7A and must be signed by Aeronautical Information Services/Division Manager or their designated representative. Forward the completed form to the Flight Procedure Implementation and Oversight Branch for final approval. See paragraph 8-6-19 for procedures developed by non-government sources.

**8-6-18. Approved by.**

**a.** Title 14 CFR part 97 instrument procedures. Enter the name and signature of the Aeronautical Information Services manager, or his/her designated representative, and the date signed for instrument procedures developed by the FAA. Non-FAA service providers approved by the FAA have the approval authority for those procedures and must complete this block [see paragraph 8-6-10.v]. Signature in this block certifies that the procedure:

- (1) Was developed in accordance with appropriate policies, directives, standards, and criteria.
- (2) Is approved for further processing.

**b.** Special instrument procedures.

(1) For procedures developed by and quality reviewed by the FAA, the person who developed the procedure signs the original Form 8260-7A in the “Developed by” section.

(2) For procedures developed by non-government sources, the person who developed the procedure signs the original Form 8260-7A in the “Developed by” section. The “Recommended by” section must be signed by the Flight Procedure Implementation and Oversight Branch. Additionally, see guidelines established in Order 8260.60.

**8-6-19. FAS Data Block Information.** When “LPV DA” or “LP MDA” is entered in the “Final Type” portion of the Form, or when “GLS” is selected as a procedure type, the “FAS Data Block Information” portion will appear. Guidance on entering the required information into this portion can be found in appendix K.



## Section 8-7. Standard Instrument Approach Procedure Data Record, FAA Form 8260-9

**8-7-1. Preparation of Form 8260-9.** The Standard Instrument Approach Procedure Data Record, Form 8260-9, must be prepared in accordance with the instructions below for each instrument approach procedure developed by Aeronautical Information Services or non-Federal procedure developers. The form is designed as a supporting document for the approach procedure. It serves as a checklist for the procedures specialist, as a technical reference for the flight inspector, and provides a permanent record of data currently available at the time of procedural development. This form supports instrument approach procedures for both fixed-wing aircraft and helicopters. If the form will be used for helicopter procedures, in the upper left corner of the form, select those items that apply to the procedure. The appropriate header information will then automatically appear where applicable.

**a.** Airport and procedure data. Enter the airport name and location identifier (ICAO, if available). Enter the procedure name and if the procedure is an original, enter "ORIG" or if an amendment, enter "AMDT" with the applicable number. Enter the associated city name and state name derived from AIRNAV. Use the official two letter state abbreviation, followed by the airport elevation as specified in the Report Format Form 8260-3/5/7A. For facility, enter identification and type; for RNAV (VOR/DME) procedures, enter the identification of the SIAP reference facility. For RNAV or FMS procedures, insert RNAV or FMS as applicable.

**b.** Part A: Obstruction data.

(1) Segments. Identify each TAA, feeder, hold-in-lieu of procedure turn, initial, intermediate, and final segment, and stepdown fixes therein. If the segments are associated with an RNP, the RNP values must be included. **Example:** (RNP 0.15), (RNP 1.00), etc. If the IF is also an initial approach fix, identify the IF with "(IF/IAF)" in the "From" column. For precision approaches which have separate intermediate and final segments for the precision and nonprecision approaches, identify all: Intermediate: ILS and Intermediate: LOC; Final: ILS and Final: LOC. Identify the primary missed approach segments (and alternate missed approach segments, when established).

(2) From/To. Enter segment start/end points, including stepdown segments, as listed in the "Terminal Routes" section of Report Format Form 8260-3/5/7A. Enter the PT completion distance in the "From" column opposite the intermediate or final segment, as appropriate. Enter RWXXX (fix name for copter PinS procedures) in the "To" column for the final/stepdown segments. Enter "GP Intcp" (or PFAF name if established) in the "From" column and "RWXXX" in the "To" column for vertically guided procedures (even though the missed approach begins at the DA). Enter the hold-in-lieu-of-PT facility/fix in the "From" column, and the holding template number from the controlling obstacle information of the Form 8260-2 for the hold-in-lieu of PT facility/fix in the "To" column. Enter segmented RNP missed approach, when applicable.

(3) RNP. Enter the RNP value, when applicable.

(4) Distance. Enter the distance as listed in the “Terminal Routes” section of Form 8260-3/5/7A.

(5) PAT. Enter holding template number for the hold-in-lieu of PT facility/fix.

(6) MAP/HAT or HAL/HMAS. When the final segment information is provided, entries will include the missed approach point location, height above touchdown, and the starting elevation of the missed approach surface. When a procedure contains multiple lines of minimums, list each final segment independently with the MAP/DA associated with the lowest minimums first. Enter the HAT or HAL followed by the starting elevation of the missed approach surface(s) (HMAS) for each listed MAP and/or DA (for vertically guided procedures, the height of the FAS OCS at the end of Section 1A, except LNAV/VNAV, which is DA minus height loss).

**Note:** The HMAS value will only appear in the segment entry pertaining to the missed approach.

(7) Obstruction. Select the controlling obstruction as directed by section 2-11. Enter controlling obstruction type (tower, trees, terrain, AAO, etc.) and state obstacle number, if available, within each approach segment on one line. Enter segment (except final) highest terrain data on the next line. Number obstruction entries sequentially as they appear on the form. For obstructions or terrain common to other segments, the number from the “obstruction” column may be entered for each subsequent repetition and the “coordinates” column may be left blank, but remaining column entries.

(8) Coordinates. Enter coordinates in degrees, minutes, and seconds to the hundredth; e.g., 411532.01N/0943028.09W.

(9) Elev. MSL.

(a) Enter the controlling obstacle/terrain MSL elevation.

(b) Enter the highest terrain elevation used for airspace evaluation to the nearest foot, followed in parentheses by that value rounded to the nearest 100 feet; e.g., 249 (200) [see paragraph 5-2-4.b]. Do *not* assign an accuracy code to terrain used for airspace evaluation.

(10) Horizontal and vertical accuracy adjustments. Enter the appropriate values as derived from appendix C, tables 1 & 2, or the digital terrain elevation data (DTED) or digital elevation model (DEM) assigned accuracy; e.g., 50 20.

(11) Accuracy code (AC). Enter the accuracy code corresponding to the adjustment values derived from appendix C, tables 1 & 2, when applicable (i.e., do not document an accuracy code when using DTED or DEM assigned accuracy values).

(12) Enter ROC for each segment. For precision PA and APV approaches where the OCS is clear, enter “ASC” (All Surfaces Clear). Where the DA is based on an OCS penetration, enter the slope penetrated; e.g., 34:1. For LNAV/VNAV where the DA is based on the FAS level surface, enter the ROC applied.

- (13) Climb gradient (CG). Enter the CG value, when applicable.
- (14) Climb gradient termination altitude (CGTA). Enter the climb gradient termination altitude (raw value), when applicable.
- (15) Adjustments. Do *not* enter additives required for rounding purposes. State only the reason for and amount of adjustment, rounded to the next higher foot [see paragraphs 2-11-3.a and 2-11-3.b]. The following codes should be used: RA - remote altimeter; AS - airspace; AT -air traffic; AC - accuracy code; CA - cardinal altitude; SI - straight-in minimums; XL - excessive length of final; PR - precipitous terrain; HAA - circling minimum HAA; MA - missed approach; MT – mountainous terrain; PT - procedure turn; DG - descent gradient; GS - glide slope; HT – minimum HAT; MEA - minimum en route altitude; MAH - missed approach hold; SA - secondary area (also X/Y surfaces, transition areas); VEB – Vertical Error Budget. Enter the adjustment amount for all codes except SI and HAA. Use XP to refer to the “Remarks” section for items not covered in this paragraph. For example: AC50, SA-27, AS1500, etc. If necessary explain the code used in “Part C - Remarks.” For precision or APV approaches, where obstacles require a glide slope higher than three degrees, enter GS but exclude the amount of adjustment.
- (16) Minimum altitude. The obstruction elevation + ROC + altitude adjustment = minimum altitude (computed); OR, high terrain elevation + airspace adjustment = minimum altitude (computed). Enter the appropriately rounded value. Make entries on the obstruction line as well as the airspace evaluation line. When possible, separate sets of segment entries with a blank line. The segment minimum altitude to be published must be the higher rounded value, and must match the respective altitudes shown on the corresponding report format Form 8260-3/5/7A. For part-time remote altimeters, make entries in the final/stepdown “Alt. Adj.” and “Min. Alt.” columns on a separate line just below the entries for full-time altimeter. The minimum altitude values for nonprecision final/stepdown and circling must be rounded to the next higher 20-foot increment.
- (17) Distance to Vertical Error Budget (D<sub>VEB</sub>). Enter, when applicable, the distance from the LTP/FTP to the vertical error budget OCS origin.
- (18) Vertical Error Budget (VEB) OCS. Enter, when applicable, the slope of the OCS.
- (19) RF center or TF fix/distance. Enter, when applicable, the RF center fix name and distance.
- (20) TF/RF calculations. The calculation values will be entered on this line for each and the variables used [Where ALT = altitude; DTA = distance to turn anticipation; KIAS = knots indicated airspeed; KTAS = knots true airspeed; HAA = height above airport; VKTW = velocity knots tailwind; TR = turn radius (NM), and BA = bank angle].

**Examples:**

RF SEGMENT	ALT	KIAS	KTAS	HAA	VKTW	TR	BA	DTA	COURSE CHANGE	DVEB	VEB OCS	RF CENTER FIX/DISTANCE
CUKLI-LICIP	4000	250	270.21	3985.20	60.00	4.20	19.72			2417.35	20.99:1	(ZEXAX)/6.70NM

TF TURN FIX	ALT	KIAS	KTAS	HAA	VKTW	TR	BA	DTA	COURSE CHANGE	DVEB	VEB OCS	RF CENTER FIX/DISTANCE
KINGR	4792	230	252.04	3543.20	55.43	4.25	18.00	4597.68	21.78			

(21) Segment remarks. The portion can be used to describe such things as speed restrictions, coordinates for RF center points, etc.

(22) Missed approach. The MAP (or DA for precision/APV approaches) will be identified in the “FROM” column. Enter the clearance limit in the “To” column. When more than two lines of minimums are present, or when the missed approach consists of more than one segment, then list each segment of the missed approach separately. For example, a missed approach in the form of “Climb to 2000, then climbing left turn to 3000 heading 260 and PWA-216 to JESKE and hold” consists of three segments which include (1) MAP to 2000 MSL, (2) 2000 MSL to PWA R-216, and (3) PWA R-216 to JESKE. Annotate segments common to all lines of minimums only once. Elaborate in Segment Remarks, if necessary. See paragraph 8-7-1.b(1) thru 8-7-1.b(20) for data entry fields.

(a) When there are multiple controlling obstacles in the missed approach segment (e.g., to support a missed approach climb gradient), specify all controlling obstacles by type, coordinates, elevation and accuracy code. Document the controlling obstacles to include the obstacle requiring the highest climb gradient and the obstacle which controls the climb gradient termination altitude (if different). Document the highest obstacle (and adjustments) used to determine the preliminary missed approach altitude. For multiple segments, document the highest obstacle/adjustments in the primary area, or highest equivalent obstacle/adjustments in the secondary area, for each segment of the missed approach. Document the highest terrain within the primary area for each segment of the missed approach.

(b) Enter “ASC” in the “ROC” column when the 40:1 OCS surface is not penetrated. If it is penetrated and a non-standard climb gradient has been applied, enter “CG” followed by the OCS slope (e.g., “CG/32:1”). Enter the clearance limit altitude in the “MIN ALT” column. Enter any additional comments in “Segment Remarks,” if necessary.

(23) Circling. Enter the circling data for each category of aircraft authorized by the procedure. Enter controlling obstacle to include obstacle number, coordinates to the hundredth of a second. Document the variable turn radii values used to the nearest 0.01 NM. When establishing the HAA, the straight-in MDA, or the circling ROC may determine the minimum circling altitude. When the minimum circling altitude has been determined, enter the resulting HAA in the “HAA” block. If two HAAs are available, enter both HAAs separated by a “/.” Enter obstacle elevation MSL followed by the horizontal and vertical accuracy then the appropriate accuracy code. Enter ROC to the nearest foot. When HAA controls the circling minimum altitude, enter “HAA” in the “Adjustments” column; when the straight-in MDA controls the circling minimum altitude, enter “SI.” Enter other adjustment codes and amounts as appropriate. Enter only the published minimum altitudes to the next higher 20-foot increment. If use of a remote altimeter requires a higher minimum circling altitude, enter both values separated by a “/” (or only the remote altimeter value, if applicable). Enter circling remarks as needed.

(24) MSA. Identify the runway number (e.g., RW36) for RNAV procedures without a TAA; NAVAID or fix; or airport reference point (ARP) used as the minimum sector altitude (MSA) “center” point; define the “sector” boundaries when permitted by criteria. If a “common safe altitude” is established, define only one sector (360 degrees - 360 degrees) and only the one controlling obstacle. Identify obstructions by type (e.g., tower, trees, etc.), geographical

coordinates, elevation MSL, their location by reference to bearing (magnetic value to the nearest whole degree) and distance (nearest 0.1 NM) from the center point for each sector required obstacle clearance, followed by the horizontal and vertical accuracy then the appropriate accuracy code, and ROC. Enter any adjustment and the resulting MSA in the “MIN ALT” block in hundreds of feet. Leave blank for RNAV procedures incorporating a TAA. Enter MSA remarks as needed.

**c. Part B: Supplemental data.**

(1) Communications with. Identify the facility or facilities providing approach control and terminal service to the airport. If no full-time or part-time control tower, include the associated FSS. Flight inspection reports are the source for the primary frequency bands in which satisfactory communications are provided. For clarity, facility identification should agree with those used in the Chart Supplement.

(2) Weather service/back-up weather service. Enter automatic weather reporting system(s) used to include level for AWOS. Enter the location(s) by airport identifier for the weather source(s). Enter the hours of operation: (if part time weather service use numerical hours of operation e.g.; 0500-1800).

(3) Altimeter source/back-up (B/U) altimeter source. Identify by airport identifier the altimeter setting source(s). If an altimeter setting is derived from a remote source, indicate the distance to 0.01 NM. Enter the number of clock hours of the altimeter source/s. Enter “Yes/No” whether the weather source is transmitted to WMSCR. Enter the resulting altitude adjustment (ROC increase) value rounded to the next higher whole foot increment. This value is used in the “Adjustments” column in part A, as appropriate. Enter in “Weather Remarks,” whether pressure patterns are the same, or not, the airport identifiers and field elevations when pressure patterns are the same, or high and low terrain values when pressure patterns are not the same, and the raw remote altimeter adjustment.

**Example:**

RASS pressure patterns the same

KOMA 984, KMLE 1050

RA = 36.3

RASS pressure patterns not the same

High Terrain 1634, Low Terrain 323

RA = 210.6

(4) Primary NAVAID/Secondary NAVAID. Identify the primary NAVAID (facility providing final approach guidance) and the location providing CAT 1 monitoring service. Enter the number of hours per day for CAT 1 monitoring service, and CAT 3 monitoring service at part-time monitoring points. For GPS or RNAV or non-RNAV (VOR/DME), leave blank. For RNAV (VOR/DME), enter the reference facility three-letter ID.

(5) Approach and runway lighting. Identify all runways with the available approach, runway, and VGSI lighting used. Enter VGSI types, i.e., VASI, PAPI, etc. Enter “(PCL)” when pilot controlled lights are available.

(6) Runway markings. List all runways with serviceable/non-standard runway markings. Place “BSC,” “PIR” and “NPI” in front of runway markings (e.g., PIR-G, NPI-Faded).

(7) Runway visual range. List each RVR system.

(8) Glidepath angle/Elevation runway threshold/Threshold crossing height/Centerline elevation abeam glideslope/Distance from runway. Provide GS/GP information as indicated for all precision and APV procedures to the following accuracy: GS/GP angle – nearest .01 degree; elevation RWY THLD and abeam GS/GP Ant – nearest 0.1 foot.; TCH – nearest 0.1 foot.; distance THLD to GS/GP Ant – nearest foot; VASI – angle to the nearest .01 degree and TCH to the nearest foot. These values must agree with the approved database.

(9) Final approach course aiming/Threshold displaced. Identify the desired approach course aiming point as determined by the procedure construction. Normally this will be the runway threshold or a point on the runway centerline extended at a specified distance from the threshold. Check either blocks on any precision or APV approach, or where the FAC is directly aligned to the runway threshold. For distances, from thresholds between 3000 feet and 5200 feet, enter the specific value. For those final approaches that parallel the runway centerline extended or intersect the centerline more than 5200 feet from the threshold, specify the distance between the FAC and the RCL extended at a point 3000 feet from the LTP measured perpendicular to the RCL. For circling or point-in-space alignment, explain in “Part C: General Remarks,” including geographical coordinates.

(10) Baro-VNAV critical temperatures box and remarks.

(a) Critical temperatures box. For RNAV (GPS and RNP) Baro-VNAV procedures, enter the results of Critical Temperature computations [see paragraph 4-6-8].

(b) Critical temperatures remarks:

1. When Average Cold Temperature (ACT) is derived from historical temperature data, use standard entry “Average Cold Temperature based on (# years) –year history (inclusive years; e.g., 2004 – 2008 or individual years; e.g., 2004, 2006, 2008).”

2. When ACT is derived from a standard deviation value, use standard entry: “Average Cold Temperature based on standard (geographical deviation value) ISA deviation.”

3. Enter the basis for the CRITICAL LOW (NA Below) temperature (i.e., ACT or effective GPA).

4. Enter the descent rates in feet per minute (FPM) at standard and high temperature.

5. Enter additional remarks as needed.

**Example:****CRITICAL TEMPERATURES**

CRITICAL LOW	CRITICAL HIGH	ACT	APT ISA
-17C	+54C	-17C	+14.13C

**CRITICAL TEMPERATURES REMARKS**

AVERAGE COLD TEMPERATURE DERIVED FROM 5-YEAR HISTORY (2009-2013).  
CRITICAL LOW TEMPERATURE BASED ON ACT.  
DESCENT RATE (FPM): STANDARD TEMP 960 HIGH TEMP 1120.

**Example:****CRITICAL TEMPERATURES**

CRITICAL LOW	CRITICAL HIGH	ACT	APT ISA
-25C	+46C	-25C	+4.04C

**CRITICAL TEMPERATURES REMARKS**

AVERAGE COLD TEMPERATURE DERIVED FROM STANDARD -30C ISA DEVIATION.  
CRITICAL LOW TEMPERATURE BASED ON ACT.  
DESCENT RATE (FPM): STANDARD TEMP 1032 HIGH TEMP 1205.

**Example:****CRITICAL TEMPERATURES**

CRITICAL LOW	CRITICAL HIGH	ACT	APT ISA
-19C	+54C	-21C	+13.66C

**CRITICAL TEMPERATURES REMARKS**

AVERAGE COLD TEMPERATURE DERIVED FROM 3-YEAR HISTORY (2010, 2012, 2013).  
CRITICAL LOW TEMPERATURE BASED ON EFFECTIVE GPA.  
DESCENT RATE (FPM): STANDARD TEMP 963 HIGH TEMP 1124.

(11) Visual portion of final penetrations. Document Order 8260.3, chapter 3, “Visual Portion of Final” penetrations. Document 20:1 penetrations first, followed by 34:1 penetrations as applicable. For an obstacle that penetrates the 20:1 surface, do not repeat the documentation process for the 34:1 surface (i.e., 20:1 penetrations automatically penetrate the 34:1 surface). Include the obstacle MSL elevation, obstacle type and ID (if applicable), coordinates, and amount of penetration to the 0.01 of a foot, starting with the greatest penetration in descending order. For multiple final segments, if penetrations exist, document each segment e.g., LPV, LP, LNAV/VNAV, LNAV, and Circling runway(s), as applicable. Use standard entry:

“Visual Portion of Final” penetrations:

**RNP, LPV, and LNAV/VNAV:**

<u>20:1</u>	5345 TREE (KSUN0092) 432931.65N/1141713.21W (43.57)
	5342 TREE (KSUNT037) 432930.08N/1141710.91W (30.03)
<u>34:1</u>	5337 TREE (KSUN0081) 432927.26N/1141702.79W (27.89)

LNAV:

- 20:1 5343 TREE (KSUN0091) 432932.65N/1141712.21W (42.57)  
5340 TREE (KSUNT039) 432931.08N/1141711.91W (28.03)
- 34:1 5335 TREE (KSUN0081) 432928.26N/1141703.79W (25.89)

**CIRCLING RWY XX:**

- 20:1 5345 TREE (KSUN0092) 432931.65N/1141713.21W (43.57)  
5342 TREE (KSUNT037) 432930.08N/1141710.91W (30.03)

(12) Document helicopter “Visual Portion of Final” or “Proceed VFR” penetrations. Document “Visual Portion of Final” penetrations and/or “Proceed VFR” obstacle(s) that penetrate the 5280-foot obstacle assessment area. Include the obstacle MSL elevation, obstacle type and ID (if applicable), coordinates, and amount of penetration to the 0.01 of a foot, starting with the greatest penetration in descending order. See paragraph 2-11-5a for additives and exemptions. Use standard entries:

**Visual Portion of Final Penetrations:**

- 5345 TREES (KSUN0092) 432931.65N/1141713.21W (43.57)  
5342 TREE (KSUNT037) 432930.08N/1141710.91W (30.03)

and/or

**5280-FOOT “PROCEED VFR” SEGMENT LEVEL SURFACE AREA PENETRATIONS:**

- 5345 TREES (KSUN0092) 432931.65N/1141713.21W (43.57)  
5342 TREE (KSUNT037) 432930.08N/1141710.91W (30.03)  
5337 TREE (KSUN0081) 432927.26N/1141702.79W (27.89).

**d.** Part C: General remarks. Use this space to amplify previous entries (state associated part number for reference), or to record essential data not considered elsewhere on the form. Also see paragraphs 8-6-7.c(1)(c) and 8-6-10.e.

- (1) State the effect, if any, of waivers to published minimums.
- (2) For RNAV (VOR/DME) SIAPs, enter the MA fix XTRK error.
- (3) Enter the amount of threshold displacement, if any.
- (4) When flight inspection establishes a final FAC other than the plotted magnetic course, enter:

“Plotted FAC is 087.43 M.”

“Electronic flight inspected FAC is 089 M.”

- (5) Enter a reason when a VDP has not been established: e.g., “VDP NOT ESTABLISHED – Obstacles penetrate 20:1 surface.”



(6) Enter a statement indicating the precipitous terrain evaluation has been completed: “PRECIPITOUS TERRAIN EVALUATION COMPLETED.” This will be done even if adjustments are required and entered in part A. Additionally, when the precipitous terrain is identified in a Feeder Segment located in designated mountainous terrain areas, ROC reductions [see Order 8260.3] are not authorized. Document as follows:

“Feeder Segment (Fix Name) to (Fix Name) terrain identified as precipitous; ROC reductions not authorized/2000-foot ROC Required.”

(7) Enter indicated airspeed(s) (IAS) used to calculate RF turn radius for RNP procedures *if other than standard*; e.g., Max speed FONVI to JUBOL – 140 KIAS.

**Note:** When this speed is less than the maximum allowed by criteria, a note must be placed on the chart to inform the pilot. See paragraph 4-6-10.g for charting instructions.

(8) Document nonstandard tailwind component used in helicopter missed approach and departure calculations [see Order 8260.42, chapter 2]; e.g., NONSTANDARD TAILWIND COMPONENT USED – 40 KNOTS.

(9) Document nonstandard bank angle used in helicopter calculations [see Order 8260.42, chapter 2]; e.g., NONSTANDARD BANK ANGLE USED – 18 DEGREES.

(10) Document route width reductions used in helicopter GPS or WAAS procedures [see Order 8260.42, chapter 2]; e.g., ROUTE WIDTH REDUCTION KLING TO GENNE – 1.5 NM PRIMARY; 0.5 NM SECONDARY.

(11) Document the height above the heliport/airport or height above surface when a turn at an altitude for the missed approach is less than 400 feet. AGL; e.g., MA TURN BEGINS 250 FT ABOVE HELIPORT (or SURFACE, or AIRPORT).

(12) Document that Order 8260.3, chapter 2, new circling criteria has been applied as follows: “Order 8260.3, chapter 2, New Circling Criteria Applied.”

(13) When Simultaneous Close Parallel (SCP) approaches have been authorized to conduct unique operations specified in a safety study, document a reference to the applicable report (see Order 8260.3, section 16-2).

**e.** Part D: Airspace. Enter airspace data required by paragraph 5-2-4.k. Carry this information forward until amended. Alternatively, this information may be entered on any acceptable format for provision of airspace data to ATC. This form must document *all* the data requirements of paragraph 5-2-4.k.

**f.** Part E: Prepared by. Enter the name and title of the Aeronautical Information Services specialist or non-Federal developer responsible for preparing the data record; the date prepared; and the originating office.

**g.** Instrument approach procedure graphic. A graphic sketch of the plan and profile views of the approach procedure and the operational minimums as envisioned by the procedures specialist

must be depicted on a separate 8 ½" x 11" sheet. This graphic presentation becomes part of Aeronautical Information Services file. It assists the cartographer in visualizing the desired IAP layout; and is required to test the validity of the narrative procedure and to uncover any potential charting problems prior to formal publication.

**h.** Distribution. Retain completed copies of the Form 8260-9 with the associated SIAP and distribute as defined in table 8-3-2..

**Section 8-8. Transmittal of Airways/Route Data Record,  
FAA Form 8260-16**

**8-8-1. Preparation of Form 8260-16.** This form serves as a transmittal sheet of en route procedural data for Air Traffic Service (ATS) routes, both non-regulated and those published under 14 CFR part 71 and Minimum IFR Altitudes published under 14 CFR part 95. Part 71 ATS routes include Victor Airways, Jet Routes, RNAV “Q” (for FL 180 up to FL 450) and “T” and “TK” Routes (below FL 180). The form documents current en route information. All airway/route changes/cancellations must be documented on Form 8260-16 to ensure publication. Document only one airway or route per Form 8260-16. If airways overlap, document each on a separate form.

**a.** Airway No. or Route. Enter the airway number, “part 95 Direct,” or “Off-Airway Non-95” as appropriate. Use a separate form for each type of route.

**Examples:**

For High Altitude RNAV routes - Q502

For Low Altitude RNAV routes – T204

For Low Altitude helicopter RNAV routes – TK502

For Jet routes – J345

For Victor Airways – V123

**b.** Routine or Docket No. Enter the docket number when the request is associated with an airspace action. If processing is to be routine, leave blank.

**c.** From/Fly-By/Fly-Over/To/RNP/Leg Type. Each segment (fix to fix) must be listed, unless succeeding segments have been amended. Segments must be separated at facilities, changes of MEA, MOCA, MAA, and all MCA flagged fixes, and MRA flagged fixes where the MRA is higher than the MEA for route of flight. All airways and routes terminate at the U.S. control area boundary (route alignment may be explained in “Segment Remarks”).

(1) Route segments must be listed from West to East for even numbered ATS routes or South to North for odd numbered routes. When amending published routes, follow the order of listing in the annual consolidation of 14 CFR part 95 IFR altitudes.

(2) Facilities are identified by name, by the three letter ICAO identifier in parentheses, the facility type, and the two letter state abbreviation and if a waypoint (include type for RNAV routes).

**Examples:**

Airway/Jet Route: Charlotte (CLT), VOR/DME, NC

RNAV Route: Charlotte (CLT), VOR/DME, NC (FB)

(3) Fixes are identified by name, the two letter state abbreviation and if a waypoint (include type for RNAV routes).

**Examples:**

Airway/Jet Route: JOTTA, NC  
RNAV Route: JOTTA, NC (FB)

(4) In the “TO” block, document the leg type (path terminator) used for each segment of RNAV routes. Only track-to-fix (TF) leg types are used in RNAV routes.

**Examples:**

Charlotte, (CLT), NC, VOR/DME, (FB) (TF)  
JOTTA, NC (FB) (TF)

(5) “Q” routes can be flown using GNSS or DME/DME/IRU. Required DME facilities will be documented in the “Segment Remarks” section. In some cases, sufficient ground-based navigation sources are inadequate/unavailable to support DME/DME/IRU operations. When this occurs, the route must be annotated “GNSS REQUIRED.” Document this requirement in the “Segment Remarks” section of Form 8260-16.

**Note:** All “Q” routes will be assessed using the RNAV-Pro DME screening software. This screening will determine if the “GNSS REQUIRED” note is required. However, the route may have passed the RNAV-Pro screening but Flight Inspection may have determined that the route is unsuitable for DME/DME/IRU operations and require the note to be placed on the route.

**d.** Controlling terrain/obstruction and coordinates. Document the highest terrain and the highest tree or man-made obstacle with the obstacle ID number, if the man-made obstacle is a AAO, the obstacle ID number does not apply. Enter coordinates in degrees, minutes and seconds to the hundredth. Identify which obstacle controls the MEA, even though MRA may require a higher altitude by annotating under the “CONT OBST” block with a “Y” (YES) in either the obstacle or terrain line. Next enter the obstacle height, followed by the “AC” (accuracy code), then enter the required obstacle clearance “ROC” for each segment. If the controlling obstacle is located in the secondary area, state only the reason for and amount of adjustment in the “Adjustments” block. No entry is required for high altitude (Jet or RNAV) routes if terrain is not a factor. Enter reduction of mountainous obstacle clearance in the “Adjustments” block. Document the airspace floor and buffer used to evaluate the segment airspace requirements in the Segment Remarks portion.

**e.** MRA/MOCA. Enter both figures. To reduce chart clutter, MOCAs less than 500 feet below MEAs should not be published unless they allow use of a cardinal altitude within 25 NM of a facility. If a MOCA is not to be published, enter a “Y” or “N” in the “PUB” block.

(1) Low altitude RNAV routes assume GPS/GNSS signal coverage MRA is adequate at the MOCA; therefore, enter the MOCA value in the MRA block. Increase the MRA value if required by flight inspection.

(2) For low altitude RNAV routes do not publish a MOCA that is less than 500 feet below the MEA unless the resulting MOCA will provide a cardinal altitude.

**f.** MAA/MEA. Enter both figures. When dual MEAs are used, indicate the altitudes in MEA (1) and MEA (2) then indicate the direction of flight in the “Direction” block for each

MEA. When an MEA change occurs at a DME-only fix, dual MEAs are required since non-DME aircraft cannot receive the fix. When minor MEA differences exist in adjacent segments, coordinate with ATC to establish a common altitude.

(1) For Low altitude RNAV “T” and “TK” routes enter the MRA value or minimum altitude based on airspace evaluation, whichever is higher. Increase the MRA value if required by flight inspection. The MEA block will be left blank.

(2) For high altitude RNAV “Q” routes, the MEA, like Jet routes, is considered to be FL 180 unless noted otherwise [see paragraph 8-8-1.g]. The MEA block will be left blank except when there is insufficient DME coverage to support the use of DME/DME/IRU “Q” route operations at FL180. An MEA may then be established to define the lowest altitude that will support DME/DME/IRU use. This will be identified in the “D/D/I” block with a “Y” or “N.”

**g. GNSS MEA.** A GNSS MEA is required on all RNAV routes and may be established (when required) for low altitude Victor or colored airways. Do not establish a GNSS MEA on a Victor or colored airway unless it is at least 500 feet lower than the conventional MEA or achieves a cardinal altitude. The GNSS MEA must be an altitude at or above the MOCA and provide communication capability as required in TERPS.

**Note:** These MEAs will be depicted on en route charts with a “G” suffix. **Example:** 3500G.

**h. Changeover point** (not applicable for RNAV routes). Enter the changeover point in the segment where it lies. If midpoint, leave blank. If *not* midpoint, enter the mileage from and the identifier of the nearest facility. If a gap exists, the changeover point may be at the middle of the gap; however, leave blank. If a dogleg course change has been established, enter “DL.” When the dogleg point meets en route VHF intersection and/or DME fix criteria, establish a pronounceable named fix. When this is not possible, establish a CNF to identify the dogleg point.

**i. MRA/MCA/MTA.** Entries will be made in each associated block “FIX MRA” and “FIX MCA” with fix name and altitude. MCAs will include the direction of flight. The same information is required on the Form 8260-2 for the fix. When an MTA is applicable for the route outbound from the fix/facility, enter a “Y” in the MTA block, otherwise, leave the MTA block blank. Document MTA information to be charted on the Form 8260-16 associated with the route inbound from the fix/facility. See examples below.

**j. Segment remarks.**

(1) Use this section for all pertinent supporting data. Typical entries include:

Airspace floor  
Terrain clearance applied  
Dogleg radials for part 95 Direct and  
Off-Airway Non-95 Routes  
Reason for MEA adjustment  
Reason for MAA reduction  
MEA gap  
Cancel segment (reason)

GNSS Required  
DME facilities required for Q routes  
Airway restrictions  
Minimum Turning Altitude  
MCA = Flight Check MRA

(2) When airway restrictions need to be identified on the chart, prior to the restriction indicate “chart.”

**Example:**

“Chart: ALB R-067 UNUSABLE, USE CAM R-248.”

“Chart: MTA V330 E TO V520 W 16000” (*Document MTA on V330 Form 8260-16*)

“Chart: MTA V465 NE TO V330 W OR V520 W 16000”

(*Document MTA on V465 Form 8260-16*)

**k. Changes-Reason.** To assist charting agencies, when segments are amended or canceled, describe the changes in the “Changes-Reason” section.

**Example:**

RAISED MEA TO MATCH OVERLYING V188 MEA.

DELETED DIRECTIONAL MEA

**l. Flight Inspection/Validation dates.** Enter the date of the original flight inspection/validation, if available, or indicate “On File.” Use “Pending” for new/relocated facility docket. If flight inspection/validation records are not available, leave blank. Use additional lines to log subsequent flight inspections/validations, periodic reviews, and amendments. When the form’s available spaces are filled, white-out the entries on manually completed forms, and start over. Regenerate electronic forms as necessary when available spaces are filled, deleting previously entered dates. Carry forward any manually entered dates.

**m. Distribution.** The approved Form 8260-16 must be prepared by Aeronautical Information Services and distributed as defined in table 8-3-2..

**n. Examples.** Figure 8-8-1 through figure 8-8-4 contains a consolidated group of examples that can be used when completing Form 8260-16.

**o. Cancellation.** Airways cancellation is accomplished through the rulemaking process. Regions publish a Notice of Proposed Rule-making (NPRM), and upon publication of the final rule, NFDC removes the affected airways from 14 CFR part 95. When cancelling a route segment place “Segment canceled” in the remarks section of the 8260-16 for each segment being canceled.



FEDERAL AVIATION ADMINISTRATION  
FLIGHT STANDARDS SERVICE  
TRANSMITTAL OF AIRWAYS/ROUTES DATA RECORD

AIRWAY\_NO.or\_ROUTE

V10

ROUTINE or DOCKET NO

FROM	STATE	FB/EO	IO	STATE	FB/EO	RNP	LEG TYPE
FALLS	OH		WONOP	OH			
OBSTRUCTION	COORDINATES	ELEV.MSL	CONT.OBS	AC	ROC	ADJUSTMENTS	
TOWER	414538.95N/0811326.73W	978			1000		
TERRAIN	414548.00N/0811400.00W	657	Y				
MRA	MOCA	PUB	D/D/I	MEA(1)	DIRECTION(1)	MEA(2)	DIRECTION(2)
3000	2000	Y		3000			
CODE	DL WONOP		EIX MRA	EIX MCA	WONOP 5000	MTA	
						N	

+
-

SEGMENT REMARKS  
RETAINED CURRENT MEA

CHANGES-REASON  
ADDED SEGMENT - FLIGHT CHECK REQUEST  
ADDED MRA FLAG - YOUNGSTOWN (YNG). VORTAC RESTRICTION PER FLIGHT CHECK 04/16/2009  
CHANGED ICKOJ TO WONOP - ATC REQUEST



FEDERAL AVIATION ADMINISTRATION  
FLIGHT STANDARDS SERVICE  
TRANSMITTAL OF AIRWAYS/ROUTES DATA RECORD

AIRWAY\_NO.or\_ROUTE

V10

ROUTINE or DOCKET NO

FROM	STATE	FB/EO	IO	STATE	FB/EO	RNP	LEG TYPE
WONOP	OH		YOUNGSTOWN (YNG), VORTAC	OH			
OBSTRUCTION	COORDINATES	ELEV.MSL	CONT.OBS	AC	ROC	ADJUSTMENTS	
TOWER	413802.00N/0810340.00W	1620			1000		
TERRAIN	413839.00N/0810333.00W	1326	Y				
MRA	MOCA	PUB	D/D/I	MEA (1)	DIRECTION (1)	MEA (2)	DIRECTION (2)
5000	2700	Y		5000			
CODE			EIX.MRA		EIX.MCA		
						MTA	
						N	

+
-

SEGMENT REMARKS

CHANGES-REASON  
ADDED GNSS - ATC REQUEST  
INCREASED MEA - PER FLIGHT CHECK DATED 04/16/2013  
THIS IS A CORRECTED COPY OF THE FORM DEVELOPED ON 04/29/2014

FLIGHT CHECK DATE OFFICE NAME

PENDING

APPROVED DATE OFFICE TITLE NAME

MM/DD/YYYY XXX-XXXX MANAGER TILDAL N. WAVE

THIS PAGE IS INTENTIONALLY LEFT BLANK

Figure 8-8-2. Transmittal of Airways/Route Data Record

FEDERAL AVIATION ADMINISTRATION  
FLIGHT STANDARDS SERVICE  
TRANSMITTAL OF AIRWAYS/ROUTES DATA RECORD

AIRWAY NO. or ROUTE	STATE	FB/EO	ID	OSITY	ELEV. MSL	CONT. OBS	STATE ID	FB/EO	RNP	LEG. TYPE
V330										
ROUTINE or DOCKET NO										
FROM	STATE ID	FB/EO	ID	OSITY	ELEV. MSL	CONT. OBS	STATE ID	FB/EO	RNP	LEG. TYPE
IDAHO FALLS (IDF), VOR/DME										
OBSTRUCTION	COORDINATES						AC	ROC	ADJUSTMENTS	
TREE	432912.00N/114118.00W				6177	Y		2000	MT-300	
TERRAIN	432912.00N/114118.00W				6077					
MRA	MOCA	PUB	MAA	D/D/I	MEA (1)	MEA (2)	DIRECTION (2)	GNSS MEA		
8000	7900	N	17500		8000					
COP				FIX MRA					MTA	
									N	
SEGMENT REMARKS										
CHANGES-REASON										
DELETED MCA AT IDA VOR/DME - ADDED MCA AT OSITY DECREASE MOCA										
DELETED DIRECTIONAL MEA - MEA CARDINAL ALTITUDE										

+
-

FEDERAL AVIATION ADMINISTRATION  
FLIGHT STANDARDS SERVICE  
TRANSMITTAL OF AIRWAYS/ROUTES DATA RECORD

AIRWAY\_NO.or\_ROUTE

V330

ROUTINE or DOCKET NO

FROM	STATE	FB/FO	IO	JACKSON HOLE (JAC), VOR/DME	STATE	FB/FO	RNP	LEG TYPE
OSITY	ID				ID			
OBSTRUCTION	COORDINATES	ELEV.MSL	CONT.OBS	AC	ROC	ADJUSTMENTS		
AAO	434118.30N/1104856.30W	12138	Y		2000	SA-467		
TERRAIN	433900.00N/1105057.00W	11132						
MRA	MOCA	PUB	D/D/I	MEA (1)	DIRECTION (2)	GNSS MEA		
14000	13600	N		14000				
CODE	JACKSON HOLE (JAC), VOR/DME 10 NM	EIX MRA	EIX MCA	JACKSON HOLE (JAC), VOR/DME 13400W	MTA			
					Y			

+
-

8-104

SEGMENT REMARKS  
CHART: MTA V330 E TO V520 W 16000  
JAC R-251 UNUSABLE BEYOND 10NM; PRECIPITIOUS TERRAIN  
CHANGES-REASON  
DECREASED MOCA - MCA ADDED AT OSITY  
MEA CARDINAL ALTITUDE - ATC REQUEST  
INCREASE MCA - OBSTACLE

FLIGHT CHECK	DATE	OFFICE	NAME
	MM/DD/YYYY	XXX-XXXX	ANGLE F. NIGHTENGAL
APPROVED	DATE	OFFICE	TITLE
	MM/DD/YYYY	XXX-XXXX	MANAGER
			NAME
			FLINT B. GARAGEO

Figure 8-8-3. Transmittal of Airways/Route Data Record

FEDERAL AVIATION ADMINISTRATION  
FLIGHT STANDARDS SERVICE  
TRANSMITTAL OF AIRWAYS/ROUTES DATA RECORD

AIRWAY NO. or ROUTE													
J40													
ROUTINE or DOCKET NO.													
FROM	STATE	EB/EQ	IQ	MACON (MCN), VORTAC	STATE	EB/EQ	RNP	LEG TYPE					
MONTGOMERY (MGM), VORTAC	AL				GA								
OBSTRUCTION	COORDINATES		ELEV MSL	CONT OBS	AC	ROC	ADJUSTMENTS						
MRA	MOCA	PUB	MAA	D/D/I	MEA (1)	DIRECTION (1)	MEA (2)	DIRECTION (2)	GNSS MEA				
18000			45000		18000								
COE			FIX MRA		FIX MCA				MTA				
139 MONTGOMERY, (MGM) VORTAC									N				
SEGMENT REMARKS													
CHART: MCN R-258 UNUSABLE USE MGM R-075 FOR NAVIGATION													
CHANGES-REASON													

+
-

FLIGHT CHECK	DATE	OFFICE	NAME
	MM/DD/YYYY	XXX-XXXX	WOODY ILE FAIRWAY
APPROVED	DATE	OFFICE	NAME
	MM/DD/YYYY	XXX-XXXX	TUTTLE B. WARS
		TITLE	
		MANAGER	

THIS PAGE IS INTENTIONALLY LEFT BLANK

Figure 8-8-4. Transmittal of Airways/Route Data Record

FEDERAL AVIATION ADMINISTRATION  
FLIGHT STANDARDS SERVICE  
TRANSMITTAL OF AIRWAYS/ROUTES DATA RECORD

AIRWAY NO. or ROUTE													
Q26													
ROUTINE or DOCKET NO.													
FROM	STATE	FB/EO	IO	STATE	FB/EO	RNP	LEG TYPE						
WALNUT RIDGE (ARG), VORTAC	AR	FB	DEVAC	AR	FB	2	TF						
OBSTRUCTION	COORDINATES		ELEV MSL	CONT OBS	AC	ROC	ADJUSTMENTS						
MRA	MOCA	PUB	MAA	D/D/I	MEA (1)	MEA (2)	DIRECTION (2)	GNSS MEA					
20000	33000		20000	FIX MRA	20000			18000					
COE			FIX MRA	FIX MCA				MTA					
SEGMENT REMARKS													
DME FACILITIES REQUIRED LIT, JKS, GOO, MEM, BNA, FAM, ARG, DTR, VUZ, RMG; PUBLISH REMARKS IN A/FD ONLY													
CHANGES-REASON													
DECREASE MAA FOR JKS INTERFERENCE -- FLIGHT CHECK													
FLIGHT CHECK	DATE	OFFICE	NAME										
	MM/DD/YYYY	XXX-XXXX	JOHN W. AIRPLANE										
APPROVED	DATE	OFFICE	TITLE	NAME									
	MM/DD/YYYY	XXX-XXXX	MANAGER	TILE M. OVER									

+
-

THIS PAGE IS INTENTIONALLY LEFT BLANK



Figure 8-8-5. Transmittal of Airways/Route Data Record

FEDERAL AVIATION ADMINISTRATION  
FLIGHT STANDARDS SERVICE  
TRANSMITTAL OF AIRWAYS/ROUTES DATA RECORD

AIRWAY NO. or ROUTE	FROM	TO	STATE	FB	FB	AYKIN	STATE	FB	RNP	LEG. TYPE
T273			AK	FB	AYKIN	AK	FB	2		TF
ROUTINE or DOCKET NO	10-AAL-7									
FAIRBANKS (FAI), VORTAC										
OBSTRUCTION										
AAO	COORDINATES									
	653215.00N/1472030.00W									
TERRAIN	653215.00N/1472030.00W									
MRA	MOCA	PUB	MAA	D/D/I	MEA (1)	MEA (2)	DIRECTION (2)	GNSS.MEA		
6700	6700	N	17500					6700		
COE			FIX.MRA		FIX.MCA		MTA		N	
<div style="display: flex; justify-content: space-around; align-items: center;"> <span style="border: 1px solid black; padding: 2px 5px;">+</span> <span style="border: 1px solid black; padding: 2px 5px;">-</span> </div>										
SEGMENT REMARKS										
PRECIPITIOUS TERRAIN EVALUATED										
CHANGES-REASON										
SEGMENT ADDED - ATC REQUEST										

FEDERAL AVIATION ADMINISTRATION  
FLIGHT STANDARDS SERVICE  
TRANSMITTAL OF AIRWAYS/ROUTES DATA RECORD

AIRWAY_NO.or_ROUTE											
T273											
ROUTINE or DOCKET NO											
10-AAL-7											
FROM	STATE	FB	IO	STATE	FB	RNP	LEG TYPE				
AYKIN	AK	FB	TUWO	AK	FB	2	TF				
OBSRUCTION	COORDINATES		ELEV.MSL		CONT.OBS		ADJUSTMENTS				
TREE	655312.10N/1471424.70W		4277				2000		MT-300		
TERRAIN	655312.10N/1471424.70W		4177								
MRA	MOCA	PUB	D/D/I	MEA(1)	DIRECTION(1)	MEA(2)	DIRECTION(2)	GNSS MEA			
6000	6000	N		17500				6000			
CODE	EIX MRA		EIX MCA		EIX MCA		MTA				
							N				

+
-

SEGMENT REMARKS  
PRECIPITIOUS TERRAIN EVALUATED  
CHANGES-REASON  
SEGMENT ADDED - ATC REQUEST

FEDERAL AVIATION ADMINISTRATION  
FLIGHT STANDARDS SERVICE  
TRANSMITTAL OF AIRWAYS/ROUTES DATA RECORD

AIRWAY_NO.or_ROUTE														
T273														
ROUTINE or DOCKET NO														
10-AAL-7														
FROM	STATE	FB/EO	IO	STATE	FB/EO	RNP	LEG TYPE							
TUWO	AK	FB	SOTGE	AK	FB	2	TF							
OBSRUCTION	COORDINATES	ELEV.MSL	CONT.OBS	AC	ROC	ADJUSTMENTS								
AAO	691639.80N/1445440.60W	9230	Y	AC	2000									
TERRAIN	691639.80N/1445440.60W	9030												
MRA	MOCA	PUB	D/D/I	MEA(1)	DIRECTION(1)	MEA(2)	DIRECTION(2)	GNSS MEA						
11300	11300	N		17500				11300						
COE			EIX.MRA			EIX.MCA			MTA					
									N					

+
-

SEGMENT REMARKS  
PRECIPITOUS TERRAIN EVALUATED  
CHANGES-REASON  
SEGMENT ADDED - ATC REQUEST

FEDERAL AVIATION ADMINISTRATION  
FLIGHT STANDARDS SERVICE  
TRANSMITTAL OF AIRWAYS/ROUTES DATA RECORD

AIRWAY\_NO.or\_ROUTE  
T273

ROUTINE or DOCKET NO  
10-AAL-7

FROM	STATE	FB/EO	IO	STATE	FB/EO	RNP	LEG TYPE
SOTGE	AK	FB	ROCES	AK	FB	2	TF
OBSTRUCTION	COORDINATES	ELEV.MSL	CONT.OBS	AC	ROC	ADJUSTMENTS	
TREE	694433.00N/1443842.00W	1016			2000	AS 3000, MT-300	
TERRAIN	655312.10N/1471424.70W	916	Y				
MRA	MOCA	PUB	MAA	D/D/I	MEA(1)	DIRECTION(2)	GNSS MEA
4000	2800	N	17500				4000
CODE				EIX.MRA	EIX.MCA		MTA N

+

-

SEGMENT REMARKS  
PRECIPITOUS TERRAIN EVALUATED

CHANGES-REASON  
SEGMENT ADDED - ATC REQUEST

FLIGHT CHECK	DATE	OFFICE	NAME
	MM/DD/YYYY	XXX-XXXX	JOHN P. JONES
APPROVED	DATE	OFFICE	TITLE
	MM/DD/YYYY	XXX-XXXX	MANAGER
			RAYMOND J. JOHNSON JR

Figure 8-8-6. Transmittal of Airways/Route Data Record

FEDERAL AVIATION ADMINISTRATION  
FLIGHT STANDARDS SERVICE  
TRANSMITTAL OF AIRWAYS/ROUTES DATA RECORD

AIRWAY NO. or ROUTE														
TK502														
ROUTINE or DOCKET NO														
10-AEA-20														
FROM	STATE	FB	IO	STATE	FB	LEG TYPE								
WESTMINSTER (EMI), VORTAC	MD	FB	TAYLO	MD	FB	TF								
OBSTRUCTION	COORDINATES		ELEV MSL		CONT OBS	AC	ROC	ADJUSTMENTS						
TREE	393342.00N/0765748.00W		1052				2000	MT-500						
TERRAIN	393342.00N/0765748.00W		952											
MRA	MOCA	PUB	D/D/I	MEA (1)	MEA (2)	DIRECTION (2)	GNSS MEA							
2700	2600	N		17500			2700							
COP	FIX MRA		FIX MCA		MTA									
					N									
SEGMENT REMARKS														
NEW ROUTE														
CHANGES REASON														
<table border="1" style="float: right; margin-top: 10px;"> <tr> <td style="padding: 2px 5px;">+</td> </tr> <tr> <td style="padding: 2px 5px;">-</td> </tr> </table>													+	-
+														
-														

FEDERAL AVIATION ADMINISTRATION  
FLIGHT STANDARDS SERVICE  
TRANSMITTAL OF AIRWAYS/ROUTES DATA RECORD

AIRWAY\_NO.or\_ROUTE  
TK502

ROUTINE or DOCKET NO  
10-AEA-20

FROM	STATE	FB/EO	IO	STATE	FB/EO	RNP	LEG TYPE
TAYLO	MD	FB	WINGO	PA	FB		TF
OBSSTRUCTION	COORDINATES	ELEV.MSL	CONT.OBS	AC	ROC	ADJUSTMENTS	
AAO	394345.00N/0762830.00W	981			1000		
TERRAIN	394345.00N/0762830.00W	781	Y				
MRA	MOCA	PUB	D/D/I	MEA(1)	DIRECTION(1)	MEA(2)	DIRECTION(2)
2500	2000	Y		17500			
COE			EIX.MRA		EIX.MCA		
						MTA	
						N	

+

-

SEGMENT REMARKS  
NEW ROUTE

CHANGES-REASON

FEDERAL AVIATION ADMINISTRATION  
FLIGHT STANDARDS SERVICE  
TRANSMITTAL OF AIRWAYS/ROUTES DATA RECORD

AIRWAY\_NO.or\_ROUTE  
TK502

ROUTINE or DOCKET NO  
10-AEA-20

FROM	STATE	FB/EO	IO	STATE	FB/EO	RNP	LEG TYPE		
WINGO	PA	FB	SINON	PA	FB		TF		
OBSTRUCTION	COORDINATES		ELEV.MSL	CONT.OBS	AC	ROC	ADJUSTMENTS		
TOWER	400331.68N/075352.83W		1177				1000		
TERRAIN	400318.00N/0753615.00W		722	Y					
MRA	MOCA	PUB	MAA	D/D/I	MEA(1)	DIRECTION(1)	MEA(2)	DIRECTION(2)	GNSS MEA
2400	2200	N	17500						2400
CODE				EIX.MRA	EIX.MCA		MTA		N

+

-

SEGMENT REMARKS  
NEW ROUTE

CHANGES-REASON

FEDERAL AVIATION ADMINISTRATION  
FLIGHT STANDARDS SERVICE  
TRANSMITTAL OF AIRWAYS/ROUTES DATA RECORD

AIRWAY_NO.or_ROUTE													
TK502													
ROUTINE or DOCKET NO													
10-AEA-20													
FROM	STATE	FB	IO	STATE	FB	RNP	LEG TYPE						
SINON	PA	FB	GRIBL	PA	FB		TF						
OBSTRUCTION	COORDINATES		ELEV.MSL	CONT.OBS	AC	ROC	ADJUSTMENTS						
TOWER	400516.00N/0764110.00W		1180			1000							
TERRAIN	400516.00N/0764110.00W		729										
MRA	MOCA	PUB	MAA	D/D/I	MEA(1)	DIRECTION(1)	MEA(2)	DIRECTION(2)	GNSS MEA				
2400	2200	N	17500						2400				
CODE	EIX MRA		EIX MCA		MTA								
					N								
SEGMENT REMARKS													
NEW ROUTE													
CHANGES-REASON													

+
-



FEDERAL AVIATION ADMINISTRATION  
FLIGHT STANDARDS SERVICE  
TRANSMITTAL OF AIRWAYS/ROUTES DATA RECORD

AIRWAY\_NO.or\_ROUTE  
TK502

ROUTINE or DOCKET NO  
10-AEA-20

FROM	STATE	FB/EO	IO	STATE	FB/EO	RNP	LEG TYPE		
GRIBL	PA	FB	TOLAN	NJ	FB		TF		
OBSTRUCTION	COORDINATES	ELEV.MSL	CONT.OBS	AC	ROC	ADJUSTMENTS			
TOWER	401658.00N/0744110.00W	1049	Y		1000				
TERRAIN	402215.00N/0744021.00W	365							
MRA	MOCA	PUB	MAA	D/D/I	MEA(1)	DIRECTION(1)	MEA(2)	DIRECTION(2)	GNSS MEA
2100	2100	N	17500						2100
CODE				EIX.MRA	EIX.MCA		MTA		N

+

-

SEGMENT REMARKS  
NEW ROUTE

CHANGES-REASON

FEDERAL AVIATION ADMINISTRATION  
FLIGHT STANDARDS SERVICE  
TRANSMITTAL OF AIRWAYS/ROUTES DATA RECORD

AIRWAY\_NO.or\_ROUTE  
TK502

ROUTINE or DOCKET NO  
10-AEA-20

FROM	STATE	FB	IO	STATE	FB/EO	RNP	LEG TYPE
TOLAN	NJ	FB	BALDE	NY	FB		TF
OBSSTRUCTION	COORDINATES	ELEV.MSL	CONT.OBS	AC	ROC	ADJUSTMENTS	
AAO	402357.00N/0741789.00W	420			1000		
TERRAIN	402357.00N/0741789.00W	220	Y				
MRA	MOCA	PUB	D/D/I	MEA(1)	DIRECTION(1)	MEA(2)	DIRECTION(2)
1500	1500	Y		17500			
CODE			EIX.MRA	EIX.MCA		MTA	N

+
-

SEGMENT REMARKS  
NEW ROUTE  
CHANGES-REASON

FEDERAL AVIATION ADMINISTRATION  
FLIGHT STANDARDS SERVICE  
TRANSMITTAL OF AIRWAYS/ROUTES DATA RECORD

AIRWAY\_NO.or\_ROUTE

TK502

ROUTINE or DOCKET NO

10-AEA-20

FROM	STATE	FB	IO	STATE	FB	RNP	LEG TYPE		
BALDE	NY	FB	SPATE	NY	FB		TF		
OBSTRUCTION	COORDINATES	ELEV.MSL	CONT.OBS	AC	ROC	ADJUSTMENTS			
AAO	403242.00N/0741206.00W	378			1000				
AAO	403242.00N/0741206.00W	178	Y						
MRA	MOCA	PUB	MAA	D/D/I	MEA(1)	DIRECTION(1)	MEA(2)	DIRECTION(2)	GSSS.MEA
1400	1400	Y	17500						2100
COE				EIX.MRA		EIX.MCA			MTA
									N

+
-

SEGMENT REMARKS

NEW ROUTE  
AT REQUESTED INCREASE TO 1400 ADDED 222 FT  
CHANGES-REASON

FEDERAL AVIATION ADMINISTRATION  
FLIGHT STANDARDS SERVICE  
TRANSMITTAL OF AIRWAYS/ROUTES DATA RECORD

AIRWAY\_NO.or\_ROUTE  
TK502

ROUTINE or DOCKET NO  
10-AEA-20

FROM	STATE	FB/EO	IO	STATE	FB/EO	RNP	LEG TYPE		
SPATE	NY	FB	DECKR	NY	FB		TF		
OBSTRUCTION	COORDINATES	ELEV.MSL	CONT.OBS	AC	ROC	ADJUSTMENTS			
TOWER	403604.41N/0740654.51W	727			1000				
TERRAIN	403618.00N/0740630.00W	424	Y						
MRA	MOCA	PUB	MAA	D/D/I	MEA(1)	DIRECTION(1)	MEA(2)	DIRECTION(2)	GNSS MEA
		N							
CODE					EIX.MRA	EIX.MCA			MTA N

+
-

SEGMENT REMARKS  
NEW ROUTE

CHANGES-REASON

FLIGHT CHECK	DATE	OFFICE	NAME
	PENDING		
APPROVED	DATE	OFFICE	TITLE
	MM/DD/YYYY	XXX-XXXX	MANAGER
			WILLIE B. MAYS for LISTER P. GOODBIE

**Section 8-9. Simultaneous Close Parallel (SCP) and Simultaneous Offset Instrument Approach (SOIA) Procedure Attention All Users Page (AAUP)**

**8-9-1. Attention All Users Page.** For SCP approach procedures (runways separated by less than 4300 feet), including SOIA, and for simultaneous RNAV departures, an AAUP must be published. The AAUP provides the flight crew with procedures that must be used when conducting these operations, in a form that may be reviewed prior to conducting the procedure.

**Note:** The flight crew will be notified when an AAUP is published via the following note, “See additional requirements on AAUP.” For an SCP approach, the note will appear in the associated IAP briefing strip. For an RNAV SID, the note will appear on the narrative page immediately beneath the Departure Route Description title.

**8-9-2. Site Implementation Team (SIT).** A SIT is normally established to address issues related to establishing the procedures. *If no team is established*, the FAA facility that provides ATC services for the airport at which the operations are to be conducted is responsible for the AAUP. The SIT is:

- a. Comprised of FAA and industry members with the team leadership designated by ATO.
- b. Responsible for the development, among other things, of an AAUP.

**8-9-3. AAUP preparation.** The AAUP must present the step-by-step procedures used to conduct the procedure. Develop the AAUP using the appropriate 8260-18 forms and the guidance provided in this section. See Order 8260.46 for Simultaneous RNAV Departure Operations.

**Note:** AAUP examples found in this section may not be the most current or not necessarily applicable to other locations. These examples should be used as a developmental guideline. AAUPs must reflect the requirements of the specific procedure and airport for which they are developed.

**8-9-4. AAUP processing.** The SIT (or applicable ATC facility) submits the draft AAUP through channels as applicable (that is, Service Areas may have a coordination process unique to their area). In the case of a departure AAUP, also submit the procedure to AJV-14 for comment. When completed, submit the procedure to Flight Standards’ Flight Operations Branch for approval and provide an information copy to the Performance-Based Flight Operations Branch. The Flight Operations Branch submits the AAUP and requested effective date to the NFDC.

**8-9-5. AAUP publication.** The originating organization will determine the required publication date; coordinate with Aeronautical Information Services/NFDC as necessary. After receiving the AAUP from the Flight Operations Branch, the NFDC will:

- a. Verify the applicability of the publication date and assign that date for publication.
- b. Coordinate with the Flight Operations Branch who will, in turn, contact the originating organization and Aeronautical Information Services should a change in the previously agreed upon date be required.

**Note:** When publishing a new AAUP in conjunction with a new or revised procedure, it is important that the AAUP be coordinated jointly between the originating organization, the NFDC, Aeronautical Information Services, and the Flight Operations Branch to ensure its publication is concurrent with the procedure(s) for which the AAUP was developed.

- c. Publish the AAUP in the NFDD.

**Note:** The NFDD is the source for AAUP information for publication by all chart producers.

**8-9-6. Forms processing.** This section provides procedural guidance for developing AAUPs utilized when independently conducting simultaneous close parallel approach operations to two or more runways. Use Form 8260-18, Approach Procedure Attention All Users Page, to document an Approach Procedure AAUP. Instructions and samples for Form 8260-18 are in this section. Use this form for AAUPs describing ILS PRM, LDA PRM, RNAV (GPS) PRM, RNAV (RNP) PRM, or GLS PRM approaches.

**Note:** PRM is published as part of the IAP approach title along with the words “Close Parallel” to identify IAPs used to conduct SCP approaches, including SOIA. PRM typically identifies independent operations to runways or approach courses spaced less than 4300 feet apart. However, based on a site specific evaluation, an AAUP (and PRM procedures) may also be required for widely spaced approaches when they are conducted as part of a triple or greater operation when one set of runways is closely spaced. See Order 8260.3, Appendix E, sections 1 and 2.

**8-9-7. Title line.** The title line consists of the following four elements and will be filled in as noted:

- a. City, State. Enter name of city and state abbreviation. For example: San Francisco, CA.
- b. Airport name and Airport ID. Enter airport name and ID as it is, or will be, published on the instrument approach procedure (All capital letters), e.g., SAN FRANCISCO INTL (SFO).

**Note:** NFDC, as the official source of airport IDs, will verify that the ID is correct.

- c. Effective date. The effective date for original and amended AAUPs is normally concurrent with the 56-day charting cycle and the date must be coordinated [see paragraphs 8-9-4 and 8-9-5]. If the AAUP publication date is associated with the publication date of an original procedure or a procedure amendment, enter that procedure name.

**Example:**

“Concurrent with ILS PRM RWY 1R (Orig).” or “Concurrent with RNAV (GPS) RWY 28L (Amdt 3).”

**8-9-8. Text.** AAUPs must reflect the requirements of the specific procedure and airport for which they are developed. Use this guidance and the AAUP examples found in this section as a developmental guideline for preparing the AAUP.

a. Pilot non-participant procedure. Enter the non-participant procedure applicable for the specific airport.

**Example:**

Pilots who are unable to participate will be afforded appropriate arrival services as operational conditions permit and must notify the controlling ARTCC as soon as practical, but at least 100 NM from destination.

**Note:** The AAUP does not have to list the participation requirements because the AAUP is designed to remind the qualified pilot as to the procedures to be used when conducting the approach. Examples of reasons that pilots may not be able to participate include on-board equipment failure (no glideslope or no second communications receiver) or because they do not have the required training. Pilots determine whether they are qualified to conduct the approach through their OpSpecs for commercial operators or through the AIM for general aviation (GA) pilots.

b. Procedure name(s). Enter name of the PRM procedures, e.g., ILS PRM RWY 28L, RNAV (GPS) PRM RWY 28L, RNAV (RNP) PRM RWY 28L. If all PRM approaches utilize the same procedures, enter them all on one line. Otherwise, utilize one line for each approach or sets of approaches that utilize the same procedures, accompanied by their specific briefing points. Only published IAPs are named on the AAUP.

c. Briefing points (required briefing). This consists of a summation of the major tasks in which they are to be conducted, that are required to execute the approach(es). For example, "Listen to the PRM monitor (frequency 125.15) when communicating with the NORCAL approach control (frequency 135.65), no later than final approach course intercept." One or more briefing points may be published for each approach. If all briefing points are applicable to a group or all approaches, the briefing points need only be listed once with the applicable runways listed above.

**Note:** In the case of the SOIA offset approach where the charted missed approach point and the FMS-coded missed approach point are not collocated, the briefing points should include information as to what the differences are and how the missed approach is to be conducted. See the SFO AAUP in the examples section below.

d. Expanded procedures (optional, brief if necessary). This section explains in greater detail procedures used to conduct PRM approaches. It consists of the following six elements and will be filled out as noted. Paragraphs 8-9-8.d(1), 8-9-8.d(2), and 8-9-8.d(3) are mandatory. Paragraph 8-9-8.d(4) is applicable for SOIA or other PRM approaches as noted. For SOIA, include paragraph 8-9-8.d(5)(a) for the offset SOIA approach and paragraph 8-9-8.d(5)(b) for straight-in SOIA approach. Paragraph 8-9-8.d(6), Additional Airport Information may be added as necessary. Below are descriptions for each element identified:

(1) ATIS. This element discusses the information that will be transmitted by the ATIS. Based on the ATIS, guidance is provided as to how the approach is to be briefed, and how the approach can be flown using the PRM approach plate when simultaneous operations are not being conducted:

(a) Normally identical approaches will be published both as a PRM approach and as a non-PRM identical approach. To be considered identical, approaches using the same type of navigation (ILS or LDA or RNAV for example), must contain the same fixes, fix crossing altitudes, the same approach minimums and coincident missed approach procedures. **Examples:** RNAV (GPS) PRM Rwy 28L and RNAV (GPS) Rwy 28L; ILS PRM Rwy 8L and ILS Rwy 8L; LDA PRM Rwy 28R and LDA Rwy 28R.

(b) When a PRM and identical non-PRM approaches are both published the ATIS portion of the AAUP is written as shown in the following example:

“ATIS. When the ATIS broadcast advises that simultaneous [type] PRM approaches are in progress, pilots should brief to fly the PRM approach. If later advised to expect the non-PRM approach, the PRM chart may be used after completing the following briefing items:

- Minimums and missed approach procedures are unchanged,
- Monitor frequency no longer required, and
- A lower glide slope intercept altitude may be assigned when advised to expect the non-PRM approach.”

**Note:** If the simultaneous procedure operation associated with the AAUP, such as SOIA, requires a specified ceiling and visibility, include that information. For example, “Simultaneous parallel approaches will only be offered/conducted when the weather is at least 1600 feet (ceiling) and 4 SM (visibility).”

(2) Dual VHF Communications Required. The procedures for use of the PRM monitor frequency are described. Dual communication capability avoids single frequency blocked transmissions by providing an additional communications path by which the no transgression zone (NTZ) monitor controller can issue breakout or other instructions to the pilots.

(3) All “breakouts” are to be hand flown. This element describes pilot procedures when receiving a “breakout instruction.” It also reminds the pilot of the language that the ATC monitor controller will use to instruct the pilot to initiate a “breakout” maneuver.

(4) Glide Path Navigation. This element contains information about descending on the glide path.

**Note 1:** Specifically for SOIA operations, describe procedures for flying the glide path of the straight-in SOIA approach [ILS PRM or RNAV (GPS) PRM or RNAV (RNP) PRM].

**Example (for straight-in runway 28L):**

Descending on (not above) the glide path ensures compliance with any charted crossing restrictions and assists traffic approaching runway 28R to mitigate possible wake turbulence encounters without destabilizing the runway 28R approach and creating a go-around.

**Example (when the applicable temperature correction has not been applied):**

Descending on (not above) the glide path assists traffic approaching runway 28R to mitigate possible wake turbulence encounters without destabilizing the runway 28R approach and creating a go-around.



**Note 2:** When the applicable temperature correction has been applied, describe procedures for flying the glide path when conducting a PRM approach utilizing an electronic glide slope (ILS PRM and LDA PRM).

**Example:**

Descending on the glide path ensures compliance with any charted crossing restrictions.

(5) SOIA-specific notes.

(a) (APT ID) LDA PRM, RNAV (GPS) PRM, RNAV (RNP) PRM Visual Segment. This note is applicable only to the *offset* approach in SOIA. It describes pilot procedures to be used in the visual segment of the approach between the DA and the runway threshold.

**Example:**

Visual Segment (Rwy 28R): If ATC advises that there is traffic approaching runway 28L, pilots are authorized to continue past DARNE to align with runway 28R centerline only when the runway 28L traffic is in sight and is expected to remain in sight; ATC has been advised that "traffic is in sight" (ATC is not required to acknowledge this transmission), and the runway environment is in sight.

Otherwise, a missed approach must be executed at DARNE. Between DARNE and the runway threshold, pilots are responsible for separating themselves visually from traffic approaching runway 28L, which means maneuvering the aircraft as necessary to avoid the runway 28L traffic until landing (do not pass), and providing wake turbulence avoidance, as applicable. If visual contact with the runway 28L traffic is lost, advise ATC as soon as practical and execute the published missed approach unless otherwise instructed by ATC.

(b) Runway (Runway number associated with SOIA straight-in PRM approach) traffic. This note applies only to a SOIA straight-in approach. It describes for the pilot landing straight-in how the trailing aircraft conducting the offset approach will maneuver while executing the runway alignment maneuver after passing the DA.

**Example:**

While conducting this ILS PRM or RNAV (GPS) PRM approach to runway 28L, other aircraft may be conducting the offset LDA PRM or RNAV (GPS) PRM approach to runway 28R. These aircraft will approach from the right-rear and will re-align with runway 28R after making visual contact with the ILS or RNAV (GPS) runway 28L traffic.

(6) Additional airport information. (Specific Guidance, If Applicable): Other information may be included that is deemed pertinent for pilot review before conducting the approach.

**8-9-9. Administrative information.** Items below are for informational and administrative purposes only. These items are to be completed on the forms and not to be published on the AAUP. A blank Form 8260-18 is available on the FAA website.

- a.** Developed by. Enter the name of the person responsible for producing the AAUP. This individual must sign in the “developed by” space, and enter the date signed. Enter the office or function of the person responsible, such as ATL TRACON or ATL SIT.
- b.** Approved by. Specify the office/organization that approved the AAUP.
- c.** Coordinated with. Specify the offices/organizations with which to coordinate the AAUP. Always include the RAPT and the Flight Operations Branch.
- d.** Changes (for revised AAUPs)/Reasons (for initial or revised AAUPs). List changes and reasons relating to AAUP entries.

The following are samples to assist in developing the proposed approach AAUP forms for coordination and publication.

**Figure 8-9-1. Sample #1 of Form 8260-18**

**FEDERAL AVIATION ADMINISTRATION  
FLIGHT STANDARDS SERVICE  
SIMULTANEOUS CLOSE PARALLEL - PRM  
ATTENTION ALL USERS PAGE (AAUP)**

---

<b>City, State</b>	<b>Airport</b>	<b>Effective Date</b> <input type="text" value="MM/DD/YYYY"/>
DETROIT, MI	DETROIT METROPOLITAN WAYNE COUNTY (DTW)	MM/DD/YYYY

---

**ATTENTION ALL USERS PAGE (AAUP)**

---

**PILOT NON-PARTICIPANT PROCEDURE:**

Pilots who are unable to participate will be afforded appropriate arrival services as operational conditions permit and must notify the controlling ARTCC as soon as practical, but at least 100 NM from destination.

**Required Briefing:**

Brief the appropriate procedure briefing points below based on the expected or assigned IAP.

+    -

**PROCEDURE NAME(S):**

ILS PRM Rwy's 3R, 4R, 21L, 22L

**Briefing Points:**

1. When in range, tune in the PRM monitor frequency audio and set the volume on a secondary radio, then de-select the audio until switched to the tower frequency.
2. When instructed, immediately switch to the tower frequency and select the monitor frequency audio.
3. Descending on the ILS glide slope ensures compliance with any charted crossing restrictions.

**PROCEDURE NAME(S):**

ILS PRM Rwy's 22R

**Briefing Points:**

1. When in range, tune in the PRM monitor frequency audio and set the volume on a secondary radio, then de-select the audio until switched to the tower frequency.
2. When instructed, immediately switch to the tower frequency and select the monitor frequency audio.
3. Descending on the ILS glide slope ensures compliance with any charted crossing restrictions.
4. Exit the runway at Taxiway A4 (6700 ft) or A3 (7700 ft), whenever practical.
5. Whenever possible, do not stop on taxiway A between taxiway A3 and taxiway Q, due to offset LOC critical area.

**PROCEDURE NAME(S):**

ILS PRM Y Rwy 4L

**Briefing Points:**

1. When in range, tune in the PRM monitor frequency audio and set the volume on a secondary radio, then de-select the audio until switched to the tower frequency.
2. When instructed, immediately switch to the tower frequency and select the monitor frequency audio.
3. Descending on the ILS glide slope ensures compliance with any charted crossing restrictions.
4. Exit the runway at Taxiway A7 (6700 ft) or A8 (7700 ft), whenever practical.
5. Whenever possible, do not stop on taxiways A9 and A10 or on taxiway A northwest of taxiway V, due to the offset LOC critical area.

**EXPANDED PROCEDURES:** (Optional, brief if necessary)

1. ATIS. When the ATIS broadcast advises that simultaneous ILS PRM approaches are in progress, pilots should brief to fly the ILS PRM approach. If later advised to expect an ILS approach, the ILS PRM chart may be used after noting the following:

FEDERAL AVIATION ADMINISTRATION  
FLIGHT STANDARDS SERVICE  
SIMULTANEOUS CLOSE PARALLEL - PRM  
ATTENTION ALL USERS PAGE (AAUP)

City, State	Airport	Effective Date
DETROIT, MI	DETROIT METROPOLITAN WAYNE COUNTY (DTW)	MM/DD/YYYY

a. Minimums and missed approach procedures are unchanged.  
b. Monitor frequency no longer required.  
c. A lower glide slope intercept altitude may be assigned when advised to expect an ILS approach.

2. Dual VHF Communication required. To avoid blocked transmissions, each runway will have two frequencies, a primary and a PRM monitor frequency. The tower controller will transmit on both frequencies. The PRM Monitor controller's transmissions, if needed, will override both frequencies. Pilots will ONLY transmit on the tower controller's frequency, but will listen to both frequencies. When practical, on a second communications radio, select the PRM monitor frequency. Set the audio level to about the same volume as the primary communication radio so that transmissions on the PRM monitor frequency can be heard in the event the tower frequency is blocked. Then, de-select the PRM monitor audio. When instructed by ATC to contact the tower, reselect the PRM monitor frequency audio.

3. All "Breakouts" are to be hand flown to assure that the maneuver is accomplished in the shortest amount of time. Pilots, when directed by ATC to break off an approach, must assume that an aircraft is blundering toward their course and a breakout must be initiated immediately.

a. ATC Directed "Breakouts": ATC directed breakouts will consist of a turn and a climb or descent. Pilots must always initiate the breakout in response to an air traffic controller instruction. Controllers will give a descending breakout only when there are no other reasonable options available, but in no case will the descent be below minimum vectoring altitude (MVA) which provides at least 1,000 feet required obstruction clearance.

b. Phraseology - "TRAFFIC ALERT": If an aircraft enters the "NO TRANSGRESSION ZONE (NTZ)," the controller will breakout the threatened aircraft on the adjacent approach. The phraseology for the breakout will be: "TRAFFIC ALERT, (aircraft call sign) TURN (left/right) IMMEDIATELY, HEADING (degrees), CLIMB/DESCEND AND MAINTAIN (altitude)."

ADMINISTRATIVE INFORMATION: (Do Not Publish)

<b>Developed By:</b>	<b>Office Symbol:</b>	<b>Date:</b>
<input type="text"/>	<input type="text"/>	<input type="text"/>

<b>Approved By:</b>	<b>Office Symbol:</b>	<b>Date:</b>
<input type="text"/>	<input type="text"/>	<input type="text"/>

**Coordinated With:** RAPT, AJV, and Flight Operations Branch

**Changes-Reasons:** N/A - NEW PROCEDURE

Figure 8-9-2. Sample #2 of Form 8260-18

FEDERAL AVIATION ADMINISTRATION  
FLIGHT STANDARDS SERVICE  
SIMULTANEOUS CLOSE PARALLEL - PRM  
ATTENTION ALL USERS PAGE (AAUP)

City, State	Airport	Effective Date
ATLANTA, GA	ATLANTA/HARTSFIELD-JACKSON ATLANTA INTL (KATL)	TO BE COORDINATED

**ATTENTION ALL USERS PAGE (AAUP)**

**PILOT NON-PARTICIPANT PROCEDURE:**

Pilots who are unable to participate will be afforded appropriate arrival services as operational conditions permit and must notify the controlling ARTCC as soon as practical, but at least 100 NM from destination.

**Required Briefing:**

Brief the briefing points.

+	-
---	---

**PROCEDURE NAME(S):**

ILS PRM Rwy's 8L, 8R, 9L, 9R, 10, 26L, 26R, 27L, 27R, 28

**Briefing Points:**

1. When in range, tune in the PRM monitor frequency on a secondary radio, set the audio volume, then de-select the audio until switched to the tower frequency. If no communications are heard on the PRM frequency, set the volume by tuning to another frequency (i.e., the ATIS) to verify functionality of secondary radio, and return to the PRM monitor frequency.
2. When instructed to switch to the tower frequency, select the PRM monitor frequency audio on.
3. Descending on the ILS glide slope ensures compliance with any charted crossing restrictions.

**EXPANDED PROCEDURES:** (Optional, brief if necessary)

1. ATIS. When the ATIS broadcast advises that simultaneous ILS PRM approaches are in progress, pilots should brief to fly the ILS PRM approach. If later advised to expect an ILS approach, the ILS PRM chart may be used after noting the following.
  - a. Minimums and missed approach procedures are unchanged.
  - b. Monitor frequency no longer required.
  - c. A lower glide slope intercept altitude may be assigned when advised to expect an ILS approach.
2. Dual VHF Communication required. To avoid blocked transmissions, each runway will have two frequencies, a tower, and a PRM monitor frequency. The PRM Monitor controller's transmissions, if needed, will override both frequencies. Pilots will ONLY transmit on the tower controller's frequency, but will listen to both frequencies. When in range, on a second communications radio, select the PRM monitor frequency. Set the audio level to about the same volume as the primary communication radio so that transmissions on the PRM monitor frequency can be heard in the event the tower frequency is blocked. Then, de-select the PRM monitor audio. When instructed by ATC to contact the tower, reselect the PRM monitor frequency audio.
3. All "Breakouts" are to be hand flown to assure that the maneuver is accomplished in the shortest amount of time. Pilots, when directed by ATC to break off an approach, must assume that an aircraft is blundering toward their course and a breakout must be initiated immediately.
  - a. ATC Directed "Breakouts": ATC directed breakouts will consist of a turn and a climb or descent. Pilots must always initiate the breakout in response to an air traffic controller instruction. Controllers will give a descending breakout only when there are no other reasonable options available, but in no case will the descent be below minimum vectoring altitude (MVA) which provides at least 1,000 feet required obstruction clearance.
  - b. Phraseology - "TRAFFIC ALERT": If an aircraft enters the "NO TRANSGRESSION ZONE (NTZ)," the controller will breakout the threatened aircraft on the adjacent approach. The phraseology for the breakout will be:  

"TRAFFIC ALERT, (aircraft call sign) TURN (left/right) IMMEDIATELY, HEADING (degrees), CLIMB/DESCEND AND MAINTAIN (altitude)."

FEDERAL AVIATION ADMINISTRATION  
FLIGHT STANDARDS SERVICE  
SIMULTANEOUS CLOSE PARALLEL - PRM  
ATTENTION ALL USERS PAGE (AAUP)

City, State	Airport	Effective Date
ATLANTA, GA	ATLANTA/HARTSFIELD-JACKSON ATLANTA INTL (KATL)	TO BE COORDINATED

**ADMINISTRATIVE INFORMATION:** (Do Not Publish)

**Developed By:** \_\_\_\_\_ **Office Symbol:** \_\_\_\_\_ **Date:** \_\_\_\_\_

**Approved By:** \_\_\_\_\_ **Office Symbol:** \_\_\_\_\_ **Date:** \_\_\_\_\_

**Coordinated With:** RAPT, AJV, Delta Air Lines, and Flight Operations Branch

**Changes-Reasons:** Updated wording in "briefing points" and in "Dual VHF Communication required" sections because of revised communication procedures. Deleted the sentence, "The tower controller will transmit on both frequencies." - Requested by ATL TRACON and by primary user.

Figure 8-9-3. Sample #3 of Form 8260-18

FEDERAL AVIATION ADMINISTRATION  
FLIGHT STANDARDS SERVICE  
SIMULTANEOUS CLOSE PARALLEL - PRM  
ATTENTION ALL USERS PAGE (AAUP)

City, State	Airport	Effective Date
SAN FRANCISCO, CA	SAN FRANCISCO INTL (KSFO)	MM/DD/YYYY

**ATTENTION ALL USERS PAGE (AAUP)**

**PILOT NON-PARTICIPANT PROCEDURE:**

Pilots who are unable to participate will be afforded appropriate arrival services as operational conditions permit and must notify the controlling ARTCC as soon as practical, but at least 100 NM from destination.

**Required Briefing:**

Brief the appropriate procedure briefing points below based on the expected or assigned IAP.

+	-
---	---

**PROCEDURE NAME(S):**

ILS PRM Rwy 28L

**Briefing Points:**

1. When in range, tune in the PRM monitor frequency (125.15) on a secondary radio and set the audio volume, then de-select the audio.
2. Re-select the PRM monitor frequency when communicating with the NORCAL approach control (frequency 135.65).
3. Utilize glidepath; do not step down between fixes after passing ROKME.
4. Descending on the glidepath ensures compliance with any charted crossing restriction. Inside NEPIC (I-SFO 5.3 DME), descending on (not above) the glidepath benefits the trailing 28R aircraft to avoid wake turbulence.
5. While conducting the PRM approach to runway 28L, other aircraft may be conducting the PRM approach to runway 28R. These aircraft will approach from the right-rear and will re-align with runway 28R after making visual contact with the runway 28L traffic.
6. Expect to be switched to SFO tower (120.5) at NEPIC (I-SFO 5.3 DME).
7. PRM monitor frequency may be de-selected after determining that the aircraft is on the tower frequency.

**PROCEDURE NAME(S):**

LDA PRM Rwy 28R

**Briefing Points:**

Note: Non-standard Missed Approach coding initially requires use of heading mode. Identify DARNE as I-FNP LOC 4 NM if not in the FMC approach coding.

1. If required, develop a wake mitigation strategy as soon as practical. After passing DARNE, pilots will be operating in close proximity to the 28L aircraft and will be responsible for wake turbulence avoidance.
2. When in range, tune in the PRM monitor frequency (127.675) on a secondary radio and set the audio volume, then deselect the audio.
3. Re-select the PRM monitor frequency when communicating with the NORCAL approach control (frequency 120.35).
4. Utilize glidepath; do not step down between fixes after passing HEGOT.
5. Descending on the glidepath ensures compliance with any charted crossing restrictions.
6. Report the 28L traffic in sight as soon as practical and prior to DARNE (I-FNP 4.0 DME). DO NOT PASS.
7. Remain on the LDA until passing DARNE so as not to penetrate the NTZ.
8. Expect to be switched to SFO tower (120.5) at DARNE (I-FNP 4.0 DME).
9. PRM monitor frequency may be de-selected after determining that the aircraft is on the tower frequency.
10. After passing DARNE, MANEUVER VISUALLY.
11. In the visual segment after DARNE, pilots are responsible for collision and wake avoidance. (See Visual Segment under Expanded Procedures for additional information).
12. If executing a go-around between DARNE runway 28R, initially establish a climbing right turn heading 030° unless otherwise instructed by ATC. Missed approach leg from airport to OAK VORTAC, if depicted on a map display, is for

**FEDERAL AVIATION ADMINISTRATION  
FLIGHT STANDARDS SERVICE  
SIMULTANEOUS CLOSE PARALLEL - PRM  
ATTENTION ALL USERS PAGE (AAUP)**

City, State	Airport	Effective Date
SAN FRANCISCO, CA	SAN FRANCISCO INTL (KSFO)	MM/DD/YYYY

reference only. Follow IAP published missed approach procedure unless otherwise instructed by ATC.

**PROCEDURE NAME(S):**

RNAV (GPS) PRM Rwy 28L

**Briefing Points:**

Note: Identify NEPIC WP as 3.3 NM from Rwy 28L WP if not in the FMC approach coding.

1. When in range, tune in the PRM monitor frequency (125.15) on a secondary radio and set the audio volume, then des-select the audio.
2. Re-select the PRM monitor frequency when communicating with the NORCAL approach control (frequency 135.65).
3. If practical, utilize constant descent angle after passing ROKME WP.
4. Monitor descent path to ensure that fix crossing requirements are adhered to.
5. VDA is 2.85° between all waypoints on the final approach course.
6. Inside NEPIC descending on (not above) the vertical path benefits the trailing 28R aircraft to avoid wake turbulence.
7. While conducting the PRM approach to runway 28L, other aircraft may be conducting the PRM approach to runway 28R. These aircraft will approach from the right-rear and will re-align with runway 28R after making visual contact with the runway 28L traffic.
8. Expect to be switched to SFO tower (120.5) at NEPIC WP, 3.3 NM from Rwy 28L WP.
9. PRM monitor frequency may be de-selected after determining that the aircraft is on the tower frequency.

**PROCEDURE NAME(S):**

RNAV (GPS) PRM X Rwy 28R

**Briefing Points:**

Note: Non-standard RNAV Missed Approach coding initially requires use of heading mode. Identify DARNE WP as 3.4 NM from CFFKC WP if not in the FMC approach coding.

1. If required, develop a wake mitigation strategy as soon as practical. After passing DARNE WP, pilots will be operating in close proximity to the 28L aircraft and will be responsible for wake turbulence avoidance.
2. When in range, tune in the PRM monitor frequency (127.675) on a secondary radio and set the audio volume, then de-select the audio.
3. Re-select the PRM monitor frequency when communicating with the NORCAL approach control (frequency 120.35).
4. If practical, utilize constant descent angle after passing HEGOT WP.
5. Monitor descent path to ensure that fix crossing requirements are adhered to.
6. VDA is 3° between all waypoints on the final approach course.
7. Report the 28L traffic in sight as soon as practical and prior to DARNE. DO NOT PASS.
8. Remain on the RNAV track until passing DARNE WP, so as not to penetrate the NTZ.
9. Expect to be switched to SFO tower (120.5) at DARNE WP, 3.4 NM from CFFKC WP.
10. After passing DARNE, MANEUVER VISUALLY.
11. The VNAV path is valid to the runway threshold.
12. PRM monitor frequency may be de-selected after determining that the aircraft is on the tower frequency.
13. In the visual segment after DARNE, pilots are responsible for collision and wake avoidance. (See Visual Segment under Expanded Procedures for additional information).
14. If executing a missed approach or go-around, initially establish a climbing right turn heading 030°. Caution: Missed approach leg from airport to OAK VORTAC, if depicted on a map display, is for reference only. Follow IAP published missed approach procedure unless otherwise instructed by ATC.

**EXPANDED PROCEDURES:** (Optional, brief if necessary)

1. ATIS. When the ATIS broadcast advises that simultaneous PRM Rwy 28L and PRM Rwy 28R approaches are in progress, pilots should brief to fly the PRM approach. If later advised to expect an ILS, LDA or RNAV (GPS) approach, the PRM chart may be used after noting the following:
  - a. Minimums and missed approach procedures are unchanged.
  - b. Monitor frequency no longer required.



**FEDERAL AVIATION ADMINISTRATION  
FLIGHT STANDARDS SERVICE  
SIMULTANEOUS CLOSE PARALLEL - PRM  
ATTENTION ALL USERS PAGE (AAUP)**

City, State	Airport	Effective Date
SAN FRANCISCO, CA	SAN FRANCISCO INTL (KSFO)	MM/DD/YYYY

c. A different glidepath or VNAV path intercept altitude may be assigned when advised to expect ILS, LDA or RNAV (GPS) approach.

Simultaneous parallel approaches will only be offered/conducted when the weather is at least 1600 feet (ceiling) and 4 SM (visibility).

2. Dual VHF Communication required (Rwy 28R). To avoid blocked transmissions, each runway will have two frequencies, a primary, and a PRM monitor frequency. The NORCAL approach controller will transmit on both frequencies. The PRM Monitor controller's transmissions, if needed, will override both frequencies. Pilots will ONLY transmit on the approach controller's frequency, but will listen to both frequencies. When practical, on a second communications radio, select the PRM monitor frequency. Set the audio level to about the same volume as the primary communications radio so that transmissions on the

PRM monitor frequency can be heard in the event the approach control frequency is blocked. Then deselect the PRM monitor audio. Re-select the PRM monitor frequency audio only when in contact with the NORCAL approach controller (120.35).

Dual VHF Communication required (Rwy 28L). To avoid blocked transmissions, each runway will have two frequencies, a primary, and a PRM monitor frequency. The NORCAL approach controller will transmit on both frequencies. The PRM Monitor controller's transmissions, if needed, will override both frequencies. Pilots will ONLY transmit on the approach controller's frequency, but will listen to both frequencies. When practical, on a second communications radio, select the PRM monitor frequency. Set the audio level to about the same volume as the primary communications radio so that transmissions on the PRM monitor frequency can be heard in the event the approach control frequency is blocked. Then deselect the PRM monitor audio. Re-select the PRM monitor frequency audio only when in contact with the NORCAL approach controller (135.65).

3. All "Breakouts" are to be hand flown to assure that the maneuver is accomplished in the shortest amount of time. Pilots, when directed by ATC to break off an approach, must assume that an aircraft is blundering toward their course and a breakout must be initiated immediately.

a. ATC Directed "Breakouts": ATC directed breakouts will consist of a turn and a climb or descent. Pilots must always initiate the breakout in response to an air traffic controller instruction. Controllers will give a descending breakout only when there are no other reasonable options available, but in no case will the descent be below minimum vectoring altitude (MVA) which provides at least 1,000 feet required obstruction clearance.

b. Phraseology - "TRAFFIC ALERT": If an aircraft enters the "NO TRANSGRESSION ZONE (NTZ)," the controller will breakout the threatened aircraft on the adjacent approach. The phraseology for the breakout will be:

"TRAFFIC ALERT, (aircraft call sign) TURN (left/right) IMMEDIATELY, HEADING (degrees), CLIMB/DESCEND AND MAINTAIN (altitude)."

4. Visual Segment (Rwy 28R): If ATC advises that there is traffic approaching runway 28L, pilots are authorized to continue past DARNE to align with runway 28R centerline only when:

- a. The runway 28L traffic is in sight and is expected to remain in sight.
- b. ATC has been advised that "traffic is in sight." (ATC is not required to acknowledge this transmission.)
- c. The runway environment is in sight.

Otherwise, a missed approach must be executed at DARNE. Between DARNE and the runway threshold, pilots are responsible for separating themselves visually from traffic approaching runway 28L, which means maneuvering the aircraft as necessary to avoid the runway 28L traffic until landing (do not pass), and providing wake turbulence avoidance, as applicable. If visual contact with the runway 28L traffic is lost, advise ATC as soon as practical and execute the published missed approach unless otherwise instructed by ATC.

**ADMINISTRATIVE INFORMATION:** (Do Not Publish)

<b>Developed By:</b>	<b>Office Symbol:</b>	<b>Date:</b>
<input type="text"/>	<input type="text"/>	<input type="text"/>

<b>Approved By:</b>	<b>Office Symbol:</b>	<b>Date:</b>
<input type="text"/>	<input type="text"/>	<input type="text"/>

**Coordinated With:**

**FEDERAL AVIATION ADMINISTRATION  
FLIGHT STANDARDS SERVICE  
SIMULTANEOUS CLOSE PARALLEL - PRM  
ATTENTION ALL USERS PAGE (AAUP)**

---

City, State	Airport	Effective Date <input type="text"/>
SAN FRANCISCO, CA	SAN FRANCISCO INTL (KSFO)	MM/DD/YYYY

**Changes-Reasons:** N/A - NEW PROCEDURE

## Appendix A. Administrative Information

- 1. Distribution.** This order is distributed electronically only.
- 2. Terms, definitions, and acronyms.** For the purpose of this order, flight procedures are identified as the functions for predetermining safe and practical methods of navigating aircraft that prescribe intended flight tracks, operational altitudes, and arrival/departure minimums. Flight procedures are subdivided into six general categories as follows: departure procedure, en route, instrument approach, missed approach, holding, and fix descriptions. The following words have the meaning shown:
  - a. May. Action is permissible.
  - b. Must. Action is mandatory.
  - c. Service providers. Any organization, company, or person who develops and/or maintains instrument flight procedures.
  - d. Should. Action is desirable.
  - e. Will. Indicated a presumption that action is to be taken.
- 3. Acronyms and abbreviations.** Users of this order can refer to appendix A table 1 for an alphabetical listing of frequently used acronyms and abbreviations:

**Table 1. Acronyms and Abbreviations**

AAO	Adverse assumption obstacle
AAUP	Attention All Users Page
AC	Advisory Circular
ADF	Automatic direction finder
ADP	Automatic data processing
AF	Airway Facilities
AFSS	Automated Flight Service Station
AGL	above ground level
AIM	Aeronautical Information Manual
AIP	Aeronautical Information Publication
AIP	Airport Improvement Program
ALS	Approach light system
AOA	airborne obstacle assessment
AOP	NAS Operations Program

AP	Autopilot
APO	Aviation policy and plans
APV	approach with vertical guidance
AR	Authorization Required
ARA	airborne radar approach
ARC	Airport Reference Code
ARDH	achieved reference datum height
ARP	airport reference point
ARSR	air route surveillance radar
ARTCC	Air Route Traffic Control Center
ARTS	Automated Radar Terminal System
ASAT	Airspace Simulation Analysis Tool
ASIP	Airspace System Inspection Pilot
ASOS	Automated Surface Observing System

ASR	airport surveillance radar
ATC	Air Traffic Control
ATD	along track distance
ATIS	Automatic Terminal Information Service
ATNS	Air Traffic Noise Screening Model
ATO	Air Traffic Organization
ATRK	along-track
ATS	Air Traffic Service
AWO	All Weather Operations
AWOS	Automated Weather Observing System
BaroVNAV	Barometric vertical navigation
BC	back course
CA	course-to-altitude
CAT	category
CCW	counter-clockwise
CF	course-to-fix
CFR	Code of Federal Regulations
CG	climb gradient
CGTA	climb gradient termination altitude
CHDO	Certificate Holding District Office
CIP	capital investment plan
CL	course line
CMO	Certificate Management Office
CNF	computer navigation fix
CONUS	continental United States
COP	changeover point
CRC	cyclic redundancy check
CRM	collision risk model
CW	clockwise
CY	calendar year
DA	decision altitude
DEM	digital elevation model

DER	departure end of runway
DF	direct-to-fix
DG	descent gradient
DH	decision height
DMA	designated mountainous area
DME	distance measuring equipment
DOC	Department of Commerce
DoD	Department of Defense
DOF	digital obstruction file
DOT	Department of Transportation
DP	departure procedure
DR	dead reckoning
DRP	departure reference point
DTED	digital terrain elevation data
dTPP	digital Terminal Procedure Publication
EAS	En Route Automation System
ELSO	equivalent lateral spacing operations
EOVM	emergency obstruction video map
ESA	emergency safe altitude
ESV	expanded service volume
FAA	Federal Aviation Administration
FAC	final approach course
FAF	final approach fix
FAP	final approach point
FAS	final approach segment
FATO	final approach takeoff area
FB	fly-by
FCC	Federal Communications Commission
FD	Flight Director
FDC	Flight Data Center
FIFO	Flight Inspection Field Office

FI/P	Flight Information/Permanent
FI/T	Flight Information/Temporary
FL	flight level
FMA	final monitor air
FMC	flight management computer
FMO	Frequency Management Office
FMS	Flight Management System
FO	fly-over
FPAP	flight path alignment point
FPCP	flight path control point
FPT	Flight Procedures Team
FSDO	Flight Standards District Office
FSS	Flight Service Station
FTIP	foreign terminal instrument procedure
FTP	fictitious threshold point
FV	Flight Validation
FY	fiscal year
GA	general aviation
GBAS	Ground Based Augmentation System
GCA	ground controlled approach
GLS	GBAS Landing System
GNSS	Global Navigation Satellite System
GP	glidepath
GPA	glidepath angle
GPI	ground point of intercept
GPS	Global Positioning System
GOA	ground obstacle assessment
GS	glide slope
HAA	height above airport
HAE	height above ellipsoid
HAL	height above landing area elevation

HAS	height above surface
HAT	height above touchdown
HCH	Heliport Crossing Height
HF	high frequency
HMAS	height of missed approach surface
HUD	heads-up display
HUR	high update radar
IAC	initial approach course
IACC	Interagency Air Cartographic Committee
IAF	initial approach fix
IAP	instrument approach procedure
IAPA	Instrument Approach Procedure Automation
IFP	instrument flight procedures
IFPV	instrument flight procedure validation
IC	intermediate course
ICAO	International Civil Aviation Organization
IF	initial fix (RNAV)
IF	intermediate fix
IFP	instrument flight procedure
IFR	instrument flight rules
ILS	Instrument Landing System
IM	inner marker
INT	intersection
IPDS	Instrument Procedure Development System
IRU	inertial reference unit
ISA	International Standard Atmosphere
KIAS	knots indicated airspeed
KTAS	knots true airspeed
LDA	localizer type directional aid
LF	low frequency
LNAV	lateral navigation

LOA	letter of agreement
LOB	line of business
LOC	localizer
LOM	locator outer marker
LP	localizer performance (without vertical guidance)
LPV	localizer performance with vertical guidance
LTP	landing threshold point
MAA	maximum authorized altitude
MAH	missed approach hold
MALS	Medium intensity approach lighting system
MALSF	medium intensity approach lighting system with sequenced flashing
MALSR	medium intensity approach lighting system with runway alignment indicator lights
MAP	missed approach point
MCA	minimum crossing altitude
MDA	minimum descent altitude
MEA	minimum en route altitude
MHA	minimum holding altitude
MIA	minimum IFR altitude
MSL	mean sea level
MM	middle marker
MOA	memorandum of agreement
MOA	military operations area
MOC	minimum obstacle clearance
MOCA	minimum obstruction clearance altitude
MRA	minimum reception altitude
MSA	minimum safe/sector altitude
MSL	mean sea level
MT	mountainous terrain
MTA	minimum turning altitude
MV	magnetic variation

MVA	minimum vectoring altitude
MVAC	minimum vectoring altitude chart
NA	not authorized
N/A	not applicable
NAD	North American Datum
NAET	National Aircraft Evaluation Team
NAPT	National Airspace and Procedures Team
NAS	National Airspace System
NASR	National Airspace System Resources
NAVAID	navigational aid
NAVD	North American Vertical Datum
NCP	NAS Change Proposal
NDB	non-directional radio beacon
NES	NOTAM entry system
NFD	National Flight Database
NFDC	National Flight Data Center
NFDD	National Flight Data Digest
NGA	National Geospatial-Intelligence Agency
NGDC	National Geophysical Data Center
NGS	National Geodetic Survey
NM	nautical mile
NOAA	National Oceanic & Atmospheric Administration
NoPT	No procedure turn
NOS	National Ocean Service
NOTAM	Notices to Airmen
NPRM	Notice of Proposed Rulemaking
NTAP	Notices to Airmen Publication
NTS	NOTAM tracking system
OC	obstruction chart
OCA	obstacle clearance altitude

OCS	obstacle clearance surface
ODP	obstacle departure procedure
OE	obstacle evaluation
OFA	obstacle free area
OIS	obstacle identification surface
OM	outer marker
OpSpecs	operation specifications
OSV	operational service volume
PA	precision approach
PAOA	Parallel Approach Obstruction Assessment
PAPI	precision approach path indicator
PAR	precision approach radar
PBN	Performance Based Navigation
PCG	positive course guidance
PCL	pilot controlled lighting
PEP	procedure evaluation pilot
PFAF	precise final approach fix
PinS	point in space
PO	proponent
POC	point of contact
POI	principal operations inspector
PRB	Procedures Review Board
PRM	precision runway monitor
PT	procedure turn
PTS	procedure tracking system
RA	radio altimeter
RAIL	runway alignment indicator light
RAPCON	radar approach control
RAPT	Regional Airspace and Procedures Team
RASS	remote altimeter setting source
RCL	runway centerline

RDOS	runway departure obstacle screening
RDP	radar data processing
RDP	reference datum point
REIL	runway end identifier lights
RF	radius-to-fix
RFO	responsible Federal official
RNAV	area navigation
RNP	required navigation performance
ROC	required obstacle clearance
RSI	remote status indicator
RVR	runway visual range
RWY	runway
SCP	simultaneous close parallel
SDF	Simplified Directional Facility
SDF	stepdown fix
SIAP	standard instrument approach procedure
SID	standard instrument departure
SM	statute mile
SMGCS	Surface Movement Ground Control System
SMS	Safety Management System
SOIA	Simultaneous Offset Instrument Approach
SOP	standard operating procedures
SRM	safety risk management
SRTM	shuttle radar terrain model
SSALR	short simplified approach lighting system with runway alignment indicator lights
SSV	standard service volume
STAR	standard terminal arrival
SUA	special use airspace
TAA	terminal arrival area

TACAN	tactical air navigational aid
TARGETS	Terminal Area Route Generation, Evaluation and Traffic Simulation software tool
TCAS	Traffic Alert and Collision Avoidance System
TCH	threshold crossing height
TDP	touchdown point
TDZ	touchdown zone
TDZE	touchdown zone elevation
TERPS	terminal instrument procedures
TF	track-to-fix
THR	threshold
TPP	terminal procedure publication
TRACON	terminal radar approach control facility
TSO	technical standard order
UHF	ultra high frequency
USA	U.S. Army
USAASA	U.S. Army Aeronautical Services Agency
USAASDE	U.S. Army Aeronautical Services Detachment – Europe
USAF	U.S. Air Force
USCG	U.S. Coast Guard
USN	U.S. Navy
USNOF	U.S. NOTAM Office
VA	heading-to-an-altitude leg
VASI	visual approach slope indicator
VCA	visual climb area
VDA	vertical descent angle
VDP	visual descent point
VFR	visual flight rules
VGSI	visual glide slope indicator
VHF	very high frequency

VI	vector-to-intercept leg
VLF	very low frequency
VM	vector-to-a-manual termination
VMC	visual meteorological conditions
VNAV	vertical navigation
VOR	very high frequency omni-directional range
VOR/DME	VOR collocated with DME
VORTAC	VOR collocated with tactical air navigation
VPA	vertical path angle
VSDA	visual segment descent angle
WAAS	Wide Area Augmentation System
WP	waypoint
XTRK	crosstrack



**4. Forms.** The following forms are provided in electronic form online for use in the development and maintenance of flight procedures.

**Table 2. Forms**

FAA Form Number	Title
8260-1	Flight Procedure Standards Waiver
8260-2	Radio Fix and Holding Data Record
8260-3	ILS-Standard Instrument Approach Procedure
8260-4	Radar Standard Instrument Approach Procedure
8260-5	Standard Instrument Approach Procedure
8260-7A	Special Instrument Approach Procedure
8260-7B	Special Instrument Procedure Authorization
8260-9	Standard Instrument Approach Procedure Data Record
8260-15A	Takeoff Minimums and Textual Departure Procedure (DP)
8260-15B	Graphic Departure Procedure (DP)
8260-15C	Departure (Data Record)
8260-15D	Diverse Vector Area (DVA)
8260-15E	RNAV Departure Procedure Attention All Users Page (AAUP)
8260-16	Transmittal of Airways/Route Data Record
8260-17.1	Standard Terminal Arrival (STAR)
8260-17.2	STAR (Data Record)
8260-18	Simultaneous Close Parallel (PRM) Attention All Users Page (AAUP)
8260-30.1	Simulator Evaluation Checklist
8260-30.2	Obstacle Assessment Checklist
8260-30.3	Flight Validation Checklist

**5. Information update.** For your convenience, Form 1320-19, Directive Feedback Information, is included at the end of this order to note any deficiencies found, clarifications needed, or suggested improvements regarding the contents of this order. When forwarding your comments to the originating office for consideration, please provide a complete explanation of why the suggested change is necessary.

THIS PAGE IS INTENTIONALLY LEFT BLANK

**Appendix B. Flight Procedures References**

The following publications (latest versions) listed within this appendix are provided for use as an information aide in the development of instrument flight procedures. This listing may not be all inclusive of new and/or recently canceled publications.

**Table 1. Orders**

	<b>Order Number</b>	<b>Title of Order</b>
	1050.1	Policies and Procedures for Considering Environmental Impacts
	1100.161	Air Traffic Oversight
	1350.15	Records Organization, Transfer, and Destruction Standards
	1370.52	Information Resources Policy
	1370.82	Information Systems Security Program
	1800.56	National Flight Standards Work Program Guidelines
	5010.4	Airport Safety Data Program
	5100.38	Airport Improvement Program (AIP) Handbook
	6030.20	Electrical Power Policy
	6050.32	Spectrum Management Regulations and Procedures Manual
	6560.10	Runway Visual Range (RVR)
	6700.20	Non-Federal Navigational Aids and Air Traffic Control Facilities
	6750.16	Siting Criteria for Instrument Landing Systems
	6750.24	Instrument Landing System and Ancillary Electronic Component Configuration and Performance Requirements
JO	6750.49	Maintenance of Instrument Landing System (ILS) Facilities
JO	6850.2	Visual Guidance Lighting Systems
JO	6850.5	Maintenance of Lighted Navigational Aids
	6950.2	Electrical Power Policy Implementation at National Airspace System Facilities
	7031.2	Airway Planning Standards #1 Terminal Air Navigation Facilities and Air Traffic Services
JO	7100.9	Standard Terminal Arrival
JO	7110.10	Flight Services
	7110.19	Designation Taxiways as Temporary Runways
	7110.22	Arrival and Departure Handling of High Performance Aircraft
JO	7110.65	Air Traffic Control
	7110.79	Chartered Visual Flight Procedures
JO	7110.308	Simultaneous Dependent Approaches to Closely Spaced Parallel Runways
JO	7210.3	Facility Operation and Administration
JO	7210.37	En Route Minimum IFR Altitude (MIA) Sector Charts
JO	7340.2	Contractions

JO	7350.9	Location Identifiers
JO	7400.2	Procedures for Handling Airspace Matters
JO	7470.1	Distance Measuring Equipment (DME)/DME Infrastructure Evaluation for Area Navigation (RNAV) Routes and Procedures
	7450.1	Special Use Airspace Management System
JO	7610.4	Special Operations
	7900.2	Reporting of Electronic Navigation Aids and Communication Facilities Data to the NFDC
	7900.5	Surface Weather Observing
JO	7930.2	Notices to Airmen (NOTAMs)
	8000.369	Safety Management System
	8040.4	Safety Risk Management Policy
	8200.1	United States Standard Flight Inspection Manual
JO	8200.44	Coordination of Flight Inspection Procedure Packages
	8240.47	Determination of Instrument Landing System (ILS) Glidepath Angle, Reference Datum Heights (RDH)
	8260.3	United States Standard for Terminal Instrument Procedures (TERPS)
	8260.15	United States Army Terminal Instrument Procedure Service
	8260.26	Establishing Submission Cutoff Dates for Civil Instrument Flight Procedures
	8260.31	Foreign Terminal Instrument Procedures
	8260.32	United States Air Force Terminal Instrument Procedures Service
	8260.42	United States Standard for Helicopter Area Navigation (RNAV)
	8260.43	Flight Procedures Management Program
	8260.46	Departure Procedure (DP) Program
	8260.55	Special Area Navigation Visual Flight Procedures
FS	8260.57	Oversight of Third Party Instrument Flight Procedure Service Providers
	8260.58	United States Standard for Performance-based Navigation (PBN) Instrument Procedure Design
	8260.60	Special Instrument Procedures
	8400.13	Procedures for the Approval of Special Authorization Category II and Lowest Standard Category I Operations
	8900.1	Flight Standards Information Management System (FSIMS)

**Table 2. Advisory Circulars**

<b>AC Number</b>	<b>Title of Advisory Circular</b>
FAA-H-8083-15	Instrument Flying Handbook
FAA-H-8083-16	Instrument Procedures Handbook
20-138	Airworthiness Approval of Positioning and Navigation Systems
25-15	Approval of Flight Management Systems in Transport Category Airplanes
70/7460-1	Obstruction Marking and Lighting
90-42	Traffic Advisory Practices at Airports Without Operating Control Towers
90-80	Approval for Offshore Standard Approach Procedures (OSAP), Airborne Radar Approaches (ARA), and Helicopter En Route Descent Areas (HEDA)
90-100	U.S. Terminal and En Route Area Navigation (RNAV) Operations
90-101	Approval Guidance for RNP Procedures with SAAAR
90-105	Approval Guidance for RNP Operations and Barometric Vertical Navigation in the U.S. National Airspace System
90-107	Guidance for Localizer Performance with Vertical Guidance and Localizer Performance without Vertical Guidance Approach Operations in the U.S. Airspace System
90-108	Use of Suitable Area Navigation (RNAV) Systems on Conventional Routes and Procedures
90-110	Authorization Guidance for Development of Required Navigation Performance (RNP) Procedures with Authorization Required (AR) by Third Party Instrument Flight Procedure (IFP) Service Providers
90-112	Development and Submission of Special Instrument Procedures to the Federal Aviation Administration (FAA)
90-113	Instrument Flight Procedure Validation (IFPV) of Satellite-based Instrument Flight Procedures (IFPs)
91-14	Altimeter Setting Sources
91-16	Category II Operations-General Aviation Airplanes
91-54	Automatic Reporting Systems-Altimeter Setting and Other Operational Data
97-1	Runway Visual Range (RVR)
120-28	Criteria for Approval of Category III Weather Minima for Takeoff, Landing, and Rollout
120-29	Criteria for Approving Category I and Category II Landing Minima for FAR 121 Operators
120-91	Airport Obstacle Analysis
150/5070-6	Airport Master Plans
150/5200-28	Notices to Airmen (NOTAMs) for Airport Operators
150/5300-13	Airport Design
150/5340-1	Standards for Airport Markings
150/5340-26	Maintenance of Airport Visual Aid Facilities
150/5390-2	Heliport Design
150/5345-50	Specification for Portable Runway Lights
170-9	Criteria for Acceptance of Ownership and Servicing of Civil Aviation Interest(s) Navigational and Air Traffic Control Systems and Equipment

**Table 3. Title 14, Code of Federal Regulations (CFR)**

<b>Part</b>	<b>Title of 14 CFR</b>
1	Definition and Abbreviations
71	Designations of Class A, Class B, Class C, Class D, and Class E Airspace Areas; Air Traffic Service Routes; and Reporting Points
73	Special Use Airspace
77	Objects Affecting Navigable Airspace
91	General Operating and Flight Rules
93	Special Air Traffic Rules
95	IFR Altitudes
97	Standard Instrument Approach Procedures
103	Ultra-light Vehicles
121	Operating Requirements: Domestic Flag and Supplemental Operations
125	Certification and Operations: Airplanes Having a Seating Capacity of 20 or More Passengers or a Maximum Payload Capacity of 6,000 Pounds or More; and Rules Governing Persons Onboard Such Aircraft
129	Operations: Foreign Air Carriers and Foreign Operators of U.S. – Registered Aircraft Engaged in Common Carriage
135	Operating Requirements: Commuter and On Demand Operations and Rules Governing Persons Onboard Such Aircraft
139	Certification and Operations: Land Airports Serving Certain Air Carriers
150	Airport Noise Compatibility Planning
152	Airport Aid Program
157	Notice of Construction, Alteration, Activation, and Deactivation of Airports
161	Notice and Approval of Airport Noise and Access Restrictions
170	Establishment and Discontinuance Criteria for Air Traffic Control Services and Navigational Facilities
171	Non-Federal Navigation Facilities

**Table 4. Other Publications**

<b>Title of Publication</b>
Aeronautical Information Manual (AIM)
Airport Master Record, FAA Form 5010.1
Airspace Dockets
Area Charts
Chart Supplement
Graphic Notices and Supplemental Data
ICAO Annex 11, Air Traffic Services
ICAO ATM 4444, Air Traffic Management
Low and High Altitude En Route Charts
National Flight Data Digest (NFDD)
National Plan of Integrated Airport Systems (NPIAS)
NACO Weekly Obstacle Memo
RTCA Document DO-187, Minimum Operational Performance Standards for Airborne Area Navigation Equipment Using Multi-Sensor Inputs
RTCA Document DO-236, Minimum Aviation System Performance Standards: Required Navigation Performance for Area Navigation
Sectional and Terminal Area Charts
Transmittal Letter (TL)
USGS Topographical Charts

THIS PAGE IS INTENTIONALLY LEFT BLANK



## Appendix C. Obstacle Accuracy Standards, Codes, and Sources

**1. United States national map accuracy standards.** With a view to the utmost economy and expedition in producing maps that fulfill not only the broad needs for standard or principal maps, but also the reasonable particular needs of individual agencies, standards of accuracy for published maps are defined as follows:

**a.** Horizontal accuracy. For maps on publication scales larger than 1:20,000, up to 10 percent of the points tested must be in error by more than 1/30 inch, measured on the publication scale; for maps on publication scales of 1:20,000 or smaller, 1/50 inch. These limits of accuracy must apply in all cases to positions of well-defined points only. Well-defined points are those that are easily visible or recoverable on the ground, such as the following: monuments or markers, such as bench marks, property boundary monuments; intersections of roads, railroads, etc.; corners of large buildings or structures (or center points of small buildings); etc. In general, what is well defined will also be determined by what can be plotted on the scale of the map within 1/100 inch. Thus, while the intersection of two roads or property lines meeting at right angles would come within a sensible interpretation, identification of the intersection of such lines meeting at an acute angle would obviously not be practicable within 1/100 inch. Similarly, features not identifiable upon the ground within close limits are not to be considered as test points within the limits quoted, even though their positions may be scaled closely upon the map. Timber lines, soil boundaries, etc. would be in this class.

**b.** Vertical accuracy, as applied to contour maps on all publication scales, must be such that not more than 10 percent of the elevations tested must be in error more than one-half the contour interval. In checking elevations taken from the map, the apparent vertical error may be decreased by assuming a horizontal displacement within the permissible horizontal error for a map of that scale.

**c.** Map accuracy testing may be accomplished by comparing the positions of points whose locations or elevations are shown upon it with corresponding positions as determined by surveys of a higher accuracy. Tests must be made by the producing agency that must also determine which of its maps are to be tested and the extent of such testing.

**d.** Published maps meeting these accuracy requirements must note this fact on their legends as follows: "This map complies with National Map Accuracy Standards."

**e.** Published maps whose errors exceed those stated before must omit all mention of standard accuracy from their legends.

**f.** Enlargements. When a published map is a considerable enlargement of a map drawing (manuscript) or of a published map, that fact must be stated in the legend. For example, "This map is an enlargement of a 1:20,000-scale map drawing "or" This map is an enlargement of a 1:24,000-scale published map."

**g.** Data interchange. To facilitate ready inter-change and use of basic information for map construction among all Federal map-making agencies, manuscript maps and published maps,

wherever economically feasible and consistent with intended map use, must conform to latitude and longitude boundary size, being 15, 7.5, or 3 ¾ minutes of latitude and longitude.

## 2. Accuracy codes and sources.

**a.** Accuracy codes. Allowable accuracy of vertical and horizontal data was originally determined by a joint DoD/DOC/DOT task group in 1979. Accuracy codes established by that task group no longer require documentation on 8260-series forms. Instead, document the vertical [see appendix C table 2] and/or horizontal adjustment [see appendix C table 1] applied [see paragraphs 2-11-3, 2-11-4, 8-7-1.b(11) and 8-7-1.b(15)]. Where digital terrain elevation data (DTED) or digital elevation model (DEM) postings have an assigned accuracy value, use the actual accuracy value associated with the model or posting as applicable.

**b.** Sources. The task group was provided specified accuracies from each of the following sources:

**Table 1. Horizontal**

Code	Tolerance	
1	+20 feet	(6 m)
2	+50 feet	(15 m)
3	+100 feet	(30 m)
4	+250 feet	(75 m)
5	+500 feet	(150 m)
6	+1000 feet	(300 m)
7	+½ NM	(900 m)
8	+1 NM	(1800 m)
9	Unknown	

**Table 2. Vertical**

Code	Tolerance	
A	+3 feet	(1 m)
B	+10 feet	(3 m)
C	+20 feet	(6 m)
D	+50 feet	(15 m)
E	+125 feet	(38 m)
F	+250 feet	(75 m)
G	+500 feet	(150 m)
H	+1000 feet	(300 m)
I	Unknown	

(1) Department of Transportation. FAA obstacle data for terrain structures are recorded on airspace, airport, and procedures records.

(a) Field inspections that employ a theodolite, +50 feet (15 meters) horizontally and +20 feet (6 meters) vertically. Code 2C.

(c) Weekly obstacle memo - digital obstacle file, accuracy codes are as specified. Code 1A to 9I.

(d) Airport Field Offices (AFO) may assign their own codes to obstacles on engineering drawings and airport layout plan furnished to regional Airports Division.

(e) Technical Operations (Tech Ops) field survey navigation aids, +20 feet (6 meters) horizontally and 3 feet (1 meter) vertically. Code 1A. Other obstacles, +50 feet (15 meters) horizontally and +10 feet (3 meters) vertically, unless verified to a higher accuracy. Code 2B.

(f) Flight inspection fly-by, +250 feet (75 meters) horizontally and +50 feet (15 meters) vertically [see Order 8200.1]. Code 4D.

(g) Flight edits photogrammetry, +100 feet (30 meters) horizontally and +20 feet (6 meters) vertically, excluding moveable objects. Code 3C.

(h) Estimated by airport owner or operator, +½ NM (900 meters) horizontally and +500 feet (150 meters) vertically. Code 7G.

(i) Sectional chart and VFR terminal chart.

1. Terrain features which are not marked as spot elevations [see appendix C table 3]:

**Table 3.**

Chart	Horizontal	Vertical*
Sec	+900 feet (275 m)	+250 feet (75 m)
VFR	+500 feet (150 m)	+250 feet (75 m)
		* ½ contour line

2. When mountain peaks are specifically marked by a spot elevation, the vertical accuracy is 20 feet (6 meters). Horizontal accuracy determined by chart type as specified in paragraph 2.b.

3. When these charts are used to establish coordinates, it must be recognized that the IACC charting standards permit displacement of objects to provide for relative depiction. To account for these additional errors, the horizontal accuracy factors must be doubled for manmade obstacles depicted on sectional and VFR charts.

(2) Department of Defense.

(a) National Geospatial-intelligence Agency [see paragraph 2a]:

1. DTED (Level 0) 1 kilometer postings from 1:350,000 charts, +500 feet (150 meters) horizontally and +100 feet (30 meters) vertically Code 5E. DTED (Level 1), 100 meter postings +50 meters (164 feet) horizontally and +30 meters (98 feet) vertically. Code 4E.

DTED (Level 2), 30 meter postings +23 meters (76 feet) horizontally and +18 meters (59 feet) vertically. Code 3E.

2. Shuttle radar terrain model (SRTM): Level 1 (Foreign) 90 meter posting, equivalent to 1:250,000. Level 2 (CONUS) 30 meter posting, equivalent to 1:50,000. Level 1 and 2 accuracies are 20 meter horizontal and 16 meter vertical. Code 3D.

3. Vertical obstruction feature database (VOFD). Populated using multiple sources. Obstruction attributes contain associated source accuracy code (Surveyed to Reported). Code 1A to 9I.

4. Joint operations graphic (JOG) - AIR, 2nd Series, (1:250,000 scale), +500 feet (150 meters) horizontally and +125 feet (38 meters) vertically. Code 5E.

5. Topographical line maps (TLM), (1:50,000 and 1:100,000 scale), +50 feet (15 meters) horizontally and +20 feet (6 meters) vertically. Code 2C.

(b) Surveys conducted by U.S. Army topographic units must have the same accuracy standards as those developed by the Department of Transportation [see paragraph 2.b(1)(a)].

(3) Department of Interior. U.S. geological survey data in magnetic tape files are claimed to be accurate to +1000 feet (300 meters) horizontally and +100 feet (30 meters) vertically. Code 6E. For the following charts, when obstacles or mountain peaks are specifically marked by a spot elevation, the vertical accuracy changes to +3 feet (1 meter). Otherwise, these charts have the following accuracies:

(a) Topographical charts (1:250,000 scale), +1000 feet (300 meters) horizontally and +125 feet (38 meters) vertically. Code 6E.

(b) Topographical charts (1:100,000 scale), +250 feet (75 meters) horizontally and +125 feet (38 meters) vertically. Code 4E.

(c) Topographical charts (1:62,500 or 1:63,360 scale), +250 feet (75 meters) horizontally and +50 feet (15 meters) vertically. Code 4D.

(d) Topographical charts [1:20,000, 1:24,000] (7 ½ min. Quad series), and 1:25,000], +40 feet (12 meters) horizontally and +20 feet (6 meters) vertically. Code 2C.

When these charts are used to establish coordinates, it must be recognized that the IACC charting standards permit displacement of objects to provide for relative depiction. To account for these additional errors (as well as human scaling errors), the following accuracy factors will be used [see appendix C table 4]:

**Table 4. Accuracy Factors**

Map Scale	Landmarks Depicted on Chart	Owner Marked Positions
1:250,000	7G	8H
1:62,500 or 1:63,360 ( $\leq$ 40-foot contours)	4E	5E
1:62,500 or 1:63,360 ( $\leq$ 80-foot contours)	4F	5F
1:20,000 or 1:24,000 ( $\leq$ 10-foot contours)	4D	4D
1:20,000 or 1:24,000 ( $\leq$ 20-foot contours)	4D	4E
1:100,000	5F	6G

(a) DEM data. U.S. Geological survey data for terrain elevations is typically based on DEM. Source documentation from the NOS supports the following horizontal and vertical accuracies; these values must be used in instrument procedure construction [see exception in paragraph 2a]: DEM 7.5 minute (Level 1), +13 meters (43 feet) horizontally and +14 meters (46 feet) vertically. Code 2D.

(b) DEM 7.5 minute (Level 2), +13 meters (43 feet) horizontally and +17 meters (56 feet) vertically. Code 2E.

(c) DEM 1 degree (1:250,000 scale), +130 meters (427 feet) horizontally and +30 meters (98 feet) vertically. Code 5E.

THIS PAGE IS INTENTIONALLY LEFT BLANK

**Appendix D. FAA Form 8260-2, Data Worksheet**

*Instructions for completing 8260-2, Data Worksheet, [see appendix D figure 1] for requesting modification of fixes (including “Fix Use” updates) and/or holding patterns associated with existing 14 CFR part 95 routes, 14 CFR part 97 approaches, Special instrument procedures, SID or STARs.*

Complete this worksheet with as much information as possible and explain any requested procedure additions or deletions in block 10, Remarks. Submit this worksheet to the Office of Primary Responsibility (OPR) identified on the Form 8260-2 for proper action to be taken. For those fixes/holding patterns documented on older versions of Form 8260-2 that do not contain an OPR listed, contact the National Flight Data Center (NFDC), for a determination on where to submit this request.

**Block 1. Requested publication date.** Enter the desired effective date that coincides with the charting cycle [see Order 8260.26, appendix A]. If the Form 8260-2 request is to be in conjunction with an airspace action, obtain the docket number from the Western, Central, or Eastern Service Area for En Route Operations, Airspace Group. For Form 8260-2 requests, allow at least 20 weeks lead-time from the desired effective date.

**Block 2. Fix name.** Enter the five-character pronounceable name obtained from ARTCC. Do not include “WP” as part of the name. If requesting holding at a navigational aid, enter the name and type of navigational aid.

**Block 3. Fix type.** List the type(s) of fix, e.g., RADAR, WP, DME, INT (made up of crossing radials, bearings, or combinations of both).

**Block 4. State.** Enter the state in which the fix is located [see paragraph 8-5-2.b].

**Block 5. ICAO region code.** Enter the ICAO region code in which the fix is located [see paragraph 8-5-2.d].

**Block 6. Location.** Latitude and longitude accurate to the hundredth of a second; e.g., 09.25 sec. List all navigational aids used for the fix makeup. Provide radials or bearings, DME, and distance values to the hundredth value; e.g., 347.23°; 08.37 NM. Specify if the course/bearing is in magnetic (and the magnetic variation used for computation) or in true.

**Block 7. Type of action required.** Check applicable box to establish, modify, or cancel the fix. If there is no change to the fix, check “no change.”

**Block 8. Holding.** Describe holding patterns required at fix. When climb-in-holding is required, provide detailed holding instructions including maximum altitude and maximum speed (if other than standard).

**Block 9. Charting.** Indicate required charting; i.e., terminal, SIDs, STARs, or en route charts.

**Block 10. Remarks.** List all procedures which use the fix and other uses of the fix; e.g., reporting points, etc. Include any other information that may assist in developing the fix. Justify the requirement for other than routine processing and charting.

07/20/2017

Order 8260.19H  
Appendix D

**Block 11.** Point-of-contact (POC). Self-explanatory.



Figure 1. FAA Form 8260-2, Data Worksheet

1. Requested Publication Date: \_\_\_\_\_

2. Fix Name: \_\_\_\_\_

3. Fix Type: \_\_\_\_\_

4. State: \_\_\_\_\_

5. ICAO Region Code: \_\_\_\_\_

6. Location: \_\_\_\_\_

7. Type of (Fix) Action Required:      Establish  Modify  Cancel  No Change

8. Holding: \_\_\_\_\_

9. Charting: \_\_\_\_\_

10. Remarks (Use additional paper if required):

---

11. Point of Contact (POC):

ATC Facility Name.

POC's Name.

Telephone Number.

FAX Number.

E-Mail Address

THIS PAGE IS INTENTIONALLY LEFT BLANK

**Appendix E. Radio Fix and Holding Data Record, FAA Form 8260-2**

This appendix contains examples of Form 8260-2, Radio Fix and Holding Data Record [see appendix E figure 1 through figure 5].

**Figure 1.**

**RADIO FIX AND HOLDING DATA RECORD**

NAME: PROVIDENCE VORTAC STATE: RI COUNTRY: US ICAO REGION CODE: K6

LATITUDE/LONGITUDE: 414327.64N/0713546.70W TYPE:

AIRSPACE DOCKET: FIX TYPE OF ACTION: NO CHANGE

**FIX MAKE-UP FACILITIES:**

FAC NAME	IDENT	TYPE	CLASS	MAG BRG	TRUE BRG	DME	DIST FROM FAC NM	MRA FEET	MAA
1 PROVIDENCE	PVD	VORTAC	H						45000

HOLDING: HOLDING TYPE OF ACTION: MODIFY

**PATTERNS:**

PAT	DIR	IDENT	TYPE	RAD/CRS/BRG	CRS INBOUND	TURN (L OR R)	LEG LENGTH TIME	DME	HOLDING ALTITUDES MIN MAX	TEMPLATES MIN MAX
1	S	PVD	VORTAC	181.00	001.00	R	1		1900 5000	4 5
2	N	PVD	VORTAC	344.00	164.00	R	1		3000 5000	4 5
3	NE	PVD	VORTAC	057.00	237.00	R	1 1/2		24000 39000	19 27
4	N	PVD	VORTAC	008.00	188.00	R	1		2100 10000	4 9
5	SW	PVD	VORTAC	234.00	054.00	R	1-1 1/2		11000 23000	9 19
6	SW	WP		235.41	055.41	R		8	11000 14000	9 10

**CONTROLLING OBSTRUCTIONS:**

PAT	AIRSPEED	OBSTRUCTION	COORDINATES	ELEVATION	ACCURACY CODE
1	200	200' AAO	414038.00N/0712947.00W	559	2C
2	200	TOWER (40-0125)	414812.00N/0713325.00W	1049	5D
4	200	TOWER (40-0125)	414812.00N/0713325.00W	1049	5D
5	230	TOWER (22-0325)	415213.00N/0711743.00W	1149	4D
6	230	TOWER (40-0113)	413423.00N/0713756.00W	851	2C

**HOLDING RESTRICTIONS:**

HOLDING LIMITED TO ESTABLISHED PATTERNS

**REMARKS:**

Assigned Facility MagVar: 14 degrees West

**FIX USE:**

USE TYPE	USE TITLE	FAC	PAT	AIRPORT IDENT	CITY	STATE
DP	LOGAN			KBOS	BOSTON	MA
DP	WYLYY			KBOS	BOSTON	MA
DP	BRADLEY			KBDL	WINDSOR LOCKS	MA
DP	HANSCOM			KBED	BEDFORD	MA
DP	BEVERLY			KBVY	BEVERLY	MA
DP	NORWOOD			KOWD	NORWOOD	MA
DP	LAWRENCE			KLWM	LAWRENCE	MA
DP	STEWAY			KACK	NANTUCKET	MA
EN ROUTE	V139		5			
EN ROUTE	V146					
EN ROUTE	V151					
EN ROUTE	V167					
EN ROUTE	V405					
EN ROUTE	V475					
EN ROUTE	J55		5			
EN ROUTE	J68					
EN ROUTE	J225					
IAP	ILS RWY 15R			KBOS	BOSTON	MA
IAP	VOR/DME RWY 15R			KBOS	BOSTON	MA
IAP	VOR/DME RWY 27			KBOS	BOSTON	MA
IAP	VOR/DME RWY 33			KBOS	BOSTON	MA
IAP	VOR/DME RNAV RWY 4R			KBOS	BOSTON	MA
IAP	NDB RWY 32			1B9	MANSFIELD	MA
IAP	ILS RWY 5			KEWB	NEW BEDFORD	MA
IAP	LOC BC RWY 23			KEWB	NEW BEDFORD	MA
IAP	NDB RWY 5			KEWB	NEW BEDFORD	MA
IAP	RNAV (GPS) RWY 5			KEWB	NEW BEDFORD	MA
IAP	LOC RWY 22			KUUU	NEWPORT	RI
IAP	VOR/DME OR GPS RWY 16		2	KUUU	NEWPORT	RI
IAP	ILS RWY 16			KOQU	NORTH KINGSTOWN	RI
IAP	VOR-A		4	KOQU	NORTH KINGSTOWN	RI
IAP	VOR RWY 34			KOQU	NORTH KINGSTOWN	RI
IAP	VOR/DME RNAV RWY 34			KOQU	NORTH KINGSTOWN	RI
IAP	LOC RWY 35			KOWD	NORWOOD	MA
IAP	VOR-A		1	KSFZ	PAWTUCKET	RI
IAP	VOR-B			KSFZ	PAWTUCKET	RI

IAP	RNAV (GPS) RWY 5		KSFZ	PAWTUCKET	RI
IAP	ILS OR LOC/DME RWY 6		KPYM	PLYMOUTH	MA
IAP	RNAV (GPS) RWY 6		KPYM	PLYMOUTH	MA
IAP	NDB OR GPS RWY 30		KTAN	TAUNTON	MA
IAP	ILS OR LOC RWY 5		KPVD	PROVIDENCE	RI
IAP	ILS OR LOC RWY 23		KPVD	PROVIDENCE	RI
IAP	ILS RWY 5 CAT II		KPVD	PROVIDENCE	RI
IAP	ILS RWY 5 CAT III		KPVD	PROVIDENCE	RI
IAP	ILS RWY 34		KPVD	PROVIDENCE	RI
IAP	VOR/DME RWY 16		KPVD	PROVIDENCE	RI
IAP	VOR/DME RWY 23		KPVD	PROVIDENCE	RI
IAP	VOR/DME RWY 34		KPVD	PROVIDENCE	RI
IAP	VOR RWY 5		KPVD	PROVIDENCE	RI
IAP	VOR RWY 34		KPVD	PROVIDENCE	RI
IAP	RNAV (GPS) RWY 5		KPVD	PROVIDENCE	RI
IAP	RNAV (GPS) RWY 16		KPVD	PROVIDENCE	RI
IAP	VOR RWY 23		KGON	GROTON (NEW LONDON)	CT
IAP	RNAV (GPS) RWY 23		KGON	GROTON (NEW LONDON)	CT
STAR	GRAYM			BEDFORD	MA
STAR	NEWBE			NANTUCKET	MA
STAR	NORWICH	5	KBOS	BOSTON	MA
STAR	SCUPP		KBOS	BOSTON	MA
STAR	TEDDY			PROVIDENCE	RI
STAR	WOONS			BOSTON	MA

REQUIRED CHARTING: AREA, DP, EN ROUTE LOW, EN ROUTE HIGH, IAP, STAR

COMPULSORY REPORTING POINT: NO

RECORD REVISION NUMBER: 19      DATE OF REVISION: MM/DD/YYYY

REASON FOR REVISION:  
ADDED A TEMPLATE TO PAT 5, 265K HOLDING.  
RAISED PAT 4, 200K MINIMUM HOLDING ALTITUDE.  
ADDED HOLDING PAT 6.  
CHANGED PAT 4, 230K CONTROLLING OBSTACLE.  
CHANGED PAT 5, 265K CONTROLLING OBSTACLE.  
UPDATED FIX USE.  
ADDED FACILITY MAG VAR.

ATC COORDINATION:    DATE: MM/DD/YYYY    FACILITY: ZBW      NAME: MICK CONTROL

INITIATED BY:      DATE:      ORGANIZATION:      NAME:

OFFICE OF PRIMARY RESPONSIBILITY:    XXXXX XXXXX, XXX-XXX

APPROVED BY:      DATE: MM/DD/YYYY    OFFICE: XXX-XXX      NAME: MAXWELL MCDONALD

SIGNATURE:

DISTRIBUTION: NFDC  
FIFO  
FPT: XXX-XXX  
ARTCC: ZBW  
ATC FACILITY: PVD APP CON  
OTHER:

Figure 2.

**RADIO FIX AND HOLDING DATA RECORD**

**NAME:** XMPLE **STATE:** TN **COUNTRY:** US **ICAO REGION CODE:** K7  
**LATITUDE/LONGITUDE:** 383338.31N/0873152.98W **TYPE:** INT, DME, WP, RADAR  
**AIRSPACE DOCKET:** 06-AEA-0108 **FIX TYPE OF ACTION:** ESTABLISH

**FIX MAKE-UP FACILITIES:**

FAC	NAME	IDENT	TYPE	CLASS	MAG BRG	TRUE BRG	DME	DIST FROM FAC NM	MRA FEET	MAA
1	POCKET CITY	PXV	VORTAC	H	013.00	016.00	39.44	39.44	2000	17500
2	SAMSVILLE	SAM	VOR/DME	T	083.00	080.00		26.50	2000	17500
3	LAWRENCEVILLE	LWV	VOR/DME	T	165.79	164.75		12.99	2000	17500
4	MT CARMEL	AJG	NDB	MH	110.51	108.51		9.67	2000	17500
5	WASHINGTON	DCY	NDB	MH	248.71	246.71		20.44	2000	17500
6	BUG TUSSLE	I-BUG	LOC/DME		305.48	306.48	12.37	12.37	2000	6500

**EXPANDED SERVICE VOLUME (ESV):**

FAC IDENT	FAC TYPE	RADIAL/BEARING	DISTANCE	MIN ALTITUDE	MAX ALTITUDE
SAM	VOR/DME	R-083	27	2000	17500
LWV	VOR/DME	R-166	13	2000	17500

**FIX RESTRICTIONS:**

MCA V7 4500 NORTHBOUND  
MRA V44 3000

**HOLDING:**

**HOLDING TYPE OF ACTION:** ESTABLISH

**PATTERNS:**

PAT	DIR	IDENT	TYPE	RAD/CRS/BRG	CRS	TURN	LEG LENGTH	HOLDING ALTITUDES	TEMPLATES		
					INBOUND	(L OR R)	TIME	MIN	MAX	MIN	MAX
1	S	LWV	VOR/DME	165.79	345.79	L	1	5000	10000	4	4
2	NW	I-BUG	LOC/DME	305.48	125.48	L	1	2500	6000	4	5
3	NW		WP	305.48	125.48	R	4	2500	15000	4	12

**CONTROLLING OBSTRUCTIONS:**

PAT	AIRSPEED	OBSTRUCTION	COORDINATES	ELEVATION	ACCURACY CODE
1	175	ANTENNA (27-0038)	383346.19N/0873200.26W	772	3C
1	230	TOWER (27-1005)	383357.24N/0873255.39W	1035	4D
2	200	POWERLINE (27-2337)	383347.20N/0873155.87W	521	2C
3	200	POWERLINE (27-2337)	383347.20N/0873155.87W	521	2C
UPN	310	ANTENNA (KBUG0024)	383255.49N/0873126.05W	2345	1A

**REASON FOR NONSTANDARD HOLDING:**

PAT 1 TRAFFIC AVOIDANCE  
PAT 2 AIR TRAFFIC BOUNDARY

**HOLDING RESTRICTIONS:**

PAT 1 CHART 175K ICON  
UNPLANNED HOLDING AUTHORIZED AT OR ABOVE 3400  
COORDINATE WITH INDIANAPOLIS ARTCC PRIOR TO HOLDING AT XMPLE

**PROCEDURES REQUIRING CLIMB-IN-HOLD:**

PAT	PROCEDURE TITLE	AIRPORT IDENT	CITY	STATE
PAT 1	NDB RWY 18	KAJG	MT CARMEL	TN

**REMARKS:**

POCKET CITY (FAC 1) AND SAMSVILLE (FAC 2) USED TO ESTABLISH FIX COORDINATES.

**FIX USE:**

USE TYPE	USE TITLE	FAC	PAT	AIRPORT IDENT	CITY	STATE
DP	JETHRO	1, 2		KBUG	BUG TUSSLE	TN
DP	BODINE RNAV			KBUG	BUG TUSSLE	TN
EN ROUTE	V7	1, 2				
EN ROUTE	V44	1, 2				
IAP	NDB RWY 18	1, 2, 3	1	KAJG	MT CARMEL	TN
IAP	NDB RWY 5	3, 5		KDCY	WASHINGTON	TN

IAP	ILS OR LOC RWY 13	1, 6	2	KBUG	BUG TUSSLE	TN
IAP	RNAV (GPS) RWY 13		3	KBUG	BUG TUSSLE	TN
STAR	CANNONBALL				PIXLEY	TN

REQUIRED CHARTING: AREA, DP, EN ROUTE LOW, IAP, STAR

COMPULSORY REPORTING POINT: LOW

RECORD REVISION NUMBER: ORIG      DATE OF REVISION: MM/DD/YYYY

REASON FOR REVISION:

ATC COORDINATION:    DATE: MM/DD/YYYY    FACILITY: CRC APP CON    NAME: SEYMOUR PLANES

INITIATED BY:            DATE:                    ORGANIZATION:            NAME:

OFFICE OF PRIMARY RESPONSIBILITY:    XXXXX XXXXX, XXX-XXX

APPROVED BY:            DATE: MM/DD/YYYY    OFFICE: XXX-XXX            NAME: FRANK FAIRCHILD

SIGNATURE:

DISTRIBUTION: NFDC  
 FIFO  
 FPT: XXX-XXX  
 ARTCC: ZID, ZKC, ZMP  
 ATC FACILITY: CRC APP CON, AJG ATCT, BUG ATCT  
 OTHER: TN DOT, CITY OF BUG TUSSLE AVIATION AUTHORITY

Figure 3.

**RADIO FIX AND HOLDING DATA RECORD**

NAME: HOWTO STATE: MO COUNTRY: US ICAO REGION CODE: K3

LATITUDE/LONGITUDE: 394700.16N/0945501.01W TYPE: WP

AIRSPACE DOCKET: FIX TYPE OF ACTION: ESTABLISH

HOLDING: HOLDING TYPE OF ACTION: ESTABLISH

PATTERNS:

PAT	DIR	IDENT	TYPE	RAD/CRS/BRG	CRS INBOUND	TURN (L OR R)	LEG LENGTH TIME	DME	HOLDING ALTITUDES MIN	MAX	TEMPLATES MIN	MAX
1	NW		WP	347.08	147.08	R		4	3000	24000	5	17

CONTROLLING OBSTRUCTIONS:

PAT	AIRSPEED	OBSTRUCTION	COORDINATES	ELEVATION	ACCURACY
1	200	TOWER (31-1165)	3948.00.34N/0945358.93W	2735	2B

HOLDING RESTRICTIONS:  
HOLDING LIMITED TO ESTABLISHED PATTERN.

FIX USE:

USE TYPE	USE TITLE	FAC	PAT	AIRPORT IDENT	CITY	STATE
IAP	RNAV (GPS) RWY 15		1	STJ	ST JOSEPH	MO
IAP	RNAV (GPS) RWY 33			STJ	ST JOSEPH	MO

REQUIRED CHARTING: IAP

COMPULSORY REPORTING POINT: NO

RECORD REVISION NUMBER: ORIG DATE OF REVISION: MM/DD/YYYY

REASON FOR REVISION:

ATC COORDINATION: DATE: MM/DD/YYYY FACILITY: STJ APP CON NAME: ROGER OVER

INITIATED BY: DATE: ORGANIZATION: NAME:

OFFICE OF PRIMARY RESPONSIBILITY: XXXXX XXXXX, XXX-XXX

APPROVED BY: DATE: MM/DD/YYYY OFFICE: XXX-XXX NAME: GREGORY GRUMMAN

SIGNATURE:

DISTRIBUTION: NFDC  
FIFO  
FPT: XXX-XX  
ARTCC: ZKC  
ATC FACILITY: STJ APP CON.  
OTHER: MO AVIATION DIRECTOR

THIS PAGE IS INTENTIONALLY LEFT BLANK



Figure 4.

**RADIO FIX AND HOLDING DATA RECORD**

**NAME:** NITER OM **STATE:** TX **COUNTRY:** US **ICAO REGION CODE:** K4  
**LATITUDE/LONGITUDE:** 325423.25N/0965449.89W **TYPE:** INT, DME  
**AIRSPACE DOCKET:** **FIX TYPE OF ACTION:** MODIFY

**FIX MAKE-UP FACILITIES:**

FAC	NAME	IDENT	TYPE	CLASS	MAG BRG	TRUE BRG	DME	DIST FROM FAC NM	FAC FEET	MRA	MAA
1	NITER		OM		219.70	225.70		0.03		1900	5000
2	DALLAS	I-DAL	LOC/DME		309.64	315.64	5.59	5.59	33962	1900	5000
3	MAVERICK	TTT	VOR/DME	H	064.72	070.72		6.78		1900	5000

**FIX RESTRICTIONS:**

**REMARKS:**

I-DAL DME LAT/LONG: 325025.01N/0965009.33W (DME SERVES RWY 13L & 31R)  
COORDINATES REFLECT LOCATION ON LOC/AZ CENTERLINE ABEAM THE NITER OM. ACTUAL FACILITY LOCATION IS 325424.46N/0965448.42W.

**FIX USE:**

USE TYPE	USE TITLE	FAC	PAT	AIRPORT IDENT	CITY	STATE
IAP	ILS Y RWY 13L	1, 2, 3		KDAL	DALLAS	TX
SPECIAL IAP	ILS Z RWY 13L	1, 2, 3		KDAL	DALLAS	TX

**REQUIRED CHARTING:** IAP

**COMPULSORY REPORTING POINT:** NO

**RECORD REVISION NUMBER:** 5 **DATE OF REVISION:** MM/DD/YYYY

**REASON FOR REVISION:**

FAC 2 COURSE, DISTANCE, MRA AND MAA UPDATED.  
FIX USE UPDATED.  
LAT/LONG REVISED (MOVED 24 FT)

**ATC COORDINATION:** **DATE:** MM/DD/YYYY **FACILITY:** DAL APP CON **NAME:** TIM MOVER

**INITIATED BY:** **DATE:** **ORGANIZATION:** **NAME:**

**OFFICE OF PRIMARY RESPONSIBILITY:** XXXXX XXXXX, XXX-XXX

**APPROVED BY:** **DATE:** MM/DD/YYYY **OFFICE:** XXX-XXX **NAME:** BENJAMIN BOEING

**SIGNATURE:**

**DISTRIBUTION:** NFDC

FIFO  
FPT: XXX-XXX  
ARTCC: ZFW  
ATC FACILITY: DAL ATCT, DFW ATCT  
OTHER:

THIS PAGE IS INTENTIONALLY LEFT BLANK



THIS PAGE IS INTENTIONALLY LEFT BLANK

### Appendix F. ILS and RNAV Standard Instrument Approach Procedure, FAA Form 8260-3

This appendix contains examples of Form 8260-3.[see appendix F figure 1 through figure 3.

Figure 1.

**FEDERAL AVIATION ADMINISTRATION**  
**FLIGHT STANDARDS SERVICE**  
**ILS STANDARD INSTRUMENT APPROACH PROCEDURE**  
**TITLE 14 CFR PART 97.29**

Bearings, headings, courses, tracks and radials are magnetic. Elevations and altitudes are in feet. MSL, except HAT, HAA, TCH, and PA. Altitudes are minimum altitudes unless otherwise indicated. Ceilings are in feet above airport elevation. Distances are in nautical miles unless otherwise indicated, except variables which are in statute miles or feet RVR.

AIRPORT	AIRPORT ID	PROCEDURE NAME	ORIGINAL/AMENDMENT	CITY	STATE
LOS ANGELES INTL	KLAX	ILS OR LOC RWY 6R	17C	LOS ANGELES	CA
AIRPORT ELEVATION	IDZE	SUPERSEDED	ORIGINAL/AMENDMENT	DATED	EPOCH YEAR
128	114	ILS OR LOC RWY 6R	17B	01/09/2012	
FACILITY	COORDINATES OF FACILITIES	ACTUAL EFFECTIVE DATE	REQUIRED EFFECTIVE DATE	CANCEL/SUSPEND	
		02/04/2016	ROUTINE	SUSPEND	

---

**TERMINAL ROUTES**

FROM	FIX TYPE	TO	FIX TYPE	LEG TYPE	FOI/B	RNP	COURSE	DISTANCE	ALTITUDE
<b>Procedure suspended effective 03/01/2017</b>									

---

**MISSED APPROACH**  
MAP:

**MISSED APPROACH INSTRUCTIONS:**

**ALTERNATE MISSED APPROACH INSTRUCTIONS (DO NOT CHART):**

---

**PROFILE:**

1. PT	<input checked="" type="checkbox"/>	SIDE OF COURSE	OUTBOUND	FT WITHIN	MILES OF	(IAF)			
2.									
3. FAC:	<input type="checkbox"/>	FAF	DIST FAF TO MAP:	DIST FAF TO THLD:					
4. MIN ALT:									
5. DIST TO THLD FROM FAF:	MM:	100 HAT:	150 HAT:	HAT:	GS ANT:				
6. MIN GS INCPT:	GS ALT AT FAF:	MM:							
7. GS ANGLE:	34:1:	<input type="checkbox"/>	20:1:	<input checked="" type="checkbox"/>	TCH:				
8. MSA FROM:									

---

**EQUIPMENT REQUIREMENTS NOTES:**

**NOTES:**

**ADDITIONAL FLIGHT DATA:**

---

**MINIMUMS:**  
 TAKEOFF: SEE FAA FORM 8260-15A FOR THIS AIRPORT  
 ALTERNATE: NA

---

FAA Form 8260-3 (12/16) Supersedes Previous Edition Electronic Version Page 1 of 2

**AIRPORT** LOS ANGELES INTL      **AIRPORT ID** KLAX      **PROCEDURE NAME** ILS OR LOC RWY 6R      **ORIGINAL/AMENDMENT** 17C      **CITY** LOS ANGELES      **STATE** CA

CATEGORY:		A		B		C		D		E		
FINAL TYPE	DA/MDA	VIS	HAT/HAA	DA/MDA	VIS	HAT/HAA	DA/MDA	VIS	HAT/HAA	DA/MDA	VIS	HAT/HAA

**CHANGES - REASONS**

**COORDINATED WITH:**

A4A  ALPA  AOPA  APA  HAI  NBAA  OTHER:

**FLIGHT CHECKED BY**

**DEVELOPED BY**

**APPROVED BY**

**OFFICE**      **DATE**

**OFFICE**      **DATE**

AJV-XXXX      02/08/2017

**OFFICE**      **DATE**

AJV-XXXX      02/08/2017

**TITLE**

MANAGER

Figure 2.

Reset Form

FEDERAL AVIATION ADMINISTRATION  
 FLIGHT STANDARDS SERVICE  
 RNAV STANDARD INSTRUMENT APPROACH PROCEDURE  
 TITLE 14 CFR PART 97.33

TAA  COPTER

Bearings, headings, courses, tracks and radials are magnetic. Elevations and altitudes are in feet, MSL, except HAT, HAA, TCH, and RA. Altitudes are minimum altitudes unless otherwise indicated. Distances are in feet above airport elevation. Distances are in nautical miles unless otherwise indicated, except visibilities which are in statute miles or feet-PVR.

AIRPORT BELLINGHAM INTL AIRPORT ID KBLI AIRPORT NAME RNAV (RNP) Z RWY16 ORIGINAL/AMENDMENT 1 STATE WA

AIRPORT ELEVATION 170 TDZE 163 SUPERSEDED RNAV (RNP) Z RWY16 ORIGINAL/AMENDMENT ORIG-A DATED 05/29/2014 CITY BELLINGHAM MAG VAR 16E EPOCH YEAR 2020

FACILITY RNAV COORDINATES OF FACILITIES ACTUAL EFFECTIVE DATE 03/01/2017 REQUIRED EFFECTIVE DATE ROUTINE CANCEL/SUSPEND

TERMINAL ROUTES	FROM	FIX TYPE	TO	FIX TYPE	LEG TYPE	FO/FB	RNP	COURSE	DISTANCE	ALTITUDE
	UCAKI	IAF	CUSEL	TF	FB	1.00	352.60	6.53	2000	
	TECUV	IAF	APDON	TF	FB	1.00	053.99	9.35	2000	
	APDON	IF	HONUJ	TF	FB	1.00	061.05	5.92	2000	
	CUSEL	IF	HONUJ	RF	FB	1.00	(2.01 NM RADIUS CW (CFFVP))	2.40	2000	
	HONUJ		WUGUT	RF	FB	1.00	(2.01 NM RADIUS CW (CFFVP))	3.60	2000	
	SECOG	IF	WUGUT	TF	FB	1.00	163.85	6.00	2000	
	WUGUT	FAF	RW16	MAP	FO		163.85	5.61		
	RW16	MAP	700 MSL	CA			163.85		700	
	700 MSL		TECUV	DF	FO				2000	

MISSED APPROACH

MAP: RNP DA

MISSED APPROACH INSTRUCTIONS:

CLIMB TO 700 THEN CLIMBING RIGHT TURN TO 2000 DIRECT TECUV AND HOLD

ALTERNATE MISSED APPROACH INSTRUCTIONS (DO NOT CHART):

NA

PROFILE:

1. PT  SIDE OF COURSE OUTBOUND FT WITHIN MILES OF (IAF)
2. PROFILE STARTS AT WUGUT
3. FAC: 163.85 PFAF  DIST PFAF TO MAP: DIST PFAF TO THLD: 5.61
4. MIN ALT: WUGUT 2000
5. DIST TO THLD FROM PFAF: 5.61 MM: 150 HAT: 285 HAT: 0.74
6. MIN GP INCP: 2000 GP ALT AT PFAF: WAGUT 2000 MM: IM:

**AIRPORT:** BELLINGHAM INTL      **AIRPORT ID:** KBLI      **PROCEDURE NAME:** RNAV (RNP) Z RWY16      **ORIGINAL/AMENDMENT:** 1      **CITY:** BELLINGHAM      **STATE:** WA

7. **GP ANGLE:** 3.00    34:1: IS CLEAR  20:1:     TCH: 51.4

8. **MSA FROM:** RW 16 12000

**PBN EQUIPMENT REQUIREMENTS NOTES:**

RNP AR APCH, RADAR REQUIRED FOR ARRIVALS AT SECOG

**NOTES:**

CHART NOTE: FOR UNCOMPENSATED BARO-VNAV SYSTEMS, PROCEDURE NA BELOW -10C OR ABOVE 54C  
 CHART PLANVIEW NOTE: PROCEDURE NA FOR ARRIVAL AT TECUV ON V495 SOUTHWEST BOUND  
 CHART PROFILE NOTE: SEE PLANVIEW FOR MULTIPLE IF LOCATIONS  
 CHART PLANVIEW NOTE ADJACENT TO UCARI: RF REQUIRED  
 CHART PLANVIEW NOTE ADJACENT TO TECUV: RF REQUIRED  
 CHART SPEED ICON IN PLANVIEW AT CUSEL: MAX 180 KIAS  
 CHART SPEED ICON IN PLANVIEW AT HONU:V: MAX 180 KIAS  
 CHART NOTE: FOR INOPERATIVE MALSR: INCREASE RNP 0.27 ALL CATS VISIBILITY TO RVR 4500

**ADDITIONAL FLIGHT DATA:**

HOLD NW, RT, 135.90 INBOUND  
 #TCH 213.9 MSL (DO NOT CHART)

**MINIMUMS:**

**TAKEOFF: SEE FAA FORM 8260-15A FOR THIS AIRPORT**

**ALTERNATE:** NA  STANDARD

**CATEGORY:**

FINAL TYPE	A		B		C		D		E		
	DA/MDA	VIS	HAT/HAA	DA/MDA	VIS	HAT/HAA	DA/MDA	VIS	HAT/HAA	DA/MDA	VIS
RNP 0.27 DA	448	2400	285	448	2400	285	285	2400	285	285	2400
RNP 0.30 DA	580	4500	417	580	4500	417	417	4500	417	417	4500

AUTHORIZATION REQUIRED



AIRPORT  
BELLINGHAM INTL

AIRPORT ID  
KBLI

PROCEDURE NAME  
RNAV (RNP) Z RWY16

ORIGINAL/AMENDMENT  
1

CITY  
BELLINGHAM

STATE  
WA

- CHANGES - REASONS**
1. DELETED NOTE "WHEN LOCAL ALTIMETER SETTING NOT RECEIVED PROCEDURE NA". - SECONDARY ALTIMETER SETTING NOT PROVIDED
  2. ALL HEADINGS AND COURSES INCREASED 4 DEGREES DUE TO MAGVAR UPDATE - AIRPORT MAGVAR UPDATED FROM 20E/1985 TO 16E/2020
  3. ADDED CHART PLANVIEW NOTE AT SECOG: "RADAR REQUIRED FOR ARRIVAL AT SECOG". - REQUIRED FOR PROCEDURE ENTRY
  4. RNP 0.27 VISIBILITY CHANGED FROM 40 RVR TO 24 RVR AND 34:1 IS NOT CLEAR NOTE CHANGED TO 34:1 IS CLEAR - RUNWAY 16 VISUAL SURFACES ARE VERIFIED CLEAR
  5. RNP 0.30 DAHAT CHANGED FROM 576/413 TO 580/417 - INCREASED DUE TO MISSED CONTROLLING OBSTACLE 53-000538 ELEVATION INCREASED FROM 290 MSL TO 294 MSL
  6. CHANGED CHART PLANVIEW NOTE AT HONUUV: MAX 180 KIAS TO CHART SPEED ICON IN PLANVIEW AT HONUUV: MAX 180 KIAS - FAAO 8260.19H PARA 4-6-10G
  7. CHANGED CHART PLANVIEW NOTE AT CUSEL: MAX 180 KIAS TO CHART SPEED ICON IN PLANVIEW AT CUSEL: MAX 180 KIAS - FAAO 8260.19H PARA 4-6-10G
  8. CHANGED THE UNCOMPENSATED BARO-VNAV SYSTEMS, PROCEDURE NA BELOW -11C OR ABOVE 47C TO UNCOMPENSATED BARO-VNAV SYSTEMS, PROCEDURE NA BELOW -10C OR ABOVE 54C - PER AFS LOW/HIGH TEMPERATURE CALCULATOR
  9. CHANGED RF RADIUS FROM 2.00 TO 2.01 AND RF CENTERPOINT CFFVP FIX MOVED FROM 485342.650N/1223518.39W 60FT WEST TO 485342.650N/1223519.287W - IPDS REQUIRES RF RADIUS TO BE A VALUE GREATER THAN 2.00 FOR PROCEDURE DESIGN; FIX MOVED TO IPDS CALCULATED FIX COORDINATES
  10. CUSEL MOVED FROM 485400.96N/1223818.12W 125FT WEST TO 485400.747N/1223819.974W - IPDS CALCULATED LOCATION BASED ON RF SEGMENT CALCULATION
  11. HONUUV MOVED FROM 485539.62N/1223558.39W 113FT WEST TO 485540.139N/1223559.888W - IPDS CALCULATED LOCATION BASED ON RF SEGMENT CALCULATION
  12. UCAKI TO CUSEL DISTANCE CHANGED FROM 6.54 TO 6.53 - IPDS CALCULATED LOCATION BASED ON RF SEGMENT CALCULATION
  13. CUSEL TO HONUUV DISTANCE CHANGED FROM 2.38 TO 2.40 - IPDS CALCULATED LOCATION BASED ON RF SEGMENT CALCULATION
  14. APOND TO HONUUV DISTANCE CHANGED FROM 5.93 TO 5.92 - IPDS CALCULATED LOCATION BASED ON RF SEGMENT CALCULATION
  15. HONUUV TO WUGUT DISTANCE CHANGED FROM 3.58 TO 3.60 - IPDS CALCULATED LOCATION BASED ON RF SEGMENT CALCULATION
  16. HOLDING AT TECUV CHANGED FROM 131.90 INBOUND TO 135.90 INBOUND - DUE TO MAGVAR UPDATE

**COORDINATED WITH:**

A4A  ALPA  AOPA  APA  HAI  NBAA  OTHER: ZSE, YYJ APP CON, BLI ATCT, AMGR, WFPT

**FLIGHT CHECKED BY**

**DEVELOPED BY**

**APPROVED BY**

<b>OFFICE</b>	<b>DATE</b>
AJW-XXXX	
<b>OFFICE</b>	<b>DATE</b>
AJV-XXXX	
<b>OFFICE</b>	<b>DATE</b>
AJV-XXXX	

**TITLE**  
MANAGER

THIS PAGE INTENTIONALLY LEFT BLANK



**AIRPORT:** FORT MORGAN MUNI      **AIRPORT ID:** KFMM      **PROCEDURE NAME:** RNAV (GPS) RWY 14      **ORIGINAL/AMENDMENT:** 1      **CITY:** FORT MORGAN MUNI      **STATE:** CO

**ALTERNATE MISSED APPROACH INSTRUCTIONS (DO NOT CHART):**

NA

**PROFILE:**

1. **PT**  **SIDE OF COURSE**      **OUTBOUND**      **FT WITHIN**      **MILES OF**      **(IAF)**
2. HOLD NW ECUDI, RT, 143.53 INBOUND, 7400 IN LIEU OF PT (IAF), MAX 14000
3. **FAC:** 143.58 **PFAP**  **FEPAS**      **DIST PFAP TO MAP:** 4.94      **DIST PFAP TO THLD:** 4.94
4. **MIN ALT:** ECUDI 7400, FEPAS 6200, GISEY 2.30 NM TO RW14 5340\*
5. **DIST TO THLD FROM PFAP:**      **MM:**      **IM:**      **150 HAT:**      **250 HAT:** 0.69
6. **MIN GP INCP:** 6200 **GP ALT AT PFAP:** FEPAS 6200      **MM:**      **IM:**
7. **GP ANGLE:** 3.00      34:1: IS CLEAR  20:1:       **TCH:** 30.0
8. **MSA FROM:**

**PBN EQUIPMENT REQUIREMENTS NOTES:**

RNP APCH

**NOTES:**

**CHART NOTE:** WHEN LOCAL ALTIMETER SETTING NOT RECEIVED, USE AKRON ALTIMETER SETTING: INCREASE ALL DA TO 4828 FT AND ALL VISIBILITIES 1/8 MILE. INCREASE ALL MDAS 100 FT AND ALL CAT C AND D VISIBILITIES 1/4 MILE.  
**CHART NOTE:** CIRCLING RWY 8, 17, 26, 32, 35 NA AT NIGHT.  
**CHART PROFILE NOTE:** \*RNAV ONLY

**ADDITIONAL FLIGHT DATA:**

HOLD SE, RT, 323.71 INBOUND  
 CHART FAS OBST: 4754 RD (N) 402238N/1035036W  
 CHART VDP AT 1.18 MILES TO RW14  
 WAAS CHANNEL #86330  
 REFERENCE PATH ID: W14A  
 CHART CIRCLING ICON  
 LTP HAE: 1381.2 M

**MINIMUMS:**

**TAKEOFF: SEE FAA FORM 8260-15A FOR THIS AIRPORT**

**ALTERNATE:** NA  STANDARD - NA WHEN LOCAL WEATHER NOT AVAILABLE, CAT D 800 - 2 1/2

CATEGORY:	A			B			C			D			E				
	FINAL TYPE	DA/MDA	VIS	HAT/HAA	DA/MDA	VIS	HAT/HAA	DA/MDA	VIS	HAT/HAA	DA/MDA	VIS	HAT/HAA	DA/MDA	VIS	HAT/HAA	
LPV DA	4845	1	250	4845	1	250	4845	1	250	4845	1	250	4845	1	250	4845	1
LNAV/NAV DA	4845	1	250	4845	1	250	4845	1	250	4845	1	250	4845	1	250	4845	1
LNAV MDA	5000	1	405	5000	1	405	5000	1 1/8	405	5000	1 1/8	405	5000	1 1/8	405	5000	1 1/8
CIRCLING	5040	1	445	5080	1	485	5120	1 1/2	525	5340	1 1/2	745					

AIRPORT  
FORT MORGAN MUNI

AIRPORT ID  
KFMM

PROCEDURE NAME  
RNAV (GPS) RWY 14

ORIGINAL/AMENDMENT  
1

CITY  
FORT MORGAN MUNI

STATE  
CO

**CHANGES - REASONS**

- 1. CHANGED HEADINGS FOR TERMINAL ROUTES FROM: DEKTE-ECUDI 053.43, CAPVA-ECUDI 233.68, ECUDI-FEPAS 143.95, FEPAS-RW14 143.60, RWY14-4969 MSL 143.60; TO: DEKTEECUDI 053.40, CAPVA-ECUDI 233.65, ECUDI-FEPAS 143.53, FEPAS-RW14 143.58, RWY14-4969 MSL 143.58 - RWY 14 LOCATION SHIFT AND PFAF FORMULA CALCULATION
- 2. DIST FAF TO MAP/THLD CHANGED FROM 4.98 TO 4.94 - RWY 14 LOCATION SHIFT AND PFAF FORMULA CALCULATION
- 3. RAISED ALTITUDE FOR ECUDI IFFAF FROM 7000 TO 7400 - PER FPT CHECKLIST REQUEST.
- 4. RAISED MISSED APPROACH HOLDING ALTITUDE AT HARPU FROM 7000 TO 7400 - PER FPT CHECKLIST REQUEST
- 5. CHANGED HOLDING INBOUND COURSE FOR ECUDI ON LINE 2 - RWY LOCATION CHANGED CAUSED IFFAF REALIGNMENT
- 6. CHANGED TCH FROM 45 TO 30 - PER FPT CHECKLIST REQUEST.
- 7. CHANGED 34:1 DATA ON LINE 7 FROM "IS NOT CLEAR" TO "IS CLEAR" - NO 34:1 OBSTRUCTIONS FOUND
- 8. CHANGED MISSED APPROACH HOLDING AT HARPU INBOUND COURSE FROM 323.72 TO 323.71 - RWY LOCATION CHANGED CAUSED IFFAF REALIGNMENT FOR RWY 32 WHICH THE MISSED APPROACH HOLDING FIX
- 9. UPDATED FAS OBSTACLE DATA IN ADDITIONAL FLIGHT DATA - NEW OBSTACLE INFO CAUSED FROM RWY SHIFT
- 10. ADDED VDP DATA TO ADDITIONAL FLIGHT DATA - VDP NOW CHARTABLE BECAUSE OF NO 20:1 PENETRATIONS
- 11. ADDED "CHART CIRCLING ICON" TO ADDITION FLIGHT DATA - IAW FAAO 8260.19H, PARA 8-6-10T
- 12. ADDED DIST TO THLD FORM 250 HAT TO ADDITIONAL FLIGHT DATA - DUE TO LPV LINE OF MINIMA BEING CHARTED
- 13. ADDED LPV AND LNAV/VNAV LINES OF MINIMA - PER FPT CHECKLIST REQUEST.
- 14. REMOVE LP LINE OF MINIMA - DUE TO LPV LINE AND LNAV/VNAV LINES OF MINIMA BEING CHARTED
- 15. UPDATED LNAV HAT FROM 432 ALL CATS TO 405 ALL CATS - RWY 14 LOCATION SHIFT, AND USE OF TDZE INSTEAD OF THRE
- 16. CHANGED LNAV CAT C/D VIS FROM 1 1/4 TO 1 1/8 - IAW VISI CHECK CALCULATOR
- 17. CHANGED CIRCLING MINS FROM: CAT A 5000/432 VIS 1, CAT B 5020/451 VIS 1, CAT C 5040/471 VIS 1 1/2, CAT D 5140/571 VIS 2; TO: CAT A 5040/445 VIS 1, CAT B 5080/465 VIS 1, CAT C 5120/525 VIS 1 1/2, CAT D 5340/7451 VIS 2 1/2 - RWY 14 LOCATION SHIFT, NEW CIRCLING AREA RADIUS USED AND VISI CHECK CALCULATOR USED
- 18. CIRCLING RWY 8, 17, 26, 32, 35 NA AT NIGHT - FPT CHECKLIST REQUEST, DUE TO 20:1 PENETRATION TO RWY 32
- 19. REMOVED NOTE: "WHEN VGSJ INOP, STRAIGHT-IN/CIRCLING RWY 14 PROCEDURES NA AT NIGHT" - NO LONGER NEEDED WITHOUT 20:1 PENETRATIONS
- 20. REMOVED NOTE: "VISIBILITY REDUCTION BY HELICOPTERS NA" - NO LONGER NEEDED WITHOUT 20:1 PENETRATIONS
- 21. REMOVED NOTE: "DME/DME RNP-0.3 NA" - NO LONGER REQUIRED IAW FAAO 8260.19H
- 22. CHANGED TAA RADIAL FROM 053 TO 054 - FIX LOCATION CHANGES DUE TO RWY SHIFT
- 23. CHANGED BOTH TAA STEPDOWN ARCS FROM 8NM TO 15NM - PER FPT CHECKLIST REQUEST.
- 24. CHANGED TAA STRAIGHT-IN OUTER AREA FROM 7700 TO 8000, AND RIGHT BASE OUTER AREA FROM 7800 TO 8100 - ROC REDUCTION NOT ALLOWED IN TAA (AP-408)

**COORDINATED WITH:**

A4A  ALPA  AOPA  APA  HAI  NBAA  OTHER: ZDV, AMGR

**FLIGHT CHECKED BY**

OFFICE  
AJW-XXXX

DATE

**DEVELOPED BY**

OFFICE  
AJV-XXXX

DATE

**APPROVED BY**

OFFICE  
AJV-XXXX

TITLE  
MANAGER

DATE

AIRPORT  
FORT MORGAN MUNI

AIRPORT ID  
KFMM

PROCEDURE NAME  
RNAV(GPS) RWY 14

ORIGINAL/AMENDMENT  
1

CITY  
FORT MORGAN MUNI

STATE  
CO

**EAS DATA BLOCK INFORMATION**

DATA FIELD	DATA
OPERATION TYPE	0
SBAS SERVICE PROVIDER IDENTIFIER	0
AIRPORT IDENTIFIER	KFMM
RUNWAY	RW14
APPROACH PERFORMANCE DESIGNATOR	0
ROUTE INDICATOR	0
REFERENCE PATH DATA SELECTOR	W14A
REFERENCE PATH IDENTIFIER (APPROACH ID)	402041.4650N
LTP/FTP LATITUDE	1034842.0900W
LTP/FTP LONGITUDE	00030.0
LTP/FTP ELLIPSOIDAL HEIGHT	401923.0220N
FPAP LATITUDE	1034746.7010W
FPAP LONGITUDE	00030.0
THRESHOLD CROSSING HEIGHT (TCH)	F
TCH UNITS SELECTOR (METERS OR FEET USED)	03.00
GLIDE PATH ANGLE (GPA)	106.75
COURSE WIDTH AT THRESHOLD	1000
LENGTH OFFSET	40
HORIZONTAL ALERT LIMIT (HAL)	50
VERTICAL ALERT LIMIT (VAL)	
CRC REMAINDER	8F1D0606

**ADDITIONAL PATH POINT RECORD INFORMATION**

ICAO CODE	K2
LTP ORTHOMETRIC HEIGHT	+14006
FPAP ORTHOMETRIC HEIGHT	+14006

Figure 4.

**FEDERAL AVIATION ADMINISTRATION**  
**FLIGHT STANDARDS SERVICE**  
**ILS - STANDARD INSTRUMENT APPROACH PROCEDURE**  
**TITLE 14 CFR PART 97.29**

---

**TAA**  **COPTER**

**AIRPORT** DANE COUNTY RGNL-TRUAX FIELD  
**AIRPORT ID** KMSN  
**PROCEDURE NAME** ILS OR LOC RWY 18  
**ORIGINAL/AMENDMENT** 2  
**CITY** MADISON  
**STATE** WI

**AIRPORT ELEVATION** 887  
**TDZE** 864  
**SUPERSEDED** ILS OR LOC/DME RWY 18  
**ORIGINAL/AMENDMENT** 1D  
**DATED** 04/02/2015  
**MAG VAR** 3W  
**EPOCH YEAR** 2020

**FACILITY** I-DSZ  
**COORDINATES OF FACILITIES** 43.0717,7.4N/089.2026,90W  
**ACTUAL EFFECTIVE DATE** 04/13/2017  
**REQUIRED EFFECTIVE DATE** ROUTINE  
**CANCEL/SUSPEND**

---

**TERMINAL ROUTES**

FROM	FIX TYPE	TO	FIX TYPE	LEG TYPE	FO/FB	RNP	COURSE	DISTANCE	ALTITUDE
MSN VORTAC	<input type="checkbox"/>	RUKY INT/I-DSZ 6.56 DME/RADAR	<input type="checkbox"/>		<input type="checkbox"/>		358.20	5.16	3000
DLL VORTAC	<input type="checkbox"/>	DECAL INT/15.65 DME	<input type="checkbox"/>	NOPT	<input type="checkbox"/>		114.94	21.46 (MSN LR-351)	3000
DECAL INT/15.65 DME	<input type="checkbox"/>	GATNE INT/9.79 DME	<input type="checkbox"/>		<input type="checkbox"/>		184.94	5.87 (I-DSZ)	2700
GATNE INT/9.79 DME	<input type="checkbox"/>	RUKY INT/I-DSZ 6.56 DME/RADAR	<input type="checkbox"/>		<input type="checkbox"/>		184.94	3.23 (I-DSZ)	2500

---

**MISSED APPROACH**  
**MAP:**  
 ILS: DA  
 LOC: 1.59 DME

**MISSED APPROACH INSTRUCTIONS:**  
 CLIMB TO 2700 ON MSN VORTAC R-180 TO MONAH INT/MSN VORTAC 4.93 DME/RADAR AND HOLD.  
**ALTERNATE MISSED APPROACH INSTRUCTIONS (DO NOT CHART):**  
 CLIMB TO 1400 THEN CLIMBING LEFT TURN TO 3500 ON HEADING 070 AND ON BAE VORTAC R-270 TO DREAR/BAE 33.66 DME AND HOLD

---

**PROFILE:**

- PT L  SIDE OF COURSE 004.94 OUTBOUND 2800 FT WITHIN 10 MILES OF RUKY (IAF)
- 
- FAC: 184.94 FAF  RUKY INT/I-DSZ 6.56 DME/RADAR DIST FAF TO MAP: DIST FAF TO THLD: 4.97
- MIN ALT: RUKY 2500, JOGRI/I-DSZ 3.19 DME 1420\*
- DIST TO THLD FROM FAF: MIM: 100 HAT: 904 150 HAT: 1858 HAT: GS ANT: 1094
- MIN GS INCP: 2500 GS ALT AT FAF: RUKY 2500 MIM: IM:
- GS ANGLE: 3:00 34:1:  20:1:  TCH: 57.3
- MSA FROM: MSN VORTAC 360-180 3100, 180-360 3600

---

FAA Form 8260-3 (12/16) Supersedes Previous Edition Electronic Version Page 1 of 4

**AIRPORT:** DANIE COUNTY RGNL-TRUAX FIELD      **AIRPORT ID:** KMSN      **PROCEDURE NAME:** ILS OR LOC RWY 18  
**ORIGINAL/AMENDMENT:** 2      **CITY:** MADISON      **STATE:** WI

**EQUIPMENT REQUIREMENTS NOTES:**

**NOTES:**  
**SA CAT I ILS - SPECIAL AIRCREW AND AIRCRAFT CERTIFICATION REQUIRED:** S-ILS 18: CAT A, B, C, D, RA 153, RVR 1400, HAT 150, DA 1014 MSL  
**SA CAT II ILS - SPECIAL AIRCREW AND AIRCRAFT CERTIFICATION REQUIRED:** S-ILS 18: CAT A, B, C, D, RA 103, RVR 1200, HAT 100, DA 963 MSL  
**CHART NOTE:** \*\* RVR 1800 AUTHORIZED WITH USE OF FD OR AP OR HUD TO DA  
**CHART PLANVIEW NOTE:** PROCEDURE TURN NA FOR CAT E  
**CHART NOTE:** FOR INOPERATIVE MALSR, INCREASE S-ILS 18 CAT E VISIBILITY TO RVR 4000 AND S-LOC 18 CATS C/D/E VISIBILITY TO RVR 5500  
**CHART PROFILE NOTE:** USE I-DSZ DME WHEN ON THE LOCALIZER COURSE  
**CHART PROFILE NOTE:** \*LOC ONLY  
**SA CAT I CHART NOTE:** REQUIRES SPECIFIC OPSEC, MSPEC, OR LOA APPROVAL AND USE OF HUD TO DH  
**CHART NOTE:** SA CAT I: S-ILS R18 NA WHEN CONTROL TOWER CLOSED  
**SA CAT II CHART NOTE:** REQUIRES SPECIFIC OPSEC, MSPEC, OR LOA APPROVAL AND USE OF AUTOLAND OR HUD TO TOUCHDOWN  
**CHART NOTE:** SA CAT II: S-ILS R18 NA WHEN CONTROL TOWER CLOSED  
**ADDITIONAL FLIGHT DATA:**  
 HOLDS RT, 000.20 INBOUND  
 CHART IN PLANVIEW: ALTERNATE MA HOLDING, HOLD W DREAR/BAE 33.66 DME, LT 090.43 INBOUND  
 CHART FAS OBST: 979 TREE 431058N/0890006W  
 FAS OBST: 1210 AAO 431349N/0891923W  
 CHART VDP AT 2.60 DME  
 DISTANCE VDP TO THLD 1.01 MILES  
 CHART CIRCLING ICON  
 CHART: MSN R-180 AT MONAH

**MINIMUMS:**  
**TAKEOFF: SEE FAA FORM 8260-15A FOR THIS AIRPORT**  
**ALTERNATE:** NA  ILS: STANDARD - CAT D 900 - 2 3/4, CAT E 900 - 3, NA WHEN CONTROL TOWER CLOSED; LOC: STANDARD - CAT D 900 - 2 3/4, CAT E 900 - 3, NA WHEN CONTROL TOWER CLOSED

CATEGORY:	A			B			C			D			E			
	FINAL TYPE	DA/MDA	VIS	HAT/HAA	DA/MDA	VIS	HAT/HAA	DA/MDA	VIS	HAT/HAA	DA/MDA	VIS	HAT/HAA	DA/MDA	VIS	HAT/HAA
S-ILS 18**		1064	2400	200	1064	2400	200	1064	2400	200	1064	2400	200	1064	2400	200
S-LOC 18		1240	2400	376	1240	2400	376	1240	3500	376	1240	3500	376	1240	3500	376
CIRCLING		1420	1	533	1460	1	573	1460	1 1/2	573	1700	2 3/4	813	1700	3	813



AIRPORT DANIE COUNTY RGNL-TRUAX FIELD

AIRPORT ID KMSN

PROCEDURE NAME  
ILS OR LOC RWY 18  
ILS RWY 18 (SA CAT I)  
ILS RWY 18 (SA CAT II)

ORIGINAL/AMENDMENT  
2

CITY MADISON

STATE WI

**CHANGES - REASONS**

1. GANITE DME FIX DESCRIPTION CHANGE FROM MSN 8.39 TO I-DSZ 9.79 - DME NOW FROM I-DSZ VICE MSN VORTAC
2. DECAL TO GANITE COURSE CHANGED FROM 181.94 TO 184.94 - UPDATED MAGVAR FROM 0E/1990 TO 3W/2020
3. GANITE TO RUKIY COURSE CHANGED FROM 181.94 TO 184.94 - UPDATED MAGVAR FROM 0E/1990 TO 3W/2020
4. RUKIY DME FIX DESCRIPTION CHANGE FROM MSN 5.16 TO I-DSZ 6.56 - DME NOW FROM I-DSZ VICE MSN VORTAC
5. LINE 3 - FAC CHANGED FROM 181.94 TO 184.94 - UPDATED MAGVAR FROM 0E/1990 TO 3W/2020
6. LINE 4 - ADDED STEPDOWN FIX JOGRI/I-DSZ 3.19 DME 1430 - STEPDOWN FIX ADDED TO GET LOWER LOC MINIMUMS
7. LINE 5 - ADDED 150 HAT 1858 AND 100 HAT 904 - ADDED STEPDOWN FIX JOGRI
8. S-LOC 18 MDA/HAT CHANGED FROM 1340/476 TO 1240/376 ALL CATS. CAT C/D/E VIS CHANGED FROM 5000 TO 3500 - ADDED STEPDOWN FIX JOGRI
9. CHANGED CIRCLING CAT A MDA/HAA FROM 1520/633 TO 1420/533 - TEMP CRANE DRIVING CIRCLING MINS FROM PREVIOUS AMENDMENT HAS BEEN REMOVED AND NEW CIRCLING CRITERIA USED PER FAAO 8260.3C/PARA 2-7-1
10. CHANGED CIRCLING CAT B AND C MDA/HAA FROM 1520/633 TO 1460/573 - TEMP CRANE DRIVING CIRCLING MINS FROM PREVIOUS AMENDMENT HAS BEEN REMOVED AND NEW CIRCLING CRITERIA USED PER FAAO 8260.3C, PARA. 2-7-1
11. CHANGED CIRCLING CAT D MDA/HAA FROM 1520/633 TO 1700/813 - TEMP CRANE DRIVING CIRCLING MINS FROM PREVIOUS AMENDMENT HAS BEEN REMOVED AND NEW CIRCLING CRITERIA USED PER FAAO 8260.3C/PAR 2-7-1
12. CHANGED CIRCLING CAT C VISIBILITY FORM 1 3/4 TO 1 1/2 AND CAT D FROM 2 TO 2 3/4 - TEMP CRANE DRIVING CIRCLING MINS FROM PREVIOUS AMENDMENT HAS BEEN REMOVED AND NEW CIRCLING CRITERIA USED PER FAAO 8260.3C/PAR 2-7-1
13. CHANGED LOC MISSED APPROACH POINT DESCRIPTION FROM MSN 0.20 TO I-DSZ 1.59 DME - DME NOW FROM I-DSZ VICE MSN VORTAC
14. MISSED APPROACH INSTRUCTIONS CHANGED FROM "CLIMB TO 2700 DIRECT MONAH LOM/MSN 4.94 DME/RADAR" TO "CLIMB TO 2700 ON MSN VORTAC R-180 TO MONAH INT/MSN 4.93 DME/RADAR" - MONAH LOM DECOMMISSIONED
15. HOLDING COURSE INBOUND CHANGED FROM 002.51 TO 000.20 IN ADDITIONAL FLIGHT DATA - ALIGNED MISSED APPROACH HOLDING INBOUND COURSE WITH MSN VORTAC RADIAL 180
16. FAS OBSTACLE CHANGED FROM 1079 TREE TO 979 TREE - USED 200' AAO VICE 100' TREE IN FINAL SEGMENT IAW FAAO 8260.19, PARA 2-11-5
17. ADDED 7:1 OBSTACLE 1210 AAO TO ADDITIONAL FLIGHT DATA - USED 200' AAO VICE 100' TREE IN FINAL SEGMENT IAW FAAO 8260.19, PARA 2-11-5
18. ADDED CHART VDP AT 2.60 DME TO ADDITIONAL FLIGHT DATA - FINAL FACILITY NOW HAS ASSOCIATED DME SO VDP WAS ADDED TO PROCEDURE
19. ADDED DISTANCE VDP TO THLD 1.01 MILE TO ADDITIONAL FLIGHT DATA - FINAL FACILITY NOW HAS ASSOCIATED DME SO VDP WAS ADDED TO PROCEDURE
20. ADDED CHART CIRCLING ICON TO ADDITIONAL FLIGHT DATA - PER CRITERIA FAAO 8260.19, PARA 8-6-10T
21. ADDED SA CAT I AND SA CAT II AND ASSOCIATED DATA - CAT I AND CAT II PROCEDURES ADDED PER AIRPORT REQUEST
22. ADDED SA CAT I CHART NOTE: REQUIRES SPECIFIC OPSEC, MSPEC, OR LOA APPROVAL AND USE OF HUD TO DH - CAT I AND CAT II PROCEDURES ADDED PER AIRPORT REQUEST
23. ADDED SA CAT II CHART NOTE: REDUCED LIGHTING: REQUIRES SPECIFIC OPSEC, MSPEC, OR LOA APPROVAL AND USE OF AUTOLAND OR HUD TO TOUCHDOWN - CAT I AND CAT II PROCEDURES ADDED PER AIRPORT REQUEST
24. ALTERNATE MINIMUMS UPDATED: ILS: CAT D 900-2 3/4, CAT E 900 - 3 AND LOC: CAT D 900 - 2 3/4, CAT E 900 - 3 - NEW CIRCLING CAT D CONTROLLING OBSTACLE DUE TO LARGER RADII WITH NEW CIRCLING CRITERIA INCREASED CIR CAT D MDA TO 1700
25. ADDED CHART IN PLANVIEW ONLY: DLL 21.46 DME AT DECAL - FOR PROCEDURE DESIGN TO PREVENT LOCALIZER FALSE COURSE
26. UPDATED INOP MALSR NOTE FROM "INCREASE S-LOC 18 CATS C, D AND E VISIBILITY TO 1 3/8" TO "INCREASE S-LOC 18 CAT E VISIBILITY TO RVR 4000 AND S-LOC 18 CATS C/D/E VISIBILITY TO RVR 5500" - UPDATED PROCEDURE EVALUATION
27. MAGVAR CHANGED FROM 0E/1990 TO 3W/2020 IN ADDITIONAL FLIGHT DATA - UPDATED MAGVAR FROM 0E/1990 TO 3W/2020
28. DELETED NOTE: "CHART 3000 PRIOR TO RUKIY IN PROFILE" - NOTE NOT REQUIRED
29. ADDED "CHART PROFILE NOTE: USE OF I-DSZ DME WHEN ON THE LOCALIZER COURSE" - PER CRITERIA FAAO 8260.19, PARA 8-2-5F
30. DELETED NOTE: "MSN DME REQUIRED FOR PROCEDURE TURN" - NOTE NOT REQUIRED
31. DELETED MISSED APPROACH INSTRUCTION "OR AS DIRECTED BY ATC" - FAAO 8260.19 NO LONGER REQUIRES THIS TEXT.

**AIRPORT** DANE COUNTY RGNI-TRUAX FIELD      **AIRPORT ID** KMSN      **PROCEDURE NAME** ILS OR LOC RWY 18  
 ILS RWY 18 (SA CAT I)  
 ILS RWY 18 (SA CAT II)      **ORIGINAL/AMENDMENT** 2      **CITY** MADISON      **STATE** WI

**COORDINATED WITH:**

A4A  ALPA

AOPA

APA

HAI

NBAA

**OTHER:** ZAU, MSN ATCT, AMGR, ANG/DOBA

**FLIGHT CHECKED BY**

<b>OFFICE</b>	<b>DATE</b>
AJW-XXXX	

**DEVELOPED BY**

<b>OFFICE</b>	<b>DATE</b>
AJV-XXXX	

**APPROVED BY**

<b>OFFICE</b>	<b>DATE</b>	<b>TITLE</b>
AJV-XXXX		MANAGER

### Appendix G. Radar – Standard Instrument Approach Procedure, FAA Form 8260-4

This appendix contains an example of Form 8260-4, Radar - Standard Instrument Approach Procedure [see appendix G figure 1].

Figure 1.

**FEDERAL AVIATION ADMINISTRATION**  
**FLIGHT STANDARDS SERVICE**  
**RADAR - STANDARD INSTRUMENT APPROACH PROCEDURE**  
**TITLE 14 CFR PART 97.31**

Bearings, headings, courses, tracks and radials are magnetic. Elevations and altitudes are in feet, MSL, except HAT, HAA, TCH, and DA. Altitudes are minimum altitudes unless otherwise indicated. Ceiling is in feet above airport elevation. Distances are in nautical miles unless otherwise indicated, except visibilities which are in statute miles or feet RVR.

Initial approach minimum altitudes shall correspond with those established for enroute operation in the particular area or as set forth below. Positive identification must be established with the radar controller. From initial contact with radar to final authorized landing minimums, the instructions of the radar controller are mandatory except when: (A) visual contact is established on final approach or before descent to the authorized landing minimums, or (B) at pilot's discretion it appears desirable to discontinue the approach. Except when the radar controller may direct otherwise prior to final approach, a missed approach shall be executed by the radar controller for more than 30 seconds during a surveillance approach, (E) directed by radar controller for more than 30 seconds during a surveillance approach, (F) directed by radar controller for more than 30 seconds during a surveillance approach, or (D) if landing is not accomplished.

AIRPORT	AIRPORT ID	PROCEDURE NAME	ORIGINAL/AMENDMENT	STATE
ATLANTIC CITY INTL	KACY	RADAR-1	16	NJ
AIRPORT ELEVATION	TDZE	SUPERSEDED	ORIGINAL/AMENDMENT	EPOCH YEAR
75		RADAR-1	15	2020
FACILITY	COORDINATES OF FACILITIES	ACTUAL EFFECTIVE DATE	REQUIRED EFFECTIVE DATE	CANCEL/SUSPEND
ACY ASR		03/01/2017	ROUTINE	

Use Facility MVA

---

RADAR TERMINAL AREA MANEUVERING SECTORS AND ALTITUDES (Sectors and distances measured from radar antenna)

FROM	TO	DISTANCE	ALTITUDE	DISTANCE	ALTITUDE	DISTANCE	ALTITUDE
AS ESTABLISHED BY THE CURRENT ATLANTIC CITY ASR MINIMUM VECTORING ALTITUDE							

---

**MISSED APPROACH**

MAP:  
RWY 4, 13, 22, 31 - THRESHOLD

**MISSED APPROACH INSTRUCTIONS:**  
RWY 4, 31: CLIMBING RIGHT TURN TO 2000 ON ACY R-090 TO SMITS INT71.00 DME AND HOLD E, RT, 270.00 INBOUND  
RWY 13, 22: CLIMBING LEFT TURN TO 2000 ON ACY R-090 TO SMITS INT71.00 DME AND HOLD E, RT, 270.00 INBOUND

**ALTERNATE MISSED APPROACH INSTRUCTIONS (DO NOT CHART):**  
NA

---

**NOTES:**  
RWY 4: FAF 5 MILES FROM THRESHOLD, MINIMUM ALTITUDE 1600, MINIMUM ALTITUDE 2 MILE FIX 700, FINAL APPROACH COURSE 039.96, RECOMMEND ALTITUDES: 4 MILES 1300, 3 MILES 1000, 2 MILES 700  
RWY 13: FAF 5 MILES FROM THRESHOLD, MINIMUM ALTITUDE 1600, MINIMUM ALTITUDE 2 MILE FIX 720, FINAL APPROACH COURSE 129.93, RECOMMEND ALTITUDES: 4 MILES 1300, 3 MILES 1000, 2 MILES 700  
RWY 22: FAF 5 MILES FROM THRESHOLD, MINIMUM ALTITUDE 1600, MINIMUM ALTITUDE 2 MILE FIX 720, FINAL APPROACH COURSE 212.03, RECOMMEND ALTITUDES: 4 MILES 1300, 3 MILES 1000, 2 MILES 720  
RWY 31: FAF 5 MILES FROM THRESHOLD, MINIMUM ALTITUDE 1800, MINIMUM ALTITUDE 2 MILE FIX 800, FINAL APPROACH COURSE 310.07, RECOMMEND ALTITUDES: 4 MILES 1460, 3 MILES 1140, 2 MILES 800

CHART NOTE: FOR INOPERATIVE MALSR, INCREASE S-13 CAT C/D/E RVR 6000  
CHART NOTE: RWY 4 HELICOPTER VISIBILITY REDUCTION BELOW 3/4 SM NOT AUTHORIZED

**LOST COMMUNICATIONS (ALL RWYS):** AS DIRECTED BY ATC ON INITIAL CONTACT.

**ADDITIONAL FLIGHT DATA:**  
 TDZE: 68.3 RWY: 4 IDZE: 74.8 RWY: 13 TDZE: 67.5 RWY: 22 TDZE: 63.5 RWY: 31  
 FAS OBST: RWY 04 - 158 POLE 392537.77N/0743508.49W; RWY 13 - 217 TOWER 392705.00N/0743556.00W; RWY 22 - 245 TOWER 392837.00N/0743222.00W; RWY 31 - 171 TOWER 392717.63N/0743310.86W; CHART: CIRCLING ICON

---

**MINIMUMS:**  
 TAKEOFF: SEE FAA FORM 8260-15A FOR THIS AIRPORT  
 ALTERNATE: NA STANDARD: CAT E 800 - 2 1/2

---

FAA Form 8260-4 (12/16) Supersedes Previous Edition

Electronic Version
Page 1 of 2

AIRPORT  
ATLANTIC CITY INTL

AIRPORT ID  
KACY

PROCEDURE NAME  
RADAR-1

ORIGINAL/AMENDMENT  
16

CITY  
ATLANTIC CITY

STATE  
NJ

CATEGORY:	A			B			C			D			E				
	FINAL TYPE	DA/MDA	HAT/HAA	VIS	HAT/HAA	DA/MDA	VIS	HAT/HAA	DA/MDA	VIS	HAT/HAA	DA/MDA	VIS	HAT/HAA	DA/MDA	VIS	HAT/HAA
S-4	480	412	1	480	412	1	480	412	480	1 1/8	412	480	1 1/8	412	480	1 1/8	412
S-13	480	405	2400	480	405	2400	480	405	480	4000	405	480	4000	405	480	4000	405
S-22	560	492	1	560	492	1	560	492	560	1 3/8	492	560	1 3/8	492	560	1 3/8	492
S-31	480	416	5500	480	416	5500	480	416	480	6000	416	480	6000	416	480	6000	416
CIRCLING	560	465	1	600	525	1	620	545	640	2	565	760	2 1/2	685			

**CHANGES - REASONS**

1. CHANGED RWY 4 CATS C/D/E VISIBILITY FROM 1 1/4 TO 1 1/8 - FAAO 8260.3C TABLE 3-3-1
2. CHANGED RWY 13 CATS D/E VISIBILITY FROM RVR 5000 TO RVR 4000 - FAAO 8260.3C TABLE 3-3-1
3. ADDED ASSUMED OBSTACLES AND STEP-DOWNS TO FINAL FOR RWYS 4/13 AND 22 - FAAO 8260.19H PARA 2-11-5
4. CHANGED RWY 22 MDA FROM 600 TO 560 AND CATS C/D/E VISIBILITY FOR 1 1/2, 1 3/4 AND 2 TO 1 3/8 - DESCENT GRADIENT, NEW CONTROLLING OBSTACLE AND FAAO 8260.3C TABLE 3-3-1
5. CHANGED RWY 31 MINIMUM ALTITUDES AT 5 NM AND 2NM FROM 1600 TO 720 AND 1800 TO 800 - NEW RWY 31 MVA AND DESCENT ANGLE
6. CHANGED RWY 31 NM RECOMMENDED ALTITUDE FROM 1020 TO 1000 - NEW DESCENT ANGLE CALCULATIONS
7. CHANGED RWY 31 RECOMMENDED ALTITUDES AT 4, 3, AND 2 NM FROM 1300, 1020, AND 720 TO 1460, 1140 AND 800
8. CHANGED RWY 31 VISIBILITIES FROM SM TO RVR - RWY 31 NOW EQUIPPED WITH RVR
9. RAISED CAT B/C CIRCLING MDA FROM 560 TO 600 AND 620 - ORDER 8260.3C, CIRCLING CRITERIA
10. CHANGED RWY 13 INOP MALSR NOTE FROM CAT D VISIBILITY TO RVR 6000 AND CAT E TO 1 1/2 TO CAT E TO RVR 6000 - INOP TABLE AND FAAO 8260.3C, TABLE 3-3-1

**COORDINATED WITH:**

A4A  ALPA  AOPA  APA  HAI  NBAA  OTHER:

**FLIGHT CHECKED BY**

OFFICE  
AJW-XXXX

DATE

**DEVELOPED BY**

OFFICE  
AJV-XXXX

DATE

**APPROVED BY**

OFFICE  
AJV-XXXX

DATE

TITLE  
MANAGER

### Appendix H. Standard Instrument Approach Procedure, FAA Form 8260-5

This appendix contains an example of Form 8260-5, Standard Instrument Approach Procedure [see appendix H figure 1 and figure 2].

Figure 1.

**FEDERAL AVIATION ADMINISTRATION**  
**FLIGHT STANDARDS SERVICE**

**LOC - STANDARD INSTRUMENT APPROACH PROCEDURE**  
**TITLE 14 CFR PART 97.25**

BEARINGS, HEADINGS, COURSES, TRACKS AND RADIALS ARE MAGNETIC. ELEVATIONS AND ALTITUDES ARE IN FEET, MSL, EXCEPT HAT, HAA, TCH, and EA. ALTITUDES ARE MINIMUM ALTITUDES UNLESS OTHERWISE INDICATED. CHARTS ARE IN FEET ABOVE AIRPORT ELEVATION. DISTANCES ARE IN STATUTE MILES UNLESS OTHERWISE INDICATED, EXCEPT DISTANCES WHICH ARE IN STATUTE MILES OR FEET PVR.

---

**AIRPORT** SHREVEPORT RGNL  
**AIRPORT ELEVATION** 258  
**FACILITY** I-MWP

**AIRPORT ID** KSHV  
**TDZE** 237  
**COORDINATES OF FACILITIES** N322717.82 W0934643.01

**PROCEDURE NAME** LOC RWY 6  
**SUPERSEDED** LOC RWY 6  
**ACTUAL EFFECTIVE DATE** 03/01/2017

**ORIGINAL/AMENDMENT** 3  
**ORIGINAL/AMENDMENT** 2A  
**REQUIRED EFFECTIVE DATE** ROUTINE

**CITY** SHREVEPORT  
**DATED** 06/26/2014  
**CANCEL/SUSPEND**

**STATE** LA  
**EPOCH YEAR** 2020

**MAG. VAR** 2E  
**DISTANCE** 6.00 (I-MWP)  
**ALTITUDE** 2000

---

**TERMINAL ROUTES**

FROM	FIX TYPE	TO	FIX TYPE	LEG TYPE	FO/FB	RNP	COURSE	DISTANCE	ALTITUDE
GIGGS/I-MWP	IF	DODDY/I-MWP	6.01 DME/RADAR				058.90	6.00 (I-MWP)	2000

---

**MISSED APPROACH**  
MAP:  
LOC: 4.77 MILES AFTER DODDY/I-MWP 6.01 DME/RADAR OR AT I-MWP 1.24 DME FIX

**MISSED APPROACH INSTRUCTIONS:**  
CLIMB TO 700 THEN CLIMBING RIGHT TURN TO 2000 DIRECT EMG VORTAC AND HOLD  
CLIMB TO 700 THEN CLIMBING LEFT TURN TO 4000 DIRECT EIC VORTAC AND HOLD

**ALTERNATE MISSED APPROACH INSTRUCTIONS (DO NOT CHART):**  
CLIMB TO 700 THEN CLIMBING LEFT TURN TO 4000 DIRECT EIC VORTAC AND HOLD

---

**PROFILE:**

- PT  **SIDE OF COURSE** OUTBOUND FT WITHIN MILES OF (IAF)
- PROFILE STARTS AT GIGGS/I-MWP 12.01 DME/RADAR
- FAC: 058.90 FAF:  DODDY/I-MWP 6.01 DME/RADAR DIST FAF TO MAP: 4.77 DIST FAF TO THLD: 4.77
- MIN ALT: GIGGS/I-MWP 12.01 DME/RADAR, DODDY/I-MWP 6.01 DME/RADAR, WOXATI-I-MWP 2.44 DME 700
- MSA FROM: EMG VORTAC 3100

---

**EQUIPMENT REQUIREMENTS NOTES:**  
RADAR REQUIRED FOR PROCEDURE ENTRY. DME OR RADAR REQUIRED TO DEFINE FIXES GIGGS AND DODD

**NOTES:**  
CHART NOTE: HELICOPTER VISIBILITY REDUCTION BELOW 3/4 SM NOT AUTHORIZED  
CHART PROFILE NOTE: VGS/ AND DESCENT ANGLES NOT COINCIDENT (VGS) ANGLE (ANGLE)/TCH (FEET)

**ADDITIONAL FLIGHT DATA:**  
HOLD NW, LT, 120.00 INBOUND; CHART IN PLANVIEW; ALTERNATE MA HOLDING, HOLD N EIC VORTAC, RT, 171.00 INBOUND; CHART FAS OBST: 362 TREE 322615N/0935037W, 489 AAO 322358N/0933456W; CHART IN PLANVIEW; EIC VORTAC; DODDY TO RW06: 3.38/91.2; CHART: ASR; CHART: CIRCLING ICON.

---

**MINIMUMS:**  
TAKEOFF: SEE FAA FORM 8260-15A FOR THIS AIRPORT  
ALTERNATE: NA  STANDARD - CAT D 900 - 2 3/4, CAT E 900 - 3

---

FAA Form 8260-5 (12/16) Supersedes Previous Edition

Electronic Version

Page 1 of 2

AIRPORT  
SHREVEPORT RGNL

AIRPORT ID  
KSHV

PROCEDURE NAME  
LOC RWY 6

ORIGINAL/AMENDMENT  
3

CITY  
SHREVEPORT

STATE  
LA

CATEGORY:	A			B			C			D			E		
	FINAL TYPE	DA/MDA	HAT/HAA	DA/MDA	VIS	HAT/HAA	DA/MDA	VIS	HAT/HAA	DA/MDA	VIS	HAT/HAA	DA/MDA	VIS	HAT/HAA
S-LOC 06	700	463	1	700	1	463	700	1 3/8	463	700	1 3/8	463	700	1 3/8	463
CIRCLING	740	760	1	760	1	502	980	2	722	1100	3	842	1100	3	842
WOXAT FIX MINIMUMS															
S-LOC 06	620	383	1	620	1	383	620	1 1/8	383	620	1 1/8	383	620	1 1/8	383
CIRCLING	740	482	1	760	1	502	980	2	722	1100	2 3/4	842	1100	3	842

**CHANGES - REASONS**

1. CHANGED HMWP MAG VAR/EPOCH YEAR FROM 4E 1995 TO 2E 2020 - CURRENT AIRNAV DATA
2. CHANGED FAC FROM 056.90 TO 058.90 - RESULT OF MAG VAR UPDATE
3. CHANGED MSA FROM EMG VORTAC - 280-010 3100, 010-280 2100 TO EMG VORTAC 3100 - CONTINUITY WITH OTHER PROCEDURES AT SHREVEPORT RGNL
4. CHANGED CAT A CIRCLING MDA/HAA FROM 800/542 TO 740/482, CAT B FROM 800/542 TO 760/502, CAT C FROM 800/542 TO 980/722 AND CAT D FROM 820/562 TO 1100/842. CHANGED CAT C CIRCLING VIS FROM 1 1/2 TO 2 AND CAT D FROM 2 TO 2 3/4 - APPLICATION OF NEW CIRCLING RADII AND CURRENT OBSTACLE DATABASE
5. CHANGED ALTERNATE MINIMUMS FROM CAT E 900- 2 3/4 TO CAT E 900-3 - APPLICATION OF NEW CIRCLING RADII AND CURRENT OBSTACLE DATABASE
6. CHANGED CHART NOTE FROM HELICOPTER VISIBILITY REDUCTION BELOW 1 SM NOT AUTHORIZED TO HELICOPTER VISIBILITY REDUCTION BELOW 3/4 SM NOT AUTHORIZED - VISUAL SURFACE PENETRATIONS ARE 34:1 NOT 20:1
7. CHANGED PROFILE NOTE FROM VGSI AND DESCENT ANGLES NOT COINCIDENT TO VGSI AND DESCENT ANGLES NOT COINCIDENT (VGSI ANGLE (ANGLE)/TCH (FEET)) - CURRENT FORMAT
8. ADDED EQUIPMENT REQUIREMENTS NOTES - FAAO 8260.19H, PARA 8-6-8

**COORDINATED WITH:**

A4A  ALPA  AOPA  APA  HAI  NBAA  OTHER:

**FLIGHT CHECKED BY**

OFFICE  
AJW-XXXX

**DEVELOPED BY**

OFFICE  
AJV-XXXX

**APPROVED BY**

OFFICE  
AJV-XXXX

TITLE  
MANAGER

### Appendix I. Special Instrument Approach Procedure, FAA Form 8260-7A and Special Instrument Procedure Authorization, FAA Form 8260-7B

This appendix contains an example of Form 8260-7A [see appendix I figure 1] and Form 8260-7B [see appendix I figure 2].

Figure 1.

**FEDERAL AVIATION ADMINISTRATION  
FLIGHT STANDARDS SERVICE**

**COPTER RNAV - SPECIAL INSTRUMENT APPROACH PROCEDURE  
SPECIFICATION - NOT FOR COCKPIT USE**

Bearings, headings, courses, tracks and radials are magnetic. Elevations and altitudes are in feet. MSL, except HAT, HAA, TCH, and RA. Altitudes are minimum altitudes unless otherwise indicated. Distances are in nautical miles unless otherwise indicated, except visibilities which are in statute miles or feet. RVR. If an instrument approach procedure of the above type is conducted at the below named airport, it shall be conducted in accordance with a charted instrument approach procedure published on the specifications contained herein, unless an approach is conducted in accordance with a different procedure for such airport authorized by the Administrator. Minimum altitudes shall correspond with those established for enroute operations in the particular area or as set forth below.

Reset Form

---

**TAA**  **COPTER**  **PROCEDURE**  **VFR**   
**AIRSHIP**  **HELIPORT**

Reset Form

---

**HELIPORT ID** K8111

**HELIPORT** METHODIST HOSPITAL OF IN. INC

**SURFACE ELEVATION** 729

**FACILITY** RNAV

**PROCEDURE NAME** COPTER RNAV (GPS) 060

**ORIGINAL/AMENDMENT** ORIGINAL/AMENDMENT

**REQUIRED EFFECTIVE DATE** 03/30/2017

**ROUTINE**

---

**COORDINATES OF FACILITIES**

**TDZE**

**CITY** INDIANAPOLIS

**MAG VAR** 4W

**DATED**

**CANCEL/SUSPEND**

---

FROM	TO	FIX TYPE	LEG TYPE	FO/FB	RNP	COURSE	DISTANCE	ALTITUDE
COVPU	HIBAL	IAF	TF	FB		330.72	3.00	3100
FVAX	HIBAL	IAF	TF	FB		149.28	3.00	3100
HIBAL	JEKLO	IF	TF	FB		059.93	3.00	2000
JEKLO	MEDRE	FAF	TF	FO		059.98	2.00	
MEDRE	1280 MSL	MAP	CA			059.98		
1280 MSL	ORBUE		DF	FO				3100

---

**TERMINAL ROUTES**

**STATE** IN

**EPOCH YEAR** 2010

---

**MISSED APPROACH**

**MAP:** LNAV: MEDRE

**MISSED APPROACH INSTRUCTIONS:** CLIMB TO 3100 DIRECT ORBUE AND HOLD

**ALTERNATE MISSED APPROACH INSTRUCTIONS (DO NOT CHART):** NA

**PROFILE:**

- PT  SIDE OF COURSE OUTBOUND FT WITHIN MILES OF (IAF)
- PROFILE STARTS AT HIBAL
- FAC: 059.98 PFAF: JEKLO DIST PFAF TO MAP: 2.00 DIST PFAF TO THLD:
- MIN ALT: HIBAL 3100, JEKLO 2000
- DIST TO THLD FROM PFAF: MIM: 150 HAT: HAT:
- MIN GP INCPT: GP ALT AT PFAF: MIM: IM:
- GP ANGLE: 34:1 GP ALT AT PFAF: IM: TCH:
- MSA FROM: MEDRE 3100

---

FAA Form 8260-7A (12/16) Supersedes Previous Edition

Electronic Version

---

FAA Form 8260-7A (12/16) Supersedes Previous Edition

Page 1 of 2

HELIPORT: METHODIST HOSPITAL OF IN. INC      HELIPORT ID: K8111      PROCEDURE NAME: COPTER RNAV (GPS) 060      ORIGINAL/AMENDMENT: ORIG      CITY: INDIANAPOLIS      STATE: IN

**PBN EQUIPMENT REQUIREMENTS NOTES:**

RNP APCH

**NOTES:**

**CHART PLANVIEW NOTE:** LIMIT FINAL AND MISSED APPROACH TO 70 KIAS; **CHART PLANVIEW NOTE:** LIMIT INITIAL AND INTERMEDIATE APPROACH TO 90 KIAS; **CHART PLANVIEW NOTE:** PROCEED VFR FROM MEDRE OR CONDUCT THE SPECIFIED MISSED APPROACH; **CHART NOTE:** USE OF METHODIST HOSPITAL OF IN. INC REQUIRES PERMISSION OF THE OWNER. USE OF THIS PROCEDURE REQUIRES SPECIFIC AUTHORIZATION BY FAA FLIGHT STANDARDS; **CHART NOTE:** USE INDIANAPOLIS DOWNTOWN ALTIMETER SETTING, WHEN NOT RECEIVED USE INDIANAPOLIS INTL. ALTIMETER SETTING; **CHART PLANVIEW NOTE:** INCREASE TO 90 KIAS UPON REACHING MISSED APPROACH ALTITUDE

**ADDITIONAL FLIGHT DATA:**

HOLD SW, RT, 060.04 INBOUND  
CHART FAS OBST: 949 TOWER 394703N/0861108W  
CHART 1017 TOWER 394654N/0860931W  
CHART INDIANAPOLIS DOWNTOWN HELIPORT AWOS-3

**MINIMUMS:**

TAKEOFF: SEE FAA FORM 8260-15A FOR THIS HELIPORT

ALTERNATE: NA

**CATEGORY:**

FINAL TYPE	DA/MDA	COPTER VIS	HAS	DA/MDA	B VIS	HAT/HAA	DA/MDA	C VIS	HAT/HAA	DA/MDA	D VIS	HAT/HAA	DA/MDA	E VIS	HAT/HAA
LNAV MDA	1280	3/4	551												

**CHANGES - REASONS**

ORIGINAL PROCEDURE - FPT REQUEST

SUBMITTED BY

FLIGHT CHECKED BY

DEVELOPED BY

RECOMMENDED BY

APPROVED BY

OFFICE	DATE	OFFICE	DATE	OFFICE	DATE	OFFICE	DATE	OFFICE	DATE	OFFICE	DATE	TITLE
												MANAGER
												MANAGER



Figure 2.

FEDERAL AVIATION ADMINISTRATION  
FLIGHT STANDARDS SERVICE  
SPECIAL INSTRUMENT PROCEDURE AUTHORIZATION

CITY AND STATE	AIRPORT NAME / AIRPORT ID	PROCEDURE NAME
HAINES, AK	HAINES (HNS) (PAHN)	RNAV (GPS)-A, AMDT 1

ORIGINATING OFFICE  
AFS-470, PERFORMANCE BASED FLIGHT SYSTEMS BRANCH

The following requirements may contain information considered proprietary by the operator.

a. **Classification:** Training and Operational Information Requirements

(1) Instrument Procedure Requirements:

This instrument approach procedure requires a missed approach with a minimum climb of 320 ft/NM to 3000 ft and an airspeed restriction to not exceed 140 KIAS until the COKKA waypoint. Procedure is for category A and B aircraft only;

(2) Operator Requirements:

The operator must provide each pilot assigned to conduct operations using this approach procedure with ground training, flight training, and operational conducting operations using this procedure. The training must include:

- (a) Aircraft specific operational capabilities and limitations associated with Technical Standard Order (TSO) C145a/C146a (or later revision that meets or exceeds the accuracy of this TSO/revision as approved by the Administrator) compliant Global Positioning System (GPS), and Wide Area Augmentation System (WAAS) receivers and navigation system displays;
- (b) The unique requirements associate with the Haines, AK RNAV arrival, special instrument approach, and departure procedures;
- (c) Initial and annual aircraft flight demonstration(s) of pilot proficiency to include approach, missed approach, departure and en route procedures at Haines, AK.
- (d) The operator must provide performance information to the pilot for use in the cockpit that will permit the pilot to determine whether the aircraft is capable, under the meteorological conditions that exist upon arrival at/departure from the destination.

(3) Inspector Guidance:

The Principal Operations Inspector must review the procedure with the certificate holder. During this review, the operator must show that each make/model/series (and variant) of aircraft intended for use on this procedure, has the performance capability to meet or exceed the aircraft missed approach/departure climb gradient. In addition the POI should evaluate the operator's proposed training program, and if applicable, operations manuals, checklists, or other operational documents, to determine their suitability for supporting safe IFR operations using this Instrument Approach Procedure (see Operator Requirements above).

FEDERAL AVIATION ADMINISTRATION  
FLIGHT STANDARDS SERVICE  
SPECIAL INSTRUMENT PROCEDURE AUTHORIZATION

CITY AND STATE	AIRPORT NAME / AIRPORT ID	PROCEDURE NAME
HAINES, AK	HAINES (HNS) (PAHN)	RNAV (GPS)-A, AMDT 1

**b. Classification:** Equipment Requirement

(1) Instrument Procedure Requirements:

This procedure is designed for RNAV-equipped aircraft that uses advanced avionics. Technical Standards Order (TSO) C145a/C146a (or later revision that meets or exceeds the accuracy of this TSO/revision as approved by the Administrator) compliant Global Positioning System (GPS) and Wide Area Augmentation System (WAAS) receivers.

(2) Operator Requirements:

The operator must ensure that only aircraft equipped with dual TSO C145a/C146a (or later revision that meets or exceeds the accuracy of this TSO/revision as approved by the Administrator) compliant Global Positioning System (GPS) and Wide Area Augmentation System (WAAS) receivers are used to conduct this procedure.

(3) Inspector Guidance:

The Principal Operations Inspector (POI) must evaluate the operator's procedures, and if applicable, operations manuals, checklists, or other operational documents, to determine they include methods to ensure properly equipped aircraft are used for this Instrument Approach Procedure (see Operator Requirements above).

**c. Classification:** Airport Operations Requirement

(1) Instrument Procedure Requirements:

None.

(2) Operator Requirements:

None.

(3) Inspector Guidance:

None.

**d. Classification:** Simulator Requirements

(1) Instrument Procedure Requirements:

If an interactive training device or aircraft simulator is used it must contain Haines, AK features specific to this procedure.

(2) Operator Requirements:

The interactive training device or aircraft simulator, if used by the operator, must contain Haines, AK features specific to this procedure, otherwise, an aircraft equipped with a TSO C145a/C146a (or later revision that meets or exceeds the accuracy of this TSO/revision as approved by the Administrator) compliant GPS and WAAS receiver must be used for pilot training and proficiency checks.

(3) Inspector Guidance:

The Principal Operations Inspector must evaluate the operator's program, procedures, and training equipment to determine their suitability for supporting safe IFR operations using this Instrument Approach Procedure (see Operator Requirements above). For operators without an approved training program, such as 14 CFR Part 91 and 135 single pilot operators, the POI will approve training and qualification procedures which meet the requirements listed in the operator's requirements paragraph above.

FEDERAL AVIATION ADMINISTRATION  
FLIGHT STANDARDS SERVICE  
SPECIAL INSTRUMENT PROCEDURE AUTHORIZATION

CITY AND STATE \_\_\_\_\_ AIRPORT NAME / AIRPORT ID \_\_\_\_\_ PROCEDURE NAME \_\_\_\_\_  
HAINES, AK \_\_\_\_\_ HAINES (HNS) (PAHN) \_\_\_\_\_ RNAV (GPS)-A, AMDT 1 \_\_\_\_\_

This Special Instrument Procedure must be conducted in accordance with the instructions specified within and the operator's minima as specified in appropriate Letter of Authorization or operations/management specifications.

RECOMMENDED BY: \_\_\_\_\_ OFFICE \_\_\_\_\_ DATE \_\_\_\_\_  
NAME: James P. Doe \_\_\_\_\_ AFS-4XX \_\_\_\_\_ MM/DD/YYYY \_\_\_\_\_  
APPROVED BY: \_\_\_\_\_ OFFICE \_\_\_\_\_ DATE \_\_\_\_\_  
NAME: Mary J. Smith \_\_\_\_\_ AFS-4XX \_\_\_\_\_ MM/DD/YYYY \_\_\_\_\_

\_\_\_\_\_ Name/Operator/Carrier \_\_\_\_\_ FAA Designator/Cert No. \_\_\_\_\_ hereby acknowledges receipt of this \_\_\_\_\_

Special Instrument Procedure to the following Airport Name/Identifier: \_\_\_\_\_  
Aircraft authorized (optional): \_\_\_\_\_

DATE: \_\_\_\_\_ RECEIVED BY \_\_\_\_\_ PRINTED NAME & TITLE \_\_\_\_\_ SIGNATURE \_\_\_\_\_

BY THE DIRECTOR OF THE ADMINISTRATOR \_\_\_\_\_ PRINTED NAME & TITLE \_\_\_\_\_ SIGNATURE \_\_\_\_\_

EFFECTIVE DATE: \_\_\_\_\_

THIS PAGE IS INTENTIONALLY LEFT BLANK

### Appendix J. Standard Instrument Approach Procedure, FAA Form 8260-9

This appendix contains examples of Form 8260-9, Standard Instrument Approach Procedure Data Record, [see appendix J figure 1 through figure ].

Figure 1.

FEDERAL AVIATION ADMINISTRATION FLIGHT STANDARDS SERVICE															
STANDARD INSTRUMENT APPROACH PROCEDURE DATA RECORD															
AIRPORT	AIRPORT ID	PROCEDURE NAME	AMDT NO.	CITY	STATE	AIRPORT ELEVATION	FACILITY								
BELLINGHAM INTL	KBLI	RNAV (RNP) Z RWY 16	1	BELLINGHAM	WA	170	RNAV								
<b>PART A: OBSTRUCTION DATA SEGMENTS</b>															
<b>INITIAL</b>	<input type="button" value="v"/>														<input type="button" value="+"/> <input type="button" value="-"/>
<b>FROM</b>	UCAKI														
<b>RNP</b>	1.00	<b>DISTANCE</b>	6.53	<b>PAT</b>		<b>MAP</b>		<b>HAT</b>		<b>HMAS</b>					
<b>OBSTRUCTION</b>															
1. AAO	485130.00N/1223718.00W	<b>ELEVMSL</b>	565	<b>HORZ</b>	50	<b>VERT</b>	AC	<b>ROC</b>	1000	<b>OCS</b>	<b>CG</b>	<b>CGTA</b>	<b>ADJUSTMENTS</b>	<b>MIN ALT</b>	
2. TERRAIN	485133.00N/1223718.00W		365 (400)										AT435	2000	
													AS1500	1900	
<b>COMPUTATIONS</b>															
Select from menu... <input type="button" value="v"/> <b>ALT</b> <b>KIAS</b> <b>KTAS</b> <b>HAA</b> <b>VKTW</b> <b>TR</b> <b>BA</b> <b>DTA</b> <b>COURSE CHANGE</b> <b>DVEB</b> <b>VEB OCS</b> <b>RF CENTER FIX/DISTANCE</b>															
<b>SEGMENT REMARKS:</b> UCAKI TRANSITION CONNECTED TO RNAV STAR															
<b>INITIAL</b>	<input type="button" value="v"/>														<input type="button" value="+"/> <input type="button" value="-"/>
<b>FROM</b>	TECVU														
<b>RNP</b>	1.00	<b>DISTANCE</b>	9.35	<b>PAT</b>		<b>MAP</b>		<b>HAT</b>		<b>HMAS</b>					
<b>OBSTRUCTION</b>															
3. REFINERY (55-000262)	485307.00N/1224418.00W	<b>ELEVMSL</b>	408	<b>HORZ</b>	100	<b>VERT</b>	AC	<b>ROC</b>	1000	<b>OCS</b>	<b>CG</b>	<b>CGTA</b>	<b>ADJUSTMENTS</b>	<b>MIN ALT</b>	
4. TERRAIN	485330.00N/1224721.00W		155 (200)										AT1992	2000	
													AS1500	1900	
<b>COMPUTATIONS</b>															
Select from menu... <input type="button" value="v"/> <b>ALT</b> <b>KIAS</b> <b>KTAS</b> <b>HAA</b> <b>VKTW</b> <b>TR</b> <b>BA</b> <b>DTA</b> <b>COURSE CHANGE</b> <b>DVEB</b> <b>VEB OCS</b> <b>RF CENTER FIX/DISTANCE</b>															
<b>SEGMENT REMARKS:</b> TECVU TRANSITION CONNECTED TO ENROUTE ENVIRONMENT															
<b>INTERMEDIATE</b>	<input type="button" value="v"/>														<input type="button" value="+"/> <input type="button" value="-"/>
<b>FROM</b>	APDON														
<b>RNP</b>	1.00	<b>DISTANCE</b>	5.92	<b>PAT</b>		<b>MAP</b>		<b>HAT</b>		<b>HMAS</b>					

**AIRPORT:** BELLINGHAM INTL      **AIRPORT ID:** KBLI      **PROCEDURE NAME:** RNAV (RNP) Z RWY 16      **AMDT NO.:** 1      **CITY:** BELLINGHAM      **STATE:** WA      **AIRPORT ELEVATION:** 170      **FACILITY:** RNAV

OBSTRUCTION	COORDINATES	ELEV MSL	HORZ	VERT	AC	ROC	OCS	CG	CGTA	ADJUSTMENTS	MIN ALT
5. AAO	485312.00N/1223845.00W	558	50	50	2D	500				AT942	2000
6. TERRAIN	485312.00N/1223845.00W	358 (400)								AS1500	1900

**COMPUTATIONS**  
Select from menu...      **ALT:**  **KIAS**      **HAA:**      **VKTW:**      **TR:**      **BA:**      **DTA:**      **COURSE CHANGE:**      **DVEB:**      **VEB\_OCS:**      **RF CENTER FIX/DISTANCE:**

**SEGMENT REMARKS:**

**INTERMEDIATE**            **TO:** HONVU      **HAT:**      **HMAS:**       **+** **-**

RNP	DISTANCE	PAT	MAP	HAT	HMAS						
1.00	2.40										
OBSTRUCTION	COORDINATES	ELEV MSL	HORZ	VERT	AC	ROC	OCS	CG	CGTA	ADJUSTMENTS	MIN ALT
7. AAO	485300.00N/1223830.00W	561	50	50	2D	500				AT939	2000
8. TERRAIN	485300.00N/1223830.00W	361 (400)								AS1500	1900

**COMPUTATIONS**  
**RF SEGMENT**       **ALT:** 3500      **KIAS:** 180      **KTAS:** 195      **HAA:** 3330      **VKTW:** 54      **TR:** 2.01      **BA:** 24      **DTA:**      **COURSE CHANGE:**      **DVEB:**      **VEB\_OCS:**      **RF CENTER FIX/DISTANCE:** (CFFVP)/2.4 NM  
CUSEL-HONVU  
**SEGMENT REMARKS:**  
MAX SPEED CUSEL TO HOVUV - 180 KIAS

**INTERMEDIATE: STEPDOWN**            **TO:** WUGUT      **HAT:**      **HMAS:**       **+** **-**

RNP	DISTANCE	PAT	MAP	HAT	HMAS						
1.00	3.60										
OBSTRUCTION	COORDINATES	ELEV MSL	HORZ	VERT	AC	ROC	OCS	CG	CGTA	ADJUSTMENTS	MIN ALT
9. AAO	485739.00N/1223224.00W	338	50	50	2D	500				AT1162	2000
10. TERRAIN	485739.00N/1223224.00W	138 (100)								AS1500	1600

**COMPUTATIONS**  
**RF SEGMENT**       **ALT:** 2900      **KIAS:** 180      **KTAS:** 193      **HAA:** 2730      **VKTW:** 53      **TR:** 2.01      **BA:** 24      **DTA:**      **COURSE CHANGE:**      **DVEB:**      **VEB\_OCS:**      **RF CENTER FIX/DISTANCE:** (CFFVP)/3.6 NM  
HONVU-WUGUT  
**SEGMENT REMARKS:**  
MAX SPEED HOVUV TO WUGUT - 180 KIAS

**AIRPORT** BELLINGHAM INTL      **AIRPORT ID** KBLI      **PROCEDURE NAME** RNAV (RNP) Z RWY 16      **AMDT NO.** 1      **CITY** BELLINGHAM      **STATE** WA      **AIRPORT ELEVATION** 170      **FACILITY** RNAV

+ -

**INTERMEDIATE**  
**FROM** WUGUT      **TO** WUGUT  
**SECOG**  
**RNP** 1.00      **DISTANCE** 6.00      **PAT**      **MAP**      **HAT**      **HMAS**  
**OBSTRUCTION**  
 11. AAO      **COORDINATES** 490042.00N/1223518.00W      **ELEV MSL** 479      **HORZ** 50      **VERT** 50      **AC** 2D      **ROC** 500      **OCS**      **CG**      **CGTA**      **ADJUSTMENTS** AT899 VEB122      **MIN ALT** 2000  
 12. TERRAIN      485903.00N/1223357.00W      253 (300)      253 (300)      **AS1500**      1800

**COMPUTATIONS**  
 Select from menu...      **ALT**      **KIAS**      **KTAS**      **HAA**      **VKTW**      **TR**      **BA**      **DTA**      **COURSE CHANGE**      **DVEB**      **VEB OCS**      **RF CENTER FIX/DISTANCE**

**SEGMENT REMARKS:**  
 RADAR REQUIRED FOR PROCEEDURE ENTRY AT SECOG

+ -

**FINAL**  
**FROM** WUGUT      **TO** RWY16  
**RNP** 0.30      **DISTANCE**      **PAT**      **MAP** DA      **HAT** 417      **HMAS**  
**OBSTRUCTION**  
**COORDINATES**      **ELEV MSL**      **HORZ**      **VERT**      **AC**      **ROC**      **OCS**      **CG**      **CGTA**      **ADJUSTMENTS** MA167      **MIN ALT** 580

**COMPUTATIONS**  
 Select from menu...      **ALT**      **KIAS**      **KTAS**      **HAA**      **VKTW**      **TR**      **BA**      **DTA**      **COURSE CHANGE**      **DVEB** 3757      **VEB OCS** 21.15:1      **RF CENTER FIX/DISTANCE**

**SEGMENT REMARKS:**

+ -

**FINAL**  
**FROM** WUGUT      **TO** RWY16  
**RNP** 0.27      **DISTANCE** 5.61      **PAT**      **MAP** DA      **HAT** 285      **HMAS**

**AIRPORT** BELLINGHAM INTL      **AIRPORT ID** KBLI      **PROCEDURE NAME** RNAV (RNP) Z RWY 16      **AMDT NO.** 1      **CITY** BELLINGHAM      **STATE** WA      **AIRPORT ELEVATION** 170      **FACILITY** RNAV  
**OBSTRUCTION**      **COORDINATES**      **ELEV MSL**      **HORZ**      **VERT**      **AC**      **ROC** ASC      **OCS**      **CG**      **CGTA**      **ADJUSTMENTS** MA35      **MIN ALT** 448

**COMPUTATIONS**  
 Select from menu...      **ALT**      **KIAS**      **KTAS**      **HAA**      **VKTW**      **TR**      **BA**      **DTA**      **COURSE CHANGE**      **DVEB** 3505      **VEB\_OCS** 21.15:1      **RF CENTER FIX/DISTANCE**

**SEGMENT REMARKS:**

**MISSED APPROACH**      **TO**      **FROM**      **DA**      **RNP**      **DISTANCE**      **PAT**      **MAP**      **HAT**      **HMAS** 419      **OBSTRUCTION**      **COORDINATES**      **ELEV MSL**      **HORZ**      **VERT**      **AC**      **ROC** ASC      **OCS**      **CG**      **CGTA**      **ADJUSTMENTS**      **MIN ALT**

**COMPUTATIONS**  
 Select from menu...      **ALT**      **KIAS**      **KTAS**      **HAA**      **VKTW**      **TR**      **BA**      **DTA**      **COURSE CHANGE**      **DVEB**      **VEB\_OCS**      **RF CENTER FIX/DISTANCE**

**SEGMENT REMARKS:**

**MISSED APPROACH**      **TO**      **FROM**      **DA**      **RNP**      **DISTANCE**      **PAT**      **MAP**      **HAT**      **HMAS**      **OBSTRUCTION**      **COORDINATES**      **ELEV MSL**      **HORZ**      **VERT**      **AC**      **ROC** ASC      **OCS**      **CG**      **CGTA**      **ADJUSTMENTS**      **MIN ALT**

**COMPUTATIONS**  
 Select from menu...      **ALT**      **KIAS**      **KTAS**      **HAA**      **VKTW**      **TR**      **BA**      **DTA**      **COURSE CHANGE**      **DVEB**      **VEB\_OCS**      **RF CENTER FIX/DISTANCE**

**SEGMENT REMARKS:**



**AIRPORT** BELLINGHAM INTL      **AIRPORT ID** KBLI      **PROCEDURE NAME** RNAV (RNP) Z RWY 16      **AMDT NO.** 1      **CITY** BELLINGHAM      **STATE** WA      **AIRPORT ELEVATION** 170      **FACILITY** RNAV

**MISSED APPROACH** + -  
**FROM** 700 MSL      **TO** TECUV  
**RNP** 0.30-1.00      **DISTANCE**      **PAT**      **MAP**      **HAT**      **HMAS**  
**OBSTRUCTION** 13. TANK (53-000538)      **COORDINATES** 484825.00N/1223323.00W      **ELEV MSL** 294      **HORZ** 500      **VERT** 125      **AC** 5E      **ROC** ASC      **CGTA**      **ADJUSTMENTS** AC125      **MIN ALT**

**COMPUTATIONS**  
 Select from menu...      **ALT**      **KIAS**      **KTAS**      **HAA**      **VKTW**      **TR**      **BA**      **DTA**      **COURSE CHANGE**      **DVEB**      **VEB OCS**      **RF CENTER FIX/DISTANCE**

**SEGMENT REMARKS:**

**MISSED APPROACH** + -  
**FROM** DA      **TO** RWY16  
**RNP** 0.27-1.00      **DISTANCE**      **PAT**      **MAP**      **HAT**      **HMAS** 287  
**OBSTRUCTION**      **COORDINATES**      **ELEV MSL**      **HORZ**      **VERT**      **AC**      **ROC** ASC      **CGTA**      **ADJUSTMENTS**      **MIN ALT**

**COMPUTATIONS**  
 Select from menu...      **ALT**      **KIAS**      **KTAS**      **HAA**      **VKTW**      **TR**      **BA**      **DTA**      **COURSE CHANGE**      **DVEB**      **VEB OCS**      **RF CENTER FIX/DISTANCE**

**SEGMENT REMARKS:**

**MISSED APPROACH** + -  
**FROM** RWY16      **TO** 700 MSL  
**RNP** 0.27-1.00      **DISTANCE**      **PAT**      **MAP**      **HAT**      **HMAS**

**AIRPORT** BELLINGHAM INTL      **AIRPORT ID** KBLI      **PROCEDURE NAME** RNAV (RNP) Z RWY 16      **AMDT NO.** 1      **CITY** BELLINGHAM      **STATE** WA      **AIRPORT ELEVATION** 170      **FACILITY** RNAV

**OBSTRUCTION**      **COORDINATES**      **ELEV MSL**      **HORZ**      **VERT**      **AC**      **ROC**      **OCS**      **CG**      **CGTA**      **ADJUSTMENTS**      **MIN ALT**

**COMPUTATIONS**  
Select from menu...      **ALT**      **KIAS**      **KTAS**      **HAA**      **VKTW**      **TR**      **BA**      **DTA**      **COURSE CHANGE**      **DVEB**      **VEB\_OCS**      **RF CENTER FIX/DISTANCE**

**SEGMENT REMARKS:**

**MISSED APPROACH**      **TO**      **TECUV**      **HAT**      **HMAS**      **+**      **-**

**FROM** 700 MSL

**RNP** 0.27-1.00

**OBSTRUCTION**      **COORDINATES**      **ELEV MSL**      **HORZ**      **VERT**      **AC**      **ROC**      **OCS**      **CG**      **CGTA**      **ADJUSTMENTS**      **MIN ALT**

14. WINDMILL (53-020882)      484706.28N/1223131.99W      300      500      125      5E      ASC      ASC

**COMPUTATIONS**  
Select from menu...      **ALT**      **KIAS**      **KTAS**      **HAA**      **VKTW**      **TR**      **BA**      **DTA**      **COURSE CHANGE**      **DVEB**      **VEB\_OCS**      **RF CENTER FIX/DISTANCE**

**SEGMENT REMARKS:**

**MISSED APPROACH: LEVEL SURFACE**      **TO**      **TECUV**      **HAT**      **HMAS**      **+**      **-**

**FROM** DA

**RNP**      **DISTANCE**      **PAT**      **MAP**      **HAT**

**OBSTRUCTION**      **COORDINATES**      **ELEV MSL**      **HORZ**      **VERT**      **AC**      **ROC**      **OCS**      **CG**      **CGTA**      **ADJUSTMENTS**      **MIN ALT**

15. AAO      485031.32N/1224109.43W      499      50      125      2E      1000      ASC      AC125      1700      2000

16. TERRAIN      485031.32N/1224109.43W      299 (300)

**COMPUTATIONS**  
Select from menu...      **ALT**      **KIAS**      **KTAS**      **HAA**      **VKTW**      **TR**      **BA**      **DTA**      **COURSE CHANGE**      **DVEB**      **VEB\_OCS**      **RF CENTER FIX/DISTANCE**

**SEGMENT REMARKS:**

**AIRPORT:** BELLINGHAM INTL      **AIRPORT ID:** KBLI      **PROCEDURE NAME:** RNAV (RNP) Z RWY 16      **AMDT NO.:** 1      **CITY:** BELLINGHAM      **STATE:** WA      **AIRPORT ELEVATION:** 170      **FACILITY:** RNAV

**CIRCLING** (Select all that apply)     ALL CATS     CAT A     CAT B     CAT C     CAT D     CATE     NOT AUTHORIZED

**CIRCLING REMARKS:**  

**CENTER**        **RADIUS**  

SECTOR	OBSTRUCTION	COORDINATES	BEARING	DISTANCE	ELEV MSL	HORZ	VERT	AC	ROC	ADJUSTMENTS	MIN ALT

**MSA REMARKS:**    

**NOTES/EXPLANATIONS FROM PROCEDURE SEGMENTS:**

**PART B: SUPPLEMENTAL DATA**

**COMMUNICATIONS WITH ZSE ARTCC, BLI TOWER, VICTORIA APP CON**

WX SERVICE ASOS	LOCATION	HRS OPERATION	ALTIMETER SOURCE	DISTANCE	SERVICE-A	ADJUSTMENTS
	KBLI	24	KBLI	0	Y	0

BACK-UP WX SERVICE	LOCATION	HRS OPERATION	ALTIMETER SOURCE	DISTANCE	SERVICE-A	ADJUSTMENTS

**WX REMARKS:**  
KBLI ATIS ON SERVICE A

**PRIMARY NAVAID**      **MONITOR POINT**      **HRS OPERATION**      **CAT**

APPROACH AND RUNWAY LIGHTING SYSTEM		RUNWAY MARKINGS		RUNWAY VISUAL RANGE	
RW16 - MALSR (PCL), HIRL (PCL), PAPI-4L	TCH	PRI-G	APPROACH		
RW34 - HIRL (PCL), REIL (PCL), PAPI-4L	51.4	NPI-G			

GLIDESLOPE ANGLE	ELEV RWY THRESHOLD	TCH	ELEV GS ANTENNA	DISTANCE FROM RWY	VGSI ANGLE	TCH
3.00	162.5	51.4			3.00	50.0

**FINAL APPROACH COURSE AIMING**  
**RUNWAY THRESHOLD**       **FT FROM THRESHOLD**  
**ON CENTERLINE**       **FT FROM CENTERLINE**  
**DISPLACED THRESHOLD DISTANCE**

**CRITICAL TEMPERATURES**  
**CRITICAL LOW**      **CRITICAL HIGH**      **ACT**      **APT/ISA**  
 -10C      +54C      -10C      +14.66C

**AIRPORT:** BELLINGHAM INTL      **AIRPORT ID:** KBLI      **PROCEDURE NAME:** RNAV (RNP) Z RWY 16      **AMDT NO.:** 1      **CITY:** BELLINGHAM      **STATE:** WA      **AIRPORT ELEVATION:** 170      **FACILITY:** RNAV

**CRITICAL TEMPERATURE REMARKS:**  
 DESCENT RATE: STANDARD TEMP 956 HIGH TEMP 1116; AVERAGE COLD TEMPERATURE BASED ON A 5 YR HISTORY (2010-2014) ACT -10

**"VISUAL PORTION OF FINAL" PENETRATIONS**

FINAL TYPE       +       -  
 20:1  
 RUNWAY       +       -  
 34:1  
 RUNWAY       +       -

**PENETRATIONS REMARKS:**  
 VISUAL APPROACH SURFACES VERIFIED CLEAR

**HELICOPTER "VISUAL PORTION OF FINAL" PENETRATIONS**

and/or  
 5280-FT "PROCEED VFR" SEGMENT LEVEL SURFACE AREA PENETRATIONS

**PENETRATIONS REMARKS:**

**PART C: GENERAL REMARKS:**  
 MAXIMUM TREE HEIGHT 40 FT PER FPT; PRECIPITOUS TERRAIN EVALUATION COMPLETED

FACILITY  
RNAV

AIRPORT ELEVATION  
170

STATE  
WA

CITY  
BELLINGHAM

AMDT NO.  
1

PROCEDURE NAME  
RNAV (RNP) Z RWY 16

AIRPORT ID  
KBLI

AIRPORT  
BELLINGHAM INTL

PART D: AIRSPACE

DOCKET #

ALL DISTANCES TO 1/100NM; ELEVATION TO NEAREST 100 FEET; COORDINATES TO 1/100 SECOND; DEG TO 1/100 DEGREE

DISTANCE FROM	THLD		TO 1000FT POINT	2.94
WIDTH OF	FINAL		SEGMENT AT 1000FT POINT	1.20
TRUE COURSE OF	FINAL		SEGMENT CONTAINING 1000FT POINT	179.85
HIGH TERRAIN IN	FINAL		SEGMENT CONTAINING 1000FT POINT	200
DISTANCE FROM	THLD		TO 1500FT POINT	4.61
WIDTH OF	FINAL		SEGMENT AT 1500FT POINT	1.20
TRUE COURSE OF	FINAL		SEGMENT CONTAINING 1500FT POINT	179.85
HIGH TERRAIN IN	FINAL		SEGMENT CONTAINING 1500FT POINT	200

THRESHOLD  
COORDINATES  
(IF STR-IN)  
484806.75N/1233215.20W

ARP COORDINATES  
484733.70N/1233215.10W

RUNWAY APCH END  
AND DIST FURTHEST  
FROM MAP  
RW34/0.55

PFAF   
COORDINATES  
435343.01N/1233216.54W

FIX NAME  
COORDINATES

REMARKS  
NO ADDITIONAL AIRSPACE REQUIRED

PART E: PREPARED BY

NAME OFFICE DATE TITLE

THIS PAGE IS INTENTIONALLY LEFT BLANK

Figure 2.

**FEDERAL AVIATION ADMINISTRATION  
FLIGHT STANDARDS SERVICE  
STANDARD INSTRUMENT APPROACH PROCEDURE DATA RECORD**

**COPTER**  Reset Form

<b>AIRPORT</b> FORT MORGAN MUNI	<b>AIRPORT ID</b> KFMM	<b>PROCEDURE NAME</b> RNAV (GPS) RWY 14	<b>AMDT NO.</b> 1	<b>CITY</b> FORT MORGAN	<b>STATE</b> CO	<b>AIRPORT ELEVATION</b> 4595	<b>FACILITY</b> RNAV
------------------------------------	---------------------------	--	----------------------	----------------------------	--------------------	----------------------------------	-------------------------

**PART A: OBSTRUCTION DATA SEGMENTS**

**TAA - STRAIGHT-IN AREA**

**FROM**  
054/30 CW 234/30

<b>RNP</b>	<b>DISTANCE</b>	<b>PAT</b>	<b>MAP</b>	<b>HMAS</b>	<b>HAT</b>	<b>TO</b> 054/15 CW 234/15	
------------	-----------------	------------	------------	-------------	------------	-------------------------------	--

**OBSTRUCTION**

<b>COORDINATES</b>	<b>ELEV MSL</b>	<b>HORZ</b>	<b>VERT</b>	<b>AC</b>	<b>ROC</b>	<b>OCS</b>	<b>CG</b>	<b>CGTA</b>	<b>ADJUSTMENTS</b>	<b>MIN ALT</b>
1. WINDMILL (08-001268) 405456.41N/1040452.36W	5929	250	50	4D	2000				AS1500	8000
2. TERRAIN 405354.00N/1040615.00W	5558 (6600)									7100

**COMPUTATIONS**  
Select from menu...

<b>ALT</b>	<b>KIAS</b>	<b>KTAS</b>	<b>HAA</b>	<b>YKTW</b>	<b>TR</b>	<b>BA</b>	<b>DTA</b>	<b>COURSE CHANGE</b>	<b>DVEB</b>	<b>VEB OCS</b>	<b>RF CENTER FIX/DISTANCE</b>
------------	-------------	-------------	------------	-------------	-----------	-----------	------------	----------------------	-------------	----------------	-------------------------------

**SEGMENT REMARKS:**

---

**TAA - STRAIGHT-IN AREA STEPDOWN**

**FROM**  
054/15 CW 234/15

<b>RNP</b>	<b>DISTANCE</b>	<b>PAT</b>	<b>MAP</b>	<b>HMAS</b>	<b>HAT</b>	<b>TO</b> ECUDI	
------------	-----------------	------------	------------	-------------	------------	--------------------	--

**OBSTRUCTION**

<b>COORDINATES</b>	<b>ELEV MSL</b>	<b>HORZ</b>	<b>VERT</b>	<b>AC</b>	<b>ROC</b>	<b>OCS</b>	<b>CG</b>	<b>CGTA</b>	<b>ADJUSTMENTS</b>	<b>MIN ALT</b>
3. AAO 403445.00N/1035833.00W	5289	250	50	4D	2000					7400
4. TERRAIN 403445.00N/1035833.00W	5069 (5100)								AS1500	6600

**COMPUTATIONS**  
Select from menu...

<b>ALT</b>	<b>KIAS</b>	<b>KTAS</b>	<b>HAA</b>	<b>YKTW</b>	<b>TR</b>	<b>BA</b>	<b>DTA</b>	<b>COURSE CHANGE</b>	<b>DVEB</b>	<b>VEB OCS</b>	<b>RF CENTER FIX/DISTANCE</b>
------------	-------------	-------------	------------	-------------	-----------	-----------	------------	----------------------	-------------	----------------	-------------------------------

**SEGMENT REMARKS:**

---

**TAA - LEFT BASE AREA**

**FROM**  
234/30 CW 324/30

<b>RNP</b>	<b>DISTANCE</b>	<b>PAT</b>	<b>MAP</b>	<b>HMAS</b>	<b>HAT</b>	<b>TO</b> CAPVA	
------------	-----------------	------------	------------	-------------	------------	--------------------	--

AIRPORT FORT MORGAN MUNI AIRPORT ID KFMM AIRPORT NAME RNAV (GPS) RWY 14 AMDT NO. 1 CITY FORT MORGAN STATE CO AIRPORT ELEVATION 4595 FACILITY RNAV

OBSTRUCTION	COORDINATES	ELEV MSL	HORZ	VERT	AC	ROC	OCS	CG	CGTA	ADJUSTMENTS	MIN ALT
3. AAO	403445.00N/1035833.00W	5269	250	50	4D	2000				AT131	7400
4. TERRAIN	403445.00N/1035833.00W	5069 (5100)								AS1500	6600

COMPUTATIONS Select from menu... ALT KIAS KTAS HAA VKTW TR BA DTA COURSE CHANGE DVEB VEB\_OCS RF CENTER FIX/DISTANCE

SEGMENT REMARKS:

TAA - RIGHT BASE AREA	TO	HAT	HMAS
FROM 324/30 CW 050/30	324/15 CW 054/15		

OBSTRUCTION	COORDINATES	ELEV MSL	HORZ	VERT	AC	ROC	OCS	CG	CGTA	ADJUSTMENTS	MIN ALT
5. TOWER 08-020356)	4000201.21N/1035618.94W	6044	500	50	5D	2000					8100
6. TERRAIN	4000257.00N/1043303.00W	5161 (5200)								AS1500	6700

COMPUTATIONS Select from menu... ALT KIAS KTAS HAA VKTW TR BA DTA COURSE CHANGE DVEB VEB\_OCS RF CENTER FIX/DISTANCE

SEGMENT REMARKS:

TAA - RIGHT BASE AREA STEPDOWN	TO	HAT	HMAS
FROM 324/15 CW 054/15	DEKTE		

OBSTRUCTION	COORDINATES	ELEV MSL	HORZ	VERT	AC	ROC	OCS	CG	CGTA	ADJUSTMENTS	MIN ALT
3. AAO	403445.00N/1035833.00W	5269	250	50	4D	2000				AT131	7400
4. TERRAIN	403445.00N/1035833.00W	5069 (5100)								AS1500	6600

COMPUTATIONS Select from menu... ALT KIAS KTAS HAA VKTW TR BA DTA COURSE CHANGE DVEB VEB\_OCS RF CENTER FIX/DISTANCE

SEGMENT REMARKS:



AIRPORT FORT MORGAN MUNI AIRPORT ID KFMM PROCEDURE NAME RNAV (GPS) RWY 14 AMDT NO. 1 CITY FORT MORGAN STATE CO AIRPORT ELEVATION 4595 FACILITY RNAV

INITIAL														+ -
FROM DEKTE														
RNP	DISTANCE	PAT	MAP	HAT	HMAS									
	10.00					TO ECUDI								
OBSTRUCTION	COORDINATES	ELEV MSL	HORZ	VERT	AC	ROC	CG	CGTA	ADJUSTMENTS	MIN ALT				
7. AAO	403318.00N/1035724.00W	5230	250	50	4D	1000			AT1170	7400				
8. TERRAIN	403318.00N/1035724.00W	5030 (5000)												

COMPUTATIONS  
Select from menu... ALT KIAS KTAS HAA VKTW TR BA DTA COURSE CHANGE DVFB VEB OCS RF CENTER FIX/DISTANCE

SEGMENT REMARKS:

INITIAL														+ -
FROM CAPVA														
RNP	DISTANCE	PAT	MAP	HAT	HMAS									
	10.00					TO ECUDI								
OBSTRUCTION	COORDINATES	ELEV MSL	HORZ	VERT	AC	ROC	CG	CGTA	ADJUSTMENTS	MIN ALT				
7. AAO	403318.00N/1035724.00W	5230	250	50	4D	1000			AT1170	7400				
8. TERRAIN	403318.00N/1035724.00W	5030 (5000)												

COMPUTATIONS  
Select from menu... ALT KIAS KTAS HAA VKTW TR BA DTA COURSE CHANGE DVFB VEB OCS RF CENTER FIX/DISTANCE

SEGMENT REMARKS:

INTERMEDIATE: (IF/IAF)														+ -
FROM ECUDI														
RNP	DISTANCE	PAT	MAP	HAT	HMAS									
	7.40					TO FEPAS								

**AIRPORT** FORT MORGAN MUNI      **AIRPORT ID** KFMM      **PROCEDURE NAME** RNAV(GPS) RWY 14      **AMDT NO.** 1      **CITY** FORT MORGAN      **STATE** CO      **AIRPORT ELEVATION** 4595      **FACILITY** RNAV

**OBSTRUCTION**

9. AAO	COORDINATES	ELEV MSL	HORZ	VERT	AC	ROC	CGTA	ADJUSTMENTS	MIN ALT
	403309.00N/1035706.00W	5204	50	20	2C	500		AT496	6200
10. TERRAIN	403309.00N/1035706.00W	5004 (5000)						AS1000	6000

**COMPUTATIONS**  
Select from menu...

**ALT**      **KIAS**      **KTAS**      **HAA**      **VKTW**      **IR**      **BA**      **DTA**      **COURSE CHANGE**      **DVEB**      **VEB OCS**      **RF CENTER FIX/DISTANCE**

**SEGMENT REMARKS:**

**FINAL:** LPV      **TO** RWY14      **FROM** FEPAS      **PAT**      **HAT** 250      **RNP**      **DISTANCE** 4.94      **MAP** DA      **HMAS**      **OBSTRUCTION**      **COORDINATES**      **ELEV MSL**      **HORZ**      **VERT**      **AC**      **ROC** 34:1      **CGTA**      **ADJUSTMENTS**      **MIN ALT** 4845

**COMPUTATIONS**  
Select from menu...

**ALT**      **KIAS**      **KTAS**      **HAA**      **VKTW**      **IR**      **BA**      **DTA**      **COURSE CHANGE**      **DVEB**      **VEB OCS**      **RF CENTER FIX/DISTANCE**

**SEGMENT REMARKS:**

**FINAL:** LNAV/VNAV      **TO** RWY14      **FROM** FEPAS      **PAT**      **HAT** 250      **RNP**      **DISTANCE** 4.94      **MAP** DA      **HMAS**      **OBSTRUCTION**      **COORDINATES**      **ELEV MSL**      **HORZ**      **VERT**      **AC**      **ROC** 23.81:1      **CGTA**      **ADJUSTMENTS**      **MIN ALT** 4845

**COMPUTATIONS**  
Select from menu...

**ALT**      **KIAS**      **KTAS**      **HAA**      **VKTW**      **IR**      **BA**      **DTA**      **COURSE CHANGE**      **DVEB**      **VEB OCS**      **RF CENTER FIX/DISTANCE**

**SEGMENT REMARKS:**

**AIRPORT** FORT MORGAN MUNI      **AIRPORT ID** KFMM      **PROCEDURE NAME** RNAV(GPS) RWY 14      **AMDT NO.** 1      **CITY** FORT MORGAN      **STATE** CO      **AIRPORT ELEVATION** 4595      **FACILITY** RNAV

**FINAL: LNAV**            **TO** GISEY/2.30 NM TO RW14     

**FROM** FEPAS      **DISTANCE** 2.64      **PAT**      **HAT**      **HMAS**

**RNP**      **MAP**      **OBSTRUCTION** 11. AAC      **ELEV MSL** 4910      **HORIZ** 50      **VERT** 20      **AC** 2C      **ROC** 250      **OCS**      **CG**      **CGTA**      **ADJUSTMENTS** DG180      **MIN ALT** 5340

**COMPUTATIONS**

Select from menu...

**ALT**      **KIAS**      **KTAS**      **HAA**      **VKTW**      **TR**      **BA**      **DTA**      **COURSE CHANGE**      **DVEB**      **VEB OCS**      **RF CENTER FIX/DISTANCE**

**SEGMENT REMARKS:**

**FINAL: LNAV STEPDOWN**     

**FROM** GISEY/2.30 NM TO RW14      **TO** RW14     

**RNP**      **DISTANCE** 2.30      **PAT**      **HAT** 405      **HMAS**

**OBSTRUCTION** 12. RD (N) (KFMMT000323)      **ELEV MSL** 4745      **HORIZ** 20      **VERT** 3      **AC** 1A      **ROC** 250      **OCS**      **CG**      **CGTA**      **ADJUSTMENTS**      **MIN ALT** 5000

**COMPUTATIONS**

Select from menu...

**ALT**      **KIAS**      **KTAS**      **HAA**      **VKTW**      **TR**      **BA**      **DTA**      **COURSE CHANGE**      **DVEB**      **VEB OCS**      **RF CENTER FIX/DISTANCE**

**SEGMENT REMARKS:**

**HOLD-IN-LIEU-OF-PT**     

**FROM** ECUDI      **TO**     

**RNP**      **DISTANCE**      **PAT** 9      **HAT**      **HMAS**

AIRPORT FORT MORGAN MUNI AIRPORT ID KFMM AIRPORT NAME RNAV (GPS) RWY 14 AMDT NO. 1 CITY FORT MORGAN STATE CO AIRPORT ELEVATION 4595 FACILITY RNAV

OBSTRUCTION	COORDINATES	ELEV MSL	HORZ	VERT	AC	ROC	OCS	CG	CGTA	ADJUSTMENTS	MIN ALT
13. AAO	404512.00N/1040457.00W	5305	250	20	4D	1000				AT1095	7400
14. TERRAIN	404512.00N/1040457.00W	5105 (5100)								AS1500	6600

COMPUTATIONS Select from menu... ALT KIAS KTAS HAA VKTW TR BA DTA COURSE CHANGE DVEB VEB\_OCS RF CENTER FIX/DISTANCE

SEGMENT REMARKS:

MISSED APPROACH FROM DA TO HARPU

RNP	DISTANCE	PAT	MAP	HAT	HIMAS						
			DA		4659						
OBSTRUCTION	COORDINATES	ELEV MSL	HORZ	VERT	AC	ROC	OCS	CG	CGTA	ADJUSTMENTS	MIN ALT
15. STACK (08-000280)	401313.00N/1034047.00W	4862	500	50	5D	1000				AC50	6000
16. TERRAIN	400921.00N/1034251.00W	4528 (4500)								AS1500	6000

COMPUTATIONS Select from menu... ALT KIAS KTAS HAA VKTW TR BA DTA COURSE CHANGE DVEB VEB\_OCS RF CENTER FIX/DISTANCE

SEGMENT REMARKS: HOLDING OBSTACLE: 4941 AAO 400245.00N/10324.33W

MISSED APPROACH FROM DA TO HARPU

RNP	DISTANCE	PAT	MAP	HAT	HIMAS						
			DA		4685						
OBSTRUCTION	COORDINATES	ELEV MSL	HORZ	VERT	AC	ROC	OCS	CG	CGTA	ADJUSTMENTS	MIN ALT
15. STACK (08-000280)	401313.00N/1034047.00W	4862	500	50	5D	1000				AC50	6000
16. TERRAIN	400921.00N/1034251.00W	4528 (4500)								AS1500	6000

COMPUTATIONS Select from menu... ALT KIAS KTAS HAA VKTW TR BA DTA COURSE CHANGE DVEB VEB\_OCS RF CENTER FIX/DISTANCE

SEGMENT REMARKS: HOLDING OBSTACLE: 4941 AAO 400245.00N/10324.33W

AIRPORT FORT MORGAN MUNI AIRPORT ID KFMM PROCEDURE NAME RNAV (GPS) RWY 14 AIRMT NO. 1 CITY FORT MORGAN STATE CO AIRPORT ELEVATION 4595 FACILITY RNAV

+ -

MISSED APPROACH FROM RW14 TO HARPU

RNP	DISTANCE	PAT	MAP RW14	HAT	HMAS	CG	CGTA	ADJUSTMENTS	MIN ALT
15. STACK (08-000280)	401313.00N/1034047.00W		4862	50	5D	1000	ASC	AC50	6000
16. TERRAIN COMPUTATIONS	401313.00N/1034047.00W		4528 (4500)					AS1500	6000

Select from menu... ALT KIAS KTAS HAA VKTW TR BA DTA COURSE CHANGE DVFB VEB OCS RF CENTER FIX/DISTANCE

SEGMENT REMARKS: HOLDING OBSTACLE: 4941 AAO 400245.00N/10324.33W

(Select all that apply)  ALL CATS  CATA  CATB  CATC  CATD  CATE  NOT AUTHORIZED

CIRCLING OBSTRUCTION	COORDINATES	RADIUS	HAA	ELEVMSL	HORZ	VERT	AC	ROC	OCS	ADJUSTMENTS	MIN ALT
17. TREE	402124.00N/1035015.00W	1.38	445	4707	50	20	2C	300			5040
18. TREE	402145.00N/1035051.00N	1.98	485	4756	50	20	2C	300			5080
19. TREE	402212.00N/1035127.00W	3.13	525	4789	50	20	2C	300			5120
20. AAC	402330.00N/1035233.00W	4.10	745	4985	250	20	4D	300	AC50		5340

CIRCLING REMARKS:

+ -

CENTER RADIUS

SECTOR	OBSTRUCTION	COORDINATES	BEARING	DISTANCE	ELEVMSL	HORZ	VERT	AC	ROC	ADJUSTMENTS	MIN ALT

+ -

MSA REMARKS:

NOTES/EXPLANATIONS FROM PROCEDURE SEGMENTS:

**AIRPORT** FORT MORGAN MUNI      **AIRPORT ID** KFMM      **PROCEDURE NAME** RNAV(GPS) RWY 14      **AMDT NO.** 1      **CITY** FORT MORGAN      **STATE** CO      **AIRPORT ELEVATION** 4595      **FACILITY** RNAV

**PART B: SUPPLEMENTAL DATA**

**COMMUNICATIONS WITH**  
ZDV ARTCC, DEN FSS

**WX SERVICE** AWOS-3      **LOCATION** KFMM      **HRS OPERATION** 24      **ALTIMETER SOURCE** KFMM      **DISTANCE** 0      **SERVICE-A** Y      **ADJUSTMENTS** 0  
**BACK-UP WX SERVICE** ASOS      **LOCATION** KAKO      **HRS OPERATION** 24      **ALTIMETER SOURCE** KAKO      **DISTANCE** 28.3      **SERVICE-A** Y      **ADJUSTMENTS** 85.5

**WX REMARKS:**  
RASS PRESSURE PATTERNS THE SAME KFMM 4568.7, KAKO 4715.8 RA = 85.85 FT

**PRIMARY NAVAID**      **MONITOR POINT**      **HRS OPERATION**      **CAT**

APPROACH AND RUNWAY LIGHTING SYSTEM		RUNWAY MARKINGS		RUNWAY VISUAL RANGE	
RW08	BSC-F	BSC-F			-
RW26	BSC-F	BSC-F			+
RW14 - MIRL (PCL), PAPI-2L (PCL)		NPI-G			-
RW32 - MIRL (PCL), PAPI-2L (PCL)		NPI-G			+

**GLIDESLOPE ANGLE** 3.00      **ELEV RWY THRESHOLD** 4595.3      **TCH** 30.0      **ELEV GS ANTENNA**      **DISTANCE FROM RWY**      **VGSI ANGLE** 3.00      **TCH** 27.9

**FINAL APPROACH COURSE AIMING**

**RUNWAY THRESHOLD**       **FT FROM THRESHOLD**      **DISPLACED THRESHOLD DISTANCE**  
**ON CENTERLINE**       **FT FROM CENTERLINE**

**CRITICAL TEMPERATURES**

**CRITICAL LOW** -27C      **CRITICAL HIGH** +54C      **ACT** -27.44      **APT ISA** +5.90

**CRITICAL TEMPERATURE REMARKS:**  
AVERAGE COLD TEMPERATURE BASED ON 5-YR HISTORY; CRITICAL LOW TEMP BASED ON EFFECTIVE GPA DESCENT RATE; STANDARD TEMP 1018, HIGH TEMP 1189 TEMPARTURE LIMITS;  
DESCENT VALUES DERIVED FROM AFS-400 CALCULATIONS

**"VISUAL PORTION OF FINAL" PENETRATIONS**

**FINAL TYPE**  -

20:1  -

**RUNWAY**  -

<b>AIRPORT</b> FORT MORGAN MUNI	<b>AIRPORT ID</b> KFMM	<b>PROCEDURE NAME</b> RNAV (GPS) RWY 14	<b>AMDT. NO.</b> 1	<b>CITY</b> FORT MORGAN	<b>STATE</b> CO	<b>AIRPORT ELEVATION</b> 4595	<b>FACILITY</b> RNAV
------------------------------------	---------------------------	--	-----------------------	----------------------------	--------------------	----------------------------------	-------------------------

34:1

RUNWAY

+ -

**PENETRATIONS REMARKS:**

**HELICOPTER VISUAL PORTION OF FINAL PENETRATIONS**

and/or

5280-FT "PROCEED VFR" SEGMENT LEVEL SURFACE AREA PENETRATIONS

**PENETRATIONS REMARKS:**

**PART C: GENERAL REMARKS:**

TAA DEVELOPED PER ATC REQUEST; 15 FT VEGETATION WITHIN 20,000 FT AND 200 FT AAC USED IN PROCEDURE; VEGETATION HEIGHT FER FPT

AIRPORT: FORT MORGAN MUNI      AIRPORT ID: KFWM      PROCEDURE NAME: RNAV (GPS) RWY 14      AMDT. NO.: 1      CITY: FORT MORGAN      STATE: CO      AIRPORT ELEVATION: 4595      FACILITY: RNAV

PART D: AIRSPACE

DOCKET #

ALL DISTANCES TO 1/100 NM; ELEVATION TO NEAREST 100 FEET; COORDINATES TO 1/100 SECOND; DEG TO 1/100 DEGREE

DISTANCE FROM	THLD		TO 1000FT POINT	3.37
WIDTH OF	FINAL		SEGMENT AT 1000FT POINT	1.74
TRUE COURSE OF	FINAL		SEGMENT CONTAINING 1000FT POINT	151.58
HIGH TERRAIN IN	FINAL		SEGMENT CONTAINING 1000FT POINT	4700
DISTANCE FROM	THLD		TO 1500FT POINT	4.94
WIDTH OF	FINAL		SEGMENT AT 1500FT POINT	2.00
TRUE COURSE OF	FINAL		SEGMENT CONTAINING 1500FT POINT	151.58
HIGH TERRAIN IN	FINAL		SEGMENT CONTAINING 1500FT POINT	4700

THRESHOLD COORDINATES (IF STR-IN) 402041.49N/1034842.00W

ARP COORDINATES 402007.65N/1034815.01W

RUNWAY APCH END AND DIST FURTHEST FROM MAP RW 14/0.58

FAF COORDINATES 402502.52N/1035146.61W

FIX NAME COORDINATES IAF: ECUDI 403133.08N/1035623.81W; IAF: DEKTE 402646.25N/1040754.65W; IAF: CAPVA 403618.75N/1034451.36W

REMARKS NO ADDITIONAL AIRSPACE REQUIRED

PART E: PREPARED BY

NAME OFFICE DATE TITLE



Figure 3.

**FEDERAL AVIATION ADMINISTRATION  
FLIGHT STANDARDS SERVICE  
STANDARD INSTRUMENT APPROACH PROCEDURE DATA RECORD**

<b>AIRPORT</b>	DANE COUNTY RGNL-TRUAX FIELD	<b>AIRPORT ID</b>	KMSN	<b>PROCEDURE NAME</b>	ILS OR LOC/DME RWY 18	<b>STATE</b>	WI	<b>AIRPORT ELEVATION</b>	887	<b>FACILITY</b>	I-DSZ
<b>AMDT NO.</b>	2	<b>CITY</b>	MADISON	<b>ILS RWY 18 (SA CAT I)</b>		<b>VEB OCS</b>		<b>RF CENTER FIX/DISTANCE</b>			
<b>ILS RWY 18 (SA CAT II)</b>		<b>MAP</b>		<b>HAT</b>		<b>DVEB</b>		<b>CGTA</b>		<b>ADJUSTMENTS</b>	
										AT657	3000
										AS1000	2100

**PART A: OBSTRUCTION DATA SEGMENTS**

<b>FEEDER</b>		<b>TO</b>	RUKYI INT/I-DSZ 6.56 DME/RADAR								
<b>FROM</b>	MSN VORTAC	<b>HAT</b>		<b>HMAS</b>		<b>CGTA</b>		<b>ADJUSTMENTS</b>		<b>MIN ALT</b>	
<b>RNP</b>		<b>MAP</b>									
<b>DISTANCE</b>	5.16										
<b>COORDINATES</b>		<b>AC</b>	5D	<b>OC</b>	1000	<b>CGTA</b>		<b>ADJUSTMENTS</b>		<b>MIN ALT</b>	3000
1. TWR (55-000509)	431027.00N/0891520.00W	<b>VERT</b>	50	<b>OC</b>	1000	<b>CGTA</b>		<b>ADJUSTMENTS</b>		<b>MIN ALT</b>	3000
2. TERRAIN	431348.00N/0892543.00W	<b>HORZ</b>	500	<b>OC</b>	1000	<b>CGTA</b>		<b>ADJUSTMENTS</b>		<b>MIN ALT</b>	3000
		<b>ELEV MSL</b>	1343	<b>OC</b>	1000	<b>CGTA</b>		<b>ADJUSTMENTS</b>		<b>MIN ALT</b>	3000
		<b>1068 (1100)</b>		<b>OC</b>	1000	<b>CGTA</b>		<b>ADJUSTMENTS</b>		<b>MIN ALT</b>	3000

**COMPUTATIONS**

Select from menu...

<b>ALT</b>		<b>DTA</b>		<b>COURSE CHANGE</b>		<b>DVEB</b>		<b>VEB OCS</b>		<b>RF CENTER FIX/DISTANCE</b>	
------------	--	------------	--	----------------------	--	-------------	--	----------------	--	-------------------------------	--

**SEGMENT REMARKS:**

<b>INITIAL</b>		<b>TO</b>	DECAL INT/15.65 DME								
<b>FROM</b>	DLL VORTAC	<b>HAT</b>		<b>HMAS</b>		<b>CGTA</b>		<b>ADJUSTMENTS</b>		<b>MIN ALT</b>	
<b>RNP</b>		<b>MAP</b>									
<b>DISTANCE</b>	21.46										
<b>COORDINATES</b>		<b>AC</b>	4D	<b>OC</b>	1000	<b>CGTA</b>		<b>ADJUSTMENTS</b>		<b>MIN ALT</b>	3000
3. TWR (55-000819)	432602.00N/0893712.00W	<b>VERT</b>	50	<b>OC</b>	1000	<b>CGTA</b>		<b>ADJUSTMENTS</b>		<b>MIN ALT</b>	3000
4. TERRAIN	432554.00N/0893854.00W	<b>HORZ</b>	250	<b>OC</b>	1000	<b>CGTA</b>		<b>ADJUSTMENTS</b>		<b>MIN ALT</b>	3000
		<b>ELEV MSL</b>	1920	<b>OC</b>	1000	<b>CGTA</b>		<b>ADJUSTMENTS</b>		<b>MIN ALT</b>	3000
		<b>1549 (1500)</b>		<b>OC</b>	1000	<b>CGTA</b>		<b>ADJUSTMENTS</b>		<b>MIN ALT</b>	3000

**COMPUTATIONS**

Select from menu...

<b>ALT</b>		<b>DTA</b>		<b>COURSE CHANGE</b>		<b>DVEB</b>		<b>VEB OCS</b>		<b>RF CENTER FIX/DISTANCE</b>	
------------	--	------------	--	----------------------	--	-------------	--	----------------	--	-------------------------------	--

**SEGMENT REMARKS:**

<b>PROCEDURE TURN</b>		<b>TO</b>	10 NM								
<b>FROM</b>	RUKYI INT/I-DSZ 6.56 DME/RADAR	<b>HAT</b>		<b>HMAS</b>		<b>CGTA</b>		<b>ADJUSTMENTS</b>		<b>MIN ALT</b>	
<b>RNP</b>		<b>MAP</b>									
<b>DISTANCE</b>											

**AIRPORT** DANE COUNTY RGNL-TRUAX FIELD      **AIRPORT ID** KMSN      **PROCEDURE NAME** ILS OR LOC/DME RWY 18  
**AIRPORT ELEVATION** 887      **STATE** WI      **CITY** MADISON      **FACILITY** I-DSZ  
**AMDT NO.** 2      **MIN ALT** 2800

OBSTRUCTION	COORDINATES	ELEV MSL	HORZ	VERT	AC	ROC	OCS	CG	CGTA	ADJUSTMENTS	MIN ALT
5. AAO	432851.78N/0893107.67W	1540	50	20	2C	1000					2800
6. TERRAIN	432851.78N/0893107.67W	1340 (1300)								AS1500	2800

**COMPUTATIONS**

Select from menu...

ALT      KIAS      KTAS      HAA      VKTW      TR      BA      DTA      COURSE CHANGE      DVEB      VEB\_OCS      RF\_CENTER FIX/DISTANCE

**SEGMENT REMARKS:**

INTERMEDIATE: PT

FROM 10 NMI



TO GATNE INT/9.79 DME



RNP

DISTANCE

PAT

MAP

HAT

HMAS

OBSTRUCTION

7. TWR (55-000080)

432140.00N/0892412.00W

ELEV MSL 1535

CG

MIN ALT 2700

8. TERRAIN

431938.27N/0891821.60W

ELEV MSL 1129 (1100)

CG

MIN ALT 2800

**COMPUTATIONS**

Select from menu...

ALT      KIAS      KTAS      HAA      VKTW      TR      BA      DTA      COURSE CHANGE      DVEB      VEB\_OCS      RF\_CENTER FIX/DISTANCE

**SEGMENT REMARKS:**

INTERMEDIATE: PT STEPDOWN

FROM GATNE INT/9.79 DME



TO RUKIY INT/I-DSZ 6.56 DME/RADAR



RNP

DISTANCE

PAT

MAP

HAT

HMAS

OBSTRUCTION

9. AAO

431653.23N/0891741.32W

ELEV MSL 1250

CG

MIN ALT 2500

10. TERRAIN

431653.23N/0891741.32W

ELEV MSL 1039 (1000)

CG

MIN ALT 2000

**COMPUTATIONS**

Select from menu...

ALT      KIAS      KTAS      HAA      VKTW      TR      BA      DTA      COURSE CHANGE      DVEB      VEB\_OCS      RF\_CENTER FIX/DISTANCE

**SEGMENT REMARKS:**

**AIRPORT** DANE COUNTY RGNL-TRUAX FIELD      **AIRPORT ID** KMSN      **PROCEDURE NAME** ILS OR LOC/DME RWY 18  
**AIRPORT ELEVATION** 887      **STATE** WI      **CITY** MADISON      **FACILITY** I-DSZ  
**AMDT NO.** 2      **TO** GATNE INT/9.79 DME

INTERMEDIATE      [v]      [ + ]      [ - ]

**FROM** DECAL INT/15.65 DME      **HAT** 500      **CGTA** AT665      **MIN ALT** 2700  
**RNP**      **DISTANCE** 5.87      **MAP**      **HMAS**

**OBSTRUCTION**      **COORDINATES**      **ELEV MSL**      **HORZ**      **VERT**      **AC**      **ROC**      **OCS**      **CG**      **ADJUSTMENTS**      **MIN ALT**  
 7. TWR (55-000080)      432140.00N/0892412.00W      1535      20      50      1D      500                     AT665      2700  
 8. TERRAIN      431938.27N/0891821.60W      1129 (1100)                                              AS1500      2600

**COMPUTATIONS**      **ALT**      **KIAS**      **KTAS**      **HAA**      **VKTW**      **TR**      **BA**      **DTA**      **COURSE CHANGE**      **DVEB**      **VEB OCS**      **RF CENTER FIX/DISTANCE**  
 Select from menu...

SEGMENT REMARKS:

INTERMEDIATE: STEPDOWN      [v]      [ + ]      [ - ]

**FROM** GATNE INT/9.79 DME      **HAT** 500      **CGTA** AT750      **MIN ALT** 2500  
**RNP**      **DISTANCE** 3.23      **MAP**      **HMAS**

**OBSTRUCTION**      **COORDINATES**      **ELEV MSL**      **HORZ**      **VERT**      **AC**      **ROC**      **OCS**      **CG**      **ADJUSTMENTS**      **MIN ALT**  
 9. AAO      431653.23N/0891741.32W      1250      50      20      2C      500                     AT750      2500  
 10. TERRAIN      431653.23N/0891741.32W      1039 (1000)                                              AS1000      2000

**COMPUTATIONS**      **ALT**      **KIAS**      **KTAS**      **HAA**      **VKTW**      **TR**      **BA**      **DTA**      **COURSE CHANGE**      **DVEB**      **VEB OCS**      **RF CENTER FIX/DISTANCE**  
 Select from menu...

SEGMENT REMARKS:

FINAL: ILS      [v]      [ + ]      [ - ]

**FROM** RUKIY INT/I-DSZ 6.56 DME/RADAR      **HAT** 200      **CGTA**      **MIN ALT** 2500  
**RNP**      **DISTANCE**      **MAP**      **HMAS**

**AIRPORT** DANE COUNTY RGNL-TRUAX FIELD      **AIRPORT ID** KMSN      **PROCEDURE NAME** ILS OR LOC/DME RWY 18  
 ILS RWY 18 (SA CAT I)  
 ILS RWY 18 (SA CAT II)      **AMDT NO.** 2      **CITY** MADISON      **STATE** WI      **AIRPORT ELEVATION** 887      **FACILITY** I-DSZ  
**OBSTRUCTION**      **COORDINATES**      **ELEV MSL**      **HORIZ**      **VERT**      **AC**      **ROC**      **ASC**      **CGTA**      **ADJUSTMENTS**      **MIN ALT**  
 1064

**COMPUTATIONS**  
 Select from menu...      **ALT**      **KIAS**      **KTAS**      **HAA**      **VKTW**      **TR**      **BA**      **DTA**      **COURSE CHANGE**      **DVEB**      **VEB OCS**      **RF CENTER FIX/DISTANCE**

**SEGMENT REMARKS:**

**FINAL: LOC**         
**FROM** RUKIY INT/I-DSZ 6.56 DME/RADAR      **TO** JOGRI/I-DSZ 3.19 DME  
**RNP**      **DISTANCE** 3.37      **PAT**      **MAP**      **HAT**      **HMAS**  
**OBSTRUCTION**      **COORDINATES**      **ELEV MSL**      **HORIZ**      **VERT**      **AC**      **ROC**      **OCS**      **CG**      **CGTA**      **ADJUSTMENTS**      **MIN ALT**  
 11. AAC      431229.00N/0891938.00W      1170      50      20      2C      250

**COMPUTATIONS**  
 Select from menu...      **ALT**      **KIAS**      **KTAS**      **HAA**      **VKTW**      **TR**      **BA**      **DTA**      **COURSE CHANGE**      **DVEB**      **VEB OCS**      **RF CENTER FIX/DISTANCE**

**SEGMENT REMARKS:**

**FINAL: LOC STEPDOWN**         
**FROM** JOGRI/I-DSZ 3.19 DME      **TO** I-DSZ 1.59 DME  
**RNP**      **DISTANCE** 1.6      **PAT**      **MAP**      **HAT**      **HMAS**  
**OBSTRUCTION**      **COORDINATES**      **ELEV MSL**      **HORIZ**      **VERT**      **AC**      **ROC**      **OCS**      **CG**      **CGTA**      **ADJUSTMENTS**      **MIN ALT**  
 12. TREE (KMSNT1097)      431057.71N/0892006.44W      979      50      20      2C      250

**COMPUTATIONS**  
 Select from menu...      **ALT**      **KIAS**      **KTAS**      **HAA**      **VKTW**      **TR**      **BA**      **DTA**      **COURSE CHANGE**      **DVEB**      **VEB OCS**      **RF CENTER FIX/DISTANCE**

**SEGMENT REMARKS:**

**AIRPORT** DANE COUNTY RGNL-TRUAX FIELD      **AIRPORT ID** KMSN      **PROCEDURE NAME** ILS OR LOC/DME RWY 18  
 ILS RWY 18 (SA CAT I)  
 ILS RWY 18 (SA CAT II)      **AMDT NO.** 2      **CITY** MADISON      **STATE** WI      **AIRPORT ELEVATION** 887      **FACILITY** I-DSZ

**FINAL: ILS SA CAT I**            **TO** RWY16     

**FROM** RUKIY INT/A-DSZ 6.56 DME/RADAR      **RNP**      **DISTANCE**      **PAT**      **MAP** DA      **HAT** 150      **HMAS**      **OBSTRUCTION**      **COORDINATES**      **ELEV MSL**      **HORIZ**      **VERT**      **AC**      **ROC** ASC      **OCS**      **CG**      **CGTA**      **ADJUSTMENTS**      **MIN ALT** 1014

**COMPUTATIONS**      **ALT**      **KIAS**      **KTAS**      **HAA**      **VKTW**      **TR**      **BA**      **DTA**      **COURSE CHANGE**      **DVEB**      **VEB OCS**      **RF CENTER FIX/DISTANCE**

**SEGMENT REMARKS:**

**FINAL: ILS SA CAT II**            **TO** RWY16     

**FROM** RUKIY INT/A-DSZ 6.56 DME/RADAR      **RNP**      **DISTANCE**      **PAT**      **MAP** DA      **HAT** 100      **HMAS**      **OBSTRUCTION**      **COORDINATES**      **ELEV MSL**      **HORIZ**      **VERT**      **AC**      **ROC** ASC      **OCS**      **CG**      **CGTA**      **ADJUSTMENTS**      **MIN ALT** 964

**COMPUTATIONS**      **ALT**      **KIAS**      **KTAS**      **HAA**      **VKTW**      **TR**      **BA**      **DTA**      **COURSE CHANGE**      **DVEB**      **VEB OCS**      **RF CENTER FIX/DISTANCE**

**SEGMENT REMARKS:**

**MISSSED APPROACH: ILS**            **TO** MONAH INT/MSN VORTAC 4.93     

**FROM** DA      **RNP**      **DISTANCE**      **PAT**      **MAP**      **HAT**      **HMAS** 890

**AIRPORT** DANE COUNTY RGNL-TRUAX FIELD      **AIRPORT ID** KMSN      **PROCEDURE NAME** ILS OR LOC/DME RWY 18  
 ILS RWY 18 (SA CAT I)  
 ILS RWY 18 (SA CAT II)

**AMDT NO.** 2      **CITY** MADISON      **STATE** WI      **AIRPORT ELEVATION** 887      **FACILITY** I-DSZ

OBSTRUCTION	COORDINATES	ELEV MSL	HORZ	VERT	AC	ROC	OCS	CG	CGTA	ADJUSTMENTS	MIN ALT	
13. AAO	430354.00N/0891821.00W	1140	50	20	2C	1000					2700	
14. TERRAIN	430354.00N/0891821.00W	940 (900)								AS1500	2200	
<b>COMPUTATIONS</b>												
Select from menu...	<b>ALT</b>	<b>KIAS</b>	<b>KTAS</b>	<b>HAA</b>	<b>VKTW</b>	<b>TR</b>	<b>BA</b>	<b>DTA</b>	<b>COURSE CHANGE</b>	<b>DVEB</b>	<b>VEB OCS</b>	<b>RF CENTER FIX/DISTANCE</b>

**SEGMENT REMARKS:**

MISSED APPROACH: LOC

**FROM** I-DSZ 1.59 DME

**RNP** **DISTANCE**

**PAT**

**MAP**

**TO** MONAH INT/MSN VORTAC 4.93

**HAT**

**HMAS** 990

**OBSTRUCTION**

13. AAO 430354.00N/0891821.00W

14. TERRAIN 430354.00N/0891821.00W

**COMPUTATIONS**

Select from menu...

**ALT**

**KIAS**

**KTAS**

**HAA**

**VKTW**

**TR**

**BA**

**DTA**

**COURSE CHANGE**

**DVEB**

**VEB OCS**

**RF CENTER FIX/DISTANCE**

+ -

MISSED APPROACH: SA CAT I

**FROM** DA

**RNP** **DISTANCE**

**PAT**

**MAP**

**TO** MONAH INT/MSN VORTAC 4.93

**HAT**

**HMAS**

**OBSTRUCTION**

13. AAO 430354.00N/0891821.00W

14. TERRAIN 430354.00N/0891821.00W

**COMPUTATIONS**

Select from menu...

**ALT**

**KIAS**

**KTAS**

**HAA**

**VKTW**

**TR**

**BA**

**DTA**

**COURSE CHANGE**

**DVEB**

**VEB OCS**

**RF CENTER FIX/DISTANCE**

+ -

**AIRPORT** DANE COUNTY RGNL-TRUAX FIELD      **AIRPORT ID** KMSN      **PROCEDURE NAME** ILS OR LOC/DME RWY 18  
**AIRPORT ELEVATION** 887      **STATE** WI      **CITY** MADISON      **FACILITY** I-DSZ  
**AMDT NO.** 2      **TO** MONAH INT/MSN VORTAC 4.93

FROM	DA	RNP	DISTANCE	PAT	MAP	HAT	HMAS	ELEV MSL	HORZ	VERT	AC	ROC	OCS	CG	CGTA	ADJUSTMENTS	MIN ALT
13.	AAO		430354.00N/0891821.00W														
14.	TERRAIN		430354.00N/0891821.00W					940 (900)								AS1500	

**COMPUTATIONS** Select from menu...      **ALT**      **KIAS**      **KTAS**      **HAA**      **VKTW**      **TR**      **BA**      **DTA**      **COURSE CHANGE**      **DVEB**      **VEB OCS**      **RF CENTER FIX/DISTANCE**

**SEGMENT REMARKS:**

FROM	DA	RNP	DISTANCE	PAT	MAP	HAT	HMAS	ELEV MSL	HORZ	VERT	AC	ROC	OCS	CG	CGTA	ADJUSTMENTS	MIN ALT
15.	TOWER (55-000891)		430332.14N/0890345.30W					1405	100	20	3C	1000					3500
16.	TERRAIN		430733.00N/0891527.00W					1060 (1100)								AS1500	2500

**COMPUTATIONS** Select from menu...      **ALT**      **KIAS**      **KTAS**      **HAA**      **VKTW**      **TR**      **BA**      **DTA**      **COURSE CHANGE**      **DVEB**      **VEB OCS**      **RF CENTER FIX/DISTANCE**

**SEGMENT REMARKS:**

FROM	DA	RNP	DISTANCE	PAT	MAP	HAT	HMAS	ELEV MSL	HORZ	VERT	AC	ROC	OCS	CG	CGTA	ADJUSTMENTS	MIN ALT
17.	TOWER (55-000891)		430332.14N/0890345.30W					1405	100	20	3C	1000					3500
18.	TERRAIN		430733.00N/0891527.00W					1060 (1100)								AS1500	2500

**COMPUTATIONS** Select from menu...      **ALT**      **KIAS**      **KTAS**      **HAA**      **VKTW**      **TR**      **BA**      **DTA**      **COURSE CHANGE**      **DVEB**      **VEB OCS**      **RF CENTER FIX/DISTANCE**

**SEGMENT REMARKS:**

**AIRPORT** DANE COUNTY RGNL-TRUAX FIELD      **AIRPORT ID** KMSN      **PROCEDURE NAME** ILS OR LOC/DME RWY 18  
 ILS RWY 18 (SA CAT I)  
 ILS RWY 18 (SA CAT II)      **AMDT NO.** 2      **CITY** MADISON      **STATE** WI      **AIRPORT ELEVATION** 887      **FACILITY** I-DSZ

OBSTRUCTION	COORDINATES	ELEV MSL	HORZ	VERT	AC	ROC	OCS	CG	CGTA	ADJUSTMENTS	MIN ALT
15. TOWER (55-000891)	430332.14N/0890345.30W	1405	100	20	3C	1000					3500
16. TERRAIN	430733.00N/0891527.00W	1060 (1100)								AS1500	2500
											2600

**COMPUTATIONS**  
 Select from menu...

**SEGMENT REMARKS:**

MISSED APPROACH ALTERNATE: SA CAT I

**FROM** DA      **RNP**      **DISTANCE**      **PAT**      **MAP**      **HAT**      **HMAS**      **TO** DREAR/BAE VORTAC 33.66 DME

OBSTRUCTION	COORDINATES	ELEV MSL	HORZ	VERT	AC	ROC	OCS	CG	CGTA	ADJUSTMENTS	MIN ALT
15. TOWER (55-000891)	430332.14N/0890345.30W	1405	100	20	3C	1000					3500
16. TERRAIN	430733.00N/0891527.00W	1060 (1100)								AS1500	2500
											2600

**COMPUTATIONS**  
 Select from menu...

**SEGMENT REMARKS:**

MISSED APPROACH ALTERNATE: SA CAT II

**FROM** DA      **RNP**      **DISTANCE**      **PAT**      **MAP**      **HAT**      **HMAS**      **TO** DREAR/BAE VORTAC 33.66 DME

OBSTRUCTION	COORDINATES	ELEV MSL	HORZ	VERT	AC	ROC	OCS	CG	CGTA	ADJUSTMENTS	MIN ALT
15. TOWER (55-000891)	430332.14N/0890345.30W	1405	100	20	3C	1000					3500
16. TERRAIN	430733.00N/0891527.00W	1060 (1100)								AS1500	2500
											2600

**COMPUTATIONS**  
 Select from menu...

**SEGMENT REMARKS:**



**AIRPORT:** DANE COUNTY RGNL-TRUAX FIELD      **AIRPORT ID:** KMSN      **PROCEDURE NAME:** ILS OR LOC/DME RWY 18  
**AIRPORT ELEVATION:** 887      **STATE:** WI      **CITY:** MADISON      **AMDT NO.:** 2      **FACILITY:** I-DSZ  
**PROCEDURE NAME:** ILS RWY 18 (SA CAT I)  
**PROCEDURE NAME:** ILS RWY 18 (SA CAT II)

CIRCLING	OBSTRUCTION	ALL CATS		CATA		CATB		CATC		CATD		CATE		NOT AUTHORIZED		MIN ALT
		COORDINATES	RADIUS	HAA	ELEVMSL	HORZ	VERT	AC	ROC	OCS	ADJUSTMENTS	ADJUSTMENTS	ADJUSTMENTS	ADJUSTMENTS		
<b>CATEGORY A</b>																
17. TREE	430944.00N/0891948.00W	1.30	533	1109	50	20	2C	300								1420
<b>CATEGORY B</b>																
18. TANK (55-000759)	430819.30N/0892224.57W	1.84	533	1158	20	10	1B	300								1460
<b>CATEGORY C</b>																
18. TANK (55-000759)	430819.30N/0892224.57W	2.89	573	1158	20	10	1B	300								1460
<b>CATEGORY D</b>																
1. TWR (55-000509)	431027.00N/0891520.00W	3.77	813	1343	500	50	5D	300						AC50		1700
<b>CATEGORY E</b>																
1. TWR (55-000509)	431027.00N/0891520.00W	4.72	813	1343	500	50	5D	300						AC50		1700
<b>CIRCLING REMARKS:</b>																
<b>MSA</b> <input type="checkbox"/>																
<b>CENTER</b> <b>RADIUS</b>																
MSN VORTAC      25																
SECTOR	OBSTRUCTION	COORDINATES	BEARING	DISTANCE	ELEVMSL	HORZ	VERT	AC	ROC	ADJUSTMENTS	ADJUSTMENTS	ADJUSTMENTS	ADJUSTMENTS	ADJUSTMENTS	ADJUSTMENTS	MIN ALT
360-180	19. TWR (55-001319)	435521.00N/0892354.21W	166	25.5	2049	250	50	4D	1000							3100
180-360	20. TWR (55-000756)	434974.53N/0891259.94W	235	10.1	2549	500	50	5D	1000							3600

**MSA REMARKS:**

**NOTES/EXPLANATIONS FROM PROCEDURE SEGMENTS:**

**PART B: SUPPLEMENTAL DATA**

**COMMUNICATIONS WITH**  
 ZAU ARTCC; MSN APP CON; MSN TWR

WX SERVICE	LOCATION	HRS OPERATION	ALTIMETER SOURCE	DISTANCE	SERVICE-A	ADJUSTMENTS
ASOS	KMSN	24	KMSN	0	Y	0
BACK-UP WX SERVICE	LOCATION	HRS OPERATION	ALTIMETER SOURCE	DISTANCE	SERVICE-A	ADJUSTMENTS

**WX REMARKS:**  
 REDUNDANT WEATHER SOURCES AVAILABLE ON ARPT (LLAWS AND ASOS)

**AIRPORT** DANE COUNTY RGNL-TRUAX FIELD      **AIRPORT ID** KMSN      **PROCEDURE NAME** ILS OR LOC/DME RWY 18  
 ILS RWY 18 (SA CAT I)  
 ILS RWY 18 (SA CAT II)      **STATE** WI      **AIRPORT ELEVATION** 887      **FACILITY** I-DSZ  
**AIRPORT** I-DSZ      **AMDT NO.** 2      **CITY** MADISON

PRIMARY NAVAID	MONITOR POINT	HRS OPERATION	CAT	STATE	AIRPORT ELEVATION	FACILITY
I-DSZ	ATCT	TOWER OPEN TOWER CLOSED	1 3	WI	887	I-DSZ
<b>APPROACH AND RUNWAY LIGHTING SYSTEM</b>						
RW03 - HIRL (PCL), REIL (PCL), PAPI-4L			PIR-G			-
RW21 - MALSR, HIRL (PCL), C/L, PAPI-4L			PIR-G			+
RW14 - HIRL (PCL), REIL, PAPI-4L			NPI-G			-
RW32 - HIRL (PCL), REIL (PCL), PAPI-4L			NPI-G			+
RW18 - MALSR (PCL), HIRL (PCL), PAPI-4L (PCL)			PIR-G			-
RW36 - ALSF-2, HIRL (PCL), TDZ, C/L, PAPI-4L			PIR-G			+

GLIDESLOPE ANGLE	ELEV RWY THRESHOLD	ICH	ELEV GS ANTENNA	DISTANCE FROM RWY	VGSI ANGLE	ICH	RUNWAY VISUAL RANGE
3.00	859.3	57.3	859.2	1094	3.00	57	
<b>FINAL APPROACH COURSE AIMING</b>							
RUNWAY THRESHOLD	<input checked="" type="checkbox"/>		FT FROM THRESHOLD	DISPLACED THRESHOLD DISTANCE 400 FT			
ON CENTERLINE	<input checked="" type="checkbox"/>		FT FROM CENTERLINE				
<b>CRITICAL TEMPERATURES</b>							
CRITICAL LOW	CRITICAL HIGH	ACT	APT ISA				

**CRITICAL TEMPERATURE REMARKS:**

**"VISUAL PORTION OF FINAL" PENETRATIONS**

FINAL TYPE	<input type="checkbox"/> + <input type="checkbox"/> -
20:1 RUNWAY	<input type="checkbox"/> + <input type="checkbox"/> -
34:1 RUNWAY	<input type="checkbox"/> + <input type="checkbox"/> -

**PENETRATIONS REMARKS:**

**HELICOPTER 'VISUAL PORTION OF FINAL' PENETRATIONS**

and/or

FAA Form 8260-9 / (11/16) Supersedes Previous Edition

Electronic Version

**AIRPORT** DANE COUNTY RGNL-TRUAX FIELD      **AIRPORT ID** KMSN      **PROCEDURE NAME** ILS RWY 18 (SA CAT I)  
**AIRPORT ELEVATION** 887      **STATE** WI      **CITY** MADISON      **AMDT NO.** 2      **FACILITY** I-DSZ  
**ILS RWY 18 (SA CAT I)**  
**ILS RWY 18 (SA CAT II)**

**5280-FT "PROCEED VFR" SEGMENT LEVEL SURFACE AREA PENETRATIONS**

**PENETRATIONS REMARKS:**

**PART C: GENERAL REMARKS:**  
 PRECIPITOUS TERRAIN EVALUATION COMPLETED; VEGETATION HEIGHT 100 FT

**PART D: AIRSPACE**

**DOCKET #**

ALL DISTANCES TO 1/100NM; ELEVATION TO NEAREST 100 FEET; COORDINATES TO 1/100 SECOND; DEG TO 1/100 DEGREE

DISTANCE FROM	THLD	TO 1000FT POINT	3.40
WIDTH OF	FINAL	SEGMENT AT 1000FT POINT	0.95
TRUE COURSE OF	FINAL	SEGMENT CONTAINING 1000FT POINT	181.94
HIGH TERRAIN IN	FINAL	SEGMENT CONTAINING 1000FT POINT	1000
DISTANCE FROM	THLD	TO 1500FT POINT	4.97
WIDTH OF	FINAL	SEGMENT AT 1500FT POINT	1.29
TRUE COURSE OF	FINAL	SEGMENT CONTAINING 1500FT POINT	181.94
HIGH TERRAIN IN	FINAL	SEGMENT CONTAINING 1500FT POINT	1000

**THRESHOLD COORDINATES (IF STR-IN)**  
 430852.95N/0892027.88W\*

**ARP COORDINATES**  
 430823.49N/0892015.05W

**RUNWAY APCH END AND DIST FURTHEST FROM MAP**  
 RW36/0.95

**FAF COORDINATES**  
 431346.85N/0892014.27W

**FIX NAME COORDINATES**

**REMARKS**  
 \* DISPLACED THRESHOLD; NO ADDITIONAL AIRSPACE REQUIRED

**AIRPORT** DANE COUNTY RGNL-TRUAX FIELD      **AIRPORT ID** KMSN      **PROCEDURE NAME** ILS OR LOC/DME RWY 18  
 ILS RWY 18 (SA CAT I)  
 ILS RWY 18 (SA CAT II)      **AMDT NO.** 2      **CITY** MADISON      **STATE** WI      **AIRPORT ELEVATION** 887      **FACILITY** I-DSZ

**PART E: PREPARED BY**  
**NAME**      **OFFICE**      **DATE**      **TITLE**

Figure 4.

**FEDERAL AVIATION ADMINISTRATION  
FLIGHT STANDARDS SERVICE  
STANDARD INSTRUMENT APPROACH PROCEDURE DATA RECORD**

<b>AIRPORT</b> ATLANTIC CITY	<b>AIRPORT ID</b> KACY	<b>PROCEDURE NAME</b> RADAR-1	<b>AMDT NO.</b> 16	<b>CITY</b> ATLANTIC CITY	<b>STATE</b> NJ	<b>AIRPORT ELEVATION</b> 75	<b>FACILITY</b> ACY ASR
---------------------------------	---------------------------	----------------------------------	-----------------------	------------------------------	--------------------	--------------------------------	----------------------------

---

**PART A: OBSTRUCTION DATA SEGMENTS**

<b>FINAL:</b> RW04	<input type="button" value="▼"/>	<b>TO</b> 2 NM					<input type="button" value="+"/> <input type="button" value="-"/>
<b>FROM</b> 5 NM							
<b>RNP</b>	<b>DISTANCE</b> 3.00	<b>PAT</b>	<b>MAP</b>	<b>HAT</b>	<b>HMAS</b>		
<b>OBSTRUCTION</b>	<b>COORDINATES</b> 392442.04N/0743811.54W	<b>VERT AC</b> 20 2C	<b>ROC</b> 250	<b>OCS</b>	<b>CG</b> CGTA	<b>ADJUSTMENTS</b> DG180	<b>MIN ALT</b> 700
1. AAO	<b>ELEV MSL</b> 270	<b>HORZ</b> 50	<b>VERT</b> 20 2C	<b>BA</b>	<b>DTA</b>	<b>VEB OCS</b>	<b>RF CENTER FIX/DISTANCE</b>

**COMPUTATIONS**  
Select from menu...

<b>ALT</b>	<b>KIAS</b>	<b>KTAS</b>	<b>HAA</b>	<b>VKTW</b>	<b>TR</b>	<b>BA</b>	<b>DTA</b>	<b>COURSE CHANGE</b>	<b>DVEB</b>	<b>VEB OCS</b>	<b>RF CENTER FIX/DISTANCE</b>
------------	-------------	-------------	------------	-------------	-----------	-----------	------------	----------------------	-------------	----------------	-------------------------------

---

**SEGMENT REMARKS:**  
FAF ALTITUDE IS 1600

<b>FINAL:</b> RW04	<input type="button" value="▼"/>	<b>TO</b> RW04					<input type="button" value="+"/> <input type="button" value="-"/>
<b>FROM</b> 2 NM							
<b>RNP</b>	<b>DISTANCE</b> 2.00	<b>PAT</b>	<b>MAP</b>	<b>HAT</b>	<b>HMAS</b>		
<b>OBSTRUCTION</b>	<b>COORDINATES</b> 392537.77N/0743508.49W	<b>VERT AC</b> 20 2C	<b>ROC</b> 250	<b>OCS</b>	<b>CG</b> CGTA	<b>ADJUSTMENTS</b>	<b>MIN ALT</b> 480
2. POLE (34-024084)	<b>ELEV MSL</b> 222	<b>HORZ</b> 50	<b>VERT</b> 20 2C	<b>BA</b>	<b>DTA</b>	<b>VEB OCS</b>	<b>RF CENTER FIX/DISTANCE</b>

**COMPUTATIONS**  
Select from menu...

<b>ALT</b>	<b>KIAS</b>	<b>KTAS</b>	<b>HAA</b>	<b>VKTW</b>	<b>TR</b>	<b>BA</b>	<b>DTA</b>	<b>COURSE CHANGE</b>	<b>DVEB</b>	<b>VEB OCS</b>	<b>RF CENTER FIX/DISTANCE</b>
------------	-------------	-------------	------------	-------------	-----------	-----------	------------	----------------------	-------------	----------------	-------------------------------

---

**SEGMENT REMARKS:**

<b>FINAL:</b> RW13	<input type="button" value="▼"/>	<b>TO</b> 2 NM					<input type="button" value="+"/> <input type="button" value="-"/>
<b>FROM</b> 5 NM							
<b>RNP</b>	<b>DISTANCE</b> 3.00	<b>PAT</b>	<b>MAP</b>	<b>HAT</b>	<b>HMAS</b>		

**AIRPORT** ATLANTIC CITY      **AIRPORT ID** KACY      **PROCEDURE NAME** RADAR-1      **AMDT NO.** 16      **CITY** ATLANTIC CITY      **STATE** NJ      **AIRPORT ELEVATION** 75      **FACILITY** ACY ASR

**OBSTRUCTION**  
3. AAO      **COORDINATES** 393102.22N/0743939.03W      **ELEV MSL** 269      **HORZ** 50      **VERT** 20      **AC** 2C      **ROC** 250      **OCS**      **CG**      **CGTA**      **ADJUSTMENTS** DG201      **MIN ALT** 720

**COMPUTATIONS**  
Select from menu...      **ALT**      **KIAS**      **KTAS**      **HAA**      **VKTW**      **TR**      **BA**      **DTA**      **COURSE CHANGE**      **DVEB**      **VEB OCS**      **RF CENTER FIX/DISTANCE**

**SEGMENT REMARKS:**  
FAF ALTITUDE IS 1600

**FINAL: RW13**      **TO** RW13      **FROM** 2 NM      **RNP**      **DISTANCE** 2.00      **PAT**      **MAP**      **HAT**      **HMAS**      **OBSTRUCTION**      **COORDINATES** 392705.00N/0743556.00W      **ELEV MSL** 217      **HORZ** 20      **VERT** 10      **AC** 1B      **ROC** 250      **OCS**      **CG**      **CGTA**      **ADJUSTMENTS**      **MIN ALT** 480

**COMPUTATIONS**  
Select from menu...      **ALT**      **KIAS**      **KTAS**      **HAA**      **VKTW**      **TR**      **BA**      **DTA**      **COURSE CHANGE**      **DVEB**      **VEB OCS**      **RF CENTER FIX/DISTANCE**

**SEGMENT REMARKS:**

**FINAL: RW22**      **TO** 2 NM      **FROM** 5 NM      **RNP**      **DISTANCE** 3.00      **PAT**      **MAP**      **HAT**      **HMAS**      **OBSTRUCTION**      **COORDINATES** 393209.42N/0743049.54W      **ELEV MSL** 289      **HORZ** 500      **VERT** 50      **AC** 5D      **ROC** 250      **OCS**      **CG**      **CGTA**      **ADJUSTMENTS** AC50 DG131      **MIN ALT** 720

**COMPUTATIONS**  
Select from menu...      **ALT**      **KIAS**      **KTAS**      **HAA**      **VKTW**      **TR**      **BA**      **DTA**      **COURSE CHANGE**      **DVEB**      **VEB OCS**      **RF CENTER FIX/DISTANCE**

**SEGMENT REMARKS:**  
FAF ALTITUDE IS 1600

AIRPORT ATLANTIC CITY AIRPORT ID KACY AIRPORT NAME RADAR-1 AMDT NO. 16 CITY ATLANTIC CITY STATE NJ AIRPORT ELEVATION 75 FACILITY ACY ASR

FINAL: RW22 + -

FROM 2 NM  
RNP DISTANCE 2.00  
PAT HAT  
HMAS  
OBSTRUCTION  
COORDINATES 392837.00N/0743222.00W  
ELEV MSL 245 HORIZ 500 VERT 50 AC 5D 250 ROC 250  
OCS CG CGTA  
ADJUSTMENTS AC50  
MIN ALT 560

COMPUTATIONS  
Select from menu... ALT KIAS KTAS HAA VKTW TR BA DTA COURSE CHANGE DVEB VEB OCS RF CENTER FIX/DISTANCE

SEGMENT REMARKS:

FINAL: RW31 + -

FROM 5 NM  
RNP DISTANCE 3.00  
PAT HAT  
HMAS  
OBSTRUCTION  
COORDINATES 392455.08N/0743153.77N  
ELEV MSL 319 HORIZ 500 VERT 20 AC 2C 250 ROC 250  
OCS CG CGTA  
ADJUSTMENTS DG231  
MIN ALT 800

COMPUTATIONS  
Select from menu... ALT KIAS KTAS HAA VKTW TR BA DTA COURSE CHANGE DVEB VEB OCS RF CENTER FIX/DISTANCE

SEGMENT REMARKS:  
FAF ALTITUDE IS 1800

FINAL: RW31 + -

FROM 2 NM  
RNP DISTANCE 2.00  
PAT HAT  
HMAS

**AIRPORT** ATLANTIC CITY      **AIRPORT ID** KACY      **PROCEDURE NAME** RADAR-1      **AMDT NO.** 16      **CITY** ATLANTIC CITY      **STATE** NJ      **AIRPORT ELEVATION** 75      **FACILITY** ACY ASR  
**COORDINATES** 392717.63N/0743310.66W      **ELEV/MSL** 171      **HORZ** 20      **VERT** 3      **AC** 1A      **ROC** 250      **CG**      **CGTA**      **ADJUSTMENTS** AT59      **MIN.ALT** 480  
**OBSTRUCTION** 8. TOWER (34-020095)

**COMPUTATIONS**  
 Select from menu...  **ALT**      **KIAS**      **KTAS**      **HAA**      **VKTW**      **TR**      **BA**      **DTA**      **COURSE CHANGE**      **DVEB**      **VEB\_OCS**      **RF\_CENTER FIX/DISTANCE**

**SEGMENT REMARKS:**

**MISSED APPROACH**  **FROM** RW04      **TO** SMITS INT      **HAT**      **HMAS**      **MIN.ALT**     
**RNP**      **DISTANCE**      **PAT**      **MAP**      **ASC**      **OC**      **CG**      **CGTA**      **ADJUSTMENTS**      **MIN.ALT**  
**OBSTRUCTION**      **COORDINATES**      **ELEV/MSL**      **HORZ**      **VERT**      **AC**      **ROC**      **ASC**      **ADJUSTMENTS**      **MIN.ALT**  
 9. TOWER (34-001011)      392752.78N/0742956.23W      283      20      3      1A      1000                2000  
 10. TERRAIN      392751.00N/0743557.00W      73 (100)                                         1300  
**COMPUTATIONS**      **ALT**      **KIAS**      **KTAS**      **HAA**      **VKTW**      **TR**      **BA**      **DTA**      **COURSE CHANGE**      **DVEB**      **VEB\_OCS**      **RF\_CENTER FIX/DISTANCE**  
 Select from menu...

**SEGMENT REMARKS:**

**MISSED APPROACH**  **FROM** RW13      **TO** SMITS INT      **HAT**      **HMAS**      **MIN.ALT**     
**RNP**      **DISTANCE**      **PAT**      **MAP**      **ASC**      **OC**      **CG**      **CGTA**      **ADJUSTMENTS**      **MIN.ALT**  
**OBSTRUCTION**      **COORDINATES**      **ELEV/MSL**      **HORZ**      **VERT**      **AC**      **ROC**      **ASC**      **ADJUSTMENTS**      **MIN.ALT**  
 9. TOWER (34-001011)      392752.78N/0742956.23W      283      20      3      1A      1000                2000  
 10. TERRAIN      392751.00N/0743557.00W      73 (100)                                         1300  
**COMPUTATIONS**      **ALT**      **KIAS**      **KTAS**      **HAA**      **VKTW**      **TR**      **BA**      **DTA**      **COURSE CHANGE**      **DVEB**      **VEB\_OCS**      **RF\_CENTER FIX/DISTANCE**  
 Select from menu...

**SEGMENT REMARKS:**



AIRPORT ATLANTIC CITY AIRPORT ID KACY AIRPORT NAME RADAR-1 AMDT NO. 16 CITY ATLANTIC CITY STATE NJ AIRPORT ELEVATION 75 FACILITY ACY ASR

MISSED APPROACH		TO				+ -					
FROM	SMITS INT										
RNP	SMITS INT	HAT	HMAS								
OBSTRUCTION	COORDINATES	ELEV MSL	HORZ	VERT	AC	ROC	CGTA	ADJUSTMENTS	MIN ALT		
11. BLDG (34-000681)	392303.20N/0742541.50W	531	20	3	1A	1000			2000		
12. TERRAIN	392754.00N/0743557.00W	73 (100)						AS1500	1600		
COMPUTATIONS											
Select from menu...											
ALT	KIAS	KTAS	HAA	VKTW	TR	BA	DTA	COURSE CHANGE	DVEB	VEB OCS	RF CENTER FIX/DISTANCE

SEGMENT REMARKS:

MISSED APPROACH		TO				+ -					
FROM	SMITS INT										
RNP	SMITS INT	HAT	HMAS								
OBSTRUCTION	COORDINATES	ELEV MSL	HORZ	VERT	AC	ROC	CGTA	ADJUSTMENTS	MIN ALT		
13. TOWER (34-000681)	393034.00N/0743537.00W	294	500	50	5D	1000			2000		
14. TERRAIN	393318.00N/0743315.73W	73 (100)						AS1500	1300		
COMPUTATIONS											
Select from menu...											
ALT	KIAS	KTAS	HAA	VKTW	TR	BA	DTA	COURSE CHANGE	DVEB	VEB OCS	RF CENTER FIX/DISTANCE

SEGMENT REMARKS:

CIRCLING		ALL CATS		CATA		CATB		CATC		CATD		CATE		NOT AUTHORIZED		ADJUSTMENTS		MIN ALT	
OBSTRUCTION	COORDINATES	RADIUS	HAA	ELEV MSL	HORZ	VERT	AC	ROC	OCS	ROC	OCS	AC	ROC	OCS	ADJUSTMENTS	MIN ALT			
15. BLDG (34-00581)	292719.00N/0743517.00W	1.30	485	288	20	3	1A	300							S120	560			
6. TOWER (34-000070)	392837.00N/0743222.00W	1.81	525	245	500	50	5D	300							AC50	600			
7. TOWER (34-000686)	392455.08N/0743153.77N	2.84	545	319	50	20	2C	300								620			

**AIRPORT** ATLANTIC CITY      **AIRPORT ID** KACY      **PROCEDURE NAME** RADAR-1      **AMDT NO.** 16      **CITY** ATLANTIC CITY      **STATE** NJ      **AIRPORT ELEVATION** 75      **FACILITY** ACY ASR

**CATEGORY D**  
7. TOWER (34-000686)      392455.08N/0743153.77N      3.71      565      319      50      20      2C      300      HA20      640  
**CATEGORY E**  
16. TOWER (34-000510)      392324.00N/0743044.00W      4.63      685      394      500      50      5D      300      AC50      760  
**CIRCLING REMARKS:**

SECTOR	OBSTRUCTION	COORDINATES	BEARING	DISTANCE	ELEV MSL	HORZ	VERT	AC	ROC	ADJUSTMENTS	MIN ALT		
											-	+	
<b>RADIUS</b>												-	+

**MSA REMARKS:**

**NOTES/EXPLANATIONS FROM PROCEDURE SEGMENTS:**  
INITIAL AND INTERMEDIATE SEGMENTS USE ATLANTIC CITY ASR MINIMUM VECTORING ALTITUDE CHART

**PART B: SUPPLEMENTAL DATA**

**COMMUNICATIONS WITH**  
ACY APP CON, ACY ATCT

WX SERVICE	LOCATION	HRS OPERATION	ALTIMETER SOURCE	DISTANCE	SERVICE-A	ADJUSTMENTS
ASOS	KACY	24	KACY	0	Y	0
BACK-UP WX SERVICE	LOCATION	HRS OPERATION	ALTIMETER SOURCE	DISTANCE	SERVICE-A	ADJUSTMENTS

**WX REMARKS:**

PRIMARY NAVAID	MONITOR POINT	HRS OPERATION	CAT	APPROACH AND RUNWAY LIGHTING SYSTEM	RUNWAY MARKINGS	RUNWAY VISUAL RANGE
ACY ASR	ACY APP CON	24	1			
	RW04 - HIRL, PAPI-4L				NPI-G	-
	RW22 - HIRL, VAPI-4L				NPI-G	+
	RW13 - MALS, HIRL, TDZ, C/L, PAPI-4L				PIR-G	-
	RW31 - HIRL, REIL, C/L, PAPI-4L				PIR-G	+
<b>GLIDESLOPE ANGLE</b>	<b>ELEV RWY THRESHOLD</b>	<b>TCH</b>	<b>ELEV GS ANTENNA</b>	<b>DISTANCE FROM RWY</b>	<b>VGSI ANGLE</b>	<b>TCH</b>



AIRPORT  
ATLANTIC CITY

AIRPORT ID  
KACY

PROCEDURE NAME  
RADAR-1

AMDT NO.  
16

CITY  
ATLANTIC CITY

STATE  
NJ

AIRPORT ELEVATION  
75

FACILITY  
ACY ASR

PART D: AIRSPACE

DOCKET #

ALL DISTANCES TO 1/100NM; ELEVATION TO NEAREST 100 FEET; COORDINATES TO 1/100 SECOND; DEG TO 1/100 DEGREE

DISTANCE FROM	Select from menu...	<input type="checkbox"/>	TO 1000FT POINT
WIDTH OF	Select from menu...	<input type="checkbox"/>	SEGMENT AT 1000FT POINT
TRUE COURSE OF	Select from menu...	<input type="checkbox"/>	SEGMENT CONTAINING 1000FT POINT
HIGH TERRAIN IN	Select from menu...	<input type="checkbox"/>	SEGMENT CONTAINING 1000FT POINT
DISTANCE FROM	Select from menu...	<input type="checkbox"/>	TO 1500FT POINT
WIDTH OF	Select from menu...	<input type="checkbox"/>	SEGMENT AT 1500FT POINT
TRUE COURSE OF	Select from menu...	<input type="checkbox"/>	SEGMENT CONTAINING 1500FT POINT
HIGH TERRAIN IN	Select from menu...	<input type="checkbox"/>	SEGMENT CONTAINING 1500FT POINT

THRESHOLD  
COORDINATES  
(IF STR-IN)

ARP COORDINATES  
RUNWAY APCH END  
AND DIST FURTHEST  
FROM MAP

Select   
COORDINATES

FIX NAME  
COORDINATES

REMARKS  
NO ADDITIONAL AIRSPACE REQUIRED

PART E: PREPARED BY

NAME	OFFICE	DATE	TITLE

Figure 5.

COPTER  Reset Form

**FEDERAL AVIATION ADMINISTRATION  
FLIGHT STANDARDS SERVICE  
STANDARD INSTRUMENT APPROACH PROCEDURE DATA RECORD**

AIRPORT SHREVEPORT RGNL	AIRPORT ID KSHV	PROCEDURE NAME LOC RWY 6	AMD T NO. 3	CITY SHREVEPORT	STATE LA	AIRPORT ELEVATION 258	FACILITY RNAV
----------------------------	--------------------	-----------------------------	----------------	--------------------	-------------	--------------------------	------------------

**PART A: OBSTRUCTION DATA SEGMENTS**

INTERMEDIATE  + -

**FROM**  
GIGGS/I-MWP 12.01 DME/RADAR

RNP **DISTANCE** 6.00

TO  
DODDY/I-MWP 6.01 DME/RADAR

OBSTRUCTION	COORDINATES	ELEV MSL	HORZ	VERT	AC	ROC	OCS	CG	CGTA	ADJUSTMENTS	MIN ALT
1. TOWER (22-001533)	322320.00N/0940112.00W	1049	100	20	3C	500				AT541	2000
2. TERRAIN	322406.00N/0935954.00W	371 (400)								AS1500	1900

**COMPUTATIONS**  
Select from menu...

**SEGMENT REMARKS:**

---

**FINAL: LOC**  
**FROM**  
DODDY/I-MWP 6.01 DME/RADAR

RNP **DISTANCE** 3.57

TO  
WOXAT/I-MWP 2.44 DME

OBSTRUCTION	COORDINATES	ELEV MSL	HORZ	VERT	AC	ROC	OCS	CG	CGTA	ADJUSTMENTS	MIN ALT
3. AAO	322508.61N/0935324.29W	430	50	20	2C	250					700

**COMPUTATIONS**  
Select from menu...

**SEGMENT REMARKS:**

---

**FINAL: LOC STEPDOWN**  
**FROM**  
WOXAT/I-MWP 2.44 DME

RNP **DISTANCE** 1.20

TO  
4.77 MILES AFTER DODDY/I-MWP 6.01 DME/RADAR OR AT I-MWP 1.24 DME FIX

OBSTRUCTION	COORDINATES	ELEV MSL	HORZ	VERT	AC	ROC	OCS	CG	CGTA	ADJUSTMENTS	MIN ALT

**COMPUTATIONS**  
Select from menu...

**SEGMENT REMARKS:**

(SEE "TO" BLOCK ABOVE)

**AIRPORT** SHREVEPORT RGNL      **AIRPORT ID** KSHV      **AIRPORT NAME** LOC RWY 6      **AMDT NO.** 3      **CITY** SHREVEPORT      **STATE** LA      **AIRPORT ELEVATION** 258      **FACILITY** RNAV

**COORDINATES** 322508.61N/0935324.29W      **ELEV MSL** 362      **HORZ** 20      **VERT** 3      **AC** 1A      **ROC** 250      **OCS**      **CG**      **CGTA**      **ADJUSTMENTS**      **MIN ALT** 620

**COMPUTATIONS**  
Select from menu...      **ALT**      **KIAS**      **KTAS**      **HAA**      **VKTW**      **TR**      **BA**      **DTA**      **COURSE CHANGE**      **DVEB**      **VEB OCS**      **RF CENTER FIX/DISTANCE**

**SEGMENT REMARKS:**

**MISSED APPROACH**                 

**FROM** 4.77 MILES AFTER DODDY/I-MWP 6.01 DME/RADAR      **TO** EMG VORTAC      **HAT**

**RNP**      **DISTANCE**      **PAT**      **MAP**      **HMAS** 370

**OBSTRUCTION**      **COORDINATES**      **ELEV MSL**      **HORZ**      **VERT**      **AC**      **ROC**      **ASC**      **ADJUSTMENTS**      **MIN ALT**

5. TOWER (22-002854)      322124.00N/0934038.00W      596      500      50      5D      1000                1600

6. TERRAIN      322527.00N/0934854.00W      273 (300)                                              AS1500      1600

**COMPUTATIONS**  
Select from menu...      **ALT**      **KIAS**      **KTAS**      **HAA**      **VKTW**      **TR**      **BA**      **DTA**      **COURSE CHANGE**      **DVEB**      **VEB OCS**      **RF CENTER FIX/DISTANCE**

**SEGMENT REMARKS:**

**MISSED APPROACH ALTERNATE**                 

**FROM** 4.77 MILES AFTER DODDY/I-MWP 6.01 DME/RADAR      **TO** EIC VORTAC      **HAT**

**RNP**      **DISTANCE**      **PAT**      **MAP**      **HMAS** 370

**OBSTRUCTION**      **COORDINATES**      **ELEV MSL**      **HORZ**      **VERT**      **AC**      **ROC**      **ASC**      **ADJUSTMENTS**      **MIN ALT**

7. TOWER (22-001534)      323539.29N/0935140.26W      1046      250      50      4D      1000                4000

8. TERRAIN      323518.00N/0935127.00W      381 (400)                                              AS1500      1900

**COMPUTATIONS**  
Select from menu...      **ALT**      **KIAS**      **KTAS**      **HAA**      **VKTW**      **TR**      **BA**      **DTA**      **COURSE CHANGE**      **DVEB**      **VEB OCS**      **RF CENTER FIX/DISTANCE**

**SEGMENT REMARKS:**

**AIRPORT** SHREVEPORT RGNL      **AIRPORT ID** KSHV      **PROCEDURE NAME** LOC RWY 6      **AMDT NO.** 3      **CITY** SHREVEPORT      **STATE** LA      **AIRPORT ELEVATION** 258      **FACILITY** RNAV

CIRCLING	OBSTRUCTION	COORDINATES		RADIUS	HAA	ELEVMSL	CATC	CATD	CAT E	NOT AUTHORIZED			MIN ALT
		ALL CATS	CATA							CATB	CATC	CATD	
<b>CATEGORY A</b>													
9. TOWER (22-000718)		322721.40N/0934730.37W		1.30	482/482	440	20	10	1B	300			740/740
<b>CATEGORY B</b>													
10 STADIUM (22-021583)		322832.12N/0934734.59W		1.81	502/502	446	20	3	1A	300			760/760
<b>CATEGORY C</b>													
11. TOWER (22-003280)		322827.26N/0934611.32W		2.85	722/722	669	50	20	2C	300			980/980
<b>CATEGORY D</b>													
12. TOWER (22-001303)		322937.00N/0934556.00W		3.72	842/842	739	500	50	5D	300	AC50/AC50		1100/1100
<b>CATEGORY E</b>													
12. TOWER (22-001303)		322937.00N/0934556.00W		4.65	842/842	739	500	50	5D	300	AC50/AC50		1100/1100
<b>CIRCLING REMARKS:</b>													
<b>MSA</b> <input type="checkbox"/>													
<b>CENTER</b> EMG VORTAC <b>RADIUS</b> 25													
<b>SECTOR</b>	<b>OBSTRUCTION</b>	<b>COORDINATES</b>	<b>BEARING</b>	<b>DISTANCE</b>	<b>ELEVMSL</b>	<b>HORIZ</b>	<b>VERT</b>	<b>AC</b>	<b>ROC</b>	<b>ADJUSTMENTS</b>	<b>MIN ALT</b>		
360-360	13. TWR (22-000160)	324525.12N/0934156.43W	308	24.2	2075	10	50	1D	1000		3100	-	+

**MSA REMARKS:**

**NOTES/EXPLANATIONS FROM PROCEDURE SEGMENTS:**

**PART B: SUPPLEMENTAL DATA**

**COMMUNICATIONS WITH**  
ZFW ARTCC, SHV APP CON, SHV TOWER

WX SERVICE	LOCATION	HRS OPERATION	ALTIMETER SOURCE	DISTANCE	SERVICE-A	ADJUSTMENTS
ASOS	KSHV	24	KSHV	0	Y	0

BACK-UP WX SERVICE	LOCATION	HRS OPERATION	ALTIMETER SOURCE	DISTANCE	SERVICE-A	ADJUSTMENTS

**WX REMARKS:**

BACKUP ALTIMETER SOURCE NOT UTILIZED. KSHV HAS REDUNDANT WEATHER SOURCING

**PRIMARY NAVAID** I-MWP      **MONITOR POINT** KSHV ATCT      **HRS OPERATION** 24      **CAT** 1

AIRPORT SHREVEPORT RGNL AIRPORT ID KSHV AIRPORT ELEVATION 258 FACILITY RNAV  
 AIRPORT ELEVATION 258  
 STATE LA  
 CITY SHREVEPORT  
 AMDT NO. 3  
 PROCEDURE NAME LOC RWY 6  
 RUNWAY MARKINGS

APPROACH AND RUNWAY LIGHTING SYSTEM		RUNWAY MARKINGS		RUNWAY VISUAL RANGE	
RW06 - MRL, REIL, PAPI-4L		NPI-G			
RW24 - MRL, REIL, VAPI-4L		NPI-G			
RW14 - ALSF-2, HIRL, TDZ, C/L, PAPI-4R		PIR-G		APPROACH, MIDFIELD, ROLL OUT	
RW32 - MALS, HIRL, C/L		PIR-G			

GLIDESLOPE ANGLE	ELEV RWY THRESHOLD	TCH	ELEV GS ANTENNA	DISTANCE FROM RWY	VGSI ANGLE	TCH
					3.00	51.2

**FINAL APPROACH COURSE AIMING**

RUNWAY THRESHOLD  FT FROM THRESHOLD  
 ON CENTERLINE  FT FROM CENTERLINE

**CRITICAL TEMPERATURES**

CRITICAL LOW CRITICAL HIGH ACT APT ISA

**CRITICAL TEMPERATURE REMARKS:**

**"VISUAL PORTION OF FINAL" PENETRATIONS**

FINAL TYPE LOC

20:1 RUNWAY

34:1 RUNWAY 06

- 358 TREE (KSHV7000061) 322619.00N/0935037.97W (6.50)
- 362 TREE (KSHV7000064) 322615.22N/0935037.45W (6.18)
- 353 TREE (KSHV7000060) 322622.52N/0935039.77W (2.62)

**PENETRATIONS REMARKS:**

**HELICOPTER "VISUAL PORTION OF FINAL" PENETRATIONS**

and/or  
 5280-FT "PROCEED VFR" SEGMENT LEVEL SURFACE AREA PENETRATIONS

**PENETRATIONS REMARKS:**



AIRPORT SHREVEPORT RGNL AIRPORT ID KSHV AIRPORT ELEVATION 258 FACILITY RNAV  
 AIRPORT ID KSHV AIRPORT ELEVATION 258 FACILITY RNAV  
 PROCEDURE NAME LOC RWY 6 AMDT NO. 3 CITY SHREVEPORT STATE LA

PART C: GENERAL REMARKS:  
 PRECIPITOUS TERRAIN EVALUATION COMPLETED; TERPS PARA.289 APPLIED TO 489 AAO 322358N/0935456W; VEGETATION 100 FT PER FPT CHECKLIST

PART D: AIRSPACE

DOCKET #

ALL DISTANCES TO 1/100NM; ELEVATION TO NEAREST 100 FEET; COORDINATES TO 1/100 SECOND; DEG TO 1/100 DEGREE

DISTANCE FROM	THLD	TO 1000FT POINT	2.44
WIDTH OF	FINAL	SEGMENT AT 1000FT POINT	0.75
TRUE COURSE OF	FINAL	SEGMENT CONTAINING 1000FT POINT	060.90
HIGH TERRAIN IN	FINAL	SEGMENT CONTAINING 1000FT POINT	300
DISTANCE FROM	THLD	TO 1500FT POINT	4.37
WIDTH OF	FINAL	SEGMENT AT 1500FT POINT	1.16
TRUE COURSE OF	FINAL	SEGMENT CONTAINING 1500FT POINT	060.90
HIGH TERRAIN IN	FINAL	SEGMENT CONTAINING 1500FT POINT	300

THRESHOLD COORDINATES (IF STR-IN)  
 322642.19N/0934958.51W

ARP COORDINATES  
 322347.80N/0934932.20W

RUNWAY APCH END AND DIST FURTHEST FROM MAP  
 RW32/0.75

FAF COORDINATES  
 322422.48N/0935454.20W

FIX NAME COORDINATES

REMARKS  
 NO ADDITIONAL AIRSPACE REQUIRED

PART E: PREPARED BY

NAME OFFICE DATE TITLE

THIS PAGE IS INTENTIONALLY LEFT BLANK

Figure 6.

**FEDERAL AVIATION ADMINISTRATION  
FLIGHT STANDARDS SERVICE**

**STANDARD INSTRUMENT APPROACH PROCEDURE DATA RECORD**

COPTER     VFR     HELIPORT  
 METHODIST HOSPITAL OF IN. INC.    HELIPORT ID: K8111    PROCEDURE NAME: COPTER RNAV (GPS) 060    AMDT NO. ORIG: INDIANAPOLIS    CITY: INDIANAPOLIS    STATE: IN    SURFACE ELEVATION: 729    FACILITY: RNAV

---

**PART A: OBSTRUCTION DATA SEGMENTS**

INITIAL     TO HIBAL  
 FROM COVPU     FROM HIBAL

RNP	DISTANCE	PAT	MAP	HAS	HIMAS	ADJUSTMENTS	MIN ALT
OBSTRUCTION							
1. CTRL TWR (18-000977)	394316.00N/0861701.00W	947	20	3	1A	1000	3100
2. TERRAIN	394500.00N/0861648.00W	801 (800)					2300

**COMPUTATIONS**  
Select from menu...    ALT    KIAS    KTAS    HAA    VKTW    TR    BA    DTA    COURSE CHANGE    DVEB    VEB OCS    RF CENTER FIX/DISTANCE

**SEGMENT REMARKS:**

---

INITIAL     TO HIBAL  
 FROM FIVAX     FROM HIBAL

RNP	DISTANCE	PAT	MAP	HAS	HIMAS	ADJUSTMENTS	MIN ALT
OBSTRUCTION							
3. TOWER (18-002546)	394713.30N/0861756.70W	1147	500	50	5D	1000	3100
4. TERRAIN	394627.00N/0861618.00W	804 (800)					2300

**COMPUTATIONS**  
Select from menu...    ALT    KIAS    KTAS    HAA    VKTW    TR    BA    DTA    COURSE CHANGE    DVEB    VEB OCS    RF CENTER FIX/DISTANCE

**SEGMENT REMARKS:**

---

INTERMEDIATE     TO JEKLO  
 FROM HIBAL     FROM HIBAL

RNP	DISTANCE	PAT	MAP	HAS	HIMAS	ADJUSTMENTS	MIN ALT
OBSTRUCTION							
3. TOWER (18-002546)	394713.30N/0861756.70W	1147	500	50	5D	1000	3100
4. TERRAIN	394627.00N/0861618.00W	804 (800)					2300

**COMPUTATIONS**  
Select from menu...    ALT    KIAS    KTAS    HAA    VKTW    TR    BA    DTA    COURSE CHANGE    DVEB    VEB OCS    RF CENTER FIX/DISTANCE

**SEGMENT REMARKS:**

HELIPORT: METHODIST HOSPITAL OF IN. INC. HELIPORT ID: K81II HELIPORT NAME: COPTER RNAV (GPS) 060 AMDT NO. ORIG: INDIANAPOLIS STATE: IN AIRPORT ELEVATION: 729 FACILITY: RNAV

OBSTRUCTION	COORDINATES	ELEV MSL	HORZ	VERT	AC	ROC	OCS	CGTA	ADJUSTMENTS	MIN ALT
5. TOWER (18-000975)	394417.00N/0861648.00W	923	20	3	1A	500			AT577	AT577
6. TERRAIN	394554.00W/0861600.00W	794 (800)							AS1000	1800

COMPUTATIONS: Select from menu... ALT KIAS KTAS HAA VKTW TR BA DTA COURSE CHANGE DVEB VEB OCS RF CENTER FIX/DISTANCE

SEGMENT REMARKS:

FINAL: LNAV	FROM	JEKLO	RNP	DISTANCE	PAT	MAP	HORZ	VERT	AC	ROC	OCS	CGTA	ADJUSTMENTS	MIN ALT
			2.00			MEDRE	50	20	2C	250			RA24 XP57	
						MEDRE								

COMPUTATIONS: Select from menu... ALT KIAS KTAS HAA VKTW TR BA DTA COURSE CHANGE DVEB VEB OCS RF CENTER FIX/DISTANCE

SEGMENT REMARKS: XP = TO KEEP MDA UNCHANGED FROM FLIGHT INSPECTED. VDP NOT ESTABLISHED - REMOTE ALTIMETER IN USE

MISSED APPROACH	FROM	JEKLO	RNP	DISTANCE	PAT	MAP	HORZ	VERT	AC	ROC	OCS	CGTA	ADJUSTMENTS	MIN ALT
						MEDRE	250	50	4D	1000			AS1500	
						MEDRE								

COMPUTATIONS: Select from menu... ALT KIAS KTAS HAA VKTW TR BA DTA COURSE CHANGE DVEB VEB OCS RF CENTER FIX/DISTANCE

SEGMENT REMARKS:

HELIPORT: METHODIST HOSPITAL OF IN. INC. HELIPORT ID: K8111 PROCEDURE NAME: COPTER RNAV (GPS) 060 AMDT. NO.: ORIG CITY: INDIANAPOLIS STATE: IN AIRPORT ELEVATION: 729 FACILITY: RNAV

CIRCLING (Select all that apply)  ALL CATS  CAT A  CAT B  CAT C  CAT D  CATE  NOT AUTHORIZED

NOT AUTHORIZED  
CIRCLING REMARKS:

SECTOR	OBSTRUCTION	COORDINATES	BEARING	DISTANCE	ELEV MSL	HORZ	VERT	AC	ROC	ADJUSTMENTS	MIN. ALT
360-360	10. TOWER (18-000148)	392141.00N/0864703.00W	176	22.6	2002	250	50	4D	1000		3100

MSA REMARKS:

NOTES/EXPLANATIONS FROM PROCEDURE SEGMENTS:

PART B: SUPPLEMENTAL DATA  
COMMUNICATIONS WITH  
IND APP CON

WX SERVICE	LOCATION	HRS OPERATION	ALTIMETER SOURCE	DISTANCE	SERVICE-A	ADJUSTMENTS
AWOS-3	K8A4	24	FAA ATCT RAPCON	1.54	N	0
BACK-UP WX SERVICE	LOCATION	HRS OPERATION	ALTIMETER SOURCE	DISTANCE	SERVICE-A	ADJUSTMENTS
ASOS	KIND	24	KIND	7.49	Y	23.81

WX REMARKS:  
RASS PRESSURE PATTERNS THE SAME K8111 - 844, K8A4 - 732, KIND - 797; RA = 0 FOR K8A4 LESS THAN 5 NM

PRIMARY NAVAID: MONITOR POINT HRS OPERATION: CAT

APPROACH AND RUNWAY LIGHTING SYSTEM	RUNWAY MARKINGS	RUNWAY VISUAL RANGE
		<input type="checkbox"/> <input type="checkbox"/>

GLIDESLOPE ANGLE: ELEV RWY THRESHOLD: TCH: ELEV GS ANTENNA: DISTANCE FROM RWY: VGS ANGLE: TCH:

FINAL APPROACH COURSE AIMING

RUNWAY THRESHOLD  FT FROM THRESHOLD  
ON CENTERLINE  FT FROM CENTERLINE  
DISPLACED THRESHOLD DISTANCE

HELIPORT: METHODIST HOSPITAL OF IN. INC. HELIPORT ID: K8111 HELIPORT NAME: COPTER RNAV (GPS) 060 AMDT NO.: ORIG CITY: INDIANAPOLIS STATE: IN AIRPORT ELEVATION: 729 FACILITY: RNAV

**CRITICAL TEMPERATURES**

CRITICAL LOW CRITICAL HIGH ACT APT ISA

**CRITICAL TEMPERATURE REMARKS:**

**"VISUAL PORTION OF FINAL" PENETRATIONS**

FINAL TYPE  +  -

20:1 RUNWAY  +  -

34:1 RUNWAY  +  -

**PENETRATIONS REMARKS:**

**HELICOPTER "VISUAL PORTION OF FINAL" PENETRATIONS**

and/or  
5280-FT "PROCEED VFR" SEGMENT LEVEL SURFACE AREA PENETRATIONS

**PENETRATIONS REMARKS:**

**PART C: GENERAL REMARKS:**  
VEGETATION NOT CONSIDERED LANDING AREA IS ON TOP OF MULTI-STORY BUILDING, 122 FEET AGL; COPTER PINS PROCEDURE: PROCEDURE ALIGNED PER USER REQUEST; PROCEDURE IS PROCEED VFR - NO SURVEY AVAILABLE; PRECIPITIOUS TERRAIN EVALUATION COMPLETED.

HELIPORT ID: K81II HELIPORT: METHODIST HOSPITAL OF IN. INC. HELIPORT ID: K81II HELIPORT: METHODIST HOSPITAL OF IN. INC. PROCEDURE NAME: COPTER RNAV (GPS) 060 AMDT NO.: ORIG CITY: INDIANAPOLIS STATE: IN AIRPORT ELEVATION: 729 FACILITY: RNAV

PART D: AIRSPACE

DOCKET #

ALL DISTANCES TO 1/100NM; ELEVATION TO NEAREST 100 FEET; COORDINATES TO 1/100 SECOND; DEG TO 1/100 DEGREE

DISTANCE FROM	MAP		TO 1000FT POINT	1.00
WIDTH OF	FINAL		SEGMENT AT 1000FT POINT	1.00
TRUE COURSE OF	FINAL		SEGMENT CONTAINING 1000FT POINT	055.98
HIGH TERRAIN IN	FINAL		SEGMENT CONTAINING 1000FT POINT	700
DISTANCE FROM	FAF		TO 1500FT POINT	1.60
WIDTH OF	FINAL		SEGMENT AT 1500FT POINT	2.62
TRUE COURSE OF	FINAL		SEGMENT CONTAINING 1500FT POINT	055.93
HIGH TERRAIN IN	FINAL		SEGMENT CONTAINING 1500FT POINT	800

THRESHOLD COORDINATES (IF STR-IN) 394659.95N/0861026.85W

HRP COORDINATES 394721.78N/0860944.91W

RUNWAY APCH END AND DIST FURTHEST FROM MAP NA

PFAF COORDINATES 394552.77N/0861235.86W

FIX NAME COORDINATES

REMARKS POINT-IN-SPACE APPROACH

PART E: PREPARED BY

NAME OFFICE DATE TITLE

THIS PAGE IS INTENTIONALLY LEFT BLANK



### Appendix K. Final Approach Segment (FAS) Data Block Cyclic Redundancy Check (CRC) Requirements

Content of the FAS data block. Each FAS data block contains 22 elements (fields) (20 elements for GBAS) that include the CRC remainder. The specific order and coding of the fields must be followed rigorously to ensure avionics compatibility. The following FAS data block information must be documented on Form 8260-3. This documents the protected data that will be forwarded to the charting agencies for further processing and CRC protection. For helicopter point-in-space (PinS) operations, see RTCA Document DO-229D, appendix Q, for unique FAS data block requirements.

**1. Fields needed for the FAS data block record for approaches using WAAS (LPV and LP minima) are included in the CRC wrap [see appendix K table 1]:**

**Table 1.**

Data Field	Field Size	Data Type
Operation Type	2 characters	Unsigned Integer
SBAS Service Provider Identifier	2 characters	Unsigned Integer
Airport Identifier	4 characters	Alphanumeric
Runway	2 characters	Numeric
Runway Letter	2 characters	Numeric
Approach Performance Designator	1 character	Unsigned Integer
Route Indicator	1 character	Alpha
Reference Path Data Selector	2 characters	Unsigned Integer
Reference Path Identifier (Approach ID)	4 characters	Alphanumeric
LTP or FTP Latitude	11 characters	Alphanumeric
LTP or FTP Longitude	12 characters	Alphanumeric
LTP or FTP Ellipsoidal Height	6 characters	Signed Integer
FPAP Latitude	11 characters	Alphanumeric
FPAP Longitude	12 characters	Alphanumeric
Threshold Crossing Height	7 characters	Alphanumeric
TCH Units Selector (meters or feet used)	1 character	Feet or Meters
Glidepath Angle (GPA)	4 characters	Unsigned Integer
Course Width at Threshold	5 characters	Unsigned Integer
Length Offset	4 characters	Unsigned Integer
Horizontal Alert Limit (HAL) (LPV & LP Procedures)	3 characters	Numeric
Vertical Alert Limit (VAL) (LPV Procedures)	3 characters	Numeric

**2. Fields needed for integrity monitoring and calculated using binary representation of FAS data block (as described in RTCA/DO-229C) [see appendix K table 2].**

**Table 2.**

<b>Data Field</b>	<b>Field Size</b>	<b>Data Type</b>
Precision Approach Path Point Data CRC Remainder	8 characters	Hexadecimal

**3. Fields not included in the FAS data block, but needed for the precision approach path point record, and which are not CRC wrapped [see appendix K table 3].**

**Table 3.**

<b>Data Field</b>	<b>Field Size</b>	<b>Data Type</b>
ICAO Code	2 characters	Alphanumeric
LTP Orthometric Height	6 characters	Signed Integer
FPAP Orthometric Height	6 characters	Signed Integer
Horizontal Alert Limit (HAL) (GBAS procedures only)	3 characters	Numeric
Vertical Alert Limit (VAL) (GBAS procedures only)	3 characters	Numeric

**4. Explanation of data field entries (in the general order they appear in the FAS data block):**

**a.** Operation type. A number from 0 to 15 that indicates the type of the final approach segment.

**Example:**

0 is coded for a straight-in and offset approach procedure.

**b.** SBAS service provider identifier. A number from 0 to 15 that associates the approach procedure to a particular satellite based approach system service provider.

0 = SBAS (WAAS)

14 = GBAS

**c.** Airport identifier. The four-character ICAO location identifier assigned to an airport. Where there is a national airport identifier but no ICAO location identifier, the three- or four-character national identifier is used. Where only three characters are provided, the trailing space is to be left blank.

**Example:**

KDEN, YSSY, NZWN, FAEL, 3SL\_, OH23

**d.** Runway. Runways are identified by two characters “RW” followed by the runway number. The runway number field valid range is 01 to 36.

**Examples:**

RW26, RW08, RW18, RW02

**Note:** For WAAS procedures to heliports, the runway number field may be encoded as the procedure final approach course, rounded to the closest 10 degrees, and truncated to two characters. For final approach courses from 355 degrees to 004 degrees, the truncated closest 10 degree value is “36.”

**e.** Runway letter. A runway letter [left (L), right (R), or center (C)] is used to differentiate between parallel runways. The valid range is 00 through 11. The convention for coding is as follows:

00 = no letter      10 = C (center)

01 = R (right)      11 = L (left)

**f.** Approach performance designator. A number from 0 to 7 that identifies the type of approach. An “0” is used to identify an LPV approach procedure and a “1” indicates a CAT I approach procedure. Other values are reserved for future use.

0 = LPV and LP

1 = GLS

**g.** Route indicator. A single alpha character (Z through A or blank, omitting I and O) used to differentiate between multiple procedures to the same runway end or heliport. Normally, the first approach to a runway is labeled “Z,” except when there is only a single procedure to the runway end. In this case, the field is coded as a blank. Additional alpha characters are incrementally assigned.

**Example:**

Z, Y, X, etc.

**h.** Reference path data selector (RPDS). A numerical identifier intended for GBAS and is not intended for SBAS (WAAS) operations. A number (0-48) that enables automatic tuning of a procedure by GBAS avionics. This number is obtained from spectrum engineering. The number is related to the frequency of the VHF data broadcast and a 5-digit tuning identifier. Enter “0” for WAAS operations.

**Example: 0**

**i.** Reference path identifier (RPI). A three or four alphanumeric character identifier that is used to uniquely designate the reference path. The reference path identifier is synonymous with the “approach ID” located beneath the channel number on instrument approach plates. For WAAS procedures, this identifier is defined with a “W” signifying WAAS followed by the runway number, and a trailing alpha character. For point-in-space procedures, the final approach course rounded to the closest 10 degrees and truncated to the leading two digits with a range of 01 to 36 replaces the runway number. The last character, beginning with the letter “A,” excluding the letters “C,” “L,” and “R,” will be used to define the first procedure, followed by a

succeeding letter for each procedure to a particular runway. For example, an airport has three parallel runways and the left and right runways have both a straight-in procedure and an offset procedure; the center runway has a straight-in procedure only. The following (extreme) examples would be applicable:

**Example:**

W09A & W09B would define the two unique FAS data blocks to Rwy 09L.

W09D would be used to define the FAS data block for RWY 09C.

W09E & W09F would be used to define the FAS data blocks for Rwy 09R.

**Note:** These suffixes do not have to be in any particular order so as to allow procedures to be added at a later time without changing existing FAS data blocks.

For GBAS procedures, the RPI and RPDS must be unique within the reception range of the assigned frequency (e.g., ~160 NM) of a given ground station. Spectrum engineering will determine, assign, and track RPIs and RPDSs for all requested procedures based on the assigned station frequency, transmitter separations standards, and NFDC policies for determining unique identifiers.

**j.** Landing threshold point (LTP) or fictitious threshold point (FTP) - latitude. Represents the latitude of the threshold defined in WGS-84/NAD83 coordinates and entered to five ten-thousandths of an arc second (The last digit must be rounded to either a 0 or 5). Use the FTP latitude for offset procedures. The most significant bit is the sign bit: 0 = positive (northern hemisphere); 1 = negative (southern hemisphere). However, for documentation purposes identify the latitude as follows:

**Example:**

225436.2125N (11 characters) for 22°54'36.2125" N

**k.** LTP or FTP - longitude. Represents the longitude of the threshold defined in WGS-84/NAD83 coordinates and entered to five ten-thousandths of an arc second (the last digit must rounded to either 0 or 5). Use the FTP longitude for offset procedures. The most significant bit is the sign bit: 0 = positive (eastern hemisphere); 1 = negative (western hemisphere). However, for documentation purposes identify the latitude as follows:

**Example:**

1093247.8780E (12 characters) for 109°32'47.8780" E

**l.** LTP or FTP height above ellipsoid (HAE). The height expressed in meters reference the WGS-84/NAD83 ellipsoid. The first character is a + or – and the resolution value is in tenths of a meter with the decimal point suppressed. Use the LTP HAE for offset procedures.

**Example:**

+00356 (+35.6m), -00051(-5.1m), +01566 (+156.6m), -00022 (-2.2m)

**m.** Flight path alignment point (FPAP) – latitude. A point located on a geodesic line or an extension of a geodesic line calculated between the LTP and the designated center of the

opposite runway-landing threshold. It is positioned at a distance from the LTP to support a prescribed procedure design angular splay and course width, as well as functionality associated with an aircraft. It is used in conjunction with the LTP to determine the lateral alignment of the vertical plane containing the path of the RNAV final approach segment. On shorter runways, the FPAP may be located off the departure end of the landing runway. The latitude of the runway FPAP is defined in WGS-84/NAD83 coordinates and entered to five ten-thousandths of an arc second (the last digit must be rounded to either a 0 or 5). The most significant bit is the sign bit: 0 = positive (northern hemisphere); 1 = negative (southern hemisphere). However, for documentation purposes identify the latitude as follows:

**Example:**

225436.2125N (11 characters) for 22°54'36.2125" N

**n.** FPAP - longitude. The longitude of the runway FPAP is defined in WGS-84/NAD83 coordinates and entered to five ten-thousandths of an arc second (The last digit must be rounded to either a 0 or 5). The most significant bit is the sign bit 0 = positive (eastern hemisphere); 1 = negative (western hemisphere). However, for documentation purposes identify the latitude as follows:

**Example:**

1093247.8780E (12 characters) for 109°32'47.8780" E

**o.** Threshold crossing height (TCH). The designated crossing height of the flight path angle above the LTP (or FTP).

**Example:**

00055.0 (55.0 feet); 00042.0 (42.0 feet); 00000.00 (Used only when a TCH is not to be specified; [see paragraph 8-6-10.p.])

**p.** TCH units selector. This character defines the units used to describe the TCH.

**Example:**

F = feet

M = meters

**q.** Glidepath angle. The angle of the approach path (glidepath) with respect to the horizontal plane defined according to WGS-84/NAD83 at the LTP/FTP. It is specified in degrees.

(1) FAA policy is to publish a vertical descent angle (VDA) that may be used as advisory vertical guidance on all nonprecision approaches. Therefore, a VDA to provide advisory vertical guidance on an LP procedure is accomplished by coding a glidepath angle.

(2) The AIM, AC 20-138, and other FAA publications make it clear that the VDA is for information only, is strictly advisory in nature, and there is no implicit additional obstacle protection below the MDA.

- (3) For LP approaches, see paragraph 4x (Vertical alert limit) Note 1.
- (4) The following limitations must be met to code a GPA for LP procedures:
  - (a) Final approach segment must be “straight-in”

- (b) A GPA of zero (“00.00”) is entered into this block when a VDA is not to be specified [see paragraph 8-6-10.p].

**Example:**

02.75 (2.75°), 04.20 (4.20°), 03.00 (3.00°), 00.00 (Used when a VDA is not to be specified.)

**r.** Course width at threshold. The lateral displacement from the path defined by the FAS at the LTP/FTP at which full-scale deflection of a course deviation indicator is attained. Use the applicable “WIDTHmeters” value from the "FAS data" formula specified in Order 8260.58, chapter 3.

**Example:**

106.75

**s.**  $\Delta$  Length offset. The distance from the stop end of the runway to the FPAP. It defines the location where lateral sensitivity changes to the missed approach sensitivity. The value is in meters with the limits being 0 to 2032 m. This distance is rounded to the nearest eight-meter value. If the FPAP is located at the designated center of the opposite runway end, the distance is zero. For offset procedures, the length of offset is coded as zero.

**Example:**

0000, 0424

**t.** Precision approach path point CRC remainder. An eight-character hexadecimal representation of the calculated remainder bits used to determine the integrity of the FAS data block data during transmission and storage. This information will be computed electronically with use of the electronic transmittal software and documented on Form 8260-3.

**Example:**

CRC Remainder: E104FC14

**u.** ICAO code. The first two designators of the ICAO location identifier, as identified in ICAO Doc 7910. In the Continental U.S., the country code will begin with the letter “K” followed by a numeric character obtained from appendix L figure 2. Alaska, Hawaii, and U.S. Possessions will be as described in the ICAO Doc 7910.

**Example:**

K1, K7, PH, PA, MM, ER

**v.** Orthometric height. The height of the LTP or FPAP, as related to the geoid, and presented as an MSL elevation defined to a tenth of a meter resolution with the decimal point suppressed. For the purpose of documenting this in the “Additional Path Point Record Information,” the LTP and FPAP

orthometric height will be the same and based on the LTP elevation. The value is preceded by a “+” or “-.”

**Example:**

+00362 (+36.2m), +02478 (+247.8m), -00214 (-21.4m)

w. Horizontal alert limit (HAL). The HAL is the radius of a circle in the horizontal plane (the local plane tangent to the WGS-84/NAD83 ellipsoid), with its center being at the true position, that describes the region which is required to contain the indicated horizontal position with the required probability for a particular navigation mode assuming the probability of a GPS satellite integrity failure being included in the position solution is less than or equal to  $10^{-4}$  per hour. The range of values is 0 to 50.8m with a 0.2 resolution. The HAL for LPV procedures is a fixed value at 40.0 meters.

**Note:** A HAL is not part of the FAS data block/CRC wrap for GBAS procedures.

**Example:**

HAL 40.0

x. Vertical alert limit (VAL). The VAL is half the length of a segment on the vertical axis (perpendicular to the horizontal plane of the WGS-84/NAD83 ellipsoid), with its center being at the true position, that describes the region which is required to contain the indicated vertical position with a probability of  $1-10^{-7}$  per approach, assuming the probability of a GPS satellite integrity failure being included in the position solution is less than or equal to  $10^{-4}$  per hour. The range of values is 0 to 50.8m with a 0.2 resolution. The VAL for LPV procedures is a fixed value at 50.0 m where the HAT is 250 feet or greater. If an LPV procedure has been established to support a HAT less than 250 feet (no less than 200 feet), a VAL of 35m will be used. For an LP procedure, the VAL must always be entered as zero (00.0).

**Note 1:** A VAL of 00.0 indicates that the vertical deviations must not be used (i.e., a lateral-only {LP} approach).

**Note 2:** A VAL is not part of the FAS data block/CRC wrap for GBAS procedures.

**Example:**

VAL 50.0 VAL 35.0

Figure 1.

AIRPORT	AIRPORT ID	PROCEDURE NAME	ORIGINAL/AMENDMENT	CITY	STATE
FORT MORGAN MUNI	KFMM	RNAV (GPS) RWY 14	1	FORT MORGAN MUNI	CO
<b>FAS DATA BLOCK INFORMATION</b>					
<b>DATA FIELD</b>	<b>DATA</b>				
OPERATION TYPE	0				
SBAS SERVICE PROVIDER IDENTIFIER	0				
AIRPORT IDENTIFIER	KFMM				
RUNWAY	RW14				
APPROACH PERFORMANCE DESIGNATOR	0				
ROUTE INDICATOR	0				
REFERENCE PATH DATA SELECTOR	W14A				
REFERENCE PATH IDENTIFIER (APPROACH ID)	402041.4650N				
LTP/FTP LATITUDE	1034842.0900W				
LTP/FTP LONGITUDE	00030.0				
LTP/FTP ELLIPSOIDAL HEIGHT	401923.0220N				
FPAP LATITUDE	1034746.7010W				
FPAP LONGITUDE	00030.0				
THRESHOLD CROSSING HEIGHT (TCH)	F				
TCH UNITS SELECTOR (METERS OR FEET USED)	03.00				
GLIDE PATH ANGLE (GPA)	106.75				
COURSE WIDTH AT THRESHOLD	1000				
LENGTH OFFSET	40				
HORIZONTAL ALERT LIMIT (HAL)	50				
VERTICAL ALERT LIMIT (VAL)	8F1D0606				
CRC REMAINDER	8F1D0606				
<b>ADDITIONAL PATH POINT RECORD INFORMATION</b>					
ICAO CODE	K2				
LTP ORTHOMETRIC HEIGHT	+14006				
FPAP ORTHOMETRIC HEIGHT	+14006				



Figure 2.



THIS PAGE IS INTENTIONALLY LEFT BLANK

07/20/2017

Order 8260.19H  
Appendix L

**Appendix L. Final Approach Segment (FAS)  
Data Block Cyclic Redundancy Check (CRC)  
Requirements for Helicopter Operations – RESERVED**

THIS PAGE IS INTENTIONALLY LEFT BLANK

### Appendix M. Instrument Flight Procedures (IFP) Lifecycle

1. This appendix consists of “basic” information pertaining to the “lifecycle” of an FAA developed IFP [see appendix M figure 1 through figure 7]. Non-FAA IFP developers “lifecycle” processes will, for the most part, match the FAA process, however, they may have additional steps unique to individual company policies. This appendix does not apply to Special IFPs; see Order 8260.60 for information on the processing of those IFPs.

2. Obtaining/meeting operations and/or aircraft approval requirements necessary for using an IFP are the responsibility of the user and not part of an IFP lifecycle. However, if it has been determined that an IFP is no longer needed due to the user(s) inability to meet operational and/or aircraft approval requirements, the IFP would be subject to the processes described in appendix O figure 6, for the “Maintain” phase of the IFP.

Figure 1. Overview

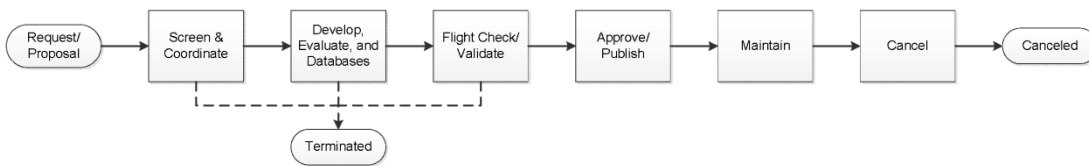
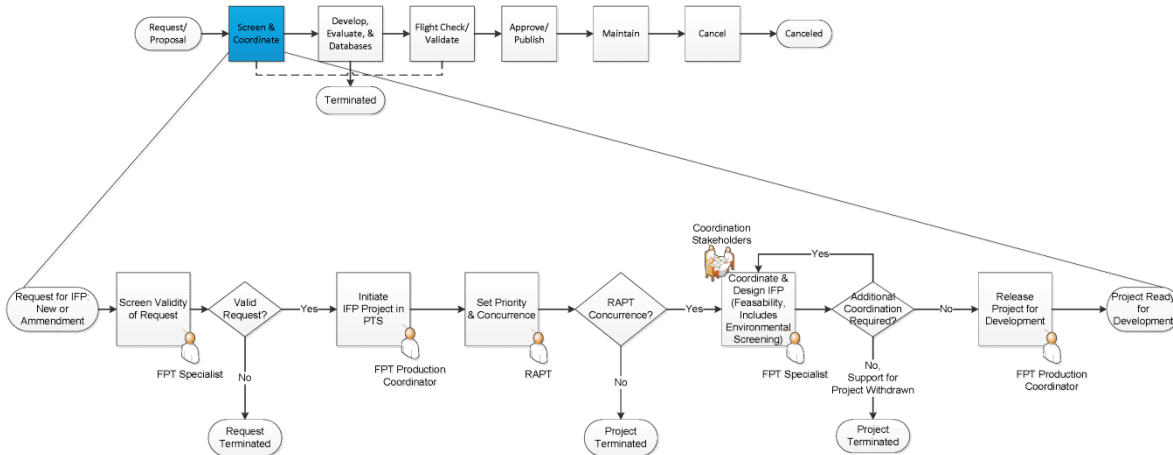
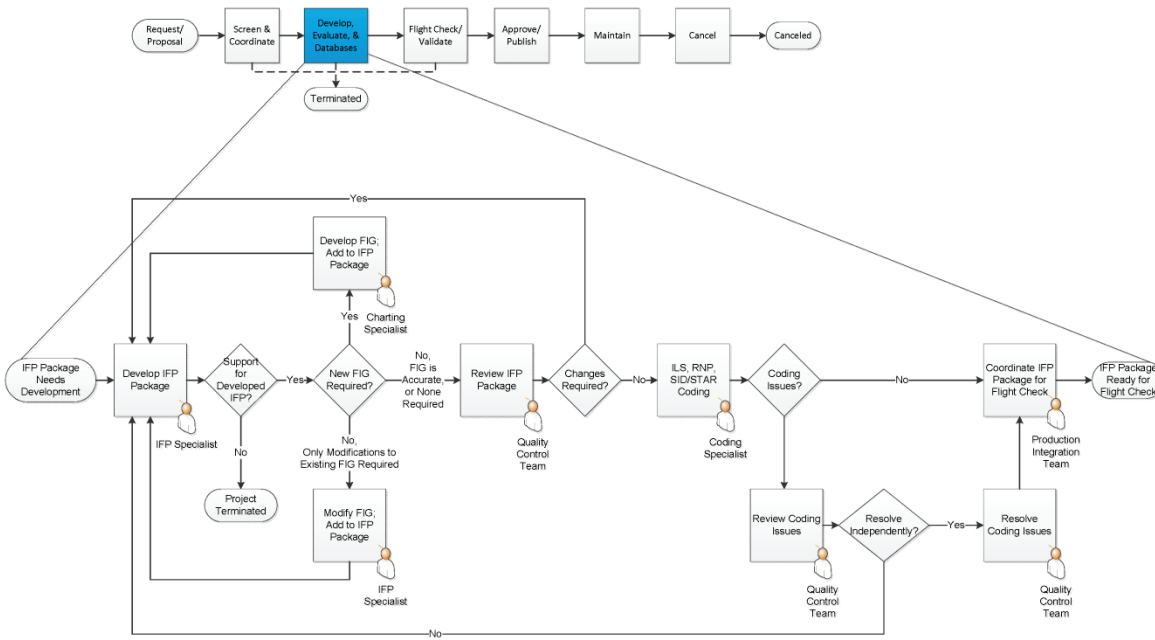

Figure 2. Process for the “Screen & Coordinate” Phase



**Figure 3. Process for the “Develop, Evaluate, & Databases” Phase**



**Figure 4. Process for the “Flight Check/Validate” Phase**

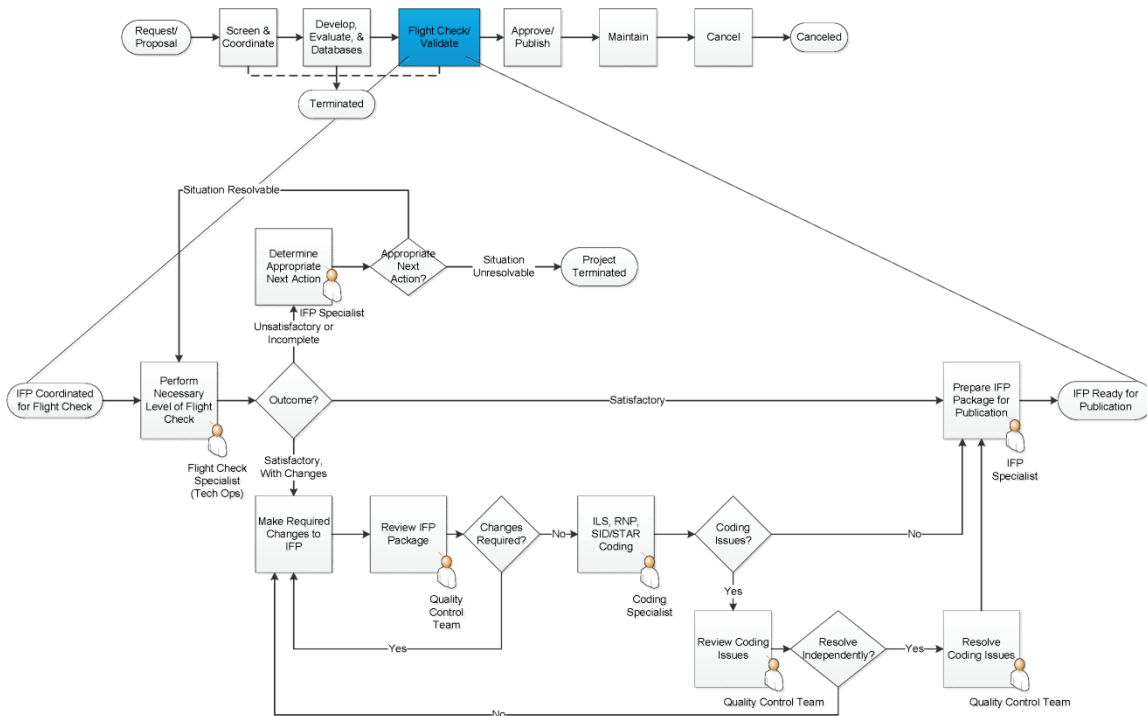
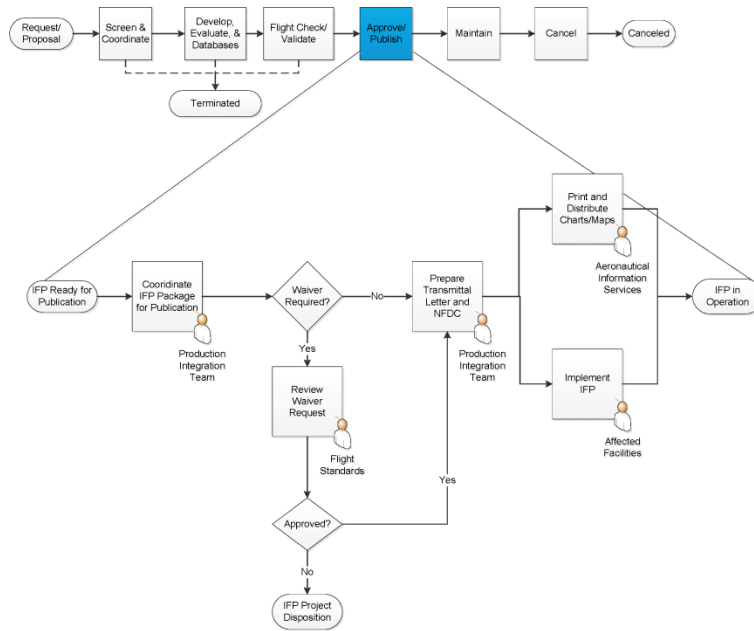
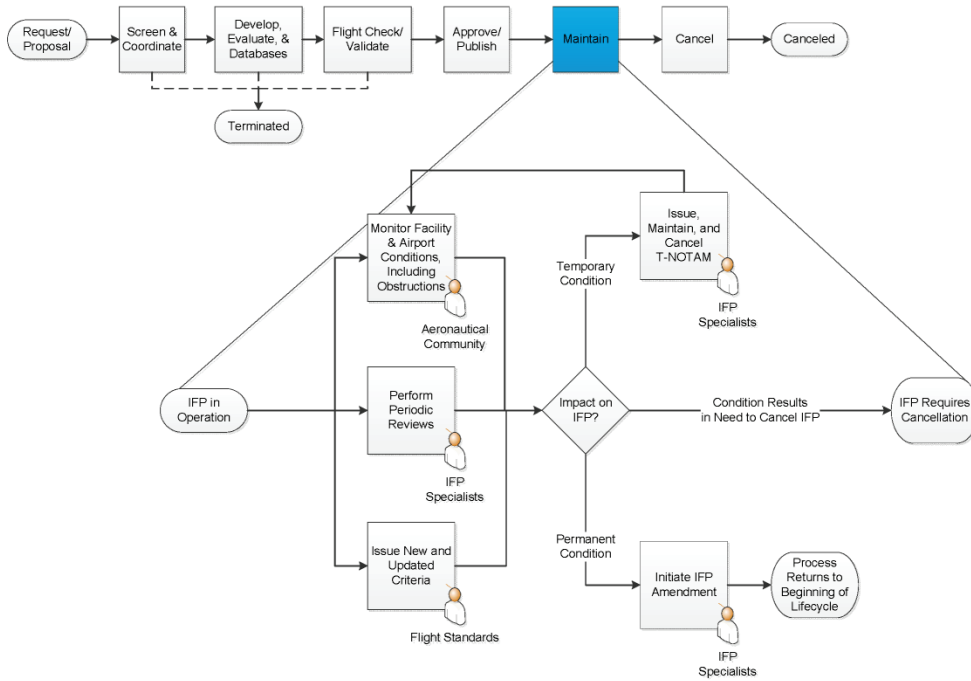

Figure 5. Process for the “Approve and Publish” Phase

Instrument Flight Procedures Lifecycle  
Process Milestones for Approve and Publish Phase



**Figure 6. Process for the “Maintain” Phase**



**Figure 7. Process for the “Cancel” Phase**

