

**AIP**  
**AERONAUTICAL INFORMATION PUBLICATION**  
**UNITED STATES OF AMERICA**

**TWENTY – SEVENTH EDITION**

**19 MAY 2022**

**CONSULT NOTAM FOR LATEST INFORMATION**

**DEPARTMENT OF TRANSPORTATION**  
**FEDERAL AVIATION ADMINISTRATION**



**AIP**  
**AERONAUTICAL INFORMATION PUBLICATION**  
**UNITED STATES OF AMERICA**

**TWENTY-SEVENTH EDITION**

**DATED 19 MAY 2022**

**AMENDMENT 1**

**3 NOV 2022**

**CONSULT NOTAM FOR LATEST INFORMATION**

**DEPARTMENT OF TRANSPORTATION**  
**FEDERAL AVIATION ADMINISTRATION**



**AIP Amendment 1**  
**Page Control Chart**  
**3 NOVEMBER 2022**

<b>REMOVE PAGES</b>	<b>DATED</b>	<b>INSERT PAGES</b>	<b>DATED</b>
GEN 0.4-1 through GEN 0.4-3 . . . . .	19 MAY 22	GEN 0.4-1 through GEN 0.4-3 . . . . .	3 NOV 22
GEN 1.7-17 . . . . .	19 MAY 22	GEN 1.7-17 . . . . .	19 MAY 22
GEN 1.7-18 through GEN 1.7-95 . . . . .	19 MAY 22	GEN 1.7-18 through GEN 1.7-97 . . . . .	3 NOV 22
GEN 3.3-17 . . . . .	19 MAY 22	GEN 3.3-17 . . . . .	3 NOV 22
GEN 3.3-18 . . . . .	19 MAY 22	GEN 3.3-18 . . . . .	19 MAY 22
GEN 3.3-21 and GEN 3.3-22 . . . . .	19 MAY 22	GEN 3.3-21 and GEN 3.3-22 . . . . .	3 NOV 22
GEN 3.5-9 . . . . .	19 MAY 22	GEN 3.5-9 . . . . .	19 MAY 22
GEN 3.5-10 . . . . .	19 MAY 22	GEN 3.5-10 . . . . .	3 NOV 22
GEN 3.5-33 . . . . .	19 MAY 22	GEN 3.5-33 . . . . .	19 MAY 22
GEN 3.5-34 . . . . .	19 MAY 22	GEN 3.5-34 . . . . .	3 NOV 22
ENR 0.4-1 through ENR 0.4-4 . . . . .	19 MAY 22	ENR 0.4-1 through ENR 0.4-4 . . . . .	3 NOV 22
ENR 1.1-39 . . . . .	19 MAY 22	ENR 1.1-39 . . . . .	19 MAY 22
ENR 1.1-40 through ENR 1.1-99 . . . . .	19 MAY 22	ENR 1.1-40 through ENR 1.1-100 . . . . .	3 NOV 22
ENR 1.4-7 through ENR 1.4-10 . . . . .	19 MAY 22	ENR 1.4-7 through ENR 1.4-10 . . . . .	3 NOV 22
ENR 1.5-19 . . . . .	19 MAY 22	ENR 1.5-19 . . . . .	3 NOV 22
ENR 1.5-20 . . . . .	19 MAY 22	ENR 1.5-20 . . . . .	19 MAY 22
ENR 1.5-29 . . . . .	19 MAY 22	ENR 1.5-29 . . . . .	19 MAY 22
ENR 1.5-30 . . . . .	19 MAY 22	ENR 1.5-30 . . . . .	3 NOV 22
ENR 1.5-35 . . . . .	19 MAY 22	ENR 1.5-35 . . . . .	19 MAY 22
ENR 1.5-36 and ENR 1.1-37 . . . . .	19 MAY 22	ENR 1.5-36 and ENR 1.1-37 . . . . .	3 NOV 22
ENR 1.5-38 . . . . .	19 MAY 22	ENR 1.5-38 . . . . .	19 MAY 22
ENR 1.5-49 . . . . .	19 MAY 22	ENR 1.5-49 . . . . .	19 MAY 22
ENR 1.5-50 . . . . .	19 MAY 22	ENR 1.5-50 . . . . .	3 NOV 22
ENR 1.5-71 . . . . .	19 MAY 22	ENR 1.5-71 . . . . .	19 MAY 22
ENR 1.5-72 through ENR 1.5-74 . . . . .	19 MAY 22	ENR 1.5-72 through ENR 1.5-74 . . . . .	3 NOV 22
ENR 1.8-7 . . . . .	19 MAY 22	ENR 1.8-7 . . . . .	19 MAY 22
ENR 1.8-8 . . . . .	19 MAY 22	ENR 1.8-8 . . . . .	3 NOV 22
ENR 4.1-11 through ENR 4.1-39 . . . . .	19 MAY 22	ENR 4.1-11 through ENR 4.1-40 . . . . .	3 NOV 22
ENR 5.2-1 . . . . .	19 MAY 22	ENR 5.2-1 . . . . .	19 MAY 22
ENR 5.2-2 . . . . .	19 MAY 22	ENR 5.2-2 and ENR 5.2-3 . . . . .	3 NOV 22
ENR 5.7-5 and ENR 5.7-6 . . . . .	19 MAY 22	ENR 5.7-5 and ENR 5.7-6 . . . . .	3 NOV 22
ENR 7.1-3 . . . . .	19 MAY 22	ENR 7.1-3 . . . . .	19 MAY 22
ENR 7.1-4 . . . . .	19 MAY 22	ENR 7.1-4 . . . . .	3 NOV 22
ENR 7.1-7 . . . . .	19 MAY 22	ENR 7.1-7 . . . . .	3 NOV 22
ENR 7.1-8 . . . . .	19 MAY 22	ENR 7.1-8 . . . . .	19 MAY 22
ENR 7.4-1 and ENR 7.4-2 . . . . .	19 MAY 22	ENR 7.4-1 and ENR 7.4-2 . . . . .	3 NOV 22
ENR 7.4-5 . . . . .	19 MAY 22	ENR 7.4-5 . . . . .	3 NOV 22
ENR 7.8-1 and ENR 7.8-2 . . . . .	19 MAY 22	ENR 7.8-1 and ENR 7.8-2 . . . . .	3 NOV 22

AD 0.4-1 through AD 0.4-6 .....	19 MAY 22	AD 0.4-1 through AD 0.4-5 .....	3 NOV 22
AD 2-1 through AD 2-656 .....	19 MAY 22	AD 2-1 through AD 2-603 .....	3 NOV 22
I-1 through I-8 .....	19 MAY 22	I-1 through I-8 .....	3 NOV 22
Appendix 2-5 .....	19 MAY 22	Appendix 2-5 .....	19 MAY 22
Appendix 2-6 .....	19 MAY 22	Appendix 2-6 .....	3 NOV 22
Appendix 2-11 through Appendix 2-14 ..	19 MAY 22	Appendix 2-11 through Appendix 2-14 ..	3 NOV 22

**AIP**  
**AERONAUTICAL INFORMATION PUBLICATION**  
**UNITED STATES OF AMERICA**

**TWENTY-SEVENTH EDITION**

**DATED 19 MAY 2022**

**AMENDMENT 2**

**20 APR 2023**

**CONSULT NOTAM FOR LATEST INFORMATION**

**DEPARTMENT OF TRANSPORTATION**  
**FEDERAL AVIATION ADMINISTRATION**





**AIP Amendment 2**  
**Page Control Chart**  
**20 APRIL 2023**

<b>REMOVE PAGES</b>	<b>DATED</b>	<b>INSERT PAGES</b>	<b>DATED</b>
GEN 0.4-1 through GEN 0.4-3 . . . . .	3 NOV 22	GEN 0.4-1 through GEN 0.4-3 . . . . .	20 APR 23
GEN 1.7-53 . . . . .	3 NOV 22	GEN 1.7-53 . . . . .	3 NOV 22
GEN 1.7-54 through GEN 1.7-56 . . . . .	3 NOV 22	GEN 1.7-54 through GEN 1.7-56	20 APR 23
GEN 1.7-95 . . . . .	3 NOV 22	GEN 1.7-95 . . . . .	3 NOV 22
GEN 1.7-96 . . . . .	3 NOV 22	GEN 1.7-96 . . . . .	20 APR 23
GEN 2.2-1 through GEN 2.2-5 . . . . .	19 MAY 22	GEN 2.2-1 through GEN 2.2-5 . . . . .	20 APR 23
GEN 3.5-3 . . . . .	19 MAY 22	GEN 3.5-3 . . . . .	19 MAY 22
GEN 3.5-4 . . . . .	19 MAY 22	GEN 3.5-4 . . . . .	20 APR 23
GEN 3.5-9 . . . . .	19 MAY 22	GEN 3.5-9 . . . . .	19 MAY 22
GEN 3.5-10 . . . . .	3 NOV 22	GEN 3.5-10 . . . . .	20 APR 23
GEN 3.5-11 through GEN 3.5-33 . . . . .	19 MAY 22	GEN 3.5-11 through GEN 3.5-33 . . . . .	20 APR 23
GEN 3.5-34 . . . . .	3 NOV 22	GEN 3.5-34 . . . . .	20 APR 23
GEN 3.5-35 through GEN 3.5-61 . . . . .	19 MAY 22	GEN 3.5-35 through GEN 3.5-61 . . . . .	20 APR 23
GEN 3.5-62 . . . . .	19 MAY 22	GEN 3.5-62 . . . . .	19 MAY 22
GEN 3.5-63 through GEN 3.5-67 . . . . .	19 MAY 22	GEN 3.5-63 through GEN 3.5-67 . . . . .	20 APR 23
GEN 3.5-68 . . . . .	19 MAY 22	GEN 3.5-68 . . . . .	19 MAY 22
GEN 3.5-77 and GEN 3.5-78 . . . . .	19 MAY 22	GEN 3.5-77 and GEN 3.5-78 . . . . .	20 APR 23
GEN 3.5-85 through GEN 3.5-87 . . . . .	19 MAY 22	GEN 3.5-85 through GEN 3.5-87 . . . . .	20 APR 23
GEN 3.5-88 . . . . .	19 MAY 22	GEN 3.5-88 . . . . .	19 MAY 22
GEN 3.5-89 through GEN 3.5-94 . . . . .	19 MAY 22	GEN 3.5-89 through GEN 3.5-94 . . . . .	20 APR 23
ENR 0.4-1 through ENR 0.4-4 . . . . .	3 NOV 22	ENR 0.4-1 through ENR 0.4-4 . . . . .	20 APR 23
ENR 0.6-1 and ENR 0.6-2 . . . . .	19 MAY 22	ENR 0.6-1 and ENR 0.6-2 . . . . .	20 APR 23
ENR 1.1-9 through ENR 1.1-39 . . . . .	19 MAY 22	ENR 1.1-9 through ENR 1.1-39 . . . . .	20 APR 23
ENR 1.1-40 through ENR 1.1-100 . . . . .	3 NOV 22	ENR 1.1-40 through ENR 1.1-101 . . . . .	20 APR 23
ENR 1.4-3 . . . . .	19 MAY 22	ENR 1.4-3 . . . . .	19 MAY 22
ENR 1.4-4 through ENR 1.4-6 . . . . .	19 MAY 22	ENR 1.4-4 through ENR 1.4-6 . . . . .	20 APR 23
ENR 1.4-7 through ENR 1.4-10 . . . . .	3 NOV 22	ENR 1.4-7 through ENR 1.4-10 . . . . .	20 APR 23
ENR 1.4-11 . . . . .	19 MAY 22	ENR 1.4-11 . . . . .	20 APR 23
ENR 1.4-12 . . . . .	19 MAY 22	ENR 1.4-12 . . . . .	19 MAY 22
ENR 1.4-15 through ENR 1.4-17 . . . . .	19 MAY 22	ENR 1.4-15 through ENR 1.4-17 . . . . .	20 APR 23
ENR 1.4-18 . . . . .	19 MAY 22	ENR 1.4-18 . . . . .	19 MAY 22
ENR 1.4-19 . . . . .	19 MAY 22	ENR 1.4-19 . . . . .	20 APR 23
ENR 1.12-1 . . . . .	19 MAY 22	ENR 1.12-1 . . . . .	19 MAY 22
ENR 1.12-2 through ENR 1.12-14 . . . . .	19 MAY 22	ENR 1.12-2 through ENR 1.12-14 . . . . .	20 APR 23
ENR 1.17-7 . . . . .	19 MAY 22	ENR 1.17-7 . . . . .	19 MAY 22
ENR 1.17-8 . . . . .	19 MAY 22	ENR 1.17-8 . . . . .	20 APR 23
ENR 3.3-1 . . . . .	19 MAY 22	ENR 3.3-1 . . . . .	20 APR 23
ENR 3.5-1 through ENR 3.5-4 . . . . .	19 MAY 22	ENR 3.5-1 through ENR 3.5-4 . . . . .	20 APR 23

ENR 4.1-35 through ENR 4.1-40 . . . . .	3 NOV 22	ENR 4.1-35 through ENR 4.1-40 . . . . .	20 APR 23
ENR 5.7-15 . . . . .	19 MAY 22	ENR 5.7-15 . . . . .	19 MAY 22
ENR 5.7-16 and ENR 5.7-17 . . . . .	19 MAY 22	ENR 5.7-16 and ENR 5.7-17 . . . . .	20 APR 23
ENR 7.1-1 . . . . .	19 MAY 22	ENR 7.1-1 . . . . .	19 MAY 22
ENR 7.1-2 . . . . .	19 MAY 22	ENR 7.1-2 . . . . .	20 APR 23
ENR 7.5-1 through ENR 7.5-3 . . . . .	19 MAY 22	ENR 7.5-1 through ENR 7.5-3 . . . . .	20 APR 23
ENR 7.11-1 . . . . .	19 MAY 22	ENR 7.11-1 . . . . .	19 MAY 22
ENR 7.11-2 . . . . .	19 MAY 22	ENR 7.11-2 . . . . .	20 APR 23
ENR 7.14-1 . . . . .	19 MAY 22	ENR 7.14-1 . . . . .	20 APR 23
. . . . .	N/A	ENR 8.1-1 and ENR 8.1-2 . . . . .	20 APR 23
. . . . .	N/A	ENR 8.2-1 through ENR 8.2-3 . . . . .	20 APR 23
. . . . .	N/A	ENR 8.3-1 through ENR 8.3-6 . . . . .	20 APR 23
. . . . .	N/A	ENR 8.4-1 through ENR 8.4-9 . . . . .	20 APR 23
. . . . .	N/A	ENR 8.5-1 through ENR 8.5-3 . . . . .	20 APR 23
. . . . .	N/A	ENR 8.6-1 . . . . .	20 APR 23
. . . . .	N/A	ENR 8.7-1 . . . . .	20 APR 23
. . . . .	N/A	ENR 8.8-1 through ENR 8.8-4 . . . . .	20 APR 23
AD 0.4-1 through AD 0.4-5 . . . . .	3 NOV 22	AD 0.4-1 through AD 0.4-5 . . . . .	20 APR 23
AD 1.1-1 through AD 1.1-52 . . . . .	19 MAY 22	AD 1.1-1 through AD 1.1-53 . . . . .	20 APR 23
AD 2-1 through AD 2-603 . . . . .	3 NOV 22	AD 2-1 through AD 2-597 . . . . .	20 APR 23
I-1 through I-8 . . . . .	3 NOV 22	I-1 through I-9 . . . . .	20 APR 23
Appendix 1-1 [and Supplemental Pages 1-426] . . . . .	19 MAY 22	Appendix 1-1 [and Supplemental Pages 1-438] . . . . .	20 APR 23
Appendix 2-15 . . . . .	19 MAY 22	Appendix 2-15 . . . . .	19 MAY 22
Appendix 2-16 . . . . .	19 MAY 22	Appendix 2-16 . . . . .	20 APR 23
Appendix 2-21 . . . . .	19 MAY 22	Appendix 2-21 . . . . .	19 MAY 22
Appendix 2-22 and Appendix 2-23 . . . . .	19 MAY 22	Appendix 2-22 and Appendix 2-23 . . . . .	20 APR 23

**AIP**  
**AERONAUTICAL INFORMATION PUBLICATION**  
**UNITED STATES OF AMERICA**

**TWENTY-SEVENTH EDITION**

**DATED 19 MAY 2022**

**AMENDMENT 3**

**5 OCT 2023**

**CONSULT NOTAM FOR LATEST INFORMATION**

**DEPARTMENT OF TRANSPORTATION**  
**FEDERAL AVIATION ADMINISTRATION**



**AIP Amendment 3**  
**Page Control Chart**  
**5 OCTOBER 2023**

<b>REMOVE PAGES</b>	<b>DATED</b>	<b>INSERT PAGES</b>	<b>DATED</b>
GEN 0.1–3	19 MAY 22	GEN 0.1–3	5 OCT 23
GEN 0.4–1 through GEN 0.4–3	20 APR 23	GEN 0.4–1 through GEN 0.4–3	5 OCT 23
GEN 1.6–1 and GEN 1.6–2	19 MAY 22	GEN 1.6–1	5 OCT 23
GEN 1.7–5	19 MAY 22	GEN 1.7–5	19 MAY 22
GEN 1.7–6 through GEN 1.7–17	19 MAY 22	GEN 1.7–6 through GEN 1.7–17	5 OCT 23
GEN 1.7–18 through GEN 1.7–53	3 NOV 22	GEN 1.7–18 through GEN 1.7–53	5 OCT 23
GEN 1.7–54 through GEN 1.7–56	20 APR 23	GEN 1.7–54 through GEN 1.7–56	5 OCT 23
GEN 1.7–57 through GEN 1.7–95	3 NOV 22	GEN 1.7–57 through GEN 1.7–95	5 OCT 23
GEN 1.7–96	20 APR 23	GEN 1.7–96	5 OCT 23
GEN 1.7–97	3 NOV 22		N/A
GEN 2.4–1	19 MAY 22	GEN 2.4–1	5 OCT 23
GEN 3.1–1	19 MAY 22	GEN 3.1–1	19 MAY 22
GEN 3.1–2 through GEN 3.1–5	19 MAY 22	GEN 3.1–2 through GEN 3.1–5	5 OCT 23
GEN 3.3–25	19 MAY 22	GEN 3.3–25	19 MAY 22
GEN 3.3–26 through GEN 3.3–28	19 MAY 22	GEN 3.3–26 and GEN 3.3–27	5 OCT 23
GEN 3.4–1 and GEN 3.4–2	19 MAY 22	GEN 3.4–1 and GEN 3.4–2	5 OCT 23
ENR 0.4–1 through ENR 0.4–4	20 APR 23	ENR 0.4–1 through ENR 0.4–4	5 OCT 23
ENR 1.8–3 through ENR 1.8–7	19 MAY 22	ENR 1.8–3 through ENR 1.8–7	5 OCT 23
ENR 1.8–8	3 NOV 22	ENR 1.8–8	3 NOV 22
ENR 1.15–5	19 MAY 22	ENR 1.15–5	5 OCT 23
ENR 1.15–6	19 MAY 22	ENR 1.15–6	19 MAY 22
ENR 4.1–11 and ENR 4.1–12	3 NOV 22	ENR 4.1–11 and ENR 4.1–12	5 OCT 23
ENR 4.1–35 through ENR 4.1–40	20 APR 23	ENR 4.1–35 through ENR 4.1–40	5 OCT 23
ENR 5.1–5	19 MAY 22	ENR 5.1–5	19 MAY 22
ENR 5.1–6	19 MAY 22	ENR 5.1–6	5 OCT 23
ENR 5.2–1	19 MAY 22	ENR 5.2–1	19 MAY 22
ENR 5.2–2 and ENR 5.2–3	3 NOV 22	ENR 5.2–2 and ENR 5.2–3	5 OCT 23
ENR 6.2–1	19 MAY 22	ENR 6.2–1	5 OCT 23
ENR 6.2–2	19 MAY 22	ENR 6.2–2	19 MAY 22
ENR 6.2–5	19 MAY 22	ENR 6.2–5	5 OCT 23
ENR 6.2–6	19 MAY 22	ENR 6.2–6	19 MAY 22
ENR 7.2–1 through ENR 7.2–3	19 MAY 22	ENR 7.2–1 through ENR 7.2–3	5 OCT 23
ENR 8.2–1	20 APR 23	ENR 8.2–1	20 APR 23
ENR 8.2–2	20 APR 23	ENR 8.2–2	5 OCT 23
ENR 8.5–1	20 APR 23	ENR 8.5–1	20 APR 23
ENR 8.5–2	20 APR 23	ENR 8.5–2	5 OCT 23
AD 0.4–1 through AD 0.4–5	20 APR 23	AD 0.4–1 through AD 0.4–6	5 OCT 23
AD 2–1 through AD 2–597	20 APR 23	AD 2–1 through AD 2–652	5 OCT 23

---

I-1 through I-9 .....	20 APR 23	I-1 through I-9 .....	5 OCT 23
Appendix 2-1 .....	19 MAY 22	Appendix 2-1 .....	5 OCT 23
Appendix 2-2 .....	19 MAY 22	Appendix 2-2 .....	19 MAY 22
Appendix 2-19 through Appendix 2-21 ..	19 MAY 22	Appendix 2-19 through Appendix 2-21 ..	5 OCT 23
Appendix 2-22 .....	20 APR 23	Appendix 2-22 .....	20 APR 23

---

**AIP**  
**AERONAUTICAL INFORMATION PUBLICATION**  
**UNITED STATES OF AMERICA**

**PART 1**  
**GENERAL (GEN)**





# PART 1 – GENERAL (GEN)

## GEN 0.

### GEN 0.1 Preface

#### 1. Name of the Publishing Authority

**1.1** The United States of America Aeronautical Information Publication (AIP) is published by the authority of the Federal Aviation Administration.

#### 2. Applicable ICAO Documents

**2.1** The AIP is prepared in accordance with the Standards and Recommended Practices (SARP) of Annex 15 to the Convention on International Civil Aviation and the Aeronautical Information Services Manual (ICAO Doc 8126). Charts contained in the AIP are produced in accordance with Annex 4 to the Convention on International Civil Aviation and the Aeronautical Chart Manual (ICAO Doc 8697). Differences from ICAO Standards, Recommended Practices and Procedures are given in subsection GEN 1.7.

#### 3. The AIP Structure and Established Regular Amendment Interval

##### 3.1 The AIP Structure

The AIP is made up of three Parts; General (GEN), En Route (ENR), and Aerodromes (AD); each divided into sections and subsections as applicable, containing various types of information subjects.

##### 3.1.1 PART 1 – General (GEN)

PART 1 consists of five sections containing information as briefly described hereafter:

**3.1.1.1** GEN 0. – Preface; Record of AIP Amendments; Checklist of AIP Pages; and Table of Contents to PART 1.

**3.1.1.2** GEN 1. National Regulations and Requirements – Designated Authorities; Flights Into or Over U.S. Territorial Airspace; Entry, Transit, and Departure of Cargo; Aircraft Instruments, Equipment, and Flight Documents; Summary of National Regulations and International Agreements/Conventions; and Differences from ICAO Standards, Recommended Practices, and Procedures.

**3.1.1.3** GEN 2. Tables and Codes – Measuring System, Time System, and Aircraft Markings; Abbreviations Used in AIS Publications; Chart Symbols; Location Indicators; List of Radio Navigation Aids; Conversion Tables; and Sunrise/Sunset Tables.

**3.1.1.4** GEN 3. Services – Aeronautical Information Services; Aeronautical Charts; Air Traffic Services; Communication Service; Meteorological Services; Search and Rescue; and Aircraft Rescue and Fire Fighting Communications.

**3.1.1.5** GEN 4. Charges for Aerodromes/Heliports and Air Navigation Services – Fees and Charges; and Air Navigation Facility Charges.

##### 3.1.2 PART 2 – En Route (ENR)

PART 2 consists of seven sections containing information as briefly described hereafter:

**3.1.2.1** ENR 0. – Checklist of AIP Pages; and the Table of Contents to PART 2.

**3.1.2.2** ENR 1. General Rules and Procedures – General Rules; Visual Flight Rules; Instrument Flight Rules; ATS Airspace Classification; Holding, Approach, and Departure Procedures; ATS Surveillance Services and

Procedures; Altimeter Setting Procedures; Flight Planning; Addressing of Flight Plans for Domestic or international Flight Planning; National Security and Interception Procedures; Medical Facts for Pilots; Safety, Hazard, and Accident Reports; and Performance–Based Navigation (PBN) and Area Navigation (RNAV).

**3.1.2.3** ENR 2. Air Traffic Services Airspace.

**3.1.2.4** ENR 3. ATS Routes – Lower ATS Routes; Upper ATS Routes; Area Navigation Routes; and Other Routes.

**3.1.2.5** ENR 4. Navigation Aids/Systems – Navigation Aids – En Route; and Special Navigation Systems.

**3.1.2.6** ENR 5. Navigation Warnings – Prohibited, Restricted, and Other Areas; Military Exercise and Training Areas; Bird Migration and Areas with Sensitive Fauna; and Potential Flight Hazards.

**3.1.2.7** ENR 6. Helicopter Operations – Helicopter IFR Operations; and Special Operations.

**3.1.2.8** ENR 7. Oceanic Operations – General Procedures; Data Link Procedures; Special Procedures for In–Flight Contingencies in Oceanic Airspace; Operational Policy 50 NM Lateral Separation; Operational Policy ADS–C Distance–Based Separation; North Atlantic (NAT) Oceanic Clearance Procedures; North Atlantic (NAT) Timekeeping Procedures; North Atlantic (NAT) Safety Information; San Juan FIR Customs Procedures; Y–Routes; Atlantic High Offshore Airspace Offshore Routes Supporting Florida Airspace Optimization; Reduced Separation Climb/Descent Procedures; and New York Oceanic Control Area (OCA) West Flight Level Allocation.

### **3.1.3 PART 3 – Aerodromes (AD)**

PART 3 consists of three sections containing information as briefly described hereafter:

**3.1.3.1** AD 0. – Checklist of AIP Pages; and Table of Contents to PART 3.

**3.1.3.2** AD 1. Aerodromes – Introduction: Aerodrome Availability.

**3.1.3.3** AD 2. Aerodromes: Listing of Aerodromes.

## **3.2 Regular Amendment Interval**

Regular amendments to the AIP will be issued every 6 months on Aeronautical Information Regulation and Control (AIRAC) effective dates listed in TBL GEN 0.1–1. A list of all AIRAC effective dates are contained in TBL GEN 0.1–2.

*TBL GEN 0.1–1*  
**Publication Schedule**

<b>New Edition or Amendment</b>	<b>Cutoff Date for Submission</b>	<b>Effective Date of Publication</b>
Twenty–Seventh Edition	2 DEC 21	19 MAY 22
Amendment 1	19 MAY 22	3 NOV 22
Amendment 2	3 NOV 22	20 APR 23
Amendment 3	20 APR 23	5 OCT 23
Twenty–Eighth Edition	5 OCT 23	21 MAR 24
Amendment 1	21 MAR 24	5 SEP 24
Amendment 2	5 SEP 24	20 FEB 25
Amendment 3	20 FEB 25	7 AUG 25

*TBL GEN 0.1-2*  
**AIRAC System Effective Dates**

<b>2022</b>	<b>2023</b>	<b>2024</b>	<b>2025</b>	<b>2026</b>
27 JAN	26 JAN	25 JAN	23 JAN	22 JAN
24 FEB	23 FEB	22 FEB	20 FEB	19 FEB
24 MAR	23 MAR	21 MAR	20 MAR	19 MAR
21 APR	20 APR	18 APR	17 APR	16 APR
19 MAY	18 MAY	16 MAY	15 MAY	14 MAY
16 JUN	15 JUN	13 JUN	12 JUN	11 JUN
14 JUL	13 JUL	11 JUL	10 JUL	9 JUL
11 AUG	10 AUG	8 AUG	7 AUG	6 AUG
8 SEP	7 SEP	5 SEP	4 SEP	3 SEP
6 OCT	5 OCT	3 OCT	2 OCT	1 OCT
3 NOV	2 NOV	31 OCT	30 OCT	29 OCT
1 DEC	30 NOV	28 NOV	27 NOV	26 NOV
29 DEC	28 DEC	26 DEC	25 DEC	24 DEC

**4. Service to Contact in Case of Detected AIP Errors or Omissions**

**4.1** In the compilation of the AIP, care has been taken to ensure that the information contained therein is accurate and complete. Any errors and omissions which may be detected, as well as any correspondence concerning the Aeronautical Information Publication, should be referred to:

FAA National Headquarters (FOB-10B)  
Publications and Administration (AJV-P12)  
Attn: AIP Editor, Room 5E41NS  
600 Independence Avenue, SW.  
Washington, DC 20597

To submit comments electronically, please email: [9-AJV-P-HQ-Correspondence@faa.gov](mailto:9-AJV-P-HQ-Correspondence@faa.gov)

**5. Subscription Information**

**5.1** This publication is distributed electronically to all who subscribe to receive email notifications through the FAA's website. All organizations are responsible for viewing, downloading, and subscribing to receive email notifications when changes occur to this order. Subscriptions to air traffic directives can be made through the Air Traffic Plans and Publications website at [https://www.faa.gov/air\\_traffic/publications/](https://www.faa.gov/air_traffic/publications/) or directly via the following link:

[https://public.govdelivery.com/accounts/USAFAA/subscriber/new?topic\\_id=USAFAA\\_39](https://public.govdelivery.com/accounts/USAFAA/subscriber/new?topic_id=USAFAA_39).



## GEN 0.2 Record of AIP Amendments

<b>AIP Amendments</b>			
<b>Amendment Number</b>	<b>Effective Date</b>	<b>Date Inserted</b>	<b>Inserted By</b>

### GEN 0.3 Record of AIP Supplements – Not applicable

**GEN 0.3**

## GEN 0.4 Checklist of Pages

PAGE	DATE
<b>PART 1 – GENERAL (GEN)</b>	
<b>GEN 0</b>	
0.1-1	19 MAY 22
0.1-2	19 MAY 22
0.1-3	5 OCT 23
0.2-1	19 MAY 22
0.4-1	5 OCT 23
0.4-2	5 OCT 23
0.4-3	5 OCT 23
0.6-1	19 MAY 22
<b>GEN 1</b>	
1.1-1	19 MAY 22
1.2-1	19 MAY 22
1.2-2	19 MAY 22
1.2-3	19 MAY 22
1.2-4	19 MAY 22
1.2-5	19 MAY 22
1.3-1	19 MAY 22
1.4-1	19 MAY 22
1.4-2	19 MAY 22
1.4-3	19 MAY 22
1.4-4	19 MAY 22
1.5-1	19 MAY 22
1.6-1	5 OCT 23
1.7-1	19 MAY 22
1.7-2	19 MAY 22
1.7-3	19 MAY 22
1.7-4	19 MAY 22
1.7-5	19 MAY 22
1.7-6	5 OCT 23
1.7-7	5 OCT 23
1.7-8	5 OCT 23
1.7-9	5 OCT 23
1.7-10	5 OCT 23
1.7-11	5 OCT 23
1.7-12	5 OCT 23
1.7-13	5 OCT 23
1.7-14	5 OCT 23
1.7-15	5 OCT 23
1.7-16	5 OCT 23
1.7-17	5 OCT 23
1.7-18	5 OCT 23
1.7-19	5 OCT 23
1.7-20	5 OCT 23
1.7-21	5 OCT 23
1.7-22	5 OCT 23
1.7-23	5 OCT 23

PAGE	DATE
1.7-24	5 OCT 23
1.7-25	5 OCT 23
1.7-26	5 OCT 23
1.7-27	5 OCT 23
1.7-28	5 OCT 23
1.7-29	5 OCT 23
1.7-30	5 OCT 23
1.7-31	5 OCT 23
1.7-32	5 OCT 23
1.7-33	5 OCT 23
1.7-34	5 OCT 23
1.7-35	5 OCT 23
1.7-36	5 OCT 23
1.7-37	5 OCT 23
1.7-38	5 OCT 23
1.7-39	5 OCT 23
1.7-40	5 OCT 23
1.7-41	5 OCT 23
1.7-42	5 OCT 23
1.7-43	5 OCT 23
1.7-44	5 OCT 23
1.7-45	5 OCT 23
1.7-46	5 OCT 23
1.7-47	5 OCT 23
1.7-48	5 OCT 23
1.7-49	5 OCT 23
1.7-50	5 OCT 23
1.7-51	5 OCT 23
1.7-52	5 OCT 23
1.7-53	5 OCT 23
1.7-54	5 OCT 23
1.7-55	5 OCT 23
1.7-56	5 OCT 23
1.7-57	5 OCT 23
1.7-58	5 OCT 23
1.7-59	5 OCT 23
1.7-60	5 OCT 23
1.7-61	5 OCT 23
1.7-62	5 OCT 23
1.7-63	5 OCT 23
1.7-64	5 OCT 23
1.7-65	5 OCT 23
1.7-66	5 OCT 23
1.7-67	5 OCT 23
1.7-68	5 OCT 23
1.7-69	5 OCT 23
1.7-70	5 OCT 23
1.7-71	5 OCT 23

PAGE	DATE
1.7-72	5 OCT 23
1.7-73	5 OCT 23
1.7-74	5 OCT 23
1.7-75	5 OCT 23
1.7-76	5 OCT 23
1.7-77	5 OCT 23
1.7-78	5 OCT 23
1.7-79	5 OCT 23
1.7-80	5 OCT 23
1.7-81	5 OCT 23
1.7-82	5 OCT 23
1.7-83	5 OCT 23
1.7-84	5 OCT 23
1.7-85	5 OCT 23
1.7-86	5 OCT 23
1.7-87	5 OCT 23
1.7-88	5 OCT 23
1.7-89	5 OCT 23
1.7-90	5 OCT 23
1.7-91	5 OCT 23
1.7-92	5 OCT 23
1.7-93	5 OCT 23
1.7-94	5 OCT 23
1.7-95	5 OCT 23
1.7-96	5 OCT 23
<b>GEN 2</b>	
2.1-1	19 MAY 22
2.1-2	19 MAY 22
2.2-1	20 APR 23
2.2-2	20 APR 23
2.2-3	20 APR 23
2.2-4	20 APR 23
2.2-5	20 APR 23
2.3-1	19 MAY 22
2.4-1	5 OCT 23
2.5-1	19 MAY 22
2.6-1	19 MAY 22
2.6-2	19 MAY 22
2.6-3	19 MAY 22
2.6-4	19 MAY 22
2.6-5	19 MAY 22
2.6-6	19 MAY 22
2.6-7	19 MAY 22
2.7-1	19 MAY 22

PAGE	DATE
<b>GEN 3</b>	
3.1-1	19 MAY 22
3.1-2	5 OCT 23
3.1-3	5 OCT 23
3.1-4	5 OCT 23
3.1-5	5 OCT 23
3.2-1	19 MAY 22
3.2-2	19 MAY 22
3.2-3	19 MAY 22
3.2-4	19 MAY 22
3.2-5	19 MAY 22
3.2-6	19 MAY 22
3.2-7	19 MAY 22
3.2-8	19 MAY 22
3.2-9	19 MAY 22
3.2-10	19 MAY 22
3.2-11	19 MAY 22
3.2-12	19 MAY 22
3.2-13	19 MAY 22
3.3-1	19 MAY 22
3.3-2	19 MAY 22
3.3-3	19 MAY 22
3.3-4	19 MAY 22
3.3-5	19 MAY 22
3.3-6	19 MAY 22
3.3-7	19 MAY 22
3.3-8	19 MAY 22
3.3-9	19 MAY 22
3.3-10	19 MAY 22
3.3-11	19 MAY 22
3.3-12	19 MAY 22
3.3-13	19 MAY 22
3.3-14	19 MAY 22
3.3-15	19 MAY 22
3.3-16	19 MAY 22
3.3-17	3 NOV 22
3.3-18	19 MAY 22
3.3-19	19 MAY 22
3.3-20	19 MAY 22
3.3-21	3 NOV 22
3.3-22	3 NOV 22
3.3-23	19 MAY 22
3.3-24	19 MAY 22
3.3-25	19 MAY 22
3.3-26	5 OCT 23
3.3-27	5 OCT 23
3.4-1	5 OCT 23
3.4-2	5 OCT 23
3.4-3	19 MAY 22
3.4-4	19 MAY 22

PAGE	DATE
3.4-5	19 MAY 22
3.4-6	19 MAY 22
3.4-7	19 MAY 22
3.4-8	19 MAY 22
3.4-9	19 MAY 22
3.4-10	19 MAY 22
3.4-11	19 MAY 22
3.4-12	19 MAY 22
3.4-13	19 MAY 22
3.4-14	19 MAY 22
3.4-15	19 MAY 22
3.4-16	19 MAY 22
3.4-17	19 MAY 22
3.4-18	19 MAY 22
3.4-19	19 MAY 22
3.4-20	19 MAY 22
3.4-21	19 MAY 22
3.4-22	19 MAY 22
3.4-23	19 MAY 22
3.5-1	19 MAY 22
3.5-2	19 MAY 22
3.5-3	19 MAY 22
3.5-4	20 APR 23
3.5-5	19 MAY 22
3.5-6	19 MAY 22
3.5-7	19 MAY 22
3.5-8	19 MAY 22
3.5-9	19 MAY 22
3.5-10	20 APR 23
3.5-11	20 APR 23
3.5-12	20 APR 23
3.5-13	20 APR 23
3.5-14	20 APR 23
3.5-15	20 APR 23
3.5-16	20 APR 23
3.5-17	20 APR 23
3.5-18	20 APR 23
3.5-19	20 APR 23
3.5-20	20 APR 23
3.5-21	20 APR 23
3.5-22	20 APR 23
3.5-23	20 APR 23
3.5-24	20 APR 23
3.5-25	20 APR 23
3.5-26	20 APR 23
3.5-27	20 APR 23
3.5-28	20 APR 23
3.5-29	20 APR 23
3.5-30	20 APR 23
3.5-31	20 APR 23

PAGE	DATE
3.5-32	20 APR 23
3.5-33	20 APR 23
3.5-34	20 APR 23
3.5-35	20 APR 23
3.5-36	20 APR 23
3.5-37	20 APR 23
3.5-38	20 APR 23
3.5-39	20 APR 23
3.5-40	20 APR 23
3.5-41	20 APR 23
3.5-42	20 APR 23
3.5-43	20 APR 23
3.5-44	20 APR 23
3.5-45	20 APR 23
3.5-46	20 APR 23
3.5-47	20 APR 23
3.5-48	20 APR 23
3.5-49	20 APR 23
3.5-50	20 APR 23
3.5-51	20 APR 23
3.5-52	20 APR 23
3.5-53	20 APR 23
3.5-54	20 APR 23
3.5-55	20 APR 23
3.5-56	20 APR 23
3.5-57	20 APR 23
3.5-58	20 APR 23
3.5-59	20 APR 23
3.5-60	20 APR 23
3.5-61	20 APR 23
3.5-62	19 MAY 22
3.5-63	20 APR 23
3.5-64	20 APR 23
3.5-65	20 APR 23
3.5-66	20 APR 23
3.5-67	20 APR 23
3.5-68	19 MAY 22
3.5-69	19 MAY 22
3.5-70	19 MAY 22
3.5-71	19 MAY 22
3.5-72	19 MAY 22
3.5-73	19 MAY 22
3.5-74	19 MAY 22
3.5-75	19 MAY 22
3.5-76	19 MAY 22
3.5-77	20 APR 23
3.5-78	20 APR 23
3.5-79	19 MAY 22
3.5-80	19 MAY 22
3.5-81	19 MAY 22



PAGE	DATE
3.5-82	19 MAY 22
3.5-83	19 MAY 22
3.5-84	19 MAY 22
3.5-85	20 APR 23
3.5-86	20 APR 23
3.5-87	20 APR 23
3.5-88	19 MAY 22
3.5-89	20 APR 23
3.5-90	20 APR 23
3.5-91	20 APR 23
3.5-92	20 APR 23
3.5-93	20 APR 23
3.5-94	20 APR 23
3.6-1	19 MAY 22
3.6-2	19 MAY 22

PAGE	DATE
3.6-3	19 MAY 22
3.6-4	19 MAY 22
3.6-5	19 MAY 22
3.6-6	19 MAY 22
3.6-7	19 MAY 22
3.6-8	19 MAY 22
3.6-9	19 MAY 22
3.6-10	19 MAY 22
3.6-11	19 MAY 22
3.6-12	19 MAY 22
3.6-13	19 MAY 22
3.6-14	19 MAY 22
3.6-15	19 MAY 22
3.6-16	19 MAY 22
3.6-17	19 MAY 22

PAGE	DATE
3.6-18	19 MAY 22
3.6-19	19 MAY 22
3.6-20	19 MAY 22
3.6-21	19 MAY 22
3.6-22	19 MAY 22
3.6-23	19 MAY 22
3.6-24	19 MAY 22
3.6-25	19 MAY 22
3.7-1	19 MAY 22
3.7-2	19 MAY 22
<b>GEN 4</b>	
4.1-1	19 MAY 22
4.1-2	19 MAY 22
4.2-1	19 MAY 22

GEN 0.5 List of Hand Amendments to the AIP – Not applicable

GEN 0.5 List of Hand Amendments to the AIP – Not applicable

## GEN 0.6 Table of Contents to Part 1

### GEN 1. National Regulations and Requirements

GEN 1.1 Designated Authorities . . . . .	GEN 1.1-1
GEN 1.2 Flights Into or Over U.S. Territorial Airspace . . . . .	GEN 1.2-1
GEN 1.3 RESERVED . . . . .	GEN 1.3-1
GEN 1.4 Entry, Transit, and Departure of Cargo . . . . .	GEN 1.4-1
GEN 1.5 Aircraft Instruments, Equipment, and Flight Documents . . . . .	GEN 1.5-1
GEN 1.6 Summary of National Regulations and International Agreements/Conventions . . . . .	GEN 1.6-1
GEN 1.7 Differences From ICAO Standards, Recommended Practices and Procedures . . . . .	GEN 1.7-1

### GEN 2. Tables and Codes

GEN 2.1 Measuring System, Time System, and Aircraft Markings . . . . .	GEN 2.1-1
GEN 2.2 Abbreviations Used in AIS Publications . . . . .	GEN 2.2-1
GEN 2.3 Chart Symbols . . . . .	GEN 2.3-1
GEN 2.4 Location Indicators . . . . .	GEN 2.4-1
GEN 2.5 List of Radio Navigation Aids . . . . .	GEN 2.5-1
GEN 2.6 Conversion Tables . . . . .	GEN 2.6-1
GEN 2.7 Sunrise/Sunset Tables . . . . .	GEN 2.7-1

### GEN 3. Services

GEN 3.1 Aeronautical Information Services . . . . .	GEN 3.1-1
GEN 3.2 Aeronautical Charts . . . . .	GEN 3.2-1
GEN 3.3 Air Traffic Services . . . . .	GEN 3.3-1
GEN 3.4 Communication Service . . . . .	GEN 3.4-1
GEN 3.5 Meteorological Services . . . . .	GEN 3.5-1
GEN 3.6 Search and Rescue . . . . .	GEN 3.6-1
GEN 3.7 Aircraft Rescue and Fire Fighting Communications . . . . .	GEN 3.7-1

### GEN 4. Charges for Aerodromes/Heliports and Air Navigation Services

GEN 4.1 Fees and Charges . . . . .	GEN 4.1-1
GEN 4.2 Air Navigation Facility Charges . . . . .	GEN 4.2-1



# GEN 1. NATIONAL REGULATIONS AND REQUIREMENTS

## GEN 1.1 Designated Authorities

### 1. Introduction

**1.1** This section contains the contact information for certain designated U.S. authorities that are directly involved with flights that enter, exit, or transit U.S. territorial airspace.

### 2. Designated Authorities

**2.1** Certain designated authorities concerned with facilitation of aircraft operations in the U.S. can be contacted as follows:

**2.1.1** U.S. Customs and Border Protection (CBP) for:

**2.1.1.1** Customs requirements, including Advanced Passenger Information System (APIS) at <https://www.cbp.gov>.

**2.1.1.2** CBP Service Offices/Ports of Entry at [www.cbp.gov/contact/ports](http://www.cbp.gov/contact/ports).

**2.1.2** U.S. Transportation Security Administration (TSA) for TSA security programs at <https://www.tsa.gov/>.

**2.1.3** U.S. Department of Transportation (DOT) for foreign aircraft licensing and permits at <https://www.transportation.gov>.

**2.1.4** Federal Aviation Administration (FAA) at <https://www.faa.gov>.

**2.1.5** Additional designated authorities are listed with contact information on the FAA Prohibitions, Restrictions, and Notices website located at [https://www.faa.gov/air\\_traffic/publications/us\\_restrictions/](https://www.faa.gov/air_traffic/publications/us_restrictions/).

### 3. Applicable ICAO Documents

**3.1** National regulations and practices concerning facilitation of international air transport are being carried out at all international airports as far as possible in accordance with the provisions set forth in the Standards and Recommended Practices of Annex 9 to the Convention on International Civil Aviation. Differences from certain Annex 9 provisions exist only in those cases where it has not yet been possible to amend national legislation accordingly. Continuous efforts are being made to eliminate these differences.



## GEN 1.2 Flights Into or Over U.S. Territorial Airspace

### 1. General

**1.1** All aircraft operators that conduct flights into or over U.S. territorial airspace must comply with the following:

**1.1.1** National security requirements contained in AIP Section ENR 1.12, National Security and Intercept Procedures;

**REFERENCE-**

*FAA Notices to Air Missions (NOTAMS), Special Notices, at ([http://www.faa.gov/pilots/flt\\_plan/notams/](http://www.faa.gov/pilots/flt_plan/notams/)).*

*FAA Prohibitions, Restrictions, and Notices website located at [https://www.faa.gov/air\\_traffic/publications/us\\_restrictions/](https://www.faa.gov/air_traffic/publications/us_restrictions/).*

**1.1.2** All applicable sections of Title 14, Code of Federal Regulations (CFR), Part 91, General Operating and Flight Rules, particularly Subpart H, Foreign Aircraft Operations and Operations of U.S. Registered Civil Aircraft Outside of the United States; and Rules Governing Persons on Board Such Aircraft;

**1.1.3** All applicable sections of Title 49, United States Code (USC), Transportation, particularly Subtitle VII, Aviation Programs (sections 40101 through 50105);

**1.1.4** All applicable sections of U.S. Customs and Border Protection (CBP) and Transportation Security Administration (TSA) requirements in Title 19 USC Part 122, Air Commerce Regulations.

**1.2** U.S. CBP designates the airport of entry or other location for international aircraft that land or depart within U.S. territorial airspace. For information pertaining to U.S. CBP Service Offices/Ports of Entry, see AIP GEN 1.1, paragraph 2.1.1.

**1.3** Subject to the observance of the applicable rules, conditions, and limitations of the Federal Aviation Regulations and the Department of Transportation (DOT)/Office of the Secretary of Transportation (OST), Office of International Aviation, as described below, foreign civil aircraft registered and manufactured in any foreign country which is a member of the International Civil Aviation Organization (ICAO) may be navigated in the U.S. Foreign civil aircraft manufactured in a country which at the time of manufacture was not a member of ICAO may be navigated in the U.S. if the country has notified ICAO that the aircraft meets the standards described in the Chicago Convention or if a notice has been filed with the DOT/OST, Office of International Aviation, through diplomatic channels, that the aircraft meets the standards described in the Chicago Convention.

**1.4** Aircraft registered under the laws of foreign countries, not members of the ICAO, may be navigated in U.S. territory only when authorized by the DOT/OST, Office of International Aviation.

**1.5** All foreign civil aircraft operated to, from, or within the U.S. must carry on board effective certificates of registration and air worthiness issued by the country of registry. Also, each member of the flight crew must carry a valid airman certificate or license authorizing that member to perform their assigned functions in the aircraft.

**1.6** Transportation of firearms by aircraft passengers. Regulations of the Alcohol, Tobacco and Firearms Division of the Internal Revenue Service make it unlawful for any person knowingly to deliver or cause to be delivered to any common or contract carrier for transportation or shipment in interstate or foreign commerce, to persons other than licensed importers, licensed manufacturers, licensed dealers, or licensed collectors, any package or other container in which there is any firearm or ammunition without written notice to the carrier that such firearm or ammunition is being transported or shipped; except that any passenger who owns or legally possesses a firearm or ammunition being transported aboard any common or contract carrier for movement with the passenger in interstate or foreign commerce may deliver said firearm or ammunition into the custody of the pilot, captain, conductor or operator of such common or contract carrier for the duration of the trip.

### 1.7 Miscellaneous Information

**1.7.1** Commercial air transport operators in the U.S. must adhere to Annex 6 – Operation of Aircraft with the proviso that aircraft which have no operators' local representative available to them will be required to carry a

fixed fuel reserve of not less than 45 minutes at the approved fuel consumption rate plus a variable reserve equivalent to 15% of the fuel required from departure to destination and to an alternate if an alternate is required; or where the reserve calculated in accordance with the above exceeds two hours at the approved fuel consumption rate – two hours reserve fuel.

## **2. Public Health**

### **2.1 Public Health Measures Applied to Aircraft**

**2.1.1** At airports without Public Health Service Quarantine staff, the Customs, Immigration, or Agriculture Officer present will represent the Public Health Service.

**2.1.2** No public health measures are required to be carried out with respect to aircraft entering U.S. territory except that disinfection of an aircraft may be required if it has departed from a foreign area that is infected with insect-borne communicable disease, and the aircraft is suspected of harboring insects dangerous to public health. Disinfection is defined as: “The operation in which measures are taken to kill the insect vectors of human disease present in carriers and containers.”

**2.1.3** Disinfection must be the responsibility of the air carrier and must be subject to monitoring by the Director of the Public Health Service.

**2.1.4** Disinfection of the aircraft must be accomplished immediately after landing and blocking. The cargo compartment must be disinfected before the mail, baggage, and other cargo are discharged, and the rest of the aircraft must be disinfected after passengers and crew deplane.

**2.1.5** Disinfection must be performed with an approved insecticide in accordance with the manufacturer’s instructions. The current list of approved insecticides and sources may be obtained from the Division of Quarantine, Center for Prevention Services, Centers for Disease Control, Atlanta, GA 30333.

**2.1.6** All food and potable water taken on board an aircraft at any airport and intended for human consumption thereon must be obtained from sources approved in accordance with Title 21 CFR Parts 1240 and 1250.

**2.1.7** Aircraft inbound or outbound on an international flight must not discharge over the U.S. any excrement or waste water or other polluting materials. Arriving aircraft must discharge such matter only at servicing areas approved under regulations cited in paragraph 2.1.6 above.

**2.1.8** Aircraft on an international voyage (that are in traffic between U.S. airports) must be subject to inspection when there occurs on board, among passengers or crew, any death, or any ill person, or when illness is suspected to be caused by insanitary conditions.

### **2.2 Public Health Requirements**

**2.2.1** Disembarking passengers are not required to present a vaccination certificate except when coming directly from an area infected with cholera, yellow fever, or smallpox. Smallpox vaccination is necessary only if, within the 14 days before arrival, the traveler has been in a country reporting smallpox.

**2.2.2** The pilot in command of an aircraft destined for a U.S. airport must report immediately to the Quarantine Station at or nearest the airport at which the aircraft will arrive, the occurrence, on board, of any death or an ill person among passengers or crew. Ill person is defined as:

**2.2.2.1** Temperature of 100 degrees Fahrenheit (38 degrees Celsius) or greater accompanied by rash, glandular swelling, or jaundice, or which has persisted for more than 48 hours; or

**2.2.2.2** Diarrhea, defined as the occurrence in a 24-hour period of three or more loose stools or of a greater than normal (for the person) amount of loose stools.

**2.2.3** The pilot in command is responsible for detaining the aircraft and persons and things arriving thereon and keeping them free from unauthorized contact pending release when required by the Foreign Quarantine Regulations of the Public Health Service described in Title 42 CFR Part 71.



### **3. Scheduled Common Carriage Flights**

#### **3.1 General**

**3.1.1** Generally, when an operator of an aircraft advertises its transportation services to the general public or particular classes or segments of the public for compensation or hire, it is a common carrier. In turn, the transportation service the operator performs is considered to be in common carriage. The scheduled flights into, from and landing in the territory of the U.S. for purposes of loading or unloading passengers, cargo and mail (revenue flights), must first obtain from the U.S. DOT/OST, Office of International Aviation (X-40), a foreign air carrier permit. Applications for common carrier authority must be filed with X-40. If X-40, with the President's approval, determines that the carrier is fit, willing, and able to perform the service it proposes and that the service is in the public interest, X-40 must issue the carrier a foreign air carrier permit, subject to the disapproval of the President of the U.S.

**3.1.2** The scheduled flights in transit across the territory of the U.S. or landing for reasons other than for the purpose of loading and unloading of passengers, cargo or mail (nonrevenue flights), which are registered in a State which is a party to the International Air Services Transit Agreement, must submit a notice of transit to X-40. The notice of transit must be submitted at least 15 days prior to the flight and must include:

**3.1.2.1** Name, country of organization and nationality (including the nationality of all ownership interests) of the operator;

**3.1.2.2** Name of the country in which the aircraft to be used in the service is registered;

**3.1.2.3** A full description of the proposed operations including the type of operations (passenger, property, mail, or combination), date of commencement, duration and frequency of flights, and routing (including each terminal and intermediate point that will be served);

**3.1.2.4** Copies of advertising of the flights, if advertised in the U.S.

**3.1.3** If the notice is timely filed, the flights may be operated in the absence of a contrary notification from X-40.

**3.1.4** Scheduled flights in transit across the territory of the U.S. or landing for reasons other than for the purpose of loading and unloading of passengers, cargo or mail (nonrevenue flights), which are registered in a State which is not a party to the International Air Services Transit Agreement, must obtain prior permission from X-40 at least 15 days prior to the flight. All permission requests must include the same information as requested in paragraph 3.1.2 (see also paragraph 1.4). The carrier may not transit U.S. territory unless and until it receives a foreign aircraft permit to do so from X-40.

**3.1.5** The permission to transit U.S. territory as described above also includes the right to make stops in the U.S. for technical purposes (for example, refueling and servicing of the aircraft) as long as the stopover does not exceed 24 hours. Stopovers which do exceed 24 hours are permitted only in those cases where a transfer of passengers, property or mail to another aircraft is necessary for the safety of the aircraft, passengers, property, or crew. Stopovers for the pleasure or convenience of passengers are not included in the transit authority.

#### **3.2 Documentary Requirements for Clearance of Aircraft**

**3.2.1** The undermentioned documents must be submitted to U.S. authorities for clearance on entry and departure of aircraft. All documents listed below must follow the ICAO standard format as set forth in the relevant appendixes to Annex 9, and are acceptable only when furnished in English.

**3.2.2** Aircraft Documents Required (Arrival and Departure)

TBL GEN 1.2-1

Required by	General Declaration	Passenger Manifest	Cargo Manifest
Customs Agriculture	1	0	1
Plant and Quarantine	1	0	1
Immigrations	1	0	1
Public Health	1	0	0
Total	4	0	3

#### 4. Nonscheduled, Noncommon Carriage Flights

##### 4.1 General

4.1.1 Nonscheduled, noncommon carriage flights are transportation services for remuneration or hire that are not offered to the general public.

4.1.2 Nonscheduled flights in transit across the territory of the U.S. or landing for reasons other than the purposes of loading and unloading passengers, cargo or mail (nonrevenue flights) which are registered in a State which is a member of the International Civil Aviation Organization (ICAO) may do so without the necessity of obtaining prior permission, provided passengers are not permitted to leave the airport during stopover or provided that each stopover does not exceed 24 hours. Stopovers which do exceed 24 hours are permitted only in those cases where a transfer of passengers, property or mail to another aircraft is necessary for the safety of the aircraft, passengers, property, or crew. Stopovers for the pleasure or convenience of passengers are not included in the transit authority.

4.1.3 Nonscheduled flights landing in the territory of the U.S. for reasons of loading or unloading passengers, cargo or mail (revenue flights), must obtain prior permission from the DOT/OST, Office of International Aviation (X-40), at least 15 days prior to the flight. All permission requests must include:

4.1.3.1 Name and address of applicant.

4.1.3.2 Aircraft make, model, and registration or identification marks.

4.1.3.3 Country in which the aircraft is registered.

4.1.3.4 Name and address of registered owner of aircraft.

4.1.3.5 Type of flight(s) (passenger, cargo, or agricultural or industrial operation).

4.1.3.6 Purpose of flight(s).

4.1.3.7 Date of the flight(s).

4.1.3.8 Routing of the flight(s).

4.1.3.9 Number of flights.

4.1.3.10 Name of charterer.

4.1.3.11 Charter price.

4.1.4 Applications should be made on DOT/OST, Office of International Aviation Form 4509; however, if time does not permit, applications by telegram will be accepted as long as they include the information described above. Telegraphic applications must include a prepaid voucher sufficient to allow a sixty word reply. The permit must be carried aboard the aircraft during flight over U.S. territory.

##### 4.2 The following commercial air operations require preflight authorization from X-40:

**4.2.1** Agricultural and industrial operations which include, but are not limited to, such services as crop dusting, pest control, pipeline patrols, mapping, surveying, banner towing, or skywriting.

**4.2.2** Occasional and infrequent planeload charter flights carrying persons or property to and/or from the U.S. The number of these flights that may be performed is limited to six in any calendar year. Foreign civil aircraft are not permitted to transport persons or property or mail for compensation or hire between points wholly within the U.S.

**4.2.3** Continuing cargo operations for one or more contractors. Applicants may be authorized to serve up to 10 different contractors in a 12-month period; however, authorization may be granted only if it is clear that the service is not in common carriage and the carrier and contractor enter into a contract which provides for (a) continuing cargo operations for a period of at least 6 months; (b) an absolute or minimum number of flights or volume of cargo to be transported; and (c) a guarantee by the contractor to the carrier to pay for the minimum number of flights to be performed or volume of cargo to be transported whether or not he/she uses the capacity. Continuing cargo operations wholly within the U.S. cannot be authorized.

**4.2.4** Persons wishing to operate foreign civil aircraft from, to, or within the U.S. other than as described in this section may request permission to perform those services by filing an application with X-40. The application should include the information described above in this section. Permission to perform these services may be granted if X-40 finds that the service is consistent with applicable law and is in the interest of the public of the U.S.

**4.2.5** Nonscheduled flights in transit across the territory of the U.S. or landing with or without purposes of loading and unloading passengers, cargo or mail (revenue or nonrevenue flights) which are registered in a State which is not a member of the International Civil Aviation Organization (ICAO) must obtain prior permission from X-40 at least 15 days prior to the flight. All permission requests must include the same information as requested in paragraph 4.1.3. (See also paragraph 1.4).

### **4.3 Documentary Requirements for Clearance of Aircraft**

**4.3.1** Same requirements as for scheduled flights.



## GEN 1.3 [RESERVED]



## GEN 1.4 Entry, Transit, and Departure of Cargo

### 1. Requirements Concerning Cargo and Other Articles

**1.1** Customs entry and clearance of cargo and unaccompanied baggage destined for points within U.S. territory must be completed at the first international airport of entry.

**1.2** Transshipment of cargo and other articles must be dealt with at the first international airport of entry according to related regulations. All aircraft entering the U.S. or arriving any place in the U.S. from any other place in the U.S. carrying residue foreign cargo must not depart from the place of landing without receiving permission from the Customs officer.

### 2. Agricultural Quarantine Requirements

**2.1** The U.S. Department of Agriculture, Plant Protection and Quarantine Division (PPQ), has strict requirements regarding the entry, handling and disposition of garbage and galley refuse on all flights arriving from any foreign country, except Canada (7 CFR Parts 94 and 330). A list of sanitary international airports approved by PPQ can be secured from any PPQ office at major airports (see Aerodrome Section).

**2.2** The U.S. Department of Agriculture (USDA) specifies regulations for inspecting aircraft and persons moving from Hawaii, Puerto Rico, Guam, the Commonwealth of the Northern Mariana Islands, or the U.S. Virgin Islands. The person moving the aircraft must contact and offer an inspector the opportunity to inspect the aircraft (7 CFR Parts 318.13 and 318.58).

**2.3** Meat, meat products, milk, live birds, poultry, or other domestic farm animals can only enter the U.S. under certain conditions from certain countries under the regulations of the PPQ.

**2.4** No insects or other plant pests must knowingly be transported into the U.S. If the pilot of any aircraft has reason to believe any flying or crawling insects are aboard his/her aircraft, such information should be relayed to the nearest PPQ office or inspector when landing.

**2.5** Permits are required to bring most fruits, vegetables, plants, seeds, etc., into the U.S. from foreign countries. A guide to restricted or prohibited products can be secured from any PPQ office.

**2.6** Dogs, cats, monkeys, psittacine birds (parrot family), turtles, shipments of disease organisms and vectors, and dead bodies are subject to entry restrictions prescribed in the Foreign Quarantine Regulations of the Public Health Service (42 CFR Part 71, Subject J).

### 3. Exportation of Aircraft, Cargo, and Other Articles

**3.1** All U.S. and foreign registered aircraft departing the U.S. for a foreign destination on a temporary sojourn must have export authorization. The two types of export authorization are a license exception (AVS) and a license. Detailed information on both the license exception and the license can be obtained from:

The U. S. Department of Commerce  
Bureau of Export Administration  
Exporter Counseling Division  
Washington, DC 20230  
Telephone: (202) 482-4811  
Facsimile: (202) 482-3617

**3.2** A license exception (AVS) is an authorization to export the aircraft if certain criteria are satisfied. This exception does not require an application nor will there be an issuance of a license document prior to the flight.

**REFERENCE-**  
15 CFR Section 740.15

**3.3** License exception AVS authorizes an operating civil aircraft of foreign registry that has been in the U.S. on a temporary sojourn to depart from the U.S. under its own power for any destination, provided that:

**3.3.1** No sale or transfer of operational control of the aircraft to nationals of Cuba, Iran, Iraq, Libya, North Korea, Sudan, or Syria has occurred while in the U.S.

**3.3.2** The aircraft is not departing for the purpose of sale or transfer of operational control to nationals of Cuba, Iran, Iraq, Libya, North Korea, Sudan, or Syria; and

**3.3.3** It does not carry from the U.S. any item for which an export license is required and has not been granted by the U.S. Government.

**3.4** License exception AVS authorizes a civil aircraft of U.S. registry operating under an Air Carrier Operating Certificate, Commercial Operating Certificate, or Air Taxi Operating Certificate issued by the Federal Aviation Administration or conducting flights under operating specifications approved by the Federal Aviation Administration pursuant to 14 CFR Part 129 of the regulations of the Federal Aviation Administration, may depart from the U.S. under its own power for any destination provided that:

**3.4.1** The aircraft does not depart for the purpose of sale, lease or other disposition of operational control of the aircraft or its equipment, parts, accessories, or components to a foreign country or any national thereof.

**3.4.2** The aircraft's U.S. registration will not be changed while abroad.

**3.4.3** The aircraft is not to be used in any foreign military activity while abroad; and

**3.4.4** The aircraft does not carry from the U.S. any item for which a license is required and has not been granted by the U.S. Government.

**3.5** License exception AVS authorizes any other operating civil aircraft of U.S. registry to depart from the U.S. under its own power for any destination, except to Cuba, Iran, Iraq, Sudan, Syria, Libya, and North Korea (flights to these destinations require a license), provided that:

**3.5.1** The aircraft does not depart for the purpose of sale, lease or other disposition of operational control of the aircraft, or its equipment, parts, accessories, or components to a foreign country or national thereof.

**3.5.2** The aircraft's U.S. registration will not be changed while abroad.

**3.5.3** The aircraft is not to be used in any foreign military activity while abroad.

**3.5.4** The aircraft does not carry from the U.S. any item for which an export license is required and has not been granted by the U.S. Government; and

**3.5.5** The aircraft will be operated while abroad by a U.S. licensed pilot, except that during domestic flights within a foreign country, the aircraft may be operated by a pilot currently licensed by that foreign country.

**3.6** A license authorizes the departure of the aircraft within the special limitations set forth in the license document. It is issued only on the basis of a formal application requesting the issuance of a license prior to the flight.

**3.7** Once it has been determined that an export license is required, an application for the license should be submitted to the Bureau of Export Administration, U.S. Department of Commerce. An application consists of Form BXA-748P (multipurpose application). This form and information on the application process can be obtained free of charge from either the U.S. Department of Commerce in Washington or any of its District Offices. (See paragraph 4.)

**3.8** Applications for validated licenses by non-U.S. citizens require that the applicant appoint an agent subject to U.S. jurisdiction to act in his/her behalf. If an emergency situation necessitates the expedition of the application process, contact the Counseling Division Staff of the Bureau of Export Administration (telephone 202-482-4811) or any Department of Commerce District Office for assistance.



#### 4. Department of Commerce District Office Locations

TBL GEN 1.4-1

State	City
Alabama	Birmingham
Alaska	Anchorage
Arizona	Phoenix
California	Los Angeles
California	San Francisco
Colorado	Denver
Connecticut	Hartford
Florida	Miami
Georgia	Atlanta
Georgia	Savannah
Hawaii	Honolulu
Illinois	Chicago
Indiana	Indianapolis
Iowa	Des Moines
Louisiana	New Orleans
Maryland	Baltimore
Massachusetts	Boston
Michigan	Detroit
Minnesota	Minneapolis
Missouri	St. Louis
Nebraska	Omaha

Nevada	Reno
New Jersey	Newark
New Mexico	Albuquerque
New York	Buffalo
New York	New York
North Carolina	Greensboro
Ohio	Cincinnati
Ohio	Cleveland
Oregon	Portland
Pennsylvania	Philadelphia
Pennsylvania	Pittsburgh
Puerto Rico	San Juan
South Carolina	Columbia
Tennessee	Memphis
Texas	Dallas
Texas	Houston
Utah	Salt Lake City
Washington	Seattle
West Virginia	Charleston
Wisconsin	Milwaukee
Wyoming	Cheyenne

#### 5. Regulations Concerning Civil Movement of Arms, Ammunition, and Military Type Aircraft

**5.1** Importation of military type aircraft and the carriage or importation of firearms or ammunition are regulated by the U.S. Department of the Treasury, Division of Alcohol, Tobacco and Firearms.

**5.2** A permit must be obtained from the Alcohol, Tobacco and Firearms Division for the importation of certain military type aircraft regardless of demilitarization. Aircraft that are exempt from permits are specifically listed in the regulations on Importation of Arms, Ammunition and Implements of War (26 CFR Part 180).

**5.3** A permit must be obtained from the Alcohol, Tobacco and Firearms Division for the importation of firearms and ammunition for commercial transactions.

**5.4** Transportation or shipment of firearms or ammunition in interstate or foreign commerce to persons other than licensed importers, licensed manufacturers, licensed dealers or licensed collectors, without written notice to the carrier that such firearms or ammunition is being transported or shipped is unlawful.

**5.5** Any passenger who owns or legally possesses a firearm or ammunition being transported aboard any common or contract carrier for movement with the passenger must deliver said firearm or ammunition into the custody of the pilot, captain, conductor, or operator of such common or contract carrier for the duration of the trip.

**5.6** Applications for permits should be made on Form 6 (Firearms), preferably 30 days in advance of importation. Form IRS-4522, International Import Certificate, may also be required by the exporting country and should accompany applications on Form 6 (Firearms) when necessary.

**5.7** Exportation of military type aircraft are regulated by the U.S. Department of State, Office of Munitions Control.

**5.8** A license must be obtained from the Office of Munitions Control, Department of State, for the exportation from the U. S. of certain military type aircraft regardless of demilitarization. Aircraft that are exempt from licenses are specifically listed in the regulations on International Traffic in Arms (22 CFR Part 121). Applications for licenses are made as follows:

**5.8.1** For permanent export, on Form DSP-5. Apply at least 30, preferable 60, days in advance. A Form DSP-63a may also be required from the importing country.

**5.8.2** For temporary export, on Form DSP-73. Apply at least 10 days in advance.

## **GEN 1.5 Aircraft Instruments, Equipment, and Flight Documents**

### **1. General**

**1.1** Commercial air transport aircraft operating in the U.S. airspace must adhere to the provisions of Annex 6, Operation of Aircraft, Part One, Chapter Six (Airplane Instruments, Equipment and Flight Documents) and Chapter Seven (Airplane Communications and Navigation Equipment).



---

## GEN 1.6 Summary of National Regulations and International Agreements/Conventions

### 1. Summary of National Regulations

**1.1** Air regulations for the U.S. and areas under its jurisdiction are published in Title 14 of the U.S. Code of Federal Regulations (CFR) Parts 1–199, entitled the Federal Aviation Administration, Department of Transportation. It is essential that persons engaged in air operations in the U.S. airspace be acquainted with the relevant regulations. Copies of the 14 CFR parts may be purchased from the:

Superintendent of Documents  
U.S. Government Publishing Office  
Attn: New Orders  
P.O. Box 979050  
St. Louis, MO 63197–9000  
Telephone: 202–512–1800

**1.2** Title 14, Chapter I, of the CFR is available electronically at: <https://www.ecfr.gov/current/title-14/chapter-I>.



## GEN 1.7 Differences From ICAO Standards, Recommended Practices and Procedures

**NOTE–**

See GEN 1.6 for the availability of Title 14 of the U.S. Code of Federal Regulations Parts 1–199.

<b>ANNEX 1 – PERSONNEL LICENSING</b>	
<b>Chapter 1</b>	<b>Definitions and General Rules Concerning Licences</b>
Remote co–pilot	The United States does not currently define.
Remote flight crew member	The United States does not currently define.
Remote pilot	The United States does not currently define.
Chapter 1 Reference 1.2.5.2	<p>The maximum validity allowed for non-FAA air traffic controllers (required to hold an FAA Second-Class airman medical certificate) is 12 months.</p> <p>The maximum validity allowed for FAA air traffic controllers is 24 months for those under age 40 who work at FAA terminals or centers.</p> <p>U.S. free balloon and glider pilots are not required to hold medical certificates but are prohibited from operating during periods of medical deficiency.</p> <p>Since the United States has not specifically mandated RPAS medical assessment, a 48–month duration period for the remote pilot licence –aeroplane, airship, glider, rotorcraft, powered–lift, or free balloon is not established.</p>
Chapter 1 Reference 1.2.5.2.2	U.S. commercial pilots engaging in single-crew commercial air transport operations carrying passengers have a 12-month validity on their medical assessments regardless of age.
Chapter 1 Reference 1.2.5.2.3	U.S. commercial pilots have a 12-month validity on their medical assessments regardless of age.
Chapter 1 Reference 1.2.5.2.4	<p>U.S. free balloon and glider pilots are not required to hold a medical certificate but are prohibited from operating during periods of medical deficiency.</p> <p>Certain holders of U.S. private pilot licenses (operating domestically) are not required to hold an FAA medical certificate but must meet U.S. (“Basic Med”) regulations effective May 1, 2017. “Basic Med” requires a medical education course every 24 months and medical examination every 48 months.</p> <p>Since the United States has not specifically mandated RPAS medical assessment, reducing validity to 24 months for holders of remote pilot licenses is not established.</p>
Chapter 1 Reference 1.2.5.2.5	<p>U.S. private pilots required to hold an FAA Third–Class medical certificate who have passed their 50<sup>th</sup> birthday have a 24-month validity on their medical assessments.</p> <p>U.S. free balloon and glider pilots are not required to hold medical certificates but are prohibited from operating during periods of medical deficiency.</p> <p>Since the United States has not specifically mandated RPAS medical assessment, reducing validity to 12 months for holders of remote pilot licenses who have passed their 50<sup>th</sup> birthday is not established.</p>
Chapter 1 Reference 1.2.5.2.6	The United States does not defer medical examinations.

<b>Chapter 2</b>	<b>Licences and Ratings for Pilots</b>
Chapter 2 Reference 2.1.9.2	The United States only allows pilots to log SIC flight experience in an aircraft that requires an SIC by type design or by an operational requirement.
Chapter 2 Reference 2.1.9.3	SIC experience (hours) may only be used towards obtaining an Airline Transport Pilot certificate with an Airplane rating. Then, only 1/3 of the SIC time may be applied, with a maximum allowable 500 hrs as SIC.
Chapter 2 Reference 2.1.10	The U.S. currently limits all part 121 operations to age 65, but has no age restriction on all other commercial air trans operations (such as part 135 operations).
Chapter 2 Reference 2.3.1.4	U.S. private pilots required to hold an FAA Third–Class medical certificate must meet the requirements of an FAA Third-Class medical certificate which are equivalent to ICAO Class 2 with exceptions specified in Chapter 6.
Chapter 2 Reference 2.4.1.4	U.S. commercial pilots must meet the requirements of an FAA Second-Class medical certificate which are equivalent to ICAO Class 1 with exceptions specified in Chapter 6.
Chapter 2 Reference 2.5.1.1	The United States has no 14 CFR provisions for MPL.
Chapter 2 Reference 2.5.1.2	The United States has no 14 CFR provisions for MPL.
Chapter 2 Reference 2.5.1.3.1	The United States has no 14 CFR provisions for MPL.
Chapter 2 Reference 2.5.1.3.2	The United States has no 14 CFR provisions for MPL.
Chapter 2 Reference 2.5.1.4	The United States has no 14 CFR provisions for MPL.
Chapter 2 Reference 2.5.2.1	The United States has no 14 CFR provisions for MPL.
Chapter 2 Reference 2.5.2.2	The United States has no 14 CFR provisions for MPL.
Chapter 2 Reference 2.5.2.3	The United States has no 14 CFR provisions for MPL.
Chapter 2 Reference 2.5.3.1	The United States has no 14 CFR provisions for MPL.
Chapter 2 Reference 2.5.3.2	The United States has no 14 CFR provisions for MPL.
Chapter 2 Reference 2.5.3.3	The United States has no 14 CFR provisions for MPL.
Chapter 2 Reference 2.5.4.1	The United States has no 14 CFR provisions for MPL.
Chapter 2 Reference 2.5.4.2	The United States has no 14 CFR provisions for MPL. However, the FAA could approve a part 141 special curriculum or part 142 training curriculum for operators wanting to train persons to meet the ICAO MPL requirements.
Chapter 2 Reference 2.6.1.1.	The United States minimum age is 23.
Chapter 2 Reference 2.6.1.4	U.S. airline transport pilots must meet the requirements of an FAA First-Class medical certificate which are equivalent to ICAO Class 1 with exceptions specified in Chapter 6.
Chapter 2 Reference 2.7.1.3.1	U.S. private pilots required to hold an FAA Third–Class medical certificate who hold an airplane instrument rating are not required to comply with ICAO Class 1 hearing standards. U.S. hearing requirements for FAA First- and Third-Class medical certificates are equivalent to ICAO Class 1 with exceptions specified in Chapter 6.



Chapter 2 Reference 2.8.2.2	The United States has no 14 CFR provisions for MPL. However, the FAA could approve a part 141 special curriculum or a part 142 training curriculum for operators wanting to train persons to meet the ICAO MPL requirements.
Chapter 2 Reference 2.9.1.5	U.S. glider pilots are not required to hold a medical certificate but are prohibited from operating during periods of medical deficiency.
Chapter 2 Reference 2.10.1.5	U.S. free balloon pilots are not required to hold a medical certificate but are prohibited from operating during periods of medical deficiency.
Chapter 2 Reference 2.11.9	The United States has not specifically mandated an age 60 limitation on RPAS privileges.
Chapter 2 Reference 2.12.3	The United States has not established a specific category for “student remote pilot” nor a requirement for medical assessment equivalent to ICAO Class 1 or Class 3.
Chapter 2 Reference 2.13.1.4	The United States has not established a specific requirement for an instrument–rated RPAS pilot to hold a Class 3 or Class 1 medical assessment
<b>Chapter 3</b>	<b>Licences for Flight Crew Members other than Licences for Pilots</b>
Chapter 3 Reference 3.2.1.5	U.S. flight navigators must meet the requirements of an FAA Second-Class medical certificate which are equivalent to ICAO Class 2 with exceptions specified in Chapter 6.
Chapter 3 Reference 3.3.1.5	U.S. flight engineers must meet the requirements of an FAA Second-Class medical certificate which are equivalent to ICAO Class 2 with exceptions specified in Chapter 6.
<b>Chapter 4</b>	<b>Licences and Ratings for Personnel other than Flight Crew Members</b>
Chapter 4 Reference 4.2.1.3	The United States does not require 4 years of experience to qualify to take the written examination for a mechanic’s airframe and powerplant license.
Chapter 4 Reference 4.2.2.4	The United States does not allow an approved maintenance organization to appoint non-licensed personnel to exercise the privileges of 4.2.2 within the U.S.
Chapter 4 Reference 4.3.2	Non-FAA air traffic controllers must meet the requirements of an FAA Second-Class medical certificate which meets the intent of ICAO Class 3 with exceptions specified in Chapter 6.
Chapter 4 Reference 4.4.1.1	The United States requires that an applicant be at least 18 years of age.
Chapter 4 Reference 4.4.1.3	Intentionally left blank.
Chapter 4 Reference 4.4.1.4	Non-FAA air traffic controllers must meet the requirements of an FAA Second-Class medical certificate which meets the intent of ICAO Class 3 with exceptions specified in Chapter 6.
Chapter 4 Reference 4.6.1.1	The United States requires the applicant shall not be less than 23 years of age.
Chapter 4 Reference 4.6.1.3.2	The United States permits the applicant to have two years of experience in the last three years.
<b>Chapter 5</b>	<b>Specifications for Personnel Licences</b>
Chapter 5 Reference 5.1.3	The United States only issues certificates in the English language.
<b>Chapter 6</b>	<b>Medical Provisions for Licencing:</b> <i>Please note:</i> References containing 6.3 refer to airline transport pilots and commercial pilots; 6.4 refer to private pilots, free balloon pilots, glider pilots, student pilots, flight engineers, and flight navigators; and 6.5 refer to air traffic controllers.
Chapter 6 Reference 6.1.1	The United States has not established a specific medical assessment standard for the remote pilot license.

Chapter 6 Reference 6.2.3.2	The United States uses a variety of methods for testing visual acuity that meet the intent of ICAO Recommended Practice. Illumination levels are set by manufactured standards.
Chapter 6 Reference 6.3.1.2	An FAA first-class medical certificate is required when exercising the privileges of an airline transport pilot and an FAA second-class medical certificate is required when exercising the privileges of a commercial pilot, a flight engineer, or a flight navigator. The United States has no provisions for MPL.
Chapter 6 Reference 6.3.2.6	Electrocardiography is not required for airline transport pilots at first issue unless the individual is age 35 or older and not for commercial pilots, flight engineers, or flight navigators unless clinically indicated.
Chapter 6 Reference 6.3.2.6.1	Electrocardiography is required in re-examination of airline transport pilot applicants over the age of 40 every 12 months. Electrocardiography is not specifically required for commercial pilots, flight engineers, or flight navigators unless clinically indicated.
Chapter 6 Reference 6.3.2.6.2	Electrocardiography is required in re-examination of airline transport pilot applicants over the age of 40 every 12 months. Electrocardiography is not specifically required for commercial pilots, flight engineers, or flight navigators unless clinically indicated.
Chapter 6 Reference 6.3.2.9.1	Chest radiography is not specifically required unless clinically indicated.
Chapter 6 Reference 6.3.3.2 (b)	A specific requirement that a [spare] set of suitable correcting spectacles be kept readily available when exercising the privileges of the license is not established.
Chapter 6 Reference 6.3.3.2.1 (c)	A specific requirement that a set of suitable correcting spectacles be kept readily available when exercising the privileges of the license [with contact lenses] is not established.
Chapter 6 Reference 6.3.3.2.3	The demonstration of compliance with visual acuity by providing a full ophthalmic report is not required.
Chapter 6 Reference 6.3.3.4	The demonstration of compliance with the visual requirements to be made with only one pair of corrective lenses is not specifically required.
Chapter 6 Reference 6.3.3.4.1	A requirement that a second pair of near-correction spectacles be kept available when exercising the privileges of the license is not established.
Chapter 6 Reference 6.3.4.1.1	Applicants are not required to demonstrate normal hearing against a background noise that reproduces or simulates the masking properties of flight deck noise upon speech and beacon signals.
Chapter 6 Reference 6.3.4.1.2	Applicants are not required to take a practical hearing test.
Chapter 6 Reference 6.4.1.1	U.S. free balloon and glider pilots are not required to hold a medical certificate but are prohibited from operating during periods of medical deficiency.
Chapter 6 Reference 6.4.1.2	U.S. free balloon and glider pilots are not required to hold a medical certificate but are prohibited from operating during periods of medical deficiency.  Certain holders of U.S. private pilot licenses (operating domestically) are not required to hold an FAA medical certificate but must meet U.S. (“Basic Med”) regulations effective May 1, 2017. “Basic Med” requires a medical education course every 24 months and medical examination every 48 months.
Chapter 6 Reference 6.4.2.6	Electrocardiography for applicants for third-class airman (private pilot) medical certification is not required at first issue unless clinically indicated.

Chapter 6 Reference 6.4.2.6.1	Routine electrocardiography for applicants for FAA third-class airman (private pilot) medical certification is not required unless clinically indicated.
Chapter 6 Reference 6.4.3.4	The demonstration of compliance with the visual requirements to be made with only one pair of corrective lenses is not specifically required.
Chapter 6 Reference 6.4.3.4.1	A requirement that a second pair of near-correction spectacles be kept available when exercising the privileges of the license is not established.
Chapter 6 Reference 6.5.1	The United States has not established a specific medical assessment standard for the remote pilot license, therefore a U.S. remote pilot would not undergo specific medical examination unless U.S. regulations are adopted by 2022.
Chapter 6 Reference 6.5.1.2	The United States has not established a specific medical assessment standard for the remote pilot license.
Chapter 6 Reference 6.5.2.6	Electrocardiography is required for FAA air traffic controllers at first issue but not for non-FAA ATCs unless clinically indicated.
Chapter 6 Reference 6.5.2.6.1	Electrocardiography is required for FAA ATCs but not for non-FAA ATCs unless clinically indicated.
Chapter 6 Reference 6.5.3.2 (b)	A specific requirement that a [spare] set of suitable correcting spectacles be kept readily available when exercising the privileges of the license is not established.
Chapter 6 Reference 6.5.3.2.1 (c)	A specific requirement that a set of suitable correcting spectacles be kept readily available when exercising the privileges of the license [with contact lenses] is not established.
Chapter 6 Reference 6.5.3.2.3	The demonstration of compliance with visual acuity by providing a full ophthalmic report is not required.
Chapter 6 Reference 6.5.3.4	The demonstration of compliance with the visual requirements to be made with only pair of corrective lenses is not specifically required.
Chapter 6 Reference 6.5.3.4.1	A requirement that a second pair of near-correction spectacles be kept available when exercising the privileges of the license is not established.
Chapter 6 Reference 6.5.4.1.1	Applicants are not required to demonstrate normal hearing against a background noise that reproduces or simulates an air traffic control working environment.
Chapter 6 Reference 6.5.4.1.2	Applicants are not required to take a practical hearing test.

<b>ANNEX 2 – RULES OF THE AIR</b>	
<b>Chapter 1</b>	<b>Definitions</b>
Advisory Airspace	Advisory service is provided in terminal radar areas and the outer areas associated with Class C and Class E airspace areas.
Aerodrome Traffic Zone	There are no more Control Zones (Airport Traffic Zones) or Airport Traffic Areas (ATA). In the 7110.65, PCG, Controlled Airspace covers the defined dimensions of airspace. Class D was formerly the ATA (normally a 5NM radius around the airport). The old Control Zones were extensions of the ATA to encompass (ILS) Approach Paths.
Airborne Collision Avoidance System (ACAS)	The U.S. uses “traffic alert collision avoidance system (TCAS).” TCAS is an airborne collision avoidance system based on radar beacon signals and operates independent of ground – based equipment. TCAS – I generates traffic advisories only. TCAS – II generates traffic advisories and resolution (collision avoidance) advisories in the vertical plane.
Air-taxiing	The U.S. uses “hover taxi” for this maneuver above 100 feet above ground level (AGL) and “air taxi” below 100 feet AGL.
Area control centre	The U.S. equivalent facility for an Area Control Centre (ACC) is an Air Route Traffic Control Center (ARTCC).
Area control service	The U.S. does not use the term “area control service” to indicate controlled flight in controlled areas.
Danger area	The term “danger area” is not used within the U.S. or any of its possessions or territories.
Flight information centre	The U.S. does not operate flight information centers (FICs). In the U.S., the services provided by FICs are performed by air traffic control (ATC) facilities, flight service stations (FSSs), and rescue coordination centers (RCCs).
Level	The U.S. uses “altitude” or “flight level” rather than “level” and “cruising altitude” rather than “cruising level.” The term “level” is not used to mean “height,” “altitude,” or “flight level.”
Movement area	In the U.S., the term “movement area” means “the runways, taxiways, and other areas of an airport/heliport which are utilized for taxiing, hover taxiing, air-taxiing, take-off and landing of aircraft, exclusive of loading ramps and parking areas. At those airport/heliports with a tower, specific approval for entry onto the movement area must be obtained from ATC.”  The U.S. does not use an all-inclusive term to denote the movement area plus loading ramps and parking areas of an airport, nor does the U.S. use the term “maneuvering area” in any related context.
Repetitive flight plan (RPL)	The U.S. uses the term “stored flight plan” for domestic operations.
Transition altitude	In U.S. domestic airspace, “transition altitude,” “layer” and “level” are not used; however, in the U.S., flight levels begin at FL 180 where the reference datum of 29.92 inches of mercury is used as the constant atmospheric pressure. Below FL 180, altitudes are based on barometric pressure readings. QNH and QFE altimeter settings are not provided in domestic U.S. airspace.
Visibility	The U.S. defines Visibility as: The ability, as determined by atmospheric conditions and expressed in units of distance, to see and identify prominent unlighted objects by day and prominent lighted objects by night. Visibility is reported as statute miles, hundreds of feet, or meters. The U.S. identifies the following classes of visibility: Flight Visibility, Ground Visibility, Prevailing Visibility, Runway Visibility Value, and Runway Visual Range.
<b>Chapter 3</b>	<b>General Rules</b>
3.1.8	In addition, aircraft shall not be flown in formation flight when passengers are carried for hire.

3.1.10	<p>14 CFR part 101 prescribes rules governing the operation in the United States, of any unmanned free balloon that—</p> <ul style="list-style-type: none"> <li>(i) Carries a payload package that weighs more than four pounds and has a weight/size ratio of more than three ounces per square inch on any surface of the package, determined by dividing the total weight in ounces of the payload package by the area in square inches of its smallest surface;</li> <li>(ii) Carries a payload package that weighs more than six pounds;</li> <li>(iii) Carries a payload, of two or more packages, that weighs more than 12 pounds; or</li> <li>(iv) Uses a rope or other device for suspension of the payload that requires an impact force of more than 50 pounds to separate the suspended payload from the balloon.</li> </ul>
3.2 Note	See difference under “Movement area.”
3.2.3.2 d)	The U.S. national regulations do not require aircraft on the movement area of an airport, whose engines are running, to display lights which indicate that fact from sunset to sunrise.
3.2.5	<p>Unless otherwise authorized or required by ATC, no person may operate an aircraft within a Class B, C, or D surface area except for the purpose of landing at, or taking off from, an airport within that area.</p> <p>In addition, in the case of a helicopter approaching to land, avoid the flow of fixed-wing aircraft.</p> <p>In addition, no person may, within a Class B, C, or D surface area operate an aircraft to, from, or on an airport having a control tower operated by the U.S. unless two-way radio communications are maintained between that aircraft and the control tower.</p>
3.3.1.2	In the U.S., ATC flight plans are not required for VFR flight in Class C, D, or E airspace.
3.3.1.2 e)	Requirements pertaining to filing flight plans for flights operating across U.S. borders and for identification purposes are described in 14 CFR Part 91 (Section 91.84) and Part 99.
3.6.2.2	<p>The United States requires pilots to report changes in the average true airspeed (at cruising altitude) when it varies by 5 percent or 10 knots (whichever is greater) from that filed in the flight plan. However, 14 CFR 91.703 requires pilots to abide by Annex 2 when flying over the high seas. In addition, when complying with speed adjustment assignments, the United States requires pilots to maintain an indicated airspeed within plus or minus 10 knots or 0.02 Mach number of the specified speed.</p>
3.6.2.4	When meteorological conditions fall below the minimum specified for en route VFR flights, the pilot of the aircraft shall not continue his/her flight in such conditions, except in emergency, beyond the extent necessary to return to his/her departure point or to the nearest suitable landing point.
3.6.5.2 (Communication Failure)	<p>Two-way Radio Communications Failure</p> <ul style="list-style-type: none"> <li>a. It is virtually impossible to provide regulations and procedures applicable to all possible situations associated with two-way radio communications failure. During two-way radio communications failure, when confronted by a situation not covered in the regulation, pilots are expected to exercise good judgment in whatever action they elect to take. Should the situation so dictate they should not be reluctant to use the emergency action contained in 14 CFR Section 91.3(b)</li> <li>b. Whether two-way communications failure constitutes an emergency depends on the circumstances, and in any event, it is a determination made by the pilot. 14 CFR Section 91.3(b) authorizes a pilot to deviate from any rule in Subparts A and B to the extent required to meet an emergency.</li> <li>c. In the event of two-way radio communications failure, ATC service will be provided on the basis that the pilot is operating in accordance with 14 CFR Section 91.185. A pilot experiencing two-way communications failure should (unless emergency authority is exercised) comply with 14 CFR Section 91.185 quoted below <ul style="list-style-type: none"> <li>1. General. Unless otherwise authorized by ATC, each pilot who has two-way radio communications failure when operating under IFR shall comply with the rules of this section.</li> </ul> </li> </ul>

3.6.5.2.2	<p>In the event of two-way communications failure in the U.S., ATC service is predicated on pilot compliance with the provisions of 14 CFR Part 91 (Section 91.185). If the failure occurs in IMC, or if VFR cannot be complied with, each pilot is to continue the flight according to the following:</p> <p><b>Route</b></p> <ul style="list-style-type: none"><li>a) By the route assigned in the last ATC clearance received;</li><li>b) If being radar vectored, by the direct route from the point of failure to the fix, route, or airway specified in the vector clearance;</li><li>c) In the absence of an assigned route, by the route that ATC has advised may be expected in a further clearance; or</li><li>d) In the absence of an assigned route or a route that ATC has advised may be expected in a further clearance, by the route filed in the flight plan.</li></ul> <p><b>Altitude</b> – At the <b>HIGHEST</b> of the following altitudes or flight levels <b>FOR THE ROUTE SEGMENT BEING FLOWN</b>:</p> <ul style="list-style-type: none"><li>a) The altitude or flight level assigned in the last ATC clearance received;</li><li>b) The minimum altitude/flight level as prescribed for IFR operations; or</li><li>c) The altitude or flight level ATC has advised may be expected in a further clearance.</li></ul> <p><b>IFR conditions</b> – If the failure occurs in IFR conditions, or if subparagraph 2 above cannot be complied with, each pilot shall continue the flight according to the following:</p> <ul style="list-style-type: none"><li>(a) Route.<ul style="list-style-type: none"><li>(1) By the route assigned in the last ATC clearance received;</li><li>(2) If being radar vectored, by the direct route from the point of radio failure to the fix, route, or airway specified in the vector clearance;</li><li>(3) In the absence of an assigned route, by the route that ATC has advised may be expected in a further clearance; or</li><li>(4) In the absence of an assigned route of a route that ATC has advised may be expected in a further clearance by the route filed in the flight plan.</li></ul></li><li>(b) Altitude. At the <b>HIGHEST</b> of the following altitudes or flight levels <b>FOR THE ROUTE SEGMENT BEING FLOWN</b>:<ul style="list-style-type: none"><li>(1) The altitude or flight level assigned in the last ATC clearance received;</li><li>(2) The minimum altitude (converted, if appropriate) to minimum flight level as prescribed in 14 CFR Section 91.121(c) for IFR operations; or</li><li>(3) The altitude or flight level ATC has advised may be expected in a further clearance.</li></ul></li></ul>
-----------	--

3.6.5.2.2 a)	Annex 2 references maintaining last assigned speed, level, or minimum flight altitude for a specified amount of time depending on radar coverage. 91.185 does not require last assigned speeds and altitudes be maintained for specified amounts of time.
3.9	<p>There is no Class F airspace in the U.S. Basic VFR weather minimums are listed in the table below.</p> <p>Except as otherwise authorized by the appropriate air traffic control unit for special VFR flights within Class B, C, D, or E surface areas, no person may operate an aircraft under VFR when the flight visibility is less, or at a distance from clouds that is less than that prescribed for the corresponding altitude and class of airspace in the table below.</p> <p>Class G Airspace: Notwithstanding the provisions of paragraph a) of this section, the following operations may be conducted in Class G airspace below 1,200 feet above the surface:</p> <ol style="list-style-type: none"><li>1) Helicopter. A helicopter may be operated clear of clouds if operated at a speed that allows the pilot adequate opportunity to see any air traffic or obstruction in time to avoid collision.</li><li>2) Airplane. When the visibility is less than 3 statute miles but not less than 1 statute mile during night hours, an airplane may be operated clear of clouds if operated in an airport traffic pattern within one-half mile of the runway.</li></ol> <p>Except as provided in 4.2, no person may operate an aircraft under VFR within the lateral boundaries of the surface areas of Class B, Class C, Class D, or Class E airspace designated for an airport when the ceiling is less than 1,000 feet.</p> <p>Except as provided in 4.2, no person may take-off or land an aircraft, or enter the traffic pattern area of an airport under VFR, within the lateral boundaries of the surface area of Class B, Class C, Class D, or Class E airspace designed for an airport:</p> <ol style="list-style-type: none"><li>1) unless ground visibility at that airport is at least 3 statute miles; or</li><li>2) if ground visibility is not reported at that airport, unless flight visibility during landing or takeoff, or while operating in the traffic pattern is at least 3 statute miles</li></ol>

**Basic VFR Weather Minimums**

<b>Airspace</b>	<b>Flight Visibility</b>	<b>Distance from Clouds</b>
Class A .....	Not Applicable	Not Applicable
Class B .....	3 statute miles	Clear of Clouds
Class C .....	3 statute miles	500 feet below 1,000 feet above 2,000 feet horizontal
Class D .....	3 statute miles	500 feet below 1,000 feet above 2,000 feet horizontal
Class E Less than 10,000 feet MSL .....	3 statute miles	500 feet below 1,000 feet above 2,000 feet horizontal
At or above 10,000 feet MSL .....	5 statute miles	1,000 feet below 1,000 feet above 1 statute mile horizontal
Class G 1,200 feet or less above the surface (regardless of MSL altitude). For aircraft other than helicopters: Day, except as provided in §91.155(b) .....	1 statute mile	Clear of clouds
Night, except as provided in §91.155(b) .....	3 statute miles	500 feet below 1,000 feet above 2,000 feet horizontal
For helicopters: Day .....	½ statute mile	Clear of clouds
Night, except as provided in §91.155(b) .....	1 statute mile	Clear of clouds
More than 1,200 feet above the surface but less than 10,000 feet MSL. Day .....	1 statute mile	500 feet below 1,000 feet above 2,000 feet horizontal
Night .....	3 statute miles	500 feet below 1,000 feet above 2,000 feet horizontal
More than 1,200 feet above the surface and at or above 10,000 feet MSL. ....	5 statute miles	1,000 feet below 1,000 feet above 1 statute mile horizontal

<b>Chapter 4</b>	<b>Visual Flight Rules</b>
4.2	In the U.S., no person may operate an aircraft beneath the ceiling under VFR within the lateral boundaries of controlled airspace designated to the surface for an airport when the ceiling is less than 1,000 feet. No person may take-off or land an aircraft (other than a helicopter) under special VFR (SVFR) unless ground visibility is at least 1 statute mile or if ground visibility is not reported, unless flight visibility is at least 1 statute mile.  The U.S. restricts the ceiling to 1,000 ft. and ground visibility of 3 miles and greater.
4.3	The U.S. does not prohibit VFR flight between sunset and sunrise.



4.4	<p>In the U.S., VFR flight is not permitted within Class A airspace designated in 14 CFR Part 71 unless otherwise authorized by ATC.</p> <p>In the U.S., an ATC clearance is needed for VFR flight only in Class B airspace area.</p> <p>The U.S. limits VFR flights up to FL 180.</p>
4.5	The U.S. limits VFR flights up to FL 180.
4.7	<p>In addition, grid tracks are not used to determine cruising altitudes in polar areas. True tracks are used to determine cruising levels above FL 230 in the area north of Alaska bounded by the true North Pole to 72°00'00"N, 141°00'00"W; to 72°00'00"N, 158°00'00"W; to 68°00'00"N, 168°58'23"W; to point of beginning. The U.S. has named this area the Anchorage Arctic CTA/FIR for national reference purposes.</p>
4.8	In U.S. Class C and D airspace/areas, an ATC clearance is not required for VFR flights.
<b>Chapter 5</b>	<b>Instrument Flight Rules</b>
5.1.2	<p>In the U.S., minimum altitudes for IFR flights are 2,000 feet above the highest obstacle within a horizontal distance of 4 nautical miles from the course to be flown in mountainous terrain and 1,000 feet above the highest obstacle within a horizontal distance of 4 nautical miles from the course to be flown in non-mountainous terrain.</p>
5.2.2	See difference under paragraph 4.7.
5.3.1	See difference under paragraph 4.7.
<p><b>Further differences which exist by virtue of the fact that the Annex contains no comparable standards for the U.S. national regulations.</b></p>	<p>1) The regulations covering the selection and use of alternate airports in respect to ceiling and visibility minima, require that:</p> <p>Unless otherwise authorized by the FAA Administrator, no person may include an alternate airport in an IFR flight plan unless current weather forecasts indicate that, at the estimated time of arrival at the alternate airport, the ceiling and visibility at that airport will be at or above the alternate airport weather minima.</p> <p>2) Operation under IFR in Class A, B, C, D, or E airspace malfunction reports:</p> <p>a) The pilot-in-command of each aircraft operated in Class A, B, C, D or E airspace under IFR shall report as soon as practical to ATC any malfunctions of navigational, approach, or communication equipment occurring in flight.</p> <p>b) In each report the pilot-in-command shall include:</p> <ol style="list-style-type: none"> <li>1) aircraft identification.</li> <li>2) equipment affected.</li> <li>3) degree to which the capability of the pilot to operate under IFR in the ATC system is impaired; and</li> <li>4) nature and extent of assistance desired from ATC.</li> </ol> <p>3) When an aircraft has been cleared to maintain "VFR conditions on top," the pilot is responsible to fly at an appropriate VFR altitude, comply with VFR visibility and distance from cloud criteria, and to be vigilant so as to see and avoid other aircraft.</p> <p>4) Aircraft speed:</p> <p>a) Unless otherwise authorized by the FAA Administrator, no person may operate an aircraft below 10,000 feet MSL at an indicated airspeed of more than 250 kt (288 m.p.h.).</p> <p>b) Unless otherwise authorized or required by ATC, no person may operate an aircraft within Class B, C, or D surface area at an indicated airspeed of more than 200 kt (230 m.p.h.). This paragraph 4b) does not apply to operations within Class B airspace. Such operations shall comply with paragraph 4a) of this section.</p> <p>c) No person may operate an aircraft in the airspace underlying Class B airspace, or in a VFR corridor designated through Class B airspace, at an indicated airspeed of more than 200 kt (230 m.p.h.).</p> <p>d) If the minimum safe airspeed for any operation is greater than the maximum speed prescribed in this section, the aircraft may be operated at that minimum speed.</p>

<p>5) Operating rules and pilot and equipment requirements for flight in Class B airspace.</p> <p>a) Operating rules. No person may operate an aircraft within Class B airspace except in compliance with the following rules:</p> <p>1) No person may operate an aircraft within Class B airspace unless that person has received an appropriate authorization from ATC prior to operation of that aircraft in that area.</p> <p>2) Unless otherwise authorized by ATC, each person operating a large turbine engine-powered airplane to or from a primary airport shall operate at or above the designated floors while within the lateral limits of the Class B airspace.</p> <p>3) Any person conducting pilot training operations at an airport within Class B airspace shall comply with any procedures established by ATC for such operations in Class B airspace.</p> <p>b) Pilot requirements. No person may take off or land a civil aircraft at an airport within Class B airspace or operate a civil aircraft within Class B airspace unless:</p> <p>1) The pilot-in-command holds at least a private pilot certificate; or</p> <p>2) The aircraft is operated by a student pilot who has met the requirements (14 CFR Part 61 (Section 61.95)).</p> <p>c) Communications and navigation requirements. Unless otherwise authorized by ATC, no person may operate an aircraft within Class B airspace unless that aircraft is equipped with:</p> <p>1) For <b>IFR</b> operations, an operable VOR or TACAN receiver, and</p> <p>2) For <b>all</b> operations, an operable two-way radio capable of communications with ATC on appropriate frequencies for that Class B airspace.</p> <p>d) Transponder requirements. No person may operate an aircraft in Class B airspace unless the aircraft is equipped with the applicable operating transponder and automatic altitude reporting equipment.</p>
<p>6) Operating rules and pilot and equipment requirements for operating in Class C airspace.</p> <p>a) General. For the purpose of this section, the primary airport is the airport designated in 14 CFR Part 71, for which the Class C airspace is designated. A satellite airport is any other airport within the Class C airspace.</p> <p>b) Deviations. An operator may deviate from any provisions of this section under the provisions of an ATC authorization issued by the ATC facility giving jurisdiction of the Class C airspace. ATC may authorize a deviation on a continuing basis or for an individual flight, as appropriate.</p> <p>c) Arrivals and overflights. No person may operate an aircraft in Class C airspace unless two-way radio communication is established with the ATC facility having jurisdiction over the Class C airspace prior to entering that area and is thereafter maintained with the ATC facility having jurisdiction over the Class C airspace while within that area.</p> <p>d) Departures. No person may operate an aircraft within Class C airspace except as follows:</p> <p>1) From the primary airport or satellite airport with an operating control tower, unless two-way radio communication is established and maintained with the control tower, and thereafter as instructed by ATC while operating in the Class C airspace.</p> <p>2) From a satellite airport without an operating control tower, unless two-way radio communication is established as soon as practical after departing and thereafter maintained with the ATC facility having jurisdiction over the Class C airspace.</p> <p>e) Traffic patterns. No person may take off or land an aircraft at a satellite airport within Class C airspace except in compliance with FAA arrival and departure traffic patterns.</p> <p>f) Equipment requirements. Unless otherwise authorized by the ATC facility having jurisdiction over the Class C airspace, no person may operate an aircraft within Class C airspace unless that aircraft is equipped with the applicable equipment specified in 14 CFR Part 91 (Section 91.215).</p>

	<p>7) Except for persons operating gliders below the floor of Class A airspace, no person may operate an aircraft in Class B, C, D, or E airspace of the 48 contiguous States and the District of Columbia above 10,000 feet MSL, excluding that airspace at and below 2,500 feet AGL, unless that aircraft is equipped with an operable radar beacon transponder having at least a Mode 3/A 4096-code capability, replying to Mode 3/A interrogation with the code specified by ATC, and automatic altitude reporting equipment having a Mode C capability that automatically replies to Mode C interrogations by transmitting pressure altitude information in 100-foot increments.</p> <p>8) Compliance with ATC clearances and instructions:</p> <ul style="list-style-type: none"> <li>a) When an ATC clearance has been obtained, no pilot-in-command may deviate from that clearance, except in an emergency, unless an amended clearance is obtained. A pilot-in-command may cancel an IFR flight plan if that pilot is operating in VFR weather conditions outside of Class A airspace. If a pilot is uncertain of the meaning of an ATC clearance, the pilot shall immediately request clarification from ATC.</li> <li>b) Except in an emergency, no person may operate an aircraft contrary to an ATC instruction in an area in which ATC is exercised.</li> <li>c) Each pilot-in-command who, in an emergency, deviates from an ATC clearance or instruction shall notify ATC of that deviation as soon as possible.</li> <li>d) Each pilot-in-command who is given priority by ATC in an emergency shall submit a detailed report of that emergency within 48 hours to the manager of that ATC facility, if requested by ATC.</li> <li>e) Unless otherwise authorized by ATC, no person operating an aircraft may operate that aircraft according to any clearance or instruction that has been issued to the pilot of another aircraft for radar ATC purposes.</li> </ul>
<b>Appendix 1</b>	<b>SIGNALS</b>
4.1.1	<p>The flashing white signal to aircraft in flight, meaning “land at this aerodrome and proceed to apron” is not used in the United States.</p> <p>In addition, the alternating red and green signal to aircraft on the ground or in flight means exercise extreme caution.</p>
<b>Appendix 5</b>	<p><b>UNMANNED FREE BALLOONS</b> (<i>Note.—See Chapter 3, 3.1.10 of the Annex</i>)</p>
1.	<p>14 CFR part 101 prescribes rules governing the operation in the United States, of any unmanned free balloon that—</p> <ul style="list-style-type: none"> <li>(i) Carries a payload package that weighs more than four pounds and has a weight/size ratio of more than three ounces per square inch on any surface of the package, determined by dividing the total weight in ounces of the payload package by the area in square inches of its smallest surface;</li> <li>(ii) Carries a payload package that weighs more than six pounds;</li> <li>(iii) Carries a payload, of two or more packages, that weighs more than 12 pounds; or</li> <li>(iv) Uses a rope or other device for suspension of the payload that requires an impact force of more than 50 pounds to separate the suspended payload from the balloon.</li> </ul>

<b>PANS ATM Doc 4444 16<sup>th</sup> Edition</b>	
<b>CHAPTER 1</b>	<b>DEFINITIONS</b>
Advisory Air-space	The U.S. does not define, it refers to Advisory Service.
Advisory Route	The U.S. does not define, it refers to Advisory Service.
Aerodrome Traffic	The U.S. does not define.
Air Traffic Advisory Service	In the U.S., “Advisory Service” is intended for IFR and VFR aircraft.
Airborne Collision Avoidance System	The U.S. uses traffic alert and collision avoidance system (TCAS).
Aircraft	U.S. uses “Aircraft” to mean the airframe, crew members, or both.
AIRMET	In the U.S., AIRMET stands for Airmen’s Meteorological Information which is a concise description of an occurrence or expected occurrence of specified en route weather phenomena that may affect the safety of aircraft operations, but at intensities lower than those that require the issuance of a SIGMET. An AIRMET may be issued when moderate turbulence, low-level wind shear, strong surface winds greater than 30 knots, moderate icing, freezing level, mountain obscuration, or IFR conditions are occurring or are expected to occur.
Air-report	The U.S. does not normally use the term “air-report.” Pilot weather reports (PIREPs), position, and operational reports are used. PIREPs include reports of strong frontal activity, squall lines, thunderstorms, light to severe icing, wind shear and turbulence (including clear air turbulence) of moderate or greater intensity, volcanic eruptions and volcanic ash clouds, and other conditions pertinent to flight safety. They may include information on ceilings, visibility, thunderstorms, icing of light degree or greater, wind shear and its effect on airspeed, or volcanic ash clouds, but do not usually include air temperature.
Air-taxiing	In the U.S., the term “hover taxi” is sometimes used to indicate the ICAO term “air-taxiing.” In the U.S., air-taxiing is the preferred method for helicopter movements on airports provided ground operations/conditions permit. Additionally, in the U.S., air taxi is used to indicate certain commercial aircraft operations. For those operations, usually a special call sign is used, or the prefix “Tango” is added to the aircraft call sign.
Air Traffic Flow Management	U.S. defines as Air Traffic Control System Command Center.
Altitude	U.S. uses “Altitude” to mean indicated altitude mean sea level (MSL), flight level (FL), or both.
Approval Request	U. S. uses “APREQ.”
Area control service	The U.S. does not use the term “area control service” to indicate controlled flight in controlled areas.
ATS route	In U.S. domestic airspace, the term “ATS route” is not used. Routes in the U.S. include VOR airways, jet routes, substitute routes, off-airway routes, RNAV routes and colored airways. The U.S. also uses instrument departure procedures (DPs), and standard terminal arrivals (STARs).
Control zone	The U.S. uses “surface area” in place of the ICAO term “control zone.” Surface area is defined as the airspace contained by the lateral boundary of the Class B, C, D or E airspace designated for an airport that begins at the surface and extends upward.
Controlled air-space	The U.S. uses the following definition of controlled airspace found in 14 CFR Section 1.1: “Controlled airspace means an airspace of defined dimensions within which air traffic control service is provided to IFR flights and to VFR flights in accordance with the airspace classification.”
Course, bearing, azimuth, heading, and wind direction	U.S. uses “Course, bearing, azimuth, heading, and wind direction” information and it shall always be magnetic unless specifically stated otherwise.

Cruising level	The U.S. uses the term “cruising altitude.”
Decision altitude	Approach with vertical guidance (VNAV).
Emergency Phase	The U.S. does not utilize classification system of emergency phases
Expedite	U.S. uses “ <b>EXPEDITE</b> ” by ATC when <b>prompt compliance</b> is required to avoid the development of an imminent situation. Expedite climb/descent normally indicates to a pilot that the approximate best rate of climb/descent should be used without requiring an exceptional change in aircraft handling characteristics.
Flight information centre	In the U.S., the services provided by flight information centers (FICs) are conducted by air traffic control (ATC) facilities, flight service stations (FSSs), and rescue coordination centers (RCCs).
Ground Effect	The U.S. does not define, but is referred to in “Hover Taxi.”
Holding procedure	In the U.S., a hold procedure is also used during ground operations to keep aircraft within a specified area or at a specified point while awaiting further clearance from air traffic control.
Hot Spot	This is a known term , but not specifically defined in 7110.65.
Level	The U.S. uses “altitude” or “flight level” rather than “level.”
Miles	U.S. uses “Miles” to mean nautical miles unless otherwise specified, and means statute miles in conjunction with visibility.
Minute	U.S. uses “minute plus 30 seconds”, except when time checks are given to the nearest quarter minute.
Movement area	In the U.S., the “movement area” is equivalent to the ICAO “maneuvering area” which does not include parking areas.
Near Parallel Runways	In the U.S., these are not defined as non-intersecting runways aligned 15 degrees or less apart
Position Symbol	The U.S. definition differs in that it refers to mode of tracking, rather than position of an aircraft or vehicle
Procedural Control	The U.S. does not define this as method to provide ATC service without data from an ATS surveillance system.
Procedural Separation	The U.S. does not define as separation used when providing “Procedural Control.”
Runway Incursion	This is a well-known term in NAS, but is not defined in the 7110.65
Standard instrument arrival (STAR)	The U.S. uses the acronym STAR to define a standard terminal arrival.
Standard instrument departure (SID)	The U.S. uses the term departure procedure (DP) in lieu of SID.
Stopway	The U.S. does not define a “stopway” as a rectangular area.
Taxiway a) <i>Aircraft stand taxilane</i> b) <i>Apron taxiway</i> c) <i>Rapid exit taxiway</i>	Ref (a), the US does not define as “portion of an apron designated as a taxiway intended to provide access to aircraft stands only.” Ref (b), the US does not define as “portion of a taxiway system located on an apron, providing taxi route across an apron.” Ref (c), the US defines as High Speed Taxiway.
Terminal control area	In the U.S., the term “terminal control area” has been replaced by “Class B airspace.” Standard IFR services should be provided to IFR aircraft operating in Class B airspace.

Transition altitude, transition layer, and transition level	In U.S. domestic airspace, transition altitude, layer, and level are not used. U.S. flight levels begin at FL 180 where a barometric altimeter setting of 29.92 inches of mercury is used as the constant atmospheric pressure. Below FL 180, altitudes are based on barometric pressure readings.
Uncertainty Phase	The U.S. does not utilize emergency phase classifications.
Visibility	Definitions are different.
Visual Approach	In the U.S., aircrews may execute visual approaches when the pilot has either the airport or the preceding aircraft in sight and is instructed to follow it.
Will	U.S. uses “Will” means futurity, not a requirement for the application of a procedure.
<b>CHAPTER 4</b>	<b>GENERAL PROVISIONS FOR AIR TRAFFIC SERVICES</b>
4.2	In the U.S., flight information and alerting services are provided by ATC facilities, FSSs, and RCCs.
4.3.2.1.1	Transfer of control points vary depending on numerous factors.
4.3.2.1.3	Transfer of control varies.
4.3.2.1	Transfer of control points vary depending on numerous factors.
4.3.3.1	Transfer of control varies.
4.3.3.1a/ b	The U.S. does not “release” aircraft. Handoff is used.
4.4.1	In the U.S., flight information and alerting services are provided by ATC facilities, FSSs, and RCCs.
4.4.1.3	The U.S. uses a flight plan format different from the ICAO model discussed in Appendix 2. The U.S. ATS facilities will transmit ICAO repetitive flight plans (RPLs) even though a different format is used for stored flight plans.
4.4.2.1.1	The U.S. accepts flight plans up to 24 hours prior to Estimated Off –Block Time (EOBT).
4.5.6.2	U.S. ATS controllers do not normally include clearance for transonic acceleration in their ATC clearances.
4.5.7.3 and 4.10.4	In U.S. domestic airspace, transition altitude, layer, and level are not used. U.S. flight levels begin at FL180 where a barometric altimeter setting of 29.92 inches of mercury is used as the constant atmospheric pressure. Below FL 180, altitudes are based on barometric pressure readings. QNH and QFE altimeter settings are not provided in domestic U.S. airspace.
4.5.7.5	The flight crew shall read back to the air traffic controller safety-related parts of ATC clearances.
4.6.1.5	The U.S. allows speed adjustments to be assigned in 5 knot increments.
4.6.3.2	The U.S. uses different speed control phraseologies. Specifically, Doc 4444 uses “Maximum Speed” whereas the US uses “Maximum Forward Speed”. Doc 4444 uses “Minimum Clean Speed” whereas the US uses “Slowest Practical Speed.”
4.6.3.7	In the US, speed control is not to be assigned inside Final Approach Fix or 5 NM from runway end.
4.8.2	U.S. Controller phraseology differs slightly and does not include a time check.
4.8.3	ATS units are not required to advise a pilot who has canceled an IFR flight plan that IMC conditions are likely to be encountered along the route of flight; however, if a pilot informs a controller of a desire to change from <b>IFR</b> to VFR, the controller will request that the pilot contact the appropriate FSS.
4.9.1.1	FAA uses different wake turbulence categories and weight groups for wake turbulence separation minimums.
4.9.1.2	FAA uses different wake turbulence categories and weight groups for wake turbulence separation minimums.  Not all FAA facilities are authorized to use the provisions of FAA JO 7110.126.

4.9.2	In the U.S., the word “heavy” is <b>used in all communications</b> with or about heavy jet aircraft in the terminal environment. In the en route environment, “heavy” is used in all communications with or about heavy jet aircraft with a terminal facility, when the en route center is providing approach control service, when the separation from a following aircraft may become less than five miles by approved procedure, and when issuing traffic advisories.
4.10.1.1, 4.10.1.2, 4.10.4.6	Flight levels (at or above 18,000msl, except oceanic) and in feet below 18,000 ft MSL, including around airports (vs. ICAO QFE – height above field/threshold when near airports).
4.11.2.2 4.11.3 d)	Reporting the assigned speed with each frequency change by pilots is not a requirement. Controllers are required to forward this information to the next controller.
4.11.4	The U.S. has not yet published ATS procedures for the use of Automatic Dependent Surveillance-Contract (ADS-C).
4.11.1.1	The U.S. has different criteria to make position reports. FAA Order JO 7110.65, 5-1-12. Position Reporting.
4.11.1.3	After an aircraft receives the statement “radar contact” from ATC, it discontinues reporting over compulsory reporting points.
4.12.2 and 4.12.3	The U.S. does not normally use the term “air-report.” Pilot weather reports (PIREPs), position, and operational reports are used. PIREPs include reports of strong frontal activity, squall lines, thunderstorms, light to severe icing, wind shear and turbulence (including clear air turbulence) of moderate or greater intensity, volcanic eruptions and volcanic ash clouds, and other conditions pertinent to flight safety. They may include information on ceilings, visibility, thunderstorms, icing of light degree or greater, wind shear and its effect on airspeed, or volcanic ash clouds, but do not usually include air temperature.
4.13.4	The difference is the length of time for retention.
<b>CHAPTER 5</b>	<b>SEPARATION METHODS AND MINIMA</b>
5.2.1	In U.S. airspace, only conflict resolution (not separation) is provided between IFR and VFR operations. Separation is provided between IFR and Special VFR (SVFR) aircraft only within the lateral boundaries of Class B, C, D, or E control zones (the U.S. term is surface areas) below 10,000 feet MSL.
5.2.1.1	In U.S. Class A and B airspace, separation is provided for all aircraft. In U.S. Class C airspace, separation is provided between IFR and SVFR aircraft; conflict resolution is provided between IFR and VFR operations.
5.3.1 and 5.3.4	U.S. rules allow assignment of altitude to second aircraft after first aircraft has been issued climb/descent and is observed or reports leaving that altitude. 7110.65, paragraph 6-6-1, APPLICATION, 6-6-2, EXCEPTIONS.
5.4.1.2.1.2	U.S. Lateral separation criteria and minima values differ somewhat.
5.4.2.2.1.1 c/ d	The U.S. uses 22 kt instead of 20 kt and 44 kt instead of 40 kt.
5.4.2.4.1	FAA uses Mach number technique for application of longitudinal separation with turbojet aircraft only.
5.4.2.5.1	FAA uses Mach number technique for application of longitudinal separation with turbojet aircraft only.
5.4.2.7.3.2 d)2).	The FAA’s Advanced Technologies and Oceanic Procedures (ATOP) automation platform is designed to ensure that separation will not decrease below required minima for same track aircraft should either the reference or maneuvering aircraft turn during the ITP. This allows the controller to issue a clearance to perform an ADS-B ITP climb/descent maneuver if required separation is maintained or increased and either the reference or maneuvering aircraft has a turn in its flight plan.
5.5.2	Whenever the other aircraft concerned are within 5 minutes flying time of the holding area.
5.6	U.S. Allows 2 minute separation standard when courses diverge within 5 minutes after departure.
5.7	U.S. Requires departing aircraft to be established on a course diverging by at least 45 degrees from the reciprocal of the final approach course.

5.8.2.1	<p>FAA uses different wake turbulence categories and differing minima.</p> <p>FAA requires 3 minutes separation for a Large or Heavy aircraft landing behind a Super aircraft.</p>
5.8.3.1	<p>FAA uses different wake turbulence categories and differing minima.</p> <p>For Heavy, Large, or Small aircraft departing behind a Super aircraft, taking off from the same runway or a parallel runway separated by less than 2,500 feet, FAA requires that takeoff clearance may not be issued to following aircraft until 3 minutes after the preceding aircraft begins takeoff roll.</p>
5.8.3.2	<p>FAA Consolidated Wake Turbulence (CWT) is based on nine weight groups. FAA time-based wake turbulence separation minima differs from ICAO standards.</p>
5.8.3.4	<p>FAA Consolidated Wake Turbulence (CWT) is based on nine weight groups. FAA time-based wake turbulence separation minima differs from ICAO standards.</p>
5.8.4.1	<p>The U.S. includes B757 in heavy category for wake turbulence purposes. DOC 4444 does not stipulate.</p> <p>For Heavy, Large, or Small aircraft taking off behind a departing Super aircraft on an intersecting runway or nonintersecting runway if flight paths will cross; FAA requires 3 minutes wake turbulence separation.</p>
5.8.4.2	<p>FAA Consolidated Wake Turbulence (CWT) is based on nine weight groups. FAA time-based wake turbulence separation minima differs from ICAO standards.</p>
5.8.4.3	<p>FAA Consolidated Wake Turbulence (CWT) is based on nine weight groups. FAA time-based wake turbulence separation minima differs from ICAO standards.</p>
5.8.5.2	<p>FAA Consolidated Wake Turbulence (CWT) is based on nine weight groups. FAA time-based wake turbulence separation minima differs from ICAO standards.</p>
<b>CHAPTER 6</b>	<b>SEPARATION IN THE VICINITY OF AERODROMES</b>
6.3.2.4	<p>In the U.S.:</p> <ul style="list-style-type: none"> <li>a) An altitude to maintain is not normally issued in conjunction with a climb via clearance. If no altitude is assigned, pilots should climb to the “Top Altitude” depicted on the SID. ATC will assign an altitude when the “Top Altitude” is identified as “Assigned by ATC”;</li> <li>b) While on a climb via clearance, if a new clearance is issued to an altitude to maintain (for example, “Climb and maintain flight level one eight zero”), all published altitude restrictions on the SID are cancelled;</li> <li>c) A clearance to “climb via SID except maintain” cancels all remaining published altitudes on the SID that are above the cleared altitude;</li> <li>d) A clearance to “climb via SID except cross” instructs pilots to comply with the issued crossing restriction and all other restrictions on the SID;</li> <li>e) The phraseology “climb unrestricted” is not used. A climb and maintain (altitude) authorizes the pilot to climb unrestricted to the assigned altitude.</li> </ul>



6.3.2.5	<p>In the U.S., if the communications failure occurs in IFR conditions, or if VFR cannot be complied with, each pilot shall continue the flight according to the following requirements:</p> <p>Route</p> <ul style="list-style-type: none"> <li>a) By the route assigned in the last ATC clearance received;</li> <li>b) If being radar vectored, by the direct route from the point of failure to the fix, route, or airway specified in the vector clearance;</li> <li>c) In the absence of an assigned route, by the route that ATC has advised may be expected in a further clearance; or</li> <li>d) In the absence of an assigned route or a route that ATC has advised may be expected in a further clearance, by the route filed in the flight plan.</li> </ul> <p>Altitude - At the highest of the following altitudes or flight levels for the route segment being flown:</p> <ul style="list-style-type: none"> <li>a) The altitude or flight level assigned in the last ATC clearance received;</li> <li>b) The minimum altitude as prescribed in 14 CFR Part 91 (Section 91.121(c)) for IFR operations; or</li> <li>c) The altitude or flight level ATC has advised may be expected in a further clearance.</li> </ul>
6.3.3.3	Arriving aircraft – delay of 10 minutes or more.
6.5.2.4	<p>In the U.S.:</p> <ul style="list-style-type: none"> <li>a) A descend via clearance authorizes pilots to descend at pilot discretion to meet published restrictions on a STAR. Pilots are not authorized to descend without being issued an altitude;</li> <li>b) An altitude to maintain is not normally issued in conjunction with a descend via clearance. If no altitude is issued, the pilot is expected to descend to the lowest published altitude on the STAR;</li> <li>c) While on a descend via clearance, if a new clearance is issued to an altitude to maintain (for example, “Descend and maintain flight level two eight zero”), all published altitude restrictions on the STAR are cancelled;</li> <li>d) A clearance to “descend via STAR except maintain” cancels all remaining published altitudes on the STAR that are below the cleared altitude;</li> <li>e) A clearance to “descend via STAR except cross” instructs pilots to comply with the issued crossing restriction and all other restrictions on the STAR;</li> <li>f) The phraseology “descend unrestricted” is not used. A descend and maintain (altitude) authorizes the pilot to descend unrestricted to the assigned altitude.</li> </ul>
6.5.3.1	The 7110.65 does not stipulate flight crew concurrence of Controller initiated Visual Approach.
6.5.3.5	U.S. requires ATC to inform following aircraft behind Heavy/B757 aircraft of manufacturer and model information.
6.5.5.2	Onward clearance time. 7110.65 PG EXPECT FURTHER CLEARANCE (TIME)- The time a pilot can expect to receive clearance beyond a clearance limit.
6.7.3.1.2	U.S. has no criteria for separate radar controllers in conducting Parallel approaches.
6.7.3.2.1 a) Table 6–1	When conducting Dual and Triple Simultaneous Independent Approaches using High Update Rate Surveillance, the FAA allows the minimum distance between runway centerlines to be 3100 feet.
6.7.3.2.1 b)	The U.S. has adopted procedures allowing RNAV equipped aircraft to conduct Independent Parallel Approaches.
6.7.3.2.10	U.S. has no parallel approach obstacle assessment surfaces (PAOAS) Criteria.
6.7.3.2.10	The U.S. has no criteria for a “45 degree track”.
6.7.3.2.11 (a)	The U.S. has no criteria for both controllers to be advised when visual separation is applied.
6.7.3.4.1 (d)	The U.S. has adopted procedures allowing RNAV equipped aircraft to conduct Dependent Parallel approaches.
6.7.3.4.1 (f)	The U.S. requires that adjacent missed approach procedures do not conflict.
6.7.3.6.3 (b)	The U.S. has no surveillance radar approach (SRA).

6.7.3.6.3 (c)	In the U.S., aircrews may execute visual approaches when the pilot has either the airport or the preceding aircraft in sight and is instructed to follow it. A contact approach is one wherein an aircraft on an IFR flight plan, having an air traffic control authorization, operating clear of clouds with at least 1 mile flight visibility and a reasonable expectation of continuing to the destination airport by visual reference in those conditions, may deviate from the instrument approach procedure and proceed to the destination airport by visual reference to the surface. This approach will only be authorized when requested by the pilot and the reported ground visibility at the destination airport is at least 1 statute mile.
<b>CHAPTER 7</b>	<b>PROCEDURES FOR AERODROME CONTROL SERVICE</b>
7.4.1.1	U.S. has no start up procedures, taxi clearance.
7.4.1.2.1 (f)	U.S. does not require time check prior to taxi.
7.6.3.2.3.2	In the U.S., for movements of other than aircraft traffic (i.e., vehicles, equipment, and personnel), steady green means cleared to cross, proceed, go; flashing green is not applicable; flashing white means return to starting point on airport; and alternating red and green means a general warning signal to exercise extreme caution.
7.6.3.2.3.3	U.S. controllers do not flash runway or taxiway lights to instruct aircraft to “vacate the runway and observe the tower for light signal.”
7.10.2	In the U.S., landing clearance to a succeeding aircraft in a landing sequence need not be withheld if the controller observes the positions of the aircraft and determines that prescribed runway separation will exist when the aircraft crosses the landing threshold. Controllers issue traffic information to the succeeding aircraft if it has not previously been reported.
7.11.4 and 7.11.6	U.S. category 1, 2, & 3 (SRS) aircraft weights differ. Separation standards are greater, due to increased size and weight categories.
7.13.1.1.2	U.S. does not specify separation standards on taxiways.
7.15	Special VFR operations may be conducted in the U.S. under the following weather minimums and requirements below 10,000 feet MSL within the airspace contained by the upward extension of the lateral boundaries of the controlled airspace designated to the surface for an airport. These minimums and requirements are found in 14 CFR Section 91.157.  Special VFR operations may only be conducted: (1) With an ATC clearance; (2) Clear of clouds; (3) Except for helicopters, when flight visibility is at least 1 statute mile; and (4) Except for helicopters, between sunrise and sunset (or in Alaska, when the sun is 6 degrees or more below the horizon) unless: (i) The person being granted the ATC clearance meets the applicable requirements for instrument flight; and (ii) The aircraft is equipped as required in 14 CFR Sec. 91.205(d).
7.15	No person may take off or land an aircraft (other than a helicopter) under special VFR: (1) Unless ground visibility is at least 1 statute mile; or (2) If ground visibility is not reported, unless flight visibility is at least 1 statute mile.
<b>CHAPTER 8</b>	<b>ATS SURVEILLANCE SERVICES</b>
8.5.5.1	U.S. validation of mode C readouts allow up to 300 feet variance from pilot reported altitudes.
8.6.5.2	The U.S. has not implemented cold temperature corrections to the radar minimum vectoring altitude.
8.7.3.2 (b)	The U.S. only allows visual observance of runway turn-off points.
8.7.3.4	Separate a Heavy aircraft operating directly behind a Super aircraft or following a Super aircraft conducting an instrument approach by 6 miles unless the Super aircraft is operating above FL 240 and above 250 knots.  Consider parallel runways less than 2,500 feet apart as a single runway because of the possible effects of wake

8.7.3.5	FAA Consolidated Wake Turbulence (CWT) is based on nine weight groups. FAA distance-based wake turbulence separation minima differs from ICAO standards.
8.7.3.6	Separate a Heavy aircraft operating directly behind a Super aircraft or following a Super aircraft conducting an instrument approach by 6 miles unless the Super aircraft is operating above FL 240 and above 250 knots.  Consider parallel runways less than 2,500 feet apart as a single runway because of the possible effects of wake.
8.8.3.2	In the U.S., if the communications failure occurs in IFR conditions, or if VFR cannot be complied with, each pilot shall continue the flight according to the following requirements:  Route a) By the route assigned in the last ATC clearance received; b) If being radar vectored, by the direct route from the point of failure to the fix, route, or airway specified in the vector clearance; c) In the absence of an assigned route, by the route that ATC has advised may be expected in a further clearance; or d) In the absence of an assigned route or a route that ATC has advised may be expected in a further clearance, by the route filed in the flight plan.  Altitude – At the highest of the following altitudes or flight levels for the route segment being flown: a) The altitude or flight level assigned in the last ATC clearance received; b) The minimum altitude as prescribed in 14 CFR Part 91 (Section 91.121(c)) for IFR operations; or c) The altitude or flight level ATC has advised may be expected in a further clearance.
8.8.4.2	The U.S. does not specify that applicable separation can be utilized during emergency situations.
8.9.3.6	U.S. specifies maximum intercept angle of 30 degrees for fixed wing aircraft vectored to final approach course.
<b>CHAPTER 9</b>	<b>FLIGHT INFORMATION SERVICE AND ALERTING SERVICE</b>
9.1.3.2.1	ATC facilities in the CONUS will no longer receive AIRMET advisories to broadcast and will therefore not broadcast AIRMETS; operators have other methods, such as the G–AIRMET, of receiving AIRMET information over the CONUS.
9.1.3.7	The U.S. does not have special procedures for the transmission of information to supersonic aircraft.
9.1.4.1.1	Class F airspace is not used in the U.S. Traffic advisories are provided in Class C airspace and, workload permitting, in Class D, Class E, and Class G airspace.
9.2.1.2	The U.S. does not use “operations normal” or “QRU” messages. U.S. controllers are not normally familiar with the term “uncertainty phase.”
<b>CHAPTER 10</b>	<b>COORDINATION</b>
10.1.3.1	Except for a VFR aircraft practicing an instrument approach, an IFR approach clearance in the U.S. automatically authorizes the aircraft to execute the missed approach procedure depicted for the instrument approach being flown. No additional coordination is normally needed between the approach and en route controllers. Once an aircraft commences a missed approach, it may be radar vectored.
10.1.4.2.2	U.S. does not require ETA to be forwarded at least 15 minutes prior to ETA.
<b>CHAPTER 11</b>	<b>AIR TRAFFIC SERVICES MESSAGES</b>
11.1.2	U.S. uses different emergency messages. FAA Order JO 7110.10, Chapter 3, Emergency Services.
11.4.2.3.6	The existing U.S. ATS automation system does not process logical acknowledgment messages (LAMs).

CHAPTER 12	PHRASEOLOGIES
12.2.7	<p>US ATC does not allow conditional clearances described for example: “SAS 941, BEHIND DC9 ON SHORT FINAL, LINE UP BEHIND.”</p> <p><i>Note – This implies the need for the aircraft receiving the conditional clearance to identify the aircraft or vehicle causing the conditional clearance.</i></p>
<p>12.3.1.2 m) General to require action when convenient</p> <p>m) WHEN READY (<i>instruction</i>);</p>	<p>U.S. does not use this phraseology. 7110.65 4-5-7. ALTITUDE INFORMATION PHRASEOLOGY CLIMB/ DESCEND AT PILOT’S DISCRETION 1. The pilot is expected to commence descent upon receipt of the clearance and to descend at the suggested rates specified in the AIM, 4-4-9, Adherence to Clearance, until reaching FL 280. At that point, the pilot is authorized to continue descent to FL 240 within the context of the term “at pilot’s discretion” as described in the AIM. f. When the “pilot’s discretion” portion of a climb/descent clearance is being canceled by assigning a new altitude, inform the pilot that the new altitude is an “amended altitude.” EXAMPLE- “American Eighty Three, amend altitude, descend and maintain Flight Level two six zero.”</p>
<p>12.3.1.2 (n) MAINTAIN OWN SEPARATION AND VMC [FROM (<i>level</i>) [TO (<i>level</i>)]; and</p> <p>(o) MAINTAIN OWN SEPARATION AND VMC ABOVE (<i>or</i> BELOW, <i>or</i> TO) (<i>level</i>);</p>	<p>U.S. does not use “maintain own separation and VMC ’from,’ ’above,’ or ’below’ . . .,” U.S. controllers say “maintain visual separation ’from’ that traffic.” Meteorological conditions are expressed in terms of visibility, distance from cloud, and ceiling, equal to or better than specified minima.</p>
<p>12.3.1.2 aa) Clearance to cancel level restriction(s) of the vertical profile of a SID during climb.”</p> <p>(z) CLIMB TO (<i>level</i>) [LEVEL RESTRICTION(S) (<i>SID designator</i>) CANCELLED (<i>or</i>) LEVEL RESTRICTION(S) (<i>SID designator</i>) AT (<i>point</i>) CANCELLED];</p>	<p>The U.S. does not have specific phraseology examples that cover this issue. However, phraseology contained in the 7110.65 covers how to change altitudes and altitude restriction in a SID.</p>

<p>12.3.1.2 ff) Clearance to cancel level restriction(s) of the vertical profile of a STAR during descent. <b>gg)</b> DESCEND TO <i>(level)</i> [LEVEL RESTRICTION(S) <i>(STAR designator)</i> CANCELLED <i>(or)</i> LEVEL RESTRICTION(S) <i>(STAR designator)</i> AT <i>(point)</i> CANCELLED].</p>	<p>The U.S. does not have specific phraseology examples that cover this issue. However, phraseology contained in the 7110.65 covers how to amend or cancel altitude restrictions.</p>
<p>12.3.1.2 a) 2) TO AND MAINTAIN BLOCK <i>(level)</i> TO <i>(level)</i>;</p>	<p>U.S. uses “MAINTAIN BLOCK (altitude) THROUGH (altitude).” 7110.65, Para 4-5-7. g. ALTITUDE INFORMATION</p>
<p>12.3.1.6 CHANGE OF CALL SIGN</p>	<p>U.S. has no phraseology or approved procedure to advise aircraft to change call signs. The U.S. has procedures for a duplicate aircraft identification watch and notification to airline operators but does not publish national procedures for on-the-spot temporary changes to aircraft call signs in accordance with ICAO guidelines.</p>
<p>12.3.1.7 TRAFFIC INFORMATION</p>	<p>The U.S. requires issuance of azimuth, distance, direction, type, and altitude.</p>
<p>12.3.1.8 b) METEOROLOGICAL CONDITIONS</p>	<p>In the U.S., the criterion for a variable wind is: wind speed greater than 6 kt and direction varies by 60 degrees or more. If the wind is &gt;1 kt but &lt;6 kt, the wind direction may be replaced by “VRB” followed by the speed or reported as observed. “VRB” would be spoken as “wind variable at &lt;speed&gt;.”</p>
<p>12.3.1.8 d), e), and f) METEOROLOGICAL CONDITIONS</p>	<p>U.S. controllers do not give wind speed, visibility, or RVR values in metric terms. RVR values are given in 100- or 200-foot increments while RW values are given in Venule increments.</p>
<p>12.3.1.8 j)</p>	<p>U.S. controllers do not use the term “CAVOK.” However, the ceiling/sky condition, visibility, and obstructions to vision may be omitted if the ceiling is above 5,000 feet and the visibility is more than 5 miles.</p>
<p>12.3.1.8 l) and m)</p>	<p>In the US, controllers and pilots exchange altimeter setting by reference to inches Hg. ICAO describes altimeter setting by reference to millibars, QNH or QFE. (where QNH – above mean sea level and QFE – height above aerodrome)</p>
<p>12.3.1.11 g)</p>	<p>U.S. use BRAKING ACTION terms “good,” “fair,” “poor,” “nil,” or combination of these terms. “Braking action fair to poor, reported by a heavy D-C Ten.”. 7110.65, Para 3-3-4.</p>

<p>12.3.2.2 INDICATION OF ROUTE AND CLEAR- ANCE LIMIT</p>	<p>U.S. will issue a clearance “direct” to a point on the previously issued route. PHRASEOLOGY CLEARED DIRECT (fix). NOTE Clearances authorizing “direct” to a point on a previously issued route do not require the phrase “rest of route unchanged.” However, it must be understood where the previously cleared route is resumed. When necessary, “rest of route unchanged” may be used to clarify routing. 7110.65, paragraph 4-4-1. ROUTE USE &amp; 4-2-5. ROUTE OR ALTI-TUDE AMENDMENTS 3.</p>
<p>12.3.2.4 Specification of Cruise Levels, (c) Cruise climb between. (levels) or above (level)</p>	<p>The U.S. does not have equivalent cruise climb between levels/altitudes. However, in ICAO regions for supersonic flight 8- 8-3a(1), U.S. has adopted ICAO phraseology.</p>
<p>12.3.2.5</p>	<p>U.S. has no phraseology or instruction for emergency descent:</p>
<p>12.3.2.8, Separation In- structions (b) ADVISE IF ABLE TO CROSS (signi- ficant point) AT (time or level)</p>	<p>U.S. has no phraseology for “ADVISE IF ABLE.” U.S. does have phraseology “Advise if un-able...”</p>
<p>12.3.4.7, Taxi procedures, after landing (n), (o), &amp; (p)</p>	<p>U.S. has no phraseology using “BACKTRACK.” U.S. does use BACK-TAXI (7110.65) – A term used by air traffic controllers to taxi an aircraft on the runway opposite to the traffic flow. The aircraft may be instructed to back-taxi to the beginning of the runway or at some point before reaching the runway end for the purpose of departure or to exit the runway.</p>
<p>12.3.4.11  TAKE-OFF CLEARANCE when take-off clearance has not been com- plied with  c) Vacate  12.3.4.20 RUN- WAY VACAT- ING AND COMMUNIC- ATIONS AFTER LANDING  b)</p>	<p>U.S. uses <b>CLEAR OF THE RUNWAY</b> <b>a.</b> Taxiing aircraft, which is approaching a runway, is clear of the runway when all parts of the U.S. uses aircraft are held short of the applicable runway holding position marking. <b>b.</b> A pilot or controller may consider an aircraft, which is exiting or crossing a runway, to be clear of the runway when all parts of the aircraft are beyond the runway edge and there are no restrictions to its continued movement beyond the applicable runway holding position marking. <b>c.</b> Pilots and controllers shall exercise good judgment to ensure that adequate separation exists between all aircraft on runways and taxiways at airports with inadequate runway edge lines or holding position markings.</p>

<p>12.3.4.11 (e) HOLD POSI- TION, CAN- CEL TAKE- OFF I SAY AGAIN CAN- CEL TAKE- OFF (<i>reasons</i>);</p>	<p>U.S. uses different phraseology to cancel a take off.</p> <p>3-9-10. CANCELLATION OF TAKEOFF CLEARANCE PHRASEOLOGY If circumstances require, cancel a previously issued take-off clearance and, when appropriate, in- form the aircraft of the reason.</p> <p><b>PHRASEOLOGY</b> <i>CANCEL TAKEOFF CLEARANCE (reason)</i></p>
<p>12.3.5.7 a) EXPEDITE CLEARANCE (<i>aircraft call sign</i>) EXPEC- TED DEPARTURE FROM (<i>place</i>) AT (<i>time</i>); b) EXPEDITE CLEARANCE (<i>aircraft call sign</i>) [ESTIM- ATED] OVER (<i>place</i>) AT (<i>time</i>) RE- QUESTS (<i>level or route, etc.</i>).</p>	<p>U.S. has no phraseology to expedite clearance.</p>
<p>12.3.5.6 HAN- DOVER</p>	<p>U.S. does not use radar handover. 7110.65, Para 5-4-3. METHODS PHRASEOLOGY HAN- DOFF/ POINT OUT/TRAFFIC (aircraft position) (aircraft ID),or (discrete beacon code point out only) (altitude, restrictions, and other appropriate information, if applicable). c. When receiving a handoff, point out, or traffic restrictions, respond to the transferring controller as follows: PHRAS- EOLOGY- (Aircraft ID) (restrictions, if applicable) RADAR CONTACT, or (aircraft ID or discrete beacon code) (restrictions, if applicable) POINT OUT APPROVED, or TRAFFIC OBSERVED,</p>
<p>12.4.1.1 IDENTIFICA- TION OF AIR- CRAFT f)</p>	<p>U.S. controllers do not say “will shortly lose identification” or “identification lost.” 7110.65, Para 5-3-7 5-3-7. IDENTIFICATION STATUS a. Inform an aircraft of radar contact when: 1. Initial radar identification in the ATC system is es- tablished. 2. Subsequent to loss of radar contact or terminating radar service, radar identification is re-estab- lished. <b>PHRASEOLOGY</b> <i>RADAR CONTACT (position if required).</i> b. Inform an aircraft when radar contact is lost. <b>PHRASEOLOGY</b> <i>RADAR CONTACT LOST (alternative instructions when required).</i></p>

<p>12.4.2.1 VECTORIZING FOR AP- PROACH (b)</p>	<p>U.S. would use “airport or runway” rather than “field.” 7-4-2. VECTORS FOR VISUAL APPROACH PHRASEOLOGY- (ACID) FLY HEADING OR TURN RIGHT/LEFT HEADING (degrees) VECTOR FOR VISUAL APPROACH TO (airport name). 7110.65, Para 5-11-2, VISUAL REFERENCE REPORT: Aircraft may be requested to report the runway, approach/runway lights, or airport in sight. Helicopters making a “point-in-space” approach may be requested to report when able to proceed to the landing area by visual reference to a prescribed surface route. <i>PHRASEOLOGY</i> <i>REPORT</i> (runway, approach/runway lights or airport) <i>IN SIGHT.</i> <i>REPORT WHEN ABLE TO PROCEED VISUALLY TO AIRPORT/HELIPORT.</i></p>
<p>12.4.2.4.2 a) COMMENCE DESCENT NOW [TO MAINTAIN A (number) DE- GREE GLIDE PATH]</p>	<p>The U.S uses only “begin descent” and does not speak to “Maintain a (number) Degree Glide Path.”</p>
<p>12.4.2.5.1 PAR APPROACH</p>	<p>U.S. controllers say “this will be a P-A-R/surveillance approach to runway (number) or airport/runway (number) or airport/heliport.” U.S. controllers do not say “approach completed.” U.S. controllers say “your missed approach procedure is (missed approach procedure)” and, if needed, “execute missed approach.” For PAR approaches, U.S. controllers say “begin descent” and for surveillance approaches, U.S. controllers say “descend to your minimum descent altitude.” 7110.65, Para 5-12-8. APPROACH GUIDANCE TERMINATION lights in sight and requested to or advised that he/she will proceed visually, and has been instructed to proceed visually, all PAR approach procedures shall be discontinued. d. Continue to monitor final approach and frequency. Pilots shall remain on final controller’s frequency until touchdown or otherwise instructed. 5-12-9. COMMUNICATION TRANSFER PHRASEOLOGY CONTACT (terminal control function) (frequency, if required) AFTER LANDING</p>
<p>12.4.2.4.4 CHECKS; (a)</p>	<p>U.S. uses “CHECK WHEELS DOWN”. 7110.65, Par 2-1-24. WHEELS DOWN CHECK PHRASEOLOGY</p>
<p>12.4.2.5.8 MISSED APPROACH a)</p>	<p>US ATC does not allow conditional clearances described.</p>
<p>12.4.3.12 and 12.4.3.13</p>	<p>U.S., for aircraft above FL 180, U.S. controllers would say, “confirm using two niner niner two as your altimeter setting, verify altitude” or “stop altitude squawk” “stop altitude squawk; altitude differs by (number) feet.” U.S. controllers would not say “stop squawk Charlie.” 7110.6, Para 5-2-22. BEACON TERMINATION Inform an aircraft when you want it to turn off its transponder.</p>
<p>12.3.4.13 - ENTERING AN AERO- DROME TRAFFIC CIRCUIT b)</p>	<p>U.S. uses PHRASEOLOGY: ENTER LEFT/RIGHT BASE. STRAIGHT-IN. MAKE STRAIGHT-IN. STRAIGHT-IN APPROVED. RIGHT TRAFFIC. MAKE RIGHT TRAFFIC. RIGHT TRAFFIC APPROVED. CONTINUE. b. Runway in use. c. Surface wind. d. Altimeter setting. REFERENCE FAA Order 7110.65, Current Settings, Para 2-7-1. e. Any supplementary information. f. Clearance to land. g. Requests for additional position reports. Use prominent geographical fixes which can be easily recognized from the air, preferably those depicted on sectional charts. This does not preclude the use of the legs of the traffic pattern as reporting points.</p>
<p>12.4.3.14</p>	<p>U.S. controllers would say “verify at (altitude)” and/or “verify assigned altitude.” 7110.65 Para, 5-2-17. 1. Issue the correct altimeter setting and confirm the pilot has accurately reported the altitude. PHRASEOLOGY- (Location) ALTIMETER (appropriate altimeter), VERIFY ALTITUDE.</p>
<p>12.6.1 Alerting phraseologies</p>	<p>U.S. controllers would issue MEA/MVA/MOCA/MIA instead of QNH. 7110.65.</p>



<b>CHAPTER 15</b>	<b>PROCEDURES RELATED TO EMERGENICES, COMMUNICATION FAILURE AND CONTINGENCIES</b>
15.1.3 Unlawful interference and aircraft bomb threat	U.S. has difference updated. 5–2–13, Code Monitor Note 1. & 2. “10–2–6 HIJACKED AIRCRAFT 10–2–6. HIJACKED AIRCRAFT Hijack attempts or actual events are a matter of national security and require special handling. Policy and procedures for hijack situations are detailed in FAA Order JO 7610.4, Special Operations. FAA Order JO 7610.4 describes reporting requirements, air crew procedures, air traffic procedures and escort or interceptor procedures for hijack situations.  REFERENCE: FAA Order JO 7610.4, Hijacked/Suspicious Aircraft Reporting and Procedures, Chapter 7. FAA Order 7110.65, Code Monitor, paragraph 5–2–13.
15.3.3 b) 1, 2	7110.65 defers to the AIM for what to expect an aircraft to do when loss of two-way communication has been encountered. The expectations in the AIM differ from what a pilot is expected to do in accordance with PANS-ATM 15.3.3 b) 1 and 2.  The U.S. does not specify a time that an aircraft would maintain its last assigned heading, speed, or altitude. PANS-ATM uses 20 min. in a non-radar environment and 7 min. in a radar environment.
15.3.10	When neither communications nor radar contact can be established for 30 minutes (or prior, if appropriate), U.S. controllers will consider an aircraft overdue and will initiate overdue aircraft procedures including reporting to the ARTCC or FSS.
15.4.1	U.S. does not use the terms “strayed” or “unidentified” aircraft. 7110.65, paragraph 10-3-1. <b>OVERDUE AIRCRAFT</b>
15.5.3.2	Separate known aircraft from the aircraft dumping fuel as follows: a. IFR aircraft by one of the following: 1. <i>1,000 feet</i> above it; or in accordance with paragraph 4–5–1, Vertical Separation Minima, whichever is greater. 2. 2,000 feet below it. 3. 5 miles radar. 4. 5 miles laterally. b. VFR radar-identified aircraft by <i>5 miles</i> and in accordance with paragraph 5–6–1, Application.
15.7.1.1	The PANS-ATM states: “If, during an emergency situation, it is not possible to ensure that the applicable horizontal separation can be maintained, emergency separation of half the applicable vertical separation minimum may be used” Pilots must be advised that emergency separation is being applied and traffic information must be given.  There is no equivalent emergency separation procedure in the U.S.
<b>APPENDIX 1</b>	<b>INSTRUCTIONS FOR AIR-REPORTING BY VOICE COMMUNICATIONS</b>
AIREP Form of Air-report	U.S. uses Pilot Reports (UAs), or Urgent Pilot Reports (UUAs).
<b>APPENDIX 2</b>	<b>FLIGHT PLAN</b>
ITEM 9	ICAO aircraft wake turbulence categories (heavy, medium, light) and FAA weight classes (heavy, large, small) differ. Also, for landing aircraft, wake turbulence separation is defined differently. The U.S. makes special provisions for any aircraft landing behind a B-757 (4 miles for a large aircraft behind or 5 miles for a small aircraft behind).
ITEM 15	U.S. ATS units do not accept cruising speeds nor filed altitudes/flight levels in metric terms. The U.S. accepts filed Mach Number expressed as M followed by 3 figures.
ITEM 18	The U.S. accepts the non-standard indicator IRMK/in filed flight plans.

<b>APPENDIX 3</b>	<b>AIR TRAFFIC SERVICES MESSAGES</b>
1.1.1	See Part XI, ATS Messages, 1.3. 1.3 Composition of the standard types of message. The composition of each standard type of message, expressed as a standardized sequence of fields of data, shall be as prescribed in the reference table on page A3-33. Each message shall contain all the fields prescribed.
1.6.2	See Part XII, Phraseologies, 2.8.
1.8.1 (Field Type 3), (Field Type 15), and (Field Type 18).	See Appendix 2, Flight Plan, 2.2 (Item 15) and 2.2 (Item 18).
2.1, 2.4.5, 2.5	See Part XI, ATS Messages 1.3.
<b>APPENDIX 4</b>	<b>AIR TRAFFIC INCIDENT REPORT</b>
Appendix 4	U.S. has their accident/incident report in FAA Order JO 8020.16C.
<b>APPENDIX 6</b>	<b>ATS INTERFACILITY DATA COMMUNICATIONS (AIDC) MESSAGES</b>
1. INTRODUCTION 1.1 General	7110.65; 8-2-3. AIR TRAFFIC SERVICES INTERFACILITY DATA COMMUNICATIONS (AIDC) Where interfacility data communications capability has been implemented, its use for ATC coordination should be accomplished in accordance with regional Interface Control Documents, and supported by letters of agreement between the facilities concerned.

<b>ANNEX 3 – METEOROLOGICAL SERVICE FOR INTERNATIONAL AIR NAVIGATION</b>	
<b>PART I (Core SARPs)</b>	
<b>Chapter 2</b>	<b>General Provisions</b>
2.2	The U.S. has implemented a quality management system (QMS) for the majority of the meteorological information supplied to users. WAFC Washington and MWO Kansas City (a.k.a. Aviation Weather Center) are ISO 9000. MWOs Anchorage and Honolulu and all 122 Weather Forecast Offices have a QMS that is governed under the following National Weather Service (NWS) directives: NWS Instruction 10–1601 (Verification), NWS Instruction 10–1602 (Service Evaluation), NWS Instruction 10–1606 (Service Assessment), NWS Instruction 10–1607 (Office Evaluation), and NWS Instruction 10–815 (Aviation Meteorologist Training and Competencies). No QMS is in place for the augmentation of the surface observing program.
<b>Chapter 3</b>	<b>World Area Forecast System and Meteorological Offices</b>
3.2.1	SIGWX forecasts are not disseminated in IWXXM form (Appendix 2, 1.2.1.3).
3.7 b)	Tropical Cyclone Advisories issued by Miami and Honolulu TCACs differ from Table A2–2 in Appendix 2 as they contain forecasts valid at 3–, 9–, 15– 21– and 27–hours instead of 6–, 12–, 18–, and 24–hours.
3.8.1 a) 2)	Space weather advisories are not issued for communication via satellite (SATCOM).
<b>Chapter 4</b>	<b>Meteorological Observations and Reports</b>
4.3.2 a)	The U.S. does not issue local routine reports or local special reports. This difference is applicable to subsequent paragraphs that relate to the provision of local routine and special reports in Annex 3. The U.S. provides METAR to departing and arriving aircraft and provides wind and altimeter information in accordance with Federal Aviation Administration (FAA) Order JO 7110.65Y Section 9 (3–9–1) and Section 10 (3–10–1).
4.5.1 d)	This field is also used to denote a correction to the METAR/SPECI by “COR.”
4.6.2.1	The U.S. reports visibility in statute miles.
4.6.3.3	RVR values in the METAR/SPECI code forms are reported in feet.
4.6.4.1	The U.S. automated surface observing systems (ASOS, AWOS) do not generate an automated report for the occurrence of drizzle or freezing drizzle. The ASOS does allow the manual augmentation of these elements to the observations.
4.6.7	The U.S. provides atmospheric pressure in inches of mercury. METAR and SPECI contains an Altimeter Setting (A) instead of QNH, for example, A3010 for 30.10 inches of mercury. The U.S. does not provide QFE.
<b>Chapter 5</b>	<b>Aircraft observations and reports</b>
5.5	Urgent Pilot Reports (UUA) are used in lieu of Special Aircraft Observations, to include Hail, Low Level Wind Shear (within 2,000 ft of surface), severe icing, severe and extreme turbulence, tornado, funnel cloud or waterspout, and volcanic eruption and/or volcanic ash. In addition, Pilot Reports (UA) and UAA identify the location of the weather phenomenon by NAVAIDS.  Pilot Reports are used in lieu of Special Aircraft Observations, to include moderate turbulence and moderate icing. Braking action may be included in the remarks section of the UUA/UA, but is reported to air traffic control when worse than reported.
<b>Chapter 6</b>	<b>Forecasts</b>
6.3.1	Landing forecasts are provided by the TAF.
6.3.3	The U.S. does not provide trend forecasts.
6.5	The U.S. provides an Area Forecast (FA) and Graphical Forecast for Aviation (GFA) in place of a GAMET. The FA is provided by MWOs Anchorage and Honolulu while the GFA is provided by WFO Kansas City. The format and content of the FA and GFA differs from the GAMET.  The FA and GFA are valid from the surface up to FL450. The GFA is a web–based interactive information service.

<b>Chapter 7</b>	<b>SIGMET and AIRMET Information, Aerodrome Warnings and Wind Shear Warnings</b>
7.2.1	The vertical domain of U.S. AIRMETs is from the surface up to FL450. The content, order, and format of U.S. AIRMETs are not in accordance with Table A6–1A due to national practices, which are described in National Weather Service Instruction 10–811. Traditional Alphanumeric Code AIRMETs are no longer in use over the contiguous U.S., but continue to be used over Alaska and Hawaii. The AIRMET sequence number is not restricted to FIRs. AIRMETs in the U.S. are issued on a routine schedule when moderate turbulence, non-convective low-level wind shear, strong surface winds greater than 30 knots, moderate icing, freezing level, mountain obscuration, or IFR conditions are occurring or are expected to occur. The US does not issue AIRMETs for thunderstorms. AIRMET information is not restricted to FL100 and below and can be provided up to FL450 depending on the phenomena. The U.S. does not use flight level (FL) when describing the altitudes in AIRMETs except for those above FL180. The U.S. uses VORs instead of latitude and longitude to describe the area within an AIRMET.
7.2.3	AIRMETs over the conterminous U.S. (CONUS) and Hawaii are valid for 6 hours and are issued every 6 hours on a scheduled basis. AIRMETs over Alaska are valid for 8 hours and are issued every 8 hours on a scheduled basis. The vertical domain of AIRMETs is from the surface up to FL450. The U.S. also provides a graphical version of the AIRMET (G–AIRMET) that contains 3–hourly time steps valid from 0–hour to 12–hours.
7.4.1	The U.S. does not provide wind shear warnings. The U.S. believes wind shear alerts are timelier to flight crews in landing and takeoff than wind shear warnings and thus provide a greater level of safety. In addition, the information is duplicative in nature in that wind shear warnings could be delayed while wind shear alerts are provided via automated systems that allow for immediate data link to flight crews through ATS systems.
<b>Chapter 9</b>	<b>Service for operators and flight crew members</b>
9.2.3 & 9.2.4	U.S. meteorological offices have no means to communicate directly to flight crews if there is a divergence in the forecast from what is provided in the flight document folder.
9.3.3	U.S. meteorological offices have no means to provide updates to flight document folders or to contact the operator.
<b>PART II</b>	<b>APPENDICES and ATTACHMENTS</b>
<b>APPENDIX 2</b>	<b>Technical specifications related to global systems, supporting centers and meteorological offices</b>
Table A2–2	U.S. TCACs do not provide observed CB clouds in the tropical cyclone advisory message.
5.1.4	U.S. TCACs do not provide observed CB clouds in the tropical cyclone advisory (TCA) message. The U.S. does not provide a graphical version of the TCA.
<b>APPENDIX 3</b>	<b>Technical specifications related to meteorological observations and reports</b>
2.1.2	U.S. METARs and SPECIs are not issued in accordance with Table A3–2 due to national practices, which are described in FAA Order JO 7900.5 and Federal Meteorological Handbook No. 1 (FMH–1). Ranges and resolution for numerical elements included in METAR and SPECI differ from Table A3–5.
2.2	The U.S. does not use the term CAVOK in meteorological reports.
2.3	U.S. practices require SPECI for wind shift when wind direction changes by 45 degrees or more in less than 15 minutes and the wind speed is 10 knots or more throughout the wind shift. Practices do not require SPECI for increases of mean surface wind speed. Practices require SPECI for squall, where squall is defined as a strong wind characterized by a sudden onset in which the wind speed increases at least 16 knots and is sustained at least 22 knots or more for at least one minute. Practices do not require SPECI for wind direction changes based on local criteria. Practices do not require SPECI for the onset, cessation or change in intensity of: freezing fog; low drifting dust, sand or snow; blowing dust, sand or snow (including snowstorm); dust storm; or sandstorm. Practice provides a SPECI when a layer of clouds or obscurations aloft is present below 1000 ft and no layer aloft was reported below 1000 ft in the preceding report. A SPECI is also reported when the ceiling (ceiling is defined in the U.S. as the lowest broken or overcast layer) decreases or increases at these markers: 3000, 1500, 1000, 500 ft or lowest published instrument approach procedures. SPECI is made when referenced weather phenomena cause changes in the visibility, ceiling, sky condition, freezing precipitation (including intensity), hail, or ice pellets.

2.3.3 c)	The U.S. does not issue SPECI for the equivalents in feet of 50, 175, 300, 550 or 600 meters. RVR is measured in increments of 100 feet up to 1,000 feet, increments of 200 feet from 1,000 feet to 3,000 feet, and increments of 500 feet above 3,000 feet to 6,000 feet. SPECI is made when the highest value from the designated RVR runway decreases to less than or if below, increases to equal or exceeds 2,400 feet during the preceding 10 minutes.
3.1.4	Practice to disseminate SPECI for improving conditions as soon as possible after the observation.
4.1.1.2	The U.S. does not provide wind representatives for specific runways but does provide a wind representative for the aerodrome.
4.1.3.1 b)	The United States provides a 2–minute average wind observation for the METAR/SPECI.
4.1.5	The wind direction may be considered variable if, during the 2–minute evaluation period, the wind speed is 6 knots or less. Also, the wind direction must be considered variable if, during the 2–minute evaluation period, it varies by 60 degrees or more when the wind speed is greater than 6 knots. Practices define wind gusts as rapid fluctuations in wind speed with a variation of 10 knots or more between peaks and lulls. Wind speed data for the most recent 10 minutes is examined and a gust, the maximum instantaneous wind speed during that 10–minute period, is reported if the definition above is met during that period.
4.2.4.4	Surface visibility is derived from an automated sensor system and is reported as prevailing visibility in the METAR and SPECI. Tower visibility is the prevailing visibility determined from the airport control tower at locations that also report surface visibility. When visibility is reported from both surface and tower, the lower value (if below 4 miles) is reported in the body of the METAR/SPECI and the other value is reported in the remarks section of the METAR/SPECI.
4.3.4b)	The U.S. does not report in METAR or SPECI marked discontinuity values when RVR passes through values of 800, 550, 300 and 175 meters.
4.3.6	The U.S. reports RVR in increments of 100 feet up to 1,000 feet, increments of 200 feet from 1,000 feet to 3,000 feet, and increments of 500 feet above 3,000 feet to 6,000 feet. The U.S. reports RVR for a single designated runway in the METAR/SPECI. RVR tendency is not reported.
4.4	The following weather elements are augmented manually at designated automated stations observation sites: FC, TS, GR, GS, and VA. At selected airports, additional present weather elements may be provided. With the exception of volcanic ash, present weather is reported when prevailing visibility is less than 7 statute miles or considered operationally significant. Volcanic ash is always reported when observed.
4.4.2.3	GR refers to all hail. All reports of hail include hailstone size diameter in the Remarks (RMK) section of the METAR/SPECI in increments of 1/4 inch. If no hail size is reported it will be assumed to be small hail. Small hail will result in the issuance of a SPECI. GS is used only when snow pellets are observed. The U.S. automated surface observing systems (ASOS, AWOS, AWSS) do not generate an automated report for the occurrence of drizzle or freezing drizzle. The ASOS and AWSS do allow the manual augmentation of these elements to the observations.
4.4.2.8	The practice with respect to the proximity indicator VC is between 5 to 10 statute miles from point of observation.
4.4.2.10	The U.S. does not use “//” to denote the present weather is missing at an automated observing site. The U.S. uses “PWINO” in the remarks section of the METAR and SPECI to denote the present weather is unavailable.
4.5.3	Practice does not provide adjustments for runway thresholds more than 50 feet lower than aerodrome elevation. Applies to KDEN runways 7, 8, 16L, 16R, 17L, 17R, 25, 26, 34L, 34R and 35R, KCLT runway 36C, KCVG runway 36C, KDFW runways 13L and 31R, KLAS runways 25L and 25R, KMEM runways 9 and 18C, KPIT runways 10R, 28L and 32, KSTL runways 6, 12R, 24 and 29, KIND runway 5L, and KRDU runway 5L.

4.5.4	<p>The United States reports only up to 3 layers at automated sites and up to 6 layers at manual sites. Cloud layer amounts are a summation of layers at or below a given level, utilizing cumulative cloud amount. In addition, at automated sites, which are unstaffed, cloud layers above 12,000 ft are not reported. At staffed automated sites, clouds above 12,000 ft may be augmented. CAVOK and NSC are not used. In addition, the US does not use “////” when cloud type cannot be observed; “NCD” when no clouds are detected; or “/////” for CB or TCU when not detected by automated observing systems. In the US, the symbol “////”, when used in the cloud section of METAR, refers to a mountain station where the layer is below the station level. The US refers to a cloud Ceiling, with the abbreviation CIG, as the lowest layer reported as broken or overcast, or the vertical visibility into an indefinite ceiling. The US refers to a Variable Ceiling in the METAR and SPECI Remarks (RMK) when the ceiling layer is variable and below 3,000 feet. The range of variability (V) between the two values is included in the Remark, for example “CIG 005V010”. This difference is also applicable to Table A3–2, METAR and SPECI.</p>
4.5.4.6 d)	<p>The United States does not provide supplemental section for the METAR rather the U.S provides a Remarks Section (RMK) that contains similar information. U.S. METAR and SPECI contain Remarks that are intended for all operational decision–making. FMH–1 contains the complete description of Remarks. Wind shear is not included in the METAR/SPECI code form in the U.S remarks. Practice is to not use RE and to use beginning and ending times in the remarks section for only recent precipitation and thunderstorms. Sea–surface temperature, the state of the sea and state of the runway are not provided in the METAR/SPECI code form in the U.S. remarks.</p>
4.8	<p>The United States does not provide supplemental section for the METAR rather the U.S provides a Remarks Section (RMK) that contains similar information. U.S. METAR and SPECI contain Remarks that are intended for all operational decision–making. FMH–1 contains the complete description of Remarks. Wind shear is not included in the METAR/SPECI code form in the U.S remarks. Practice is to not use RE and to use beginning and ending times in the remarks section for only recent precipitation and thunderstorms.</p> <p>Sea–surface temperature, the state of the sea and state of the runway are not provided in the METAR/SPECI code form in the U.S. remarks.</p>
<b>APPENDIX 4</b>	<b>Technical specifications related to aircraft observations and reports</b>
3.1.3	The U.S. MWOs do not disseminate special air observations and reports.
<b>APPENDIX 5</b>	<b>Technical specifications related to forecasts</b>
1.1	NWS TAFS are not issued in accordance with Table A5–1 due to national practices, which are described in <i>National Weather Service Instruction 10–813</i> .
1.2	<p>Forecast visibility increments used consist of 1/4 mile from 0 (zero) to 1 mile, 1/2 mile from 1 to 2 miles, and 1 mile above 2 miles. Note: miles are statute miles.</p> <p>Practice defines light winds as less than or equal to 6 knots for using VRB in TAF. Practices require forecast of non–convective low–level wind shear within 2,000 feet of the ground in the Optional Group. The NWS does not use CAVOK and NSC in the TAF. NWS practices do not include TCU in the TAF.</p>
1.3	<p>Change groups and amendment criteria below 1/2 statute mile (800 meters) are not used. The 100–foot (30 meter) change group and amendment criterion is not used. Practice requires TAF to be amended for a 30–degree change with an accompanying wind of 12 knots or greater; for a 10 knot wind increase only when the original was 12 knots or greater; and for a 10 knot wind gust, regardless of mean wind speed. The NWS does not use the change indicator “BECMG.” The period of time covered by a TEMPO group is normally kept to a minimum but could be up to four (4) hours. Practice does not amend TAFs for moderate or heavy precipitation.</p>
1.4	The NWS does not use “PROB 40” in the TAF. “PROB 30” will not be used in the first nine (9) hours of every TAF’s valid period, including amendments.

<b>APPENDIX 6</b>	<b>Technical specifications related to SIGMET and AIRMET information, aerodrome warnings and wind shear warnings and alerts</b>
Table A6–1A, Template for SIGMET and AIRMET messages	The US does not provide SIGMET and AIRMET information in accordance with Table A6–1A, template for SIGMET and AIRMET messages.
1.1	<p>The content and format of U.S. SIGMETs are not in accordance with Table A6–1A due to national practices, which are described in National Weather Service Instruction 10–811. SIGMETs in the conterminous U.S. (CONUS), i.e. except Alaska and Hawaii, are often valid for more than one FIR. The SIGMET sequence number is not restricted to FIRs. U.S. practices are to issue SIGMET for mountain wave only when accompanied by severe turbulence. Within the-CONUS and coastal waters, convective SIGMETs are issued in lieu of SIGMETs for thunderstorms. SIGMETs are issued by alphanumeric series, e.g., Kilo 1,2,3 etc. SIGMET messages in the CONUS use VORs in place of lat/long and do not reference FIRs. The U.S. does not use flight level (FL) when describing the altitudes in SIGMETs except for those above FL180.</p> <p>The U.S. does not include a specific forecast position for the end of the SIGMET and AIRMET validity time, other than TC and VA. The U.S. does not issue a SIGMET for radioactive clouds. Within the FIRs over the CONUS and coastal waters, convective SIGMETs are issued in lieu of SIGMETs for Tropical Cyclones (TC).</p>
2.1	<p>The content, order and format of U.S. AIRMETs are not in accordance with Table A6–1A due to national practices, which are described in National Weather Service Instruction 10–811. AIRMETs in the conterminous U.S. are often valid for more than one FIR. The AIRMET sequence number is not restricted to FIRs. AIRMETs in the U.S. are issued on a routine schedule for icing, turbulence, sustained surface winds, ceiling/visibility and mountain obscuration. The US does not issue AIRMETs for thunderstorms. AIRMET information is not restricted to FL100 and below and can be provided up to FL450 depending on the phenomena. The U.S. does not use flight level (FL) when describing the altitudes in AIRMETs except for those above FL180. The U.S. uses VORs instead of latitude and longitude to describe the area within an AIRMET.</p>
4.2	<p>The U.S. issues convective SIGMETs in lieu of SIGMETs for thunderstorms over the CONUS. The US does not issue AIRMETs for thunderstorms. Convective SIGMETs are issued hourly for the East, Central, and Western U.S. and thus they do not indicate the FIR. Convective SIGMETs have an outlook section.</p>
4.2.1	<p>U.S. practices allow for the use of term widespread (WDSPR) for more than 50 percent of the area.</p> <p>Convective SIGMET criteria over the CONUS are:</p> <ol style="list-style-type: none"> <li>a. A line of thunderstorms at least 60 miles long with thunderstorms affecting at least 40 percent of its length.</li> <li>b. An area of active thunderstorms judged to have a significant impact on the safety of aircraft operations, covering at least 40 percent of the area concerned, and exhibiting a very strong radar reflectivity intensity or a significant satellite or lightning signature.</li> <li>c. Embedded or severe thunderstorm(s) expected to occur for more than 30 minutes during the valid period regardless of the size of the area.</li> </ol>
4.2.9	<p>The U.S. criteria for heavy sandstorm and dust storm is visibility less than or equal to 1/4 SM (400 m). The U.S. criteria for moderate sandstorm and dust storm is visibility greater than 1/4 SM and less than or equal to 1/2 SM (800 m).</p>
5.1	<p>The U.S. issues airport warning messages similar to the ICAO format (Table A6–2, Template for aerodrome warnings) only at selected airports based on criteria per a bilateral agreement between the airport authority and the NWS Forecast Office.</p>
6.2.1	<p>The U.S. does not provide wind shear warnings.</p>

<b>ANNEX 4 – AERONAUTICAL CHARTS</b>	
<b>Chapter 1</b>	<b>Definitions</b>
Air taxiway	The U.S. does not depict defined surfaces for air-taxiing of helicopters.
Final approach and take-off area (FATO)	The U.S. does not depict final approach and take-off areas (FATOs).
Prohibited area Restricted area	The U.S. will employ the terms “prohibited area” and “restricted area” substantially in accordance with the definitions established and, additionally, will use the following terms: “Alert area.” Airspace which may contain a high volume of pilot training activities or an unusual type of aerial activity, neither of which is hazardous to aircraft. “Controlled firing area.” Airspace wherein activities are conducted under conditions so controlled as to eliminate the hazards to nonparticipating aircraft and to ensure the safety of persons and property on the ground. “Warning area.” Airspace which may contain hazards to nonparticipating aircraft in international airspace. “Maneuvering area.” This term is not used by the U.S. “Military operations area (MOA).” An MOA is an airspace assignment of defined vertical and lateral dimensions established outside Class A airspace to separate/segregate certain military activities from IFR traffic and to identify for VFR traffic where these activities are conducted. “Movement area.” Movement area is defined by the U.S. as the runways, taxiways, and other areas of an airport which are utilized for taxiing, take-off, and landing of aircraft, exclusive of loading ramp and parking areas.
Touchdown and lift-off area (TLOF)	The U.S. does not use this term.
<b>Chapter 1.1</b>	<b>Definitions</b>
Aerodrome reference point	Airport Reference Point is the approximate geometric center of all usable runway surfaces.
Area Minimum Altitude	Off Route Obstruction Clearance Altitude (OROCA) used.
Air Transit Route	Term “Helicopter Route” used.
Arrival Routes	Arrival routes are also identified on Standard Terminal Arrival (STAR).
Danger Area	The term “danger area” will not be used in reference to areas within the U.S. or in any of its possessions or territories.
Flight Level	Flight level is related to a reference datum of 29.92 inches of mercury.
Glide Path	Glideslope is used instead of glide path.
Helicopter Stand	Helipad is used vice helicopter stand.
Minimum obstacle clearance altitude (MOCA)	MOCA also assures acceptable navigational signal coverage within 22 NM of a VOR.
Minimum sector altitude	Minimum Sector Altitude is centered on the navigation facility upon which the procedure is predicated.
Missed approach point	Missed approach point based on acquiring the required visual reference.
Movement Area	Movement area also includes areas used by helicopters in taxiing. It does not include loading ramps or parking areas.
Obstacle	Obstacles may include terrain and objects of natural growth.



Obstacle clearance altitude (OCA) or Obstacle clearance height (OCH)	Decision Altitude and Decision Height used vice Obstacle Clearance Altitude and Obstacle Clearance Height.
Terminal arrival altitude (TAA)	Terminal Arrival Areas defined by the extension of the IAF legs and the intermediate segment course.
Touchdown zone	Touchdown zone is the first 3000 feet of the runway beginning at the threshold.
Visual approach procedure	Visual approach procedure is conducted on an IFR flight plan which authorizes the pilot to proceed visually and clear of clouds to the airport.
<b>Chapter 1.2</b>	<b>Applicability</b>
1.2.2	Charts vary in their conformance to ICAO Standards.
1.2.2.1	Charts vary in their conformance to ICAO Recommended Practices.
<b>Chapter 2</b>	<b>General Specifications</b>
2.1.7	Charts are True North oriented except as indicated.
2.1.8	Sheet size of charts varies dependent on chart type.
2.2.1	The marginal note layouts, in some cases, differ from those set forth in Appendices 1, 5, and 6.
2.3.1	Marginal note layouts vary by chart type
2.4	Symbols do not universally conform to Appendix 2.
2.4.1	Symbols do not universally conform to Appendix 2.
2.5.4	Linear dimensions are expressed in feet.
2.5.7	Conversion scales are not universally used.
2.6.2	Some charts have no linear scale.
2.9.2	Abbreviations used are from FAA Order JO JO 7340.2, not ICAO Doc 8400.
2.11	Color schemes differ by chart series.
2.12.2	Hypsometric tints differ by chart series.
2.14.1	Airspace depiction differs by chart.
2.15.1	Depiction of magnetic variation differs by chart series and is not always shown.
2.15.4	Each aerodrome has its own magnetic variation assigned. IACC specifications require individually assigned magnetic variation values for each airport.
2.16	Chart typography may vary in conformance to ICAO Standards.
2.18.3.1	Julian Calendar is also used. Local times are used on select charts.
<b>Chapter 3</b>	<b>Aerodrome Obstacle Chart – ICAO Type A (Operating Limitations)</b>
3.1	This data is available digitally and is depicted on other individual flight products to which it is pertinent.
3.2.1	Availability of chart is not dependent on provision of other charts.
3.2.2	Notification is not made when chart is not required.
<b>Chapter 4</b>	<b>Aerodrome Obstacle Chart – ICAO Type B</b>
4.1	This data is available digitally and is depicted on other individual flight products to which it is pertinent.
4.2.1	Availability of chart is not dependent on provision of other charts.
<b>Chapter 5</b>	<b>Aerodrome Obstacle Chart – ICAO Type C</b>
5.1	This data is available digitally and is depicted on other individual flight products to which it is pertinent.

<b>Chapter 6</b>	<b>Precision Approach Terrain Chart – ICAO</b>
6.1	This data is available digitally and is depicted on other individual flight products to which it is pertinent.
<b>Chapter 7</b>	<b>En Route Chart – ICAO</b>
7.1	Simplified versions are not created.
7.6.1	Charts depict only oceanic shorelines and the major lake/river systems forming the U.S./Canadian border.
7.6.2	Off Route Obstruction Clearance Altitude (OROCA) is shown.
7.7	Isogonic date not charted. Isogonic data always reflects the most recent 5 year epoch date
7.9.2	Danger Areas do not exist in the U.S. Prohibited and Restricted airspace, Military Operations Areas, Warning Areas, Alert Areas, and National Security Areas exist and are charted.
7.9.3.1.1	Coordinates are shown in degrees, minutes and hundredths of minutes. DME antenna elevation is not shown. Vertical limits of airspace are shown in tabulated data form. RNP values are not shown on routes. Coordinates of significant points are not shown. Bearings are shown to the nearest degree and distances to the nearest mile.
<b>Chapter 8</b>	<b>Area Chart – ICAO</b>
8.1	Area charts produced only where the amount of detail required results in congestion of information on an IFR Enroute Low Altitude chart.
8.3.1	Departure and Arrival routes are not shown.
8.6.1	Charts depict only oceanic shorelines and the major lake/river systems forming the U.S./Canadian border.
8.6.2	Obstacles are not shown.
8.7	Magnetic Variation is not shown unless an isogonic line runs through the area.
8.8.1	Bearings and tracks are not provided as True values. IACC specifications do not accommodate nor require True values.
8.8.2	Bearings and tracks are not provided as true values.
8.9.1	Only airports shown are those with hard surface runways of 3000 feet or longer and/or with an Instrument Approach Procedure.
8.9.2	Danger Areas do not exist in the U.S. Prohibited and Restricted airspace, Military Operations Areas, Warning Areas, Alert Areas, and National Security Areas exist and are charted.
8.9.3	Off Route Obstruction Clearance Altitude (OROCA) is shown.
8.9.4.1.1	Coordinates are shown in degrees, minutes and hundredths of minutes. DME antenna elevation is not shown. Vertical limits of airspace are shown in tabulated data form. Terminal routings are not shown. Coordinates of significant points are not shown. Bearings are shown to the nearest degree and distances to the nearest mile. Minimum vectoring altitudes are not shown.
<b>Chapter 9</b>	<b>Standard Departure Chart – Instrument (SID) – ICAO</b>
9.2	Charts are provided only when a procedure has been established.
9.3.2	Charts are not generally drawn to scale.
9.3.3	Scale bar is not shown.
9.4.2	Parallels and meridians are not shown.
9.4.3	Graduation marks are not shown.
9.5	Procedure route is identified in accordance with FAA Order 8260.46
9.6.1	Culture and topography are not shown.
9.6.2	Contour relief is not shown. Obstacles are listed textually.
9.7	Magnetic variation is not shown.
9.8.1	Bearings and tracks are not provided as True values. IACC specifications do not accommodate nor require True values.
9.8.2	Bearings and tracks are not provided as True values.
9.8.3	Bearings, tracks, and radials are not provided as True/Grid values.
9.9.1.2	Any requested secondary airport shown by symbol vs runway pattern.

9.9.2	Danger Areas do not exist in the U.S. Prohibited and Restricted airspace, Military Operations Areas, Warning Areas, Alert Areas, and National Security Areas exist and are charted when requested by procedure developer.
9.9.3.1	Minimum Sector Altitude is not shown.
9.9.3.2	Area minimum altitudes are not shown.
9.9.4.1.1	Coordinates for NAVAIDs and Significant Points are shown in degrees, minutes and hundredths of minutes. Bearings are shown to the nearest degree and distances to the nearest mile. DME antenna elevation is not shown. Obstacles are depicted textually with position and height, and without regard for penetration of OIS. Minimum vectoring altitudes are not shown.
<b>Chapter 10</b>	<b>Standard Arrival Chart – Instrument (STAR) – ICAO</b>
10.2	Charts are provided only when a procedure has been established.
10.3.2	Charts are not generally drawn to scale.
10.3.3	Scale bar is not shown.
10.4.2	Parallels and meridians are not shown.
10.4.3	Graduation marks are not shown.
10.5	Procedure route is identified in accordance with FAA Order JO 7100.9
10.6.1	Culture and topography are not shown.
10.6.2	Contour relief is not shown. Obstacles are listed textually.
10.7	Magnetic variation is not shown.
10.8.1 10.8.2	Bearings and tracks are not provided as True values.
10.8.3	Bearings, tracks, and radials are not provided as True/Grid values.
10.9.1.1	Airports are shown by symbol vice pattern.
10.9.1.2	Airports are shown by symbol vs runway pattern.
10.9.2	Danger Areas do not exist in the U.S. Prohibited and Restricted airspace, Military Operations Areas, Warning Areas, Alert Areas, and National Security Areas exist and are charted when requested by procedure developer.
10.9.3.1	Minimum Sector Altitude is not shown.
10.9.3.2	Area minimum altitudes are not shown.
10.9.4.1.1	Bearings are shown to the nearest degree and distances to the nearest mile. Coordinates for NAVAIDs and Significant Points are shown in degrees, minutes and hundredths of minutes. DME antenna elevation is not shown. Minimum vectoring altitudes are not shown.
<b>Chapter 11</b>	<b>Instrument Approach Chart – ICAO</b>
11.3.3	Scale is not shown.
11.3.3.1	Distance circle is not shown.
11.3.3.2	Distance between components and between last component and runway shown.
11.4	Sheet size is 8.25 inches by 5.375 inches
11.5.2	Graduation marks are not shown.
11.7.1	Culture information is not shown. Shaded hydrographic features are shown, but not labeled.
11.7.2	Terrain charting criteria does not include approach gradient steeper than optimal due to terrain.
11.7.3	Terrain is not charted if Std 11.7.2 is not met.
11.8.1	Magnetic variation is shown only in areas of compass instability and on charts North of 67 degrees of latitude.
11.9.1	Bearings, tracks, and radials are not shown as true values for RNAV segments.
11.9.2	Only magnetic north values are shown.
11.9.3	Bearings, tracks, and radials are not provided in true/grid values.
11.10.1.1	Only airports specifically requested for charting are shown.
11.10.1.2	Only airports specifically requested for charting are shown.
11.10.2.2	Obstacles that are the determining factor for an OCA/OCH are not necessarily shown.
11.10.2.4	Obstacle heights are only shown in MSL.

11.10.2.7	Absence of obstacle free zones are not shown.
11.10.3	Danger Areas do not exist in the U.S. Prohibited and Restricted airspace, Military Operations Areas, Warning Areas, Alert Areas, and National Security Areas exist and are charted when requested by procedure developer.
11.10.4.3	Geographic final approach fix coordinates are not shown.
11.10.5	Minimum Safe Altitudes vice Minimum Sector Altitudes. Terminal Arrival Areas vice Terminal Arrival Altitude.
11.10.6.1	Arrowed dotted line is used for MA track. Arrowed dashed line used for Visual track. Times required for the procedure are not shown.
11.10.6.2	Distance to airport from final approach NAVAID is not shown.
11.10.6.3	Missed approach segment is shown by arrowed, dotted line. Arrowed, dashed line is used for visual segments. Times required for the procedure are not shown. Distance between components is shown vice a distance scale.
11.10.6.4	Parentheses are not shown.
11.10.6.5	Ground profile and shaded altitude blocks are not shown.
11.10.7.1	Procedure landing minima are shown vice aerodrome operating minima.
11.10.7.2	Decision Altitude/Height (DA/H) shown vice OCA/H.
11.10.8.2	Altitude/height table is not shown.
11.10.8.3	Altitude/height table is not shown.
11.10.8.4	Rate of descent table is not shown on individual plates, but a combined climb/descent table is available digitally or with printed procedure publication.
11.10.8.5	Descent gradient not shown, threshold crossing height shown in feet, vertical descent angle shown to hundredths of a degree.
11.10.8.6	Threshold crossing height shown in feet. Descent angle shown to the nearest hundredth of a degree.
11.10.8.8	Cautionary note is dependent on multiple criteria.
11.10.8.9	Simultaneous operations notes do not always contain references to runways or procedures.
<b>Chapter 12</b>	<b>Visual Approach Chart – ICAO</b>
12.2	Chart provided only when visual approach procedure has been established.
12.3.2	The scale can vary and also be not-to-scale.
12.3.3	Charts are shown at scale of 1:250,000, IAPs at 1:500,000 or smaller.
12.4	Sheet size is 8.25 inches by 5.375 inches.
12.5.2	Graduation marks are not shown
12.8	Magnetic variation is shown only in areas of compass instability and on charts North of 67 degrees of latitude.
12.9.2	Bearings, tracks, and radials are not shown as true/grid values.
12.9.3	Grid meridian is not shown.
12.10.1.1	Only airports specifically requested for charting are shown.
12.10.1.2	Airport elevation is not shown.
12.10.2.3	Height of obstacle above Mean Sea Level is shown.
12.10.2.3.1	Datum height not shown. Parentheses are not shown.
12.10.3	Vertical limits of areas are not shown. Danger Areas do not exist in the U.S. Prohibited and Restricted airspace, Military Operations Areas, Warning Areas, Alert Areas, and National Security Areas exist and are charted when requested by procedure developer.
12.10.4	Control zones and Traffic zones are not shown.
12.10.5.3	VASI, MEHT, and angle of displacement are not shown.
<b>Chapter 13</b>	<b>Aerodrome/Heliport Chart – ICAO</b>
13.1	Helicopter movement is supported only with the location of helipads.
13.3.2	Latitude and longitude graticules are shown vice linear scale.

13.6.1	Latitude and longitude graticules are shown vice geographical coordinates. Airport elevations and runway end elevations are shown. Runway length and width are shown in feet. Clearways are not shown. Taxiways and identification only are shown. Standard taxi routes are not shown. Boundaries of air traffic service are not shown. RVR observation sites are not shown. Approach and runway lighting are not shown. VASI systems are not shown. VOR checkpoint and frequency are not shown.
13.6.2	Locations accommodating folding wings tips are not shown.
13.6.3	Helicopter pads only are shown. Touchdown and liftoff areas are not shown. Final approach and takeoff areas are not shown. Safety areas are not shown. Clearways are not shown. Only highest obstacle within parameters of chart is shown. Visual aids are not shown. Declared distances are not shown.
<b>Chapter 14</b>	<b>Aerodrome Ground Movement Chart – ICAO</b>
14.1	Chart is not produced.
<b>Chapter 15</b>	
15.1	Chart is not produced.
<b>Chapter 16</b>	<b>World Aeronautical Chart – ICAO 1:1 000 000</b>
16.2.1	1:1,000,000 Chart Series only produced and made available in areas NOT covered by 1:500,000 Chart Series. (Available in Caribbean area only.)
16.3.1	Linear scales are shown in the following order: nautical miles, statute miles, kilometers.
16.4.3	Charts are folded in eleven vertical panels and one horizontal fold.
16.5.1	Standard parallels are for each 8 degrees and are shown 1 degree and 20 minutes in from the Northern and Southern edges of the chart. Charts are not produced above 80 degrees latitude.
16.5.2	Distance between parallels is 1 degree. Above 56 degrees North, latitude graduation marks are shown only on every even degree of longitude. Distance between longitude meridians is 1 degree. Above 64 degrees North, meridian graduation marks are shown every 5 minutes.
16.5.3.1	Lengths of interval marks are as follow: 1 minute – .045 inches; 5 minutes – .065 inches; 10 minutes – .10 inches on both sides.
16.6	Chart numbering is indicated on Title Panel chart index.
16.7.2.2	Tunnels, if possible, are shown wherever they exist.
16.7.3.2	Roads are not shown within outlined populated areas.
16.7.9.2	Coordinates shown to the nearest minute.
16.7.10.1	Notes will read ‘Relief data incomplete’ or ‘Limits of reliable relief information.’
16.7.12.1	Wooded areas are not shown.
16.7.13	Date of topographic information is not shown.
16.8.2	Date of isogonic information is shown in the chart legend.
16.9.2.2	Other than hard surface runways are shown by symbol.
16.9.3.1	Obstacles greater than 500 feet are shown.
16.9.4	Danger Areas do not exist in the U.S. Prohibited and Restricted airspace, Military Operations Areas, Warning Areas, Alert Areas, and National Security Areas exist and are charted.
16.9.7.1	Only aeronautical ground lights that operate continuously are shown.
16.9.7.2	Only marine lights that operate year round, with a range of at least 10 NM, and are omnidirectional are shown.
<b>Chapter 17</b>	<b>Aeronautical Chart – ICAO 1:500 000</b>
17.3.1	Linear scales are shown in the following order: nautical miles, statute miles, kilometers.
17.4.3	Charts are folded in eleven vertical panels and one horizontal fold.
17.4.4	Relationship of chart to WAC series is not shown.
17.5.4.1	The 10 minute interval mark is .10 inches on both sides of the graticule line.
17.6.1.1	Relationship of chart to WAC series is not shown.
17.7.2.2	Tunnels, if possible, are shown wherever they exist. Prominent tunnels are shown pictorially.
17.7.3.1	Roads are shown for radar and visual value and for distinct configurations that provide visual checkpoint value.

17.7.9.2	Coordinates are shown to the nearest minute.
17.7.10.1	Notes will read ‘Relief data incomplete’ or ‘Limits of reliable relief information.’
17.7.12.1	Wooded areas are not shown.
17.7.13	Date of topographic information is not shown.
17.8.2	Date of isogonic information is shown in the chart legend.
17.9.2.2	Other than hard surface runways are shown by symbol.
17.9.3.1	Obstacles greater than 200 feet are shown, except in built up areas where only those greater than 300 feet are shown.
17.9.4	Danger Areas do not exist in the U.S. Prohibited and Restricted airspace, Military Operations Areas, Warning Areas, Alert Areas, and National Security Areas exist and are charted.
17.9.7.1	Only aeronautical ground lights that operate continuously are shown.
17.9.7.2	Only marine lights that operate year round, with a range of at least 10 NM, and are omnidirectional are shown.
<b>Chapter 18</b>	<b>Aeronautical Navigation Chart — ICAO Small Scale</b>
18.1	Chart is not produced.
<b>Chapter 19</b>	<b>Plotting Chart – ICAO</b>
19.1	Chart is not produced.
<b>Chapter 20</b>	<b>Electronic Aeronautical Chart Display — ICAO</b>
20.1	Charts provided digitally to operators. Digital charts mimic paper products described above and may not be modified.
<b>Chapter 21</b>	<b>ATC Surveillance Minimum Altitude Chart — ICAO</b>
21.1	Minimum Vectoring Altitude charts are available in electronic format only.
21.9.2	Danger Areas do not exist in the U.S. Prohibited and Restricted airspace, Military Operations Areas, Warning Areas, Alert Areas, and National Security Areas exist and are charted.
<b>Appendix 6</b>	<b>Aeronautical Data Quality Requirements</b>
Table 5. Bearing used for the formation of an en route and of a terminal fix	Whole degree resolution in charting of bearing used for formation of an en route and terminal fix.
Table 5. Bearing used for the formation of an instrument approach fix	Whole degree resolution in charting of bearing used for formation of an instrument approach procedure fix.
Table 6. (Length/ distance/ dimension  Distance used for the formation of an en route fix	Whole NM resolution in charting of distance used for formation of an en route fix.

<p>Table 6. (Length/ distance/ dimension</p> <p>Distance used for formation of an terminal and instrument approach procedure fix</p>	<p>Whole NM resolution in charting of distance used for formation of an Arrival or Departure fix.</p>
--	---

<b>DOC 10066, PANS-AIM</b>	<b>Procedures for Air Navigation Services Aeronautical Information Management</b>
<b>Chapter 1</b>	<b>Definitions</b>
ASHTAM	The U.S. does not have a series of NOTAM called ASHTAM.
Danger Area	The FAA does not have Danger Area airspace within the U.S.
SNOWTAM	The U.S. does not use the SNOWTAM format.
<b>Chapter 5</b>	<b>Aeronautical Information Products and Services</b>
5.2.1.3.7	The FAA does not produce an AIP Supplement.
5.2.1.4	The FAA does not produce an AIP Supplement.
5.2.5	The U.S. Does not use SNOWTAM format.
5.2.5	The U.S. does not have a series of NOTAM called ASHTAM.
5.2.5	Currently, the U.S. does not utilize the ICAO format for Domestic NOTAMs. The U.S. NOTAMs that are distributed as International NOTAMs may be in ICAO format.
5.4.2	The FAA distribution system does not always match the ICAO standard for formatting, SNOWTAM, and ASHTAM.
<b>Chapter 6</b>	<b>Aeronautical Information Updates</b>
6.1.4	The FAA does not issue Trigger NOTAMs.
<b>Appendix 2</b>	<b>Content of the Aeronautical Information Publication (AIP)</b>
ENR 5.1	U.S. does not use the term Danger Areas. The U.S. describes navigation warnings for Prohibited and Restricted airspace, Warning Areas, Military Operations Areas, Alert Areas, Controlled Firing Areas, and National Security Areas.
<b>Appendix 3</b>	<b>NOTAM Format</b>
Entire Appendix	Currently, the U.S. does not utilize the ICAO format for Domestic NOTAMs. The U.S. NOTAMs that are distributed as International NOTAMs may be in ICAO format.
<b>Appendix 4</b>	<b>SNOWTAM Format</b>
Entire Appendix	The U.S. does not use the SNOWTAM format.
<b>Appendix 5</b>	<b>ASHTAM Format</b>
Entire Appendix	The U.S. does not have a series of NOTAM called ASHTAM.
<b>Appendix 7</b>	<b>Predetermined Distribution System for NOTAM</b>
Entire Appendix	The FAA distribution system does not always match the ICAO standard for formatting, SNOWTAM, and ASHTAM.



<b>ANNEX 5 – UNITS OF MEASUREMENT TO BE USED IN AIR-GROUND COMMUNICATIONS</b>	
<b>Chapter 3</b>	<b>Standard application of units of measurement</b>
3.2.2 Table 3-3 Table 3-4	Table 3-4 Ref 1.12, runway length and Ref 1.13 runway visual range, unit of measure is in feet. Table 3-4 Ref 1.16, visibility unit of measure is statute miles (SM). Table 3-4 Ref 3.2, altimeter setting, unit of measure is reported as inches of mercury. Table 3-4, Ref 3.3, atmospheric pressure, unit of measure is in inches of mercury.
<b>Attachment B</b>	<b>Guidance on the application of System of Units (SI)</b>
5.4.2	Specifications differ from Attachment B, Style and usage, Para 5.4 Numbers. Comma is not acceptable as a decimal marker. Comma is used to separate digits in groups of three.

<b>ANNEX 6 – OPERATION OF AIRCRAFT</b>	
<b>Part I</b>	
<b>Chapter 3</b>	<b>General</b>
Chapter 3 Reference 3.3.6	The U.S. Flight Quality Assurance Program is a voluntary program.
<b>Chapter 4</b>	<b>Flight Operations</b>
Chapter 4 Reference 4.2.2.3	U.S. regulations exempt a single pilot in a 9-or-less seating configuration operation from having a maintenance manual. Rather, U.S. regulations (CFR 135.411) require a single pilot to comply with the maintenance requirements in CFR 91 and 43 in lieu of a maintenance manual or program.
Chapter 4 Reference 4.3.2	For multiengine, aeroplanes, commuter and on-demand operators are required to maintain fuel and oil records as part of the load manifest for 30 days rather than 3 months. For single engine aeroplanes, commuter and on-demand operators are not required to maintain fuel and oil records.
Chapter 4 Reference 4.3.4.1.2	The FAA treats takeoff alternates differently. Take off alternate: for airplanes with 3 or more engines SP/59/4.1 states that the take-off alternate aerodrome must be located within the following flight time distance from the aerodrome of departure: two hours of flight time at an all-engine operating cruising speed, determined from the aircraft operating manual, calculated in ISA and still-air conditions using the actual take-off mass. FAR 121.617 states 2 hours at normal cruising speed with one engine inoperative.
Chapter 4 Reference 4.3.8.2	The U.S. requires descent within four minutes to 14,000 ft not 13,000 ft, in the event of loss of pressurization. For commuter and on-demand operations, the descent altitude is 15,000 ft.
Chapter 4 Reference 4.9.2	The U.S. allows turbo-jets that are certificated for single pilot operations.
<b>Chapter 5</b>	<b>Aeroplane performance operating limitations</b>
Chapter 5 Reference 5.2.8.1	The United States does not have specific regulations that require the loss of Runway length be considered due to alignment of the airplane prior to takeoff. However, the United States does within its aircraft certification regulations require aircraft performance be determined by using the point on the runway where takeoff is started when computing takeoff distance. This same criteria is used when computing runway available for accelerate/stop distance. Accounting for runway loss due to alignment is done within each air carrier’s approved operations manual.
Chapter 5 Reference 5.4.1	The U.S. does not require turbine engine reliability to have a power loss rate of less than 1 per 100,000 engine hours, a radio altimeter, two attitude indicators, airborne weather radar, a certified navigation system to identify aerodromes as forced landing areas, or an engine fire warning system.
Chapter 5 Reference 5.4.2	The U.S. does not require an automatic trend monitoring system on aeroplanes certificated after 1 January 2005.
<b>Chapter 6</b>	<b>Aeroplane instruments, equipment and flight documents</b>
6.3.2.3.2	Effective 1 January 2021, the United States will not have implemented the referenced standard because 14 CFR part 25 does not include the subject requirement for a 25-hour cockpit voice recorder.
Chapter 6 Reference 6.17.2	The U.S. does not require an ELT unless operated over water or remote areas.
Chapter 6 Reference 6.17.3	The U.S. does not require an ELT unless operated over water or remote areas.
Chapter 6 Reference 6.17.4	The U.S. does not require an ELT unless operated over water or remote areas.

Chapter 6 Reference 6.17.5	The U.S. does not require an ELT unless operated over water or remote areas.
Chapter 6 Reference 6.19.2	The U.S. does not require pressure altitude information with a resolution of 25 feet or better.
Chapter 6 Reference 6.19.3	The U.S. does not require pressure altitude information with a resolution of 25 feet or better.
Chapter 6 Reference 6.4.1	The U.S. does not require a time piece.
Chapter 6 Reference 6.4.2	The United States does not require aeroplanes on VFR flights, when operated as controlled flights, to be equipped in accordance with the requirements for aeroplanes operated under instrument flight rules.
Chapter 6 Reference 6.5.1	Seaplanes are not required to have equipment for making the sound signals prescribed in the International Regulations for Preventing Collision at Sea. Seaplanes are not required to be equipped with sea anchor.
Chapter 6 Reference 6.5.3.1	The United States defines extended over water operations for aircraft other than helicopters as an operation over water at a horizontal distance of more than 50 nautical miles from the nearest shoreline.
Chapter 6 Reference 6.12	The United States does not require equipment to measure cosmic radiation.
Chapter 6 Reference 6.15.6	The U.S. does not require ground prox systems for piston powered airplanes.
Chapter 6 Reference 6.20.2	The U.S. does not require pressure altitude information with a resolution of 25 feet or better.
Chapter 6 Reference 6.20.3	The U.S. does not require pressure altitude information with a resolution of 25 feet or better.
Chapter 6 Reference 6.21	The United States does not require crewmembers on flight deck duty to communicate through boom or throat microphones below the transition level/altitude.
Chapter 6 Reference 6.23	The U.S. requires an autopilot for IFR passenger operations, not for VFR or cargo operations. A) The U.S. does not require a boom microphone. B) The U.S. requires charts be available and used.
<b>Chapter 8</b>	<b>Aeroplane Maintenance</b>
Chapter 8 Reference 8.1.3	The person signing the maintenance release must have a CFR 65 certificate.
Chapter 8 Reference 8.4.2	The United States requires that records of work be retained until the work is repeated, superseded by other work or for one year after the work is performed, but does not require the records be retained after the unit has been permanently withdrawn from service.
Chapter 8 Reference 8.7.1.1	Left Intentionally Blank
<b>Chapter 9</b>	<b>Aeroplane flight crew</b>
Chapter 9 Reference 9.4.2.1	The U.S. does not have currency requirements for cruise relief pilots.
Chapter 9 Reference 9.4.2.2	The U.S. does not have currency requirements for cruise relief pilots.
Chapter 9 Reference 9.4.3.2	The United States requires air carrier pilots “before beginning a flight become familiar with all available information concerning the flight.” It does not require the pilot to demonstrate this knowledge.

Chapter 9 Reference 9.4.3.5	The U.S. does not restrict operators from using a pilot as a pilot-in-command on a route where the pilot has not, within the preceding 12 months, made at least one trip between the terminal points of that route as a pilot member of the flight crew, or as an observer on the flight deck except for special areas and airports.  A list of U.S. Special airports may be found at the following link: <a href="http://fsims.faa.gov/PICDetail.aspx?docId=AD20682A64001B6686257B71005E5B74">http://fsims.faa.gov/PICDetail.aspx?docId=AD20682A64001B6686257B71005E5B74</a>
Chapter 9 Reference 9.4.3.6	The U.S. does not have an area/route 12 month currency requirement for pilots in command, except for special areas and airports.
Chapter 9 Reference 9.4.4.1	For PICs, the U.S. requires 1 proficiency checks per 12 months and either proficiency check or an approved simulator training course, for SICs, the U.S. requires 1 proficiency check each 24 months and another proficiency check or an approved simulator training course every 12 months.
<b>PART II</b>	
<b>Section I</b>	<b>General</b>
<b>Chapter 1.1</b>	<b>Definitions</b>
Continuous descent final approach (CDFA)	The FAA does not believe “circling or visual flight maneuver” needs to be added to the definition of a CDFA. The primary reason for a CDFA is to maintain a continuous rate of descent from the FAF, through the MDA until 50 feet above the threshold in the FAS of an NPA. A circle or visual flight maneuver is contrary to the CDFA, the aircraft must stop at the MDA and transition to level flight in order to accomplish the circling or visual flight maneuver to landing. The FAA does recognize that a constant descent rate, not to exceed 1000 ft/min, is normally used to accomplish the descent from the FAF to the circling MDA where level flight is maintained to accomplish the maneuver. This rate of descent may vary due to the design of the circle and/or category of the aircraft. The procedure for accomplishing a circling maneuver has not changed over time, versus, changing the technique for flying a FAS from a “dive and drive” maneuver to a CDFA.
Low-visibility operations (LVO)	FAA defines LVO only as a condition regarding ground operations; not as it pertains to approach and takeoff operations. Further, the FAA sets the threshold for LVO at an RVR of 1200 feet or 350 meters.
<b>Section II</b>	<b>General Aviation Operations</b>
<b>Chapter 2.2</b>	<b>Flight Operations</b>
2.2.2.2.1.1	The FAA allows general aviation operations to 100’ HAT using enhanced flight visions systems when actual visibility is below the newly established ICAO LVO threshold, without a specific approval.
2.2.2.2.5	The FAA allows general aviation instrument approach operations down to MDA or CAT I DA, irrespective of ceiling and visibility, without a specific approval. Further, these operations may be conducted without RVR information.
2.2.2.2.6	The FAA allows general aviation and fractional ownership operators to conduct takeoffs with visibility below the newly established ICAO LVO threshold without a specific approval
2.2.3.4.3	In addition to the Standard prescribed in Annex 6, Part II, 4.6.4, the U.S. prohibits a pilot from taking of a US registered large or turbine-powered multi-engine general aviation aeroplane if there is frost, snow, or ice adhering to critical systems, components, and surfaces of the aircraft.
<b>Chapter 2.4</b>	Aeroplane instruments, equipment and flight documents.
2.4.2.6.1	The United States does not require break-in point markings.
2.4.2.6.2	The United States does not require break-in point markings.

2.4.4.1	The United States does not require all seaplanes on all flights to be equipped with one life jacket or equivalent individual floatation device for each person on board; equipment for making the sound signals prescribed in the International Regulations for Preventing Collisions at Sea; and anchor or a sea anchor (drogue).
2.4.5	Airplanes operated over land areas designated as areas in which search and rescue would be especially difficult are not required to be equipped with signaling devices or life-saving equipment. The United States does not designate areas in which search and rescue would be especially difficult, and therefore does not require such additional equipment.
2.4.8	Airplanes operated under visual flight rules at night are not required to be equipped with c) to f) a) a turn and slip indicator; b) an altitude indicator (artificial horizon); c) a heading indicator (directional gyroscope); d) a means of indicating whether the supply of power to the gyroscopic instruments is adequate; 3) a sensitive pressure altimeter; f) a means of indicating the outside air temperature; g) a timepiece with a sweep second hand; h) an airspeed indicating system with a means of preventing malfunctioning due to condensation or icing; i) a rate-of-climb and descent indicator; j) a landing light; k) illumination for flight instruments and equipment; l) lights in passenger compartments; and m) a flashlight (electric torch) for each crew member station.
2.4.11.4	Ground proximity warning systems are not required on general aviation aircraft, including turbine-engine airplanes with a take-off mass greater than 5700 kg or capable of carrying more than nine passengers.
<b>Chapter 2.5</b>	<b>Aeroplane Communication, Navigation and Surveillance Equipment</b>
2.5.1.1	Except when operating under controlled flight, airplanes operated at night are not required to have radio communications equipment capable of conducting two-way communications. United States requirements for radio communications equipment are based upon the type of airspace in which the operation occurs, and not on the time of the day.
2.5.1.2	When more than one radio communications equipment unit is required, the United States has no provision that each unit be independent of any other.
2.5.1.4	Except when operating under controlled flight, airplanes on extended flights over water or on flights over underdeveloped land are not required to have radio communications equipment capable of conducting two-way communications.
2.5.2.1	The United States has no provisions concerning requirement aircraft navigation instruments enabling a flight to proceed in accordance with a flight plan, prescribed RNP types, or the air traffic services provided. The United States does not specify a minimum distance between landmark references used by flight operating under visual flight rules.
2.5.2.7 (b)	The FAA monitors RVSM performance on a continual basis via ADS-B
2.5.2.9	Though the FAA does not have RVSM operational reporting requirements, it does have a quality assurance requirement in 14 CFR appendix G Sections 2,3, and 4. In addition, RVSM operational deviation may be noted by FAA ATC and reported the FAA Office of Aviation Safety for disposition as deem appropriate.
2.5.2.12	Airplanes are not required to have navigation equipment to ensure that in the event of the failure of one item of equipment at any stage of the flight, the remaining equipment will enable the aeroplane to proceed in accordance with Annex 6, Part II, 2.2.1. to 7.2.3.
<b>Chapter 2.6</b>	<b>Aeroplane maintenance</b>
2.6.2.2.	The FAA established Title 14 Code of Federal Regulations section 43.10, which speaks to the disposition of parts, removed from type-certificated products. After April 15, 2002, each person who removes a life-limited part from a type certificated product must ensure that the part is controlled using: a record keeping system; tag or record attached to part; non-permanent marking; permanent marking; or segregation.

<b>Chapter 2.7</b>	<b>Aeroplane flight crew</b>
2.7.2.2	Only pilot operating aircraft with TCAS under 14 CFR parts 91 (subpart K), 121, and 135 are required to having on the use of TCAS.
<b>Appendix 2.4</b>	<b>General aviation specific approvals</b>
2. SPECIFIC APPROVAL TEMPLATE	The FAA monitors RVSM performance on a continual basis via ADS-B.
<b>Section III</b>	<b>Large and Turbojet Aeroplanes</b>
<b>Chapter 3.6</b>	<b>Aeroplane instruments, equipment and flight documents</b>
3.6.1.1.2	The United States does not base requirements for flight data recorders on aircraft mass, but on passenger and engine configuration.
<b>PART III</b>	
<b>Section I</b>	<b>General</b>
<b>Chapter 1</b>	<b>Definitions</b>
Continuous descent final approach (CDFA).	The FAA does not believe “circling or visual flight maneuver” needs to be added to the definition of a CDFA. The primary reason for a CDFA is to maintain a continuous rate of descent from the FAF, through the MDA until 50 feet above the threshold in the FAS of an NPA. A circle or visual flight maneuver is contrary to the CDFA, the aircraft must stop at the MDA and transition to level flight in order to accomplish the circling or visual flight maneuver to landing. The FAA does recognize that a constant descent rate, not to exceed 1000 ft/min, is normally used to accomplish the descent from the FAF to the circling MDA where level flight is maintained to accomplish the maneuver. This rate of descent may vary due to the design of the circle and/or category of the aircraft. The procedure for accomplishing a circling maneuver has not changed over time, versus, changing the technique for flying a FAS from a “dive and drive” maneuver to a CDFA.
Low-visibility operations (LVO).	FAA defines LVO only as a condition regarding ground operations; not as it pertains to approach and takeoff operations. Further, the FAA sets the threshold for LVO at an RVR of 1200 feet or 350 meters
<b>Section II</b>	<b>International Commercial Air Transport</b>
Chapter 2 Reference 2.2.3.1	Intentionally left blank.
Chapter 2 Reference 2.2.4.2	Intentionally left blank
Chapter 2 Reference 2.2.9.1	Helicopter operators are not required to maintain fuel and oil records showing that the requirements of 2.3.6 have been met.
Chapter 2 Reference 2.2.9.2	Helicopter operators are not required to keep fuel and oil records for three months, though there is a requirement that load manifests be retained for 30 days.
Chapter 2 Reference 2.2.12	Intentionally left blank
Chapter 2 Reference 2.3.2	The pilot-in-command is not required to ensure that all persons on board are aware of the location and general manner of use of the principal emergency equipment carried for collective use.
Chapter 2 Reference 2.3.2	The United States requires that flight preparation forms must be retained for 30 days, not three months.
Chapter 2 Reference 2.3.3.2	The United States does not require that the operations manual describe the contents and use of the operational flight plan, but does require establishing procedures for locating each flight.
Chapter 2 Reference 2.3.6.2.	Intentionally left blank
Chapter 2 Reference 2.3.6.3	The fuel requirements for commuter and on demand operations are expressed in terms of flight time and do not include a specific altitude requirement.
Chapter 2 Reference 2.3.6.3.1	The United States does not require IFR helicopter operations to maintain a specific altitude above a destination.

Chapter 2 Reference 2.3.6.3.2	Fuel reserves for IFR helicopter operations is 30 minutes at normal cruise speed beyond the alternate heliport.
Chapter 2 Reference 2.3.6.3.3	The U.S. has no provisions addressing when a suitable alternate is unavailable. If the destination weather so requires, an alternate must be specified and 30 minute fuel reserved <u>must be carried</u> .
Chapter 2 Reference 2.3.6.4	The operations manual does not include procedures for loss of pressurization and other contingencies.
Chapter 2 Reference 2.3.8.1	The United States does not require oxygen at all times for passengers experiencing cabin pressure altitudes above 13,000 ft (620hPa). Oxygen for all passengers is not required until 15,000 ft (4,572m).
Chapter 2 Reference 2.3.8.2	The United States does not require oxygen at all times for passengers experiencing cabin pressure altitudes above 13,000 ft (620hPa). Oxygen for all passengers is not required until 15,000 ft (4,572m).
Chapter 2 Reference 2.4	The pilot-in-command is not specifically required, prior to commencing a flight, to be <u>satisfied that any load carried is safely secured</u> .
Chapter 2 Reference 2.4.1.3	The United States does not utilize a 1,000 ft minimum for non-precision approaches
Chapter 2 Reference 2.6.2.2	The United States allows for meteorological conditions at the estimated time of arrival and <u>for one hour after the estimated time of arrival, not two hours</u> .
Chapter 2 Reference 2.6.3.2	The United States allows the continuation of an approach regardless of the reported weather.
Chapter 2 Reference 2.8.3.1	The United States does not require that a specific altitude above the alternate be maintained.
Chapter 2 Reference 2.8.3.2	The United States does not require that a specific altitude above the alternate be maintained.
Chapter 2 Reference 2.8.4	The U.S. does not require that the procedures for loss of pressurization, where applicable, or <u>failure of one power-unit while en route, be part of the required fuel and oil computations</u> .
Chapter 2 Reference 2.10	The U.S. requirement for use of breathing oxygen by flight crew members applies only to altitudes above 14000 ft (4,267m).
Chapter 2 Reference 2.11	During an emergency, the pilot-in-command is not required to ensure that all persons on board the aircraft are <u>instructed in emergency procedures</u> .
Chapter 2 Reference 2.14	The pilot-in-command is not specifically required to discontinue a flight beyond the nearest suitable aerodrome when flight crew member's capacity to perform functions is significantly reduced by impairment of faculties from causes such as fatigue, sickness, and lack of oxygen.
Chapter 3 Reference 3.1.1	US does not specify or restrict helicopter operations based on performance, class or <u>category</u> . (See definition of performance class in Annex 6, Part III, Section 1).
Chapter 3 Reference 3.2.1	The United States does not specify or restrict helicopter operations based on performance class or category (see definition of Performance Class in Annex 6, Part III, Section 1)
Chapter 3 Reference 3.2.7	US does not require the helicopter weight limitations found I n3.2.7 a), c), and d).
Chapter 4 Reference 4.1.2	US does not require carriage of a copy of the air operator's certificate.
Chapter 4 Reference 4.1.4.1	The United States does not require break-in points.
Chapter 4 Reference 4.1.4.2	The United States does not require break-in points.
Chapter 4 Reference 4.2.2	a) first aid equipment is not required on helicopters b) Us has no provisions that fire extinguishers, when discharge, will not cause dangerous contamination of the air within the helicopter c) (3) US has no provisions for a safety harness device to prevent interference <u>with flight controls should a pilot become incapacitated</u> .
Chapter 4 Reference 4.2.4.1	The US does not require marking of break-in points.
Chapter 4 Reference 4.2.4.2	The U.S. does not require marking of break-in points.
Chapter 4 Reference 4.3.2.3	Life-saving rafts are not required on helicopters operating on flights over water.

Chapter 4 Reference 4.4	Helicopters operated over land areas designated as areas in which search and rescue would be especially difficult are not required to be equipped with signaling devices or life-saving equipment. The U.S. does not designate areas in which search and rescue would be especially difficult and therefore does not require such additional equipment.
Chapter 4 Reference 4.4.2	Helicopters flown over water in passenger operations are not required to be certified for ditching but only to be equipped with flotation devices.
Chapter 4 Reference 4.5.2.1	B) and C) Life saving rafts and pyrotechnic devices are only required for extended over-water operations. That is in respect to helicopters in operations over water with a horizontal distance of more than 50 NM from the nearest shore line and more than 50 NM from an off-shore heliport structure.
Chapter 4 Reference 4.6	The U.S. does not require helicopters to carry a specific document attesting noise certification. However, the helicopter’s type certificate is the de facto document that the helicopter complied with the noise certification requirements at the time it received FAA type certification.
Chapter 4 Reference 4.6	Helicopters operated over land areas designated as areas in which search and rescue would be especially difficult are not required to be equipped with signaling devices or life-saving equipment. The U.S. does not designate areas in which search and rescue would be especially difficult and therefore does not require additional equipment.
Chapter 4 Reference 4.9.1	The U.S. requires transponders only in certain airspace.
Chapter 4 Reference 4.11	The U.S. does not require helicopters to carry a specific document attesting noise certification. However, the helicopter’s type certificate is the de facto document that the helicopter complied with the noise certification requirements at the time it received FAA type certification.
Chapter 4 Reference 4.13	The U.S. requires transponders only in certain airspace.
Chapter 4 Reference 4.14	The U.S. does not require crew members flight deck duty to communicate through boom or throat microphone.
Chapter 5 Reference 5.1.1	Except when operating under controlled flight, helicopters are not required to have radio communications for night operators.
Chapter 5 Reference 5.1.2	The U.S. does not require that the radio communications equipment specified in 5.1.1 be independent of the other or others to the extent that failure in my any one will not result in failure of any other.
Chapter 5 Reference 5.1.4	Except when operating under controlled flight, helicopters on extended flights over water or on flights over underdeveloped land are not required to have radio communications equipment.
Chapter 5 Reference 5.2.1	The U.S. has no provision that visual landmarks used in VFR be located at least every 60 NM (110km).
Chapter 5 Reference 5.2.1	The United does not require a helicopter to be provided with navigation equipment in accordance with RNP types for navigation with the United States. However, the United States does provide information and operations specifications for IFR operating requirements when U.S. operators and aircraft conduct operations in the European Airspace Designated for Basic Area Navigation (RNP-5 and 10).
Chapter 6 Reference 6.1.1	All United States helicopters used in commercial air transport are certified as commuter or on demand operations. Maintenance on United States commuter and on demand helicopters may be performed by either an approved maintenance organization, a certified mechanic, or by persons under the supervisions of a certified mechanic.
Chapter 6 Reference 6.2.2	The U.S. requires that records of work must be retained until the work is repeated, superseded by other work, or for one year after the work is performed.
Chapter 6 Reference 6.3.1	The U.S. does not require an operator’s maintenance training program to include training in knowledge and skills related to human performance.
Chapter 6 Reference 6.4.2	The U.S. requires that records of work be retained until the work is repeated, superseded by other work for one year after the work is performed, but does not require the records be retained after the until has been permanently withdrawn from service.
Chapter 6 Reference 6.8.2	The U.S. requires that records of work must be retained until the work is repeated, superseded by other work, or for one year after the work is performed.
Chapter 7 Reference 7.4.2.2	Helicopter pilots are not required to demonstrate to the operator an adequate knowledge of the specific areas described in 7.4.3.2



Chapter 7 Reference 7.5	The U.S. practice is to require a spare set of correcting lenses only when a flight crew member's defective visual acuity necessitates a limitation on the pilot's medical certificate.
Chapter 9 Reference 9.5	The U.S. does not require that an operator keep a list of the emergency and survival equipment carried on board any of their helicopters engaged in international air navigation.
Chapter 11 Reference 11.1	A checklist containing procedures to be followed in searching for a suspected bomb is not required to be aboard the aircraft. The U.S. requires that crew members be trained in dealing with explosives that may be on board an aircraft, but this does not necessarily include training on how to search for an explosive.
Chapter 11 Reference 11.2.1	The U.S. does not require an operator to establish and maintain a training program that enables crew members to act in the most appropriate manner to minimize the consequences of acts of unlawful interference.
Chapter 11 Reference 11.2.2	The U.S. does not require an operator to establish and maintain a training program that enables crew members to act in the most appropriate manner to minimize the consequences of acts of unlawful interference.
Chapter 11 Reference 11.3	The pilot-in-command is not required to submit, without delay, a report of an act of unlawful interference to the designated local authority.
<b>Section III</b>	<b>International General Aviation</b>
	Intentionally left blank

<b>ANNEX 7 – AIRCRAFT NATIONALITY AND REGISTRATION MARKS</b>	
3.3.1 and 4.2.1	The marks on wing surfaces are not required.
3.2.5 and Section 8	Identification plates are not required on unmanned, free balloons.
4.2.2	The minimum height of marks on small (12,500 lb or less), fixed-wing aircraft is 3 inches when none of the following exceeds 180 knots true airspeed: (1) design cruising speed; (2) maximum operating limit speed; (3) maximum structural cruising speed; and (4) if none of the foregoing speeds have been determined for the aircraft, the speed shown to be the maximum cruising speed of the aircraft.
Section 6	A centralized registry of unmanned free balloons is not maintained. Operators are required to furnish the nearest ATC facility with a prelaunch notice containing information on the date, time, and location of release, and the type of balloon. This information is not maintained for any specified period of time.
Section 8	United States Identification plate does not have nationality or registration mark.  ICAO ID plate information required by Annex 7.8 does not include nationality or registration mark.  Also for non Part 121 and commuter aircraft, location must be either adjacent to and aft of the rear-most entrance door or on the fuselage near the tail surfaces.

<b>ANNEX 8 – AIRWORTHINESS OF AIRCRAFT</b>	
<b>PART II Procedures for Certification and Continued Airworthiness</b>	
<b>Chapter 1</b>	<b>Type Certification</b>
1.2.5	ICAO requires that the design of an aircraft under ICAO Annex 8, Parts IIIB, IVB, and V use alternative fire extinguishing agents to halon in the lavatories, engines, and auxiliary power units. The United States does not have a similar requirement.
<b>PART III Aeroplanes</b>	
<b>Part IIIA</b>	
<b>Chapter 4</b>	<b>Design and Construction</b>
4.1.6 (b), 4.1.6 (g), 4.1.6 (h), 4.1.6 (i)	The United States does not have similar requirements. The FAA has begun work in an effort to amend the U.S. regulations with the purpose of eventually meeting the intent of these provisions.
<b>Chapter 8</b>	<b>Instruments and Equipment</b>
8.4.1	ICAO requires that airplanes operating on the movement area of an airport shall have airplane lights of such intensity, color, fields of coverage and other characteristics to furnish personnel on the ground with as much time as possible for interpretation and for subsequent maneuver necessary to avoid a collision. The FAA has no such requirement.
8.4.2 (b)	This provision addresses the lights’ affect on outside observers in reference to “harmful dazzle.” The U.S. regulations do not address the affect of aircraft lights on outside observers. However, visibility to other pilots and the lights’ affect on the flight crew is addressed.
<b>Chapter 9</b>	<b>Operating Limitations and Information</b>
9.3.5	The United States does not have similar requirements. The FAA has begun work in an effort to amend the U.S. regulations with the purpose of eventually meeting the intent of these provisions.
<b>Chapter 11</b>	<b>Security</b>
11.2, 11.3, 11.4	With the exception of the door required by 11.3, the United States does not have similar requirements. The FAA has begun work in an effort to amend the U.S. regulations with the purpose of eventually meeting the intent of these provisions.
<b>Part IIIB</b>	
<b>Chapter 3</b>	<b>Structure</b>
3.8.2	The corresponding FAA requirement does not specify the use of failsafe principles; however, the FAA does advise the use of failsafe principles.
<b>Chapter 4</b>	<b>Design and Construction</b>
4.1.6	On November 28, 2008, the FAA adopted new regulations that meet the intent of these provisions. However, Part IIIB applies to airplanes with a date of application of March 2, 2004 or later, but the U.S. requirements apply to airplanes with a date of application of November 28, 2008 or later.
4.2 g)4)	The United States has not modified regulations to require manufacturers to include the elements of the aeroplane design associated with cargo compartment fire protection and a summary of the demonstrated standards that were considered in the process of aeroplane certification, in the documentation made available to the operator for those aircraft certificated on or after 1 January 2025.

D.2 (g)	<p>Paragraph D.2.g.1 of the ICAO standard requires a fire suppression system for each cargo compartment accessible to a crewmember in a passenger–carrying airplane. U.S. requirements permit manual fire fighting in an accessible cargo compartment by a crewmember or members for an all–passenger–carrying airplane or a passenger–cargo combination carrying airplane.</p> <p>Additionally, the FAA does not have specific requirements to consider the effects of explosions or incendiary devices.</p>
D.2 (h)	<p>The United States does have provisions to protect against possible instances of cabin depressurization. However, the FAA does not have specific requirements to consider the effects of explosions or incendiary devices.</p>
F.4.1	<p>ICAO requires that airplanes operating on the movement area of an airport shall have airplane lights of such intensity, color, fields of coverage and other characteristics to furnish personnel on the ground with as much time as possible for interpretation and for subsequent maneuver necessary to avoid a collision. The U.S. has no such requirement.</p>
<b>Chapter 7</b>	<b>Operating Limitations and Information</b>
7.3.5	<p>The United States does not have similar requirements. The FAA has begun work in an effort to amend the U.S. regulations with the purpose of eventually meeting the intent of these provisions.</p>
<b>Chapter 10</b>	<b>Security</b>
10.3.1, 10.3.2	<p>The FAA has a door requirement, but no requirements addressing bulkheads, floors, etc. On January 5, 2007, the FAA published Notice of Proposed Rulemaking that, when adopted, will meet the intent of these provisions.</p>
<b>PART IV Helicopters</b>	
<b>Part IIIB</b>	<b>Large Aeroplane Certification</b>
<b>Chapter 2</b>	<b>Design and Production</b>
4.2	<p>The United States does not have a specific requirement for physical separation of systems. However, physical separation is considered in the means of compliance to various regulations such as 25.1309, 25.901(c) and 25.903(d).</p>
<b>Part IVA</b>	
<b>Chapter 2</b>	<b>Flight</b>
2.2.3.1, 2.2.3.1.1 – 2.2.3.1.4	<p>These provisions address take–off performance data for all classes of helicopters and require that this performance data include the take–off distance required. However, the United States has adopted the requirements only for Category A helicopters.</p>
<b>Chapter 6</b>	<b>Rotor and Power Transmissions Systems and Powerplant Installation</b>
6.7	<p>This provision requires that there be a means for restarting a helicopter’s engine at altitudes up to a declared maximum altitude. In some cases the FAA does not require demonstration of engine restart capability. Since there is a different level of certitude for transport and normal category helicopters in the United States, the engine restart capability is only required for Category A and B helicopters (14 CFR Part 29) and Category A normal helicopters (14 CFR Part 27).</p>
<b>Chapter 7</b>	<b>Instruments and Equipment</b>
7.4.2	<p>This provision addresses the need to switch off or reduce the intensity of the flashing lights. The United States has minimum acceptable intensities that are prescribed for navigation lights and anti–collision lights. No reduction below these levels is possible.</p>
7.4.2 (b)	<p>This provision addresses the lights’ affect on outside observers in reference to “harmful dazzle.” The U.S. regulations do not address the affect of aircraft lights on outside observers. However, visibility to other pilots and the lights’ affect on the flight crew is addressed.</p>

8.4.2 (b)	This provision addresses the lights’ affect on outside observers in reference to “harmful dazzle.” The U.S. regulations do not address the affect of aircraft lights on outside observers. However, visibility to other pilots and the lights’ affect on the flight crew is addressed.
<b>Part IVB</b>	
<b>Chapter 6</b>	<b>Systems and Equipment</b>
6.5	U.S. regulations do not address electromagnetic interference from external sources. High Intensity Radiated Fields (HIRF) are addressed by Special Conditions but only for flight critical systems, not flight essential systems.
<b>PART V Small Aeroplanes</b>	
<b>Chapter 8</b>	<b>Crashworthiness and Cabin Safety</b>
8.5 (e)	The FAA provides requirements for emergency lighting systems in 14CFR 23.812. These requirements do not address the impact of the fuel spillage on emergency lighting systems. Only commuter category airplanes are required to install emergency lighting systems.

<b>ANNEX 9 – FACILITATION</b>	
*The list of differences include Guam, Puerto Rico, and the U.S. Virgin Islands. The status of implementation of Annex 9 in Guam with respect to public health quarantine is not covered in the list of differences.	
<b>Chapter 2</b>	<b>Entry and Departure of Aircraft</b>
2.3	Written crew baggage declaration is required in certain circumstances, and a special Embarkation/Disembarkation Card is required for most alien crew members.
2.4	A General Declaration for all inbound and for outbound flights with commercial cargo are required. However, the General Declaration outbound flights with commercial cargo shall not be required if the declaratory statement is made on the air cargo manifest. No declaration is required for outbound flights without commercial cargo if Customs clearance is obtained by telephone.
Remarks	19 CFR 122
2.4.1	Each crew member must be listed showing surname, given name, and middle initial.
2.4.4	The signing or stamping of the General Declaration protects the carrier by serving as proof of clearance.
2.5	The crew list is required by statute.
2.7	There is a statutory requirement for the Cargo Manifest.
2.8	In order to combat illicit drug smuggling, the U.S. requires the additional following information: the shipper’s and the consignee’s name and address, the type of air waybills, weight, and number of house air waybills. The manifest submitted in electronic form may become legally acceptable in the future. However, until the compliance rate for the automated manifest is acceptable, the U.S. must be able to require the written form of the manifest.
Remarks	19 CFR 122.48
2.9	Nature of goods information is required.
2.10	Stores list required in all cases but may be recorded on General Declaration in lieu of a separate list.
2.17	A cargo manifest is required except for merchandise, baggage and stores arriving from and departing for a foreign country on the same through flight. “All articles on board which must be licensed by the Secretary of State shall be listed on the cargo manifest.” “Company mail shall be listed on the cargo manifest.”
2.18	Traveling general declaration and manifest, crew purchases and stores list as well as a permit to proceed are required under various conditions when aircraft arrive in the U.S. from a foreign area with cargo shown on the manifest to be traveling to other airports in the U.S. or to foreign areas.
2.21	There is a statutory requirement that such changes can only be made prior to or at the time of formal entry of the aircraft.
2.25	The U.S. does not support the use of insecticides in aircraft with passengers present. Pesticides registered for such use should not be inhaled. In effect, the passenger safety issue has precluded the use of such insecticides in the presence of passengers since 1979.
2.35	Advance notice is required of the number of citizens and aliens on board (non–scheduled flights only).
2.40	A copy of the contract for remuneration or hire is required to be a part of the application in the case of non–common carrier operations.
2.41	Single inspection is accorded certain aircraft not by size of aircraft but rather by type of operation. Loads (cargo) of an agricultural nature require inspection by a plant or animal quarantine inspector.
2.41c	Fees are charged for services provided in connection with the arrival of private aircraft (nonscheduled aircraft).
<b>Chapter 3</b>	<b>Entry and Departure of Persons and Their Baggage</b>
3.3	Medical reports are required in some cases.

Remarks	8 CFR 212.7 and INA 234
3.4	Documents such as visas with certain security devices serve as identity documents.
3.4.1	The U.S. has not standardized the personal identification data included in all national passports to conform with the recommendation in Doc 9303.
3.5.6	U.S. passport fees exceed the cost of the operation.
3.5.7	U.S. allows separate passports for minor dependents under the age of 16 entering the U.S. with a parent or legal guardian.
3.7	The U.S. has a pilot program that allows nationals of certain countries which meet certain criteria to seek admission to the U.S. without a visa for up to 90 days as a visitor for pleasure or business.
Remarks	22 CFR 41.112(d) INA 212(d)(4), INA 238, 8 CFR 214.2(c) INA 217
	The law permits visa waivers for aliens from contiguous countries and adjacent islands or in emergency cases. Visas are also waived for admissible aliens arriving on a carrier which is signatory to an agreement assuring immediate transit of its passengers provided they have a travel document or documents establishing identity, nationality, and ability to enter some country other than the U.S.
3.8	The U.S. charges a fee for visas.
3.8.3	Duration of stay is determined at port of entry.
Remarks	INA 217
3.8.4	A visitor to the U.S. cannot enter without documentation.
Remarks	INA 212(a) (26)
3.8.5	Under U.S. law, the duration of stay is determined by the Immigration Authorities at the port of entry and thus cannot be shown on the visa at the time of issuance.
3.10	Embarkation/Disembarkation Card does not conform to Appendix 4 in some particulars.
3.10.1	The operator is responsible for passengers' presentation of completed embarkation/disembarkation cards.
Remarks	8 CFR 299.3
3.10.2	Embarkation/Disembarkation cards may be purchased from the U.S. Government, Superintendent of Documents.
Remarks	8 CFR 299.3
3.14.2	The U.S. fully supports the electronic Advance Passenger Information (API) systems. However, the WCO/IATA Guideline is too restrictive and does not conform to the advancements in the PAXLIST EDIFACT international standard.
3.15	U.S. Federal Inspection Services' officials see individuals more than once.
3.16	Written baggage declarations by crew members are required in some instances.
3.17.1	The U.S. uses a multiple channel system rather than the dual channel clearance system.
3.23, 3.23.1	Statute requires a valid visa and passport of all foreign crew members.
3.24, 3.24.1, 3.25, 3.25.1, 3.25.2, 3.25.3	Crew members, except those eligible under Visa Waiver Pilot Program guidelines, are required to have valid passports and valid visas to enter the U.S.
Remarks	INA 212(a) (26), INA 252 and 253, 8 CFR 214.1(a), 8 CFR 252.1(c)
3.26, 3.27, 3.28, 3.29	Passports and visas are required for crew and non–U.S. nationals to enter the U.S.
3.33	Does not apply to landing card.
3.35	Law requires that the alien shall be returned to the place whence he/she came. Interpretation of this provision requires that he/she be returned to the place where he/she began his/her journey and not only to the point where he/she boarded the last–used carrier.
3.35.1	Law requires that certain aliens be deported from the U.S. at the expense of the transportation line which brought them to the U.S.
3.36	Statute provides for a fine if a passenger is not in possession of proper documents.

3.39.3	NOTE: The U.S. considers security for individuals in airline custody to be the carrier’s responsibility.
3.40.2	Annex 9 recommends that fines and penalties be mitigated if an alien with a document deficiency is eventually admitted to the country of destination.
3.43	Operator can be held responsible for some detention costs.
<b>Chapter 4</b>	<b>Entry and Departure of Cargo and Other Articles</b>
4.20	The Goods Declaration as defined by the Kyoto Convention serves as the fundamental Customs document rather than the commercial invoice.
4.40	Aircraft equipment and parts, certified for use in civil aircraft, may be entered duty-free by any nation entitled to most-favored nation tariff treatment. Security equipment and parts, unless certified for use in the aircraft, are not included.
4.41	Customs currently penalizes the exporting carrier for late filing of Shipper’s Export Declarations (SEDs) and inaccuracies on bills of lading with respect to the SEDs.
4.42	Regulations require entry of such items, most of which are dutiable by law.
4.44	Certain items in this category are dutiable by law.
4.48	Carriers are required to submit new documentation to explain the circumstances under which cargo manifest is not unladen. No penalty is imposed if the carrier properly reports this condition.
4.50	The procedures for adding, deleting, or correcting manifest items require filing a separate document.
4.55	The U.S. requires a transportation in-bond entry or a special manifest bonded movement for this type of movement.
<b>Chapter 5</b>	<b>Traffic Passing Through the Territory of a Contracting State</b>
5.1	Such traffic must be inspected at airports where passengers are required to disembark from the aircraft and no suitable sterile area is available.
5.2	Passports and visas are waived for admissible aliens arriving on a carrier which is signatory to an agreement assuring immediate transit of its passengers provided they have a travel document or documents establishing identity, nationality, and ability to enter some country other than the U.S.
5.3	Such traffic must be inspected at airports where no suitable sterile area is available.
5.4	Passports and visas are waived for admissible aliens arriving on a carrier which is signatory to an agreement assuring immediate transit of its passengers provided they have a travel document or documents establishing identity, nationality, and ability to enter some country other than the U.S.
5.4.1	Passengers will not be required to obtain and present visas if they will be departing from the U.S. within 8 hours of arrival or on the first flight thereafter departing for their destination.
5.8	Examination of transit traffic is required by law. Transit passengers without visas are allowed one stopover between the port of arrival and their foreign destination.
5.9	Passports and visas are required generally for transit passengers who are remaining in the U.S. beyond 8 hours or beyond the first available flight to their foreign destinations.
<b>Chapter 6</b>	<b>International Airports – Facilities and Services for Traffic</b>
6.3.1	Procedures involving scheduling committees raise a number of anti-trust problems under U.S. law.
6.33	Sterile physical facilities shall be provided, and in-transit passengers within those areas shall be subject to immigration inspection at any time.
Remarks	OI 214.2(c)
6.34	The U.S. inspects crew and passengers in transit.
6.36	The U.S. inspects crew and passengers in transit.



---

6.56	Operators of aircraft are statutorily required to pay overtime charges for federal inspections conducted outside normal scheduled hours of operation. This requirement places aircraft operators in a less favorable position than operators of highway vehicles and ferries who are statutorily exempt from such charges.
<b>Chapter 8</b>	<b>Other Facilitation Provisions</b>
8.1	Separate bonds are required.
8.3.2	Visas are issued by the Department of State and are not issued at ports of entry.

<b>ANNEX 10 – AERONAUTICAL TELECOMMUNICATIONS</b>	
<b>ANNEX 10 – VOLUME 1 – RADIO NAVIGATION AIDS</b>	
<b>PART I</b>	
<b>Chapter 3</b>	<b>Specifications for Radio Navigation Aids</b>
3.1.4.1, 3.1.4.2	The United States does not require such aircraft ILS equipment immunity. Interference from FM broadcast signals will not adversely affect aircraft navigation and communications systems in the United States airspace.
3.3.4.2	The US minimum VOR signal strength is -120 dBW/m2. The ICAO requirement is - 107 dBW/m2.
3.3.8.1, 3.3.8.2	The United States does not require such equipage for aircraft. Interference from FM broadcast signals will not adversely affect aircraft navigation and communications systems in the United States airspace.
3.7.3.5.3.1	Currently, the service volume of GBAS in FAA Order 6050.32B is 23 NM up to 10,000 feet vs. 15 and 20 NM ICAO standard.
3.7.3.5.4.1	In the U.S., the LAAS operates on center frequencies from 112.050 to 117.950 MHz vs. ICAO’s 108.0 to 117.975 MHz with the lowest assignable frequency of 112.05 MHz and the last upper assignable frequency of 117.150 MHz vs. ICAO’s 108.025 MHz and 117.900 MHz respectively.
3.7.3.5.3	Currently, the service volume of GBAS in FAA Order 6050.32B is 23 NM up to 10,000 feet.
<b>Appendix B</b>	<b>TECHNICAL SPECIFICATIONS FOR THE GLOBAL NAVIGATION SATELLITE SYSTEM (GNSS)</b>
3.6.7.2.3.5	A solution has been implemented in the US which does not require protection level bounding for rare anomalous ionospheric storms under extreme conditions. The solution requires denial of the approach service when anomalous ionosphere conditions could cause potentially large residual errors and allows operations when estimated residual errors would be below a threshold. The resulting errors under the threshold were found to be acceptable using specific safety assessments and criteria for this equipment.
3.6.8.2.2.5.3	In the U.S., the LAAS operates above the ILS LOC frequency band on center frequencies from 112.05 to 117.950 MHz; therefore, this standard does not apply.
3.6.8.2.2.6	Currently, the D/U standard for co-channel rejection is the same as the ICAO standard of 26 dB. However, D/U standard for the second adjacent channel rejection is 46 dB, which is 3 dB less than the ICAO standard. In addition, no third adjacent channel rejection standard exists in Order 6050.32B.
3.6.8.2.2.6.1c	In the U.S., the LAAS operates above the ILS LOC frequency band on center frequencies from 112.05 to 117.950 MHz; therefore, this standard does not apply.
3.6.8.2.2.6.2a	In the U.S., the LAAS receiver protection from an undesired LAAS signal offset by +/- 50 kHz is 46 dB vs. ICAOs 43 dB.
3.6.8.2.2.6.2c	In the U.S., the LAAS operates above the ILS LOC frequency band on center frequencies from 112.05 to 117.950 MHz.
3.6.8.2.2.6.3	In the U.S., the LAAS receiver protection from an undesired LAAS, VOR, or ILS signal offset by +/- 75 to +/- 975 kHz is not considered during the frequency assignment process.
3.6.8.2.2.6.3c	In the U.S., the LAAS operates above the ILS LOC frequency band on center frequencies from 112.05 to 117.950 MHz.
3.6.8.2.2.6.4	In the U.S., the LAAS receiver protection from an undesired LAAS, VOR, or ILS signal offset by +/- 1 MHz or more is not considered during the frequency assignment process.
<b>Attachment C</b>	<b>INFORMATION AND MATERIAL FOR GUIDANCE IN THE APPLICATION OF THE STANDARDS AND RECOMMENDED PRACTICES FOR ILS, VOR, PAR, 75 MHz MARKER BEACONS (EN-ROUTE), NDB AND DME</b>
2.6.2.1.1 and 2.6.2.1.2	The US frequency protections for ILS localizers are 3 dB more stringent than the ICAO protections (i.e. 23 dB vs. 20 dB for co-channel, -4 dB vs. -7 dB for interim 1st adjacent channels, -31 dB vs. -34 dB for final 1st adjacent channels, -43 dB vs. -46 dB for 2nd adjacent channels, and -47 dB vs. -50 dB for 3rd adjacent channels).

2.6.2.2.1	The US frequency protections for ILS localizers are 3 dB more stringent than the ICAO protections (i.e. 23 dB vs. 20 dB for co-channel, –4 dB vs. –7 dB for interim 1st adjacent channels, –31 dB vs. –34 dB for final 1st adjacent channels, –43 dB vs. –46 dB for 2nd adjacent channels, and –47 dB vs. –50 dB for 3rd adjacent channels).
3.4.6.1 a),b),c) 3.4.6.2 a),b),c)	The US frequency protections for co-channel, 1st and 2nd adjacent channels for VOR are 3 dB more stringent than the ICAO protections (i.e. 23 dB vs. 20 dB for co-channel, –4 dB vs. –7 dB for interim 1st adjacent channels, –31 dB vs. –34 dB for final 1st adjacent channels, –43 dB vs. –46 dB for 2nd adjacent channels).
3.4.6.1 d) 3.4.6.2 d)	The US does not provide any VOR frequency protection for 3rd adjacent channels. The ICAO protection provides –50 dB for 3rd adjacent channels.
7.1.8.1 7.1.8.2 Table C–6	The US frequency protections for co-channel and 1st adjacent channels for DME are 3 dB more stringent than the ICAO protections (i.e. 11 dB vs. 8 dB for co-channel, –39 dB vs. –42 dB for 1st adjacent channels). The US frequency protection for 2nd adjacent channels for DME is 28 dB more stringent than the ICAO protection (i.e. –47 dB vs. –75 dB).
<b>Attachment D</b>	<b>INFORMATION AND MATERIAL FOR GUIDANCE IN THE APPLICATION OF THE GNSS STANDARDS AND RECOMMENDED PRACTICES</b>
7.2.1.5 and Table D–4	In the U.S., the LAAS/LAAS co-channel geographical separation is 159 nm at 10,000 and 20,000 ft. ICAO separation is 195 nm at 10,000 ft.  The first adjacent channel in the U.S. is equivalent to the ICAO second adjacent channel or +/- 50 kHz.  The ICAO separation requirement for GBAS/GBAS second adjacent channel separation is 24 NM. In the U.S., geographical separations are not required between LAAS facilities, which differ in frequency by more than 25 kHz.
7.2.1.6 and Table D–5	Distances shown in ICAO Table D–5 are different from the distances in FAA Order 6050.32B figures 203 and 204 since in the U.S. the separation distances are calculated using the same method as for VOR described in FAA Order 6050.32B.
<b>ANNEX 10 – VOLUME II – COMMUNICATION PROCEDURES INCLUDING THOSE WITH PANS STATUS</b>	
<b>Chapter 3</b>	<b>General Procedures for the International Aeronautical Telecommunication Service</b>
3.2.2, 3.2.3	US regulations do not have any specific procedures for closing down international aeronautical stations. All international aeronautical stations in the U.S. operate continuously (24 hours a day and seven days a week)
<b>Chapter 5</b>	<b>Aeronautical Mobile Service – Voice Communications</b>
5.1.5	US regulations do not require pilots to wait 10 seconds before making a second call. US regulations only require “a few seconds” instead of “10 seconds.”
5.2.1.4.1.1	The United States directs that, for air carriers and other civil aircraft having FAA authorized call signs, the call sign should be followed by the flight number in group form; and for air carriers of foreign registry, the flight number should be stated in group form, or using separate digits if that is the format used by the pilot.
5.2.1.4.1.1	The United States issues surface wind using the word “wind” followed by the separate digits of the indicated wind direction to the nearest 10-degree multiple, the word “at” and the separate digits of the indicated velocity in knots, to include any gusts.
5.2.1.4.1.3	The United States issues the separate digits of a frequency, inserting the word “point” where the decimal point occurs.
5.2.2.7.1.2	US regulations do not specifically require pilots to send a message twice preceded with the phrase “TRANSMITTING BLIND”.  US regulations provides general procedures which allow pilots to make blind transmissions in case of emergency.

5.2.2.7.1.3.1	US regulations do not specifically require pilots to make a blind transmission preceded by “TRANSMITTING BLIND DUE TO RECEIVER FAILURE” with respect to the continuation of the flight of the aircraft.  US regulations provide general procedures which allow pilots to make appropriate blind transmissions.
5.2.2.7.2.1, 5.2.2.7.2.2, 5.2.2.7.2.3	US regulations do not specifically require aeronautical stations to get assistance from other aircraft in case of communications failure.  US regulations require aeronautical stations to use “all appropriate means” available to re-establish communications with aircraft.
5.2.2.7.2.4	US regulations do not provide this specific standard.  US regulations require aeronautical stations to use “all appropriate means” available to re-establish communications with aircraft.
5.2.2.7.3.1	US regulations do not specifically require pilots to make a blind transmission preceded by “TRANSMITTING BLIND DUE TO RECEIVER FAILURE”.  US regulations provide general procedures which allow pilots to make appropriate blind transmissions.
<b>ANNEX 10 – VOLUME III – COMMUNICATION SYSTEMS</b>	
<b>PART I – DIGITAL DATA COMMUNICATION SYSTEMS</b>	
<b>Chapter 7</b>	<b>Aeronautical Mobile Airport Communications System (AeroMACS)</b>
7.4.5.1 (d)	In the U.S., the power spectral density of any frequency removed from the assigned frequency above 150% of the authorized frequency is 50 dB or 55 + log (P) dB, whichever is the lesser attenuation. ICAO requires 50 dB.
<b>PART II – VOICE COMMUNICATION SYSTEMS</b>	
<b>Chapter 2</b>	<b>Aeronautical Mobile Service</b>
2.2.1.2	ICAO recommends a signal-in-space field strength of 75 uv/m (–109dBW/m <sup>2</sup> ), which translates to –82.5 dBm at the input of the receiver assuming 0 dB system losses. In the U.S., per RTCA DO–186a MOPS, the input power to the aircraft receiver should be –87 dBm.
2.3.3.1 2.3.3.2 2.3.3.3 2.3.3.4	The US does not require aircraft flying within the US airspace to meet the interference immunity performance of paragraphs 2.3.3.1, 2.3.3.2, and 2.3.3.3 and the recommendation of paragraph 2.3.3.4 of Annex 10, Vol 3, Part 2, Chapter 2. The FAA, based on the recommendations of the Aviation Rulemaking Advisory Committee, made a decision, in 1996, not to adopt the FM interference immunity performance standards in the U.S. The U.S. continues to use its own FM immunity standards to avoid FM interference in aircraft.
2.3.3.4	The U.S. does not require airborne VHF communications receiving systems to meet the FM broadcast immunity performance standards recommended by ICAO.
<b>ANNEX 10 – VOLUME IV – SURVEILLANCE AND COLLISION AVOIDANCE SYSTEMS</b>	
<b>Chapter 3</b>	<b>Surveillance Systems</b>
3.1.1.7.13	SPI required to be transmitted for 18 +/- 1 second. US regulations are more stringent than ICAO.
<b>Chapter 4</b>	<b>Airborne Collision Avoidance System</b>
4.2.3.3.4	The TSO–C118 (RTCA DO–197) implements this requirement. However, the requirement of limiting Mode S power to the level of Mode A/C (paragraph 4.2.3.4) is not implemented.
4.3.1.1.1	Specifies a nominal cycle of 1 second
4.3.2.1.2	The US specifies a false track probability of less than 1.2% for Mode A/C and less than 0.1% for Mode S.
4.3.5.3.1	Software versions 6.04A, version 7.0 and version 7.1 are all approved for operations in U.S. airspace.

4.3.5.3.2	No changes planned to the current U.S. guidance. Per Advisory Circular (AC) 120–55C, Change 1, Section 11 (MAINTENANCE), para c., TCAS Software Updates: “when necessary, operators should ensure that appropriate TCAS software updates are incorporated. The latest version of software for TCAS II is version 7.1. To ensure compatibility with international standards, the FAA encourages the installation of this software as practical. Software version 6.04A, version 7.0 and version 7.1 are all approved for operations in U.S. airspace.”
4.3.5.3.3	No changes planned to the current U.S. guidance. Per Advisory Circular (AC) 120–55C, Change 1, Section 11 (MAINTENANCE), para c., TCAS Software Updates: “when necessary, operators should ensure that appropriate TCAS software updates are incorporated. The latest version of software for TCAS II is version 7.1. To ensure compatibility with international standards, the FAA encourages the installation of this software as practical. Software version 6.04A, version 7.0 and version 7.1 are all approved for operations in U.S. airspace.”
ACAS	The US uses the term Traffic Alert and Collision Avoidance System (TCAS). The difference of terminology does not impact interoperability of the systems.
<b>ANNEX 10 – VOLUME V – AERONAUTICAL RADIO FREQUENCY SPECTRUM UTILIZATION</b>	
<b>Chapter 2</b>	<b>Distress frequencies</b>
2.1.1	All emergency locator transmitters installed on or after 1 January 2002 and carried in compliance with Standards of Annex 6, Parts I, II and III shall operate on both 406 MHz and 121.500 MHz or on 121.5 MHz.
<b>Chapter 4</b>	<b>Utilization of frequencies above 30 MHz</b>
4.1.2.4	FAA has not issued a mandatory carriage of VDL Mode 3 and VDL Mode 4. Participation in CPDLC (VDL Mode 2) “is at the discretion of the flight crew and/or operator” (NAS Data Communications Guide, version 8, September 10, 2019).
4.1.2.4.1	FAA has not issued a mandatory carriage of VDL Mode 3 and VDL Mode 4.
4.1.4.1	The US does not provide the 20 dB desired-to-undesired signal protection for VHF frequency assignments. The US provides 14 dB.
4.1.4.2	The US does not require aircraft flying within the US airspace to meet one of the characteristics dealing with the FM interference immunity performance. The U.S. Aviation Rulemaking Committee made a decision not to adopt the FM interference immunity performance standards in the U.S. The U.S. continues to use its own FM immunity standards to avoid FM interference in aircraft.
4.1.6.1.2	Assignable frequencies in 25 KHz steps in the US are 121.550 – 123.075 MHz instead of 121.550 – 123.050 MHz, and 123.125 – 136.975 MHz instead of 123.150 – 136.475 MHz.
4.2.3	The US does not follow the VOR assignment priority as defined in Section 4.2.3. Due to severe frequency congestion in the U.S., the ICAO frequency assignment priority order would result in inefficient use of the radio spectrum.

<b>ANNEX 11 – AIR TRAFFIC SERVICES</b>	
<b>Chapter 1</b>	<b>Definitions</b>
Accepting Unit	The term “receiving facility” is used.
Advisory Airspace	Advisory service is provided in terminal radar service areas and the outer area associated with class C airspace areas as well as Class E airspace.
Advisory Route	Advisory service is provided in terminal radar service areas and the outer area associated with class C airspace areas as well as Class E airspace.
ACAS–Airborne Collision Avoidance System	Traffic Alert and Collision Avoidance System (TCAS) – An airborne collision avoidance system based on radar beacon signals which operates independent of ground-based equipment. 14 CFR 1.1 further defines and breaks down TCAS into TCAS 1 – provides traffic advisories 2 – provides traffic advisories and resolution advisories in the vertical plane and 3 – provides traffic advisories and resolution advisories in the vertical and horizontal planes.
AIRMET	FAA Pilot Controller Glossary defines (in part) AIRMET as “A concise description of an occurrence or expected occurrence of specified en route weather phenomena that may affect the safety of aircraft operations, but at intensities lower than those that require the issuance of a SIGMET.” The ICAO definition of AIRMET narrows the purpose of the advisory to “low-level aircraft operations”, where the FAA has a more broad definition to encompass “all aircraft and...aircraft having limited capability...” Also, ICAO uses the term “forecast...for the flight information region” where the FAA uses “area forecast”. Difference in character (terminology) for area forecast. FAA uses AIRMETS for broader purpose.
Air traffic control unit	The U.S. uses the term “air traffic control facility”. (i.e. En Route, Terminal, or Flight Service)
Air traffic services reporting office	FAA Pilot Control Glossary defines (in part) Flight Service Stations (FSS) as “air traffic facilities which provide pilot briefing, en route communications and VFR search and rescue services, assist lost aircraft in emergency situations, relay ATC clearances, originate Notices to Air Missions, broadcast aviation weather and NAS information, receive and process IFR flight plans...” FSS’s are available to receive any reports concerning air traffic services as well as accept and file flight plans.
Air traffic services unit	The U.S. uses “Air Route Traffic Control Center”.
Airway	A Class E airspace area established in the form of a corridor, the centerline of which is defined by radio navigational aids.
Alert Phase	Alert – a notification to a position that there is an aircraft-to-aircraft or aircraft-to-airspace conflict as detected by automated problem detection.
Altitude	Height above ground level (AGL), mean sea level (MSL) or indicate altitude.
Apron Management Service	Ground control or ramp control provide the same service. There is no formal definition in the Pilot Controller Glossary.
Area Control Centre	The U.S. uses the terms “Traffic Control Center”, “Radar Approach Control Facility”, and “Tower” to define a facility that provides air traffic control service to aircraft operating on IFR flight plans within controlled airspace and principally during the en route phase of flight. When equipment capabilities and controller workload permit, certain advisory/assistance services may be provided to VFR aircraft.
Area Control Service	Air Traffic Control – A service operated by appropriate authority to promote the safe, orderly and expeditious flow of air traffic.
Controlled flight	The US uses the term “IFR Clearance”.

Control Zone	The US uses the term “Surface Area”. Surface area is airspace contained by the lateral boundary of the Class B, C, D, or E airspace designated for an airport that begins at the surface and extends upward.
Cruising Level	Cruising Altitude – an altitude or flight level maintained during en route level flight. This is a constant altitude and should not be confused with a cruise clearance.
Downstream Clearance	Same as air traffic control clearance. Authorization for an aircraft to proceed under conditions specified by an air traffic control unit.
Flight Information Centre	In the US, flight information service and alerting service are often provided by flight service stations.
Level	The term “altitude” is used.
Maneuvering Area	Any locality either on land, water, or structures, including airports/heliports and intermediate landing fields, which is used, or intended to be used, for the landing and takeoff of aircraft whether or not facilities are provided for the shelter, servicing, or for receiving or discharging passengers or cargo.
Meteorological office	No PCG definition. However FSSs perform this duty.
Movement Area	The runways, taxiways, and other areas of an airport/heliport which are utilized for taxiing/hover taxiing, air taxiing, takeoff, and landing of aircraft, exclusive of loading ramps and parking areas. At those airports/heliports with a tower, specific approval for entry onto the movement area must be obtained from ATC.
Pilot-in-command	The person who has final authority for the operation and safety of the flight has been designated as pilot in command before or during the flight and hold the appropriate category, class and type rating for the flight.
Traffic avoidance advice	US uses the term “Safety Alert”
Traffic information	US uses the term “Traffic Advisory”
Waypoint	A predetermined geographical position used for route/instrument approach definition, progress reports, published VFR routes, visual reporting points or points for transitioning and/or circumnavigating controlled and/or special use airspace, that is defined relative to a VORTAC station or in terms of latitude/longitude coordinates.
<b>Chapter 2</b>	<b>General</b>
2.3.2	Annex 11, paragraph 2.3.2 directs the flight information service to accomplish objective d) of para 2.2, “to provide advice and information for the safe and efficient conduct of flight.” Details on procedures to accomplish this objective are contained in FAA Order JO 7210.3, Part 4, Flight Service Stations. Specific procedures for accomplishing this objective are contained in FAA Order JO 7110.10, Flight Services. Also, the FAA Pilot Controller Glossary defines a Flight Service Station (FSS) as an air traffic facility which provides pilot briefings, flight plan processing, en route flight advisories, search and rescue services, and assistance to lost aircraft and aircraft in emergency situations. FSSs also relay ATC clearances, process Notices to Air Missions, and broadcast aviation weather and aeronautical information. In Alaska, FSSs provide Airport Advisory Services.
2.5.2.2.1	FAA uses the generic term “controlled airspace” and “surface areas”
2.5.2.2.1.1	FAA also provides this service in Class E.

2.5.2.2.2	Annex 11, paragraph 2.3.2 directs the flight information service to accomplish objective d) of para 2.2, “to provide advice and information for the safe and efficient conduct of flight.” Details on procedures to accomplish this objective are contained in FAA Order 7210.3, Part 4, Flight Service Stations. Specific procedures for accomplishing this objective are contained in FAA Order 7110.10, Flight Services. Also, the FAA Pilot Controller Glossary defines Flight Service Stations as “air traffic facilities which provide pilot briefing, en route communications and VFR search and rescue services, assist lost aircraft and aircraft in emergency situations, relay ATC clearances, originate Notices to Air Missions, broadcast aviation weather and NAS information, receive and process IFR flight plans, and monitor NAVAIDs. In addition, at selected locations, FSSs provide En Route Flight Advisory Service (Flight Watch), take weather observations, issue airport advisories, and advise Customs and Immigration of trans–border flights.”
2.6.1	The U.S. has chosen not to use Class F airspace.
2.11.3.2.2	Class E–5 700/1200–foot airspace areas are used for transitioning aircraft to/from the terminal or en route environment.
2.11.3.3	En Route Domestic Airspace Areas consist of Class E airspace that extends upward from a specified altitude to provide controlled airspace in those areas where there is a requirement to provide IFR en route ATC services but the Federal airway structure is inadequate. En Route Domestic Airspace Areas may be designated to serve en route operations when there is a requirement to provide ATC service but the desired routing does not qualify for airway designation. Offshore/Control Airspace Areas are locations designated in international airspace (between the U.S. 12–mile territorial limit and the CTA/FIR boundary, and within areas of domestic radio navigational signal or ATC radar coverage) wherein domestic ATC procedures may be used for separation purposes.
2.11.5.1	A Class D airspace area shall be of sufficient size to: 1. Allow for safe and efficient handling of operations. 2. Contain IFR arrival operations while between the surface and 1,000 feet above the surface, and IFR departure operations while between the surface and the base of adjacent controlled airspace. Size and shape may vary to provide for 1 and 2. The emphasis is that a Class D area shall be sized to contain the intended operations.
2.11.5.3	Refer to Surface Areas. The U.S. uses the term “Surface Area”. Surface area is airspace contained by the lateral boundary of the Class B, C, D, or E airspace designated for an airport that begins at the surface and extends upward.
2.26.5	No time is issued prior to taxi for take–off. Time checks are given to the nearest quarter minute.
2.29	Process is described in the FAA Safety Management System Manual and the FAA Order 1100.161.
<b>Chapter 3</b>	<b>Air Traffic Control Service</b>
3.2	Air Route Traffic Control Facilities (ARTCC) are used instead of Area Control Service, and Terminal Control Facilities instead of Approach Control Service.
3.6.2.4	The U.S does not specify notification of 2–way communication. The accepting unit shall not alter the clearance of an aircraft that has not yet reached the transfer of control point without the prior approval of the transferring unit.
3.7.3.1	Air crews are not required to read back clearances, only to acknowledge receipt of clearances.
3.7.3.1.1	Air crews are not required to read back clearances, only to acknowledge receipt of clearances.
3.7.3.3	The U.S. only requires a read back for operations regarding hold short instructions. Controllers may request a read back whenever they feel a read back is necessary.
3.7.4.3	4–3–8. COORDINATION WITH RECEIVING FACILITY Coordinate with the receiving facility before the departure of an aircraft if the departure point is less than 15 minutes flying time from the transferring facility’s boundary unless an automatic transfer of of data between automated systems will occur, in which case the flying time requirement may be reduced to 5 minutes or replaced with a mileage from the boundary parameter when mutually agreeable to both facilities.



3.7.4.4	4-4-5. CLASS G AIRSPACE Include routes through Class G airspace only when requested by the pilot. NOTE-1. Flight plans filed for random RNAV routes through Class G airspace are considered a request by the pilot. 2. Flight plans containing MTR segments in/through Class G airspace are considered a request by the pilot. Air Traffic Control Clearance means an authorization by air traffic control within controlled airspace.
<b>Chapter 4</b>	<b>Flight Information Service</b>
4.2.2	No Class F airspace. Collision Hazard information is provided between known traffic to aircraft in Class G airspace.
<b>Chapter 6</b>	<b>Air Traffic Services Requirements for Communications</b>
6.1.1.4 6.2.2.3.8	The US uses a 45 day retention period.
6.2.3.6	The US has a 45 day or longer retention period, with some exceptions. US en route facilities using system analysis recording tapes as their radar retention media shall retain radar data for 15 days. Facilities using a teletype emulator or console printout must be retained for 30 days unless they are related to an accident or incident. A facility using a console typewriter printout take-up device may retain the printout on the spool for 15 days after the last date on the spool. If a request is received to retain data information following an accident or incident, the printout of the relative data will suffice and the tape/disc may then be returned to service through the normal established rotational program.
6.3.1.3	The US has a 45 day or longer retention period except that those facilities utilizing an analog voice recorder system shall retain voice recordings for 15 days.
6.4.1.2	The US retains surveillance data recordings for 45 days or longer when they are pertinent to an accident or incident investigation, except that en route facilities using system analysis recording tapes as their radar retention media (regardless of the type of voice recorder system being used) shall retain voice recordings for 15 days and those facilities using an analog voice recorder system shall retain voice recordings for 15 days. FAA's Air Traffic Control System Command Center shall retain voice recordings for 15 days.
<b>Chapter 7</b>	<b>Air Traffic Services Requirements for Information</b>
7.1.5	The term "communication station" is not used but the flight information is passed.
7.6	Temporary Flight Restrictions (TFRs) are the mechanism that would be implemented in such cases.
<b>Appendix 2</b>	<b>Principles Governing the Establishment and Identification of Significant Points</b>
3.1	In US, per FAA Order 8260.19D, there are some points not to be named. Fixes used for navigation not to be named include Visual Descent Points (VDPs), radar fixes used on ASR and/or PAR procedures, RNAV missed approach point at threshold, and an ATD fix located between the MAP and the landing area marking the visual segment descent point on COPTER RNAV PinS approach annotated "PROCEED VISUALLY."  Additionally, there are some non-pronounceable points allowed. Order 8260.19 states "Except as noted below, each name must consist of a 5-letter pronounceable word. These non-pronounceable exceptions include; Stepdown fixes between FAF and MAP, Missed Approach Points (MAP), Computer Navigation Fixes (CNFs), and VFR Waypoints.

<b>Appendix 4</b>	<b>ATS Airspace Classifications</b>
	<p>Speed restrictions of 250 knots do not apply to aircraft operating beyond 12 NM from the coast line within the U.S. Flight Information Region, in offshore Class E airspace below 10,000 feet MSL.</p> <p>Paragraph (a) of § 91.117 of Title 14 of the Code of Federal Regulations (CFR) provides that “Unless otherwise authorized by the Administrator, no person may operate an aircraft below 10,000 feet MSL at an indicated airspeed of more than 250 knots.” Within domestic airspace, a pilot operating at or above 10,000 MSL on an assigned speed adjustment greater than 250 knots is expected to comply with § 91.117(a) when cleared below 10,000 feet MSL without notifying Air Traffic Control (ATC).</p> <p>The Federal Aviation Administration has proceeded from an operational perspective that the speed restrictions of § 91.117(a) do not apply to U.S.-registered aircraft, via § 91.703(a)(3), when operating outside the United States (and not within another country’s territorial airspace).</p>
<b>Appendix 6</b>	<b>Fatigue Risk Management System (FRMS) Requirements</b>
1.2 f)	Breaks (“relief periods”) required to be “of reasonable duration” (Section 2-5-4c) and “administered in an equitable manner” (2-6-6a)y. Minimum duration not defined except for a meal break (30 minutes).
1.2 Note	Variation from prescriptive schedule rules must be entered into the Daily Record of Facility Operation at the time of the deviation.
3 b)	FAA does not have <i>specific</i> processes for deviations or variations from prescriptive fatigue management regulations.

**ANNEX 12 – SEARCH AND RESCUE**

There are no reportable differences between U.S. regulations and the Standards and Recommended Practices contained in this Annex.

<b>ANNEX 13 – AIRCRAFT ACCIDENT INVESTIGATION</b>	
<b>Chapter 5</b>	<b>Investigation</b>
5.12	<p>The full exchange of information is vital to effective accident investigation and prevention. The U.S. supports, in principle, measures that are intended to facilitate the development and sharing of information. The laws of the U.S. require the determination and public reporting of the facts, circumstances, and probable cause of every civil aviation accident. This requirement does not confine the public disclosure of such information to an accident investigation. However, the laws of the U.S. do provide some protection against public dissemination of certain information of a medical or private nature.</p> <p>Also, U.S. law prohibits the disclosure of cockpit voice recordings to the public and limits the disclosure of cockpit voice recording transcript to that specific information which is deemed pertinent and relevant by the investigative authority. However, U.S. Courts can order the disclosure of the foregoing information for other than accident investigation purposes. The standard for determining access to this information does not consider the adverse domestic or international effects on investigations that might result from such access.</p>
5.25 h)	<p>Investigative procedures observed by the U.S. allow full participation in all progress and investigation planning meetings; however, deliberations related to analysis, findings, probable causes, and safety recommendations are restricted to the investigative authority and its staff. However, participation in these areas is extended through timely written submissions, as specified in paragraph 5.25 i).</p>
5.26 b)	<p>The U.S. supports, in principle, the privacy of the State conducting the investigation regarding the progress and the findings of that investigation. However, the laws of the U.S. facilitate the public disclosure of information held by U.S. government agencies and U.S. commercial business. The standard for determining public access to information requested from a U.S. government agency or a commercial business does not consider or require the expressed consent of the State conducting the investigation.</p>
<b>Chapter 6</b>	<b>Reporting</b>
6.13	<p>The U.S. supports the principle of not circulating, publishing, or providing access to a draft report or any part thereof unless such a report or document has already been published or released by the State which conducted the investigation. However, the laws of the U.S. facilitate the public disclosure of information held by government agencies and commercial business. The U.S. government may not be able to restrict public access to a draft report or any part thereof on behalf of the State conducting the investigation. The standard for determining public access to information requested from a U.S. government agency or a commercial business does not consider or require the expressed consent of the State conducting an investigation.</p>

<b>ANNEX 14 – AERODROMES</b>	
<b>VOLUME 1 – AERODROME DESIGN AND OPERATIONS</b>	
<b>Chapter 1</b>	<b>General</b>
1.2.1	<p>Airports in the U.S. are for the most part owned and operated by local governments and quasi–government organizations formed to operate transportation facilities. The Federal Government provides air traffic control, operates and maintains NAVAIDs, provides financial assistance for airport development, certifies major airports, and issues standards and guidance for airport planning, design, and operational safety.</p> <p>There is general conformance with the Standards and Recommended Practices of Annex 14, Volume I. At airports with scheduled passenger service using aircraft having more than nine seats, compliance with standards is enforced through regulation and certification. At other airports, compliance is achieved through the agreements with individual airports under which Federal development funds were granted; or, through voluntary actions.</p>
1.3.1 1.3.2 1.3.3 1.3.4	<p>In the U.S., the Airport Reference Code is a two–component indicator relating the standards used in the airport’s design to a combination of dimensional and operating characteristics of the largest aircraft expected to use the airport. The first element, Aircraft Approach Category, corresponds to the ICAO PANS–OPS approach speed groupings. The second, Airplane Design Group, corresponds to the wingspan groupings of code element 2 of the Annex 14, Aerodrome Reference Code. See below:</p>

*TBL GEN 1.7–1*  
**Airport Reference Code (ARC)**

<b>Aircraft Approach Category</b>	<b>Approximate Annex 14 Code Number</b>
A	1
B	2
C	3
D	4
E	–
<b>Airplane Design Group</b>	<b>Corresponding Annex 14 Code Letter</b>
I	A
II	B
III	C
IV	D
V	E
VI	F (proposed)

*EXAMPLE: AIRPORT DESIGNED FOR B747–400 ARC D–V.*

<b>Chapter 2</b>	<b>Aerodrome Data</b>
2.2.1	The airport reference point is recomputed when the ultimate planned development of the airport is changed.
2.9.6 2.9.7	Minimum friction values have not been established to indicate that runways are “slippery when wet.” However, U.S. guidance recommends that pavements be maintained to the same levels indicated in the ICAO Airport Services Manual.
2.11.3	If inoperative fire fighting apparatus cannot be replaced immediately, a NOTAM must be issued. If the apparatus is not restored to service within 48 hours, operations shall be limited to those compatible with the lower index corresponding to operative apparatus.
2.12 e)	Where the original VASI is still installed, the threshold crossing height is reported as the center of the on–course signal, not the top of the red signal from the downwind bar.

<b>Chapter 3</b>	<b>Physical Characteristics</b>
3.1.2*	The crosswind component is based on the ARC: 10.5 kt for AI and BI; 13 kt for AII and BII; 16 kt for AIII, BIII and CI through DIII; 20 kts for AIV through DVI.
3.1.9*	Runway widths (in meters) used in design are shown in the table below:

**Width of Runway in Meters**

Aircraft Approach Category	Airplane Design Group					
	I	II	III	IV	V	VI
A	18 <sup>1</sup>	23 <sup>1</sup>	—	—	45	60
B	18 <sup>1</sup>	23 <sup>1</sup>	—	—	45	60
C	30	30	30 <sup>2</sup>	45	45	60
D	30	30	30 <sup>2</sup>	45	45	60

<sup>1</sup>The width of a precision (lower than 3/4 statute mile approach visibility minimums) runway is 23 meters for a runway which is to accommodate only small (less than 5,700 kg) airplanes and 30 meters for runways accommodating larger airplanes.

<sup>2</sup>For airplanes with a maximum certificated take-off mass greater than 68,000 kg, the standard runway width is 45 meters.

3.1.12	FAA allows dual and triple simultaneous independent approaches when runway centerlines are at least 3100 feet apart.
3.1.14*	Longitudinal runway slopes of up to 1.5 percent are permitted for aircraft approach categories C and D except for the first and last quarter of the runway where the maximum slope is 0.8 percent.
3.1.19*	Minimum and maximum transverse runway slopes are based on aircraft approach categories as follows: For categories A and B: 1.0 – 2.0 percent C and D: 1.0 – 1.5 percent
3.2.2	The U.S. does not require that the minimum combined runway and shoulder widths equal 60 meters. The widths of shoulders are determined independently.
3.2.3*	The transverse slope on the innermost portion of the shoulder can be as high as 5 percent.
3.3.3 3.3.4* 3.3.5*	A strip width of 120 meters is used for code 3 and 4 runways for precision, nonprecision, and non-instrumented operations. For code 1 and 2 precision runways, the width is 120 meters. For non-precision/visual runways, widths vary from 37.5 meters up to 120 meters.
3.3.9*	Airports used exclusively by small aircraft (U.S. Airplane Design Group I) may be graded to distances as little as 18 meters from the runway centerline.
3.3.14*	The maximum transverse slope of the graded portion of the strip can be 3 percent for aircraft approach categories C and D and 5 percent for aircraft approach categories A and B.
3.3.15*	The U.S. does not have standards for the maximum transverse grade on portions of the runway strip falling beyond the area that is normally graded.
3.3.17*	Runways designed for use by smaller aircraft under non-instrument conditions may be graded to distances as little as 18 meters from the runway centerline (U.S. Airplane Design Groups I and II).
3.4.2*	For certain code 1 runways, the runway end safety areas may be only 72 meters.
3.7.1* 3.7.2*	The U.S. does not provide Standards or Recommended Practices for radio altimeter operating areas.
3.8.3*	The U.S. specifies a 6 meter clearance for Design Group VI airplanes.
3.8.4*	The taxiway width for Design Group VI airplanes is 30 meters.
3.8.5*	The U.S. also permits designing taxiway turns and intersections using the judgmental oversteering method.

3.8.7*	Minimum separations between runway and taxiway centerlines, and minimum separations between taxiways and taxilanes and between taxiway/taxilanes and fixed/moveable objects are shown in the tables that follow. Generally, U.S. separations are larger for non-instrumented runways, and smaller for instrumented runways, than the Annex. Values are also provided for aircraft with wingspans up to 80 meters.
--------	---

**Minimum Separations Between Runway Centerline and Parallel Taxiway/Taxilane Centerline**

Operation	Aircraft Approach Category	Airplane Design Group						
		I <sup>1</sup>	I	II	III	IV	V	VI
Visual runways and runways with not lower than 3/4-statute mile (1,200 meters) approach visibility minimums	A and B	150 feet 45 meters	225 feet 67.5 meters	240 feet 72 meters	300 feet 90 meters	400 feet 120 meters	—	—
Runways with lower than 3/4-statute mile (1,200 meters) approach visibility minimums	A and B	200 feet 60 meters	250 feet 75 meters	300 feet 90 meters	350 feet 105 meters	400 feet 120 meters	—	—
Visual runways and runways with not lower than 3/4-statute mile (1,200 meters) approach visibility minimums	C and D	—	300 feet 90 meters	300 feet 90 meters	400 feet 120 meters	400 feet 120 meters	400 <sup>2</sup> feet 120 <sup>2</sup> meters	600 feet 180 meters
Runways with lower than 3/4-statute mile (1,200 meters) approach visibility minimums	C and D	—	400 feet 120 meters	400 feet 120 meters	400 feet 120 meters	400 feet 120 meters	400 <sup>2</sup> feet 120 <sup>2</sup> meters	600 feet 180 meters

<sup>1</sup>These dimensional standards pertain to facilities for small airplanes exclusively.

<sup>2</sup>Corrections are made for altitude: 120 meters separation for airports at or below 410 meters; 135 meters for altitudes between 410 meters and 2,000 meters; and, 150 meters for altitudes above 2,000 meters.

**Minimum Taxiway and Taxilane Separations:**

	Airplane Design Group					
	I	II	III	IV	V	VI
Taxiway centerline to parallel taxiway/taxilane centerline	69 feet 21 meters	105 feet 32 meters	152 feet 46.5 meters	215 feet 65.5 meters	267 feet 81 meters	324 feet 99 meters
Fixed or movable object	44.5 feet 13.5 meters	65.5 feet 20 meters	93 feet 28.5 meters	129.5 feet 39.5 meters	160 feet 48 meters	193 feet 59 meters
Taxilane centerline to parallel taxilane centerline	64 feet 19.5 meters	97 feet 29.5 meters	140 feet 42.5 meters	198 feet 60 meters	245 feet 74.5 meters	298 feet 91 meters
Fixed or movable object	39.5 feet 12 meters	57.5 feet 17.5 meters	81 feet 24.5 meters	112.5 feet 34 meters	138 feet 42 meters	167 feet 51 meters

3.8.10*	Line-of-sight standards for taxiways are not provided in U.S. practice, but there is a requirement that the sight distance along a runway from an intersecting taxiway must be sufficient to allow a taxiing aircraft to safely enter or cross the runway.
3.8.11*	Transverse slopes of taxiways are based on aircraft approach categories. For categories C and D, slopes are 1.0–1.5 percent; for A and B, 1.0–2.0 percent.
3.11.5	The runway centerline to taxi-holding position separation for code 1 is 38 meters for non-precision operations and 53 meters for precision. Code 3 and 4 precision operations require a separation of 75 meters, except for “wide bodies,” which require 85 meters.

**Dimensions and Slopes for Protective Areas and Surfaces**

	Precision Approach	Non-precision Instrument Approach			Visual Runway	
	All runways	All runways <sup>a</sup>	Runways other than utility <sup>b</sup>	Utility runways <sup>d</sup>	Runways other than utility	Utility runways
Width of inner edge	305 meters	305 meters	152 meters	152 meters	152 meters	76 meters <sup>c</sup>
Divergency (each side)	15 percent	15 percent	15 percent	15 percent	10 percent	10 percent
Final width	4,877 meters	1,219 meters	1,067 meters <sup>c</sup>	610 meters	475 meters <sup>c</sup>	381 meters <sup>c</sup>
Length	15,240 meters	3,048 meters <sup>c</sup>	3,048 meters <sup>c</sup>	1,524 meters <sup>c</sup>	1,524 meters <sup>c</sup>	1,524 meters <sup>c</sup>
Slope: inner 3,049 meters	2 percent	2.94 percent <sup>c</sup>	2.94 percent <sup>c</sup>	5 percent <sup>c</sup>	5 percent <sup>c</sup>	5 percent <sup>c</sup>
Slope: beyond 3,048 meters	2.5 percent <sup>c</sup>					

<sup>a</sup>With visibility minimum as low as 1.2 km; <sup>b</sup>with visibility minimum greater than 1.2 km; <sup>c</sup>criteria less demanding than Annex 14 Table 4–1 dimensions and slopes. <sup>d</sup>Utility runways are intended to serve propeller-driven aircraft having a maximum take-off mass of 5,570 kg.

<b>Chapter 4</b>	<b>Obstacle Restriction and Removal</b>
4.1	Obstacle limitation surfaces similar to those described in 4.1–4.20 are found in 14 CFR Part 77.
4.1.21	A balked landing surface is not used.
4.1.25	The U.S. does not establish take-off climb obstacle limitation areas and surface, <i>per se</i> , but does specify protective surfaces for each end of the runway based on the type of approach procedures available or planned. The dimensions and slopes for these surfaces and areas are listed in the table above.
4.2	The dimensions and slopes of U.S. approach areas and surfaces are set forth in the above table. Aviation regulations do not prohibit construction of fixed objects above the surfaces described in these sections.
4.2.1	Primary surface is also used as a civil airport imaginary surface. Primary surface is a surface longitudinally centered on a runway. U.S. uses the width of the primary surface of a runway as prescribed in 14 CFR Part 77.25 for the most precise approach existing or planned for either end of that runway.
4.2.8	The slope and dimensions of the approach surface applied to each end of a runway are determined by the most precise approach existing or planned for that runway end.
4.2.9	Approach surfaces are applied to each end of each runway based upon the type of approach available or planned for that runway end.
4.2.10, 4.2.11	Any proposed construction of or alteration to an existing structure is normally considered to be physically shielded by one or more existing permanent structure(s), natural terrain, or topographic feature(s) of equal or greater height if the structure under consideration is located within the lateral dimensions of any runway approach surface but would not exceed an overall height above the established airport elevation greater than that of the outer extremity of the approach surface, and located within, but would not penetrate, the shadow plane(s) of the shielding structure(s).
4.2.12	The basic principle in applying shielding guidelines is whether the location and height of the structures are such that aircraft, when operating with due regard for the shielding structure, would not collide with that structure.
4.2.16	The size of each imaginary surface is based on the category of each runway according to the type of approach available or planned for that runway. The slope and dimensions of the approach surface applied to each end of a runway are determined by the most precise approach existing or planned for that runway end.
4.2.17	Approach surfaces are applied to each end of each runway based upon the type of approach available or planned for that runway end.



<b>Chapter 5</b>	<b>Visual Aids for Navigation</b>
5.2.1.7*	The U.S. does not require unpaved taxiways to be marked.
5.2.2.2*	The U.S. does not require a runway designator marking for unpaved runways.
5.2.2.4	Zeros are not used to precede single–digit runway markings. An optional configuration of the numeral 1 is available to designate a runway 1 and to prevent confusion with the runway centerline.
5.2.4.2* 5.2.4.3*	Threshold markings are not required, but sometimes provided, for non–instrument runways that do not serve international operations.
5.2.4.5	The current U.S. standard for threshold designation is eight stripes, except that more than eight stripes may be used on runways wider than 45 meters. After 1 January 2008, the U.S. standard will comply with Annex 14.
5.2.4.6	The width and spacing of threshold stripes will comply with Annex 14 after 1 January 2008.
5.2.4.10	When a threshold is temporarily displaced, there is no requirement that runway or taxiway edge markings, prior to the displaced threshold, be obscured. These markings are removed only if the area is unsuitable for the movement of aircraft.
5.2.5.2 5.2.5.3*	Aiming point markings are required on precision instrument runways and code 3 and 4 runways used by jet aircraft.
5.2.5.4	The aiming point marking commences 306 meters from the threshold at all runways.
5.2.6.3	The U.S. pattern for touchdown zone markings, when installed on both runway ends, is only applicable to runways longer than 4,990 feet. On shorter runways, the three pair of markings closest to the runway midpoint are eliminated.
5.2.6.4	The U.S. standard places the aiming point marking 306 meters from the threshold where it replaces one of the pair of three stripe threshold markings. The 306 meters location is used regardless of runway length.
5.2.6.5*	Touchdown zone markings are not required at a non–precision approach runway, though they may be provided.
5.2.7.4*	Runway side stripe markings on a non–instrument runway may have an over–all width of 0.3 meter.
5.2.8.3	Taxiway centerline markings are never installed longitudinally on a runway even if the runway is part of a standard taxi route.
5.2.9.5*	The term “ILS” is used instead of CAT I, CAT II, CAT III.
5.2.11.4 5.2.11.5* 5.2.11.6*	Check–point markings are provided, but the circle is 3 meters in diameter, and the directional line may be of varying width and length. The color is the yellow used for taxiway markings.
5.2.12	Standards for aircraft stand markings are not provided.
5.2.13.1*	Apron safety lines are not required although many airports have installed them.
5.2.14.1	The U.S. does not have standards for holding position markings on roadways that cross runways. Local traffic control practices are used.
5.3.1.1 5.3.1.2*	The U.S. does not have regulations to prevent the establishment of non–aviation ground lights that might interfere with airport operations.
5.3.1.3 5.3.1.4	New approach lighting installations will meet the frangibility requirements. Some existing non–frangible systems may not be replaced before 1 January 2005.
5.3.2.1* 5.3.2.2* 5.3.2.3*	There is no requirement for an airport to have emergency runway lighting available if it does not have a secondary power source. Some airports do have these systems, and there is an FAA specification for these lights.
5.3.3.1 5.3.3.3	Only airports served by aircraft having more than 30 seats are required to have a beacon, though they are available at many others.
5.3.3.6	Although the present U.S. standard for beacons calls for 24–30 flashes per minute, some older beacons may have flash rates as low as 12 flashes per minute.
5.3.3.8	Coded identification beacons are not required and are not commonly installed. Typically, airport beacons conforming to 5.3.3.6 are installed at locations served by aircraft having more than 30 seats.

5.3.4.1	While the U.S. has installed an approach light system conforming to the specifications in 5.3.4.10 through 5.3.4.19, it also provides for a lower cost system consisting of medium intensity approach lighting and sequenced flashing lights (MALSF) at some locations.
5.3.4.2	In addition to the system described in 5.3.4.1, a system consisting of omnidirectional strobe lights (ODALS) located at 90 meters intervals extending out to 450 meters from the runway threshold is used at some locations.
5.3.4.10 through 5.3.4.19	The U.S. standard for a precision approach category I lighting system is a medium intensity approach lighting system with runway alignment indicator lights (MALSR). This system consists of 3 meters barrettes at 60 meters intervals out to 420 meters from the threshold and sequenced flashing lights at 60 meters intervals from 480 meters to 900 meters. A crossbar 20 meters in length is provided 300 meters from the threshold. The total length of this system is dependent upon the ILS glide path angle. For angles 2.75° and higher, the length is 720 meters.
5.3.4.16 5.3.4.31	The capacitor discharge lights can be switched on or off when the steady-burning lights of the approach lighting system are operating. However, they cannot be operated when the other lights are not in operation.
5.3.4.20	The U.S. standard for a precision approach category II and III lighting system has a total length dependent upon the ILS glide path angle. For angles 2.75° and higher, the length is 720 meters.
5.3.5.1 5.3.5.3 5.3.5.4	Visual approach slope indicator systems are not required for all runways used by turbojets except runways involved with land and hold short operations that do not have an electronic glideslope system.
5.3.5.2	In addition to PAPI and APAPI systems, VASI and AVASI type systems remain in service at U.S. airports with commercial service. Smaller general aviation airports may have various other approach slope indicators including tri-color and pulsating visual approach slope indicators.
5.3.5.27	The U.S. standard for PAPI allows for the distance between the edge of the runway and the first light unit to be reduced to 9 meters for code 1 runways used by nonjet aircraft.
5.3.5.42	The PAPI obstacle protection surface used is as follows: The surface begins 90 meters in front of the PAPI system (toward the threshold) and proceeds outward into the approach zone at an angle 1 degree less than the aiming angle of the third light unit from the runway. The surface flares 10 degrees on either side of the extended runway centerline and extends 4 statute miles from its point of origin.
5.3.8.4	The U.S. permits the use of omnidirectional runway threshold identification lights.
5.3.13.2	The U.S. does not require the lateral spacing of touchdown zone lights to be equal to that of touchdown zone marking when runways are less than 45 meters wide.  The lateral distance between the markings is 22 meters when installed on runways with a width of 45 meters or greater. The distance is proportionately smaller for narrower runways. The lateral distance between touchdown zone lights is nominally 22 meters but may be reduced to 20 meters to avoid construction problems.
5.3.14	The U.S. has no provision for stopway lights.
5.3.15.1 5.3.15.2*	Taxiway centerline lights are required only below 183 meters RVR on designated taxi routes. However, they are generally recommended whenever a taxiing problem exists.
5.3.15.3 8.2.3	Taxiway centerline lights are not provided on runways forming part of a standard taxi route even for low visibility operations. Under these conditions, the taxi path is coincident with the runway centerline, and the runway lights are illuminated.
5.3.15.5	Taxiway centerline lights on exit taxiways presently are green. However, the new U.S. standard which is scheduled to be published by 1 January 98 will comply with the alternating green/yellow standard of Annex 14.
5.3.15.7*	The U.S. permits an offset of up to 60 cm.
5.3.16.2 8.2.3	Taxiway edge lights are not provided on runways forming part of a standard taxi route.

5.3.17.1 5.3.17.2* 5.3.17.3 5.3.17.4* 5.3.17.5*	Stop bars are required only for runway visual range conditions less than a value of 183 meters at taxiway/runway intersections where the taxiway is lighted during low visibility operations. Once installed, controlled stop bars are operated at RVR conditions less than a value of 350 meters.														
5.3.17.6	Elevated stop bar lights are normally installed longitudinally in line with taxiway edge lights. Where edge lights are not installed, the stop bar lights are installed not more than 3 meters from the taxiway edge.														
5.3.17.9	The beamspread of elevated stop bar lights differs from the in-pavement lights. The inner isocandela curve for the elevated lights is $\pm 7$ horizontal and $\pm 4$ vertical.														
5.3.17.12	The U.S. standard for stop bars, which are switchable in groups, does not require the taxiway centerline lights beyond the stop bars to be extinguished when the stop bars are illuminated. The taxiway centerline lights which extend beyond selectively switchable stop bars are grouped into two segments of approximately 45 meters each. A sensor at the end of the first segment re-illuminates the stop bar and extinguishes the first segment of centerline lights. A sensor at the end of the second segment extinguishes that segment of centerline lights.														
5.3.18.1*	Taxiway intersection lights are also used at other hold locations on taxiways such as low visibility holding points.														
5.3.18.2	Taxiway intersection lights are collocated with the taxiway intersection marking. The marking is located at the following distances from the centerline of the intersecting taxiway:  <table border="0" style="margin-left: 40px;"> <thead> <tr> <th style="text-align: left;">Airplane Design Group</th> <th style="text-align: left;">Distance</th> </tr> </thead> <tbody> <tr> <td>I</td> <td>13.5 meters</td> </tr> <tr> <td>II</td> <td>20 meters</td> </tr> <tr> <td>III</td> <td>28.5 meters</td> </tr> <tr> <td>IV</td> <td>39 meters</td> </tr> <tr> <td>V</td> <td>48.5 meters</td> </tr> <tr> <td>VI</td> <td>59 meters</td> </tr> </tbody> </table>	Airplane Design Group	Distance	I	13.5 meters	II	20 meters	III	28.5 meters	IV	39 meters	V	48.5 meters	VI	59 meters
Airplane Design Group	Distance														
I	13.5 meters														
II	20 meters														
III	28.5 meters														
IV	39 meters														
V	48.5 meters														
VI	59 meters														
5.3.19.1 5.3.19.2*	Runway guard lights are required only for runway visual range conditions less than a value of 350 meters.														
5.3.19.4 5.3.19.5	Runway guard lights are placed at the same distance from the runway centerline as the aircraft holding distance, or within a few feet of this location.														
5.3.19.12	The new U.S. standard for in-pavement runway guard lights complies with Annex 14. However, there may be some existing systems that do not flash alternately.														
5.3.20.4*	The U.S. does not set aviation standards for flood lighting aprons.														
5.3.21	The U.S. does not provide standards for visual docking guidance systems. U.S. manufacturers of these devices generally adhere to ICAO SARPS.														
5.3.23.1	The U.S. does not have a requirement for providing roadholding position lights during RVR conditions less than a value of 350 meters.														
5.4.1.2	Signs are often installed a few centimeters taller than specified in Annex 14, Volume 1, Table 5-4.														
5.4.1.5	Sign inscriptions are slightly larger, and margins around the sign slightly smaller, than indicated in Annex 14, Volume 1, Appendix 4.														
5.4.1.6	The sign luminance requirements are not as high as specified in Appendix 4. The U.S. does not specify a nighttime color requirement in terms of chromaticity.														
5.4.2.2 5.4.2.4 5.4.2.9 5.4.2.14 5.4.2.16	All signs used to denote precision approach holding positions have the legend "ILS."														
5.4.2.6	U.S. practice uses the NO ENTRY sign to prohibit entry by aircraft only.														
5.4.2.8 5.4.2.10	The second mandatory instruction sign is usually not installed unless added guidance is necessary.														

5.4.2.15	Signs for holding aircraft and vehicles from entering areas where they would infringe on obstacle limitation surfaces or interfere with NAVAIDs are inscribed with the <i>designator of the approach</i> , followed by the letters “APCH”; for example, “15–APCH.”
5.4.3.13 5.4.3.15	U.S. practice is to install signs about 3 to 5 meters closer to the taxiway/runway (See Annex 14, Table 5–4).
5.4.3.16	The U.S. does not have standards for the location of runway exit signs.
5.4.3.24	A yellow border is used on all location signs, regardless of whether they are stand-alone or collocated with other signs.
5.4.3.26	U.S. practice is to use Pattern A on runway vacated signs, except that Pattern B is used to indicate that an ILS critical area has been cleared.
5.4.3.30*	The U.S. does not have standards for signs used to indicate a series of taxi-holding positions on the same taxiway.
5.4.4.4*	The inscription, “VOR Check Course,” is placed on the sign in addition to the VOR and DME data.
5.4.5.1*	The U.S. does not have requirements for airport identification signs, though they are usually installed.
5.4.6.1*	Standards are not provided for signs used to identify aircraft stands.
5.4.7.2	The distance from the edge of road to the road-holding position sign conforms to local highway practice.
5.5.2.2* 5.5.7.1*	Boundary markers may be used to denote the edges of an unpaved runway.
5.5.3	There is no provision for stopway edge markers.
<b>Chapter 6</b>	<b>Visual Aids for Denoting Obstacles</b>
6.1	Recommended practices for marking and lighting obstacles are found in FAA Advisory Circular 70/7460–1J, Obstruction Marking and Lighting.
6.1.3	Any temporary or permanent structure, including all appurtenances, that exceeds an overall height of 200 feet (61m) above ground level or exceeds any obstruction standard contained in 14 CFR Part 77, should normally be marked and/or lighted.
6.2.1	This chapter provides recommended guidelines to make certain structures conspicuous to pilots during daylight hours. One way of achieving this conspicuity is by painting and/or marking these structures.  Recommendations on marking structures can vary depending on terrain features, weather patterns, geographic location, and in the case of wind turbines, number of structures and overall layout of design.
6.2.3*	The maximum dimension of the rectangles in a checkered pattern is 6 meters on a side.
6.2.7	Markers should be displayed in conspicuous positions on or adjacent to the structure so as to retain the general definition of the structure. They should be recognizable in clear air from a distance of at least 4,000 feet (1219m) and in all directions from which aircraft are likely to approach. Markers should be distinctively shaped, i.e., spherical or cylindrical, so they are not mistaken for items that are used to convey other information. They should be replaced when faded or otherwise deteriorated.
6.2.11	Flag markers should be displayed around, on top, or along the highest edge of the obstruction. When flags are used to mark extensive or closely grouped obstructions, they should be displayed approximately 50 feet (15m) apart. The flag stakes should be of such strength and height that they will support the flags above all surrounding ground, structures, and/or objects of natural growth.
6.2.12	Each side of the flag marker should be at least 2 feet (0.6m) in length.  Standard does not specifically address mobile objects.
6.2.14	Color patterns. Flags should be colored as follows: solid, orange and white, and checkerboard. Standard does not specifically address mobile objects.

6.3.1	Obstruction lighting may be displayed on structures as follows: aviation red obstruction lights; medium intensity flashing white obstruction lights, high intensity flashing white obstruction lights, dual lighting, obstruction lights during construction, obstruction lights in urban areas, and temporary construction equipment lighting.
6.3.11	The height of the structure AGL determines the number of light levels.  Recommendations on marking structures can vary depending on terrain features, weather patterns, geographic location, and in the case of wind turbines, number of structures and overall layout of design.
6.3.13	When a structure lighted by a high intensity flashing light system is topped with an antenna or similar appurtenance exceeding 40 feet (12m) in height, a medium intensity flashing white light (L-865) should be placed within 40 feet (12m) from the tip of the appurtenance. This light should operate 24 hours a day and flash simultaneously with the rest of the lighting system.
6.3.14	The number of light units recommended depends on the diameter of the structure at the top.
6.3.16	Lights should be installed on the highest point at each end. At intermediate levels, lights should be displayed for each 150 feet (46m) or fraction thereof. The vertical position of these lights should be equidistant between the top lights and the ground level as the shape and type of obstruction will permit. One such light should be displayed at each outside corner on each level with the remaining lights evenly spaced between the corner lights.
6.3.17	Lights should be installed on the highest point at each end. At intermediate levels, lights should be displayed for each 150 feet (46m) or fraction thereof. The vertical position of these lights should be equidistant between the top lights and the ground level as the shape and type of obstruction will permit. One such light should be displayed at each outside corner on each level with the remaining lights evenly spaced between the corner lights.
6.3.18	Lights should be installed on the highest point at each end. At intermediate levels, lights should be displayed for each 150 feet (46m) or fraction thereof. The vertical position of these lights should be equidistant between the top lights and the ground level as the shape and type of obstruction will permit. One such light should be displayed at each outside corner on each level with the remaining lights evenly spaced between the corner lights.
6.3.19, 6.3.20	One or more light units is needed to obtain the desired horizontal coverage. The number of light units recommended per level (except for the supporting structures of catenary wires and buildings) depends upon the average outside diameter of the specific structure, and the horizontal beam width of the light fixture. The light units should be installed in a manner to ensure an unobstructed view of the system by a pilot approaching from any direction. The number of lights recommended is the minimum.  The U.S. does not utilize Type A or Type B obstacle lights. Recommendations on marking structures can vary depending on terrain features, weather patterns, geographic location, and in the case of wind turbines, number of structures and overall layout of design.
6.3.21* 6.3.22*	The effective intensity, for daylight–luminance background, of Type A high–intensity obstacle lights is 270,000 cd ± 25 percent. The effective intensity, for daylight–luminance background, of Type B high–intensity obstacle lights is 140,000 cd ± 25 percent.
6.3.22	The height of the structure AGL determines the number of light levels. The light levels may be adjusted slightly, but not to exceed 10 feet (3m) when necessary to accommodate guy wires and personnel who replace or repair light fixtures. If an adjacent object shields any light, horizontal placement of the lights should be adjusted or additional lights should be mounted on that object to retain or contribute to the definition of the obstruction.  Recommendations on marking structures can vary depending on terrain features, weather patterns, geographic location, and in the case of wind turbines, number of structures and overall layout of design.

<p>6.3.23, 6.3.24, 6.3.27, 6.3.29</p>	<p>Red obstruction lights are used to increase conspicuity during nighttime. The red obstruction lighting system is composed of flashing omnidirectional beacons (L–864) and/or steady burning (L–810) lights. When one or more levels is comprised of flashing beacon lighting, the lights should flash simultaneously.</p> <p>The U.S. does not utilize Type A, B, C, or D obstacle lights. Recommendations on marking structures can vary depending on terrain features, weather patterns, geographic location, and in</p>
<p>6.3.28</p>	<p>When objects within a group of obstructions are approximately the same overall height above the surface and are located a maximum of 150 feet (46m) apart, the group of obstructions may be considered an extensive obstruction. Install light units on the same horizontal plane at the highest portion or edge of prominent obstructions. Light units should be placed to ensure that the light is visible to a pilot approaching from any direction.</p>
<p>6.3.30, 6.3.31, 6.3.32</p>	<p>The medium intensity flashing white light system is normally composed of flashing omnidirectional lights. Medium intensity flashing white obstruction lights may be used during daytime and twilight with automatically selected reduced intensity for nighttime operation.</p> <p>The U.S. does not utilize Type A, B, or C obstacle lights. Medium intensity flashing white (L–865) obstruction lights may provide conspicuity both day and night. Recommendations on marking structures can vary depending on terrain features, weather patterns, geographic location, and in the case of structures and overall layout of design.</p>
<p>6.3.35</p>	<p>Use high intensity flashing white obstruction lights during daytime with automatically selected reduced intensities for twilight and nighttime operations. When high intensity white lights are operated 24 hours a day, other methods of marking and lighting may be omitted.</p> <p>The U.S. does not utilize Type A obstacle lights. Lighting with high intensity (L–856) flashing white obstruction lights provides the highest degree of conspicuity both day and night. Recommendations on marking structures can vary depending on terrain features, weather patterns, geographic location, and in the case of wind turbines, number of structures and overall layout of design.</p>
<p><b>Chapter 7</b></p>	<p><b>Visual Aids for Denoting Restricted Use Areas</b></p>
<p>7.1.2*</p>	<p>A “closed” marking is not used with partially closed runways. See 5.2.4.10, above.</p>
<p>7.1.4</p>	<p>Crosses with shapes similar to figure 7.1, illustration b) are used to indicate closed runways and taxiways. The cross for denoting a closed runway is yellow.</p>
<p>7.1.5</p>	<p>In the U.S. when a runway is permanently closed, only the threshold marking, runway designation marking, and touchdown zone marking need be obliterated. Permanently closed taxiways need not have the markings obliterated.</p>
<p>7.1.7</p>	<p>The U.S. does not require unserviceability lights across the entrance to a closed runway or taxiway when it is intersected by a night–use runway or taxiway.</p>
<p>7.4.4</p>	<p>Flashing yellow lights are used as unserviceability lights. The intensity is such as to be adequate to delineate a hazardous area.</p>
<p><b>Chapter 8</b></p>	<p><b>Equipment and Installations</b></p>
<p>8.1.5* 8.1.6* 8.1.7 8.1.8</p>	<p>A secondary power supply for non–precision instrument and non–instrument approach runways is not required, nor is it required for all precision approach runways.</p> <p>The U.S. does not provide secondary power specifically for take–off operations below 550 meters RVR.</p>
<p>8.2.1</p>	<p>There is no requirement in the U.S. to interleave lights as described in the Aerodrome Design Manual, Part 5.</p>
<p>8.2.3</p>	<p>See 5.3.15.3 and 5.3.16.2</p>
<p>8.7.2* 8.7.3 8.7.4*</p>	<p>Glide slope facilities and certain other installations located within the runway strip, or which penetrate obstacle limitation surfaces, may not be frangibly mounted.</p>

8.9.7*	A surface movement surveillance system is recommended for operations from 350 meters RVR down to 183 meters. Below 183 meters RVR, a surface movement radar or alternative technology is generally required.
<b>Chapter 9</b>	<b>Emergency and Other Services</b>
9.1.1	Emergency plans such as those specified in this section are required only at airports serving scheduled air carriers using aircraft having more than 30 seats. These airports are certificated under 14 CFR Part 139. In practice, other airports also prepare emergency plans.
9.1.12	Full-scale airport emergency exercises are conducted at intervals, not to exceed three years, at airports with scheduled passenger service using aircraft with more than 30 seats.
9.2.1	Rescue and fire fighting equipment and services such as those specified in this section are required only at airports serving scheduled air carriers in aircraft having more than 30 seats. Such airports generally equate to ICAO categories 4 through 9. Other airports have varying degrees of services and equipment.
9.2.3*	There is no plan to eliminate, after 1 January 2005, the current practice of permitting a reduction of one category in the index when the largest aircraft has fewer than an average of five scheduled departures a day.
9.2.4 9.2.5	The level of protection at U.S. airports is derived from the length of the largest aircraft serving the airport similar to the Annex's procedure, except that maximum fuselage width is not used. U.S. indices A–E are close equivalents of the Annex's categories 5–9. The U.S. does not have an equivalent to category 10.

### Fire Extinguishing Agents and Equipment

Index	Aircraft length		Total minimum quantities of extinguishing agents		Minimum trucks	Discharge rate <sup>1</sup>
	More than	Not more than	Dry chemical	Water for protein foam		
A		27 meters	225 kg	0	1	See below
B	27 meters	38 meters	225 kg	5,700 L	1	See below
C	38 meters	48 meters	225 kg	5,700 L	2	See below
D	48 meters	60 meters	225 kg	5,700 L	3	See below
E	60 meters		225 kg	11,400 L	3	See below

<sup>1</sup>Truck size  
1,900 L but less than 7,600  
7,600 L or greater

Discharge rate  
at least 1,900 L per minute but not more than 3,800 L per minute  
at least 2,280 L per minute but not more than 4,560 L per minute

9.2.10	The required firefighting equipment and agents by index are shown in the table above.  The substitution equivalencies between complementary agents and foam meeting performance level A are also used for protein and fluoroprotein foam. Equivalencies for foam meeting performance level B are used only for aqueous film forming foams.
9.2.18*	There is no specific requirement to provide rescue equipment as distinguished from firefighting equipment.
9.2.19*	At least one apparatus must arrive and apply foam within 3 minutes with all other required vehicles arriving within 4 minutes.  Response time is measured from the alarm at the equipment's customary assigned post to the commencement of the application of foam at the mid-point of the farthest runway.
9.2.29*	For ICAO category 6 (U.S. index B), the U.S. allows one vehicle.

9.4.4	At the present time, there is no requirement to perform tests using a continuous friction measuring device with self-wetting features. Some U.S. airports own these devices, while others use less formal methods to monitor build-up of rubber deposits and the deterioration of friction characteristics.
9.4.15	The standard grade for temporary ramps is 15 feet longitudinal per 1 inch of height (0.56 percent slope) maximum, regardless of overlay depth.
9.4.19	There is no U.S. standard for declaring a light unserviceable if it is out of alignment or if its intensity is less than 50 percent of its specified value.

\*Indicates ICAO Recommended Practice



<b>ANNEX 14 – AERODROMES</b>	
<b>VOLUME II – HELIPORTS</b>	
<b>Chapter 1</b>	<b>Definitions</b>
Declared distances	The U.S. does not use declared distances (take-off distance available, rejected take-off distance available, or landing distance available) in designing heliports.
Final approach and take-off area (FATO)	The U.S. “take-off and landing area” is comparable to the ICAO FATO, and the U.S. “FATO” is more comparable to the ICAO TLOF. The U.S. definition for the FATO stops with “the take-off manoeuvre is commenced.” This difference in definition reflects a variation in concept. The rejected take-off distance is an operational computation and is not required as part of the design.
Helicopter stand	The U.S. does not use the term “helicopter stand.” Instead, the U.S. considers paved or unpaved aprons, helipads, and helidecks, all as helicopter parking areas; i.e., helicopter stands.
Safety area	The U.S. considers the safety area to be part of the take-off and landing area which surrounds the FATO and does not call for or define a separate safety area.
Touchdown and lift-off area (TLOF)	The U.S. differs in the definition by considering helipads and helidecks to be FATO. The U.S. does not define the load bearing area on which the helicopter may touch down or lift-off as a TLOF.
<b>Chapter 2</b>	<b>Heliport Data</b>
2.1 d)	The U.S. does not measure or report a safety area as a separate feature of a heliport.
2.2	The U.S. does not “declare” distances for heliports.
<b>Chapter 3</b>	<b>Physical Characteristics</b>
3.1.2	The U.S. does not distinguish between single-engine and multi-engine helicopters for the purposes of heliport design standards. Neither does the U.S. design or classify heliports on the basis of helicopter performance. The U.S. FATO dimensions are at least equal to the rotor diameter of the design single rotor helicopter and the area must be capable of providing ground effect. The U.S. does not have alternative design standards for water FATOs, elevated heliports, or helidecks.
3.1.3	The U.S. has a single gradient standard; i.e., 5 percent, except in fueling areas where the limit is 2 percent, which is applicable for all portions of heliports.
3.1.6 3.1.7* 3.1.8*	The U.S. does not require or provide criteria for clearways in its design standards. It does encourage ownership and clearing of the land underlying the innermost portion of the approach out to where the approach surface is 10.5 meters above the level of the take-off surface.
3.1.14 to 3.1.21	Safety areas are considered part of the take-off and landing area (or primary surface) in U.S. heliport design. The take-off and landing area of the U.S. design criteria, based on 2 rotor diameters, provides for the ICAO safety area; however, the surface does not have to be continuous with the FATO or be load bearing.
3.1.22	Taxiway widths are twice the undercarriage width of the design helicopter.
3.1.23	The U.S. requires 1.25 rotor diameters plus 2 meters of separation between helicopter ground taxiways.
3.1.24	The U.S. gradient standard for taxiways is a maximum of 5 percent.
3.1.32*	The U.S. sets no gradient standards for air taxiways.
3.1.33	The U.S. requires 1.5 rotor diameters of separation between hover or air taxiways.
3.1.34	The U.S. standards for air taxiways and air transit routes are combined as the standards for hover taxiways noted in paragraphs 3.1.23, 3.1.24 and 3.1.33.
3.1.35	The U.S. sets no maximum turning angle or minimum radius of turn on hover taxiways.
3.1.36	The U.S. gradient standard for aprons is a maximum of 5 percent except in fueling areas where it is 2 percent.
3.1.37	The U.S. criterion for object clearances is 1/3 rotor diameter or 3 meters, whichever is greater.
3.1.38	The U.S. standard for helipads (comparable to helicopter stands) is 1.5 times the undercarriage length or width, whichever is greater.

3.1.39	The U.S. standard for separation between FATO center and the centerline of the runway is 120 meters.
3.2.2	The U.S. does not apply either a performance related or an alternative design standard for elevated heliport facilities.
3.2.5 to 3.2.10	The U.S. does not use safety areas in its heliport design.
3.3 3.4	In the U.S., shipboard and relocatable off–shore helicopter “helideck” facilities are under the purview of the U.S. Coast Guard and utilize the International Maritime Organization (IMO) code. Fixed off–shore helideck facilities are under the purview of the Department of Interior based on their document 351DM2. Coastal water helideck facilities are under the purview of the individual affected States.
<b>Chapter 4</b>	<b>Obstacle Restriction and Removal</b>
4.1.1	The U.S. approach surface starts at the edge of the take–off and landing area.
4.1.2 a)	The U.S. approach surface width adjacent to the heliport take–off and landing area is a minimum of 2 rotor diameters.
4.1.2 b) 2)	The U.S. precision instrument approach surface flares from a width of 2 rotor diameters to a width of 1,800 meters at the 7,500 meters outer end. The U.S. does not use a note similar to the one that follows 4.1.4, as it does not differentiate between helicopter requirements on the basis of operational performance.
4.1.5	The outer limit of the U.S. transitional surfaces adjacent to the take–off and landing area is 76 meters from the centerline of the VFR approach/departure surfaces. The transitional surface width decreases to zero at a point 1,220 meters from the take–off and landing area. It does not terminate at an inner horizontal surface or at a predetermined height.
4.1.6	The U.S. transitional surfaces have a fixed width, 76 meters less the width of the take–off and landing area, from the approach centerline for visual operations and an outwardly flaring width to 450 meters for precision instrument operations. The U.S. does not use an inner horizontal surface nor terminate the transitional surfaces at a fixed/predetermined height.
4.1.7 b)	Since the U.S. includes the safety area in the take–off and landing area, the comparable elevation is at the elevation of the FATO.
4.1.9 through 4.1.20	The U.S. does not use the inner horizontal surface, the conical surface, or take–off climb surface described in these paragraphs or the note following paragraph 4.1.20 for heliport design.
4.1.21 through 4.1.25	The U.S. does not have alternative criteria for floating or fixed–in–place helidecks.
4.2	The U.S. has no requirement for a note similar to the one following the heading “Obstacle limitation requirements.”
4.2.1	The U.S. criteria does not require a take–off climb surface or a conical obstacle limitation surface to establish a precision instrument approach procedure.
4.2.2	The U.S. criteria does not require a take–off climb surface or a conical obstacle limitation surface to establish a non–precision instrument approach procedure.
4.2.3	The U.S. criteria does not require a take–off climb obstacle limitation surface to establish a non–instrument approach procedure.
4.2.4*	The U.S. has no requirement for protective surfaces such as an inner horizontal surface or a conical surface.
4.2.5	The U.S. does not have tables for heliport design comparable to the ICAO Tables 4–1 to 4–4.
4.2.6	The U.S. subscribes to the intent of this paragraph to limit object heights in the heliport protective surfaces but uses fewer surfaces with different dimensions for those surfaces.
4.2.7*	The U.S. subscribes to the intent of this paragraph but uses different dimensional surfaces.
4.2.8	The U.S. criterion requires that a heliport have at least one approach and departure route and encourages multiple approaches separated by arcs of 90 to 180 degrees.
4.2.9*	The U.S. has no requirement that a heliport’s approach surfaces provide 95 percent usability.

4.2.10	Since the U.S. does not differentiate between surface level and elevated heliports, the comments to paragraphs 4.2.1 through 4.2.5 above apply.
4.2.11	The U.S. has no requirement for a take-off climb surface. It does require at least one approach/departure surface and encourages that there be as many approaches as is practical separated by arcs of 90 to 180 degrees.
4.2.12 through 4.2.22	Since the U.S. does not have alternative design criteria for helidecks or shipboard heliports, there are no comparable U.S. protective surface requirements.
Tables 4–1, 4–2, 4–3, 4–4	The U.S. does not have tables comparable to the ICAO Tables 4–1 to 4–4.
<b>Chapter 5</b>	<b>Visual Aids</b>
5.2.1	The U.S. does not have criteria for markings to be used in defining winching areas.
5.2.3.3	The U.S. maximum mass markings are specified in 1,000 pound units rather than tonnes or kilograms.
5.2.4.3	The U.S. criterion requires FATO markers but is not specific on the number or spacing between markers.
5.2.4.4	The U.S. criteria for FATO markers is not dimensionally specific.
5.2.6	The U.S. does not require, or have criteria for, marking an aiming point.
5.2.7.1	The U.S. does not require specific criteria for marking floating or off-shore fixed-in-place helicopter or helideck facilities.
5.2.8	The U.S. does not require marking the touchdown area.
5.2.9	The U.S. does not have criteria for heliport name markings.
5.2.10	The U.S. does not have a requirement to mark helideck obstacle-free sectors.
5.2.12.2	The U.S. criterion places the air taxiway markers along the edges of the routes rather than on the centerline.
5.2.12.3	The U.S. criterion for air taxiway markers does not specify the viewing area or height to width ratio.
5.3.2.3	The U.S. heliport beacon flashes white-green-yellow colors rather than a series of timed flashes.
5.3.2.5*	The U.S. criteria is not specific on the light intensity of the flash.
5.3.3.3	The U.S. criterion specifies a 300 meters approach light system configuration. The light bars are spaced at 30 meters intervals. The first two bars of the configuration are single lights, the next two bars are two lights, then two bars with three lights, then two bars with four lights, and finally two bars with five lights.
5.3.3.4	The U.S. approach light system uses aimed PAR-56 lights.
5.3.3.6	The U.S. heliport approach light system does not contain flashing lights.
5.3.5.2 a)	The U.S. requires an odd number of lights, but not less than three lights per side.
5.3.5.2 b)	The U.S. requires a minimum of eight lights for a circular FATO and does not specify the distance between lights.
5.3.5.4*	The U.S. criteria does not specify light distribution.
5.3.6	The U.S. does not have specific criteria for aiming point lights.
5.3.8	The U.S. does not have standards for winching area lighting.
<b>Chapter 6</b>	<b>Heliport Services</b>
6.1*	The U.S. requirements for rescue and fire fighting services at certificated heliports are found in 14 CFR Part 139. Criteria for other heliports are established by the National Fire Protection Association (NFPA) pamphlets 403 or 418, or in regulations of local fire departments.

\*Indicates ICAO Recommended Practice

<b>ANNEX 15 – AERONAUTICAL INFORMATION SERVICES</b>	
<b>Chapter 1</b>	<b>General</b>
ASHTAM	The U.S. doesn't have a series of NOTAM called ASHTAM.
Danger area	Danger Areas do not exist in the U.S. Equivalent/similar areas are defined, designated & charted as Prohibited, Warning, Alert, and Restricted Areas.”
Pre-flight Information Bulletin (PIB)	The US does not use the term PIB.
Prohibited Area	Additional terminology used by the US.
Restricted Area	Additional terminology used by the US.
SNOWTAM	The US presents the information via a NOTAM.
1.1.20	The US does not use the term ASHTAM.
1.2.2.2	The U.S. utilizes Geoid-03 which is a component of the North American Vertical Datum of 1988 (NAVD 88).
<b>Chapter 5</b>	<b>Aeronautical Information Products and Services</b>
5.2.1	Currently, the U.S. does not utilize the ICAO format for domestic NOTAMs. The US NOTAMs that are distributed as International NOTAMs are in ICAO format (excluding the L/L).
5.2.5.1. f)	The US does not produce an Aircraft Parking / Docking Chart.
5.2.6	The U.S. does not use the term SNOWTAM.
<b>Chapter 6</b>	<b>Aeronautical Information Updates</b>
6.3.2.1	The U.S. does not routinely issue “trigger NOTAMs” referencing published material when an AIP amendment is issued.
6.3.2.3	The U.S. does not provide a NOTAM for accidental release of radioactive material, toxic chemicals, or volcanic ash deposition.

<b>ANNEX 16 – ENVIRONMENTAL PROTECTION</b>	
<b>VOLUME I – AIRCRAFT NOISE</b>	
Reference: Part 36 of Title 14 of the United States Code of Federal Regulations	
<b>Chapter 1</b>	
<b>1.7</b>	Each person who applies for a type certificate for an airplane covered by 14 CFR Part 36, irrespective of the date of application for the type certificate, must show compliance with Part 36.
<b>Chapter 2</b>	
2.1.1	For type design change applications made after 14 August 1989, if an airplane is a Stage 3 airplane prior to a change in type design, it must remain a Stage 3 airplane after the change in type design regardless of whether Stage 3 compliance was required before the change in type design.
2.3.1 a)	Sideline noise is measured along a line 450 meters from and parallel to the extended runway centerline for two- and three-engine aircraft; for four-engine aircraft, the sideline distance is 0.35 NM.
2.4.2	Noise level limits for Stage 2 derivative aircraft depend upon whether the engine by-pass ratio is less than two. If it is, the Stage 2 limits apply. Otherwise, the limits are the Stage 3 limits plus 3 dB or the Stage 2 value, whichever is lower.
2.4.2.2 b)	Take-off noise limits for three-engine, Stage 2 derivative airplanes with a by-pass ratio equal to or greater than 2 are 107 EPNdB for maximum weights of 385,000 kg (850,000 lb) or more, reduced by 4 dB per halving of the weight down to 92 EPNdB for maximum weights of 28,700 kg (63,177 lb) or less. Aircraft with a by-pass ratio less than 2 only need meet the Stage 2 limits.
2.5.1	Trade-off sum of excesses not greater than 3 EPNdB and no excess greater than 2 EPNdB.
2.6.1.1	For airplanes that do not have turbo-jet engines with a by-pass ratio of 2 or more, the following apply: <ul style="list-style-type: none"> <li>a) four-engine airplanes – 214 meters (700 feet);</li> <li>b) all other airplanes – 305 meters (1,000 feet).</li> </ul> For all airplanes that have turbo-jet engines with a by-pass ratio of 2 or more, the following apply: <ul style="list-style-type: none"> <li>a) four-engine airplanes – 210 meters (689 feet);</li> <li>b) three-engine airplanes – 260 meters (853 feet);</li> <li>c) airplanes with fewer than three engines – 305 meters (1,000 feet).</li> </ul> The power may not be reduced below that which will provide level flight for an engine inoperative or that will maintain a climb gradient of at least 4 percent, whichever is greater.
<b>Chapter 3</b>	
3.1.1	For type design change applications made after 14 August 1989, if an airplane is a Stage 3 airplane prior to a change in type design, it must remain a Stage 3 airplane after the change in type design regardless of whether Stage 3 compliance was required before the change in type design.
3.3.1 a) 2)	The U.S. has no equivalent provision in 14 CFR Part 36.
3.3.2.2	A minimum of two microphones symmetrically positioned about the test flight track must be used to define the maximum sideline noise. This maximum noise may be assumed to occur where the aircraft reaches 305 meters (1,000 feet).  14 CFR Part 36 does not require symmetrical measurements to be made at each and every point for propeller-driven airplane sideline noise determination.
3.6.2.1 c)	Under 14 CFR Part 36, during each test take-off, simultaneous measurements should be made at the sideline noise measuring stations on each side of the runway and also at the take-off noise measuring station. If test site conditions make it impractical to simultaneously measure take-off and sideline noise, and if each of the other sideline measurement requirements is met, independent measurements may be made of the sideline noise under simulated flight path techniques. If the reference flight path includes a power cutback before the maximum possible sideline noise level is developed, the reduced sideline noise level, which is the maximum value developed by the simulated flight path technique, must be the certificated sideline noise value.

3.6.2.1 d)	14 CFR Part 36 specifies the day speeds and the acoustic reference speed to be the minimum approved value of $V_2 + 10$ kt, or the all–engines operating speed at 35 feet (for turbine–engine powered airplanes) or 50 feet (for reciprocating–engine powered airplanes), whichever speed is greater as determined under the regulations constituting the type certification basis of the airplane. The test must be conducted at the test day speeds $\pm 3$ kt.
3.7.4	If a take–off test series is conducted at weights other than the maximum take–off weight for which noise certification is requested: a) at least one take–off test must be at or above that maximum weight; b) each take–off test weight must be within +5 or –10 percent of the maximum weight. If an approach test series is conducted at weights other than the maximum landing weight for which certification is requested: a) at least one approach test must be conducted at or above that maximum weight; b) each test weight must exceed 90 percent of the maximum landing weight. Total EPNL adjustment for variations in approach flight path from the reference flight path and for any difference between test engine thrust or power and reference engine thrust or power must not exceed 2 EPNdB.
<b>Chapter 5</b>	
5.1.1	Applies to all large transport category aircraft (as they do to all subsonic turbo–jet aircraft regardless of category). Commuter category aircraft, propeller–driven airplanes below 8,640 kg (19,000 lb) are subject to 14 CFR Part 36, Appendix F or to Appendix G, depending upon the date of completion of the noise certification tests.
<b>Chapter 6</b>	
6.1.1	Applies to new, all propeller–driven airplane types below 19,000 lb (8,640 kg.) in the normal, commuter, utility, acrobatic, transport, or restricted categories for which the noise certification tests are completed before 22 December 1988.
<b>Chapter 8</b>	
General	14 CFR Part 36 (Section 36.1 (h)) defines Stage 1 and Stage 2 noise levels and Stage 1 and Stage 2 helicopters. These definitions parallel those used in 14 CFR Part 36 for turbo–jets and are used primarily to simplify the acoustical change provisions in Section 36.11. 14 CFR Part 36 (Section 36.805(c)) provides for certain derived versions of helicopters for which there are no civil prototypes to be certificated above the noise level limits.
8.1.1 a)	Applicable to new helicopter types for which application for an original type certificate was made on or after 6 March 1988.
8.1.1 b)	Applicable only to “acoustical changes” for which application for an amended or supplemental type certificate was made on or after 6 March 1988.
8.4	14 CFR Part 36 Appendix H specifies a slightly different rate of allowable maximum noise levels as a function of helicopter mass. The difference can lead to a difference in the calculated maximum noise limits of 0.1 EPNdB under certain roundoff condition.
8.6.3.1 b)	Does not include the $V_{NE}$ speeds.
8.7	14 CFR Part 36 Appendix H does not permit certain negative corrections. Annex 16 has no equivalent provision.
8.7.4	EPNL correction must be less than 2.0 EPNdB for any combination of lateral deviation, height, approach angle and, in the case of flyover, thrust or power. Corrections to the measured data are required if the tests were conducted below the reference weight. Corrections to the measured data are required if the tests were conducted at other than reference engine power.
8.7.5	The rotor speed must be maintained within one percent of the normal operating RPM during the take–off procedure.
8.7.8	The helicopter shall fly within $\pm 10^\circ$ from the zenith for approach and take–off, but within $\pm 5^\circ$ from the zenith for horizontal flyover.

<b>Chapter 10</b>	
General	Exception from acoustical change rule given for aircraft with flight time prior to 1 January 1955 and land configured aircraft reconfigured with floats or skis.
10.1.1	Applies to new, amended, or supplemental type certificates for propeller-driven airplanes not exceeding 8,640 kg (19,000 lb) for which noise certification tests have not been completed before 22 December 1988.
10.4	The maximum noise level is a constant 73 dBA up to 600 kg (1,320 lb). Above that weight, the limit increases at the rate of 1 dBA/75kg (1 dBA/165 lb) up to 85 dBA at 1,500 kg (3,300 lb) after which it is constant up to and including 8,640 kg (19,000 lb).
10.5.2, second phase, d)	For variable-pitch propellers, the definition of engine power is different in the second segment of the reference path. Maximum continuous installed power instead of maximum power is used.
<b>Chapter 11</b>	
11.1	14 CFR Part 36 Appendix J was effective 11 September 1992 and applies to those helicopters for which application for a type certificate was made on or after 6 March 1986.
11.4	14 CFR Part 36 Appendix J specifies a slightly different rate of allowable maximum noise levels as a function of helicopter mass. The difference can lead to a difference in the calculated maximum noise limits of 0.1 EPNdB under certain roundoff condition.
11.6	14 CFR Part 36 Appendix J prescribes a ±15 meter limitation on the allowed vertical deviation about the reference flight path. Annex 16 has no equivalent provision.
<b>PART V</b>	
General	No comparable provision exists in U.S. Federal Regulations. Any local airport proprietor may propose noise abatement operating procedures to the FAA which reviews them for safety and appropriateness.
<b>Appendix 1</b>	
General	Sections 3, 8, and 9 of Appendix 1 which contain the technical specifications for equipment, measurement and analysis and data correction for Chapter 2 aircraft and their derivatives differ in many important aspects from the corresponding requirements in Appendix 2 which has been updated several times. 14 CFR Part 36 updates have generally paralleled those of Appendix 2 of Annex 16. These updated requirements are applicable in the U.S. to both Stage 2 and Stage 3 aircraft and their derivatives.
2.2.1	A minimum of two microphones symmetrically positioned about the test flight track must be used to define the maximum sideline noise. This maximum noise may be assumed to occur where the aircraft reaches 305 meters (1,000 feet), except for four-engine, Stage 2 aircraft for which 439 meters (1,440 feet) may be used.
2.2.2	No obstructions in the cone defined by the axis normal to the ground and the half-angle 80° from the axis.
2.2.3 c)	Relative humidity and ambient temperature over the sound path between the aircraft and 10 meters above the ground at the noise measuring site is such that the sound attenuation in the 8 kHz one-third octave band is not greater than 12 dB/100 meters and the relative humidity is between 20 and 95 percent. However, if the dew point and dry bulb temperature used for obtaining relative humidity are measured with a device which is accurate to within one-half a degree Celsius, the sound attenuation rate shall not exceed 14 dB/100 meters in the 8 kHz one-third octave band.
2.2.3 d)	Test site average wind not above 12 kt and average cross-wind component not above 7 kt.
2.3.4	The aircraft position along the flight path is related to the recorded noise 10 dB downpoints.
2.3.5	At least one take-off test must be a maximum take-off weight and the test weight must be within +5 or -10 percent of maximum certificated take-off weight.
<b>Appendix 2</b>	
2.2.1	A minimum of two symmetrically placed microphones must be used to define the maximum sideline noise at the point where the aircraft reaches 305 meters.

2.2.2	When a multiple layering calculation is required, the atmosphere between the airplane and the ground shall be divided into layers. These layers are not required to be of equal depth, and the maximum layer depth must be 100 meters.
2.2.2 b)	14 CFR Part 36 specifies that the lower limit of the temperature test window is 36 degrees Fahrenheit (2.2 degrees Celsius). Annex 16 provides 10 degrees Celsius as the lower limit for the temperature test window. 14 CFR Part 36 does not specify that the airport facility used to obtain meteorological condition measurements be within 2,000 meters of the measurement site.
2.2.2 c)	14 CFR Part 36 imposes a limit of 14 dB/100 meters in the 8 kHz one-third octave band when the temperature and dew point are measured with a device which is accurate to within one-half a degree Celsius.
2.2.3	14 CFR Part 36 requires that the limitations on the temperature and relative humidity test window must apply over the whole noise propagation path between a point 10 meters above the ground and the helicopter. Annex 16 specifies that the limitations on the temperature and relative humidity test window apply only at a point 10 meters above the ground. 14 CFR Part 36 requires that corrections for sound attenuation must be based on the average of temperature and relative humidity readings at 10 meters and the helicopter. Annex 16 implies that the corrections for sound absorption are based on the temperature and relative humidity measured at 10 meters only.
3.2.6	No equivalent requirement.
3.4.5	For each detector/integrator the response to a sudden onset or interruption of a constant sinusoidal signal at the respective one-third octave band center frequency must be measured at sampling times 0.5, 1.0, 1.5, and 2.0 seconds after the onset or interruption. The rising responses must be the following amounts before the steady-state level: 0.5 seconds: $4.0 \pm 1.0$ dB 1.0 seconds: $1.75 \pm 0.75$ dB 1.5 seconds: $1.0 \pm 0.5$ dB 2.0 seconds: $0.6 \pm 0.5$ dB
3.4.5 (Note 1)	No equivalent provision in 14 CFR Part 36.
3.5.2	No equivalent requirement.
5.4	14 CFR Part 36 requires that the difference between airspeed and groundspeed shall not exceed 10 kt between the 10 dB down time period.
8.4.2	14 CFR Part 36 specifies a value of –10 in the adjustment for duration correction. Annex 16 specifies a value of –7.5.
9.1.2, 9.1.3	14 CFR Part 36 always requires use of the integrated procedure if the corrected take-off or approach noise level is within 1.0 dB of the applicable noise limit.
<b>Appendix 6</b>	
4.4.1	The microphone performance, not its dimensions, is specified. The microphone must be mounted 1.2 meters (4 feet) above ground level. A windscreen must be employed when the wind speed is in excess of 9 km/h (5 kt).
5.2.2 a)	Reference conditions are different. Noise data outside the applicable range must be corrected to 77 degrees F and 70 percent humidity.
5.2.2 c)	There is no equivalent provision in 14 CFR Part 36. Fixed-pitch propeller-driven airplanes have a special provision. If the propeller is fixed-pitch and the test power is not within 5 percent of reference power, a helical tip Mach number correction is required.



<b>ANNEX 16 – ENVIRONMENTAL PROTECTION</b>	
<b>VOLUME II – AIRCRAFT ENGINE EMISSIONS</b>	
<b>Chapter 1</b>	
	The U.S. currently has regulations prohibiting intentional fuel venting from turbojet, turbofan and turboprop aircraft, but we do not now have a regulation preventing the intentional fuel venting from helicopter engines.

**ANNEX 17 – SECURITY – SAFEGUARDING INTERNATIONAL CIVIL AVIATION AGAINST ACTS OF UNLAWFUL INTERFERENCE**

There are no reportable differences between U.S. regulations and the Standards and Recommended Practices contained in this Annex.

<b>ANNEX 18 – THE SAFE TRANSPORT OF DANGEROUS GOODS BY AIR</b>
Adopted by the ICAO Council 6/26/81
Effective Date: 1/1/83
Applicability Date: 1/1/84
(Note: Differences are to be filed with ICAO by 6/1/83).

<b>Chapter 1</b>	<b>General</b>
1.2.2.2	The U.S. utilizes Geoid–03 which is a component of the North American Vertical Datum of 1988 (NAVD 88).
1.1 ASHTAM	The U.S. doesn’t have a series of NOTAM called ASHTAM, although notification procedures are written on handling of Volcanic Ash activity.
1.1 Danger area	“Danger area” is not used in reference to areas within the U.S. or in any of its possessions or territories.
1.1 Maneuvering area	Any locality either on land, water, or structures, including airports/heliports and intermediate landing fields, which is used, or intended to be used, for the landing and takeoff of aircraft whether or not facilities are provided for the shelter, servicing, or for receiving or discharging passengers or cargo.
1.1 Movement area	The runways, taxiways, and other areas of an airport/heliport which are utilized for taxiing/hover–taxiing, air–taxiing, takeoff, and landing of aircraft, exclusive of loading ramps and parking areas. At those airports/heliports with a tower, specific approval for entry onto the movement area must be obtained from ATC.
1.1 Pre–flight Information Bulletin (PIB)	The US does not use the term PIB. However, current NOTAM information is gathered and available through different sources.
1.1 SNOWTAM	The US presents the information in a different manner via a NOTAM.
<b>Chapter 3</b>	<b>Aeronautical Information Management</b>
3.6.1	Current quality management system applies only to the Aeronautical Information Services.
<b>Chapter 5</b>	<b>Aeronautical Information Products and Services</b>
5.2.2	The FAA does not use PIBs, but does provide pertinent NOTAM information in plain language form every 28 days in a document called the Notices to Air Missions Publication (NTAP).
5.2.5.1. f)	The US does not produce an Aircraft Parking / Docking Chart.
5.3.3.4.1	The United States does not publish the horizontal extent of obstacles.
<b>Chapter 6</b>	<b>Aeronautical Information Updates</b>
6.3.2.1	The U.S. does not routinely issue “trigger NOTAMs” referencing published material when an AIP amendment is issued.
6.3.2.3	The U.S. does not provide a NOTAM for accidental release of radioactive material, toxic chemicals, or volcanic ash deposition.

<b>ANNEX 19 – SAFETY MANAGEMENT</b>	
<b>Chapter 3</b>	<b>State Safety Management Responsibilities</b>
3.3.2.1	U.S. does not currently require the implementation of SMS by approved training organizations that are exposed to safety risks related to aircraft operations during the provision of their services; some operators of aeroplanes or helicopters authorized to conduct international commercial air transport; approved maintenance organizations providing services to operators of aeroplanes or helicopters engaged in international commercial air transport; organizations responsible for the type design or manufacture of aircraft, engines or propellers; and operators of certified aerodromes.
3.3.2.3	The U.S. has not established criteria for international general aviation operators of large or turbojet aeroplanes to implement an SMS.

<b>PANS – OPS – 8168/611</b>	
<b>VOLUME I – Flight Procedures</b>	
<b>PART III</b>	
Table III-1-1 and Table III-1-2	Max speeds for visual maneuvering (Circling)” must not be applied to circling procedures in the U.S. Comply with the airspeeds and circling restrictions in ENR 1.5, paragraphs 11.1 and 11.6, in order to remain within obstacle protection areas.
<b>PART IV</b>	
1.2.1	The airspeeds contained in ENR 1.5 shall be used in U.S. <b>CONTROLLED AIRSPACE</b> .
<b>VOLUME III – Aircraft Operating Procedures</b>	
<b>Section 10 – Flight Tracking</b>	
1.2.1	The United States has notified differences to the distress tracking standards in Annex 6, Part I, 6.18. Consistent with those differences, the United States does not require U.S. operators to establish training programs and procedures specific to autonomous distress tracking and will not perform surveillance of implementation by U.S. operators.
1.2.2	FAA Order JO 7210.632, Air Traffic Organization Occurrence Reporting, establishes mandatory occurrence reporting (MOR) requirements and format for FAA employees, including reports sourced from operators and missed position reporting. The MOR Report form includes most, but not all, of the template in the Appendix to Ch. 1.
1.2.3	The United States has notified differences to the distress tracking standards in Annex 6, Part I, 6.18. Consistent with those differences, the United States does not require U.S. operators to maintain contact details in the ICAO OPS CTRL.

**PAN – ABC – DOC 8400**

Differences between abbreviations used in U.S. AIP, International NOTAMs Class I and Class II, and Notices to Air Missions Publication and ICAO PANS – ABC are listed in GEN 2.2. For other U.S. listings of abbreviations (contractions) for general use, air traffic control, and National Weather Service (NWS), which differ in some respects, see U.S. publication Contractions Handbook (FAA Order JO 7340.2). In addition, various U.S. publications contain abbreviations of terms used therein, particularly those unique to that publication.

## GEN 2. TABLES AND CODES

### GEN 2.1 Measuring System, Time System, and Aircraft Markings

#### 1. Units of Measurement

1.1 The following table identifies the units of measurement that have been selected for use in messages transmitted by all U.S. aeronautical stations, in the U.S. AIP, NOTAM dissemination, and other publications.

#### 2. Time System

2.1 Coordinated Universal Time (UTC) is used in the Air Traffic and Communication services provided and in most documents published by the Aeronautical Information Services.

2.2 When local mean time is used, it will be so indicated as local standard time (LST). See FIG GEN 2.1-1 for a depiction of the standard time zones within the continental U.S.

#### 3. Geodetic Reference Datum

3.1 All published geographic coordinates indicating latitude and longitude are expressed in terms of the World Geodetic System – 1984 (WGS-84) geodetic reference datum.

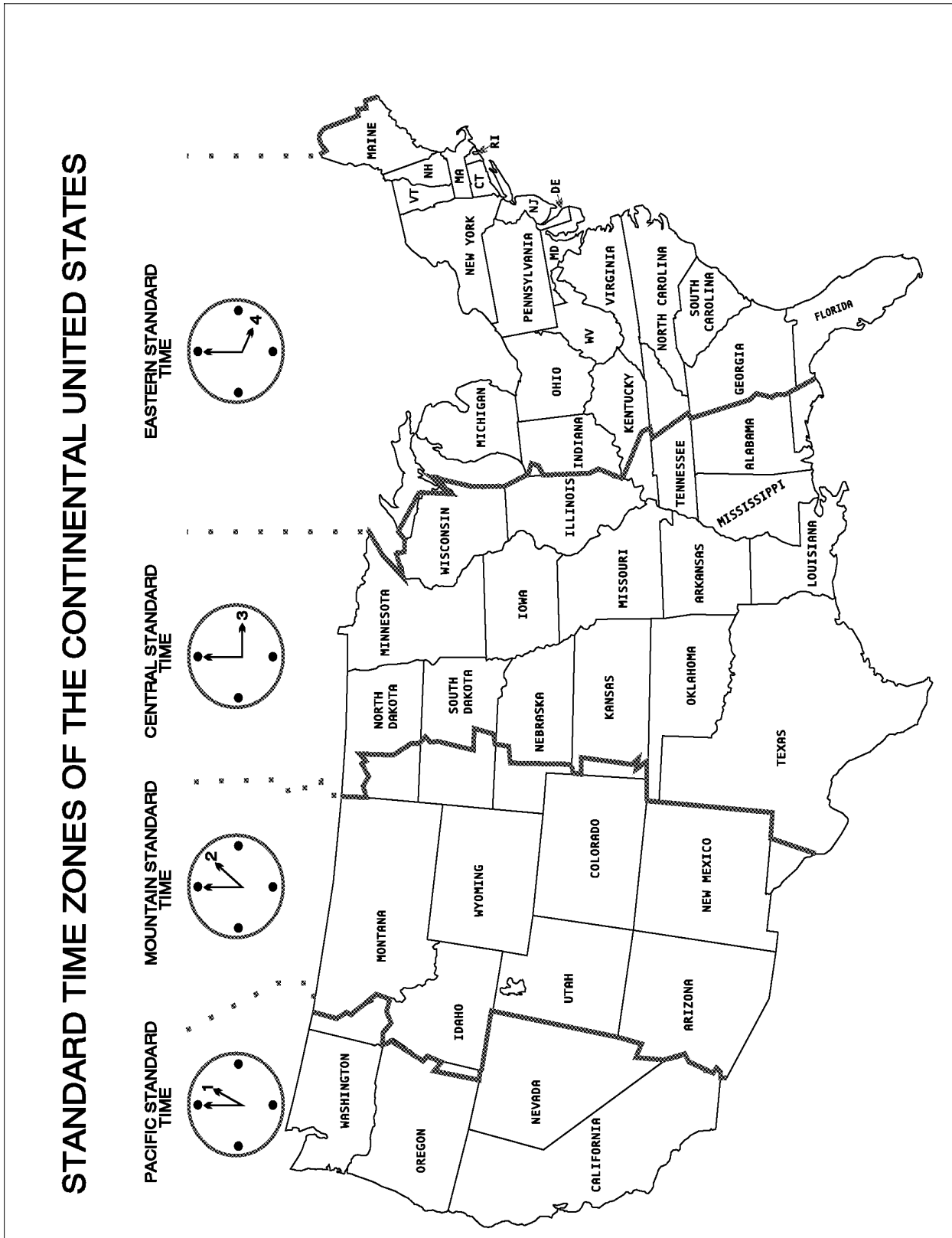
#### 4. Nationality and Registration Marks

4.1 The nationality mark for the aircraft registered in the U.S. is the letter N, followed by a series of numbers or a series of numbers and letters.

TBL GEN 2.1-1

For Measurements of:	Units used:
Distance used in navigation, position reporting, etc. – generally in excess of 2 to 3 nautical miles	Nautical miles and tenths
Relatively short distances such as those relating to aerodrome (e.g., runway lengths)	Feet
Altitudes, elevations and heights	Feet
Horizontal speed, including wind speed	Knots
Vertical speed	Feet per minute
Wind direction for landing and taking off	Degrees magnetic
Wind direction except for landing and taking off	Degrees true
Visibility, including runway visual	Statute miles or feet
Altimeter Setting	Inches of mercury
Temperature	Degrees Fahrenheit
Weight	Pounds
Time	Hours and minutes, the day of 24 hours beginning at midnight Coordinated Universal Time

FIG GEN 2.1-1





## GEN 2.2 Abbreviations Used in AIS Publications

**NOTE-**

An “s” may be added for plural. ICAO indicates ICAO usage.

<b>A</b>	
/	and
A/C	approach control
AAM	Advanced Air Mobility
AAS	airport advisory service
ICAO:	AAP – approach control; AC – altocumulus
ACFT	aircraft
ACR	air carrier
ADF	automatic direction finder
AER	approach end runway
AFIS	Automatic Flight Information Service
AFT	after
AGL	above ground level
AHRS	Attitude Heading Reference System
AIM	Aeronautical Information Manual
AIS	Aeronautical Information Services
ALS	approach light system
ALSF-1	standard 2400’ high-intensity approach lighting system with sequenced flashers (Category I configuration)
ALSF-2	standard 2400’ high-intensity approach lighting system with sequenced flashers (Category II configuration)
ALSTG	altimeter setting
ALT	altitude
ALTM	altimeter
ALTN	alternate
AMDT	amendment
ICAO:	AMD – amendment
APCH	approach
APCHG	approaching
APRX	approximate
APV	approve or approved or approval
ARAC	Army Radar Approach Control facility (US Army)
ARPT	airport
ATO	Air Traffic Organization
ICAO:	AD – aerodrome
ARR	arrive or arrival
ARSR	air route surveillance radar

ARTCC	air route traffic control center
ASDE	airport surface detection equipment
ASPH	asphalt
ASSC	Airport Surface Surveillance Capability
ATCT	air traffic control tower
ATD	along-track distance
ASR	airport surveillance radar
ATIS	automatic terminal information service
AVBL	available
AWY	airway
<b>B</b>	
BC	back course
BCN	beacon
BCST	broadcast
BLDG	building
BRG	bearing
BTN	between
BVLOS	Beyond Visual Line of Sight
BYD	beyond
<b>C</b>	
CAT	category
ICAO:	CAT – clear air turbulence
CBO	Community-Based Organization
CFR	Code of Federal Regulations
CFR	crash fire rescue
CLNC	clearance
ICAO:	CLR – clear/cleared to/clearance
CLSD	close or closed or closing
CMSND	commissioned
CNTR	center
CNTRLN	centerline
ICAO:	CL – centerline
COA	Certificate of Waiver or Authorization
COMLO	compass locator
CONST	construction
CPTY	capacity
CRS	course
CTC	contact
ICAO:	CTR – control zone

<b>D</b>	
ICAO:	D – danger area
ICAO:	D – downward (tendency in RVR during previous 10 minutes)
DALGT	daylight
DCMSND	decommissioned
DDT	runway weight bearing capacity for aircraft with double dual-tandem type landing gear
DEGS	degrees
ICAO:	C – degrees Celsius (Centigrade) F – degrees Fahrenheit
DEP	depart; departure
ICAO:	DEP – depart/departure/departure message
DF	direction finder
ICAO:	DF – I am connecting you to the station you request
DH	decision height
DME	UHF standard (TACAN compatible distance measuring equipment)
ICAO:	DME – distance measuring equipment
DSPLCD	displaced
DSTC	distance
ICAO:	DIST – distance
DT	runway weight bearing capacity for aircraft with dual-tandem type landing gear
DURG	during
ICAO:	DRG – during
DVFR	defense visual flight rule
DW	runway weight bearing capacity for aircraft with dual-wheel type landing gear
<b>E</b>	
E	east
ICAO:	E – east/east longitude
EQUIP	equipment
ICAO:	EQPT – equipment
ETA	estimated time of arrival
ETE	estimated time en route
EXCP	except
ICAO:	EXC–except
EXTD	extend or extended
<b>F</b>	
FAF	final approach fix
FAR	Federal Aviation Regulation

FDC	flight data center
FI/P	flight information (permanent)
FI/T	flight information (temporary)
FL	flight level
FM	fan marker
FM	from
ICAO:	FM – from; FM – from (followed by time weather change is forecast to begin)
FREQ	frequency
FRIA	FAA-Recognized Identification Area
FRQ	frequent
FSS	Flight Service Station
FT	feet
<b>G</b>	
GOVT	government
GP	glide path
ICAO:	GP – glide path
GS	glide slope
ICAO:	GS – ground speed; GS – small hail and/or snow pellets
GWT	gross weight
<b>H</b>	
HAA	height above airport
HAT	height above touchdown
HAZMAT	Hazardous Material
ICAO:	HGT – height/height above
HIRL	High intensity runway lights
HOL	holiday
HWY	highway
<b>I</b>	
IAF	initial approach fix
IAP	instrument approach procedure
ICAO:	INA – initial approach
IDENT	identification
ICAO:	ID – identifier/identification/identify
IF	intermediate fix
ICAO:	IF – intermediate approach fix
IFR	instrument flight rules
IFSS	international flight service station
ILS	instrument landing system
INFO	information
INOP	inoperative
INS	Inertial Navigation System
INT	intersection

INTL	international
INTST	intensity
IRU	Inertial Reference Unit
<b>J</b>	
J-bar	jet runway barrier
<b>K</b>	
KHZ	kilohertz
<b>L</b>	
L	left (used only to designate rwys; e.g., rwy 12L)
ICAO:	L – left/runway identification/locator
LAANC	Low Altitude Authorization and Notification Capability
LAT	latitude
LB	pounds (weight)
LCTD	located
LDA	localizer type directional aid
ICAO:	LDA – landing distance available LLZ – localizer
LGTD	lighted
LMM	compass locator at ILS middle marker
LNDG	landing
ICAO:	LDG – landing
LOC	localizer
ICAO:	LOC–localizer or locally or location or located
LOM	compass locator at ILS outer marker
LONG	longitude
LRCO	limited remote communications outlet
<b>M</b>	
MAA	maximum authorized altitude
MAG	magnetic
MAINT	maintain, maintenance
ICAO:	MNTN – maintain; MAINT – maintenance
MALS	medium intensity approach light system
MALSR	medium intensity approach light system with runway alignment indicator lights
MAP	missed approach point
ICAO:	MAP – aeronautical maps and charts
MAX	maximum
MCA	minimum crossing altitude
MDA	minimum descent altitude
MEA	minimum en route IFR altitude
MGOW	Maximum Gross Operating Weight
MHZ	megahertz

MIN	minimum or minute
MIRL	medium intensity runway edge lights
MM	middle marker ILS
MOCA	minimum obstruction clearance altitude
MRA	minimum reception altitude
MSA	minimum safe altitude
MSL	mean sea level
MUNI	municipal
<b>N</b>	
N	north
NA	not authorized
NATL	national
NAVAID	navigational aid
NDB	nondirectional radio beacon
NM	nautical mile(s)
NOPT	no procedure turn required
NR	number
<b>O</b>	
OBSTN	obstruction
OCA	Oceanic Control Area
ODALS	omnidirectional approach lighting system
OM	outer marker ILS
OOP	Operations Over People
OPER	operate
OPN	operation
ICAO:	OPR – operator/operate/operative/operating/operational
ORIG	original
OTS	out of service
OVRN	overrun
<b>P</b>	
PAO	Public Aircraft Operation
PAR	precision approach radar
PAT	pattern
PBCS	Performance-Based Communication and Surveillance
PCN	pavement classification number
PERMLY	permanently
PIC	Pilot-in-Command
POB	persons on board
PPR	prior permission required
PROC	procedure

<b>Q</b>	
QUAD	quadrant
<b>R</b>	
R	right (used only to designate rwys; e.g., rwy 19R)
ICAO:	R – received (acknowledgement of receipt)/red/restricted area (followed by identification)/right (runway identification)
RADAR	radio detection and ranging
RAPCON	Radar Approach Control facility (USAF, USN and USMC)
RATCF	Radar Air Traffic Control Facility (USN and USMC)
RC	Radio-Controlled
RCAG	remote communications air/ground
RCLS	runway centerline lights system
ICAO:	RCL – runway centerline
RCO	remote communications outlet
RCV	receive
RCVG	receiving
REIL	runway end identifier lights
REQ	request
RID	Remote Identification
RNAV	area navigation
RPIC	Remote Pilot-in-Command
RRP	runway reference point
REL	runway entrance lights
RLLS	Runway Lead-in Light System
RSTRD	restricted
RTS	returned to service
RVR	runway visual range
RVRM	runway visual range midpoint
RVRR	runway visual range rollout
RVRT	runway visual range touchdown
RWSL	runway status light
RWY	runway
ICAO:	RWY–runway
<b>S</b>	
S	runway weight bearing capacity for aircraft with single-wheel type landing gear
S	south
ICAO:	S – south/south latitude
SAA	Sense and Avoid
SDF	simplified directional facility

SEC	second
SFC	surface
SFL	sequenced flashing lights
SGI	Special Government Interest
SI	straight-in approach
ICAO:	STA – straight-in approach
SM	statute mile(s)
SR	sunrise
SS	sunset
ICAO:	SS – sandstorm
SSALF	simplified short approach lighting system with sequenced flashers
SSALR	simplified short approach lighting system with runway alignment indicator lights
SSALS	simplified short approach lighting system
STOL	short take-off and landing runway
ICAO:	STOL – short takeoff and landing
sUAS	Small UAS
SVC	service
ICAO:	SVC – service message
<b>T</b>	
T	true (after a bearing)
ICAO:	T – temperature
TAC	terminal area chart
TACAN	UHF navigational facility – omnidirectional course and distance information
ICAO:	TACAN – VHF tactical navigational aid
TAS	true air speed
TCH	threshold crossing height
ICAO:	TEMPO – Temporary/temporarily
TFC	traffic
THL	takeoff hold lights
THR	threshold
THRU	through
ICAO:	THRU – through/I am connecting you to another switchboard
TKOF	take-off
TEMPRLY	temporarily
ICAO:	TMA – TERMINAL CONTROL AREA
TMPRY	temporary/temporarily
TPA	traffic pattern altitude

TRACON	terminal radar approach control
TRML	terminal
TRSA	terminal radar service area
TRUST	The Recreational UAS Safety Test
TSNT	transient
TWR	tower
TWY	taxiway
<b>U</b>	
ICAO:	U/S – unserviceable
UAM	Urban Air Mobility
UAS	Unmanned Aircraft System
UASFM	UAS Facility Map
UAVBL	unavailable
UHF	ultra high frequency
UNLGTD	unlighted
UNMON	unmonitored
UNSKED	unscheduled
UNUSBL	unusable
UTM	UAS Traffic Management
<b>V</b>	
VASI	visual approach slope indicator
VCNTY	vicinity
VDP	visual descent point

VFR	visual flight rules
VHF	very high frequency
VOR	VHF omni-directional radio range
VLOS	Visual Line of Sight
VO	Visual Observer
VORTAC	Combined VOR and TACAN system (collocated)
VOT	a VOR Receiver testing facility
VSBY	visibility
ICAO:	VIS – visibility
<b>W</b>	
W	west
WEA	weather
ICAO:	WX – weather
WKDAY	weekday
WKEND	weekend
WPT	waypoint
WS	Weather Service
WT	weight
<b>Z</b>	
Z	Coordinated Universal Time
ICAO:	UTC – Coordinated Universal Time



## **GEN 2.3 Chart Symbols**

Aeronautical chart symbols are published in the Aeronautical Chart User's Guide published by Aeronautical Information Services (AIS). The guide is available in PDF format for print, download, or viewing at:

[http://www.faa.gov/air\\_traffic/flight\\_info/aeronav/digital\\_products/aero\\_guide/](http://www.faa.gov/air_traffic/flight_info/aeronav/digital_products/aero_guide/)





## GEN 2.4 Location Indicators

Location identifiers authorized by the Federal Aviation Administration, Department of the Navy, and Transport Canada and U.S. airspace fixes and procedure codes are published in FAA Order JO 7350.9, Location Identifiers. ■



## **GEN 2.5 List of Radio Navigation Aids**

A listing of navigation aids is not available. See individual aeronautical charts for specific information.



## GEN 2.6 Conversion Tables

TBL GEN 2.6-1

ft/M										
ft	0	1	2	3	4	5	6	7	8	9
0	0	0.30	0.61	0.91	1.22	1.52	1.83	2.13	2.44	2.74
10	3.05	3.35	3.66	3.96	4.27	4.57	4.88	5.18	5.49	5.79
20	6.10	6.40	6.71	7.01	7.32	7.62	7.92	8.23	8.53	8.84
30	9.14	9.45	9.75	10.06	10.36	10.67	10.97	11.28	11.58	11.89
40	12.19	12.50	12.80	13.11	13.41	13.72	14.02	14.33	14.73	14.94
50	15.24	15.54	15.85	16.15	16.46	16.76	17.07	17.37	17.68	17.98
60	18.29	18.59	18.90	19.20	19.51	19.81	20.12	20.42	20.73	21.03
70	21.34	21.64	21.95	22.25	22.56	22.86	23.16	23.47	23.77	24.08
80	24.38	24.69	24.99	25.30	25.60	25.91	26.21	26.52	26.82	27.13
90	27.43	27.74	28.04	28.35	28.65	28.96	29.26	29.57	29.87	30.18
	0	10	20	30	40	50	60	70	80	90
100	30.48	33.53	36.58	39.62	42.67	45.72	48.77	51.82	54.86	57.91
200	60.96	64.01	67.06	70.10	73.15	76.20	79.25	82.30	85.34	88.39
300	91.44	94.49	97.54	100.53	103.63	106.68	109.73	112.78	115.82	118.87
400	121.92	124.97	128.02	131.06	134.11	137.16	140.21	143.26	146.30	149.35
500	152.40	155.45	158.50	161.54	164.59	167.64	170.69	173.74	176.78	179.83
600	182.88	185.93	188.98	192.02	195.07	198.12	201.17	204.22	207.26	210.31
700	213.36	216.41	219.46	222.50	225.55	228.60	231.65	234.70	237.74	240.79
800	243.84	246.89	249.94	252.98	256.03	259.09	262.13	265.18	268.22	271.27
900	274.32	277.37	280.42	283.42	286.51	289.56	292.61	295.66	298.70	301.75
	0	100	200	300	400	500	600	700	800	900
1000	304.80	335.28	365.76	396.24	426.72	457.20	487.68	518.16	548.64	579.12
2000	609.60	640.08	670.56	701.04	731.52	762.00	792.48	822.96	853.44	883.92
3000	914.40	944.88	975.36	1005.8	1036.3	1066.8	1097.3	1127.8	1158.2	1188.7
4000	1219.2	1249.7	1280.2	1310.6	1341.6	1371.6	1402.1	1432.6	1463.0	1493.5
5000	1524.0	1554.5	1585.0	1615.4	1645.9	1676.4	1706.9	1737.4	1767.8	1798.3
6000	1828.8	1859.3	1889.8	1920.2	1950.7	1981.2	2011.7	2042.2	2072.6	2103.1
7000	2133.6	2164.1	2194.6	2225.0	2255.5	2286.0	2316.5	2347.0	2377.4	2407.9
8000	2438.4	2468.9	2499.4	2529.8	2560.3	2590.8	2621.3	2651.8	2682.2	2712.7
9000	2743.2	2773.7	2804.2	2834.6	2865.1	2895.6	2926.1	2956.6	2987.0	3017.5
	0	1000	2000	3000	4000	5000	6000	7000	8000	9000
10000	3048.0	3352.8	3657.6	3962.4	4267.2	4572.0	4876.8	5181.6	5486.4	5791.2
20000	6096.0	6400.8	6705.6	7010.4	7315.2	7620.0	7924.8	8229.6	8534.4	8839.2
30000	9144.0	9448.8	9753.6	10058	10363	10668	10937	11278	11582	11887
40000	12192	12497	12802	13106	13411	13716	14021	14326	14630	14935
50000	15240	15545	15850	16154	16459	16764	17069	17374	17678	17983

TBL GEN 2.6-2

M/ft										
M	0	1	2	3	4	5	6	7	8	9
0	0	3.28	6.56	9.84	13.12	16.40	19.68	22.97	26.25	29.53
10	32.81	36.09	39.37	42.65	45.93	49.21	52.49	55.77	59.05	62.34
20	65.62	68.90	72.18	75.46	78.74	82.02	85.30	88.58	91.86	95.14
30	98.42	101.70	104.99	108.27	111.55	114.83	118.11	121.39	124.67	127.95
40	131.23	134.51	137.79	141.07	144.36	147.64	150.92	154.20	157.48	160.76
50	164.04	167.32	170.60	173.88	177.16	180.44	183.72	187.01	190.29	193.57
60	196.85	200.13	203.41	206.69	209.97	213.25	216.53	219.81	223.09	226.38
70	229.66	232.94	236.22	239.50	242.78	246.06	249.34	252.62	255.90	259.18
80	262.46	265.74	269.03	272.31	275.59	278.87	282.15	285.43	288.71	291.99
90	295.27	298.55	301.83	305.11	308.40	311.68	314.96	318.24	321.52	324.80
	0	10	20	30	40	50	60	70	80	90
100	328.08	360.89	393.70	426.50	459.31	492.12	524.93	557.74	590.54	623.35
200	656.16	688.97	721.78	754.58	787.39	820.20	853.01	885.82	918.62	951.43
300	984.24	1017.0	1049.9	1082.7	1115.5	1148.3	1181.1	1213.9	1246.7	1279.5
400	1312.3	1345.1	1377.9	1410.7	1443.6	1476.4	1509.2	1542.0	1574.8	1607.6
500	1640.4	1673.2	1706.0	1738.8	1771.6	1804.4	1837.2	1870.1	1902.9	1935.7
600	1968.5	2001.3	2034.1	2066.9	2099.7	2132.5	2165.3	2198.1	2230.9	2263.8
700	2296.6	2329.4	2362.2	2395.0	2427.8	2460.6	2493.4	2526.2	2559.0	2591.8
800	2624.6	2657.4	2690.3	2723.1	2755.9	2788.7	2821.5	2854.3	2887.1	2919.9
900	2952.7	2985.5	3018.3	3051.1	3084.0	3116.8	3149.6	3182.4	3215.2	3248.0
	0	100	200	300	400	500	600	700	800	900
1000	3280.8	3608.0	3937.0	4265.0	4593.1	4921.2	5249.3	5577.4	5905.4	6233.5
2000	6561.6	6889.7	7217.8	7545.8	7873.9	8202.0	8530.1	8858.2	9186.2	9514.3
3000	9842.4	10170	10499	10827	11155	11483	11811	12139	12467	12795
4000	13123	13451	13779	14107	14436	14764	15092	15420	15748	16076
5000	16404	16732	17060	17388	17716	18044	18372	18701	19029	19357
6000	19685	20013	20341	20669	20997	21325	21653	21981	22309	22638
7000	22966	23294	23622	23950	24278	24606	24934	25262	25590	25918
8000	26246	26574	26903	27231	27559	27887	28215	28543	28871	29199
9000	29527	29855	30183	30511	30840	31168	31496	31824	32152	32480

TBL GEN 2.6-3

<b>INTERNATIONAL NAUTICAL MILES TO STATUTE MILES</b>										
1 nautical mile = 6,076.10 feet or 1,852 meters 1 statute mile = 5,280 feet or 1,609.35 meters										
<b>NM</b>	0	1	2	3	4	5	6	7	8	9
0	0.000	1.151	2.302	3.452	4.603	5.754	6.905	8.055	9.206	10.357
10	11.508	12.659	13.809	14.960	16.111	17.262	18.412	19.563	20.714	21.865
20	23.016	24.166	25.317	26.468	27.619	28.769	29.920	31.071	32.222	33.373
30	34.523	35.674	36.825	37.976	39.126	40.277	41.428	42.579	43.730	44.880
40	46.031	47.182	48.333	49.483	50.634	51.785	52.936	54.087	55.237	56.388
50	57.539	58.690	59.840	60.991	62.142	63.293	64.444	65.594	66.745	67.896
60	69.047	70.197	71.348	72.499	73.650	74.801	75.951	77.102	78.253	79.404
70	80.554	81.705	82.856	84.007	85.158	86.308	87.459	88.610	89.761	90.911
80	92.062	93.213	94.364	95.515	96.665	97.816	98.967	100.118	101.268	102.419
90	103.570	104.721	105.871	107.022	108.173	109.324	110.475	111.625	112.776	113.927

TBL GEN 2.6-4

<b>STATUTE MILES TO INTERNATIONAL NAUTICAL MILES</b>										
<b>SM</b>	0	1	2	3	4	5	6	7	8	9
0	0.000	0.869	1.738	2.607	3.476	4.345	5.214	6.083	6.952	7.821
10	8.690	9.559	10.428	11.297	12.166	13.035	13.904	14.773	15.642	16.511
20	17.380	18.249	19.118	19.986	20.855	21.724	22.593	23.462	24.331	25.200
30	26.069	26.938	27.807	28.676	29.545	30.414	31.283	32.152	33.021	33.890
40	34.759	35.628	36.497	37.366	38.235	39.104	39.973	40.842	41.711	42.580
50	43.449	44.318	45.187	46.056	46.925	47.794	48.663	49.532	50.401	51.270
60	52.139	53.008	53.877	54.746	55.615	56.484	57.353	58.222	59.091	59.959
70	60.828	61.697	62.566	63.435	64.304	65.173	66.042	66.911	67.780	68.649
80	69.518	70.387	71.256	72.125	72.994	73.863	74.732	75.601	76.470	77.339
90	78.208	79.077	79.946	80.815	81.684	82.553	83.422	84.291	85.160	86.029

TBL GEN 2.6-5

CONVERSION TABLE – NM/ft										
NM	0	1	2	3	4	5	6	7	8	9
0	0	607	1215	1822	2430	3037	3645	4252	4860	5467
1	6075	6682	7289	7897	8504	9112	9719	10327	10934	11542
2	12149	12757	13364	13971	14579	15186	15794	16401	17009	17616
3	18224	18831	19439	20046	20653	21261	21868	22476	23083	23691
4	24298	24906	25513	26121	26728	27335	27943	28550	29158	29765
5	30373	30980	31588	32195	32803	33410	34017	34625	35232	35840
6	36447	37055	37662	38270	38877	39485	40092	40700	41307	41914
7	42522	43129	43737	44344	44952	45559	46167	46774	47382	47989
8	48596	49204	49811	50419	51026	51634	52241	52849	53456	54064
9	54671	55278	55886	56493	57101	57708	58316	58923	59531	60138

TBL GEN 2.6-6

CONVERSION TABLE – ft/NM										
ft	0	1	2	3	4	5	6	7	8	9
0	0	0.016	0.033	0.049	0.066	0.082	0.099	0.115	0.132	0.148
1000	0.165	0.181	0.197	0.214	0.230	0.247	0.263	0.280	0.296	0.313
2000	0.329	0.346	0.362	0.379	0.395	0.411	0.428	0.444	0.461	0.477
3000	0.494	0.510	0.527	0.543	0.560	0.576	0.593	0.609	0.625	0.642
4000	0.658	0.675	0.691	0.708	0.724	0.741	0.757	0.774	0.790	0.806
5000	0.823	0.839	0.856	0.872	0.889	0.905	0.922	0.938	0.955	0.971
6000	0.988	1.004	1.020	1.037	1.053	1.070	1.086	1.103	1.119	1.136
7000	1.152	1.169	1.185	1.202	1.218	1.234	1.251	1.267	1.284	1.300
8000	1.317	1.333	1.350	1.366	1.383	1.399	1.416	1.432	1.448	1.465
9000	1.481	1.498	1.514	1.531	1.547	1.564	1.580	1.597	1.613	1.629
	0	1000	2000	3000	4000	5000	6000	7000	8000	9000
10000	1.646	1.811	1.975	2.140	2.304	2.469	2.634	2.798	2.963	3.127
20000	3.292	3.457	3.621	3.786	3.950	4.115	4.280	4.444	4.609	4.773
30000	4.938	5.103	5.267	5.432	5.596	5.761	5.926	6.090	6.255	6.419
40000	6.584	6.749	6.913	7.078	7.242	7.407	7.572	7.736	7.901	8.065
50000	8.230	8.395	8.559	8.724	8.888	9.053	9.218	9.382	9.547	9.711



TBL GEN 2.6-7

MB/INS						°C/°F					
MB	INS	MB	INS	MB	INS	°C	°F	°C	°F	°C	°F
948	27.99	982	29.00	1016	30.00	-60	-76.0	-15	15	30	86.0
949	28.02	983	29.03	1017	30.03	-59	-74.2	-14	6.8	31	87.8
950	28.05	984	29.06	1018	30.06	-58	-72.4	-13	8.6	32	89.6
951	28.08	985	29.09	1019	30.09	-57	-70.6	-12	10.4	33	91.4
952	28.11	986	29.12	1020	30.12	-56	-68.8	-11	12.2	34	93.2
953	28.14	987	29.15	1021	30.15	-55	-67.0	-10	14.0	35	95.0
954	28.17	988	29.18	1022	30.18	-54	-65.2	-9	15.8	36	96.8
955	28.20	989	29.21	1023	30.21	-53	-63.4	-8	17.6	37	98.6
956	28.23	990	29.23	1024	30.24	-52	-61.6	-7	19.4	38	100.4
957	28.26	991	29.26	1025	30.27	-51	-59.8	-6	21.2	39	102.2
958	28.29	992	29.29	1026	30.30	-50	-58.0	-5	23.0	40	104.0
959	28.32	993	29.32	1027	30.33	-49	-56.2	-4	24.8	42	105.8
960	28.35	994	29.35	1028	30.36	-48	-54.4	-3	26.6	42	107.6
961	28.38	995	29.38	1029	30.39	-47	-52.6	-2	28.4	43	109.4
962	28.41	996	29.41	1030	30.42	-46	-50.8	-1	30.2	44	111.2
963	28.44	997	29.44	1031	30.45	-45	-49.0	0	32.0	45	113.0
964	28.47	998	29.47	1032	30.47	-44	-47.2	1	33.8	46	114.8
965	28.50	999	29.50	1033	30.50	-43	-45.4	2	35.6	47	116.6
966	28.53	1000	29.53	1034	30.53	-42	-43.6	3	37.4	48	118.4
967	28.56	1001	29.56	1035	30.56	-41	-41.8	4	39.2	49	120.2
968	28.59	1002	29.59	1036	30.59	-40	-40.0	5	41.0	50	122.0
969	28.61	1003	29.62	1037	30.62	-39	-38.2	6	42.8	51	123.8
970	28.64	1004	29.65	1038	30.65	-38	-36.4	7	44.6	52	125.6
971	28.67	1005	29.68	1039	30.68	-37	-34.6	8	46.4	53	127.4
972	28.70	1006	29.71	1040	30.71	-36	-32.8	9	48.2	54	129.2
973	28.73	1007	29.74	1041	30.74	-35	-31.0	10	50.0	55	131.0
974	28.76	1008	29.77	1042	30.77	-34	-29.2	11	51.8	56	132.8
975	28.79	1009	29.80	1043	30.80	-33	-27.4	12	53.6	57	134.6
976	28.82	1010	29.83	1044	30.83	-32	-25.6	13	55.4	58	136.4
977	28.85	1011	29.86	1045	30.86	-31	-23.8	14	57.2	59	138.2
978	28.88	1012	29.88	1046	30.89	-30	-22.0	15	59.0	60	140.0
979	28.91	1013	29.91	1047	30.92	-29	-20.2	16	60.8	61	141.8
980	28.94	1014	29.94	1048	30.95	-28	-18.4	17	62.6	62	143.6
981	28.97	1015	29.97	1049	30.98	-27	-16.6	18	64.4	63	145.4
				1050	31.01	-26	-14.8	19	66.2	64	147.2
						-24	-11.2	21	69.8	66	150.8
						-23	-9.4	22	71.6	67	152.6
						-22	-7.6	23	73.4	68	154.4
						-21	-5.8	24	75.2	69	156.2
						-20	-4.0	25	77.0	70	158.0
						-19	-2.2	26	78.7		
						-18	-0.4	27	80.6		
						-17	1.4	28	82.4		
						-16	3.2	29	84.2		

TBL GEN 2.6-8

litres/imperial gallons						litres/U.S. gallons					
L	IMP	L	IMP	L	IMP	L	U.S.	L	U.S.	L	U.S.
1	.22	41	9.02	81	17.82	1	.26	41	10.83	81	21.40
3	.66	43	9.46	83	18.26	3	.79	43	11.36	83	21.93
4	.88	44	9.68	84	18.48	4	1.06	44	11.63	84	22.19
5	1.10	45	9.90	85	18.70	5	1.32	45	11.89	85	22.46
6	1.32	46	10.12	86	18.92	6	1.59	46	12.15	86	22.72
7	1.54	47	10.34	87	19.14	7	1.85	47	12.42	87	22.99
8	1.76	48	10.56	88	19.36	8	2.11	48	12.68	88	22.35
9	1.98	49	10.78	89	19.58	9	2.38	49	12.95	89	23.51
10	2.20	50	11.00	90	19.80	10	2.64	50	13.21	90	23.78
11	2.42	51	11.22	91	20.02	11	2.91	51	13.47	91	24.04
12	2.64	52	11.44	92	20.24	12	3.17	52	13.74	92	24.31
13	2.86	53	11.66	93	20.46	13	3.44	53	14.00	93	24.57
14	3.08	54	11.88	94	20.68	14	3.70	54	14.27	94	24.84
15	3.30	55	12.10	95	20.90	15	3.96	55	14.53	95	25.10
16	3.52	56	12.32	96	21.12	16	4.23	56	14.80	96	25.36
17	3.74	57	12.54	97	21.34	17	4.49	57	15.06	97	25.63
18	3.86	58	12.76	98	21.56	18	4.76	58	15.32	98	25.89
19	4.18	59	12.98	99	21.78	19	5.02	59	15.59	99	26.16
20	4.40	60	13.20	100	22.00	20	5.28	60	15.85	100	26.42
21	4.62	61	13.42	200	44.00	21	5.55	61	16.12	200	52.84
22	4.84	62	13.64	300	66.00	22	5.81	62	16.38	300	79.26
23	5.06	63	13.86	400	88.00	23	6.08	63	16.65	400	105.68
24	5.28	64	14.08	500	110.00	24	6.34	64	16.91	500	132.10
25	5.50	65	14.30	600	132.00	25	6.61	65	17.17	600	158.52
26	5.72	66	14.52	700	154.00	26	6.87	66	17.44	700	184.94
27	5.94	67	14.74	800	176.00	27	7.13	67	17.70	800	211.36
28	6.16	68	14.96	900	198.00	28	7.40	68	17.97	900	237.78
29	6.38	69	15.18	1000	220.00	29	7.66	69	18.23	1000	264.2
30	6.60	70	15.40	2000	440.00	30	7.93	70	18.49	2000	528.4
31	6.82	71	15.62	3000	660.00	31	8.19	71	18.76	3000	792.6
32	7.04	72	15.84	4000	880.00	32	8.45	72	19.02	4000	1056.8
33	7.26	73	16.06	5000	1100.00	33	8.72	73	19.29	5000	1321.0
34	7.48	74	16.28	6000	1320.00	34	8.98	74	19.55	6000	1585.2
35	7.70	75	16.50	7000	1540.00	35	9.25	75	19.82	7000	1849.4
36	7.92	76	16.72	8000	1760.00	36	9.51	76	20.08	8000	2113.6
37	8.14	77	16.94	9000	1980.00	37	9.78	77	20.34	9000	2377.8
38	8.36	78	17.16	10000	2200.00	38	10.04	78	20.61	10000	2642.0
39	8.58	79	17.38			39	10.30	79	20.87		
40	8.80	80	17.60			40	10.57	80	21.14		

TBL GEN 2.6-9

<b>Kg/lb</b>											
<b>kg</b>	<b>lb</b>	<b>kg</b>	<b>lb</b>	<b>kg</b>	<b>lb</b>	<b>kg</b>	<b>lb</b>	<b>kg</b>	<b>lb</b>	<b>kg</b>	<b>lb</b>
1	2.20	28	61.73	52	114.64	76	167.55	100	220.5	16000	35273.6
2	4.41	29	63.93	53	116.84	77	169.75	200	440.9	17000	37478.2
3	6.61	30	6.14	54	119.05	78	171.96	300	661.4	18000	39682.2
4	8.82	31	68.34	55	121.25	79	174.16	400	881.8	19000	41887.4
5	11.02	32	70.55	56	123.46	80	176.37	500	1102.3	20000	44092.0
6	13.23	33	72.75	57	125.66	81	178.57	600	1322.8	21000	46296.6
7	15.43	34	74.96	58	127.87	82	180.78	700	1543.2	22000	48501.2
8	17.64	35	77.16	59	130.07	83	182.98	800	1763.7	23000	50705.8
9	19.84	36	79.37	60	132.28	84	185.19	900	1984.1	24000	52910.4
10	22.05	37	81.57	61	134.48	85	187.39	1000	2204.6	25000	55115.0
11	24.25	38	83.78	62	136.69	86	189.60	2000	4409.2	26000	57319.6
12	26.46	39	85.98	63	138.98	87	191.80	3000	6613.8	27000	59524.2
13	28.66	40	88.18	64	141.09	88	194.01	4000	8818.4	28000	61728.8
14	30.86	41	90.39	65	143.30	89	196.21	5000	11023.0	29000	63933.5
15	33.07	42	92.59	66	145.50	90	198.41	6000	13227.6	30000	66138.0
16	35.27	43	94.80	67	147.71	91	200.62	7000	15432.2	35000	77161.0
17	37.48	44	97.00	68	149.91	92	202.82	8000	17636.8	40000	88184.0
18	39.68	45	99.21	69	152.12	93	205.03	9000	19841.4	45000	99207.0
19	41.89	46	101.41	70	154.32	94	207.23	10000	22046.0	50000	110230.0
20	44.09	47	103.62	71	156.53	95	209.44	11000	24250.6	60000	132276.0
21	46.30	48	105.82	72	158.73	96	211.64	12000	26455.2	70000	154322.0
22	48.50	49	108.03	73	160.94	97	213.85	13000	28659.8	80000	176368.0
23	50.71	50	110.23	74	163.14	98	216.05	14000	30864.4	90000	198414.0
24	52.91	51	112.44	75	165.35	99	218.26	15000	33069.0	100000	220460.0
25	55.12										
26	57.32										
27	59.52										



## **GEN 2.7 Sunrise/Sunset Tables**

The U.S. does not publish sunrise/sunset tables.



## GEN 3. SERVICES

### GEN 3.1 Aeronautical Information Services

#### 1. Aeronautical Information Service

**1.1** The U.S. Aeronautical Information Services is a part of the Air Traffic Organization of the Federal Aviation Administration.

Postal Address:  
Federal Aviation Administration  
Aeronautical Information Services  
1305 East-West Highway  
Silver Spring, MD 20910  
*Telephone:* 800-638-8972  
*Telex:* 892-562  
Commercial Telegraphic Address: FAA WASH  
AFTN Address: KRWAYAYX

**1.2** The U.S. NOTAM office is located at the following address:

Postal Address:  
Federal Aviation Administration  
U.S. NOTAM Office  
Air Traffic Control System Command Center  
3701 Macintosh Drive  
Warrenton, VA 20187  
*Telephone:* 540-422-4260  
*Toll Free:* 1-888-876-6826  
*Facsimile:* 540-422-4298  
*Telex:* None  
AFTN Address (Administrative): KDCAYNYX  
AFTN (NOTAM): KDZZNAXX

#### 2. Area of Responsibility of AIS

**2.1** Aeronautical Information Services is responsible for the collection, validation, and dissemination of aeronautical information for the U.S. and areas under its jurisdiction for air traffic control purposes.

#### 3. Aeronautical Publications

##### 3.1 United States AIP

**3.1.1** The AIP, issued in one volume, is the basic aeronautical information document published for international use. It contains information of a lasting character, with interim updates published in various other publications. The AIP is available in English only and is maintained on a current basis by a 6-month amendment service.

##### 3.2 Aeronautical Information Circulars

**3.2.1** These circulars, called Advisory Circulars, contain information of general or technical interest relating to administrative or aviation matters which are inappropriate to either the AIP or the NOTAM. Advisory Circulars are available in English only. A checklist of outstanding circulars is issued annually.

##### 3.3 En Route Aeronautical Charts, En Route Supplements, Approach Procedure Charts, Chart Supplements

**3.3.1** These publications, available in English only, contain specific information on airspace, airports, navigational aids, and flight procedures applicable to the regional areas of the U.S. and the territories and airspace under its jurisdiction. These publications are available on the AIS website at:  
[http://www.faa.gov/air\\_traffic/flight\\_info/aeronav](http://www.faa.gov/air_traffic/flight_info/aeronav).

#### **4. Distribution of Publications**

**4.1** This order is available on the FAA's Air Traffic Plans and Publications website at [http://faa.gov/air\\_traffic/publications](http://faa.gov/air_traffic/publications). All foreign aeronautical authorities are responsible for viewing, downloading, and subscribing to receive electronic mail notifications when changes occur to this publication. Subscriptions to air traffic directives can be made through the Air Traffic Plans and Publications website at [https://www.faa.gov/air\\_traffic/publications/](https://www.faa.gov/air_traffic/publications/) or directly via the following link: [https://public.govdelivery.com/accounts/USAFAA/subscriber/new?topic\\_id=USAFAA\\_39](https://public.govdelivery.com/accounts/USAFAA/subscriber/new?topic_id=USAFAA_39). See information in paragraph 1.2 for published NOTAMs.

**4.2** Advisory Circulars are available, upon request, from the:

U.S. Department of Transportation  
Subsequent Distribution Office  
Ardmore East Business Center  
3341 Q 75th Avenue  
Landover, MD 20785

**4.3** Public sales of charts and publications are available through FAA approved print providers. A listing of products, dates of latest editions, and print providers is available on the AIS website at: [http://www.faa.gov/air\\_traffic/flight\\_info/aeronav](http://www.faa.gov/air_traffic/flight_info/aeronav).

**4.4** For the latest information regarding publication availability of world-wide products see the National Geospatial-Intelligence Agency (NGA) website: <https://www.nga.mil/ProductsServices/Pages/PublicProducts.aspx>.

#### **5. NOTAM Service**

##### **5.1 NOTAM Class I (Telecommunication Distribution)**

**5.1.1** NOTAM Class I distribution is used mainly for the notification of temporary information of timely significance such as unforeseen changes in services, facilities, airspace utilization, or any other emergency. Distribution is via telecommunications through International NOTAM Office of the Aeronautical Information Services, in accordance with the following classifications:

**5.1.1.1 International NOTAM.** NOTAM containing full information on all airports, facilities and flight procedures available for use by international civil aviation. NOTAMs are given selected distribution to adjacent or appropriate International NOTAM Offices which require their exchange.

**5.1.1.2 International Airspace NOTAM.** NOTAM containing short term information pertaining to potentially hazardous international and domestic airspace utilization which is of concern to international flights. NOTAMs are given selected distribution to adjacent or appropriate International NOTAM Offices which require their exchange.

**5.1.1.3 International Airspace NOTAM.** NOTAM containing permanent changes-en route airway structure/aeronautical service and information of a general nature. NOTAMs are given selected distribution to adjacent or appropriate International NOTAM Offices which require their exchange.

**5.1.1.4 Domestic NOTAM.** NOTAM containing information of concern to aircraft other than those engaged in international civil aviation. Distribution is to local or national users only. (See ENR 1.10.)

**5.1.2** Each NOTAM is assigned a four digit serial number which is followed by the location indicator for which the series is applicable. The serial numbers start with number 0001 at 0000 UTC on 1 July of each year. Each serial number is preceded by a letter:



**5.1.2.1 “A” for NOTAM classification “1.”**

**NOTE-**

*NOTAM number one for the year 1984 for the New York, John F. Kennedy International Airport would read A0001/84 KJFK. All NOTAMs issued will be preceded by an “A.”*

**5.1.2.2 “B” for NOTAM classification “2.” (Airspace):** the identifier of the affected air traffic control center/FIR will be used.

**NOTE-**

*NOTAM number one for the year 1984 for the Oakland ARTCC/FIR (Pacific Ocean Area) would read A0001/84 KZOA.*

**5.1.2.3 “C” for NOTAM classification “3” (Permanent Airspace):** The KFDC identifier will be used for data of permanent airway/aeronautical services and of a general nature that are transmitted as NOTAMs and are given selected distribution to adjacent or appropriate International NOTAM Offices which require their exchange.

**NOTE-**

*NOTAM number one for the year 1984 for KFDC is A0001/84 KFDC.*

**5.1.2.4 “E” for NOTAM classification “5” (domestic):** No application (see ENR 1.10.)

**5.2** Each NOTAM is provided with an identification letter adjoining the end of the word NOTAM meaning:

**5.2.1 NOTAMN:** NOTAM containing new information.

**5.2.2 NOTAMC:** NOTAM cancelling a previous NOTAM indicated.

**5.2.3 NOTAMR:** NOTAM replacing a previous NOTAM indicated.

**5.3** A checklist of NOTAMs currently in force for each international NOTAM classification is issued each month over the Aeronautical Fixed Telecommunications Network (AFTN) to each International NOTAM office which exchanges International NOTAMs with the U.S. International NOTAM Office.

**5.4** NOTAM Class I information is exchanged between the U.S. International NOTAM Office and the following International NOTAM Offices.

*TBL GEN 3.1-1*

COUNTRY	CITY
AFGHANISTAN	KABUL
ALBANIA	ROME
ALGERIA	ALGIERS
ANGOLA	LUANDA
ARGENTINA	BUENOS AIRES
AUSTRALIA	SIDNEY
AUSTRIA	VIENNA
AZORES	SANTO MARIA
BAHAMAS	NASSAU
BAHRAIN	BAHRAIN
BANGLADESH	DHAKA (DACCA)
BELGIUM	BRUSSELS
BERMUDA	BERMUDA
BOLIVIA	LA PAZ
BOSNIA	ZAGREB
BRAZIL	RIO DE JANEIRO
BULGARIA	SOFIA
CAMBODIA	PHNOM-PEHN
CANADA	OTTAWA

COUNTRY	CITY
CAPE VERDE ISLANDS	AMILCAR CABRAL
CHILE	SANTIAGO
CHINA	BEIJING
CHINA (FORMOSA)	TAIPEI
COLOMBIA	BOGOTA
CONGO	BRAZZAVILLE
CROATIA	ZAGREB
CUBA	HAVANA
CYPRUS	NICOSIA
CZECH REPUBLIC	PRAGUE
DENMARK	COPENHAGEN
DOMINICAN REPUBLIC	SANTO DOMINGO
ECUADOR	GUAYAQUIL
ENGLAND	LONDON
ESTONIA	TALLINN
ETHIOPIA	ADDIS ABABA

COUNTRY	CITY
EYGPT	CAIRO
FIJI	NANDI
FINLAND	HELSINKI
FRANCE	PARIS
FRENCH GUIANA	MARTINIQUE
FRENCH POLYNESIA	TAHITI
GERMANY (WEST)	FRANKFURT
GHANA	ACCRA
GREECE	ATHENS
GREENLAND	SONDRE STROMFJORD
GUYANA	GEORGETOWN
HAITI	PORT-AU-PRINCE
HONDURAS	TEQUIGALPA
HONG KONG	HONG KONG
HUNGARY	BUDAPEST
ICELAND	REYKJAVIK
INDIA	BOMBAY
INDIA	CALCUTTA
INDIA	DELHI
INDIA	MADRAS
INDONESIA	JAKARTA
IRAN	TEHRAN (NOT AVBL)
IRELAND	SHANNON
ISRAEL	TEL AVIV
ITALY	ROME
JAMAICA	KINGSTON
JAPAN	TOKYO
JORDAN	AMMAN
KENYA	NAIROBI
KOREA (SOUTH)	SEOUL
KUWAIT	KUWAIT
LATVIA	MOSCOW
LEBANON	BEIRUT
LIBERIA	ROBERTS
LIBYA	TRIPOLI
MALAYSIA	KUALA LUMPUR
MALTA	LUQA
MAURITIUS	PLAISANCE
MAYNMAR	RANGOON
MEXICO	MEXICO CITY
MOROCCO	CASABLANCA
MOZAMBIQUE	MAPUTO
NAMIBIA	JOHANNESBURG
NAURU ISLAND	NAURU
NETHERLANDS	AMSTERDAM

COUNTRY	CITY
NETHERLANDS ANTILLES	CURACAO
NEW GUINEA	PORT MOSEBY
NEW ZEALAND	AUCKLAND
NIGERIA	LAGOS
NORWAY	OSLO
OMAN	MUSCAT
PAKISTAN	KARACHI
PANAMA	TOCUMEN
PARAGUAY	ASUNCION
PERU	LIMA
PHILLIPINES	MANILLA
POLAND	WARSAW
PORTUGAL	LISBON
ROMANIA	BUCHAREST
RUSSIA	MOSCOW
SAMOA	FALEOLA
SAUDI ARABIA	JEDDAH
SENEGAL	DAKAR
SEYCHELLES	MAHE
SINGAPORE	SINGAPORE
SLOVAKIA	BRATISLAVA
SOLOMON ISLANDS	HONIARA
SOUTH AFRICA	JOHANNESBURG
SPAIN	MADRID
SRI LANKA	COLOMBO
SUDAN	KHARTOUM
SURINAME	PARAMARIBO
SWEDEN	STOCKHOLM
SWITZERLAND	ZURICH
SYRIA	DAMASCUS
TANZANIA	DAR-ES-SALAAM
THAILAND	BANKOK
TRINIDAD	PORT OF SPAIN
TUNISIA	TUNIS
TURKEY	ANKARA
URUGUAY	MONTEVIDEO
VIET NAM	HO CHI MINH CITY
VENEZUELA	CARACAS
YEMEN	ADEN
YUGOSLAVIA	BELGRADE
ZAIRE	KINSHASA
ZAMBIA	LUSAKA
ZIMBABWE	HARARE

## **6. Pre-Flight Information Service at Aerodromes Available to International Flights**

**6.1** Pre-Flight Information Units in the U.S. are Flight Service Stations (FSS) operated by either FAA (in Alaska) or by federal contract facilities (elsewhere in the U.S.).

**6.2** FSSs are air traffic facilities that provide pilot briefings, flight plan processing, en route flight advisories, search and rescue services, and assistance to lost aircraft and aircraft in emergency situations. FSSs also relay ATC clearances, process Notices to Air Missions, and broadcast aviation weather and aeronautical information. In Alaska, designated FSSs also take weather observations, and provide Airport Advisory Services (AAS).

**6.3** FSS locations, services, and telephone information are available in the Chart Supplement U.S., Chart Supplement Alaska, and Chart Supplement Pacific.

**6.4** Flight Service Stations have telecommunications access to all of the weather and NOTAM information available for a preflight briefing to international locations with which the U.S. International NOTAM office exchanges information.



## GEN 3.2 Aeronautical Charts

### 1. General

**1.1** Civil aeronautical charts for the U.S. and its territories, and possessions are produced by Aeronautical Information Services (AIS), [http://www.faa.gov/air\\_traffic/flight\\_info/aeronav](http://www.faa.gov/air_traffic/flight_info/aeronav), which is part of FAA's Air Traffic Organization, Mission Support Services.

### 2. Obtaining Aeronautical Charts

**2.1** Public sales of charts and publications are available through a network of FAA approved print providers. A listing of products, dates of latest editions, and print providers is available on the AIS website at: [http://www.faa.gov/air\\_traffic/flight\\_info/aeronav](http://www.faa.gov/air_traffic/flight_info/aeronav).

### 3. Selected Charts and Products Available

VFR Navigation Charts  
IFR Navigation Charts  
Planning Charts  
Supplementary Charts and Publications  
Digital Products

### 4. General Description of Each Chart Series

#### 4.1 VFR Navigation Charts

**4.1.1 Sectional Aeronautical Charts.** Sectional Charts are designed for visual navigation of slow to medium speed aircraft. The topographic information consists of contour lines, shaded relief, drainage patterns, and an extensive selection of visual checkpoints and landmarks used for flight under VFR. Cultural features include cities and towns, roads, railroads, and other distinct landmarks. The aeronautical information includes visual and radio aids to navigation, airports, controlled airspace, special-use airspace, obstructions, and related data. Scale 1 inch = 6.86nm/1:500,000. 60 x 20 inches folded to 5 x 10 inches. Revised every 56 days. (See FIG GEN 3.2-1 and FIG GEN 3.2-2.)

**4.1.2 VFR Terminal Area Charts (TAC).** TACs depict the airspace designated as Class B airspace. While similar to sectional charts, TACs have more detail because the scale is larger. The TAC should be used by pilots intending to operate to or from airfields within or near Class B or Class C airspace. Areas with TAC coverage are indicated by a • on the Sectional Chart indexes. Scale 1 inch = 3.43nm/1:250,000. Revised every 56 days. (See FIG GEN 3.2-1 and FIG GEN 3.2-2.)

**4.1.3 U.S. Gulf Coast VFR Aeronautical Chart.** The Gulf Coast Chart is designed primarily for helicopter operation in the Gulf of Mexico area. Information depicted includes offshore mineral leasing areas and blocks, oil drilling platforms, and high density helicopter activity areas. Scale 1 inch = 13.7nm/1:1,000,000. 55 x 27 inches folded to 5 x 10 inches. Revised every 56 days.

**4.1.4 Grand Canyon VFR Aeronautical Chart.** Covers the Grand Canyon National Park area and is designed to promote aviation safety, flight free zones, and facilitate VFR navigation in this popular area. The chart contains aeronautical information for general aviation VFR pilots on one side and commercial VFR air tour operators on the other side. Revised every 56 days.

FIG GEN 3.2-1

Sectional and VFR Terminal Area Charts for the Conterminous U.S., Hawaii, Puerto Rico, and Virgin Islands

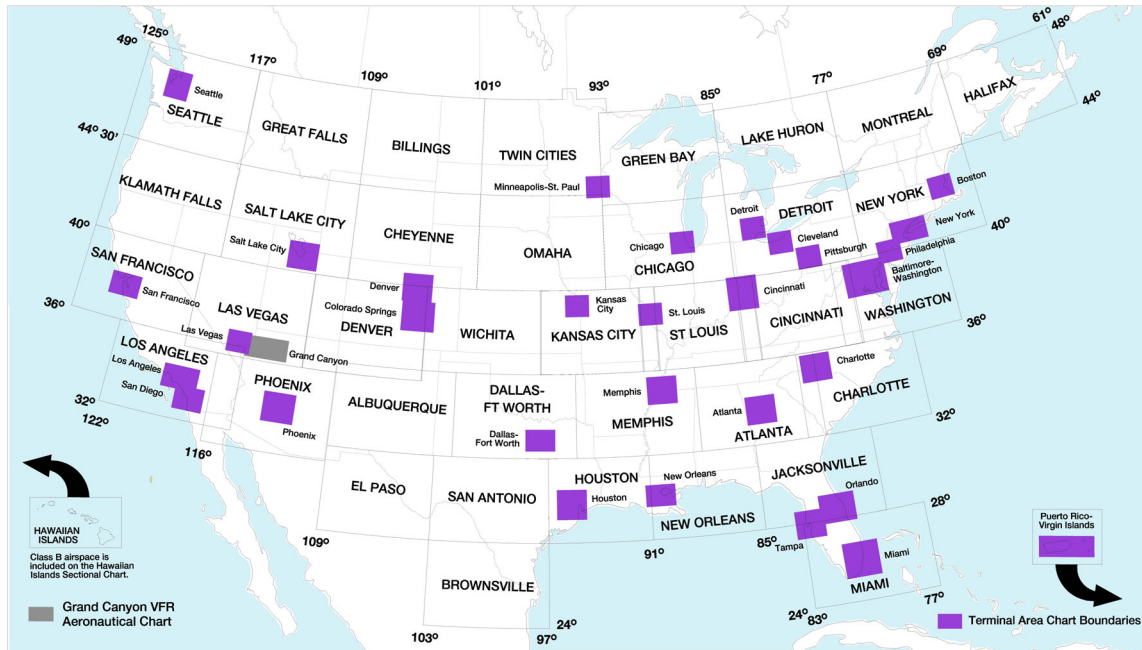
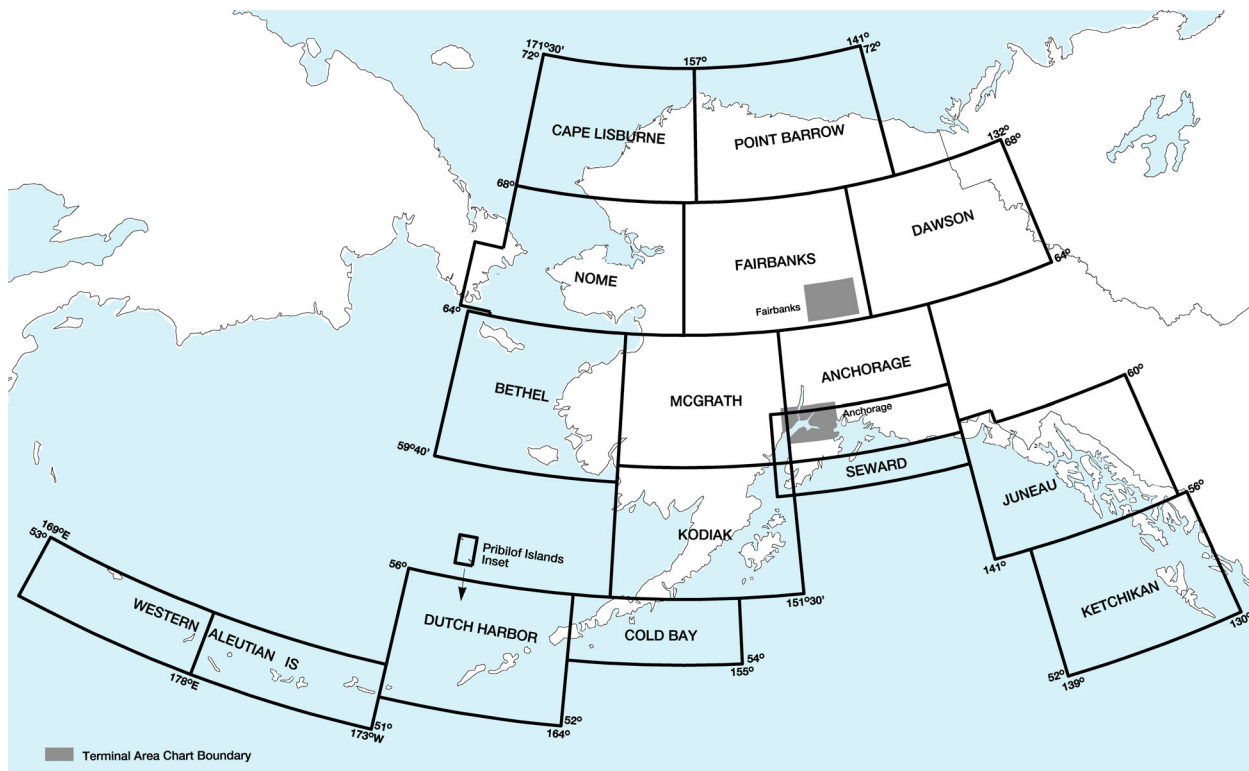


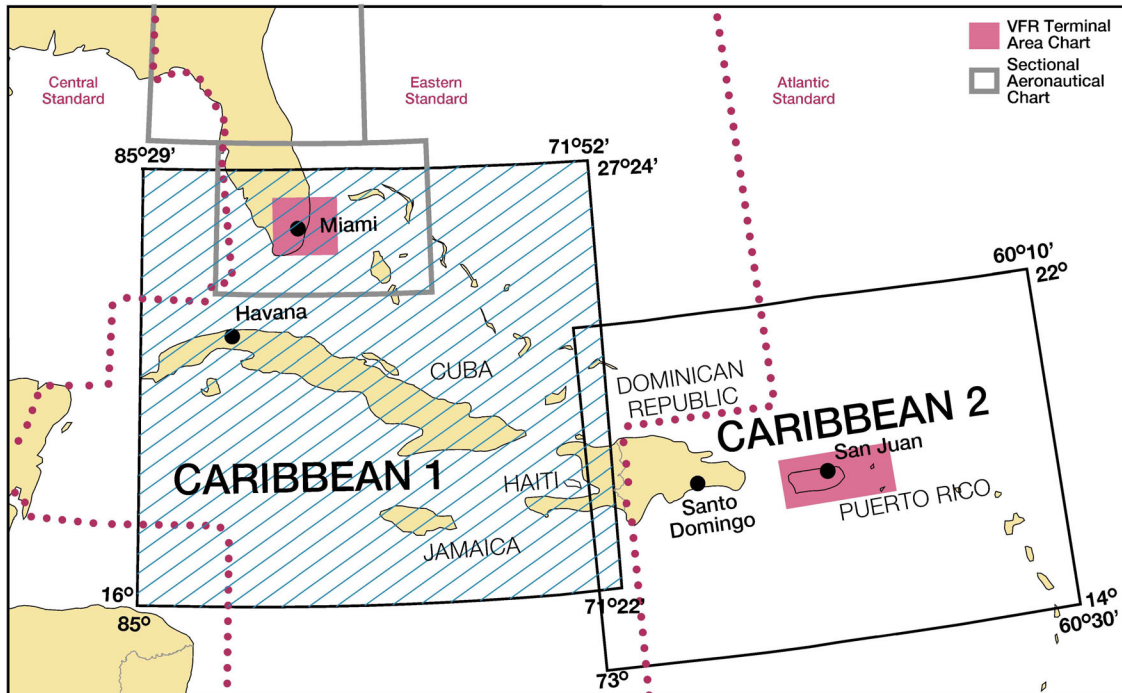
FIG GEN 3.2-2

Sectional and VFR Terminal Area Charts for Alaska



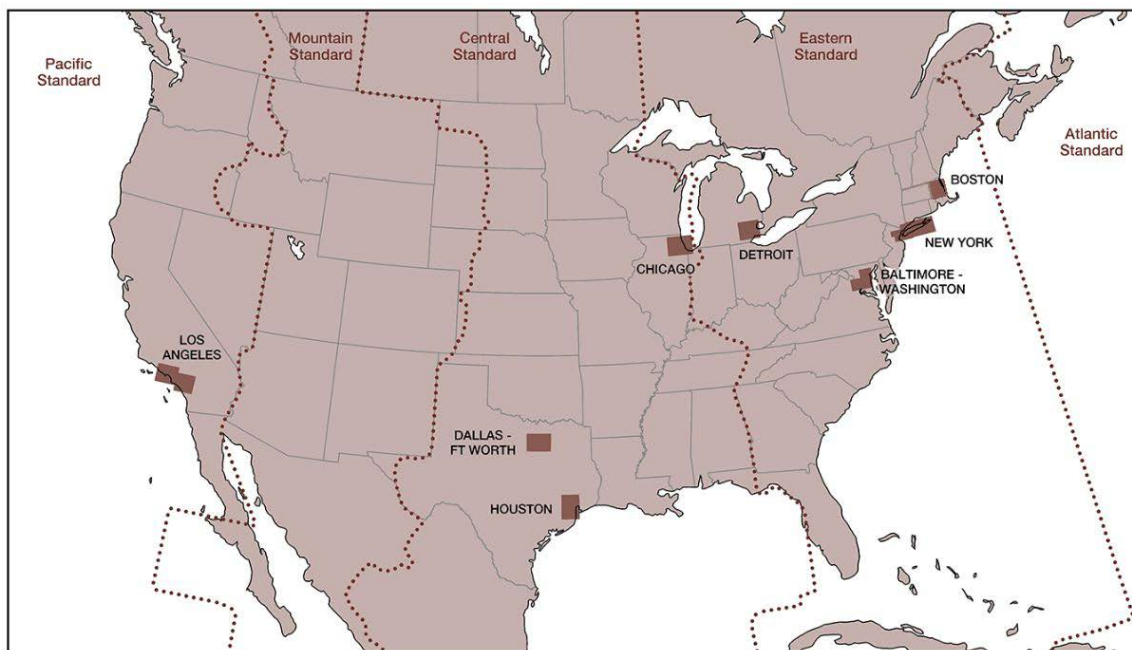
**4.1.5 Caribbean VFR Aeronautical Charts.** Caribbean 1 and 2 (CAC-1 and CAC-2) are designed for visual navigation to assist familiarization of foreign aeronautical and topographic information. The aeronautical information includes visual and radio aids to navigation, airports, controlled airspace, special-use airspace, obstructions, and related data. The topographic information consists of contour lines, shaded relief, drainage patterns, and a selection of landmarks used for flight under VFR. Cultural features include cities and towns, roads, railroads, and other distinct landmarks. Scale 1 inch = 13.7nm/1:1,000,000. CAC-1 consists of two sides measuring 30" x 60" each. CAC-2 consists of two sides measuring 20" x 60" each. Revised every 56 days. (See FIG GEN 3.2-3.)

FIG GEN 3.2-3  
Caribbean VFR Aeronautical Charts



**4.1.6 Helicopter Route Charts.** A three-color chart series which shows current aeronautical information useful to helicopter pilots navigating in areas with high concentrations of helicopter activity. Information depicted includes helicopter routes, four classes of heliports with associated frequency and lighting capabilities, NAVAIDs, and obstructions. In addition, pictorial symbols, roads, and easily identified geographical features are portrayed. Scale 1 inch = 1.71nm/1:125,000. 34 x 30 inches folded to 5 x 10 inches. Revised every 56 days. (See FIG GEN 3.2-4)

FIG GEN 3.2-4  
Helicopter Route Charts



## 4.2 IFR Navigation Charts

**4.2.1 IFR En Route Low Altitude Charts (Conterminous U.S. and Alaska).** En route low altitude charts provide aeronautical information for navigation under IFR conditions below 18,000 feet MSL. This four-color chart series includes airways; limits of controlled airspace; VHF NAVAIDs with frequency, identification, channel, geographic coordinates; airports with terminal air/ground communications; minimum en route and obstruction clearance altitudes; airway distances; reporting points; special use airspace; and military training routes. Scales vary from 1 inch = 5nm to 1 inch = 20nm. 50 x 20 inches folded to 5 x 10 inches. Charts revised every 56 days. *Area charts* show congested terminal areas at a large scale. They are included with subscriptions to any conterminous U.S. Set Low (Full set, East or West sets). (See FIG GEN 3.2-5 and FIG GEN 3.2-6.)



FIG GEN 3.2-5  
En Route Low Altitude Instrument Charts for the Conterminous U.S. (Includes Area Charts)

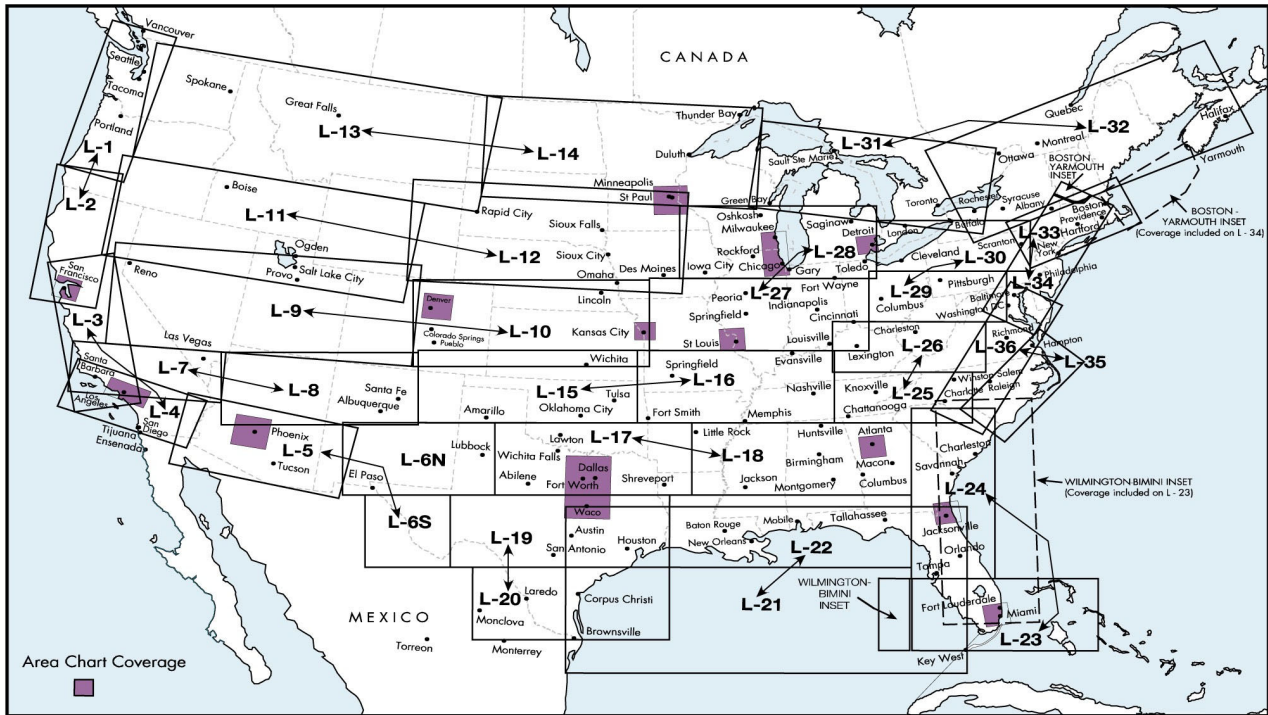
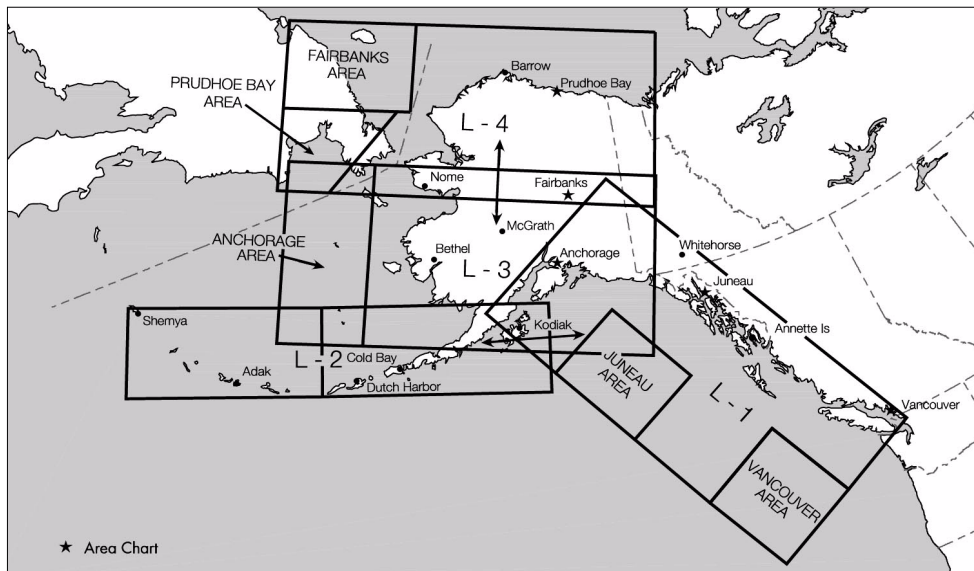
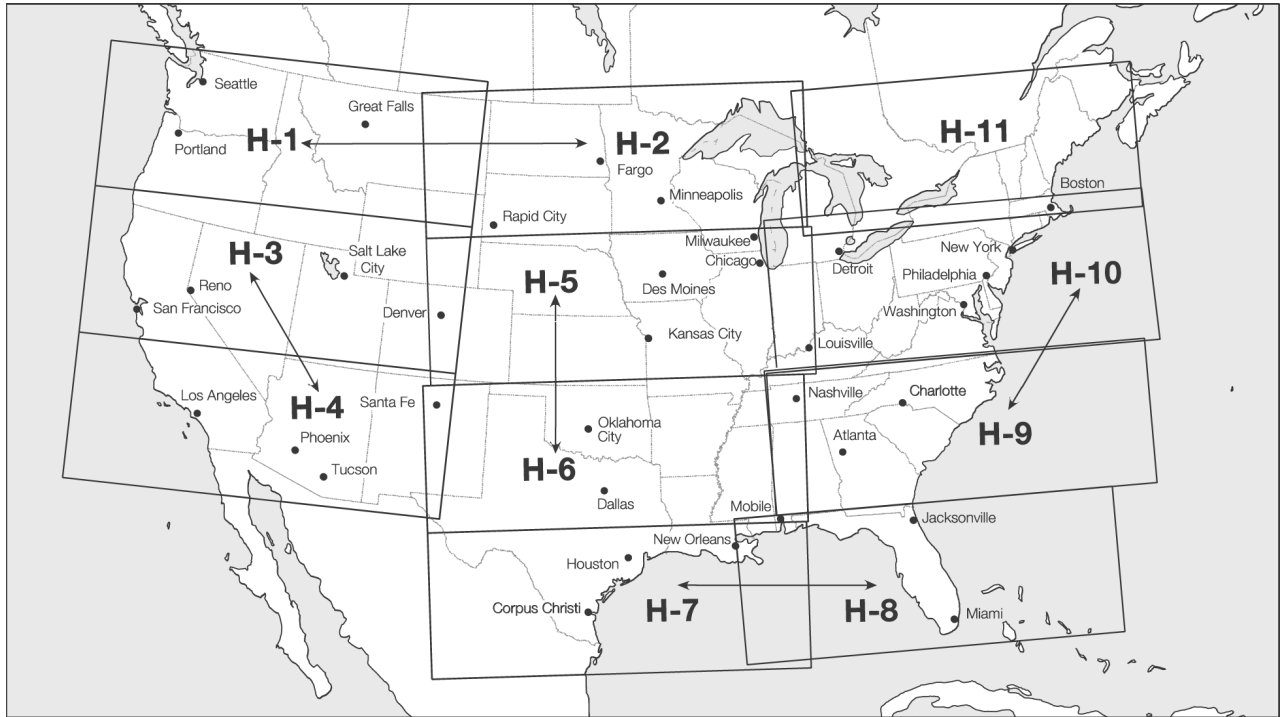


FIG GEN 3.2-6  
Alaska En Route Low Altitude Chart

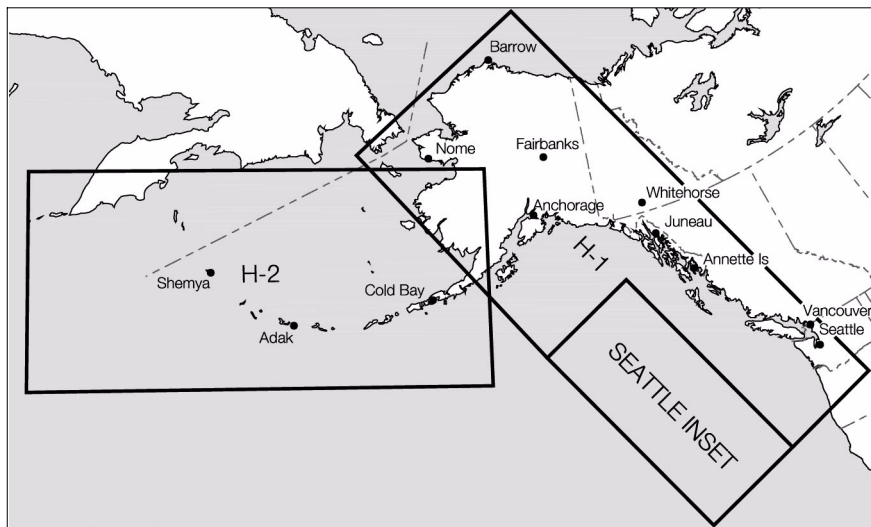


**4.2.2 IFR En Route High Altitude Charts (Conterminous U.S. and Alaska).** En route high altitude charts are designed for navigation at or above 18,000 feet MSL. This four-color chart series includes the jet route structure; VHF NAVAIDS with frequency, identification, channel, geographic coordinates; selected airports; reporting points. Scales vary from 1 inch = 45nm to 1 inch = 18nm. 55 x 20 inches folded to 5 x 10 inches. Revised every 56 days. (See FIG GEN 3.2-7 and FIG GEN 3.2-8.)

**FIG GEN 3.2-7  
En Route High Altitude Charts for the Conterminous U.S.**



**FIG GEN 3.2-8  
Alaskan En Route High Altitude Chart**



**4.2.3 U.S. Terminal Procedures Publication (TPP).** TPPs are published in 24 loose-leaf or perfect bound volumes covering the conterminous U.S., Puerto Rico and the Virgin Islands. A Change Notice is published at the midpoint between revisions in bound volume format and is available on the internet for free download at the AIS website. (See FIG GEN 3.2-15.) The TPPs include:

**4.2.3.1 Instrument Approach Procedure (IAP) Charts.** IAP charts portray the aeronautical data that is required to execute instrument approaches to airports. Each chart depicts the IAP, all related navigation data, communications information, and an airport sketch. Each procedure is designated for use with a specific electronic navigational aid, such as ILS, VOR, NDB, RNAV, etc.

**4.2.3.2 Instrument Departure Procedure (DP) Charts.** DP charts are designed to expedite clearance delivery and to facilitate transition between takeoff and en route operations. They furnish pilots' departure routing clearance information in graphic and textual form.

**4.2.3.3 Standard Terminal Arrival (STAR) Charts.** STAR charts are designed to expedite ATC arrival procedures and to facilitate transition between en route and instrument approach operations. They depict preplanned IFR ATC arrival procedures in graphic and textual form. Each STAR procedure is presented as a separate chart and may serve either a single airport or more than one airport in a given geographic area.

**4.2.3.4 Airport Diagrams.** Full page airport diagrams are designed to assist in the movement of ground traffic at locations with complex runway/taxiway configurations and provide information for updating geodetic position navigational systems aboard aircraft. Airport diagrams are available for free download at the AIS website.

**4.2.4 Alaska Terminal Procedures Publication.** This publication contains all terminal flight procedures for civil and military aviation in Alaska. Included are IAP charts, DP charts, STAR charts, airport diagrams, radar minimums, and supplementary support data such as IFR alternate minimums, take-off minimums, rate of descent tables, rate of climb tables and inoperative components tables. Volume is 5-3/8 x 8-1/4 inch top bound. Publication revised every 56 days with provisions for a Terminal Change Notice, as required.

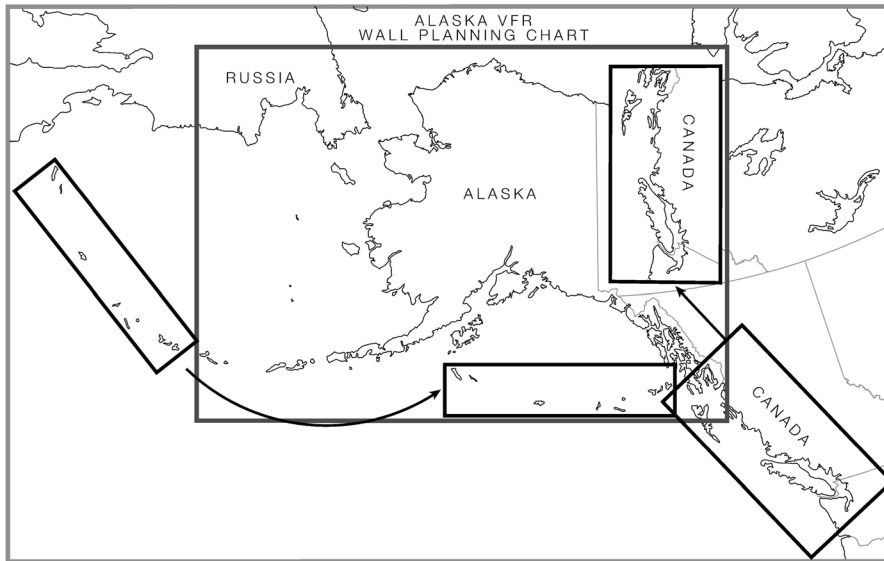
### 4.3 Planning Charts

**4.3.1 U.S. IFR/VFR Low Altitude Planning Chart.** This chart is designed for preflight and en route flight planning for IFR/VFR flights. Depiction includes low altitude airways and mileage, NAVAIDs, airports, special use airspace, cities, time zones, major drainage, a directory of airports with their airspace classification, and a mileage table showing great circle distances between major airports. Scale 1 inch = 47nm/ 1:3,400,000. Chart revised annually, and is available either folded or unfolded for wall mounting. (See FIG GEN 3.2-10.)

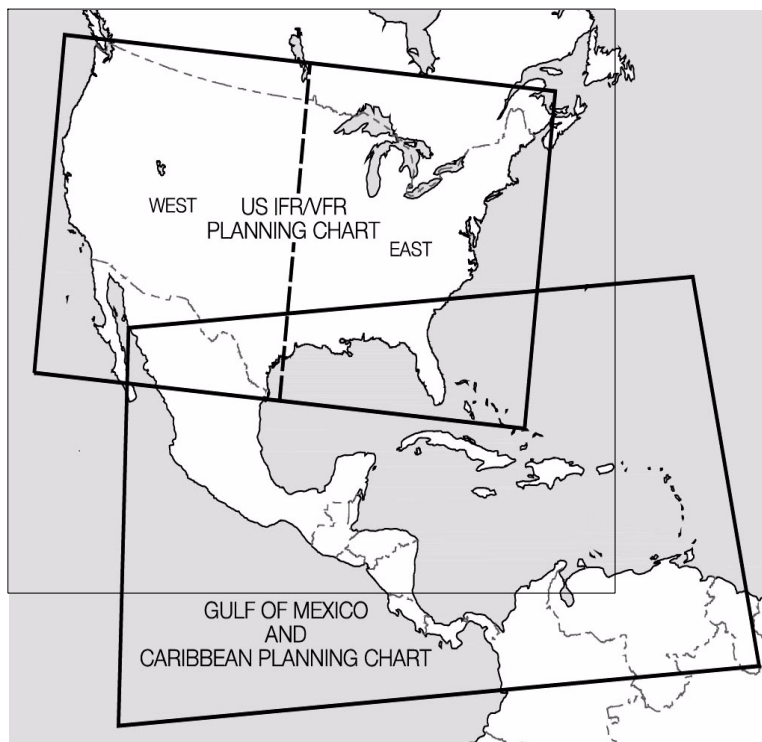
**4.3.2 Gulf of Mexico and Caribbean Planning Chart.** This is a VFR planning chart on the reverse side of the *Puerto Rico - Virgin Islands VFR Terminal Area Chart*. Information shown includes mileage between airports of entry, a selection of special use airspace and a directory of airports with their available services. Scale 1 inch = 85nm/1:6,192,178. 60 x 20 inches folded to 5 x 10 inches. Revised every 56 days. (See FIG GEN 3.2-10.)

**4.3.3 Alaska VFR Wall Planning Chart.** This chart is designed for VFR preflight planning and chart selection. It includes aeronautical and topographic information of the state of Alaska. The aeronautical information includes public and military airports; radio aids to navigation; and Class B, Class C, TRSA and special-use airspace. The topographic information includes city tint, populated places, principal roads, and shaded relief. Scale 1 inch = 27.4nm/1:2,000,000. The one sided chart is 58.5 x 40.75 inches and is designed for wall mounting. Revised annually. (See FIG GEN 3.2-9.)

**FIG GEN 3.2-9**  
**Alaska VFR Wall Planning Chart**

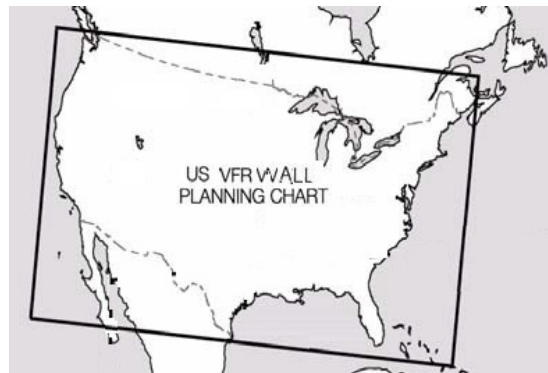


**FIG GEN 3.2-10**  
**Planning Charts**



**4.3.4 U.S. VFR Wall Planning Chart.** This chart is designed for VFR preflight planning and chart selection. It includes aeronautical and topographic information of the conterminous U.S. The aeronautical information includes airports, radio aids to navigation, Class B airspace and special use airspace. The topographic information includes city tint, populated places, principal roads, drainage patterns, and shaded relief. Scale 1 inch = 43 nm/ 1:3,100,000. The one-sided chart is 59 x 36 inches and ships unfolded for wall mounting. Revised annually. (See FIG GEN 3.2-11)

FIG GEN 3.2-11  
U.S. VFR Wall Planning Chart



**4.3.5 Charted VFR Flyway Planning Charts.** This chart is printed on the reverse side of selected TAC charts. The coverage is the same as the associated TAC. Flyway planning charts depict flight paths and altitudes recommended for use to bypass high traffic areas. Ground references are provided as a guide for visual orientation. Flyway planning charts are designed for use in conjunction with TACs and sectional charts and are not to be used for navigation. Chart scale 1 inch = 3.43nm/1:250,000.

#### 4.4 Supplementary Charts and Publications

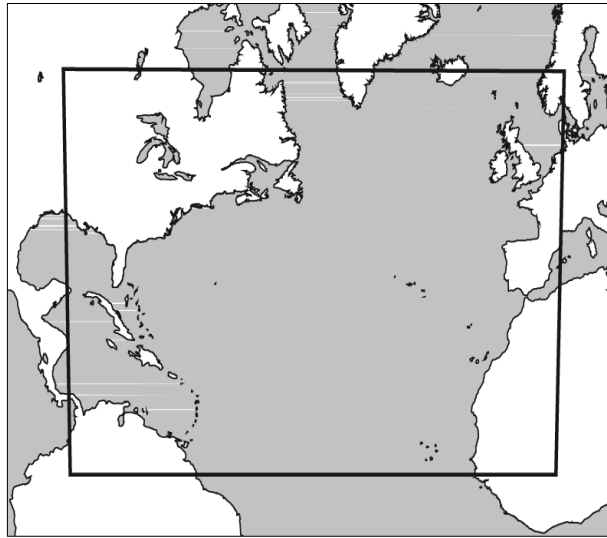
**4.4.1 Chart Supplement U.S.** This 7-volume booklet series contains data on airports, seaplane bases, heliports, NAVAIDs, communications data, weather data sources, airspace, special notices, and operational procedures. Coverage includes the conterminous U.S., Puerto Rico, and the Virgin Islands. The Chart Supplement U.S. shows data that cannot be readily depicted in graphic form; for example, airport hours of operations, types of fuel available, runway widths, lighting codes, etc. The Chart Supplement U.S. also provides a means for pilots to update visual charts between edition dates (The Chart Supplement U.S. is published every 56 days while Sectional Aeronautical and VFR Terminal Area Charts are generally revised every six months). The Aeronautical Chart Bulletins (VFR Chart Update Bulletins) are available for free download from the AIS website. Volumes are side-bound 5-3/8 x 8-1/4 inches. (See FIG GEN 3.2-14.)

**4.4.2 Chart Supplement Alaska.** This is a civil/military flight information publication issued by FAA every 56 days. It is a single volume booklet designed for use with appropriate IFR or VFR charts. The Chart Supplement Alaska contains airport sketches, communications data, weather data sources, airspace, listing of navigational facilities, and special notices and procedures. Volume is side-bound 5-3/8 x 8-1/4 inches.

**4.4.3 Chart Supplement Pacific.** This supplement is designed for use with appropriate VFR or IFR en route charts. Included in this one-volume booklet are the chart supplement, communications data, weather data sources, airspace, navigational facilities, special notices, and Pacific area procedures. IAP charts, DP charts, STAR charts, airport diagrams, radar minimums, and supporting data for the Hawaiian and Pacific Islands are included. The manual is published every 56 days. Volume is side-bound 5-3/8 x 8-1/4 inches.

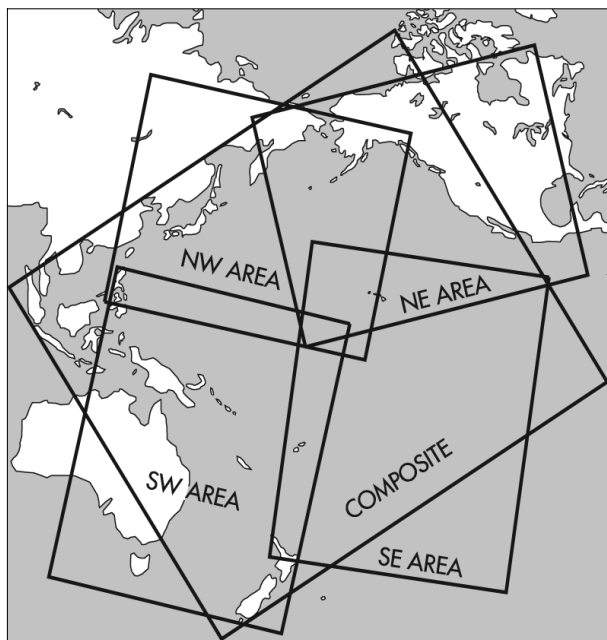
**4.4.4 North Atlantic Route Chart.** Designed for FAA controllers to monitor transatlantic flights, this 5-color chart shows oceanic control areas, coastal navigation aids, oceanic reporting points, and NAVAID geographic coordinates. Full Size Chart: scale 1 inch = 113.1nm/1:8,250,000. Chart is shipped flat only. Half Size Chart: scale 1 inch = 150.8nm/1:11,000,000. Chart is 29-3/4 x 20-1/2 inches, shipped folded to 5 x 10 inches only. Chart are revised every 56 days. (See FIG GEN 3.2-12.)

FIG GEN 3.2-12  
North Atlantic Route Charts



**4.4.5 North Pacific Route Charts.** These charts are designed for FAA controllers to monitor transoceanic flights. They show established intercontinental air routes, including reporting points with geographic positions. Composite Chart: scale 1 inch = 164NM/1:12,000,000. 48 x 41-1/2 inches. Area Charts: scale 1 inch = 95.9nm/1:7,000,000. 52 x 40-1/2 inches. All charts are shipped unfolded. Charts are revised every 56 days. (See FIG GEN 3.2-13.)

FIG GEN 3.2-13  
North Pacific Oceanic Route Charts



**4.4.6 Airport Obstruction Charts (OC).** The OC is a 1:12,000 scale graphic depicting 14 CFR Part 77, *Objects Affecting Navigable Airspace* surfaces, a representation of objects that penetrate these surfaces, aircraft movement and apron areas, navigational aids, prominent airport buildings, and a selection of roads and other planimetric detail in the airport vicinity. Also included are tabulations of runway and other operational data.

**4.4.7 FAA Aeronautical Chart User’s Guide.** A booklet designed to be used as a teaching aid and reference document. It describes the substantial amount of information provided on FAA’s aeronautical charts and publications. It includes explanations and illustrations of chart terms and symbols organized by chart type. The users guide is available for free download at the AIS website.

#### **4.5 Digital Products**

**4.5.1 The Digital Aeronautical Information CD (DAICD).** The DAICD is a combination of the NAVAID Digital Data File, the Digital Chart Supplement, and the Digital Obstacle File on one Compact Disk. These three digital products are no longer sold separately. The files are updated every 56 days and are available by subscription only.

**4.5.1.1 The NAVAID Digital Data File.** This file contains a current listing of NAVAIDs that are compatible with the National Airspace System. This file contains all NAVAIDs including ILS and its components, in the U.S., Puerto Rico, and the Virgin Islands plus bordering facilities in Canada, Mexico, and the Atlantic and Pacific areas.

**4.5.1.2 The Digital Obstacle File.** This file describes all obstacles of interest to aviation users in the U.S., with limited coverage of the Pacific, Caribbean, Canada, and Mexico. The obstacles are assigned unique numerical identifiers, accuracy codes, and listed in order of ascending latitude within each state or area.

**4.5.2 The Coded Instrument Flight Procedures (CIFP) (ARINC 424 [Ver 13 & 15]).** The CIFP is a basic digital dataset, modeled to an international standard, which can be used as a basis to support GPS navigation. Initial data elements included are: Airport and Helicopter Records, VHF and NDB Navigation aids, en route waypoints and airways. Additional data elements will be added in subsequent releases to include: departure procedures, standard terminal arrivals, and GPS/RNAV instrument approach procedures. The database is updated every 28 days. The data is available for free download at the AIS website.

**4.5.3 digital–Visual Charts (d–VC).** These digital VFR charts are geo–referenced images of FAA Sectional Aeronautical, TAC, and Helicopter Route charts. Additional digital data may easily be overlaid on the raster image using commonly available Geographic Information System software. Data such as weather, temporary flight restrictions, obstacles, or other geospatial data can be combined with d–VC data to support a variety of needs. The file resolution is 300 dots per inch and the data is 8–bit color. The data is provided as a GeoTIFF and distributed for free on the AIS website. The root mean square error of the transformation will not exceed two pixels.

FIG GEN 3.2-14  
Chart Supplement U.S. Geographic Areas

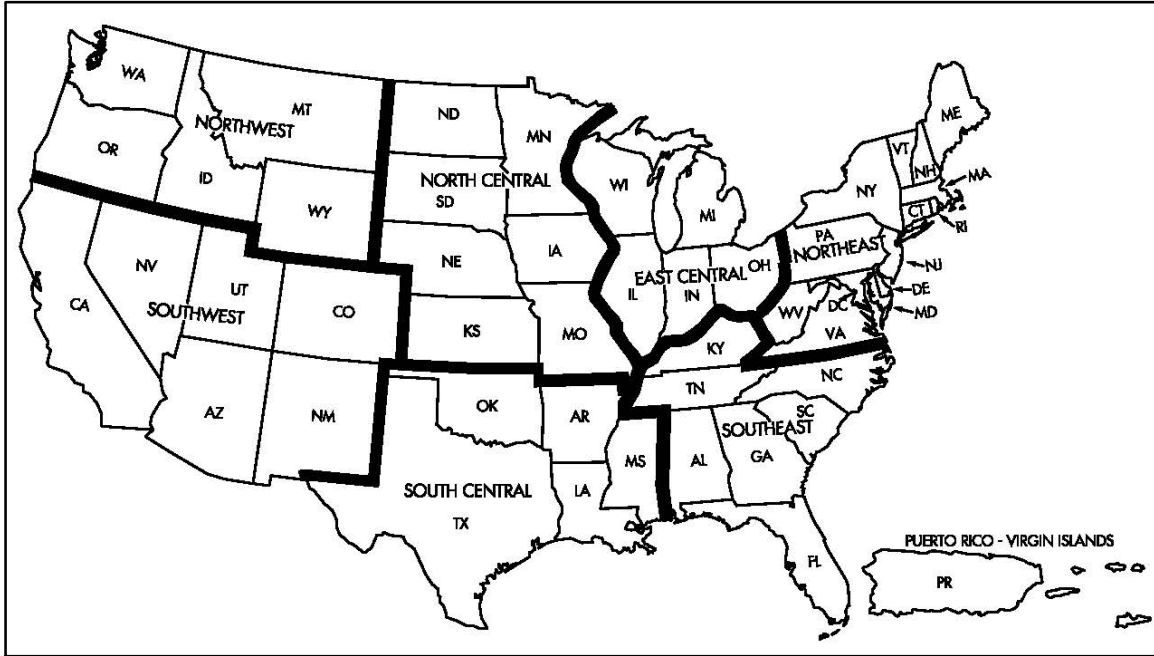
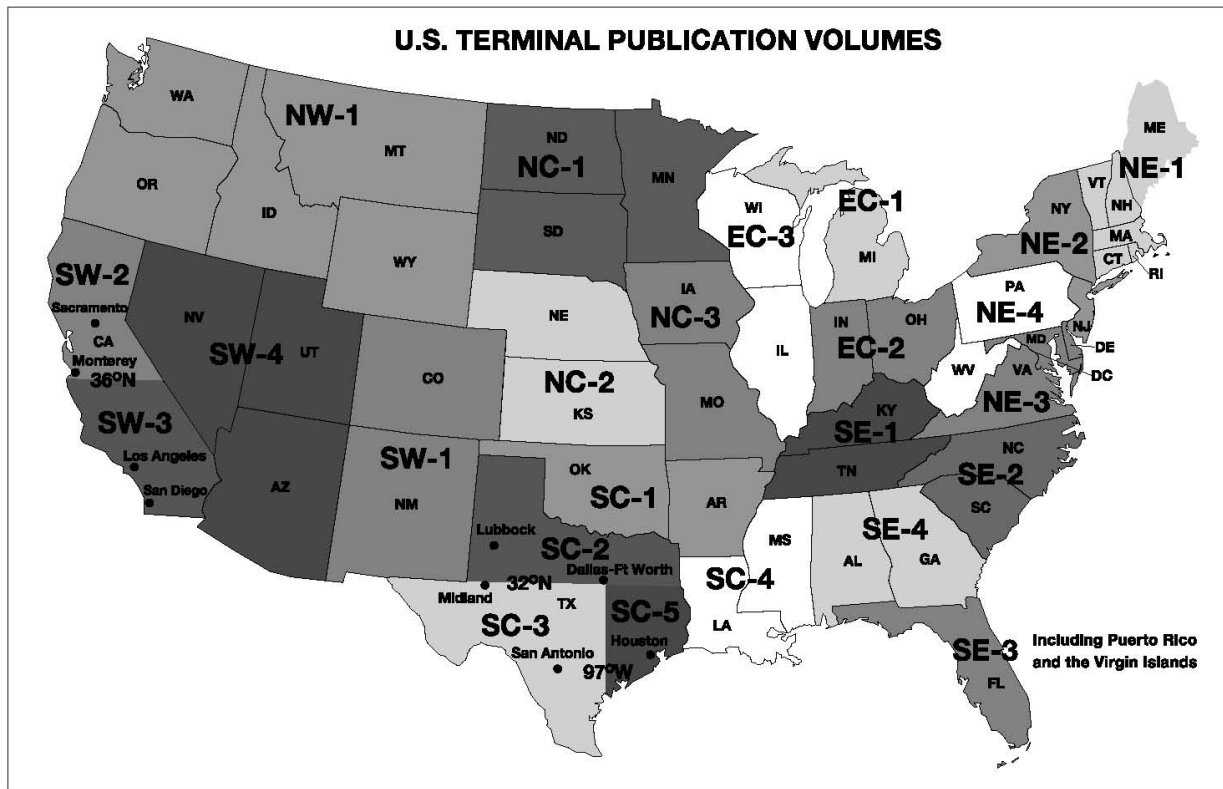


FIG GEN 3.2-15  
U.S. Terminal Publication Volumes





## **5. National Geospatial–Intelligence Agency (NGA) Products**

**5.1 National Geospatial–Intelligence Agency (NGA) Products.** For the latest information regarding publication availability, visit the NGA website:

<https://www.nga.mil/ProductsServices/Aeronautical/Pages/default.aspx>.

### **5.1.1 Flight Information Publication (FLIP) Planning Documents**

General Planning (GP)

Area Planning

Area Planning – Special Use Airspace –

Planning Charts

### **5.1.2 FLIP En Route Charts and Chart Supplements**

Pacific, Australasia, and Antarctica

United States – IFR and VFR Supplements

Flight Information Handbook

Caribbean and South America – Low Altitude

Caribbean and South America – High Altitude

Europe, North Africa, and Middle East –

Low Altitude

Europe, North Africa, and Middle East –

High Altitude

Africa

Eastern Europe and Asia

Area Arrival Charts

### **5.1.3 FLIP Instrument Approach Procedures (IAPs)**

Africa

Canada and North Atlantic

Caribbean and South America

Eastern Europe and Asia

Europe, North Africa, and Middle East

Pacific, Australasia, and Antarctica

VFR Arrival/Departure Routes – Europe and Korea

United States

### **5.1.4 Miscellaneous DOD Charts and Products**

Aeronautical Chart Updating Manual (CHUM)

DOD Weather Plotting Charts (WPC)

Tactical Pilotage Charts (TPC)

Operational Navigation Charts (ONC)

Global Navigation and Planning Charts (GNC)

Jet Navigation Charts (JNC) and Universal Jet

Navigation Charts (JNU)

Jet Navigation Charts (JNCA)

Aerospace Planning Charts (ASC)

Oceanic Planning Charts (OPC)

Joint Operations Graphics – Air (JOG–A)

Standard Index Charts (SIC)

Universal Plotting Sheet (VP–OS)

Sight Reduction Tables for Air Navigation (PUB249)

Plotting Sheets (VP–30)

Dial–Up Electronic CHUM



## GEN 3.3 Air Traffic Services

### 1. Responsible Authority

**1.1** The authority responsible for the overall administration of air traffic services provided for civil aviation in the U.S. and its territories, possessions and international airspace under its jurisdiction is the Chief Operating Officer of the Air Traffic Organization, acting under the authority of the Federal Aviation Administration (FAA).

### 2. Area of Responsibility

**2.1** Air traffic services as indicated in the following paragraphs are provided for the entire territory of the conterminous U.S., Alaska, Hawaii, Puerto Rico and the U.S. Virgin Islands, as well as the international airspace in oceanic areas under the jurisdiction of the U.S. which lies within the ICAO Caribbean (CAR), North Atlantic (NAT), North American (NAM), and Pacific (PAC) regions.

### 3. Air Traffic Services

**3.1** With the exception of terminal control services at certain civil aerodromes and military aerodromes, air traffic service in the U.S. is provided by the Air Traffic Organization, FAA, Department of Transportation (DOT), U.S. Government.

**3.2** Air Traffic control is exercised within the area of responsibility of the U.S.:

**3.2.1** On all airways.

**3.2.2** In Class B, C, D, and E Airspace; and

**3.2.3** Within the Class A airspace whose vertical extent is from 18,000 feet to and including FL 600 throughout most of the conterminous U.S. and, in Alaska, from 18,000 feet to and including FL 600 but not including the airspace less than 1,500 feet above the surface of the earth and the Alaskan Peninsula west of longitude 160° 00" West. (A complete description of Class A airspace is contained in the Code of Federal Regulations (CFR), Title 14, Part 71.)

**3.3** Air traffic control and alerting services are provided by various air traffic control (ATC) units and are described in ENR 1.1.

**3.4** Radar service is an integral part of the air traffic system. A description of radar services and procedures is provided in ENR 1.1.

**3.5** The description of airspace designated for air traffic services is found in ENR 1.4.

**3.6** Procedural data and descriptions are found in ENR 1.5.

**3.7** Numerous restricted and prohibited areas are established within U.S. territory. These areas, none of which interfere with normal air traffic, are explained in ENR 1.5. Activation of areas subject to intermittent activity is notified in advance by a Notice to Air Missions (NOTAM), giving reference to the area by its identification.

**3.8** In general, the air traffic rules and procedures in force and the organization of the air traffic services are in conformity with ICAO Standards, Recommended Practices and Procedures. Differences between the national and international rules and procedures are given in GEN 1.7. The regional supplementary procedures and altimeter setting procedures are reproduced in full with an indication wherein there is a difference.

**3.9** Coordination between the operator and air traffic services is effected in accordance with 2.11 of Annex II, and 2.1.1.4 and 2.1.2.5 of Part VIII of the PANS-ATM (Doc 4444).

**3.10** Minimum flight altitudes on the ATS routes as listed in ENR 1.4 have been determined so as to ensure at least 1,000 feet vertical clearance above the highest obstacle within 4 nautical miles (NM) on each side of the

centerline of the route. However, where the regular divergence (4.5 degrees) of the navigational aid signal in combination with the distance between the navigational aids could result in the aircraft being more than 4 NM on either side of the centerline, the 4 NM protection limit is increased by the extent to which the divergence is more than 4 NM from the centerline.

**3.11 Pilot Visits to Air Traffic Facilities.** Pilots are encouraged to participate in local pilot/air traffic control outreach activities. However, due to security and workload concerns, requests for air traffic facility visits may not always be approved. Therefore, visit requests should be submitted through the air traffic facility as early as possible. Pilots should contact the facility and advise them of the number of persons in the group, the time and date of the proposed visit, and the primary interest of the group. The air traffic facility will provide further instructions if a request can be approved.

**3.12 Operation Rain Check.** Operation Rain Check is a program designed and managed by local air traffic control facility management. Its purpose is to familiarize pilots and aspiring pilots with the ATC system, its functions, responsibilities and benefits.

## 4. En Route Procedures

### 4.1 Air Route Traffic Control Center (ARTCC)

An ARTCC is a facility established to provide air traffic control service to aircraft operating on instrument flight rule (IFR) flight plans within CONTROLLED AIRSPACE and principally during the en route phase of flight. When equipment capabilities and controller workload permit, certain advisory/assistance services may be provided to visual flight rule (VFR) aircraft.

### 4.2 ARTCC Communications

#### 4.2.1 Direct Communications, Controllers and Pilots

**4.2.1.1** ARTCCs are capable of direct communications with IFR air traffic on certain frequencies. Maximum communications coverage is possible through the use of Remote Center Air/Ground (RCAG) sites comprised of very high frequency (VHF) and ultra high frequency (UHF) transmitters and receivers. These sites are located throughout the U.S. Although they may be several hundred miles away from the ARTCC, they are remoted to the various centers by land lines or microwave links. As IFR operations are expedited through the use of direct communications, pilots are requested to use these frequencies strictly for communications pertinent to the control of IFR aircraft. Flight plan filing, en route weather, weather forecasts, and similar data should be requested through Flight Service Stations, company radio, or appropriate military facilities capable of performing these services.

**4.2.1.2** An ARTCC is divided into sectors. Each sector is handled by one or a team of controllers and has its own sector discrete frequency. As a flight progresses from one sector to another, the pilot is requested to change to the appropriate sector discrete frequency.

**4.2.1.3** Controller Pilot Data Link Communications (CPDLC) is a system that supplements air/ground voice communications. The CPDLC's principal operating criteria are:

- a) Voice remains the primary and controlling air/ground communications means.
- b) Participating aircraft will need to have the appropriate CPDLC avionics equipment in order to receive uplink or transmit downlink messages.
- c) En Route CPDLC Initial Services offer the following services: Altimeter Setting (AS), Transfer of Communications (TOC), Initial Contact (IC), and limited route assignments, including airborne reroutes (ABRR), limited altitude assignments, and emergency messages.
  - 1) Altimeter settings will be uplinked automatically when appropriate after a Monitor TOC. Altimeter settings will also be uplinked automatically when an aircraft receives an uplinked altitude assignment below FL 180. A controller may also manually send an altimeter setting message.

**NOTE-**

When conducting instrument approach procedures, pilots are responsible to obtain and use the appropriate altimeter setting in accordance with 14 CFR Section 97.20. CPDLC issued altimeter settings are excluded for this purpose.

2) Initial contact is a safety validation transaction that compares a pilot’s initiated altitude downlink message with an aircraft’s stored altitude in the ATC automation system. When an IC mismatch or Confirm Assigned Altitude (CAA) downlink time-out indicator is displayed in the Full Data Block (FDB) and Aircraft List (ACL), the controller who has track control of the aircraft must use voice communication to verify the assigned altitude of the aircraft, and acknowledge the IC mismatch/time-out indicator.

3) Transfer of communications automatically establishes data link contact with a succeeding sector.

4) Menu text transmissions are scripted nontrajectory altering uplink messages.

5) The CPDLC Message Elements for the Initial Capabilities rollout are contained in TBL GEN 3.3-1 through TBL GEN 3.3-19, CPDLC Message Elements, below.

**NOTE-**

The FAA is not implementing ATN B1; the ATN B1 column in the tables is there for informational purposes only.

TBL GEN 3.3-1

**Route Uplink Message Elements (RTEU)**

CPDLC Message Sets			Operational Definition in PANS-ATM (Doc 4444)		
FANS 1/A	ATN B1	Response	Message Element Identifier	Message Element Intended Use	Format for Message Element Display
UM74 PROCEED DIRECT TO <i>(position)</i>	UM74 PROCEED DIRECT TO <i>(position)</i>	W/U	RTEU-2	Instruction to proceed directly to the specified position.	PROCEED DIRECT TO <i>(position)</i>
UM79 CLEARED TO <i>(position)</i> via <i>(route clearance)</i>	UM79 CLEARED TO <i>(position)</i> via <i>(route clearance)</i>	W/U	RTEU-6	Instruction to proceed to the specified position via the specified route.	CLEARED TO <i>(position)</i> VIA <i>(departure data[O])</i> <i>(en-route data)</i>
UM80 CLEARED <i>(route clearance)</i>	UM80 CLEARED <i>(route clearance)</i>	W/U	RTEU-7	Instruction to proceed via the specified route.	CLEARED <i>(departure data[O])</i> <i>(en-route data)</i> <i>(arrival approach data)</i>
UM83 AT <i>(position)</i> CLEARED <i>(route clearance)</i>	N/A	W/U	RTEU-9	Instruction to proceed from the specified position via the specified route.	AT <i>(position)</i> CLEARED <i>(en-route data)</i> <i>(arrival approach data)</i>

TBL GEN 3.3-2

**Route Downlink Message Elements (RTED)**

CPDLC Message Sets			Operational Definition in PANS-ATM (Doc 4444)		
FANS 1/A	ATN B1	Response	Message Element Identifier	Message Element Intended Use	Format for Message Element Display
DM22 REQUEST DIRECT TO <i>(position)</i>	DM22 REQUEST DIRECT TO <i>(position)</i>	Y	RTED-1	Request for a direct clearance to the specified position.	REQUEST DIRECT TO <i>(position)</i>

TBL GEN 3.3-3  
Lateral Downlink Message Elements (LATD)

CPDLC Message Sets			Operational Definition in PANS-ATM (Doc 4444)		
FANS 1/A	ATN B1	Response	Message Element Identifier	Message Element Intended Use	Format for Message Element Display
DM59 DIVERTING TO <i>(position)</i> VIA <i>(route clearance)</i> <i>Note 1. – H alert attribute</i> <i>Note 2. – N response attribute</i>	N/A	N <sup>1</sup>	LATD-5	Report indicating diverting to the specified position via the specified route, which may be sent without any previous coordination done with ATC.	DIVERTING TO <i>(position)</i> VIA <i>(en-route data)</i> <i>(arrival approach data[O])</i>
DM60 OFFSETTING <i>(distance offset)</i> <i>(direction)</i> OF ROUTE <i>Note 1. – H alert attribute</i> <i>Note 2. – N response attribute</i>	N/A	N <sup>1</sup>	LATD-6	Report indicating that the aircraft is offsetting to a parallel track at the specified distance in the specified direction off from the cleared route.	OFFSETTING <i>(specified distance)</i> <i>(direction)</i> OF ROUTE
DM80 DEVIATING <i>(deviation offset)</i> <i>(direction)</i> OF ROUTE <i>Note 1. – H alert attribute</i> <i>Note 2. – N response attribute</i>	N/A	N <sup>1</sup>	LATD-7	Report indicating deviating specified distance or degrees in the specified direction from the cleared route.	DEVIATING <i>(specifiedDeviation)</i> <i>(direction)</i> OF ROUTE

<sup>1</sup> ICAO Document 10037, *Global Operational Data Link (GOLD) Manual* has these values set to Y in their table.

TBL GEN 3.3-4  
Level Uplink Message Elements (LVLU)

CPDLC Message Sets			Operational Definition in PANS-ATM (Doc 4444)		
FANS 1/A	ATN B1	Response	Message Element Identifier	Message Element Intended Use	Format for Message Element Display
UM19 MAINTAIN <i>(altitude)</i> <i>Note – Used for a single level</i>	UM19 MAINTAIN <i>(level)</i>	W/U	LVLU-5	Instruction to maintain the specified level or vertical range.	MAINTAIN <i>(level)</i>
UM20 CLIMB TO AND MAINTAIN <i>(altitude)</i> <i>Note – Used for a single level</i>	UM20 CLIMB TO <i>(level)</i>	W/U	LVLU-6	Instruction that a climb to the specified level or vertical range is to commence and once reached is to be maintained.	CLIMB TO <i>(level)</i>

CPDLC Message Sets			Operational Definition in PANS-ATM (Doc 4444)		
FANS 1/A	ATN B1	Response	Message Element Identifier	Message Element Intended Use	Format for Message Element Display
UM23 DESCEND TO AND MAINTAIN (altitude) <i>Note – Used for a single level</i>	UM23 DESCEND TO (level)	W/U	LVLU-9	Instruction that a descent to the specified level or vertical range is to commence and once reached is to be maintained.	DESCEND TO (level)
UM36 EXPEDITE CLIMB TO (altitude) <i>Note – This message element is equivalent to SUPU-3 plus LVLU-6 in Doc 4444.</i>	N/A	W/U	LVLU-6	Instruction that a climb to the specified level or vertical range is to commence and once reached is to be maintained.	CLIMB TO (level)
UM37 EXPEDITE DESCEND TO (altitude)	N/A	W/U	LVLU-9	Instruction that a descent to the specified level or vertical range is to commence and once reached is to be maintained.	DESCEND TO (level)
UM38 IMMEDIATELY CLIMB TO (altitude) <i>Note – This message element is equivalent to EMGU-2 plus LVLU-6 in Doc 4444.</i>	N/A	W/U	LVLU-6	Instruction that a climb to the specified level or vertical range is to commence and once reached is to be maintained.	CLIMB TO (level)
UM39 IMMEDIATELY DESCEND TO (altitude) <i>Note – This message element is equivalent to EMGU-2 plus LVLU-9 in Doc 4444.</i>	N/A	W/U	LVLU-9	Instruction that a descent to the specified level or vertical range is to commence and once reached is to be maintained.	DESCEND TO (level)
UM135 CONFIRM ASSIGNED ALTITUDE <i>Note – NE response attribute</i>	N/A	Y	LVLU-27	Request to confirm the assigned level.	CONFIRM ASSIGNED LEVEL
UM177 AT PILOTS DISCRETION	N/A	NE	See Note	Request to confirm the assigned level.	

**NOTE-**  
ICAO Document 10037, Global Operational Data Link (GOLD) Manual does not include this in its tables.

**TBL GEN 3.3-5**  
**Level Downlink Message Elements (LVLD)**

CPDLC Message Sets			Operational Definition in PANS-ATM (Doc 4444)		
FANS 1/A	ATN B1	Response	Message Element Identifier	Message Element Intended Use	Format for Message Element Display
DM6 REQUEST ( <i>altitude</i> ) <i>Note – Used for a single level</i>	DM6 REQUEST ( <i>level</i> )	Y	LVLD-1	Request to fly at the specified level or vertical range.	REQUEST ( <i>level</i> )
DM9 REQUEST CLIMB TO ( <i>altitude</i> )	DM9 REQUEST CLIMB TO ( <i>level</i> )	Y	LVLD-2	Request for a climb to the specified level or vertical range.	REQUEST CLIMB TO ( <i>level</i> )
DM10 REQUEST DESCENT TO ( <i>altitude</i> )	DM10 REQUEST DESCENT TO ( <i>level</i> )	Y	LVLD-3	Request for a descent to the specified level or vertical range.	REQUEST DESCENT TO ( <i>level</i> )
DM38 ASSIGNED LEVEL ( <i>altitude</i> ) <i>Note – Used for a single level</i>	DM38 ASSIGNED LEVEL ( <i>level</i> )	N	LVLD-11	Confirmation that the assigned level or vertical range is the specified level or vertical range.	ASSIGNED LEVEL ( <i>level</i> )
DM61 DESCENDING TO ( <i>altitude</i> ) <i>Note – urgent alert attribute</i>	N/A	N	LVLD-14	Report indicating descending to the specified level.	DESCENDING TO ( <i>level single</i> )



TBL GEN 3.3-6  
Crossing Constraint Message Elements (CSTU)

CPDLC Message Sets			Operational Definition in PANS-ATM (Doc 4444)		
FANS 1/A	ATN B1	Response	Message Element Identifier	Message Element Intended Use	Format for Message Element Display
UM49 CROSS ( <i>position</i> ) AT AND MAINTAIN ( <i>altitude</i> ) <i>Note 1. – A vertical range cannot be provided.</i> <i>Note 2. – This message element is equivalent to CSTU-1 plus LVLU-5 in Doc 4444.</i>	N/A	W/U	CSTU-1	Instruction that the specified position is to be crossed at the specified level or within the specified vertical range.	CROSS ( <i>position</i> ) AT ( <i>level</i> )
UM61 CROSS ( <i>position</i> ) AT AND MAINTAIN ( <i>altitude</i> ) AT ( <i>speed</i> ) <i>Note 1. – A vertical range cannot be provided.</i> <i>Note 2. – This message element is equivalent to CSTU-14 plus LVLU-5 in Doc 4444.</i>	UM61 CROSS ( <i>position</i> ) AT AND MAINTAIN ( <i>level</i> ) AT ( <i>speed</i> )	W/U	CSTU-14	Instruction that the specified position is to be crossed at the level or within the vertical range, as specified, and at the specified speed.	CROSS ( <i>position</i> ) AT ( <i>level</i> ) AT ( <i>speed</i> )

TBL GEN 3.3-7  
Air Traffic Advisory Uplink Message Elements (ADVU)

CPDLC Message Sets			Operational Definition in PANS-ATM (Doc 4444)		
FANS 1/A	ATN B1	Response	Message Element Identifier	Message Element Intended Use	Format for Message Element Display
UM154 RADAR SERVICES TERMINATED	N/A	R	ADVU-2	<i>Advisory that the ATS surveillance service is terminated.</i>	SURVEILLANCE SERVICE TERMINATED

**TBL GEN 3.3-8**  
**Voice Communications Uplink Message Elements (COMU)**

CPDLC Message Sets			Operational Definition in PANS-ATM (Doc 4444)		
FANS 1/A	ATN B1	Response	Message Element Identifier	Message Element Intended Use	Format for Message Element Display
UM117 CONTACT <i>(ICAO unit name)</i> <i>(frequency)</i>	UM117 CONTACT <i>(unit name)</i> <i>(frequency)</i>	W/U	COMU-1	Instruction to establish voice contact with the specified ATS unit on the specified frequency.	CONTACT <i>(unit name)</i> <i>(frequency)</i>
UM120 MONITOR <i>(ICAO unit name)</i> <i>(frequency)</i>	UM120 MONITOR <i>(unit name)</i> <i>(frequency)</i>	W/U	COMU-5	Instruction to monitor the specified ATS unit on the specified frequency. The flight crew is not required to establish voice contact on the frequency.	MONITOR <i>(unit name)</i> <i>(frequency)</i>

**TBL GEN 3.3-9**  
**Voice Communications Downlink Message Elements (COMD)**

CPDLC Message Sets			Operational Definition in PANS-ATM (Doc 4444)		
FANS 1/A	ATN B1	Response	Message Element Identifier	Message Element Intended Use	Format for Message Element Display
DM20 REQUEST VOICE CONTACT <i>Note – Used when a frequency is not required.</i>	N/A	Y	COMD-1	Request for voice contact on the specified frequency.	REQUEST VOICE CONTACT <i>(frequency)</i>

**TBL GEN 3.3-10**  
**Emergency/Urgency Uplink Message Elements (EMGU)**

CPDLC Message Sets			Operational Definition in PANS-ATM (Doc 4444)		
FANS 1/A	ATN B1	Response	Message Element Identifier	Message Element Intended Use	Format for Message Element Display
Used in combination with LVLU-6 and LVLU-9, which is implemented in FANS 1/A as:  UM38 IMMEDIATELY CLIMB TO <i>(altitude)</i>  UM39 IMMEDIATELY DESCEND TO <i>(altitude)</i>	N/A	N	EMGU-2	Instruction to immediately comply with the associated instruction to avoid imminent situation.	Immediately

*TBL GEN 3.3-11*  
**Emergency/Urgency Downlink Message Elements (EMGD)**

CPDLC Message Sets			Operational Definition in PANS-ATM (Doc 4444)		
FANS 1/A	ATN B1	Response	Message Element Identifier	Message Element Intended Use	Format for Message Element Display
DM55 PAN PAN PAN <i>Note – N response attribute</i>	N/A	Y	EMGD-1	Indication of an urgent situation.	PAN PAN PAN
DM56 MAYDAY MAYDAY MAYDAY <i>Note – N response attribute</i>	N/A	Y	EMGD-2	Indication of an emergency situation.	MAYDAY MAYDAY MAYDAY
DM57 ( <i>remaining fuel</i> ) OF FUEL REMAINING AND ( <i>remaining souls</i> ) SOULS ON BOARD <i>Note – N response attribute</i>	N/A	Y	EMGD-3	Report indicating fuel remaining (time) and number of persons on board.	( <i>remaining fuel</i> ) ENDURANCE AND ( <i>persons on board</i> ) PERSONS ON BOARD
DM58 CANCEL EMERGENCY <i>Note – N response attribute</i>	N/A	Y	EMGD-4	Indication that the emergency situation is canceled.	CANCEL EMERGENCY

*TBL GEN 3.3-12*  
**Standard Response Uplink Message Elements (RSPU)**

CPDLC Message Sets			Operational Definition in PANS-ATM (Doc 4444)		
FANS 1/A	ATN B1	Response	Message Element Identifier	Message Element Intended Use	Format for Message Element Display
UM0 UNABLE	UM0 UNABLE	N	RSPU-1	Indication that the message cannot be complied with.	UNABLE
UM1 STANDBY	UM1 STANDBY	N	RSPU-2	Indication that the message will be responded to shortly.	STANDBY
UM3 ROGER	UM3 ROGER	N	RSPU-4	Indication that the message is received.	ROGER

*TBL GEN 3.3–13*  
**Standard Response Downlink Message Elements (RSPD)**

CPDLC Message Sets			Operational Definition in PANS–ATM (Doc 4444)		
FANS 1/A	ATN B1	Response	Message Element Identifier	Message Element Intended Use	Format for Message Element Display
DM0 WILCO	DM0 WILCO	N	RSPD–1	Indication that the instruction is understood and will be complied with.	WILCO
DM1 UNABLE	DM1 UNABLE	N	RSPD–2	Indication that the message cannot be complied with.	UNABLE
DM2 STANDBY	DM2 STANDBY	N	RSPD–3	Indication that the message will be responded to shortly.	STANDBY
DM3 ROGER <i>Note – ROGER is the only correct response to an uplink free text message.</i>	DM3 ROGER	N	RSPD–4	Indication that the message is received.	ROGER

*TBL GEN 3.3–14*  
**Supplemental Uplink Message Elements (SUPU)**

CPDLC Message Sets			Operational Definition in PANS–ATM (Doc 4444)		
FANS 1/A	ATN B1	Response	Message Element Identifier	Message Element Intended Use	Format for Message Element Display
UM166 DUE TO TRAFFIC	N/A	N	SUPU–2	Indication that the associated message is issued due to the specified reason.	DUE TO <i>(specified reason uplink)</i>
UM167 DUE TO AIRSPACE RESTRICTION					

*TBL GEN 3.3–15*  
**Supplemental Downlink Message Elements (SUPD)**

CPDLC Message Sets			Operational Definition in PANS–ATM (Doc 4444)		
FANS 1/A	ATN B1	Response	Message Element Identifier	Message Element Intended Use	Format for Message Element Display
DM65 DUE TO WEATHER	DM65 DUE TO WEATHER	N	SUPD–1	Indication that the associated message is issued due to the specified reason.	DUE TO <i>(specified reason downlink)</i>
DM66 DUE TO AIRCRAFT PERFORMANCE	DM66 DUE TO AIRCRAFT PERFORMANCE				

TBL GEN 3.3-16  
Free Text Uplink Message Elements (TXTU)

CPDLC Message Sets			Operational Definition in PANS-ATM (Doc 4444)		
FANS 1/A	ATN B1	Response	Message Element Identifier	Message Element Intended Use	Format for Message Element Display
UM169 (free text)	UM203 (free text)	R	TXTU-1		(free text) Note – M alert attribute.
UM169 (free text) CPDLC NOT IN USE UNTIL FURTHER NOTIFICATION	N/A	R	See Note		(free text)
UM169 (free text) “[facility designation]” LOCAL ALTIMETER (for Altimeter Report- ing Station)	N/A	R	See Note		(free text)
UM169 (free text) “[facility designation] LOCAL ALTIMETER MORE THAN ONE HOUR” OLD	N/A	R	See Note		(free text)
UM169 (free text) DUE TO WEATHER	N/A	R	See Note		(free text)
UM169 (free text) REST OF ROUTE UN- CHANGED	N/A	R	See Note		(free text)
UM169 (free text) TRAFFIC FLOW MANAGEMENT REROUTE	N/A	R	See Note		(free text)

**NOTE-**  
These are FAA scripted free text messages with no GOLD equivalent.

TBL GEN 3.3-17  
Free Text Downlink Message Elements (TXTD)

CPDLC Message Sets			Operational Definition in PANS-ATM (Doc 4444)		
FANS 1/A	ATN B1	Response	Message Element Identifier	Message Element Intended Use	Format for Message Element Display
DM68 (free text) Note 1. – Urgency or Distress Alr (M)  Note 2. – Selecting any of the emergency message elements will result in this message ele- ment being enabled for the flight crew to include in the emergency message at their discretion.	N/A	Y	TXTD-1		(free text) Note – M alert attribute.

TBL GEN 3.3–18  
System Management Uplink Message Elements (SYSU)

CPDLC Message Sets			Operational Definition in PANS–ATM (Doc 4444)		
FANS 1/A	ATN B1	Response	Message Element Identifier	Message Element Intended Use	Format for Message Element Display
UM159 ERROR ( <i>error information</i> )	UM159 ERROR ( <i>error information</i> )	N	SYSU–1	System-generated notification of an error.	ERROR ( <i>error information</i> )
UM160 NEXT DATA AUTHORITY ( <i>ICAO facility designation</i> ) <i>Note – The facility designation is required.</i>	UM160 NEXT DATA AUTHORITY ( <i>facility</i> ) <i>Note – Facility parameter can specify a facility designation or no facility.</i>	N	SYSU–2	System-generated notification of the next data authority or the cancellation thereof.	NEXT DATA AUTHORITY ( <i>facility designation [O]</i> )

TBL GEN 3.3–19  
System Management Downlink Message Elements (SYSD)

CPDLC Message Sets			Operational Definition in PANS–ATM (Doc 4444)		
FANS 1/A	ATN B1	Response	Message Element Identifier	Message Element Intended Use	Format for Message Element Display
DM62 ERROR ( <i>error information</i> )	DM62 ERROR ( <i>error information</i> )	N	SYSD–1	System-generated notification of an error.	SYSD–1
DM63 NOT CURRENT DATA AUTHORITY	DM63 NOT CURRENT DATA AUTHORITY	N	SYSD–3	System-generated rejection of any CPDLC message sent from a ground facility that is not the current data authority.	SYSD–3
DM64 ( <i>ICAO facility designation</i> ) <i>Note – Use by FANS 1/A aircraft in B1 environments.</i>	DM107 NOT AUTHORIZED NEXT DATA AUTHORITY <i>Note – CDA and NDA cannot be provided.</i>	N	SYSD–5	System-generated notification that the ground system is not designated as the next data authority (NDA), indicating the identity of the current data authority (CDA). Identity of the NDA, if any, is also reported.	SYSD–5

## 4.2.2 ATC Frequency Change Procedures

4.2.2.1 The following phraseology will be used by controllers to effect a frequency change:

**EXAMPLE–**

*(Aircraft identification) CONTACT (facility name or location name and terminal function) (frequency) AT (time, fix, or altitude).*

**NOTE–**

*Pilots are expected to maintain a listening watch on the transferring controller's frequency until the time, fix, or altitude specified. ATC will omit frequency change restrictions whenever pilot compliance is expected upon receipt.*

4.2.2.2 The following phraseology should be utilized by pilots for establishing contact with the designated facility:

a) When operating in a radar environment:

1) On initial contact, the pilot should inform the controller of the aircraft's assigned altitude preceded by the words "level," or "climbing to," or "descending to," as appropriate; and the aircraft's present vacating altitude, if applicable.

**EXAMPLE–**

1. *(Name) CENTER, (aircraft identification), LEVEL (altitude or flight level).*

2. *(Name) CENTER, (aircraft identification), LEAVING (exact altitude or flight level), CLIMBING TO OR DESCENDING TO (altitude or flight level).*

**NOTE–**

*Exact altitude or flight level means to the nearest 100 foot increment. exact altitude or flight level reports on initial contact provide ATC with information required prior to using Mode C altitude information for separation purposes.*

b) When operating in a nonradar environment:

1) On initial contact, the pilot should inform the controller of the aircraft's present position, altitude and time estimate for the next reporting point.

**EXAMPLE–**

*(Name) CENTER, (aircraft identification), (POSITION), (altitude), ESTIMATING (reporting point) at (time).*

2) After initial contact, when a position report will be made, the pilot should give the controller a complete position report.

**EXAMPLE–**

*(Name) CENTER, (aircraft identification), (position), (time), (altitude), (type of flight plan), (ETA and name of next reporting point), (the name of the next succeeding reporting point), AND (remarks).*

**REFERENCE–**

*AIP, Position Reporting, Paragraph 6.*

4.2.2.3 At times controllers will ask pilots to verify the fact that they are at a particular altitude. The phraseology used will be: "VERIFY AT (altitude)." In climbing/descending situations, controllers may ask pilots to "VERIFY ASSIGNED ALTITUDE AS (altitude)." Pilots should confirm that they are at the altitude stated by the controller or that the assigned altitude is correct as stated. If this is not the case, they should inform the controller of the actual altitude being maintained or the different assigned altitude.

**CAUTION–**

*Pilots should not take action to change their actual altitude or different assigned altitude to that stated in the controller's verification request unless the controller specifically authorizes a change.*

4.2.3 **ARTCC Radio Frequency Outage.** ARTCC's normally have at least one back-up radio receiver and transmitter system for each frequency which can usually be pressed into service quickly with little or no disruption of ATC service. Occasionally, technical problems may cause a delay but switchover seldom takes more than 60 seconds. When it appears that the outage will not be quickly remedied, the ARTCC will usually request a nearby aircraft, if there is one, to switch to the affected frequency to broadcast communications instructions. It is important, therefore, that the pilot wait at least one minute before deciding that the ARTCC has

actually experienced a radio frequency failure. When such an outage does occur, the pilot should, if workload and equipment capability permit, maintain a listening watch on the affected frequency while attempting to comply with the recommended communications procedures which follow.

**4.2.3.1** If two-way communications cannot be established with the ARTCC after changing frequencies, a pilot should attempt to recontact the transferring controller for the assignment of an alternative frequency or other instructions.

**4.2.3.2** When an ARTCC radio frequency failure occurs after two-way communications have been established, the pilot should attempt to reestablish contact with the center on any other known ARTCC frequency, preferably that of the next responsible sector when practicable, and ask for instructions. However, when the next normal frequency change along the route is known to involve another ATC facility, the pilot should contact that facility, if feasible, for instructions. If communications cannot be reestablished by either method, the pilot is expected to request communications instructions from the FSS appropriate to the route of flight.

**NOTE–**

*The exchange of information between an aircraft and an ARTCC through an FSS is quicker than relay via company radio because the FSS has direct interphone lines to the responsible ARTCC sector. Accordingly, when circumstances dictate a choice between the two, during an ARTCC frequency outage, relay via FSS radio is recommended.*

## 5. Radio Communications Failure

**5.1** Pilots of IFR flights experiencing two-way radio failure are expected to adhere to the procedures prescribed in GEN 3.4, paragraph 12.

**REFERENCE–**

*14 CFR Section 91.185*

## 6. Position Reporting

**6.1** The safety and effectiveness of traffic control depends to a large extent on accurate position reporting. In order to provide the proper separation and expedite aircraft movements, ATC must be able to make accurate estimates of the progress of every aircraft operating on an IFR flight plan.

### 6.2 Position Identification

**6.2.1** When a position report is to be made passing a VOR radio facility, the time reported should be the time at which the first complete reversal of the “to/from” indicator is accomplished.



**6.2.2** When a position report is made passing a facility by means of an airborne automatic direction finder (ADF), the time reported should be the time at which the indicator makes a complete reversal.

**6.2.3** When an aural or light-panel indication is used to determine the time passing a reporting point, such as a fan marker, Z marker, cone of silence or intersection of range courses, the time should be noted when the signal is first received and again when it ceases. The mean of these two times should then be taken as the actual time over the fix.

**6.2.4** If a position is given with respect to distance and direction from a reporting point, the distance and direction should be computed as accurately as possible.

**6.2.5** Except for terminal transition purposes, position reports or navigation with reference to aids not established for use in the structure in which flight is being conducted will not normally be required by ATC.

### 6.3 Position Reporting Points

**6.3.1** Federal Aviation Regulations require pilots to maintain a listening watch on the appropriate frequency and, unless operating under the provisions of subparagraph 6.4, to furnish position reports passing certain reporting points. Reporting points are indicated by symbols on en route charts. The designated compulsory reporting point symbol is the solid triangle ; the “on request” reporting point symbol is the open triangle . Reports passing an “on request” reporting point are only necessary when requested by ATC.



## 6.4 Position Reporting Requirements

**6.4.1 Flights Along Airways or Routes.** A position report is required by all flights regardless of altitude, including those operating in accordance with an ATC clearance specifying “VFR–on–top,” over each designated compulsory reporting point along the route being flown.

**6.4.2 Flight Along a Direct Route.** Regardless of the altitude or flight level being flown, including flights operating in accordance with an ATC clearance specifying “VFR–on–top,” pilots must report over each reporting point used in the flight plan to define the route of flight.

**6.4.3 Flights in a Radar Environment.** When informed by ATC that their aircraft are in “RADAR CONTACT,” PILOTS SHOULD DISCONTINUE POSITION REPORTS OVER DESIGNATED REPORTING POINTS. They should resume normal position reporting when ATC advises “RADAR CONTACT LOST” or “RADAR SERVICE TERMINATED.”

**NOTE–**

*ATC will inform pilots that they are in “radar contact” (a) When their aircraft is initially identified in the ATC system; and (b) When radar identification is reestablished after radar service has been terminated or radar contact has been lost. Subsequent to being advised that the controller has established radar contact, this fact will not be repeated to the pilot when handed off to another controller. At times, the aircraft identity will be confirmed by the receiving controller; however, this should not be construed to mean that radar contact has been lost. The identity of transponder–equipped aircraft will be confirmed by asking the pilot to “ident, squawk standby,” or to change codes. Aircraft without transponders will be advised of their position to confirm identity. In this case, the pilot is expected to advise the controller if in disagreement with the position given. If the pilot cannot confirm the accuracy of the position given because of not being tuned to the NAVAID referenced by the controller, the pilot should ask for another radar position relative to the tuned in NAVAID.*

**6.4.4 Flights in an Oceanic (Non-radar) Environment.** Pilots must report over each point used in the flight plan to define the route of flight, even if the point is depicted on aeronautical charts as an “on request” (non-compulsory) reporting point. For aircraft providing automatic position reporting via an Automatic Dependent Surveillance-Contract (ADS-C) logon, pilots should discontinue voice position reports.

## 6.5 Position Report Items

**6.5.1 Position reports should include the following items:**

**6.5.1.1** Identification.

**6.5.1.2** Position.

**6.5.1.3** Time.

**6.5.1.4** Altitude or flight level (Include actual altitude or flight level when operating on a clearance specifying “VFR–on–top.”).

**6.5.1.5** Type of flight plan (not required in IFR position reports made directly to ARTCCs or approach control).

**6.5.1.6** ETA and name of next reporting point.

**6.5.1.7** The name only of the next succeeding reporting point along the route of flight.

**6.5.1.8** Pertinent remarks.

## 7. Additional Reports

**7.1** The following reports should be made to ATC or FSS facilities without a specific request:

**7.1.1 At all times, report:**

**7.1.1.1** When vacating any previously assigned altitude/flight level for a newly assigned altitude/flight level.

**7.1.1.2** When an altitude change will be made if operating on a clearance specifying “VFR–on–top.”

**7.1.1.3** When unable to climb/descend at a rate of at least 500 feet per minute.

**7.1.1.4** When approach has been missed. (Request clearance for specific action; i.e., to alternative airport, another approach, etc.).

**7.1.1.5** Change in the average true airspeed (at cruising altitude) when it varies by 5 percent or 10 knots (whichever is greater) from that filed in the flight plan.

**7.1.1.6** The time and altitude/flight level reaching a holding fix or point to which cleared.

**7.1.1.7** When leaving any assigned holding fix or point.

**NOTE–**

*The reports in subparagraphs 7.1.1.6 and 7.1.1.7 may be omitted by pilots of aircraft involved in instrument training at military area facilities when radar service is being provided.*

**7.1.1.8** Any loss, in controlled airspace, of VOR, TACAN, ADF, low frequency navigation receiver capability, GPS anomalies while using installed IFR–certified GPS/GNSS receivers, complete or partial loss of ILS receiver capability or impairment of air/ground communications capability. Reports should include aircraft identification, equipment affected, degree to which the capability to operate under IFR in the ATC system is impaired, and the nature and extent of assistance desired from ATC.

**NOTE–**

*When reporting GPS anomalies, include the location and altitude of the anomaly. Be specific when describing the location and include duration of the anomaly if necessary.*

**7.1.1.9** Any information relating to the safety of flight.

**NOTE–**

*Other equipment installed in an aircraft may effectively impair safety and/or the ability to operate under IFR. If such equipment; e.g., airborne weather radar, malfunctions and in the pilot's judgment either safety or IFR capabilities are affected, reports should be made as above.*

**7.2 When not in radar contact, report:**

**7.2.1** When leaving the final approach fix inbound on final approach (nonprecision approach) or when leaving the outer marker or fix used in lieu of the outer marker inbound on final approach (precision approach); or

**7.2.2** A corrected estimate at anytime it becomes apparent that an estimate as previously submitted is in error in excess of 2 minutes. For flights in the North Atlantic (NAT), a revised estimate is required if the error is 3 minutes or more.

**7.3** Pilots encountering weather conditions which have not been forecast, or hazardous conditions which have been forecast, are expected to forward a report of such weather to ATC.

**8. Quota Flow Control**

**8.1** Quota Flow Control is designed to balance the ATC system demand with system capacity.

**8.2** ARTCCs will hold the optimum number of aircraft that their primary and secondary holding fixes will safely accommodate without imposing undue limitations on the control of other traffic operating within the ARTCC's airspace. This is based on the user's requirement to continue operating to a terminal regardless of the arrival rate at that terminal. When staffing, equipment, or severe weather will inhibit the number of aircraft the arrival ARTCC may safely hold, a reduction may be necessary.

**8.3** When an ARTCC is holding the optimum number of aircraft, the adjacent ARTCCs will be issued quotas concerning aircraft which can be cleared into the impacted ARTCC's airspace. When the adjacent center's demand exceeds the quota, aircraft will be held in the adjacent ARTCC's airspace until they can be permitted to proceed.

**8.4** The size of the hourly quota will be based initially on the projected arrival rate and thereafter on the actual landing and diversion totals. Once quotas have been imposed, departures in the arrival and adjacent ARTCC's area to the affected airport may be assigned ground delay, if necessary, to limit airborne holding to ATC capacity.

However, when a forecast of improved arrival rate appears reliable, in the opinion of the arrival ARTCC, additional above-quota flights may be approved based on the expectation that by the time these additional above-quota flights become an operational factor in the affected area, the system will be able to absorb them without undue difficulty.

**8.5** Long distance flights, which originate beyond the adjacent ARTCC area, will normally be permitted to proceed to a point just short of the arrival ARTCC boundary where a delay, at least equal to the delays (ground/airborne) being encountered, will be assigned.

**8.6** ARTCCs imposing ground delays make efforts to advise the users when lengthy delays are a prospect to preclude unnecessary boarding and subsequent unloading prior to actual takeoff due to lengthy unanticipated ground delays. Users should advise the ARTCC through FSS or operation offices when there is any significant change in the proposed departure time so as to permit more efficient flow control planning. Airborne aircraft holding in the adjacent ARTCC airspace generally receive more benefit than ground delayed aircraft when increases unexpectedly develop in the quota number because the reaction time is less. For this reason, whenever operationally feasible, adjacent ARTCCs may offer airborne delay within their areas instead of ground delay.

**8.7** Flights originating beyond the adjacent ARTCC areas may not have sufficient fuel to absorb the total anticipated delay while airborne. Accordingly, the concerned adjacent ARTCC may permit these flights to land in its area while retaining previously accumulated delay for the purpose of quota priority. When the amount of air traffic backlogging in an adjacent ARTCC area is approaching the saturation point, additional en route traffic will be subject to prior approval.

**8.8** Generally, movement of arrival aircraft into the impacted airport terminal area will be made on the basis that those flights with the most accumulated delay, either ground, airborne, or a combination of both, normally receive priority over other traffic. This applies only to delays encountered because of the situation at the airport of intended landing.

**8.9** Pilots/operators are advised to check for flow control advisories which are transmitted to FSSs, to selected airline dispatch offices, and to ARTCCs.

## **9. Advisory and Air Traffic Information Services**

### **9.1 Approach Control Service for VFR Arriving Aircraft**

**9.1.1** Numerous approach control facilities have established programs for arriving VFR aircraft to contact approach control for landing information. This information includes: wind, runway, and altimeter setting at the airport of intended landing. This information may be omitted if contained in the ATIS broadcast and the pilot states the appropriate ATIS code.

**NOTE-**

*Pilot use of "have numbers" does not indicate receipt of the ATIS broadcast. In addition, the controller will provide traffic advisories on a workload permitting basis.*

**9.1.2** Such information will be furnished upon initial contact with the concerned approach control facility. The pilot will be requested to change to the tower frequency at a predetermined time or point, to receive further landing information.

**9.1.3** Where available, use of this procedure will not hinder the operation of VFR flights by requiring excessive spacing between aircraft or devious routing. Radio contact points will be based on time or distance rather than on landmarks.

**9.1.4** Compliance with this procedure is not mandatory, but pilot participation is encouraged. (See ENR 1.1, Paragraph 39, Terminal Radar Services for VFR Aircraft.)

**NOTE-**

*Approach control services for VFR aircraft are normally dependent on air traffic control radar. These services are not available during periods of a radar outage.*

## 9.2 Traffic Advisory Practices at Airports Without Operating Control Towers

### 9.2.1 Airport Operations Without an Operating Control Tower

**9.2.1.1** There is no substitute for alertness while in the vicinity of an airport. It is essential that pilots be alert and look for other traffic and exchange traffic information when approaching or departing an airport without an operating control tower. This is of particular importance since other aircraft may not have communication capability or, in some cases, pilots may not communicate their presence or intentions when operating into or out of such airports. To achieve the greatest degree of safety, it is essential that:

a) All radio–equipped aircraft transmit/receive on a common frequency identified for the purpose of airport advisories; and

b) Pilots use the correct airport name, as identified in appropriate aeronautical publications, to reduce the risk of confusion when communicating their position, intentions, and/or exchanging traffic information.

**9.2.1.2** An airport may have a full or part–time tower or FSS located on the airport, a full or part–time UNICOM station or no aeronautical station at all. There are three ways for pilots to communicate their intention and obtain airport/traffic information when operating at an airport that does not have an operating tower: by communicating with an FSS, a UNICOM operator, or by making a self–announce broadcast.

**NOTE–**

*FSS airport advisories are available only in Alaska.*

**9.2.1.3** Many airports are now providing completely automated weather, radio check capability and airport advisory information on an automated UNICOM system. These systems offer a variety of features, typically selectable by microphone clicks, on the UNICOM frequency. Availability of the automated UNICOM will be published in the Chart Supplement U.S. and approach charts.

### 9.2.2 Communicating on a Common Frequency

**9.2.2.1** The key to communicating at an airport without an operating control tower is selection of the correct common frequency. The acronym, CTAF, which stands for common traffic advisory frequency, is synonymous with this program. A CTAF is a frequency designated for the purpose of carrying out airport advisory practices while operating to or from an airport without an operating control tower. The CTAF may be a UNICOM, MULTICOM, FSS, or tower frequency and is identified in appropriate aeronautical publications.

**NOTE–**

*FSS frequencies are available only in Alaska.*

**9.2.2.2 CTAF (Alaska Only).** In Alaska, a CTAF may also be designated for the purpose of carrying out advisory practices while operating in designated areas with a high volume of VFR traffic.

**9.2.2.3** The CTAF frequency for a particular airport or area is contained in the Chart Supplement U.S., Chart Supplement Alaska, Alaska Terminal Publication, Instrument Approach Procedure Charts, and Instrument Departure Procedure (DP) Charts. Also, the CTAF frequency can be obtained by contacting any FSS. Use of the appropriate CTAF, combined with a visual alertness and application of the following recommended good operating practices, will enhance safety of flight into and out of all uncontrolled airports.

### 9.2.3 Recommended Traffic Advisory Practices

**9.2.3.1** Pilots of inbound aircraft should monitor and communicate on the designated CTAF from 10 miles to landing. Pilots of departing aircraft should monitor/communicate on the appropriate frequency from start–up, during taxi, and until 10 miles from the airport unless the Code of Federal Regulations (CFR) or local procedures require otherwise.

**9.2.3.2** Pilots of aircraft conducting other than arriving or departing operations at altitudes normally used by arriving and departing aircraft should monitor/communicate on the appropriate frequency while within 10 miles of the airport unless required to do otherwise by the CFR or local procedures. Such operations include parachute jumping/dropping (see ENR 5.1, Paragraph 2.3, Parachute Jump Aircraft Operations), en route, practicing maneuvers, etc.

**9.2.3.3** In Alaska, pilots of aircraft conducting other than arriving or departing operations in designated CTAF areas should monitor/communicate on the appropriate frequency while within the designated area, unless required to do otherwise by CFRs or local procedures. Such operations include parachute jumping/dropping, en route, practicing maneuvers, etc.

#### **9.2.4 Airport Advisory/Information Services Provided by a FSS**

**9.2.4.1** There are two advisory type services provided at selected airports.

a) Local Airport Advisory (LAA) is available only in Alaska and provided at airports that have a FSS physically located on the airport, which does not have a control tower or where the tower is operated on a part-time basis. The CTAF for LAA airports is disseminated in the appropriate aeronautical publications.

b) Remote Airport Information Service (RAIS) is provided in support of special events at nontowered airports by request from the airport authority and must be published as a NOTAM D.

**9.2.4.2** In communicating with a CTAF FSS, check the airport's automated weather and establish two-way communications before transmitting outbound/inbound intentions or information. An inbound aircraft should initiate contact approximately 10 miles from the airport, reporting aircraft identification and type, altitude, location relative to the airport, intentions (landing or over flight), possession of the automated weather, and request airport advisory or airport information service. A departing aircraft should initiate contact before taxiing, reporting aircraft identification and type, VFR or IFR, location on the airport, intentions, direction of take-off, possession of the automated weather, and request airport advisory or information service, as applicable. Also, report intentions before taxiing onto the active runway for departure. If you must change frequencies for other service after initial report to FSS, return to FSS frequency for traffic update.

a) Inbound

**EXAMPLE–**

*Vero Beach radio, Centurion Six Niner Delta Delta is ten miles south, two thousand, landing Vero Beach. I have the automated weather, request airport advisory.*

b) Outbound

**EXAMPLE–**

*Vero Beach radio, Centurion Six Niner Delta Delta, ready to taxi to runway 22, VFR, departing to the southwest. I have the automated weather, request airport advisory.*

**9.2.4.3** Airport advisory service includes wind direction and velocity, favored or designated runway, altimeter setting, known airborne and ground traffic, NOTAMs, airport taxi routes, airport traffic pattern information, and instrument approach procedures. These elements are varied so as to best serve the current traffic situation. Some airport managers have specified that under certain wind or other conditions designated runways be used. Pilots should advise the FSS of the runway they intend to use.

#### **9.2.4.4 Automatic Flight Information Service (AFIS) – Alaska FSSs Only**

a) AFIS is the continuous broadcast of recorded non-control information at airports in Alaska where an FSS provides local airport advisory service. Its purpose is to improve FSS specialist efficiency by reducing frequency congestion on the local airport advisory frequency.

1) The AFIS broadcast will automate the repetitive transmission of essential but routine information (for example, weather, favored runway, braking action, airport NOTAMs, etc.). The information is continuously broadcast over a discrete VHF radio frequency (usually the ASOS frequency).

2) Use of AFIS is not mandatory, but pilots who choose to utilize two-way radio communications with the FSS are urged to listen to AFIS, as it relieves frequency congestion on the local airport advisory frequency. AFIS broadcasts are updated upon receipt of any official hourly and special weather, and changes in other pertinent data.

3) When a pilot acknowledges receipt of the AFIS broadcast, FSS specialists may omit those items contained in the broadcast if they are current. When rapidly changing conditions exist, the latest ceiling, visibility, altimeter,

wind or other conditions may be omitted from the AFIS and will be issued by the FSS specialist on the appropriate radio frequency.

**EXAMPLE–**

*“Kotzebue information ALPHA. One six five five zulu. Wind, two one zero at five; visibility two, fog; ceiling one hundred overcast; temperature minus one two, dew point minus one four; altimeter three one zero five. Altimeter in excess of three one zero zero, high pressure altimeter setting procedures are in effect. Favored runway two six. Weather in Kotzebue surface area is below V–F–R minima – an ATC clearance is required. Contact Kotzebue Radio on 123.6 for traffic advisories and advise intentions. Notice to Air Missions, Hotham NDB out of service. Transcribed Weather Broadcast out of service. Advise on initial contact you have ALPHA.”*

**NOTE–**

*The absence of a sky condition or ceiling and/or visibility on Alaska FSS AFIS indicates a sky condition or ceiling of 5,000 feet or above and visibility of 5 miles or more. A remark may be made on the broadcast, “the weather is better than 5000 and 5.”*

- b) Pilots should listen to Alaska FSSs AFIS broadcasts whenever Alaska FSSs AFIS is in operation.

**NOTE–**

*Some Alaska FSSs are open part time and/or seasonally.*

- c) Pilots should notify controllers on initial contact that they have received the Alaska FSSs AFIS broadcast by repeating the phonetic alphabetic letter appended to the broadcast.

**EXAMPLE–**

*“Information Alpha received.”*

- d) While it is a good operating practice for pilots to make use of the Alaska FSS AFIS broadcast where it is available, some pilots use the phrase “have numbers” in communications with the FSS. Use of this phrase means that the pilot has received wind, runway, and altimeter information ONLY and the Alaska FSS does not have to repeat this information. It does not indicate receipt of the AFIS broadcast and should never be used for this purpose.

**CAUTION–**

*All aircraft in the vicinity of an airport may not be in communication with the FSS.*

### **9.2.5 Information Provided by Aeronautical Advisory Stations (UNICOM)**

**9.2.5.1** UNICOM is a nongovernment air/ground radio communication station which may provide airport information at public use airports where there is no tower or FSS.

**9.2.5.2** On pilot request, UNICOM stations may provide pilots with weather information, wind direction, the recommended runway, or other necessary information. If the UNICOM frequency is designated as the CTAF, it will be identified in appropriate aeronautical publications.

**9.2.5.3 Unavailability of Information from FSS or UNICOM.** Should LAA by an FSS or Aeronautical Advisory Station UNICOM be unavailable, wind and weather information may be obtainable from nearby controlled airports via Automatic Terminal Information Service (ATIS) or Automated Weather Observing System (AWOS) frequency.

### **9.2.6 Self–Announce Position and/or Intentions**

**9.2.6.1 General.** Self-announce is a procedure whereby pilots broadcast their position or intended flight activity or ground operation on the designated CTAF. This procedure is used primarily at airports which do not have an FSS on the airport. The self-announce procedure should also be used if a pilot is unable to communicate with the FSS on the designated CTAF. Pilots stating, “Traffic in the area, please advise” is not a recognized Self–Announce Position and/or Intention phrase and should not be used under any condition.

**9.2.6.2** If an airport has a tower which is temporarily closed or operated on a part–time basis, and there is no FSS on the airport or the FSS is closed, use the CTAF to self–announce your position or intentions.

**9.2.6.3** Where there is no tower, FSS, or UNICOM station on the airport, use MULTICOM frequency 122.9 for self–announce procedures. Such airports will be identified in appropriate aeronautical information publications.

**9.2.6.4 Straight-in Landings.** The FAA discourages VFR straight-in approaches to landings due to the increased risk of a mid-air collision. However, if a pilot chooses to execute a straight-in approach for landing without entering the airport traffic pattern, the pilot should self-announce their position on the designated CTAF approximately 8 to 10 miles from the airport and coordinate their straight-in approach and landing with other airport traffic. Pilots executing a straight-in approach (IFR or VFR) do not have priority over other aircraft in the traffic pattern, and must comply with the provisions of 14 CFR 91.113 (g), Right-of-way rules.

**9.2.6.5 Traffic Pattern Operations.** All traffic within a 10-mile radius of a non-towered airport or a part-time-towered airport when the control tower is not operating, should monitor and communicate on the designated CTAF when entering the traffic pattern. Pilots operating in the traffic pattern or on a straight-in approach must be alert at all times to other aircraft in the pattern, or conducting straight-in approaches, and communicate their position to avoid a possible traffic conflict. In the airport traffic pattern and while on straight-in approaches to a runway, effective communication and a pilot's responsibility to see-and-avoid are essential mitigations to avoid a possible midair collision. In addition, following established traffic pattern procedures eliminates excessive maneuvering at low altitudes, reducing the risk of loss of aircraft control.

**REFERENCE–**

*FAA Advisory Circular (AC) 90–66, Non-Towered Airport Flight Operations.*

**9.2.6.6 Practice Approaches.** Pilots conducting practice instrument approaches should be particularly alert for other aircraft that may be departing in the opposite direction. When conducting any practice approach, regardless of its direction relative to other airport operations, pilots should make announcements on the CTAF as follows:

- a) Departing the final approach fix, inbound (nonprecision approach) or departing the outer marker or fix used in lieu of the outer marker, inbound (precision approach).
- b) Established on the final approach segment or immediately upon being released by ATC.
- c) Upon completion or termination of the approach; and
- d) Upon executing the missed approach procedure.

**9.2.6.7** Departing aircraft should always be alert for arrival aircraft coming from the opposite direction.

**9.2.6.8 Recommended Self-Announce broadcasts.** It should be noted that aircraft operating to or from another nearby airport may be making self-announce broadcasts on the same UNICOM or MULTICOM frequency. To help identify one airport from another, the airport name should be spoken at the beginning and end of each self-announce transmission. When referring to a specific runway, pilots should use the runway number and not use the phrase “Active Runway.”

- a) Inbound

**EXAMPLE–**

*Strawn traffic, Apache Two Two Five Zulu, (position), (altitude), (descending) or entering downwind/base/ final (as appropriate) runway one seven full stop/touch– and–go, Strawn.*

*Strawn traffic Apache Two Two Five Zulu clear of runway one seven Strawn.*

- b) Outbound

**EXAMPLE–**

*Strawn traffic, Queen Air Seven One Five Five Bravo (location on airport) taxiing to runway two six Strawn.*

*Strawn traffic, Queen Air Seven One Five Five Bravo departing runway two six. “Departing the pattern to the (direction), climbing to (altitude) Strawn.”*

- c) Practice Instrument Approach

**EXAMPLE–**

*Strawn traffic, Cessna Two One Four Three Quebec (position from airport) inbound descending through (altitude) practice (name of approach) approach runway three five Strawn.*

*Strawn traffic, Cessna Two One Four Three Quebec practice (type) approach completed or terminated runway three five Strawn.*

## 9.2.7 UNICOM Communication Procedures

**9.2.7.1** In communicating with a UNICOM station, the following practices will help reduce frequency congestion, facilitate a better understanding of pilot intentions, help identify the location of aircraft in the traffic pattern, and enhance safety of flight:

- a) Select the correct UNICOM frequency.
- b) State the identification of the UNICOM station you are calling in each transmission.
- c) Speak slowly and distinctly.
- d) Report approximately 10 miles from the airport, reporting altitude, and state your aircraft type, aircraft identification, location relative to the airport, state whether landing or overflight, and request wind information and runway in use.
- e) Report on downwind, base and final approach.
- f) Report leaving the runway.

### 9.2.7.2 Recommended UNICOM Phraseologies:

- a) Inbound.

**PHRASEOLOGY–**

*FREDERICK UNICOM CESSNA EIGHT ZERO ONE TANGO FOXTROT 10 MILES SOUTHEAST DESCENDING THROUGH (altitude) LANDING FREDERICK, REQUEST WIND AND RUNWAY INFORMATION FREDERICK.*

*FREDERICK TRAFFIC CESSNA EIGHT ZERO ONE TANGO FOXTROT ENTERING DOWNWIND/BASE/ FINAL (as appropriate) FOR RUNWAY ONE NINER FULL STOP/TOUCH–AND–GO FREDERICK.*

*FREDERICK TRAFFIC CESSNA EIGHT ZERO ONE TANGO FOXTROT CLEAR OF RUNWAY ONE NINER FREDERICK.*

- b) Outbound

**PHRASEOLOGY–**

*FREDERICK UNICOM CESSNA EIGHT ZERO ONE TANGO FOXTROT (location on airport) TAXIING TO RUNWAY ONE NINE, REQUEST WIND AND TRAFFIC INFORMATION FREDERICK.*

*FREDERICK TRAFFIC CESSNA EIGHT ZERO ONE TANGO FOXTROT DEPARTING RUNWAY ONE NINE. “REMAINING IN THE PATTERN” OR “DEPARTING THE PATTERN TO THE (direction) (as appropriate)” FREDERICK.*

## 9.3 IFR Approaches/Ground Vehicle Operations

**9.3.1 IFR Approaches.** When operating in accordance with an IFR clearance and ATC approves a change to the advisory frequency, make an expeditious change to the CTAF and employ the recommended traffic advisory procedures.

**9.3.2 Ground Vehicle Operation.** Airport ground vehicles equipped with radios should monitor the CTAF frequency when operating on the airport movement area and remain clear of runways/taxiways being used by aircraft. Radio transmissions from ground vehicles should be confined to safety–related matters.

**9.3.3 Radio Control of Airport Lighting Systems.** Whenever possible, the CTAF will be used to control airport lighting systems at airports without operating control towers. This eliminates the need for pilots to change frequencies to turn the lights on and allows a continuous listening watch on a single frequency. The CTAF is published on the instrument approach chart and in other appropriate aeronautical information publications.



TBL GEN 3.3–20

Summary of Recommended Communication Procedures

			COMMUNICATION/BROADCAST PROCEDURES		
	Facility at Airport	Frequency Use	Outbound	Inbound	Practice Instrument Approach
1.	UNICOM (No Tower or FSS)	Communicate with UNICOM station on published CTAF frequency (122.7; 122.8; 122.725; 122.975; or 123.0). If unable to contact UNICOM station, use self-announce procedures on CTAF.	Before taxiing and before taxiing onto the runway for departure.	10 miles out; entering downwind, base, and final; leaving the runway.	
2.	No Tower, FSS, or UNICOM	Self-announce on MULTICOM frequency 122.9.	Before taxiing and before taxiing onto the runway for departure.	10 miles out; entering downwind, base, and final; leaving the runway.	Departing final approach fix (name) or on final approach segment inbound.
3.	No Tower in operation, FSS open (Alaska only)	Communicate with FSS on CTAF frequency.	Before taxiing and before taxiing onto the runway for departure.	10 miles out; entering downwind, base, and final; leaving the runway.	Approach completed/terminated.
4.	FSS closed (No Tower)	Self-announce on CTAF.	Before taxiing and before taxiing onto the runway for departure.	10 miles out; entering downwind, base, and final; leaving the runway.	
5.	Tower or FSS not in operation	Self-announce on CTAF.	Before taxiing and before taxiing onto the runway for departure.	10 miles out; entering downwind, base, and final; leaving the runway.	
6.	Designated CTAF Area (Alaska Only)	Self-announce on CTAF designated on chart or Chart Supplement Alaska.	Before taxiing and before taxiing on the runway for departure until leaving designated area.	When entering designated CTAF area.	

9.4 Designated UNICOM/MULTICOM Frequencies

9.4.1 Frequency Use

9.4.1.1 TBL GEN 3.3–21 depicts UNICOM and MULTICOM frequency uses as designated by the Federal Communications Commission (FCC).

**NOTE–**

1. In some areas of the country, frequency interference may be encountered from nearby airports using the same UNICOM frequency. Where there is a problem, UNICOM operators are encouraged to develop a “least interference” frequency assignment plan for airports concerned using the frequencies designated for airports without operating control towers. UNICOM licensees are encouraged to apply for UNICOM 25 KHz spaced channel frequencies. Due to the extremely limited number of frequencies with 50 KHz channel spacing, 25 KHz channel spacing should be implemented. UNICOM licensees may then request FCC to assign frequencies in accordance with the plan, which FCC will review and consider for approval.

2. Wind direction and runway information may not be available on UNICOM frequency 122.950.

**9.4.1.2** TBL GEN 3.3–22 depicts other frequency uses as designated by the FCC.

**9.5 Use of UNICOM for ATC purposes**

**9.5.1** UNICOM service may be used for air traffic control purposes, only under the following circumstances:

**9.5.1.1** Revision to proposed departure time.

**9.5.1.2** Takeoff, arrival, or flight plan cancellation time.

**9.5.1.3** ATC clearance, provided arrangements are made between the ATC facility and the UNICOM licensee to handle such messages.

*TBL GEN 3.3–21*  
**UNICOM/MULTICOM Frequency Usage**

<b>Use</b>	<b>Frequency</b>
Airports without an operating control tower.	122.700 122.725 122.800 122.975 123.000 123.050 123.075
(MULTICOM FREQUENCY) Activities of a temporary, seasonal, emergency nature or search and rescue, as well as, airports with no tower, FSS, or UNICOM.	122.900
(MULTICOM FREQUENCY) Forestry management and fire suppression, fish and game management and protection, and environmental monitoring and protection.	122.925
Airports with a control tower or FSS on airport.	122.950

*TBL GEN 3.3–22*  
**Other Frequency Usage Designated by FCC**

Use	Frequency
Air-to-air communication (private fixed wing aircraft).	122.750
Helicopter air-to-air communications; Air traffic control operations.	123.025
Aviation instruction, Glider, Hot Air Balloon <b>(not to be used for advisory service).</b>	123.300 123.500
Assignment to flight test land and aircraft stations (not for air-to-air communication except for those aircraft operating in an oceanic FIR).	123.400 <sup>1</sup> 123.450 <sup>2</sup>

<sup>1</sup>This frequency is available only to itinerant stations that have a requirement to be periodically transferred to various locations.

<sup>2</sup>Mobile station operations on these frequencies are limited to an area within 320 km (200 mi) of an associated flight test land station.

**9.6 Automatic Terminal Information Service (ATIS)**

**9.6.1** ATIS is the continuous broadcast of recorded noncontrol information in selected high activity terminal areas. Its purpose is to improve controller effectiveness and to relieve frequency congestion by automating the repetitive transmission of essential but routine information. The information is continuously broadcast over a discrete VHF radio frequency or the voice portion of a local NAVAID. ATIS transmissions on a discrete VHF radio frequency are engineered to be receivable to a maximum of 60 NM from the ATIS site and a maximum altitude of 25,000 feet AGL. At most locations, ATIS signals may be received on the surface of the airport, but local conditions may limit the maximum ATIS reception distance and/or altitude. Pilots are urged to cooperate in the ATIS program as it relieves frequency congestion on approach control, ground control, and local control frequencies. The Chart Supplement U.S. indicates airports for which ATIS is provided.

**9.6.2** ATIS information includes:

**9.6.2.1** Airport/facility name

**9.6.2.2** Phonetic letter code

**9.6.2.3** Time of the latest weather sequence (UTC)

**9.6.2.4** Weather information consisting of:

a) Wind direction and velocity

b) Visibility

c) Obstructions to vision

d) Present weather consisting of: sky condition, temperature, dew point, altimeter, a density altitude advisory when appropriate, and other pertinent remarks included in the official weather observation

**9.6.2.5** Instrument approach and runway in use.

The ceiling/sky condition, visibility, and obstructions to vision may be omitted from the ATIS broadcast if the ceiling is above 5,000 feet and the visibility is more than 5 miles. The departure runway will only be given if

different from the landing runway except at locations having a separate ATIS for departure. The broadcast may include the appropriate frequency and instructions for VFR arrivals to make initial contact with approach control. Pilots of aircraft arriving or departing the terminal area can receive the continuous ATIS broadcast at times when cockpit duties are least pressing and listen to as many repeats as desired. ATIS broadcast must be updated upon the receipt of any official hourly and special weather. A new recording will also be made when there is a change in other pertinent data such as runway change, instrument approach in use, etc.

**SAMPLE BROADCAST–**

*DULLES INTERNATIONAL INFORMATION SIERRA. ONE FOUR ZERO ZERO ZULU. WIND THREE FIVE ZERO AT EIGHT. VISIBILITY ONE ZERO. CEILING FOUR THOUSAND FIVE HUNDRED BROKEN. TEMPERATURE THREE FOUR. DEW POINT TWO EIGHT. ALTIMETER THREE ZERO ONE ZERO. ILS RUNWAY ONE RIGHT APPROACH IN USE. DEPARTING RUNWAY THREE ZERO. ADVISE ON INITIAL CONTACT YOU HAVE INFORMATION SIERRA.*

**9.6.3** Pilots should listen to ATIS broadcasts whenever ATIS is in operation.

**9.6.4** Pilots should notify controllers on initial contact that they have received the ATIS broadcast by repeating the alphabetical code word appended to the broadcast.

**EXAMPLE–**

*“Information Sierra received.”*

**9.6.5** When the pilot acknowledges receipt of the ATIS broadcast, controllers may omit those items contained on the broadcast if they are current. Rapidly changing conditions will be issued by ATC and the ATIS will contain words as follows:

**EXAMPLE–**

*“Latest ceiling/visibility/altimeter/wind/(other conditions) will be issued by approach control/tower.”*

**NOTE–**

*The absence of a sky condition/ceiling and/or visibility on ATIS indicates a sky condition/ceiling of 5,000 feet or above and visibility of 5 miles or more. A remark may be made on the broadcast, “the weather is better than 5,000 and 5,” or the existing weather may be broadcast.*

**9.6.6** Controllers will issue pertinent information to pilots who do not acknowledge receipt of a broadcast or who acknowledge receipt of a broadcast which is not current.

**9.6.7** To serve frequency–limited aircraft, FSSs are equipped to transmit on the omnirange frequency at most en route VORs used as ATIS voice outlets. Such communication interrupts the ATIS broadcast. Pilots of aircraft equipped to receive on other FSS frequencies are encouraged to do so in order that these override transmissions may be kept to an absolute minimum.

**9.6.8** While it is a good operating practice for pilots to make use of the ATIS broadcast where it is available, some pilots use the phrase “Have Numbers” in communications with the control tower. Use of this phrase means that the pilot has received wind, runway and altimeter information ONLY and the tower does not have to repeat this information. It does not indicate receipt of the ATIS broadcast and should never be used for this purpose.

## **9.7 Airport Reservation Operations and Special Traffic Management Programs**

**9.7.1** This section describes procedures for obtaining required airport reservations at airports designated by the FAA and for airports operating under Special Traffic Management Programs.

### **9.7.2 Slot Controlled Airports.**

**9.7.2.1** The FAA may adopt rules to require advance reservations for unscheduled operations at certain airports. In addition to the information in the rules adopted by the FAA, a listing of the airports and relevant information will be maintained on the FAA website [www.fly.faa.gov/ecvrs](http://www.fly.faa.gov/ecvrs).

**9.7.2.2** The FAA has established an Airport Reservation Office (ARO) to receive and process reservations for unscheduled flights at the slot controlled airports. The ARO uses the Enhanced Computer Voice Reservation System (e-CVRS) to allocate reservations. Reservations will be available beginning 72 hours in advance of the operation at the slot controlled airport. Standby lists are not maintained. Flights with declared emergencies do

not require reservations. Refer to the website for the current listing of slot controlled airports, limitations, and reservation procedures.

**9.7.2.3** For more detailed information on operations and reservation procedures at a slot controlled airport, please see 14 CFR Part 93, Subpart K – High Density Traffic Airports.

### **9.7.3 Special Traffic Management Programs (STMP)**

**9.7.3.1** Special programs may be established when a location requires special traffic handling to accommodate above normal traffic demand (for example, EAA AirVenture Oshkosh, SUN 'n FUN Aerospace Expo) or reduced airport capacity (for example, airport runway/taxiway closures for airport construction). The special programs may remain in effect until the problem has been resolved or until local traffic management procedures can handle the volume and a need for special handling no longer exists.

**9.7.3.2** If an STMP is used to accommodate a special event, a domestic notice will be issued relaying the website address: [www.fly.faa.gov/estmp](http://www.fly.faa.gov/estmp). Domestic notice information includes: what airports are included in the STMP, the dates and times reservations are required, the time limits for reservation requests, the point of contact for reservations, and any other instructions.

**9.7.4 Making Reservations.** Detailed information and User Instruction Guides for using the Web interface to the reservation systems are available on the websites for the slot controlled airports (e-CVRS), [www.fly.faa.gov/ecvrs](http://www.fly.faa.gov/ecvrs); and STMPs (e-STMP), [www.fly.faa.gov/estmp](http://www.fly.faa.gov/estmp).

**NOTE–**

*Users may contact the ARO at (540) 422–4246 if they have a problem with their reservation.*

### **9.8 Operations at Uncontrolled Airports with Automated Surface Observing System (ASOS)/Automated Weather Observation System (AWOS)**

**9.8.1** Many airports throughout the National Airspace System are equipped with either ASOS or AWOS. At most airports with an operating control tower or human observer, the weather will be available to you in a METAR hourly or special observation format on the Automatic Terminal Information Service (ATIS) or directly transmitted from the controller/observer.

**9.8.2** At uncontrolled airports that are equipped with ASOS/AWOS with ground–to–air broadcast capability, the one–minute updated airport weather should be available to you within approximately 25 NM of the airport below 10,000 feet. The frequency for the weather broadcast will be published on sectional charts and in the Chart Supplement U.S. Some part–time towered airports may also broadcast the automated weather on their ATIS frequency during the hours that the tower is closed.

**9.8.3** Controllers issue SVFR or IFR clearances based on pilot request, known traffic and reported weather; i.e., METAR/SPECI observations, when they are available. Pilots have access to more current weather at uncontrolled ASOS/AWOS airports than do the controllers who may be located several miles away. Controllers will rely on the pilot to determine the current airport weather from the ASOS/AWOS. All aircraft arriving or departing an ASOS/AWOS equipped uncontrolled airport should monitor the airport weather frequency to ascertain the status of the airspace. Pilots in Class E airspace must be alert for changing weather conditions which may affect the status of the airspace from IFR/VFR. If ATC service is required for IFR/SVFR approach/departure or requested for VFR service, the pilot should advise the controller that he/she has received the one–minute weather and state his/her intentions.

**EXAMPLE–**

*“I have the (airport) one–minute weather; request an ILS runway 14 approach.”*

**REFERENCE–**

*Section GEN 3.5, Paragraph 7, Weather Observing Programs.*



## GEN 3.4 Communication Service

### 1. Responsible Authority

**1.1** The authority responsible for the administration of communications services in the U.S. is the Federal Aviation Administration, Communications, Information and Network Programs Group, AJM-31.

*Postal Address:*

Federal Aviation Administration  
Communications, Information and Network  
Programs Group, AJM-31  
800 Independence Ave, SW  
Washington, D.C. 20591

*AFTN Address:* KRWAYAYX

*Commercial Telegraphic Address:*

FAA WASH

### 2. Area of Responsibility

**2.1** Communications services are available on a continuous basis without charge to the user. The Air Traffic Services Division is responsible for the establishment of the operational requirements of the U.S. communications system. Responsibility for the day to day operation of these services resides with the local air traffic facility. Enquiries or complaints regarding any communications services or facilities should be referred to the relevant air traffic facility or to the Federal Aviation Administration, Air Traffic Operations Services, as appropriate.

### 3. Types of Services

#### 3.1 Radio Navigation Service

**3.1.1** Various types of air navigation aids are in use today, each serving a special purpose. These aids have varied owners and operators, namely: the Federal Aviation Administration, the military services, private organizations; and individual states and foreign governments. The Federal Aviation Administration has the statutory authority to establish, operate, and maintain air navigation facilities and to prescribe standards for the operation of any of these aids which are used by both civil and military aircraft for instrument flight in federally controlled airspace. These aids are tabulated in the Chart Supplement U.S. by State.

**3.1.2** Pilots should be aware of the possibility of momentary erroneous indications on cockpit displays when the primary signal generator for a ground-based navigational transmitter (for example, a glideslope, VOR, or nondirectional beacon) is inoperative. Pilots should disregard any navigation indication, regardless of its apparent validity, if the particular transmitter was identified by NOTAM or otherwise as unusable or inoperative.

**3.1.3** The following types of radio navigation aids are provided in the U.S.:

**3.1.3.1** VHF Direction-Finding (VHF-DF).

**3.1.3.2** LF Non-Directional Beacon (NDB).

**3.1.3.3** VHF Omni-Directional Radio Range (VOR).

**3.1.3.4** Distance Measuring Equipment (DME).

**3.1.3.5** Tactical Air Navigation (TACAN).

**3.1.3.6** Instrument Landing System (ILS).

**3.1.3.7** Final Approach Simplified Directional Facility (SDF).

**3.1.3.8** Precision Approach Radar (PAR) at certain military aerodromes.

**3.1.3.9** Global Positioning System (GPS).

### **3.1.4 NAVAID Service Volumes**

**3.1.4.1** The FAA publishes Standard Service Volumes (SSVs) for most NAVAIDs. The SSV is a three-dimensional volume within which the FAA ensures that a signal can be received with adequate signal strength and course quality, and is free from interference from other NAVAIDs on similar frequencies (e.g., co-channel or adjacent-channel interference). However, the SSV signal protection does not include potential blockage from terrain or obstructions. The SSV is principally intended for off-route navigation, such as proceeding direct to or from a VOR when not on a published instrument procedure or route. Navigation on published instrument procedures (e.g., approaches or departures) or routes (e.g., Victor routes) may use NAVAIDs outside of the SSV, when Extended Service Volume (ESV) is approved, since adequate signal strength, course quality, and freedom from interference are verified by the FAA prior to the publishing of the instrument procedure or route.

**NOTE-**

*A conical area directly above the NAVAID is generally not usable for navigation.*

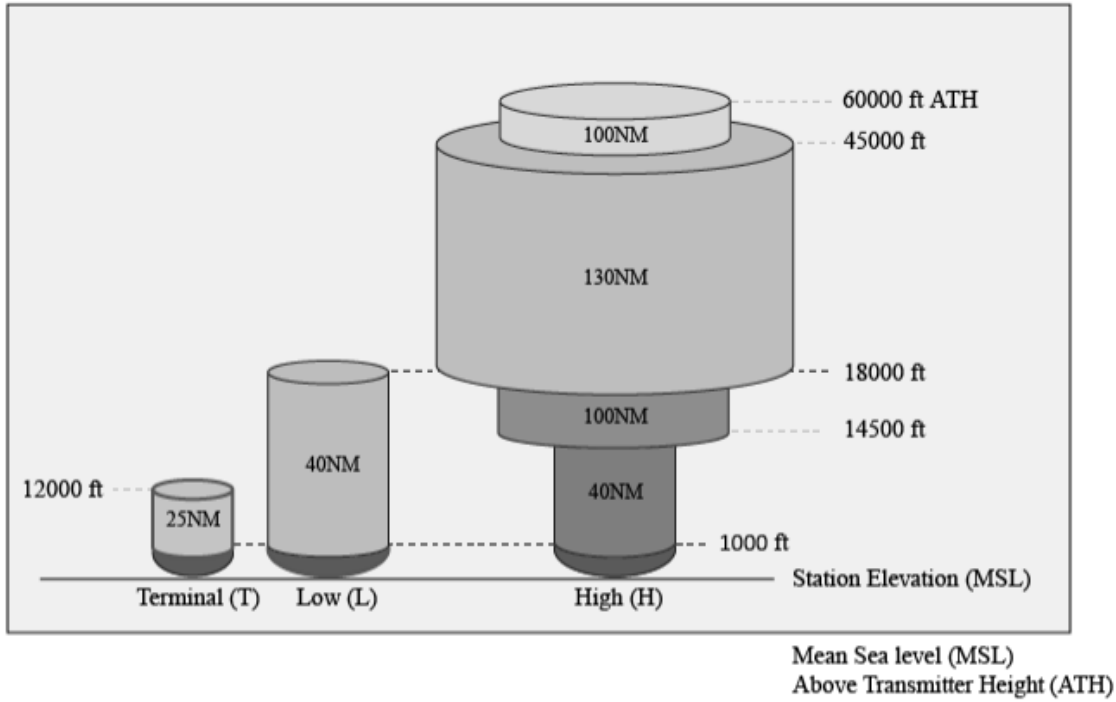
**3.1.4.2** A NAVAID will have service volume restrictions if it does not conform to signal strength and course quality standards throughout the published SSV. Service volume restrictions are first published in Notices to Air Missions (NOTAMs) and then with the alphabetical listing of the NAVAIDs in the Chart Supplement. Service volume restrictions do not generally apply to published instrument procedures or routes unless published in NOTAMs for the affected instrument procedure or route.

**3.1.4.3** VOR/DME/TACAN Standard Service Volumes (SSV).

a) The three original SSVs are shown in FIG GEN 3.4-1 and are designated with three classes of NAVAIDs: Terminal (T), Low (L), and High (H). The usable distance of the NAVAID depends on the altitude Above the Transmitter Height (ATH) for each class. The lower edge of the usable distance when below 1,000 feet ATH is shown in FIG GEN 3.4-2 for Terminal NAVAIDs and in FIG GEN 3.4-3 for Low and High NAVAIDs.



**FIG GEN 3.4-1**  
**Original Standard Service Volumes**



**FIG GEN 3.4-2**  
**Lower Edge of the Terminal Service Volume (in altitude ATH)**

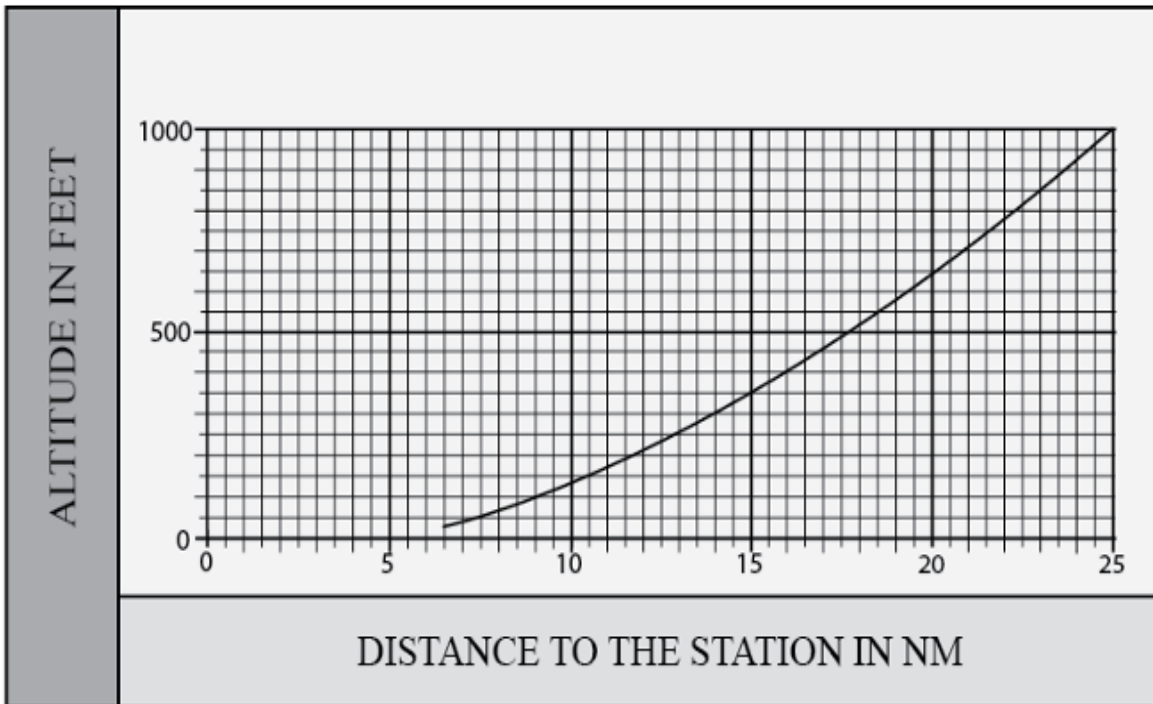
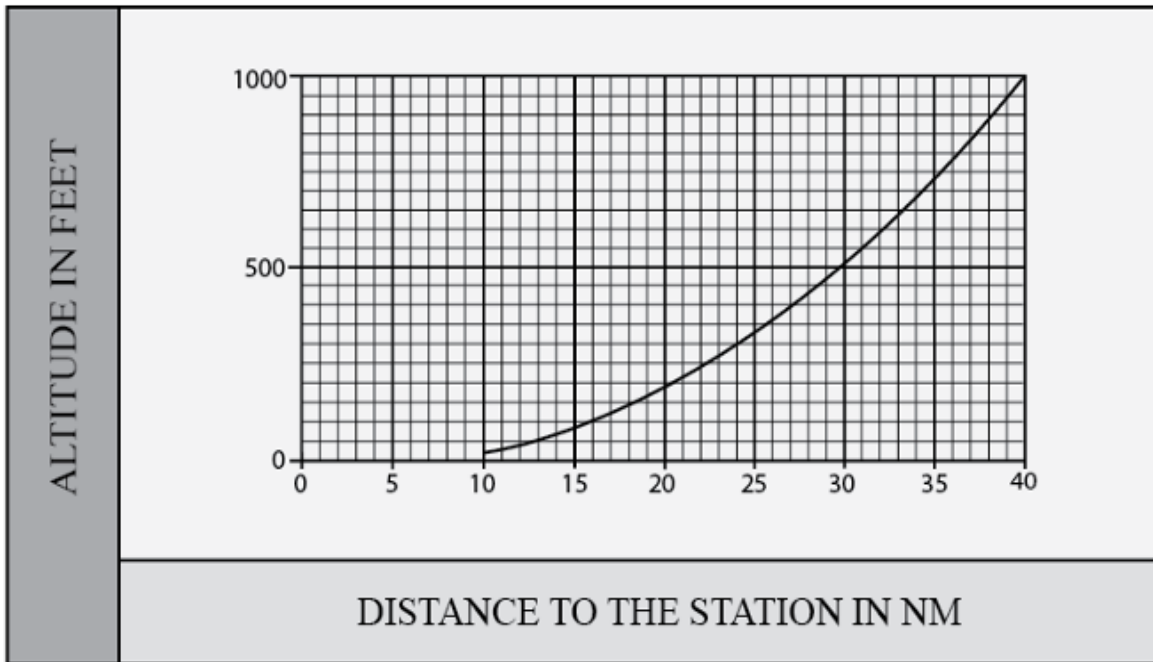


FIG GEN 3.4-3  
Lower Edge of Low and High Service Volumes (in altitude ATH)



b) With the progression of navigation capabilities to Performance Based Navigation (PBN), additional capabilities for off-route navigation are necessary. For example, the VOR MON (See ENR 4.1, paragraph 2.6) requires the use of VORs at 5,000 feet AGL, which is beyond the original SSV ranges. Additionally, PBN procedures using DME require extended ranges. As a result, the FAA created four additional SSVs. Two of the new SSVs are associated with VORs: VOR Low (VL) and VOR High (VH), as shown in FIG GEN 3.4-4. The other two new SSVs are associated with DME: DME Low (DL) and DME High (DH), as shown in FIG GEN 3.4-5. The SSV at altitudes below 1,000 feet for the VL and VH are the same as FIG GEN 3.4-3. The SSVs at altitudes below 12,900 feet for the DL and DH SSVs correspond to a conservative estimate of the DME radio line of sight (RLOS) coverage at each altitude (not including possible terrain blockage).

FIG GEN 3.4-4  
New VOR Service Volumes

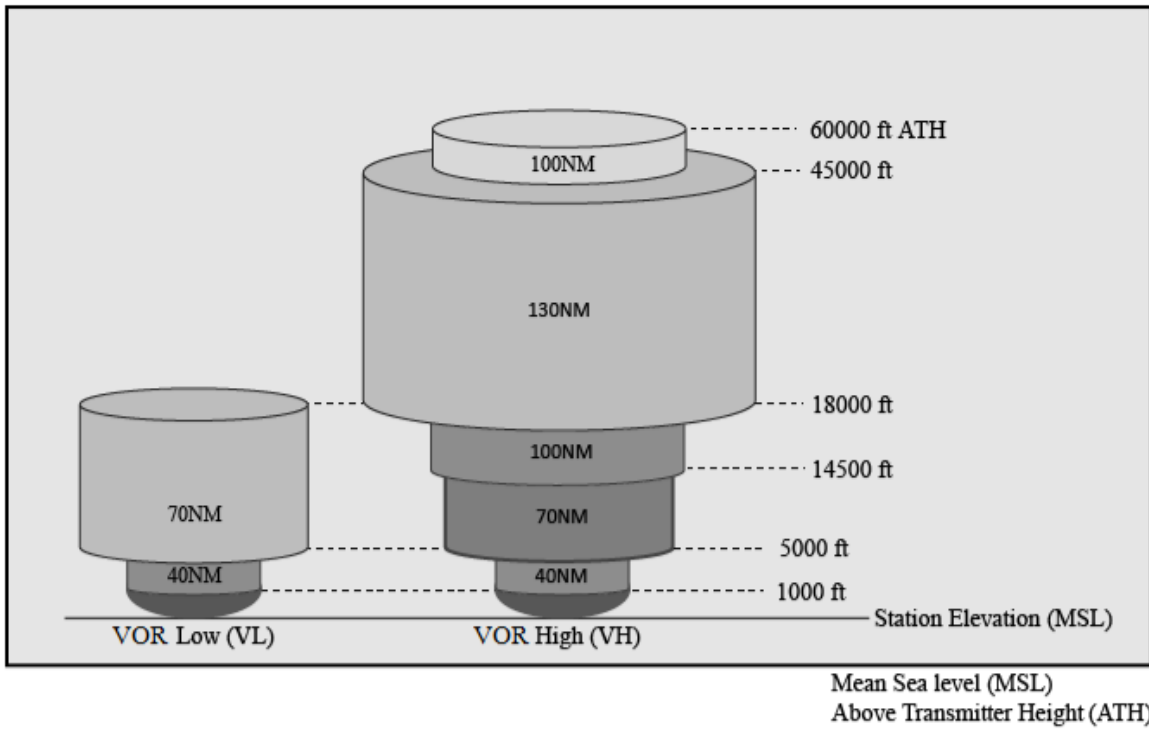
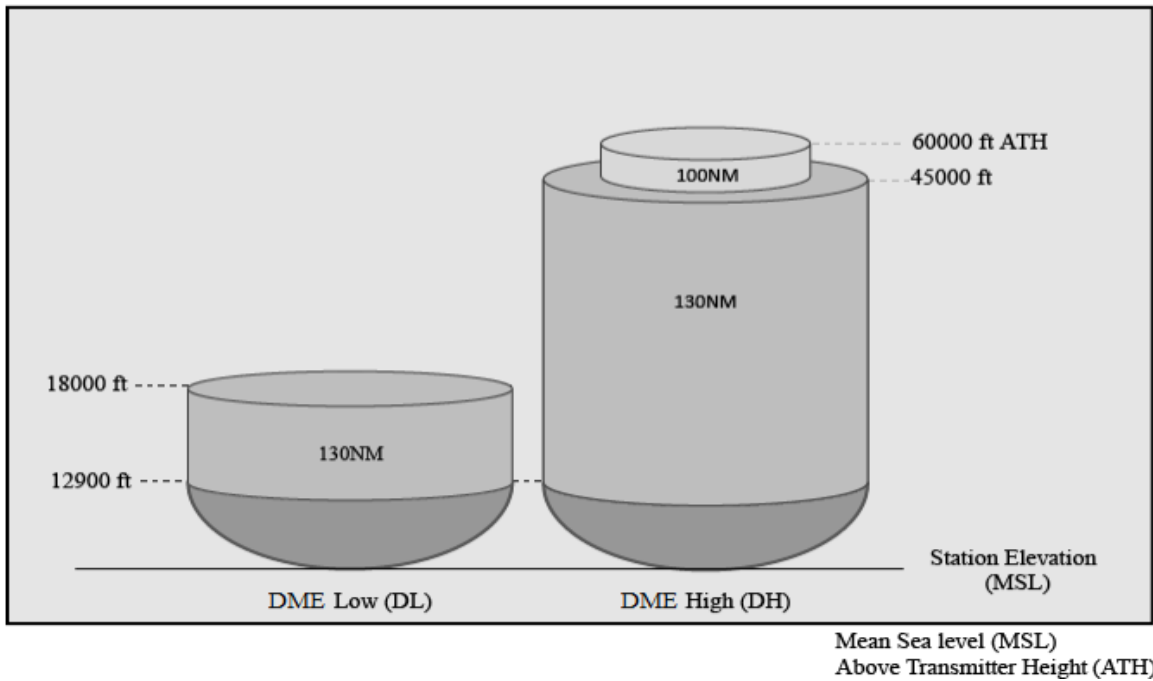


FIG GEN 3.4-5  
New DME Service Volumes



**NOTE-**

1. In the past, NAVAIDs at one location typically all had the same SSV. For example, a VORTAC typically had a High (H) SSV for the VOR, the TACAN azimuth, and the TACAN DME, or a Low (L) or Terminal (T) SSV for all three. A VOR/DME

typically had a High (H), Low (L), or Terminal (T) for both the VOR and the DME. A common SSV may no longer be the case at all locations. A VOR/DME, for example, could have an SSV of VL for the VOR and DH for the DME, or other combinations.

2. The TACAN azimuth will only be classified as T, L, or H.

c) TBL GEN 3.4-1 is a tabular summary of the VOR, DME, and TACAN NAVAID SSVs, not including altitudes below 1,000 feet ATH for VOR and TACAN Azimuth, and not including ranges for altitudes below 12,900 feet for TACAN and DME.

**TBL GEN 3.4-1  
VOR/DME/TACAN Standard Service Volumes**

<b>SSV Designator</b>	<b>Altitude and Range Boundaries</b>
T (Terminal)	From 1,000 feet ATH up to and including 12,000 feet ATH at radial distances out to 25 NM.
L (Low Altitude)	From 1,000 feet ATH up to and including 18,000 feet ATH at radial distances out to 40 NM.
H (High Altitude)	From 1,000 feet ATH up to and including 14,500 feet ATH at radial distances out to 40 NM. From 14,500 ATH up to and including 60,000 feet at radial distances out to 100 NM. From 18,000 feet ATH up to and including 45,000 feet ATH at radial distances out to 130 NM.
VL (VOR Low)	From 1,000 feet ATH up to but not including 5,000 feet ATH at radial distances out to 40 NM. From 5,000 feet ATH up to but not including 18,000 feet ATH at radial distances out to 70 NM.
VH (VOR High)	From 1,000 feet ATH up to but not including 5,000 feet ATH at radial distances out to 40 NM. From 5,000 feet ATH up to but not including 14,500 feet ATH at radial distances out to 70 NM. From 14,500 ATH up to and including 60,000 feet at radial distances out to 100 NM. From 18,000 feet ATH up to and including 45,000 feet ATH at radial distances out to 130 NM.
DL (DME Low)	For altitudes up to 12,900 feet ATH at a radial distance corresponding to the LOS to the NAVAID. From 12,900 feet ATH up to but not including 18,000 feet ATH at radial distances out to 130 NM
DH (DME High)	For altitudes up to 12,900 feet ATH at a radial distance corresponding to the LOS to the NAVAID. From 12,900 ATH up to and including 60,000 feet at radial distances out to 100 NM. From 12,900 feet ATH up to and including 45,000 feet ATH at radial distances out to 130 NM.

**3.1.4.4** Nondirectional Radio Beacon (NDB) SSVs. NDBs are classified according to their intended use. The ranges of NDB service volumes are shown in TBL GEN 3.4-2. The distance (radius) is the same at all altitudes for each class.

**TBL GEN 3.4-2  
NDB Service Volumes**

<b>Class</b>	<b>Distance (Radius) (NM)</b>
Compass Locator	15
MH	25
H	50*
HH	75
*Service ranges of individual facilities may be less than 50 nautical miles (NM). Restrictions to service volumes are first published as a Notice to Air Missions and then with the alphabetical listing of the NAVAID in the Chart Supplement U.S.	

### **3.1.5 NAVAIDs with Voice**

**3.1.5.1** Voice equipped en route radio navigational aids are under the operational control of either a Flight Service Station (FSS) or an approach control facility. Facilities with two-way voice communication available are indicated in the Chart Supplement U.S. and aeronautical charts.

**3.1.5.2** Unless otherwise noted on the chart, all radio navigation aids operate continuously except during shutdowns for maintenance. Hours of operation of facilities not operating continuously are annotated on charts and in the Chart Supplement U.S.

### **3.2 Mobile Service**

**3.2.1** The aeronautical stations (Airport Traffic Control Towers, Air Route Traffic Control Centers, and Flight Service Stations) maintain a continuous watch on their assigned frequencies during the published hours of service unless otherwise notified. An aircraft should normally communicate with the air-ground control radio station which exercises control in the area in which it is flying. Aircraft should maintain continuous watch on the appropriate frequency of the control station and should not abandon watch, except in an emergency, without informing the control radio station.

**3.2.2** Flight Service Stations (FSSs) are allocated frequencies for different functions. For Airport Advisory Service, the pilot should contact the FSS on 123.6 MHz. Individually assigned FSS frequencies are listed in the Chart Supplement U.S. under the FSS entry. If you are in doubt as to what frequency to use to contact an FSS, transmit on 122.1 MHz and advise the FSS of the frequency on which you are receiving.

### **3.3 Fixed Service**

**3.3.1** Messages to be transmitted over the Aeronautical Fixed Service are accepted only if they satisfy the requirements of:

**3.3.1.1** ICAO Annex 10, Vol. II, Chapter 3, paragraph 3.3.

**3.3.1.2** Are prepared in the form specified in Annex 10.

**3.3.1.3** The text of an individual message does not exceed 200 groups.

**3.3.2** General aircraft operating messages, Class B traffic, including reservation messages pertaining to flights scheduled to depart within 72 hours, must not be acceptable for transmission over U.S. government operated telecommunications circuits except in those cases where it has been determined by the U.S. that adequate non-government facilities are not available.

### **3.4 Broadcast Service**

**3.4.1** The following meteorological broadcasts are available for the use of aircraft in flight:

**3.4.1.1** Sub-Area Meteorological Broadcast (Volmet).

**3.4.1.2** VHF RTF Meteorological Broadcasts.

**3.4.2** Full details of broadcast service are given in GEN 3.5, Meteorological Services.

**3.4.3** All broadcast services to aircraft are provided in the English language only.

## **4. Aeronautical Fixed Services**

### **4.1 General**

**4.1.1** All U.S. ATC facilities have the ability to communicate with all other ATS facilities via either telephone or other domestic telecommunications systems. Circuit diagrams depicting these connections are not available for this publication due to the number of ATS facilities available in the U.S.

### **4.2 The Domestic Telecommunications Network**

**4.2.1** The U.S. Domestic telecommunications network is an automated system operating through the National Airspace Data Interchange Network (NADIN) in Atlanta, GA, and Salt Lake City, UT. All Flight Service Stations

(FSS) and Air Route Traffic Control Centers (ARTCC) connect through the NATCOM. All FSS and ARTCC facilities have both transmit and receive capabilities.

**4.2.2** Airport Air Traffic Control Towers (ATCT) and Approach Control (A/C) Facilities do not connect with this system. Messages originating from or destined to these facilities are relayed through the associated FSS. Associated FSSs for these facilities are listed in the Chart Supplement U.S.

**4.2.3** Airport administrative offices, airport managers or airport administrative officials do not normally connect with the domestic telecommunications network. Urgent messages destined to these facilities must be forwarded to the associated FSS for relay or the message must be sent through commercial telegraphic systems.

### **4.3 The International Message Network (Aeronautical Fixed Telecommunications Network–AFTN)**

**4.3.1** AFTN messages originating from outside the U.S. domestic telecommunications system must be prepared in accordance with ICAO procedures. All incoming messages are received by NADIN and relayed to the addressed facility through automated procedures. The automated system will interpret the international address group and automatically forward the message via the domestic system to the addressee. For example, a message addressed KIKKYFYX will be accepted by AFTN and relayed to IKK (Kankakee FSS). The Kankakee FSS will manually relay this message to the intended recipient when necessary. Intended recipients are to be addressed in the first line of the message text.

**4.3.2** All international flight plans entering the U.S. system must adhere to ICAO format. These flight plans are to be forwarded, via AFTN, to each affected, U.S. controlled, Flight Information Region (FIR) or Air Route Traffic Control Center (ARTCC) outside the continental U.S. (e.g., Miami FIR, San Juan, P.R. ARTCC) or the first FIR/ARTCC for flights entering the continental U.S. (e.g., New York FIR/ARTCC). If the flight plan content is acceptable, it is entered into the ARTCC system and is forwarded, automatically, via ARTCC computer, to all subsequently affected domestic ARTCCs. Flight plans which cannot be processed are rejected at the point of entry into the U.S. system and the originator is queried. Format adherence, once the flight plan is in the ARTCC system, is assured since each of the ARTCCs are automated facilities. Each subsequent ARTCC computer, however, will process incoming flight plans according to the requested routing. Flight plans can be rejected by any ARTCC due to errors in routing. Rejected flight plans, regardless of reason or point of rejection, are held in suspense until the needed clarification is received by the ARTCC facility.

### **4.4 Radio Communications Phraseology and Techniques**

#### **4.4.1 General**

**4.4.1.1** Radio communications are a critical link in the ATC system. The link can be a strong bond between pilot and controller – or it can be broken with surprising speed and disastrous results. Discussion herein provides basic procedures for new pilots and also highlights safe operating concepts for all pilots.

**4.4.1.2** The single, most important thought in pilot–controller communications is understanding. It is essential, therefore, that pilots acknowledge each radio communication with ATC by using the appropriate aircraft call sign. Brevity is important, and contacts should be kept as brief as possible, but the controller must know what you want to do before he/she can properly carry out his/her control duties. And you, the pilot, must know exactly what he/she wants you to do. Since concise phraseology may not always be adequate, use whatever words are necessary to get your message across. Pilots are to maintain vigilance in monitoring air traffic control radio communications frequencies for potential traffic conflicts with their aircraft especially when operating on an active runway and/or when conducting a final approach to landing.

**4.4.1.3** All pilots will find the Pilot/Controller Glossary very helpful in learning what certain words or phrases mean. Good phraseology enhances safety and is the mark of a professional pilot. Jargon, chatter and “CB” slang have no place in ATC communications. The Pilot/Controller Glossary is the same glossary used in the ATC controller’s handbook. We recommend that it be studied and reviewed from time to time to sharpen your communication skills.

#### **4.4.2 Radio Technique**

**4.4.2.1** Listen before you transmit. Many times you can get the information you want through ATIS or by monitoring the frequency. Except for a few situations where some frequency overlap occurs, if you hear someone else talking, the keying of your transmitter will be futile and you will probably jam their receivers causing them to repeat their call. If you have just changed frequency, pause for your receiver to tune, listen, and make sure the frequency is clear.

**4.4.2.2** Think before keying your transmitter. Know what you want to say and if it is lengthy; e.g., a flight plan or IFR position report, jot it down. (But do not lock your head in the cockpit.)

**4.4.2.3** The microphone should be very close to your lips and after pressing the mike button, a slight pause may be necessary to be sure the first word is transmitted. Speak in a normal conversational tone.

**4.4.2.4** When you release the button, wait a few seconds before calling again. The controller or FSS specialist may be jotting down your number, looking for your flight plan, transmitting on a different frequency, or selecting his/her transmitter to your frequency.

**4.4.2.5** Be alert to the sounds or lack of sounds in your receiver. Check your volume, recheck your frequency, and make sure that your microphone is not stuck in the transmit position. Frequency blockage can, and has, occurred for extended periods of time due to unintentional transmitter operation. This type of interference is commonly referred to as a “stuck mike,” and controllers may refer to it in this manner when attempting to assign an alternate frequency. If the assigned frequency is completely blocked by this type of interference, use the procedures described in paragraph 12., Two–Way Radio Communications Failure.

**4.4.2.6** Be sure that you are within the performance range of your radio equipment and the ground station equipment. Remote radio sites do not always transmit and receive on all of a facilities’ available frequencies, particularly with regard to VOR sites where you can hear but not reach a ground station’s receiver. Remember that higher altitude increases the range of VHF “line of sight” communications.

### **4.4.3 Aircraft Call Signs**

**4.4.3.1** Improper use of call signs can result in pilots executing a clearance intended for another aircraft. Call signs should never be abbreviated on an initial contact or at any time when other aircraft call signs have similar numbers/sounds or identical letters/numbers, (e.g., Cessna 6132F, Cessna 1622F, Baron 123F, Cherokee 7732F, etc.).

**EXAMPLE–**

*As an example, assume that a controller issues an approach clearance to an aircraft at the bottom of a holding stack and an aircraft with a similar call sign (at the top of the stack) acknowledges the clearance with the last two or three numbers of his/her call sign. If the aircraft at the bottom of the stack did not hear the clearance and intervene, flight safety would be affected, and there would be no reason for either the controller or pilot to suspect that anything is wrong. This kind of “human factors” error can strike swiftly and is extremely difficult to rectify.*

**4.4.3.2** Pilots, therefore, must be certain that aircraft identification is complete and clearly identified before taking action on an ATC clearance. ATC specialists will not abbreviate call signs of air carrier or other civil aircraft having authorized call signs. ATC specialists may initiate abbreviated call signs of other aircraft by using the prefix and the last three digits/letters of the aircraft identification after communications are established. The pilot may use the abbreviated call sign in subsequent contacts with the ATC specialist. When aware of similar/identical call signs, ATC specialists will take action to minimize errors by emphasizing certain numbers/letters, by repeating the entire call sign, repeating the prefix, or by asking pilots to use a different call sign temporarily. Pilots should use the phrase “Verify clearance for (your complete call sign)” if doubt exists concerning proper identity.

**4.4.3.3** Civil aircraft pilots should state the aircraft type, model or manufacturer’s name followed by the digits/letters of the registration number. When the aircraft manufacturer’s name or model is stated, the prefix “N” is dropped.

**EXAMPLE–**

*“Bonanza Six Five Five Golf,” “Douglas One One Zero,” “Breezy Six One Three Romeo Experimental” (Omit “Experimental” after initial contact).*

**4.4.3.4** Air taxi or other commercial operators not having FAA authorized call signs should prefix their normal identification with the phonetic word “Tango.”

**EXAMPLE–**

*“Tango Aztec Two Four Six Four Alpha.”*

**4.4.3.5** Air carriers and commuter air carriers having FAA authorized call signs should identify themselves by stating the complete call sign (using group form for the numbers) and the word “super” or “heavy” if appropriate.

**EXAMPLE–**

*“United Twenty–five, Midwest Commuter Seven Eleven.”*

**4.4.3.6** Military aircraft use a variety of systems including serial numbers, word call signs and combinations of letters/numbers.

**EXAMPLE–**

*“Army Copter 48931” “Air Force 61782” “REACH 31792” “Pat 157” “AirEvac 17652” “Navy Golf Alpha Kilo 21” “Marine 4 Charlie 36”*

**4.4.3.7** Air Ambulance Flights. Because of the priority afforded air ambulance flights in the ATC system, extreme discretion is necessary when using the term “MEDEVAC.” It is only intended for those missions of an urgent medical nature and to be utilized only for that portion of the flight requiring priority handling. It is important for ATC to be aware of a flight’s MEDEVAC status, and it is the pilot’s responsibility to ensure that this information is provided to ATC.

a) To receive priority handling from ATC, the pilot must verbally identify the flight in radio transmissions by stating “MEDEVAC” followed by the FAA authorized call sign (ICAO 3LD, US Special, or local) or the aircraft civil “N” registration numbers/letters.

**EXAMPLE–**

*If the aircraft identification of the flight indicates DAL51, the pilot states “MEDEVAC Delta Fifty One”.*

*If the aircraft identification of the flight indicates MDSTR1, the pilot states “MEDEVAC Medstar One”.*

*If the aircraft identification of the flight indicates N123G or LN123G, the pilot states “MEDEVAC One Two Three Golf”.*

b) If requested by the pilot, ATC will provide additional assistance (e.g., landline notifications) to expedite ground handling of patients, vital organs, or urgently needed medical materials. When possible make these requests to ATC via methods other than through ATC radio frequencies.

c) MEDEVAC flights may include:

1) Civilian air ambulance flights responding to medical emergencies (e.g., first call to an accident scene, carrying patients, organ donors, organs, or other urgently needed lifesaving medical material).

2) Air carrier and air taxi flights responding to medical emergencies. The nature of these medical emergency flights usually concerns the transportation of urgently needed lifesaving medical materials or vital organs, but can include inflight medical emergencies. It is imperative that the company/pilot determine, by the nature/urgency of the specific medical cargo, if priority ATC assistance is required.

d) When filing a flight plan, pilots may include “L” for “MEDEVAC” with the aircraft registration letters/digits and/or include “MEDEVAC” in Item 11 (Remarks) of the flight plan or Item 18 (Other Information) of an international flight plan. However, ATC will only use these flight plan entries for informational purposes or as a visual indicator. ATC will only provide priority handling when the pilot verbally identifies the “MEDEVAC” status of the flight as described above (in subparagraph 4.4.3.7a).

**NOTE–**

*Civilian air ambulance aircraft operating VFR and without a filed flight plan are eligible for priority handling in accordance with subparagraph c.1 above.*

**REFERENCE–**

*AIP, ENR 1.10, Flight Planning (Restriction, Limitation or Advisory Information)*



e) ATC will also provide priority handling requested. These aircraft may file “HOSP” or “AIR EVAC” in either Item 11 (Remarks) of the flight plan or Item 18 of an international flight plan. For aircraft identification in radio transmissions, civilian pilots will use normal call signs when filing ”HOSP” and military pilots will use the ”EVAC” call sign.

**4.4.3.8 Student Pilots Radio Identification.** The FAA desires to help the student pilot in acquiring sufficient practical experience in the environment in which he/she will be required to operate. To receive additional assistance while operating in areas of concentrated air traffic, a student pilot need only identify himself/herself as a student pilot during his/her initial call to an FAA radio facility. For instance, “Dayton Tower, Fleetwing One Two Three Four, Student Pilot.” This special identification will alert FAA air traffic control personnel and enable them to provide the student pilot with such extra assistance and consideration as he/she may need. It is recommended that student pilots identify themselves as such, on initial contact with each clearance delivery prior to taxiing, ground control, tower, approach and departure control frequency, or FSS contact.

#### 4.4.4 Description of Interchange or Leased Aircraft

**4.4.4.1** Controllers issue traffic information based on familiarity with airline equipment and color/markings. When an air carrier dispatches a flight using another company’s equipment and the pilot does not advise the terminal ATC facility, the possible confusion in aircraft identification can compromise safety.

**4.4.4.2** Pilots flying an “interchange” or “leased” aircraft not bearing the colors/markings of the company operating the aircraft should inform the terminal ATC facility on first contact the name of the operating company and trip number, followed by the company name as displayed on the aircraft, and aircraft type.

**EXAMPLE-**

*AIR CAL 311, United (Interchange/Lease), Boeing 727.*

#### 4.4.5 Ground Station Call Signs

**4.4.5.1** Pilots, when calling a ground station, should begin with the name of the facility being called followed by the type of the facility being called, as indicated in the following examples.

*TBL GEN 3.4-3*  
**Calling a Ground Station**

Facility	Call Sign
Airport UNICOM	“Shannon UNICOM”
FAA Flight Service Station	“Chicago Radio”
Airport Traffic Control Tower	“Augusta Tower”
Clearance Delivery Position (IFR)	“Dallas Clearance Delivery”
Ground Control Position in Tower	“Miami Ground”
Radar or Nonradar Approach Control Position	“Oklahoma City Approach”
Radar Departure Control Position	“St. Louis Departure”
FAA Air Route Traffic Control Center	“Washington Center”

### 4.5 Radio Communications Phraseology

#### 4.5.1 Phonetic Alphabet

**4.5.1.1** The International Civil Aviation Organization (ICAO) phonetic alphabet is used by FAA personnel when communications conditions are such that the information cannot be readily received without their use. Air traffic

control facilities may also request pilots to use phonetic letter equivalents when aircraft with similar sounding identifications are receiving communications on the same frequency. Pilots should use the phonetic alphabet when identifying their aircraft during initial contact with air traffic control facilities. Additionally, use the phonetic equivalents for single letters and to spell out groups of letters or difficult words during adverse communications conditions.

TBL GEN 3.4–4

Character	Morse Code	Telephony	Phonic (Pronunciation)
A	—	Alfa	(AL-FAH)
B	—	Bravo	(BRAH-VOH)
C	— —	Charlie	(CHAR-LEE) or (SHAR-LEE)
D	—	Delta	(DELL-TAH)
E		Echo	(ECK-OH)
F	—	Foxtrot	(FOKS-TROT)
G	— —	Golf	(GOLF)
H		Hotel	(HOH-TEL)
I		India	(IN-DEE-AH)
J	— — — —	Juliett	(JEW-LEE-ETT)
K	— —	Kilo	(KEY-LOH)
L	—	Lima	(LEE-MAH)
M	— —	Mike	(MIKE)
N	—	November	(NO-VEM-BER)
O	— — — —	Oscar	(OSS-CAH)
P	— — —	Papa	(PAH-PAH)
Q	— — — —	Quebec	(KEH-BECK)

Character	Morse Code	Telephony	Phonic (Pronunciation)
R	—	Romeo	(ROW-ME-OH)
S		Sierra	(SEE-AIR-RAH)
T	—	Tango	(TANG-GO)
U	—	Uniform	(YOU-NEE-FORM) or (OO-NEE-FORM)
V	— —	Victor	(VIK-TAH)
W	— — —	Whiskey	(WISS-KEY)
X	— — —	Xray	(ECKS-RAY)
Y	— — — —	Yankee	(YANG-KEY)
Z	— — — —	Zulu	(ZOO-LOO)
1	— — — — —	One	(WUN)
2	— — — —	Two	(TOO)
3	— — —	Three	(TREE)
4	— — —	Four	(FOW-ER)
5	— — —	Five	(FIFE)
6	— — —	Six	(SIX)
7	— — — —	Seven	(SEV-EN)
8	— — — — —	Eight	(AIT)
9	— — — — —	Nine	(NIN-ER)
0	— — — — —	Zero	(ZEE-RO)

### 4.5.2 Figures

**4.5.2.1** Figures indicating hundreds and thousands in round numbers, as for ceiling heights, and upper wind levels up to 9,900, must be spoken in accordance with the following:

**EXAMPLE—**

1. 500 . . . . . five hundred
2. 4,500 . . . . . four thousand five hundred

**4.5.2.2** Numbers above 9,900 must be spoken by separating the digits preceding the word “thousand.”

**EXAMPLE—**

1. 10,000 . . . . . one zero thousand
2. 13,500 . . . . . one three thousand five hundred

**4.5.2.3** Transmit airway or jet route numbers as follows:

**EXAMPLE—**

1. V12 . . . . . Victor Twelve
2. J533 . . . . . J Five Thirty– Three

**4.5.2.4** All other numbers must be transmitted by pronouncing each digit.

**EXAMPLE—**

1. 10 . . . . . one zero

**4.5.2.5** When a radio frequency contains a decimal point, the decimal point is spoken as “Point.”

**EXAMPLE–**

122.1 . . . . . one two two point one

**NOTE–**

ICAO procedures require the decimal point be spoken as “decimal.” The FAA will honor such usage by military aircraft and all other aircraft required to use ICAO procedures.

**4.5.3 Altitudes and Flight Levels**

**4.5.3.1** Up to but not including 18,000 feet MSL, by stating the separate digits of the thousands, plus the hundreds.

**EXAMPLE–**

1. 12,000 . . . . . one two thousand
2. 12,500 . . . . . one two thousand five hundred

**4.5.3.2** At and above 18,000’ MSL (FL 180) by stating the words “flight level” followed by the separated digits of the flight level.

**EXAMPLE–**

1. 190 . . . . . Flight Level One Niner Zero
2. 275 . . . . . Flight Level Two Seven Five

**4.5.4 Directions**

**4.5.4.1** The three digits of a magnetic course, bearing, heading or wind direction, should always be magnetic. The word “true” must be added when it applies.

**EXAMPLE–**

1. (Magnetic course) 005 . . . . . zero zero five
2. (True course) 050 . . . . . zero five zero true
3. (Magnetic bearing) 360 . . . . . three six zero
4. (Magnetic heading) 100 . . . . . heading one zero zero
5. (Wind direction) 220 . . . . . wind two two zero

**4.5.5 Speeds**

**4.5.5.1** The separate digits of the speed are to be followed by the word “KNOTS” except that controllers may omit the word “KNOTS” when using speed adjustment procedures (e.g., “REDUCE/INCREASE SPEED TO TWO FIVE ZERO”).

**EXAMPLE–**

1. (Speed) 250 . . . . . two five zero knots
2. (Speed) 190 . . . . . one niner zero knots

**4.5.5.2** The separate digits of the Mach number are to be preceded by the word “Mach.”

**EXAMPLE–**

1. (Mach number) 1.5 . . . . . Mach one point five
2. (Mach number) 0.64 . . . . . Mach point six four
3. (Mach number) 0.7 . . . . . Mach point seven

**4.5.6 Time**

**4.5.6.1** FAA uses Coordinated Universal Time (UTC) for all operations. The word “local” or the time zone equivalent must be used to denote local when local time is given during radio and telephone communications. The term “ZULU” may be used to denote UTC.

**EXAMPLE–**

0920 UTC . . . . . zero niner two zero,  
zero one two zero pacific or local,  
or one twenty AM

**4.5.6.2** To convert from Standard Time to UTC:

*TBL GEN 3.4-5*  
**Standard Time to Coordinated Universal Time**

Eastern Standard Time	Add 5 hours
Central Standard Time	Add 6 hours
Mountain Standard Time	Add 7 hours
Pacific Standard Time	Add 8 hours
Alaska Standard Time	Add 9 hours
Hawaii Standard Time	Add 10 hours

**NOTE-**

*For daylight time, subtract 1 hour.*

**4.5.6.3** A reference may be made to local daylight or standard time utilizing the 24-hour clock system. The hour is indicated by the first two figures and the minutes by the last two figures.

**EXAMPLE-**

1. 0000 . . . . . zero zero zero zero
2. 0920 . . . . . zero niner two zero

**4.5.6.4** Time may be stated in minutes only (two figures) in radio telephone communications when no misunderstanding is likely to occur.

**4.5.6.5** Current time in use at a station is stated in the nearest quarter minute in order that pilots may use this information for time checks. Fractions of a quarter minute or more, but less than eight seconds more, are stated as the preceding quarter minute; fractions of a quarter minute of eight seconds or more are stated as the succeeding quarter minute.

**EXAMPLE-**

1. 0929:05 . . . . time, zero niner two niner
2. 0929:10 . . . . time, zero niner two niner and one-quarter

**4.5.7 Communications with Tower when Aircraft Transmitter/Receiver or Both are Inoperative**

**4.5.7.1 Arriving Aircraft**

**a) Receiver Inoperative.** If you have reason to believe your receiver is inoperative, remain outside or above Class D airspace until the direction and flow of traffic has been determined; then, advise the tower of your type aircraft, position, altitude, intention to land, and request that you be controlled with light signals. When you are approximately 3 to 5 miles from the airport, advise the tower of your position and join the airport traffic pattern. From this point on, watch the tower for light signals. Thereafter, if a complete pattern is made, transmit your position when downwind and/or turning base leg.

**b) Transmitter Inoperative.** Remain outside or above Class D airspace until the direction and flow of traffic has been determined, then join the airport traffic pattern. Monitor the primary local control frequency as depicted on sectional charts for landing or traffic information, and look for a light signal which may be addressed to your aircraft. During hours of daylight, acknowledge tower transmissions or light signals by rocking your wings. At night, acknowledge by blinking the landing or navigational lights.

**NOTE-**

*To acknowledge tower transmissions during daylight hours, hovering helicopters will turn in the direction of the controlling facility and flash the landing light. While in flight, helicopters should show their acknowledgment of receiving a transmission by making shallow banks in opposite directions. At night, helicopters will acknowledge receipt of transmissions by flashing either the landing or the search light.*

**c) Transmitter and Receiver Inoperative.** Remain outside or above Class D airspace until the direction and flow of traffic has been determined, then join the airport traffic pattern and maintain visual contact with tower to receive light signals.

**4.5.7.2 Departing Aircraft.** If you experience radio failure prior to leaving the parking area, make every effort to have the equipment repaired. If you are unable to have the malfunction repaired, call the tower by telephone and request authorization to depart without two-way radio communications. If tower authorization is granted, you will be given departure information and requested to monitor the tower frequency or watch for light signals, as appropriate. During daylight hours, acknowledge tower transmissions or light signals by moving the ailerons or rudder. At night, acknowledge by blinking the landing or navigation lights. If radio malfunction occurs after departing the parking area, watch the tower for light signals or monitor tower frequency.

#### **4.5.8 Contact Procedures**

##### **4.5.8.1 Initial Contact**

a) The terms “initial contact” or “initial call up” mean the first radio call you make to a given facility, or the first call to a different controller/FSS specialist within a facility. Use the following format:

- 1) Name of facility being called.
- 2) Your full aircraft identification as filed in the flight plan or as discussed under aircraft call signs.
- 3) When operating on an airport surface, state your position.
- 4) The type of message to follow or your request if it is short; and
- 5) The word “Over,” if required.

**EXAMPLE–**

1. “New York Radio, Mooney Three One One Echo.”
2. “Columbia Ground, Cessna Three One Six Zero Foxtrot, south ramp, I–F–R Memphis.”
3. “Miami Center, Baron Five Six Three Hotel, request VFR traffic advisories.”

b) Many FSSs are equipped with remote communications outlets and can transmit on the same frequency at more than one location. The frequencies available at specific locations are indicated on charts above FSS communications boxes. To enable the specialist to utilize the correct transmitter, advise the location and frequency on which you expect a reply.

**EXAMPLE–**

*St. Louis FSS can transmit on frequency 122.3 at either Farmington, MO, or Decatur, IL. If you are in the vicinity of Decatur, your callup should be “Saint Louis radio, Piper Six Niner Six Yankee, receiving Decatur One Two Two Point Three.”*

c) If radio reception is reasonably assured, inclusion of your request, your position or altitude, the phrase “Have numbers” or “Information Charlie received” (for ATIS) in the initial contact helps decrease radio frequency congestion. Use discretion and do not overload the controller with information he/she does not need. When you do not get a response from the ground station, recheck your radios or use another transmitter and keep the next contact short.

**EXAMPLE–**

*Atlanta Center, Duke Four One Romeo, request VFR traffic advisories, Twenty Northwest Rome, Seven Thousand Five Hundred, over.”*

#### **4.5.9 Initial Contact when your Transmitting and Receiving Frequencies are Different**

**4.5.9.1** If you are attempting to establish contact with a ground station and you are receiving on a different frequency than that transmitted, indicate the VOR name or the frequency on which you expect a reply. Most FSSs and control facilities can transmit on several VOR stations in the area. Use the appropriate FSS call sign as indicated on charts.

**EXAMPLE–**

*New York FSS transmits on the Kennedy, Deer Park and Calverton VORTACs. If you are in the Calverton area, your callup should be “New York Radio, Cessna Three One Six Zero Foxtrot, receiving Riverhead VOR, over.”*

**4.5.9.2** If the chart indicates FSS frequencies above the VORTAC or in FSS communications boxes, transmit or receive on those frequencies nearest your location.

**4.5.9.3** When unable to establish contact and you wish to call any ground station, use the phrase “any radio (tower) (station), give Cessna Three One Six Zero Foxtrot a call on (frequency) or (VOR).” If an emergency exists or you need assistance, so state.

**4.5.10 Subsequent Contacts and Responses to Call Up from a Ground Facility.** Use the same format as used for initial contact except you should state your message or request with the call up in one transmission. The ground station name and the word “Over” may be omitted if the message requires an obvious reply and there is no possibility for misunderstandings. You should acknowledge all callups or clearances unless the controller of FSS specialist advises otherwise. There are some occasions when the controller must issue time-critical instructions to other aircraft and he/she may be in a position to observe your response, either visually or on radar. If the situation demands your response, take appropriate action or immediately advise the facility of any problem. Acknowledge with your aircraft identification, either at the beginning or at the end of your transmission, and one of the words “Wilco, Roger, Affirmative, Negative” or other appropriate remarks; e.g., “Piper Two One Four Lima, Roger.” If you have been receiving services such as VFR traffic advisories and you are leaving the area or changing frequencies, advise the ATC facility and terminate contact.

#### **4.6 Acknowledgement of Frequency Changes**

**4.6.1** When advised by ATC to change frequencies, acknowledge the instruction. If you select the new frequency without an acknowledgement, the controller’s workload is increased because he/she has no way of knowing whether you received the instruction or have had radio communications failure.

**4.6.2** At times, a controller/specialist may be working a sector with multiple frequency assignments. In order to eliminate unnecessary verbiage and to free the controller/specialist for higher priority transmissions, the controller/specialist may request the pilot “(Identification), change to my frequency 134.5.” This phrase should alert the pilot that he/she is only changing frequencies, not controller/specialist, and that initial call-up phraseology may be abbreviated.

**EXAMPLE–**

*“United Two Twenty-two on One Three Four Point Five” or “One Three Four Point Five, United Two Twenty-two.”*

**4.6.3 Compliance with Frequency Changes.** When instructed by ATC to change frequencies, select the new frequency as soon as possible unless instructed to make the change at a specific time, fix, or altitude. A delay in making the change could result in an untimely receipt of important information. If you are instructed to make the frequency change at a specific time, fix, or altitude, monitor the frequency you are on until reaching the specified time, fix, or altitudes unless instructed otherwise by ATC.

### **5. Communications for VFR Flights**

**5.1** FSSs and Supplemental Weather Service Locations (SWSLs) are allocated frequencies for different functions; for example, in Alaska, certain FSSs provide Local Airport Advisory on 123.6 MHz or other frequencies which can be found in the Chart Supplement U.S. If you are in doubt as to what frequency to use, 122.2 MHz is assigned to the majority of FSSs as a common en route simplex frequency.

**NOTE–**

*In order to expedite communications, state the frequency being used and the aircraft location during initial call-up.*

**EXAMPLE–**

*Dayton radio, November One Two Three Four Five on one two two point two, over Springfield V–O–R, over.*

**5.2** Certain VOR voice channels are being utilized for recorded broadcasts; for example, ATIS. These services and appropriate frequencies are listed in the Chart Supplement U.S. On VFR flights, pilots are urged to monitor these frequencies. When in contact with a control facility, notify the controller if you plan to leave the frequency to monitor these broadcasts.

### **6. Over-water Flights Radio Procedure**

**6.1** Pilots should remember that there is a need to continuously guard the VHF emergency frequency 121.5 MHz when on long over-water flights, except when communications on other VHF channels, equipment limitations,

or cockpit duties prevent simultaneous guarding of two channels. Guarding of 121.5 MHz is particularly critical when operating in proximity to flight information region (FIR) boundaries; for example, operations on Route R220 between Anchorage and Tokyo, since it serves to facilitate communications with regard to aircraft which may experience in-flight emergencies, communications, or navigational difficulties. (Reference ICAO Annex 10, Vol II Paras. 5.2.2.1.1.1 and 5.2.2.1.1.2.)

## **7. Radio Communications and Navigation Facilities**

**7.1** A complete listing of air traffic radio communications facilities and frequencies and radio navigation facilities and frequencies is contained in the Chart Supplement U.S. Similar information for the Pacific and Alaskan areas is contained in the Pacific and Alaskan Supplements (See GEN 3.2, Aeronautical Charts).

## **8. U.S. Aeronautical Telecommunications Services**

**8.1** The following services are available for aircraft engaged in international or overseas flight.

**8.2** The aeronautical voice communication stations listed are available to and utilized by the U.S. Federal Aviation Administration Air Traffic Control Centers for air traffic control purposes.

**8.3** The frequencies in use will depend upon the time of day or night and conditions which affect radio wave propagation. Voice communications handled on a single channel simplex basis (i.e., with the aircraft and the ground station using the same frequency for transmission and reception) unless otherwise noted in remarks.

**8.4** The stations will remain on continuous watch for aircraft within their communications areas and, when practicable, will transfer this watch to another station when the aircraft reaches the limit of the communications area.

**8.5** Stations listed below which are designated “FAA” are operated by the U.S. Federal Aviation Administration. Stations designated “Radio” are operated by Collins Aerospace, Incorporated, (formerly ARINC). Contact the Aviation Voice Services Support Section at [IMS-Voice-Svcs@Collins.com](mailto:IMS-Voice-Svcs@Collins.com). (See TBL GEN 3.4–6.)

**8.6** All users of the North Atlantic HF MWARA services should consult International NOTAMS and ICAO Regional Supplementary Procedures, Document 7030, for current procedures concerning the operational use of the North Atlantic HF families. At present, procedures for the distribution of HF communications traffic in the North Atlantic are:

**8.6.1** All aircraft registered in the hemisphere west of 30W should use family alpha on the southern routes and family bravo on the central and northern routes. (Southern routes are those which enter the New York, San Juan and Santa Maria FIRs. The central and northern routes comprise all others).

**8.6.2** All aircraft registered in the hemisphere east of 30W should use family alpha on the southern routes and family charlie on the central and northern routes.

**8.6.3** All aircraft should use family alpha on the southern route and family delta on the central and northern routes while outside the organized track system (OTS).

**8.6.4** Aircraft registered in Australia will use families designated to aircraft registered east of 30W.

**8.7** Aircraft operating in the Anchorage Arctic CTA/FIR beyond line of sight range of remote control VHF air/ground facilities operated from the Anchorage ACC, must maintain communications with Cambridge Bay radio and a listening or SELCAL watch on HF frequencies of the North Atlantic D (NAT D) network (2971 kHz, 4675 kHz, 8891 kHz and 11279 kHz). Additionally, Cambridge Bay radio can provide Anchorage and Fairbanks surface observations and terminal forecasts to flight crews on request.

TBL GEN 3.4-6

Station and Operating Agency	Radio Call	Transmitting Frequencies	Remarks
HONOLULU (FAA)	Honolulu Radio	122.6 122.2 #121.5 MHz	#Emergency. Frequency 122.1 also available for receiving only.
MIAMI (FAA)	Miami Radio	126.7 118.4 126.9 122.2 122.4 122.75 123.65 127.9 MHz	Local and Short Range.
		#121.5 MHz	#Emergency.
NEW YORK (FAA)	New York Radio (Volmet)	3485* 6604 10051 13270* kHz	*3485 Volmet broadcasts from 1 hour after sunset to 1 hour before sunrise.
			*13270 Volmet broadcasts from 1 hour before sunrise to 1 hour after sunset.
			Broadcasts at H+00-05; Aerodrome Forecasts, Detroit, Chicago, Cleveland. Hourly Reports, Detroit, Chicago, Cleveland, Niagara Falls, Milwaukee, Indianapolis.
			Broadcasts at H+05-10; SIGMET (Oceanic-New York). Aerodrome Forecasts, Bangor, Pittsburgh, Charlotte. Hourly Reports, Bangor, Pittsburgh, Windsor Locks, St. Louis, Charlotte, Minneapolis.
			Broadcasts at H+10-15; Aerodrome Forecasts, New York, Newark, Boston. Hourly reports, New York, Newark, Boston, Baltimore, Philadelphia, Washington.
			Broadcasts at H+15-20; SIGMET (Oceanic-Miami/San Juan). Aerodrome Forecasts, Bermuda, Miami, Atlanta. Hourly Reports, Bermuda, Miami, Nassau, Freeport, Tampa, West Palm Beach, Atlanta.
			Broadcasts at H+30-35; Aerodrome Forecasts, Niagara Falls, Milwaukee, Indianapolis. Hourly Reports Detroit, Chicago, Cleveland, Niagara Falls, Milwaukee, Indianapolis.
			Broadcasts at H+35-40; SIGMET (Oceanic-New York). Aerodrome Forecasts, Windsor Locks, St. Louis. Hourly Reports, Bangor, Pittsburgh, Windsor Locks, St. Louis, Charlotte, Minneapolis.
			Broadcasts at H+40-45; Aerodrome Forecasts, Baltimore, Philadelphia, Washington. Hourly Reports, New York, Newark, Boston, Baltimore, Philadelphia, Washington.
			Broadcasts at H+45-50; SIGMET (Oceanic-Miami/San Juan). Aerodrome Forecasts, Nassau, Freeport. Hourly Reports, Bermuda, Miami, Nassau, Freeport, Tampa, West Palm Beach, Atlanta.



Station and Operating Agency	Radio Call	Transmitting Frequencies	Remarks
NEW YORK (RADIO)	New York	3016 5598 8906 13306 17946 21964 kHz	North Atlantic Family A Network.
		2962 6628 8825 11309 13354 17952 kHz	North Atlantic Family E Network.
		2887 3455 5550 6577 8846 11396 kHz	Caribbean Family A Network.
		5520 6586 8918 11330 13297 17907 kHz	Caribbean Family B Network.
		3494 6640 8933 11342 13330 17925 kHz	Long Distance Operations Control (LDOC) Service (phone–patch). Communications are limited to operational control matters only. Public correspondence (personal messages) to/from crew or passengers cannot be accepted. <b>Note:</b> New York RADIO can also provide HF communications over South America on these LDOC frequencies through their remote site located in Santa Cruz, Bolivia.
		129.90 MHz	Extended range VHF. Coverage area includes Canadian Maritime Provinces, and oceanic routes to the Caribbean, from Boston, New York and Washington areas to approximately 250 nautical miles from the east coast.
		130.7 MHz	Extended range VHF. Full period service is provided within most of the Gulf of Mexico. Also on routes between Miami and San Juan to a distance of approximately 250 nautical miles from the Florida coast and within approximately 250 nautical miles of San Juan. <b>Note:</b> New York RADIO also provides VHF communications over the Northern two–thirds of Mexico on 130.7 MHz for 14 CFR Section 121.99 compliance.
		436623	Aircraft operating within the New York Oceanic FIR.
SAN FRANCISCO (RADIO)	San Francisco	3413 3452 5574 5667 6673 8843 10057 11330 13354 kHz	Central East Pacific One Network.
		2869 5547 11282 13288 21964 kHz	Central East Pacific Two Network.
		2998 4666 6532 8903 11384 13300 17904 21985 kHz	Central West Pacific Network.
		3467 5643 8867 13261 17904 kHz	South Pacific Network.
		2932 5628 6655 8915 8951 10048 11330 13273 13339 17946 21925 kHz	North Pacific Network

Station and Operating Agency	Radio Call	Transmitting Frequencies	Remarks
		3494 6640 8903 11342 13348 17925 21964 kHz	Long Distance Operations Control (LDOC) Service (phone–patch). Communications are limited to operational control matters only. Public correspondence (personal messages) to/from crew or passengers cannot be accepted. <b>Note:</b> San Francisco RADIO can also provide HF communications along the polar routes on these LDOC frequencies through their remote site located at Barrow, Alaska.
		131.95 MHz	Extended range VHF. Coverage area includes area surrounding the Hawaiian Islands and Guam. Coverage extends out approximately 250 NM from Hawaii and from the West coast.
		129.40 MHz	For en route communications for aircraft operating on Seattle/Anchorage/Routes.
		436625	Aircraft operating within the Oakland and Anchorage Oceanic FIRs.
OAKLAND (FAA)	Oakland Radio	122.5 122.2 #121.5 MHz	#Emergency.
SAN JUAN P.R. (FAA)	San Juan Radio	#121.5 122.2 126.7 123.65 #243.0 255.4 114.0 113.5 108.2 108.6 109.0 110.6 MHz	Unscheduled broadcasts H+00, H+15, H+30 and H+45 as appropriate, for Weather and Military Activity Advisories, on 110.6, 109.0, 108.6, 108.2, 113.5, and 114.0 MHz. #Emergency. For frequencies 114.0, 113.5, 108.2 and 109.0 MHz use 122.1 MHz for transmissions to San Juan Radio. For frequency 108.6 use 123.6 MHz.

## 9. Selective Calling System (SELCAL) Facilities Available

9.1 The SELCAL is a communication system which permits the selective calling of individual aircraft over radio–telephone channels from the ground station to properly equipped aircraft, so as to eliminate the need for the flight crew to constantly monitor the frequency in use.

TBL GEN 3.4–7

Location	Operator	HF	VHF
New York	RADIO	X	X
San Francisco	RADIO	X	X

## 10. Special North Atlantic, Caribbean, and Pacific Area Communications

10.1 VHF air–to–air frequencies enable aircraft engaged on flights over remote and oceanic areas out of range of VHF ground stations to exchange necessary operational information and to facilitate the resolution of operational problems.

10.2 Frequencies have been designated as follows:

TBL GEN 3.4–8

Area	Frequency
North Atlantic	123.45 MHz
Caribbean	123.45 MHz
Pacific	123.45 MHz

## 11. Distress and Urgency Communications

**11.1** A pilot who encounters a distress or urgency condition can obtain assistance simply by contacting the air traffic facility or other agency in whose area of responsibility the aircraft is operating, stating the nature of the difficulty, pilot's intentions, and assistance desired. Distress and urgency communications procedures are prescribed by the International Civil Aviation Organization (ICAO), however, and have decided advantages over the informal procedure described above.

**11.2** Distress and urgency communications procedures discussed in the following paragraphs relate to the use of air ground voice communications.

**11.3** The initial communication, and if considered necessary, any subsequent transmissions by an aircraft in distress should begin with the signal MAYDAY, preferably repeated three times. The signal PAN–PAN should be used in the same manner for an urgency condition.

**11.4** Distress communications have absolute priority over all other communications, and the word MAYDAY commands radio silence on the frequency in use. Urgency communications have priority over all other communications except distress, and the word PAN–PAN warns other stations not to interfere with urgency transmissions.

**11.5** Normally, the station addressed will be the air traffic facility or other agency providing air traffic services, on the frequency in use at the time. If the pilot is not communicating and receiving services, the station to be called will normally be the air traffic facility or other agency in whose area of responsibility the aircraft is operating, on the appropriate assigned frequency. If the station addressed does not respond, or if time or the situation dictates, the distress or urgency message may be broadcast, or a collect call may be used, addressing "Any Station (Tower) (Radio) (Radar)."

**11.6** The station addressed should immediately acknowledge a distress or urgency message, provide assistance, coordinate and direct the activities of assisting facilities, and alert the appropriate Search and Rescue coordinator if warranted. Responsibility will be transferred to another station only if better handling will result.

**11.7** All other stations, aircraft and ground, will continue to listen until it is evident that assistance is being provided. If any station becomes aware that the station being called either has not received a distress or urgency message, or cannot communicate with the aircraft in difficulty, it will attempt to contact the aircraft and provide assistance.

**11.8** Although the frequency in use or other frequencies assigned by ATC are preferable, the following emergency frequencies can be used for distress or urgency communications, if necessary or desirable:

**11.8.1 121.5 MHz and 243.0 MHz.** Both have a range generally limited to line of sight. 121.5 MHz is guarded by direction finding stations and some military and civil aircraft. 243.0 MHz is guarded by military aircraft. Both 121.5 MHz and 243.0 MHz are guarded by military towers, most civil towers, flight service stations, and radar facilities. Normally ARTCC emergency frequency capability does not extend to radar coverage limits. If an ARTCC does not respond when called on 121.5 MHz or 243.0 MHz, call the nearest tower or flight service station.

**11.8.2 2182 kHz.** The range is generally less than 300 miles for the average aircraft installation. It can be used to request assistance from stations in the maritime service. 2182 kHz is guarded by major radio stations serving Coast Guard Rescue Coordination Centers and Coast Guard units along the sea coasts of the U.S. and shores of the Great Lakes. The call "Coast Guard" will alert all Coast Guard Radio Stations within range. 2182 kHz is also guarded by most commercial coast stations and some ships and boats.

## 12. Two-Way Radio Communications Failure

**12.1** It is virtually impossible to provide regulations and procedures applicable to all possible situations associated with two-way radio communications failure. During two-way radio communications failure when confronted by a situation not covered in the regulation, pilots are expected to exercise good judgment in whatever

action they elect to take. Should the situation so dictate, they should not be reluctant to use the emergency action contained in 14 CFR Section 91.3(b).

**12.2** Whether two-way communications failure constitutes an emergency depends on the circumstances, and in any event is a determination made by the pilot. 14 CFR Section 91.3 authorizes a pilot to deviate from any rule to the extent required to meet an emergency.

**12.3** In the event of two-way radio communications failure, ATC service will be provided on the basis that the pilot is operating in accordance with 14 CFR Section 91.185. A pilot experiencing two-way communications failure should (unless emergency authority is exercised) comply with 14 CFR Section 91.185 as indicated below.

**12.4** Unless otherwise authorized by ATC, each pilot who has two-way radio communications failure when operating under IFR must comply with the following conditions:

**12.4.1** If the failure occurs in VFR conditions, or if VFR conditions are encountered after the failure, each pilot must continue the flight under VFR and land as soon as practicable.

**NOTE–**

*This procedure also applies when two-way radio failure occurs while operating in Class A airspace. The primary objective of this provision in 14 CFR Section 91.185 is to preclude extended IFR operation by these aircraft within the ATC system. Pilots should recognize that operation under these conditions may unnecessarily as well as adversely affect other users of the airspace, since ATC may be required to reroute or delay other users in order to protect the failure aircraft. However, it is not intended that the requirement to “land as soon as practicable” be construed to mean “as soon as possible.” Pilots retain the prerogative of exercising their best judgment and are not required to land at an unauthorized airport, at an airport unsuitable for the type of aircraft flown, or to land only minutes short of their intended destination.*

**12.4.2** If the failure occurs in IFR conditions, or if VFR conditions cannot be complied with, each pilot must continue the flight according to the following requirements.

**12.5 Route requirements:**

**12.5.1** By the route assigned in the last ATC clearance received.

**12.5.2** If being radar vectored, by the direct route from the point of radio failure to the fix, route, or airway specified in the vector clearance.

**12.5.3** In the absence of an assigned route, by the route that ATC has advised may be expected in a further clearance.

**12.5.4** In the absence of an assigned route or a route that ATC has advised may be expected in a further clearance, by the route filed in the flight plan.

**12.6** Altitude requirements. At the HIGHEST of the following altitudes or flight levels FOR THE ROUTE SEGMENT BEING FLOWN:

**12.6.1** The altitude or flight level assigned in the last ATC clearance received.

**12.6.2** The minimum altitude (converted, if appropriate, to minimum flight level as prescribed in 14 CFR Section 91.121(c)) for IFR operations.

**12.6.3** The altitude or flight level ATC has advised may be expected in a further clearance.

**NOTE–**

*The intent of the rule is that a pilot who has experienced two-way radio failure should select the appropriate altitude for the particular route segment being flown and make the necessary altitude adjustments for subsequent route segments. If the pilot received an “expect further clearance” containing a higher altitude to expect at a specified time or fix, he/she should maintain the highest of the following altitudes until that time/fix: (1) his/her last assigned altitude, or (2) the minimum altitude/flight level for IFR operations.*

*Upon reaching the time/fix specified, the pilot should commence his/her climb to the altitude he/she was advised to expect. If the radio failure occurs after the time/fix specified, the altitude to be expected is not applicable and the pilot should maintain an altitude consistent with 1 or 2 above.*

*If the pilot receives an “expect further clearance” containing a lower altitude, the pilot should maintain the highest of 1 or 2 above until that time/fix specified in paragraph 12.7, Leave Clearance Limit.*

**EXAMPLE–**

1. A pilot experiencing two–way radio failure at an assigned altitude of 7,000 feet is cleared along a direct route which will require a climb to a minimum IFR altitude of 9,000 feet, should climb to reach 9,000 feet at the time or place where it becomes necessary (see 14 CFR Section 91.177(b)). Later while proceeding along an airway with an MEA of 5,000 feet, the pilot would descend to 7,000 feet (the last assigned altitude), because that altitude is higher than the MEA.

2. A pilot experiencing two–way radio failure while being progressively descended to lower altitudes to begin an approach is assigned 2,700 feet until crossing the VOR and then cleared for the approach. The MOCA along the airway is 2,700 feet and MEA is 4,000 feet. The aircraft is within 22 NM of the VOR. The pilot should remain at 2,700 feet until crossing the VOR because that altitude is the minimum IFR altitude for the route segment being flown.

3. The MEA between a and b – 5,000 feet. The MEA between b and c – 5,000 feet. The MEA between c and d – 11,000 feet. The MEA between d and e – 7,000 feet. A pilot had been cleared via a, b, c, d, to e. While flying between a and b the assigned altitude was 6,000 feet and the pilot was told to expect a clearance to 8,000 feet at b. Prior to receiving the higher altitude assignment, the pilot experienced two–way failure. The pilot would maintain 6,000 to b, then climb to 8,000 feet (the altitude the pilot was advised to expect.) The pilot would maintain 8,000 feet, then climb to 11,000 at c, or prior to c if necessary to comply with an MCA at c. (14 CFR Section 91.177(b).) Upon reaching d, the pilot would descend to 8,000 feet (even though the MEA was 7,000 feet), as 8,000 was the highest of the altitude situations stated in the rule 14 CFR Section 91.185.

### 12.7 Leave Clearance Limit

**12.7.1** When the clearance limit is a fix from which an approach begins, commence descent or descent and approach as close as possible to the expected further clearance time if one has been received, or if one has not been received, as close as possible to the estimated time of arrival as calculated from the filed or amended (with ATC) estimated time en route.

**12.7.2** If the clearance limit is not a fix from which an approach begins, leave the clearance limit at the expected further clearance time if one has been received, or if none has been received, upon arrival over the clearance limit, and proceed to a fix from which an approach begins and commence descent or descent and approach as close as possible to the estimated time of arrival as calculated from the filed or amended (with ATC) estimated time en route.

## 13. Transponder Operation During Two–Way Communications Failure

**13.1** If an aircraft with a coded radar beacon transponder experiences a loss of two–way radio capability, the pilot should adjust the transponder to reply on Mode 3/A, Code 7600.

**13.2** The pilot should understand that the aircraft may not be in an area of radar coverage.

## 14. Reestablishing Radio Contact

**14.1** In addition to monitoring the NAVAID voice feature, the pilot should attempt to reestablish communications by attempting contact:

**14.1.1** On the previously assigned frequency.

**14.1.2** With an FSS, New York Radio, or San Francisco Radio.

**14.2** If communications are established with an FSS, New York Radio or San Francisco Radio, the pilot should advise the aircraft's position, altitude, and last assigned frequency; then request further clearance from the controlling facility. The preceding does not preclude the use of 121.5 MHz. There is no priority on which action should be attempted first. If the capability exists, do all at the same time.

**NOTE–**

*New York Radio and San Francisco Radio are operated by Collins Aerospace, Incorporated (formerly ARINC) under contract with the FAA for communications services. These Radio facilities have the capability of relaying information to/from ATC facilities throughout the country.*



---

## GEN 3.5 Meteorological Services

### 1. Meteorological Authority

**1.1** The meteorological authority for the United States is the Federal Aviation Administration Assistant Administrator for the Next Generation Air Transportation System (NextGen).

**Postal Address:**

Assistant Administrator, NextGen  
Federal Aviation Administration  
Orville Wright Building (FOB-10A)  
FAA National Headquarters  
800 Independence Avenue, SW.  
Washington DC 20591

**Telephone:** 202-267-7111

**Fax:** 202-267-5456

### 1.2 Meteorological Information Service Provider

**1.2.1** The meteorological services for civil aviation are prepared by the National Oceanic and Atmospheric Administration (NOAA) of the U.S. Department of Commerce.

**Postal Address:**

National Weather Service  
National Oceanic and Atmospheric Administration  
Department of Commerce  
1325 East West Highway  
Silver Spring, Maryland 20910

**Telephone:** 301-713-1726

**Fax:** 301-713-1598

### 1.3 Meteorological Offices

#### 1.3.1 FAA Flight Service Stations

**1.3.1.1** A complete listing of FAA Flight Service Stations and their telephone numbers is contained in the Chart Supplement U.S. Additionally, communications data and en route services provided by FAA Flight Service Stations are contained in the same publication. Similar information for the Pacific and Alaskan areas is contained in the Chart Supplements Pacific and Alaska. (See GEN 3.2, Aeronautical Charts.)

### 1.4 Climatological Summaries

**1.4.1** Requests for copies of climatological summaries are made available through the:

**Postal Address:**

National Climatic Data Center  
Department of Commerce  
National Oceanic and Atmospheric Administration  
Environmental Data Services Branch  
Federal Building  
Asheville, North Carolina 28801

## 2. Area of Responsibility

**2.1** The National Weather Service (NWS) is responsible for providing meteorological services for the 50 states of the U.S., its external territories, and possessions.

**2.2 International Flight Documentation Sites.** Airports listed below are designated as international flight documentation sites.

TBL GEN 3.5–1

Location	Airport Name	Indicator
Anchorage, AK	Anchorage International	PANC
Atlanta, GA	William B. Hartsfield International	KATL
Baltimore, MD	Baltimore–Washington International	KBWI
Boston, MA	General Edward Lawrence Logan International	KBOS
Charlotte, NC	Charlotte/Douglas International	KCLT
Chicago, IL	O’Hare International	KORD
Cincinnati, OH	Cincinnati/Northern Kentucky International	KCVG
Dallas–Ft. Worth, TX	Dallas–Ft. Worth International	KDFW
Detroit, MI	Detroit Metropolitan Wayne County	KDTW
Fairbanks, AK	Fairbanks International	PAFA
Guam	Guam/Agana Naval Air Station	NOCD AGANA
Hartford, CT	Bradley International	KBDL
Houston, TX	George Bush Intercontinental/Houston	KIAH
Kahului, HI	Kahului	PHOG
Las Vegas, NV	Harry Reid International	KLAS
Los Angeles, CA	Los Angeles International	KLAX
Miami, FL	Miami International	KMIA
Minneapolis, MN	Minneapolis–St. Paul International (Wold–Chamberlain)	KMSP
New Orleans, LA	New Orleans International (Moisant Field)	KMSY
New York, NY	John F. Kennedy International	KJFK
Newark, NJ	Newark International	KEWR
Orlando, FL	Orlando International	KMCO
Pago Pago, American Samoa	Pago Pago International	NSTU
Philadelphia, PA	Philadelphia International	KPHL
Pittsburgh, PA	Pittsburgh International	KPIT
Portland, OR	Portland International	KPDX
Raleigh–Durham, NC	Raleigh–Durham International	KRDU
San Francisco, CA	San Francisco International	KSFO
San Juan, PR	Luis Munoz Marin International	TJSJ
Seattle, WA	Seattle–Tacoma International	KSEA
Tampa, FL	Tampa International	KTPA
Washington, DC	Washington Dulles International	KIAD

2.2.1 Climatological information, basically in the form of climatological summaries, is available at all designated international airports in the U.S.

2.2.2 Flight documentation is provided in the form of copies of facsimile charts, copies of teletype–writer forecasts, and airport forecast decode sheets. Flight documentation materials are available at all destination



regular airport meteorological stations. English is the language used for all U.S. flight documentation. Briefings can be provided either in person or received by telephone at all airport meteorological offices.

**2.2.3** All airport forecasts (TAF) prepared for U.S. international airports cover the following validity periods: 00–24 UTC, 06–06 UTC, 12–12 UTC, and 18–18 UTC. At the present time, specific landing forecasts are not made for any U.S. airport. The portion of the airport's TAF valid closest to the time of landing is used in lieu of a landing forecast.

**2.2.4** Supplementary information available at U.S. meteorological airport offices includes extended weather and severe weather outlooks, pilot reports, runway braking action reports (during the winter), relative humidity, times of sunrise and sunset, surface and upper air analyses, radar echo charts, and forecasts of maximum and minimum surface temperatures.

**2.2.5** All meteorological offices shown as taking routine aviation observations also take unscheduled special aviation observations when meteorological conditions warrant.

### **3. Types of Service Provided**

#### **3.1 Area Forecast Charts (Facsimile Form)**

**3.1.1** The U.S. has one Area Forecast Center, the National Center for Environmental Predictions (NCEP), located in Suitland, Maryland. The NCEP prepares current weather, significant weather, forecast weather, constant pressure, and tropopause–vertical wind shear charts for the U.S., the Caribbean and Northern South America, the North Atlantic, and the North Pacific areas. The NCEP also prepares a constant pressure and tropopause–vertical wind shear chart for Canada.

#### **3.2 Local and Regional Aviation Forecasts (Printed Form)**

**3.2.1** Numerous forecasts and weather advisories are prepared which serve local and regional areas of the U.S. These forecasts are generally prepared by the NWS on a scheduled basis or, as in the case of severe weather advisories, as needed. These forecasts are Area Forecast (FA), Airport Forecast (TAF), Severe Weather Forecast (WW), Hurricane Advisories (WT), Winds and Temperature Aloft Forecast (FD), Simplified Surface Analyses (AS), 12- and 24-Hour Prognoses (FS), and flight advisory notices, such as SIGMETs (WS), AIRMETs (text bulletins–[WA] and graphics [G–AIRMET]), Center Weather Advisories (CWA), and Radar Weather Reports (SD).

#### **3.3 Preflight Briefing Services**

**3.3.1** Preflight briefing services and flight documentation are provided through FAA Flight Service Stations (FSS).

#### **3.4 National Weather Service Aviation Weather Service Program**

**3.4.1** Weather service to aviation is a joint effort of the National Oceanic and Atmospheric Administration (NOAA), the National Weather Service (NWS), the Federal Aviation Administration (FAA), Department of Defense, and various private sector aviation weather service providers. Requirements for all aviation weather products originate from the FAA, which is the Meteorological Authority for the U.S.

**3.4.2** NWS meteorologists are assigned to all air route traffic control centers (ARTCC) as part of the Center Weather Service Units (CWSU) as well as the Air Traffic Control System Command Center (ATCSCC). These meteorologists provide specialized briefings as well as tailored forecasts to support the needs of the FAA and other users of the NAS.

#### **3.4.3 Aviation Products**

**3.4.3.1** The NWS maintains an extensive surface, upper air, and radar weather observing program; and a nationwide aviation weather forecasting service.

**3.4.3.2** Airport observations (METAR and SPECI) supported by the NWS are provided by automated observing systems.

**3.4.3.3** Terminal Aerodrome Forecasts (TAF) are prepared by 123 NWS Weather Forecast Offices (WFOs) for over 700 airports. These forecasts are valid for 24 or 30 hours and amended as required.

**3.4.3.4** Inflight aviation advisories (for example, Significant Meteorological Information (SIGMETs) and Airmen’s Meteorological Information (AIRMETs)) are issued by three NWS Meteorological Watch Offices (MWOs); the Aviation Weather Center (AWC) in Kansas City, MO, the Alaska Aviation Weather Unit (AAWU) in Anchorage, AK, and the Weather Service Forecast Office (WFO) in Honolulu, HI. The AWC, the AAWU, and WSFO Honolulu issue area forecasts for selected areas. In addition, NWS meteorologists assigned to most ARTCCs as part of the Center Weather Service Unit (CWSU) provide Center Weather Advisories (CWAs) and gather weather information to support the needs of the FAA and other users of the system.

**3.4.3.5** Several NWS National Centers for Environmental Prediction (NCEP) provide aviation specific weather forecasts, or select public forecasts which are of interest to pilots and operators.

a) The Aviation Weather Center (AWC) displays a variety of domestic and international aviation forecast products over the Internet at [aviationweather.gov](http://aviationweather.gov).

b) The NCEP Central Operations (NCO) is responsible for the operation of many numerical weather prediction models, including those which produce the many wind and temperature aloft forecasts.

c) The Storm Prediction Center (SPC) issues tornado and severe weather watches along with other guidance forecasts.

d) The National Hurricane Center (NHC) issues forecasts on tropical weather systems (for example, hurricanes).

e) The Space Weather Prediction Center (SWPC) provides alerts, watches, warnings and forecasts for space weather events (for example, solar storms) affecting or expected to affect Earth’s environment.

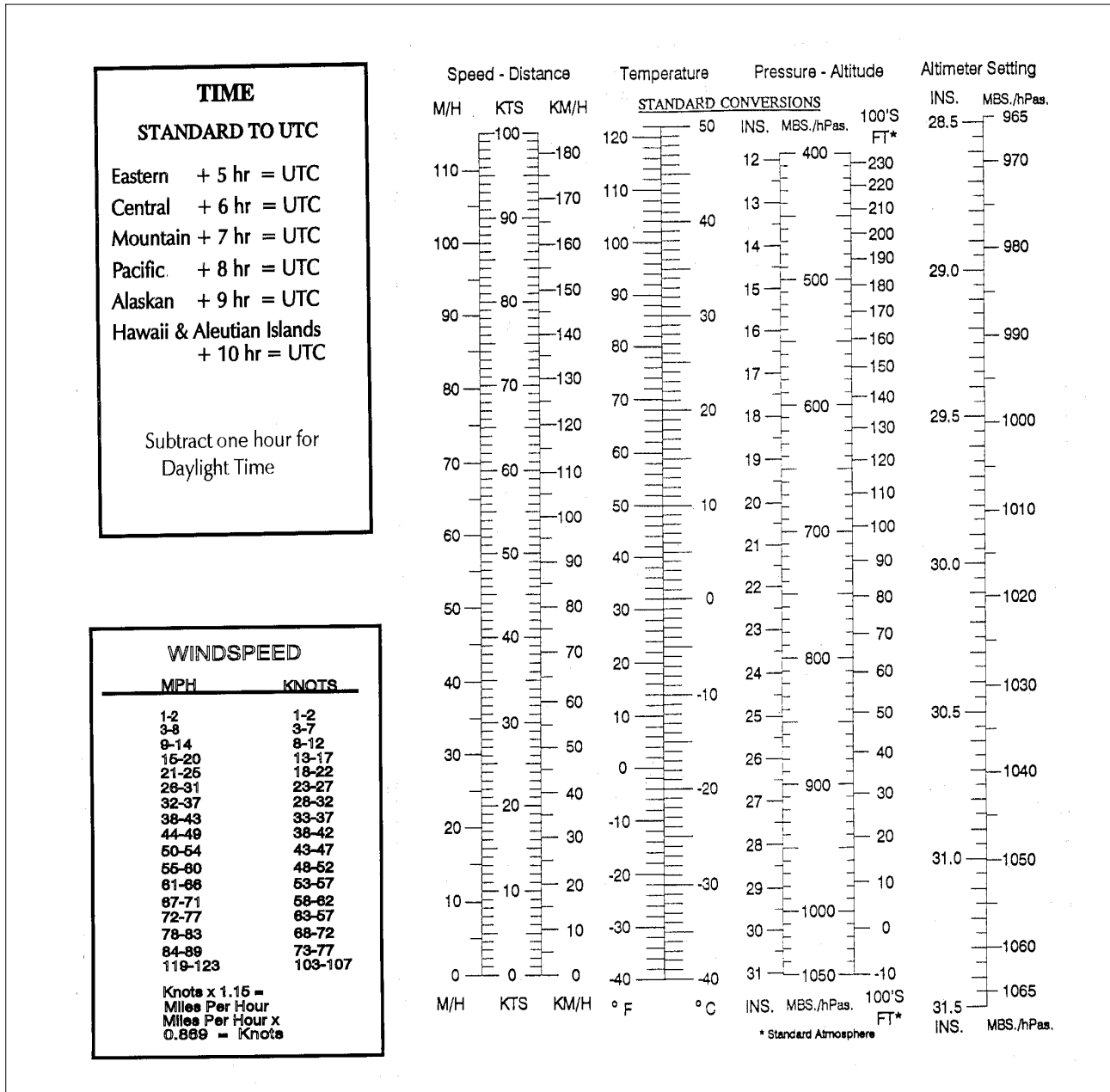
f) The Weather Prediction Center (WPC) provides analysis and forecast products on a national scale including surface pressure and frontal analyses.

**3.4.3.6** NOAA operates two Volcanic Ash Advisory Centers (VAAC) which issue forecasts of ash clouds following a volcanic eruption in their area of responsibility.

**3.4.3.7** Details on the products provided by the above listed offices and centers is available in FAA Advisory Circular 00-45, Aviation Weather Services.

**3.4.4** Weather element values may be expressed by using different measurement systems depending on several factors, such as whether the weather products will be used by the general public, aviation interests, international services, or a combination of these users. FIG GEN 3.5–1 provides conversion tables for the most used weather elements that will be encountered by pilots.

FIG GEN 3.5-1  
Weather Elements Conversion Tables



### 3.5 FAA Weather Services

**3.5.1** The FAA provides the Flight Service program, which serves the weather needs of pilots through its flight service stations (FSS) (both government and contract via 1-800-WX-BRIEF) and via the Internet, through Leidos Flight Service.

**3.5.2** The FAA maintains an extensive surface weather observing program. Airport observations (METAR and SPECI) in the U.S. are provided by automated observing systems. Various levels of human oversight of the METAR and SPECI reports and augmentation may be provided at select larger airports by either government or contract personnel qualified to report specified weather elements that cannot be detected by the automated observing system. The requirements to issue SPECI reports are detailed in TBL GEN 3.5-2.

TBL GEN 3.5-2

SPECI Issuance Table		
1	<b>Wind Shift</b>	Wind direction changes by 45° or more, in less than 15 minutes, and the wind speed is 10 kt or more throughout the wind shift.
2	<b>Visibility</b>	The surface visibility (as reported in the body of the report): <ul style="list-style-type: none"> <li>• Decreases to less than 3 sm, 2 sm, 1 sm, ½ sm, ¼ sm or the lowest standard instrument approach procedure (IAP) minimum.<sup>1</sup></li> <li>• Increases to equal to or exceed 3 sm, 2 sm, 1 sm, ½ sm, ¼ sm or the lowest standard IAP minimum.<sup>1</sup></li> </ul> <sup>1</sup> As published in the U.S. Terminal Procedures. If none published, use ½ sm.
3	<b>RVR</b>	The highest value from the designated RVR runway decreases to less than 2,400 ft during the preceding 10 minutes; or, if the RVR is below 2,400 ft, increases to equal to or exceed 2,400 ft during the preceding 10 minutes. U.S. military stations may not report a SPECI based on RVR.
4	<b>Tornado, Funnel Cloud, or Waterspout</b>	<ul style="list-style-type: none"> <li>• Is observed.</li> <li>• Disappears from sight or ends.</li> </ul>
5	<b>Thunderstorm</b>	<ul style="list-style-type: none"> <li>• Begins (a SPECI is not required to report the beginning of a new thunderstorm if one is currently reported).</li> <li>• Ends.</li> </ul>
6	<b>Precipitation</b>	<ul style="list-style-type: none"> <li>• Hail begins or ends.</li> <li>• Freezing precipitation begins, ends, or changes intensity.</li> <li>• Ice pellets begin, end, or change intensity.</li> <li>• Snow begins, ends, or changes intensity.</li> </ul>
7	<b>Squalls</b>	When a squall occurs. (Wind speed suddenly increases by at least 16 knots and is sustained at 22 knots or more for at least one minute.)
8	<b>Ceiling</b>	The ceiling changes <sup>1</sup> through: <ul style="list-style-type: none"> <li>• 3,000 ft.</li> <li>• 1,500 ft.</li> <li>• 1,000 ft.</li> <li>• 500 ft.</li> <li>• The lowest standard IAP minimum.<sup>2</sup></li> </ul> <sup>1</sup> “Ceiling change” means that it forms, dissipates below, decreases to less than, or, if below, increases to equal or exceed the values listed. <sup>2</sup> As published in the U.S. Terminal Procedures. If none published, use 200 ft.
9	<b>Sky Condition</b>	A layer of clouds or obscurations aloft is present below 1,000 ft and no layer aloft was reported below 1,000 ft in the preceding METAR or SPECI.
10	<b>Volcanic Eruption</b>	When an eruption is first noted.

11	Aircraft Mishap	Upon notification of an aircraft mishap, <sup>1</sup> unless there has been an intervening observation.  <sup>1</sup> “Aircraft mishap” is an inclusive term to denote the occurrence of an aircraft accident or incident.
12	Miscellaneous	Any other meteorological situation designated by the responsible agency of which, in the opinion of the observer, is critical.

### 3.5.3 Other Sources of Weather Information

**3.5.3.1** Weather and aeronautical information are available from numerous private industry sources on an individual or contract pay basis. Prior to every flight, pilots should gather all information vital to the nature of the flight. Pilots can receive a regulatory compliant briefing without contacting Flight Service. Pilots are encouraged to use automated resources and review AC 91-92, Pilot’s Guide to a Preflight Briefing, for more information.

**3.5.3.2** Pilots can access Leidos Flight Services via the Internet at <http://www.1800wxbrief.com>. Pilots can receive preflight weather data and file VFR and IFR flight plans.

### 3.6 Use of Aviation Weather Products

**3.6.1** Air carriers and operators certificated under the provisions of 14 CFR Part 119 are required to use the aeronautical weather information systems defined in the Operations Specifications issued to that certificate holder by the FAA. These systems may utilize basic FAA/National Weather Service (NWS) weather services, contractor- or operator-proprietary weather services and/or Enhanced Weather Information System (EWINS) when approved in the Operations Specifications. As an integral part of this system approval, the procedures for collecting, producing and disseminating aeronautical weather information, as well as the crew member and dispatcher training to support the use of system weather products, must be accepted or approved.

**3.6.2** Operators not certificated under the provisions of 14 CFR Part 119 are encouraged to use FAA/NWS products through Flight Service Stations, Leidos Flight Service, and/or Flight Information Services–Broadcast (FIS–B).

**3.6.3** The suite of available aviation weather product types is expanding, with the development of new sensor systems, algorithms and forecast models. The FAA and NWS, supported by various weather research laboratories and corporations under contract to the Government, develop and implement new aviation weather product types. The FAA’s NextGen Aviation Weather Research Program (AWRP) facilitates collaboration between the NWS, the FAA, and various industry and research representatives. This collaboration ensures that user needs and technical readiness requirements are met before experimental products mature to operational application.

**3.6.4** The AWRP manages the transfer of aviation weather R&D to operational use through technical review panels and conducting safety assessments to ensure that newly developed aviation weather products meet regulatory requirements and enhance safety.

**3.6.5** The AWRP review and decision-making process applies criteria to weather products at various stages. The stages are composed of the following:

**3.6.5.1** Sponsorship of user needs.

**3.6.5.2** R & D and controlled testing.

**3.6.5.3** Experimental application.

**3.6.5.4** Operational application.

**3.6.6** Pilots and operators should be aware that weather services provided by entities other than FAA, NWS, or their contractors may not meet FAA/NWS quality control standards. Hence, operators and pilots contemplating

using such services should request and/or review an appropriate description of services and provider disclosure. This should include, but is not limited to, the type of weather product (for example, current weather or forecast weather), the currency of the product (that is, product issue and valid times), and the relevance of the product. Pilots and operators should be cautious when using unfamiliar products, or products not supported by FAA/NWS technical specifications.

**NOTE–**

*When in doubt, consult with a FAA Flight Service Station Specialist.*

**3.6.7** In addition, pilots and operators should be aware there are weather services and products available from government organizations beyond the scope of the AWRP process mentioned earlier in this section. For example, governmental agencies such as the NWS and the Aviation Weather Center (AWC), or research organizations such as the National Center for Atmospheric Research (NCAR) display weather “model data” and “experimental” products which require training and/or expertise to properly interpret and use. These products are developmental prototypes that are subject to ongoing research and can change without notice. Therefore, some data on display by government organizations, or government data on display by independent organizations may be unsuitable for flight planning purposes. Operators and pilots contemplating using such services should request and/or review an appropriate description of services and provider disclosure. This should include, but is not limited to, the type of weather product (for example, current weather or forecast weather), the currency of the product (i.e., product issue and valid times), and the relevance of the product. Pilots and operators should be cautious when using unfamiliar weather products.

**NOTE–**

*When in doubt, consult with a FAA Flight Service Station Specialist.*

**3.6.8** With increased access to weather products via the public Internet, the aviation community has access to an over whelming amount of weather information and data that support self-briefing. FAA AC 00-45 (current edition) describes the weather products distributed by the NWS. Pilots and operators using the public Internet to access weather from a third party vendor should request and/or review an appropriate description of services and provider disclosure. This should include, but is not limited to, the type of weather product (for example, current weather or forecast weather), the currency of the product (i.e., product issue and valid times), and the relevance of the product. Pilots and operators should be cautious when using unfamiliar weather products and when in doubt, consult with a Flight Service Specialist.

**3.6.9** The development of new weather products, coupled with the termination of some legacy textual and graphical products may create confusion between regulatory requirements and the new products. All flight-related, aviation weather decisions must be based on all available pertinent weather products. As every flight is unique and the weather conditions for that flight vary hour by hour, day to day, multiple weather products may be necessary to meet aviation weather regulatory requirements. Many new weather products now have a Precautionary Use Statement that details the proper use or application of the specific product.

**3.6.10** The FAA has identified three distinct types of weather information available to pilots and operators.

**3.6.10.1 Observations.** Raw weather data collected by some type of sensor suite including surface and airborne observations, radar, lightning, satellite imagery, and profilers.

**3.6.10.2 Analysis.** Enhanced depiction and/or interpretation of observed weather data.

**3.6.10.3 Forecasts.** Predictions of the development and/or movement of weather phenomena based on meteorological observations and various mathematical models.

**3.6.11** Not all sources of aviation weather information are able to provide all three types of weather information. The FAA has determined that operators and pilots may utilize the following approved sources of aviation weather information:

**3.6.11.1 Federal Government.** The FAA and NWS collect raw weather data, analyze the observations, and produce forecasts. The FAA and NWS disseminate meteorological observations, analyses, and forecasts through a variety of systems. In addition, the Federal Government is the only approval authority for sources of weather

observations; for example, contract towers and airport operators may be approved by the Federal Government to provide weather observations.

**3.6.11.2 Enhanced Weather Information System (EWINS).** An EWINS is an FAA authorized, proprietary system for tracking, evaluating, reporting, and forecasting the presence or lack of adverse weather phenomena. The FAA authorizes a certificate holder to use an EWINS to produce flight movement forecasts, adverse weather phenomena forecasts, and other meteorological advisories. For more detailed information regarding EWINS, see the Aviation Weather Services Advisory Circular 00–45 and the Flight Standards Information Management System 8900.1.

**3.6.11.3 Commercial Weather Information Providers.** In general, commercial providers produce proprietary weather products based on NWS/FAA products with formatting and layout modifications but no material changes to the weather information itself. This is also referred to as “repackaging.” In addition, commercial providers may produce analyses, forecasts, and other proprietary weather products that substantially alter the information contained in government–produced products. However, those proprietary weather products that substantially alter government–produced weather products or information, may only be approved for use by 14 CFR Part 121 and Part 135 certificate holders if the commercial provider is EWINS qualified.

**NOTE–**

*Commercial weather information providers contracted by FAA to provide weather observations, analyses, and forecasts (e.g., contract towers) are included in the Federal Government category of approved sources by virtue of maintaining required technical and quality assurance standards under Federal Government oversight.*

**3.7 Graphical Forecasts for Aviation (GFA)**

**3.7.1** The GFA website is intended to provide the necessary aviation weather information to give users a complete picture of the weather that may affect flight in the continental United States (CONUS). The website includes observational data, forecasts, and warnings that can be viewed from 14 hours in the past to 15 hours in the future, including thunderstorms, clouds, flight category, precipitation, icing, turbulence, and wind. Hourly model data and forecasts, including information on clouds, flight category, precipitation, icing, turbulence, wind, and graphical output from the National Weather Service’s (NWS) National Digital Forecast Data (NDFD) are available. Wind, icing, and turbulence forecasts are available in 3,000 ft increments from the surface up to 30,000 ft MSL, and in 6,000 ft increments from 30,000 ft MSL to 48,000 ft MSL. Turbulence forecasts are also broken into low (below 18,000 ft MSL) and high (at or above 18,000 ft MSL) graphics. A maximum icing graphic and maximum wind velocity graphic (regardless of altitude) are also available. Built with modern geospatial information tools, users can pan and zoom to focus on areas of greatest interest. Target users are commercial and general aviation pilots, operators, briefers, and dispatchers.

**3.7.2 Weather Products.**

**3.7.2.1** The Aviation Forecasts include gridded displays of various weather parameters as well as NWS textual weather observations, forecasts, and warnings. Icing, turbulence, and wind gridded products are three–dimensional. Other gridded products are two–dimensional and may represent a “composite” of a three–dimensional weather phenomenon or a surface weather variable, such as horizontal visibility. The following are examples of aviation forecasts depicted on the GFA:

- a) Terminal Aerodrome Forecast (TAF)
- b) Ceiling & Visibility (CIG/VIS)
- c) Clouds
- d) Precipitation / Weather (PCPN/WX)
- e) Thunderstorm (TS)
- f) Winds
- g) Turbulence

h) Ice

**3.7.2.2 Observations & Warnings (Obs/Warn).** The Obs/Warn option provides an option to display weather data for the current time and the previous 14 hours (rounded to the nearest hour). Users may advance through time using the arrow buttons or by clicking on the desired hour. Provided below are the Obs/Warn product tabs available on the GFA website:

- a) METAR
- b) Precipitation/Weather (PCPN/WX)
- c) Ceiling & Visibility (CIG/VIS)
- d) Pilot Weather Report (PIREP)
- e) Radar & Satellite (RAD/SAT)

**3.7.2.3** The GFA will be continuously updated and available online at <http://aviationweather.gov/gfa>. Upon clicking the link above, select INFO on the top right corner of the map display. The next screen presents the option of selecting Overview, Products, and Tutorial. Simply select the tab of interest to explore the enhanced digital and graphical weather products designed to replace the legacy FA. Users should also refer to AC 00–45, *Aviation Weather Services*, for more detailed information on the GFA.

**3.7.2.4 GFA Static Images.** Some users with limited internet connectivity may access static images via the Aviation Weather Center (AWC) at: <http://www.aviationweather.gov/gfa/plot>. There are two static graphical images available, titled *Aviation Cloud Forecast* and *Aviation Surface Forecast*. The Aviation Cloud Forecast provides cloud coverage, bases, layers, tops with AIRMETS for mountain obscuration, and AIRMETS for icing overlaid. The Aviation Surface Forecast provides visibility, weather phenomena, and winds (including wind gusts) with AIRMETS for instrument flight rules conditions and AIRMETS for sustained surface winds of 30 knots or more overlaid. These images are presented on ten separate maps providing forecast views for the entire contiguous United States (U.S.) on one and nine regional views which provide more detail for the user. They are updated every 3 hours and provide forecast snapshots for 3, 6, 9, 12, 15, and 18 hours into the future. (See FIG GEN 3.5–2 and FIG GEN 3.5–3.)

**NOTE–**

*The contiguous United States (U.S.) refers to the 48 adjoining U.S. states on the continent of North America that are south of Canada and north of Mexico, plus the District of Columbia. The term excludes the states of Alaska, Hawaii, and all off-shore U.S. territories and possessions, such as Puerto Rico.*



FIG GEN 3.5-2  
Aviation Surface Forecast

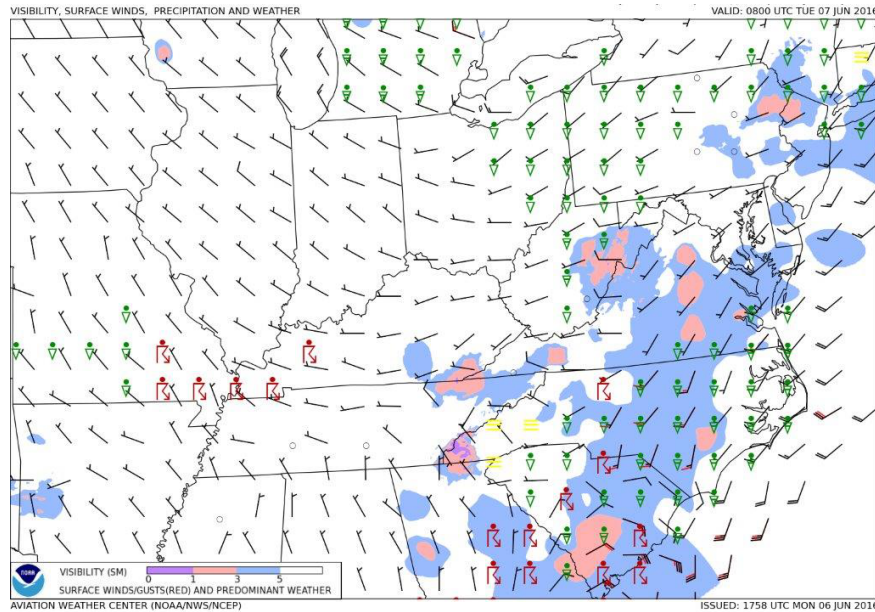
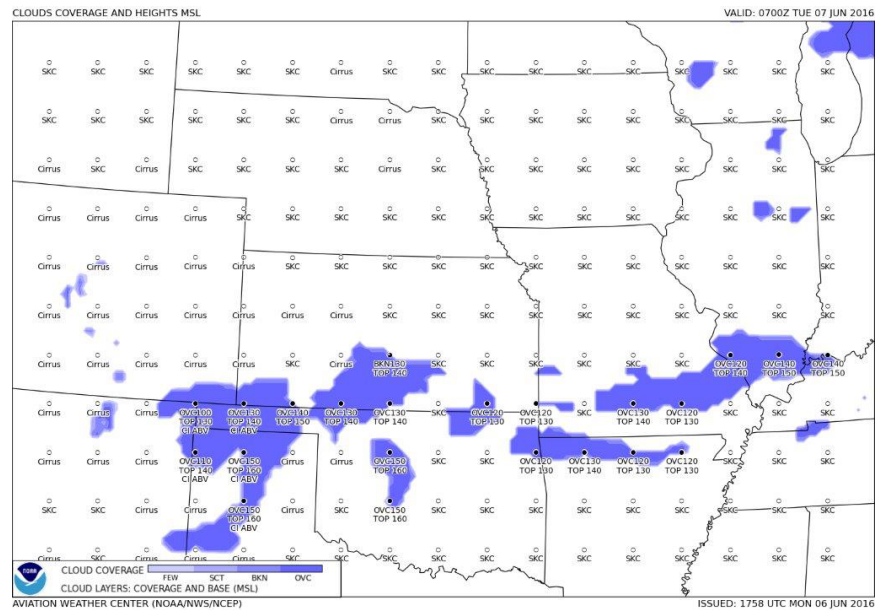


FIG GEN 3.5-3  
Aviation Cloud Forecast



### 3.8 Preflight Briefing

**3.8.1** Flight Service is one of the primary sources for obtaining preflight briefings and to file flight plans by phone or the Internet. Flight Service Specialists are qualified and certificated as Pilot Weather Briefers by the FAA. They are not authorized to make original forecasts, but are authorized to translate and interpret available forecasts and reports directly into terms describing the weather conditions which you can expect along your flight route and at your destination. Prior to every flight, pilots should gather all information vital to the nature of the flight. Pilots can receive a regulatory compliant briefing without contacting Flight Service. Pilots are encouraged

to use automated resources and review AC 91–92, Pilot’s Guide to a Preflight Briefing, for more information. Pilots who prefer to contact Flight Service are encouraged to conduct a self–brief prior to calling. Conducting a self–brief before contacting Flight Service provides familiarity of meteorological and aeronautical conditions applicable to the route of flight and promotes a better understanding of weather information.

Three basic types of preflight briefings (Standard, Abbreviated, and Outlook) are available to serve the pilot’s specific needs. Pilots should specify to the briefer the type of briefing they want, along with their appropriate background information. This will enable the briefer to tailor the information to the pilot’s intended flight. The following paragraphs describe the types of briefings available and the information provided in each briefing.

**3.8.2 Standard Briefing.** You should request a Standard Briefing any time you are planning a flight and you have not received a previous briefing or have not received preliminary information through online resources. International data may be inaccurate or incomplete. If you are planning a flight outside of U.S. controlled airspace, the briefer will advise you to check data as soon as practical after entering foreign airspace, unless you advise that you have the international cautionary advisory. The briefer will automatically provide the following information in the sequence listed, except as noted, when it is applicable to your proposed flight.

**3.8.2.1 Adverse Conditions.** Significant meteorological and/or aeronautical information that might influence the pilot to alter or cancel the proposed flight; for example, hazardous weather conditions, airport closures, air traffic delays, etc. Pilots should be especially alert for current or forecast weather that could reduce flight minimums below VFR or IFR conditions. Pilots should also be alert for any reported or forecast icing if the aircraft is not certified for operating in icing conditions. Flying into areas of icing or weather below minimums could have disastrous results.

**3.8.2.2 VFR Flight Not Recommended.** When VFR flight is proposed and sky conditions or visibilities are present or forecast, surface or aloft, that, in the briefer’s judgment, would make flight under VFR doubtful, the briefer will describe the conditions, describe the affected locations, and use the phrase “*VFR flight not recommended.*” This recommendation is advisory in nature. The final decision as to whether the flight can be conducted safely rests solely with the pilot. Upon receiving a “*VFR flight not recommended*” statement, the non–IFR rated pilot will need to make a “go or no go” decision. This decision should be based on weighing the current and forecast weather conditions against the pilot’s experience and ratings. The aircraft’s equipment, capabilities and limitations should also be considered.

**NOTE–**

*Pilots flying into areas of minimal VFR weather could encounter unforecasted lowering conditions that place the aircraft outside the pilot’s ratings and experience level. This could result in spatial disorientation and/or loss of control of the aircraft.*

**3.8.2.3 Synopsis.** A brief statement describing the type, location, and movement of weather systems and/or air masses which might affect the proposed flight.

**NOTE–**

*The first 3 elements of a standard briefing may be combined in any order when the briefer believes it will help to describe conditions more clearly.*

**3.8.2.4 Current Conditions.** Reported weather conditions applicable to the flight will be summarized from all available sources; e.g., METARs, PIREPs, RAREPs. This element may be omitted if the proposed time of departure is beyond two hours, unless the information is specifically requested by the pilot. For more detailed information on PIREPS, users can refer to the current version of AC 00–45, Aviation Weather Services.

**3.8.2.5 En Route Forecast.** En route conditions forecast for the proposed route are summarized in logical order; i.e., departure–climbout, en route, and descent.

**3.8.2.6 Destination Forecast.** The destination forecast (TAF) for the planned estimated time of arrival (ETA). Any significant changes within 1 hour before and after the planned arrival are included.

**3.8.2.7 Winds Aloft.** Forecast winds aloft for the proposed route will be provided using degrees of the compass. The briefer will interpolate wind directions and speeds between levels and stations as necessary to provide expected conditions at planned altitudes.

### 3.8.2.8 Notices to Air Missions (NOTAMs)

a) Available NOTAM (D) information pertinent to the proposed flight, including special use airspace (SUA) NOTAMs for restricted areas, aerial refueling, and night vision goggles (NVG).

**NOTE–**

*Other SUA NOTAMs (D), such as military operations area (MOA), military training route (MTR), and warning area NOTAMs, are considered “upon request” briefing items as indicated in paragraph 3.8.2.10.*

b) Prohibited Areas P–40, P–49, P–56, and the special flight rules area (SFRA) for Washington, DC.

**NOTE–**

*For information on SFRA, see ENR 5, Navigation Warnings, paragraph 2.4.2.*

c) FSS briefers do not provide FDC NOTAM information for special instrument approach procedures unless specifically asked. Pilots authorized by the FAA to use special instrument approach procedures must specifically request FDC NOTAM information for these procedures.

**NOTE–**

1. *NOTAM information may be combined with current conditions when the briefer believes it is logical to do so.*

2. *Airway NOTAMs, procedural NOTAMs, and NOTAMs that are general in nature and not tied to a specific airport/facility (for example, flight advisories and restrictions, open duration special security instructions, and special flight rules areas) are briefed solely by pilot request. NOTAMs, graphic notices, and other information published in the Domestic Notices and International Notices are not included in pilot briefings unless the pilot specifically requests a review of these notices. For complete flight information, pilots are urged to review the Domestic Notices and International Notices found in the External Links section of the Federal NOTAM System (FNS) NOTAM Search or Air Traffic Plans and Publications website and the Chart Supplement U.S. in addition to obtaining a briefing.*

**3.8.2.9 Air Traffic Control (ATC) Delays.** Any known ATC delays and flow control advisories which might affect the proposed flight.

### 3.8.2.10 Pilots may obtain the following from flight service station briefers upon request:

a) Information on Special Use Airspace (SUA) and SUA related airspace, except those listed in paragraph 3.8.2.8.

**NOTE–**

1. *For the purpose of this paragraph, SUA and related airspace includes the following types of airspace: alert area, military operations area (MOA), warning area, and air traffic control assigned airspace (ATCAA). MTR data includes the following types of airspace: IFR training routes (IR), VFR training routes (VR), and slow training routes (SR).*

2. *Pilots are encouraged to request updated information from ATC facilities while in flight.*

b) A review of airway NOTAMs, procedural NOTAMs, and NOTAMs that are general in nature and not tied to a specific airport/facility (for example, flight advisories and restrictions, open duration special security instructions, and special flight rules areas), Domestic Notices and International Notices. Domestic Notices and International Notices are found in the External Links section of the Federal NOTAM System (FNS) NOTAM Search System.

c) Approximate density altitude data.

d) Information regarding such items as air traffic services and rules, customs/immigration procedures, ADIZ rules, and search and rescue.

e) NOTAMs, available military NOTAMs, runway friction measurement value NOTAMs.

f) GPS RAIM availability for 1 hour before to 1 hour after ETA, or a time specified by the pilot.

g) Other assistance as required.

**3.8.3 Abbreviated Briefing.** Request an Abbreviated Briefing when you need information to supplement mass disseminated data, to update a previous briefing, or when you need only one or two specific items. Provide the briefer with appropriate background information, the time you received the previous information, and/or the

specific items needed. You should indicate the source of the information already received so that the briefer can limit the briefing to the information that you have not received, and/or appreciable changes in meteorological/aeronautical conditions since your previous briefing. To the extent possible, the briefer will provide the information in the sequence shown for a Standard Briefing. If you request only one or two specific items, the briefer will advise you if adverse conditions are present or forecast. Adverse conditions contain both meteorological and aeronautical information. Details on these conditions will be provided at your request.

**3.8.4 Outlook Briefing.** You should request an Outlook Briefing whenever your proposed time of departure is 6 or more hours from the time of the briefing. The briefer will provide available forecast data applicable to the proposed flight. This type of briefing is provided for planning purposes only. You should obtain a Standard or Abbreviated Briefing prior to departure in order to obtain such items as adverse conditions, current conditions, updated forecasts, winds aloft, and NOTAMs.

**3.8.5 Inflight Briefing.** You are encouraged to conduct a self-briefing using online resources or obtain your preflight briefing by telephone or in person before departure (Alaska only). In those cases where you need to obtain a preflight briefing or an update to a previous briefing by radio, you should contact the nearest FSS to obtain this information. After communications have been established, advise the specialist of the type briefing you require and provide appropriate background information. You will be provided information as specified in the above paragraphs, depending on the type of briefing requested. En Route advisories tailored to the phase of flight that begins after climb-out and ends with descent to land are provided upon pilot request. Besides flight service, there are other resources available to the pilot inflight, including:

*Automatic Dependent Surveillance–Broadcast (ADS–B).* Free traffic, weather, and flight information are available on ADS–B In receivers that can receive data over 978 MHz (UAT) broadcasts. These services are available across the nation to aircraft owners who equip with ADS–B In, with further advances coming from airborne and runway traffic awareness. Even search-and-rescue operations benefit from accurate ADS–B tracking.

*Flight Information Services–Broadcast (FIS–B).* FIS–B is a free service; but is only available to aircraft who can receive data over 978 MHz (UAT). FIS–B automatically transmits a wide range of weather products with national and regional focus to all equipped aircraft. Having current weather and aeronautical information in the cockpit helps pilots plan more safe and efficient flight paths, as well as make strategic decisions during flight to avoid potentially hazardous weather.

Pilots are encouraged to provide a continuous exchange of information on weather, winds, turbulence, flight visibility, icing, etc., between pilots and inflight specialists. Pilots should report good weather as well as bad, and confirm expected conditions as well as unexpected. Remember that weather conditions can change rapidly and that a “go or no go” decision, as mentioned in paragraph 3.8.2.2, should be assessed at all phases of flight.

**3.8.6** Following any briefing, feel free to ask for any information that you or the briefer may have missed. It helps to save your questions until the briefing has been completed. This way the briefer is able to present the information in a logical sequence and lessens the chance of important items being overlooked.

## **3.9 Inflight Aviation Weather Advisories**

**3.9.1** Inflight Aviation Weather Advisories are forecasts to advise en route aircraft of development of potentially hazardous weather. Inflight aviation weather advisories in the conterminous U.S. are issued by the Aviation Weather Center (AWC) in Kansas City, MO, as well as 20 Center Weather Service Units (CWSU) associated with ARTCCs. AWC also issues advisories for portions of the Gulf of Mexico, Atlantic and Pacific Oceans, which are under the control of ARTCCs with Oceanic flight information regions (FIRs). The Weather Forecast Office (WFO) in Honolulu issues advisories for the Hawaiian Islands and a large portion of the Pacific Ocean. In Alaska, the Alaska Aviation Weather Unit (AAWU) issues inflight aviation weather advisories along with the Anchorage CWSU. All heights are referenced MSL, except in the case of ceilings (CIG) which indicate AGL.

**3.9.2** There are four types of inflight aviation weather advisories: the SIGMET, the Convective SIGMET, the AIRMET, and the Center Weather Advisory (CWA). All of these advisories use VORs, airports, or well-known geographic areas to describe the hazardous weather areas.

**3.9.3** The Severe Weather Watch Bulletins (WWs), (with associated Alert Messages) (AWW) supplements these Inflight Aviation Weather Advisories.

**3.9.4 SIGMET.** A SIGMET is a concise description of the occurrence or expected occurrence of specified en route weather phenomena which is expected to affect the safety of aircraft operations.

**3.9.4.1 SIGMETs:**

- a) Are intended for dissemination to all pilots in flight to enhance safety.
- b) Are issued by the responsible MWO as soon as it is practical to alert operators and aircrews of hazardous en route conditions.
- c) Are unscheduled products that are valid for 4 hours; except SIGMETs associated with tropical cyclones and volcanic ash clouds are valid for 6 hours. Unscheduled updates and corrections are issued as necessary.
- d) Use geographical points to describe the hazardous weather areas. These points can reference either VORs, airports, or latitude-longitude depending on SIGMET location. If the total area to be affected during the forecast period is very large, it could be that in actuality only a small portion of this total area would be affected at any one time.

**EXAMPLE–**

*Example of a SIGMET:*

*BOSR WS 050600*

*SIGMET ROMEO 2 VALID UNTIL 051000*

*ME NH VT*

*FROM CAR TO YSJ TO CON TO MPV TO CAR*

*OCNL SEV TURB BLW 080 EXP DUE TO STG NWLY FLOW. CONDS CONTG BYD 1000Z.*

**3.9.4.2 SIGMETs over the contiguous U.S.:**

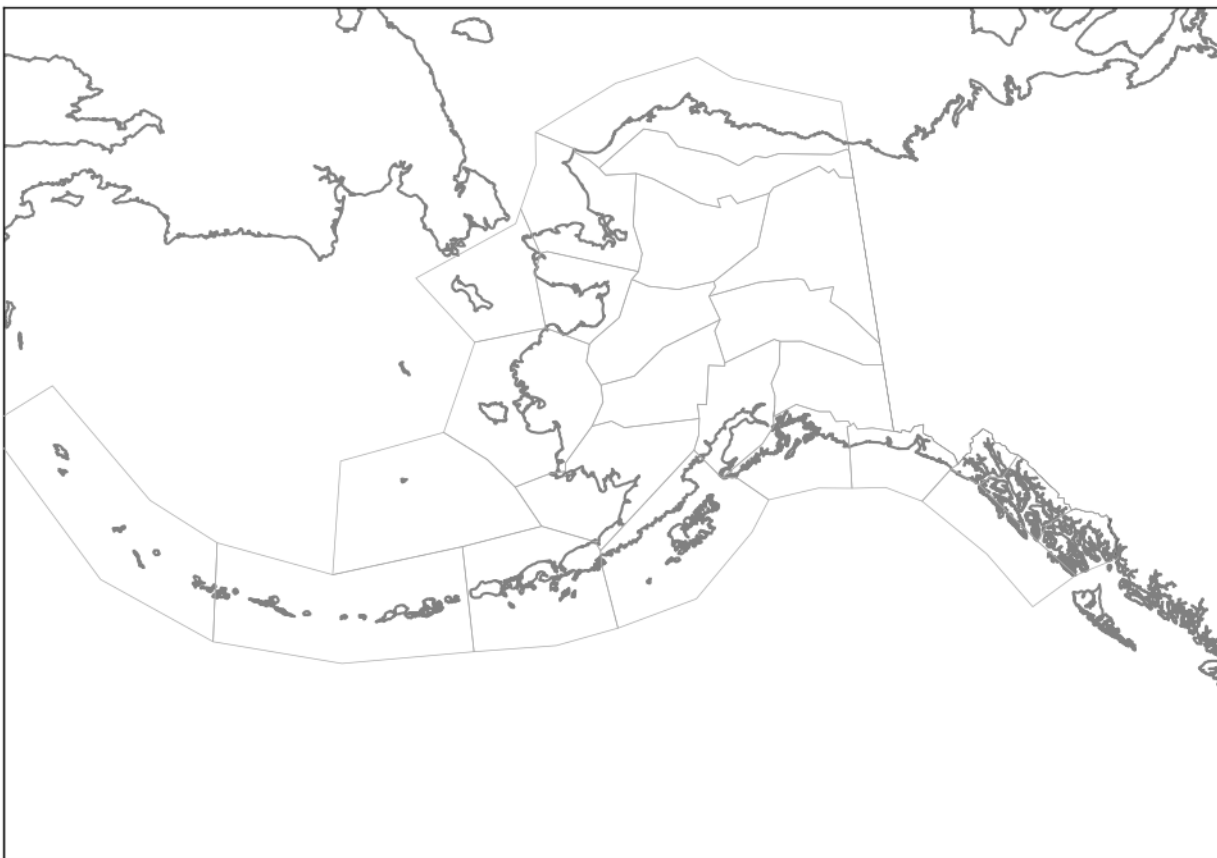
- a) Are issued corresponding to the areas described in FIG GEN 3.5–5 and are only for non-convective weather. The U.S. issues a special category of SIGMETs for convective weather called Convective SIGMETs.
- b) Are identified by an alphabetic designator, from November through Yankee, excluding Sierra and Tango. Issuance for the same phenomenon will be sequentially numbered using the original designator until the phenomenon ends. For example, the first issuance in the Chicago (CHI) area (reference FIG GEN 3.5–5) for phenomenon moving from the Salt Lake City (SLC) area will be SIGMET Papa 3, if the previous two issuances, Papa 1 and Papa 2, had been in the SLC area. Note that no two different phenomena across the country can have the same alphabetic designator at the same time.
- c) Use location identifiers (either VORs or airports) to describe the hazardous weather areas.
- d) Are issued when the following phenomena occur or are expected to occur:
  - 1) Severe icing not associated with thunderstorms.
  - 2) Severe or extreme turbulence or clear air turbulence (CAT) not associated with thunderstorms.
  - 3) Widespread dust storms or sandstorms lowering surface visibilities to below 3 miles.
  - 4) Volcanic ash.

**3.9.4.3 SIGMETs over Alaska:**

- a) Are issued for the Anchorage FIR including Alaska and nearby coastal waters corresponding to the areas described in FIG GEN 3.5–4 and are only for non-convective weather. The U.S. issues a special category of SIGMETs for convective weather called Convective SIGMETs.

- b) Use location identifiers (either VORs or airports) to describe the hazardous weather areas.
- c) Use points of latitude and longitude over the ocean areas of the Alaska FIR.
- d) Are identified by an alphabetic designator from India through Mike.
- e) In addition to the phenomenon applicable to SIGMETs over the contiguous U.S., SIGMETs over Alaska are also issued for:
  - 1) Tornadoes.
  - 2) Lines of thunderstorms.
  - 3) Embedded thunderstorms.
  - 4) Hail greater than or equal to 3/4 inch in diameter.

FIG GEN 3.5-4  
Alaska SIGMET and Area Forecast Zones



**3.9.4.4** SIGMETs over oceanic regions (New York Oceanic FIR, Oakland Oceanic FIR including Hawaii, Houston Oceanic FIR, Miami Oceanic FIR, San Juan FIR), points of latitude and longitude are used to describe the hazard area.

- a) SIGMETs over the Oakland Oceanic FIR west of 140 west and south of 30 north (including the Hawaiian Islands), are identified by an alphabetic designator from November through Zulu.
- b) SIGMETs over the Oakland Oceanic FIR east of 140 west and north of 30 north are identified by an alphabetic designator from Alpha through Mike.
- c) SIGMETs over the New York Oceanic FIR, Houston Oceanic FIR, Miami Oceanic FIR, and San Juan FIR are identified by an alphabetic designator from Alpha through Mike.

d) In addition to SIGMETs issued for the phenomenon for the contiguous U.S., SIGMETs in the oceanic regions are also issued for:

- 1) Tornadoes.
- 2) Lines of thunderstorms.
- 3) Embedded thunderstorms.
- 4) Hail greater than or equal to  $\frac{3}{4}$  inch in diameter.

### 3.9.5 Convective SIGMET

3.9.5.1 Convective SIGMETs are issued in the conterminous U.S. for any of the following:

- a) Severe thunderstorm due to:
  - 1) Surface winds greater than or equal to 50 knots.
  - 2) Hail at the surface greater than or equal to  $\frac{3}{4}$  inches in diameter.
  - 3) Tornadoes.
- b) Embedded thunderstorms.
- c) A line of thunderstorms.

d) Thunderstorms producing precipitation greater than or equal to heavy precipitation affecting 40 percent or more of an area at least 3,000 square miles.

3.9.5.2 Any convective SIGMET implies severe or greater turbulence, severe icing, and low-level wind shear. A convective SIGMET may be issued for any convective situation that the forecaster feels is hazardous to all categories of aircraft.

3.9.5.3 Convective SIGMET bulletins are issued for the western (W), central (C), and eastern (E) United States. (Convective SIGMETs are not issued for Alaska or Hawaii.) The areas are separated at 87 and 107 degrees west longitude with sufficient overlap to cover most cases when the phenomenon crosses the boundaries. Bulletins are issued hourly at H+55. Special bulletins are issued at any time as required and updated at H+55. If no criteria meeting convective SIGMET requirements are observed or forecasted, the message "CONVECTIVE SIGMET... NONE" will be issued for each area at H+55. Individual convective SIGMETs for each area (W, C, E) are numbered sequentially from number one each day, beginning at 00Z. A convective SIGMET for a continuing phenomenon will be reissued every hour at H+55 with a new number. The text of the bulletin consists of either an observation and a forecast or just a forecast. The forecast is valid for up to 2 hours.

**EXAMPLE-**

*CONVECTIVE SIGMET 44C*

*VALID UNTIL 1455Z*

*AR TX OK*

*FROM 40NE ADM-40ESE MLC-10W TXK-50WNW LFK-40ENE SJT-40NE ADM*

*AREA TS MOV FROM 26025KT. TOPS ABV FL450.*

*OUTLOOK VALID 061455-061855*

*FROM 60WSW OKC-MLC-40N TXK-40WSW IGB-VUZ-MGM-HRV-60S BTR-40N*

*IAH-60SW SJT-40ENE LBB-60WSW OKC*

*WST ISSUANCES EXPD. REFER TO MOST RECENT ACUS01 KWNS FROM STORM PREDICTION CENTER FOR SYNOPSIS AND METEOROLOGICAL DETAILS*

FIG GEN 3.5-5  
SIGMET Locations – Contiguous U.S.

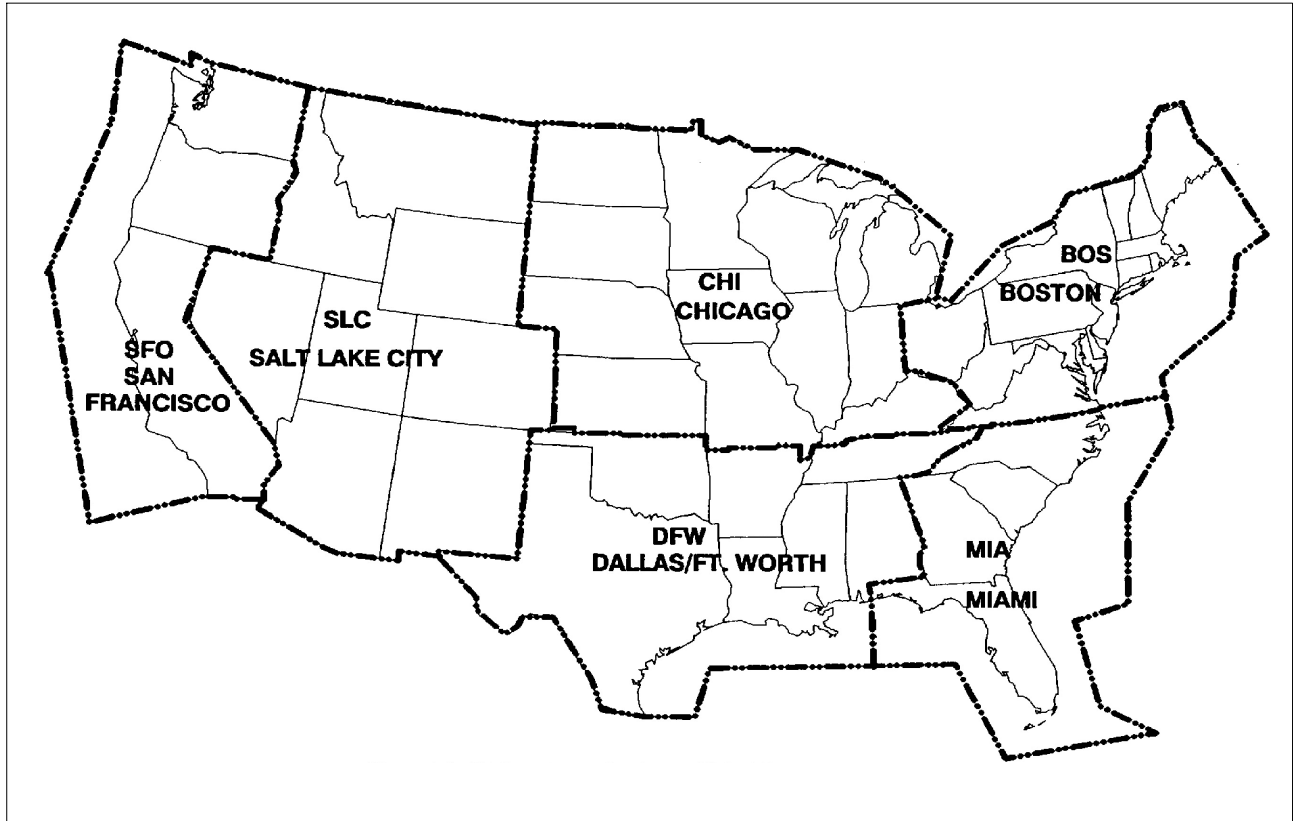
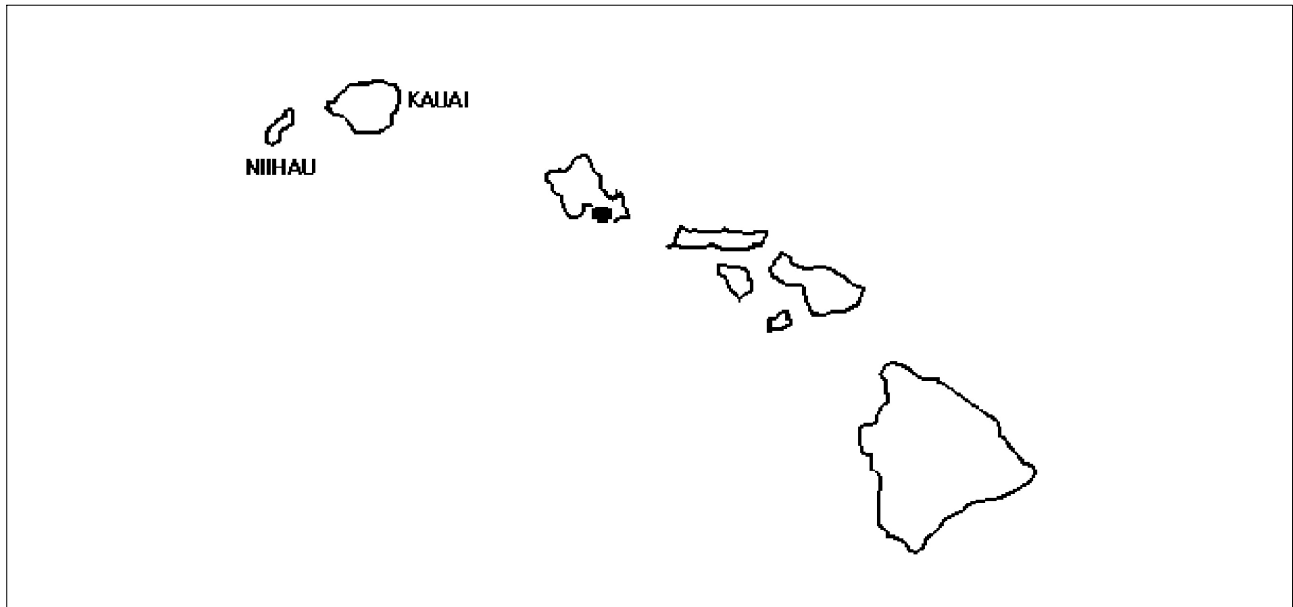


FIG GEN 3.5-6  
Hawaii Area Forecast Locations



**3.9.6 AIRMET.** An AIRMET is a concise description of the occurrence or expected occurrence of specified en route weather phenomena that may affect the safety of aircraft operations, but at intensities lower than those which require the issuance of a SIGMET.



**3.9.6.1** AIRMETS contain details about Instrument Flight Rule (IFR) conditions, extensive mountain obscuration, turbulence, strong surface winds, icing, and freezing levels. Unscheduled updates and corrections are issued as necessary.

**3.9.6.2** AIRMETS:

- a) Are intended to inform all pilots, but especially Visual Flight Rules pilots and operators of sensitive aircraft, of potentially hazardous weather phenomena.
- b) Are issued on a scheduled basis every 6 hours, except every 8 hours in Alaska. Unscheduled updates and corrections are issued as necessary.
- c) Are intended for dissemination to all pilots in the preflight and en route phase of flight to enhance safety. En route, AIRMETS are available over Flight Service frequencies. Over the contiguous U.S., AIRMETS are also available on equipment intended to display weather and other non-air traffic control-related flight information to pilots using the Flight Information Service–Broadcast (FIS–B). In Alaska and Hawaii, AIRMETS are broadcast on air traffic frequencies.
- d) Are issued for the contiguous U.S., Alaska, and Hawaii. No AIRMETS are issued for U.S. Oceanic FIRs in the Gulf of Mexico, Caribbean, Western Atlantic and Pacific Oceans.

*TBL GEN 3.5–3*  
**U.S. AIRMET Issuance Time and Frequency**

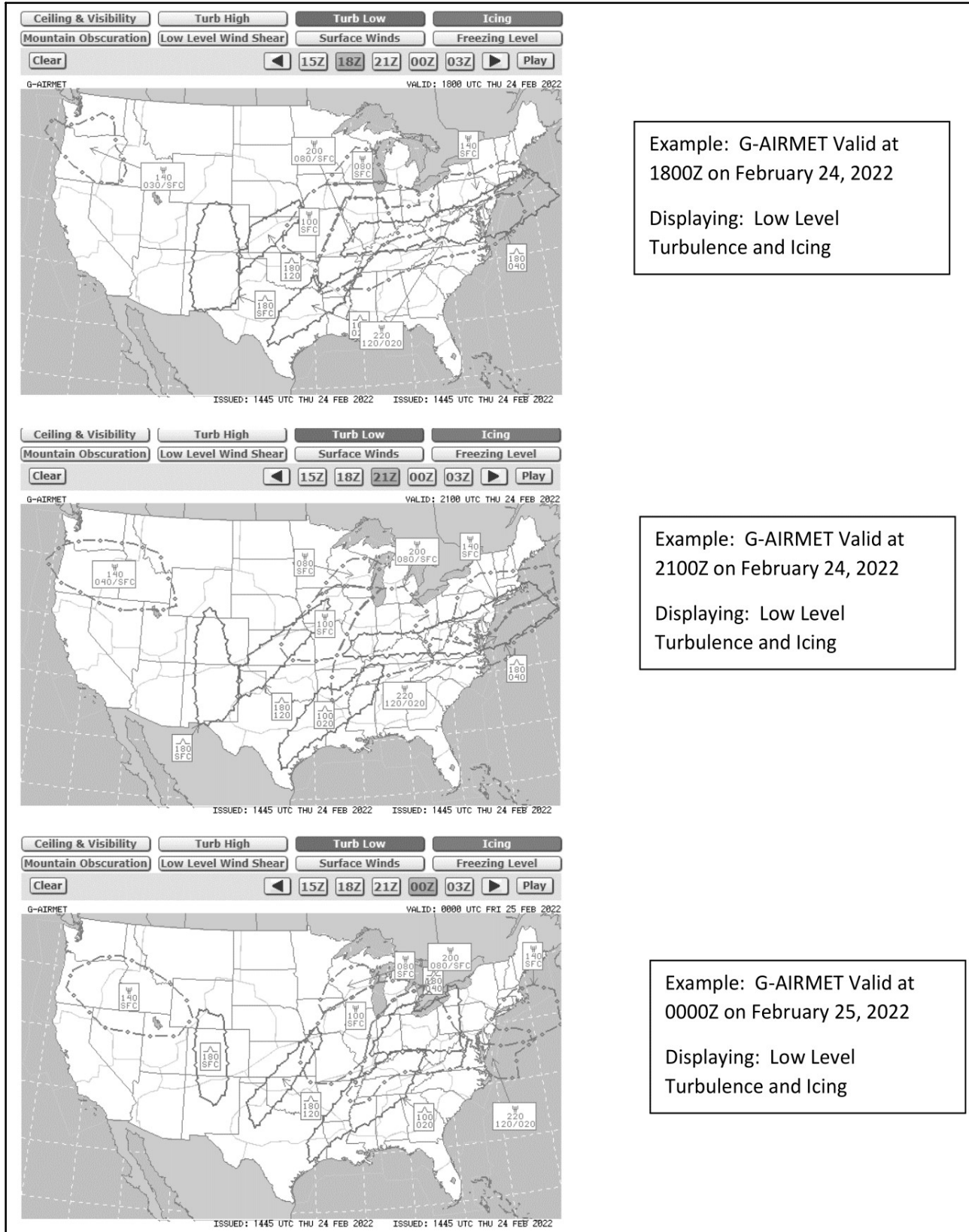
Product Type	Issuance Time	Issuance Frequency
AIRMETS over the Contiguous U.S.	0245, 0845, 1445, 2045 UTC	Every 6 hours
AIRMETS over Alaska	0515, 1315, 2115 UTC (standard time) 0415, 1215, 2015 UTC (Daylight savings time)	Every 8 hours
AIRMETS over Hawaii	0400, 1000, 1600, 2200 UTC	Every 6 hours

**3.9.6.3** AIRMETS over the Contiguous U.S.:

- a) Are displayed graphically on websites, such as aviationweather.gov and 1800wxbrief.com, and equipment receiving FIS–B information.
- b) Provide a higher forecast resolution than AIRMETS issued in text format.
- c) Are valid at discrete times no more than 3 hours apart for a period of up to 12 hours into the future (for example; 00, 03, 06, 09, and 12 hours). Additional forecasts may be inserted during the first 6 hours (for example; 01, 02, 04, and 05). 00-hour represents the initial conditions, and the subsequent graphics depict the area affected by the particular hazard at that valid time. Forecasts valid at 00 through 06 hours correspond to the text AIRMET bulletin.
- d) Depict the following en route aviation weather hazards:
  - 1) Instrument flight rule conditions (ceiling < 1000' and/or surface visibility <3 miles).
  - 2) Widespread mountain obscuration.
  - 3) Moderate icing.
  - 4) Freezing levels.
  - 5) Moderate turbulence.
  - 6) Non-convective low-level wind shear potential below 2,000 feet AGL.
  - 7) Sustained surface winds greater than 30 knots.

**3.9.6.4** Interpolation of time periods between AIRMETs over the contiguous U.S. valid times: Users must keep in mind when using the AIRMET over the contiguous U.S. that if a 00-hour forecast shows no significant weather and a 03-hour forecast shows hazardous weather, they must assume a change is occurring during the period between the two forecasts. It should be taken into consideration that the hazardous weather starts immediately after the 00-hour forecast unless there is a defined initiation or ending time for the hazardous weather. The same would apply after the 03-hour forecast. The user should assume the hazardous weather condition is occurring between the snapshots unless informed otherwise. For example, if a 00-hour forecast shows no hazard, a 03-hour forecast shows the presence of hazardous weather, and a 06-hour forecast shows no hazard, the user should assume the hazard exists from the 0001 hour to the 0559 hour time period.

FIG GEN 3.5-7  
AIRMETs over the Contiguous U.S.



**3.9.6.5** AIRMETs over Alaska and Hawaii:

a) AIRMETs over Alaska and Hawaii are in text format. The hazard areas are described using well-known geographical areas. AIRMETs over Alaska are issued for three Alaskan regions corresponding to Alaska area forecasts (See FIG GEN 3.5–4).

b) AIRMETs over Alaska are valid up to eight hours. AIRMETs over Hawaii are valid up to six hours. Unscheduled issuances contain an update number for easier identification.

c) AIRMET Zulu describes moderate icing and provides freezing level heights.

**EXAMPLE–**

*Example of AIRMET Sierra issued for the Southeast Alaska area:*

WAAK47 PAWU 241324  
WA70  
JNUS WA 241315  
AIRMET SIERRA FOR IFR AND MT OBSC VALID UNTIL 242115

LYNN CANAL AND GLACIER BAY JB  
MTS OBSC BY CLDS/ISOL PCPN. NC.

CNTRL SE AK JC  
MTS OCNL OBSC IN CLDS. NC.

SRN SE AK JD  
PAWG–PAKT LN W OCNL CIGS BLW 010/VIS BLW 3SM BR. IMPR.

ERN GLF CST JE  
OCNL CIGS BLW 010/VIS BLW 3SM BR/–RA BR. DTRT.

=JNUT WA 241315  
AIRMET TANGO FOR TURB/STG SFC WINDS VALID UNTIL 242115

ERN GLF CST JE  
OF SHR ICY BAY W SUSTAINED SFC WND 30 KTS  
OR GTR. SPRDG E. INTSF.

=JNUZ WA 241315  
AIRMET ZULU FOR ICING VALID UNTIL 242115

ERN GLF CST JE  
16Z TO 19Z ALG CST W ICY BAY OCNL MOD ICEIC 080–160.  
FZLVL 045 EXC 015 INLAND. WKN.

**EXAMPLE–**

*Example of AIRMET Tango issued for Hawaii FA area:*

WAHW31 PHFO 241529  
WA0HI

HNLS WA 241600  
AIRMET SIERRA UPDATE 2 FOR IFR VALID UNTIL 242200

NO SIGNIFICANT IFR EXP.

=HNLT WA 241600  
AIRMET TANGO UPDATE 3 FOR TURB VALID UNTIL 242200

*AIRMET TURB...HI  
OVER AMD IMT S THRU W OF MTN.  
TEMPO MOD TURB BLW 070.  
COND CONT BEYOND 2200Z.*

*=HNLZ WA 241600  
AIRMET ZULU UPDATE 2 FOR ICE AND FZLVL VALID UNTIL 242200  
NO SIGNIFICANT ICE EXP*

### **3.9.7 Watch Notification Messages**

The Storm Prediction Center (SPC) in Norman, OK, issues Watch Notification Messages to provide an area threat alert for forecast organized severe thunderstorms that may produce tornadoes, large hail, and/or convective damaging winds within the CONUS. SPC issues three types of watch notification messages: Aviation Watch Notification Messages, Public Severe Thunderstorm Watch Notification Messages, and Public Tornado Watch Notification Messages.

It is important to note the difference between a Severe Thunderstorm (or Tornado) Watch and a Severe Thunderstorm (or Tornado) Warning. A watch means severe weather is possible during the next few hours, while a warning means that severe weather has been observed, or is expected within the hour. Only the SPC issues Severe Thunderstorm and Tornado Watches, while only NWS Weather Forecasts Offices issue Severe Thunderstorm and Tornado Warnings.

**3.9.7.1** The Aviation Watch Notification Message. The Aviation Watch Notification Message product is an approximation of the area of the Public Severe Thunderstorm Watch or Public Tornado Watch. The area may be defined as a rectangle or parallelogram using VOR navigational aides as coordinates.

The Aviation Watch Notification Message was formerly known as the Alert Severe Weather Watch Bulletin (AWW). The NWS no longer uses that title or acronym for this product. The NWS uses the acronym SAW for the Aviation Watch Notification Message, but retains AWW in the product header for processing by weather data systems.

#### **EXAMPLE–**

##### **Example of an Aviation Watch Notification Message:**

*WWUS30 KWNS 271559  
SAW2  
SPC AWW 271559  
WW 568 TORNADO AR LA MS 271605Z - 280000Z  
AXIS..65 STATUTE MILES EAST AND WEST OF LINE..  
45ESE HEZ/NATCHEZ MS/ - 50N TUP/TUPELO MS/  
..AVIATION COORDS.. 55NM E/W /18WNW MCB - 60E MEM/  
HAIL SURFACE AND ALOFT..3 INCHES. WIND GUSTS..70 KNOTS. MAX TOPS TO 550. MEAN STORM MOTION  
VECTOR 26030.  
LAT..LON 31369169 34998991 34998762 31368948  
THIS IS AN APPROXIMATION TO THE WATCH AREA. FOR A COMPLETE DEPICTION OF THE WATCH SEE  
WOUS64 KWNS FOR WOU2.*

**3.9.7.2** Public Severe Thunderstorm Watch Notification Messages describe areas of expected severe thunderstorms. (Severe thunderstorm criteria are 1-inch hail or larger and/or wind gusts of 50 knots [58 mph] or greater). A Public Severe Thunderstorm Watch Notification Message contains the area description and axis, the watch expiration time, a description of hail size and thunderstorm wind gusts expected, the definition of the watch, a call to action statement, a list of other valid watches, a brief discussion of meteorological reasoning and technical information for the aviation community.

**3.9.7.3** Public Tornado Watch Notification Messages describe areas where the threat of tornadoes exists. A Public Tornado Watch Notification Message contains the area description and axis, watch expiration time, the term “damaging tornadoes,” a description of the largest hail size and strongest thunderstorm wind gusts expected, the definition of the watch, a call to action statement, a list of other valid watches, a brief discussion of

meteorological reasoning and technical information for the aviation community. SPC may enhance a Public Tornado Watch Notification Message by using the words “THIS IS A PARTICULARLY DANGEROUS SITUATION” when there is a likelihood of multiple strong (damage of EF2 or EF3) or violent (damage of EF4 or EF5) tornadoes.

**3.9.7.4** Public severe thunderstorm and tornado watch notification messages were formerly known as the Severe Weather Watch Bulletins (WW). The NWS no longer uses that title or acronym for this product but retains WW in the product header for processing by weather data systems.

**EXAMPLE-**

**Example of a Public Tornado Watch Notification Message:**

WWUS20 KWNS 050550

SEL2

SPC WW 051750

URGENT - IMMEDIATE BROADCAST REQUESTED

TORNADO WATCH NUMBER 243

NWS STORM PREDICTION CENTER NORMAN OK

1250 AM CDT MON MAY 5 2011

THE NWS STORM PREDICTION CENTER HAS ISSUED A

\*TORNADO WATCH FOR PORTIONS OF

WESTERN AND CENTRAL ARKANSAS

SOUTHERN MISSOURI

FAR EASTERN OKLAHOMA

\*EFFECTIVE THIS MONDAY MORNING FROM 1250 AM UNTIL 600 AM CDT.

...THIS IS A PARTICULARLY DANGEROUS SITUATION...

\*PRIMARY THREATS INCLUDE

NUMEROUS INTENSE TORNADOES LIKELY

NUMEROUS SIGNIFICANT DAMAGING WIND GUSTS TO 80 MPH LIKELY

NUMEROUS VERY LARGE HAIL TO 4 INCHES IN DIAMETER LIKELY

THE TORNADO WATCH AREA IS APPROXIMATELY ALONG AND 100 STATUTE MILES EAST AND WEST OF A LINE FROM 15 MILES WEST NORTHWEST OF FORT LEONARD WOOD MISSOURI TO 45 MILES SOUTHWEST OF HOT SPRINGS ARKANSAS. FOR A COMPLETE DEPICTION OF THE WATCH SEE THE ASSOCIATED WATCH OUTLINE UPDATE (WOUS64 KWNS WOU2).

REMEMBER...A TORNADO WATCH MEANS CONDITIONS ARE FAVORABLE FOR TORNADOES AND SEVERE THUNDERSTORMS IN AND CLOSE TO THE WATCH AREA. PERSONS IN THESE AREAS SHOULD BE ON THE LOOKOUT FOR THREATENING WEATHER CONDITIONS AND LISTEN FOR LATER STATEMENTS AND POSSIBLE WARNINGS.

OTHER WATCH INFORMATION...THIS TORNADO WATCH REPLACES TORNADO WATCH NUMBER 237. WATCH NUMBER 237 WILL NOT BE IN EFFECT AFTER

1250 AM CDT. CONTINUE... WW 239... WW 240... WW 241... WW 242...

DISCUSSION...SRN MO SQUALL LINE EXPECTED TO CONTINUE EWD...WHERE LONG/HOOKED HODOGRAPHS SUGGEST THREAT FOR EMBEDDED SUPERCELLS/POSSIBLE TORNADOES. FARTHER S...MORE WIDELY SCATTERED

SUPERCELLS WITH A THREAT FOR TORNADOES WILL PERSIST IN VERY STRONGLY DEEP SHEARED/LCL ENVIRONMENT IN AR.

AVIATION...TORNADOES AND A FEW SEVERE THUNDERSTORMS WITH HAIL SURFACE AND ALOFT TO 4 INCHES. EXTREME TURBULENCE AND SURFACE WIND GUSTS TO 70 KNOTS. A FEW CUMULONIMBI WITH MAXIMUM TOPS TO 500. MEAN STORM MOTION VECTOR 26045.

**3.9.7.5** Status reports are issued as needed to show progress of storms and to delineate areas no longer under the threat of severe storm activity. Cancellation bulletins are issued when it becomes evident that no severe weather will develop or that storms have subsided and are no longer severe.

**3.9.8 Center Weather Advisories (CWA)**

**3.9.8.1** CWAs are unscheduled inflight, flow control, air traffic, and air crew advisory. By nature of its short lead time, the CWA is not a flight planning product. It is generally a nowcast for conditions beginning within the next two hours. CWAs will be issued:

a) As a supplement to an existing SIGMET, Convective SIGMET or AIRMET.

b) When an Inflight Advisory has not been issued but observed or expected weather conditions meet SIGMET/AIRMET criteria based on current pilot reports and reinforced by other sources of information about existing meteorological conditions.

c) When observed or developing weather conditions do not meet SIGMET, Convective SIGMET, or AIRMET criteria; e.g., in terms of intensity or area coverage, but current pilot reports or other weather information sources indicate that existing or anticipated meteorological phenomena will adversely affect the safe flow of air traffic within the ARTCC area of responsibility.

**3.9.8.2** The following example is a CWA issued from the Kansas City, Missouri, ARTCC. The “3” after ZKC in the first line denotes this CWA has been issued for the third weather phenomena to occur for the day. The “301” in the second line denotes the phenomena number again (3) and the issuance number (01) for this phenomena. The CWA was issued at 2140Z and is valid until 2340Z.

**EXAMPLE–**

*ZKC3 CWA 032140*

*ZKC CWA 301 VALID UNTIL 032340*

*ISOLD SVR TSTM over KCOU MOVG SWWD 10 KTS ETC.*

## 4. Categorical Outlooks

**4.1** Categorical outlook terms describing general ceiling and visibility conditions for advance planning purposes are used only in area forecasts. They are defined as follows:

**4.1.1 LIFR (Low IFR).** Ceiling less than 500 feet and/or visibility less than 1 mile.

**4.1.2 IFR.** Ceiling 500 to less than 1,000 feet and/or visibility 1 to less than 3 miles.

**4.1.3 MVFR (Marginal VFR).** Ceiling 1,000 or 3,000 feet and/or visibility 3 to 5 miles inclusive.

**4.1.4 VFR.** Ceiling greater than 3,000 feet and visibility greater than 5 miles; includes sky clear.

**4.2** The cause of LIFR, IFR, or MVFR is indicated by either ceiling or visibility restrictions or both. The contraction “CIG” and/or weather and obstruction to vision symbols are used. If winds or gusts of 25 knots or greater are forecast for the outlook period, the word “WIND” is also included for all categories, including VFR.

**EXAMPLE–**

1. *LIFR CIG–low IFR due to low ceiling.*

2. *IFR FG–IFR due to visibility restricted by fog.*

3. *MVFR CIG HZ FU–marginal VFR due both to ceiling and to visibility restricted by haze and smoke.*

4. *IFR CIG RA WIND–IFR due both to low ceiling and to visibility restricted by rain; wind expected to be 25 knots or greater.*

## 5. Inflight Weather Advisory Broadcasts

ARTCCs broadcast a Convective SIGMET, SIGMET, AIRMET (except in the contiguous U.S.), Urgent Pilot Report, or CWA alert once on all frequencies, except emergency frequencies, when any part of the area described is within 150 miles of the airspace under their jurisdiction. These broadcasts advise pilots of the availability of hazardous weather advisories and to contact the nearest flight service facility for additional details.

**EXAMPLE–**

1. *Attention all aircraft, SIGMET Delta Three, from Myton to Tuba City to Milford, severe turbulence and severe clear icing below one zero thousand feet. Expected to continue beyond zero three zero zero zulu.*

2. *Attention all aircraft, Convective SIGMET Two Seven Eastern. From the vicinity of Elmira to Phillipsburg. Scattered embedded thunderstorms moving east at one zero knots. A few intense level five cells, maximum tops four five zero.*

3. *Attention all aircraft, Kansas City Center weather advisory one zero three. Numerous reports of moderate to severe icing from eight to nine thousand feet in a three zero mile radius of St. Louis. Light or negative icing reported from four thousand to one two thousand feet remainder of Kansas City Center area.*

**NOTE–**

*Terminal control facilities have the option to limit hazardous weather information broadcast as follows: Tower cab and approach control positions may opt to broadcast hazardous weather information alerts only when any part of the area described is within 50 miles of the airspace under their jurisdiction.*

**REFERENCE–**

*FAA Order JO 7110.65, Para 2–6–6, Hazardous Inflight Weather Advisory.*

## **6. Flight Information Services (FIS)**

**6.1 FIS.** FIS is a method of disseminating meteorological (MET) and aeronautical information (AI) to displays in the cockpit in order to enhance pilot situational awareness, provide decision support tools, and improve safety. FIS augments traditional pilot voice communication with Flight Service Stations (FSSs), ATC facilities, or Airline Operations Control Centers (AOCCs). FIS is not intended to replace traditional pilot and controller/flight service specialist/aircraft dispatcher preflight briefings or inflight voice communications. FIS, however, can provide textual and graphical information that can help abbreviate and improve the usefulness of such communications. FIS enhances pilot situational awareness and improves safety.

**6.1.1 Data link Service Providers (DSPs).** DSPs deploy and maintain airborne, ground-based, and, in some cases, space-based infrastructure that supports the transmission of AI/MET information over one or more physical links. A DSP may provide a free of charge or a for-fee service that permits end users to uplink and downlink AI/MET and other information. The following are examples of DSPs:

**6.1.1.1 FAA FIS-B.** A ground-based broadcast service provided through the ADS-B Universal Access Transceiver (UAT) network. The service provides users with a 978 MHz data link capability when operating within range and line-of-sight of a transmitting ground station. FIS-B enables users of properly equipped aircraft to receive and display a suite of broadcast weather and aeronautical information products.

**6.1.1.2 Non-FAA FIS Systems.** Several commercial vendors provide customers with FIS data over both the aeronautical spectrum and on other frequencies using a variety of data link protocols. Services available from these providers vary greatly and may include tier based subscriptions. Advancements in bandwidth technology permits preflight as well as inflight access to the same MET and AI information available on the ground. Pilots and operators using non-FAA FIS for MET and AI information should be knowledgeable regarding the weather services being provided as some commercial vendors may be repackaging NWS sourced weather, while other commercial vendors may alter the weather information to produce vendor-tailored or vendor-specific weather reports and forecasts.

**6.1.2 Three Data Link Modes.** There are three data link modes that may be used for transmitting AI and MET information to aircraft. The intended use of the AI and/or MET information will determine the most appropriate data link service.

**6.1.2.1 Broadcast Mode:** A one-way interaction in which AI and/or MET updates or changes applicable to a designated geographic area are continuously transmitted (or transmitted at repeated periodic intervals) to all aircraft capable of receiving the broadcast within the service volume defined by the system network architecture.

**6.1.2.2 Contract/Demand Mode:** A two-way interaction in which AI and/or MET information is transmitted to an aircraft in response to a specific request.

**6.1.2.3 Contract/Update Mode:** A two-way interaction that is an extension of the Demand Mode. Initial AI and/or MET report(s) are sent to an aircraft and subsequent updates or changes to the AI and/or MET information that meet the contract criteria are automatically or manually sent to an aircraft.

**6.1.3** To ensure airman compliance with Federal Aviation Regulations, manufacturer's operating manuals should remind airmen to contact ATC controllers, FSS specialists, operator dispatchers, or airline operations control centers for general and mission critical aviation weather information and/or NAS status conditions (such as NOTAMs, Special Use Airspace status, and other government flight information). If FIS products are systemically modified (for example, are displayed as abbreviated plain text and/or graphical depictions), the modification process and limitations of the resultant product should be clearly described in the vendor's user guidance.



**6.1.4** Operational Use of FIS. Regardless of the type of FIS system being used, several factors must be considered when using FIS:

**6.1.4.1** Before using FIS for inflight operations, pilots and other flight crewmembers should become familiar with the operation of the FIS system to be used, the airborne equipment to be used, including its system architecture, airborne system components, coverage service volume and other limitations of the particular system, modes of operation and indications of various system failures. Users should also be familiar with the specific content and format of the services available from the FIS provider(s). Sources of information that may provide this specific guidance include manufacturer’s manuals, training programs, and reference guides.

**6.1.4.2** FIS should not serve as the sole source of aviation weather and other operational information. ATC, FSSs, and, if applicable, AOCC VHF/HF voice remain as a redundant method of communicating aviation weather, NOTAMs, and other operational information to aircraft in flight. FIS augments these traditional ATC/FSS/AOCC services and, for some products, offers the advantage of being displayed as graphical information. By using FIS for orientation, the usefulness of information received from conventional means may be enhanced. For example, FIS may alert the pilot to specific areas of concern that will more accurately focus requests made to FSS or AOCC for inflight updates or similar queries made to ATC.

**6.1.4.3** The airspace and aeronautical environment is constantly changing. These changes occur quickly and without warning. Critical operational decisions should be based on use of the most current and appropriate data available. When differences exist between FIS and information obtained by voice communication with ATC, FSS, and/or AOCC (if applicable), pilots are cautioned to use the most recent data from the most authoritative source.

**6.1.4.4** FIS aviation weather products (for example, graphical ground–based radar precipitation depictions) are not appropriate for tactical (typical timeframe of less than 3 minutes) avoidance of severe weather such as negotiating a path through a weather hazard area. FIS supports strategic (typical timeframe of 20 minutes or more) weather decision–making such as route selection to avoid a weather hazard area in its entirety. The misuse of information beyond its applicability may place the pilot and aircraft in jeopardy. In addition, FIS should never be used in lieu of an individual preflight weather and flight planning briefing.

**6.1.4.5** DSPs offer numerous MET and AI products with information that can be layered on top of each other. Pilots need to be aware that too much information can have a negative effect on their cognitive work load. Pilots need to manage the amount of information to a level that offers the most pertinent information to that specific flight without creating a cockpit distraction. Pilots may need to adjust the amount of information based on numerous factors including, but not limited to, the phase of flight, single pilot operation, autopilot availability, class of airspace, and the weather conditions encountered.

**6.1.4.6** FIS NOTAM products, including Temporary Flight Restriction (TFR) information, are advisory–use information and are intended for situational awareness purposes only. Cockpit displays of this information are not appropriate for tactical navigation – pilots should stay clear of any geographic area displayed as a TFR NOTAM. Pilots should contact FSSs and/or ATC while en route to obtain updated information and to verify the cockpit display of NOTAM information.

**6.1.4.7** FIS supports better pilot decision–making by increasing situational awareness. Better decision–making is based on using information from a variety of sources. In addition to FIS, pilots should take advantage of other weather/NAS status sources, including, briefings from Flight Service Stations, data from other air traffic control facilities, airline operation control centers, pilot reports, as well as their own observations.

**6.1.4.8** FAA’s Flight Information Service–Broadcast (FIS–B).

a) FIS–B is a ground–based broadcast service provided through the FAA’s Automatic Dependent Surveillance–Broadcast (ADS–B) Services Universal Access Transceiver (UAT) network. The service provides users with a 978 MHz data link capability when operating within range and line–of–sight of a transmitting ground station. FIS–B enables users of properly–equipped aircraft to receive and display a suite of broadcast weather and aeronautical information products.

b) TBL GEN 3.5–4 lists the text and graphical products available through FIS–B and provided free-of-charge. Detailed information concerning FIS–B meteorological products can be found in Advisory Circular 00–45, Aviation Weather Services; and AC 00–63, Use of Cockpit Displays of Digital Weather and Aeronautical Information. Information on Special Use Airspace (SUA), Temporary Flight Restriction (TFR), and Notice to Air Missions (NOTAM) products can be found in Chapters ENR 1 and ENR 5 of this manual.

c) Users of FIS–B should familiarize themselves with the operational characteristics and limitations of the system, including: system architecture; service environment; product lifecycles; modes of operation; and indications of system failure.

d) FIS–B products are updated and transmitted at specific intervals based primarily on product issuance criteria. Update intervals are defined as the rate at which the product data is available from the source for transmission. Transmission intervals are defined as the amount of time within which a new or updated product transmission must be completed and/or the rate or repetition interval at which the product is rebroadcast. Update and transmission intervals for each product are provided in TBL GEN 3.5–4.

**NOTE–**

*The NOTAM–D and NOTAM–FDC products broadcast via FIS–B are limited to those issued or effective within the past 30 days. Except for TFRs, NOTAMs older than 30 days are not provided. The pilot in command is responsible for reviewing all necessary information prior to flight.*

e) Where applicable, FIS–B products include a look-ahead range expressed in nautical miles (NM) for three service domains: Airport Surface; Terminal Airspace; and Enroute/Gulf-of-Mexico (GOMEX). TBL GEN 3.5–5 provides service domain availability and look-ahead ranging for each FIS–B product.

f) Prior to using this capability, users should familiarize themselves with the operation of FIS–B avionics by referencing the applicable User’s Guides. Guidance concerning the interpretation of information displayed should be obtained from the appropriate avionics manufacturer.

g) FIS–B malfunctions not attributed to aircraft system failures or covered by active NOTAM should be reported by radio or telephone to the nearest FSS facility, or by sending an email to the ADS–B help desk at [adsb@faa.gov](mailto:adsb@faa.gov). Reports should include:

- 1) Condition observed;
- 2) Date and time of observation;
- 3) Altitude and location of observation;
- 4) Type and call sign of the aircraft; and
- 5) Type and software version of avionics system.

**6.2 Non-FAA FIS Systems.** Several commercial vendors also provide customers with FIS data over both the aeronautical spectrum and on other frequencies using a variety of data link protocols. In some cases, the vendors provide only the communications system that carries customer messages, such as the Aircraft Communications Addressing and Reporting System (ACARS) used by many air carrier and other operators.

**6.2.1** Operators using non-FAA FIS data for inflight weather and other operational information should ensure that the products used conform to FAA/NWS standards. Specifically, aviation weather and NAS status information should meet the following criteria:

**6.2.1.1** The products should be either FAA/NWS “accepted” aviation weather reports or products, or based on FAA/NWS accepted aviation weather reports or products. If products are used which do not meet this criteria, they should be so identified. The operator must determine the applicability of such products to their particular flight operations.

**6.2.1.2** In the case of a weather product which is the result of the application of a process which alters the form, function or content of the base FAA/NWS accepted weather product(s), that process, and any limitations to the application of the resultant product, should be described in the vendor’s user guidance material. An example

would be a NEXRAD radar composite/mosaic map, which has been modified by changing the scaling resolution. The methodology of assigning reflectivity values to the resultant image components should be described in the vendor’s guidance material to ensure that the user can accurately interpret the displayed data.

*TBL GEN 3.5–4*  
**FIS–B Over UAT Product Update and Transmission Intervals**

<b>Product</b>	<b>Update Interval<sup>1</sup></b>	<b>Transmission Interval (95%)<sup>2</sup></b>	<b>Basic Product</b>
AIRMET	As Available	5 minutes	Yes
AWW/WW	As Available, then at 15 minute intervals for 1 hour	5 minutes	No
Ceiling	As Available	10 minutes	No
Convective SIGMET	As Available, then at 15 minute intervals for 1 hour	5 minutes	Yes
D–ATIS	As Available	1 minute	No
Echo Top	5 minutes	5 minutes	No
METAR/SPECI	1 minute (where available), As Available otherwise	5 minutes	Yes
MRMS NEXRAD (CONUS)	2 minutes	15 minutes	Yes
MRMS NEXRAD (Regional)	2 minutes	2.5 minutes	Yes
NOTAMs–D/FDC	As Available	10 minutes	Yes
NOTAMs–TFR	As Available	10 minutes	Yes
PIREP	As Available	10 minutes	Yes
SIGMET	As Available, then at 15 minute intervals for 1 hour	5 minutes	Yes
SUA Status	As Available	10 minutes	Yes
TAF/AMEND	6 Hours (±15 minutes)	10 minutes	Yes
Temperature Aloft	12 Hours (±15 minutes)	10 minutes	Yes
TWIP	As Available	1 minute	No
Winds aloft	12 Hours (±15 minutes)	10 minutes	Yes
Lightning strikes <sup>3</sup>	5 minutes	5 minutes	Yes
Turbulence <sup>3</sup>	1 minute	15 minutes	Yes
Icing, Forecast Potential (FIP) <sup>3</sup>	60 minutes	15 minutes	Yes
Cloud tops <sup>3</sup>	30 minutes	15 minutes	Yes
1 Minute AWOS <sup>3</sup>	1 minute	10 minutes	No
Graphical–AIRMET <sup>3</sup>	As Available	5 minutes	Yes
Center Weather Advisory (CWA) <sup>3</sup>	As Available	10 minutes	Yes
Temporary Restricted Areas (TRA)	As Available	10 minutes	Yes
Temporary Military Operations Areas (TMOA)	As Available	10 minutes	Yes

<sup>1</sup> The Update Interval is the rate at which the product data is available from the source.

<sup>2</sup> The Transmission Interval is the amount of time within which a new or updated product transmission must be completed (95%) and the rate or repetition interval at which the product is rebroadcast (95%).

<sup>3</sup> The transmission and update intervals for the expanded set of basic meteorological products may be adjusted based on FAA and vendor agreement on the final product formats and performance requirements.

**NOTE–**

1. Details concerning the content, format, and symbols of the various data link products provided should be obtained from the specific avionics manufacturer.
2. NOTAM–D and NOTAM–FDC products broadcast via FIS–B are limited to those issued or effective within the past 30 days.

*TBL GEN 3.5–5*  
**Product Parameters for Low/Medium/High Altitude Tier Radios**

<b>Product</b>	<b>Surface Radios</b>	<b>Low Altitude Tier</b>	<b>Medium Altitude Tier</b>	<b>High Altitude Tier</b>
CONUS NEXRAD	N/A	CONUS NEXRAD not provided	CONUS NEXRAD imagery	CONUS NEXRAD imagery
Winds & Temps Aloft	500 NM look-ahead range	500 NM look-ahead range	750 NM look-ahead range	1,000 NM look-ahead range
METAR	100 NM look-ahead range	250 NM look-ahead range	375 NM look-ahead range	CONUS: CONUS Class B & C airport METARs and 500 NM look-ahead range  Outside of CONUS: 500 NM look-ahead range
TAF	100 NM look-ahead range	250 NM look-ahead range	375 NM look-ahead range	CONUS: CONUS Class B & C airport TAFs and 500 NM look-ahead range  Outside of CONUS: 500 NM look-ahead range
AIRMET, SIGMET, PIREP, and SUA/SAA	100 NM look-ahead range. PIREP/SUA/SAA is N/A.	250 NM look-ahead range	375 NM look-ahead range	500 NM look-ahead range
Regional NEXRAD	150 NM look-ahead range	150 NM look-ahead range	200 NM look-ahead range	250 NM look-ahead range
NOTAMs D, FDC, and TFR	100 NM look-ahead range	100 NM look-ahead range	100 NM look-ahead range	100 NM look-ahead range

## 7. Weather Observing Programs

**7.1 Manual Observations.** Aviation Routine Weather Reports (METAR) are taken at more than 600 locations in the U.S. With only a few exceptions, these stations are located at airport sites and most are staffed by FAA personnel who manually observe, perform calculations, and enter the observation into the distribution system. The format and coding of these observations are contained in FIG GEN 3.5–26 and FIG GEN 3.5–27.

### 7.2 Automated Weather Observing System (AWOS)

**7.2.1** Automated weather reporting systems are increasingly being installed at airports. These systems consist of various sensors, a processor, a computer-generated voice subsystem, and a transmitter to broadcast local, minute-by-minute weather data directly to the pilot.

**NOTE–**

*When the barometric pressure exceeds 31.00 inches Hg., see subparagraph ENR 1.7–3, Altimeter Setting Procedures.*

**7.2.2** The AWOS observations will include the prefix “AUTO” to indicate that the data are derived from an automated system. Some AWOS locations will be augmented by certified observers who will provide weather and obstruction to vision information in the remarks of the report when the reported visibility is less than 3 miles. These sites, along with the hours of augmentation, are published in the Chart Supplement U.S. Augmentation is identified in the observation as “OBSERVER WEATHER.” The AWOS wind speed, direction and gusts, temperature, dew point, and altimeter setting are exactly the same as for manual observations. The AWOS will also report density altitude when it exceeds the field elevation by more than 1,000 feet. The reported visibility is derived from a sensor near the touchdown of the primary instrument runway. The visibility sensor output is converted to a visibility value using a 10-minute harmonic average. The reported sky condition/ceiling is derived from the ceilometer located next to the visibility sensor. The AWOS algorithm integrates the last 30 minutes of ceilometer data to derive cloud layers and heights. This output may also differ from the observer sky condition in that the AWOS is totally dependent upon the cloud advection over the sensor site.

**7.2.3** Referred to as AWOS, these real-time systems are operationally classified into nine basic levels:

**7.2.3.1 AWOS–A** only reports altimeter setting.

**NOTE–**

*Any other information is advisory only.*

**7.2.3.2 AWOS–AV** reports altimeter and visibility;

**NOTE–**

*Any other information is advisory only.*

**7.2.3.3 AWOS–I** usually reports altimeter setting, wind data, temperature, dew point, and density altitude.

**7.2.3.4 AWOS–2** provides the information provided by AWOS–1, plus visibility.

**7.2.3.5 AWOS–3** provides the information provided by AWOS–2, plus cloud/ceiling data.

**7.2.3.6 AWOS–3P** provides reports the same as the AWOS 3 system, plus a precipitation identification sensor.

**7.2.3.7 AWOS–3PT** reports the same as the AWOS 3P System, plus thunderstorm/lightning reporting capability.

**7.2.3.8 AWOS–3T** reports the same as AWOS 3 system and includes a thunderstorm/lightning reporting capability.

**7.2.3.9 AWOS–4** reports the same as the AWOS 3 system, plus precipitation occurrence, type and accumulation, freezing rain, thunderstorm, and runway surface sensors.

**7.2.4** The information is transmitted over a discrete VHF radio frequency or the voice portion of a local NAVAID. AWOS transmissions on a discrete VHF radio frequency are engineered to be receivable to a maximum of 25 NM from the AWOS site and a maximum altitude of 10,000 feet AGL. At many locations, AWOS signals may be received on the surface of the airport, but local conditions may limit the maximum AWOS reception distance and/or altitude. The system transmits a 20- to 30-second weather message updated each minute. Pilots should monitor the designated frequency for the automated weather broadcast. A description of the broadcast is contained in Paragraph 7.3, Automated Weather Observing System (AWOS) Broadcasts. There is no two-way communication capability. Most AWOS sites also have a dial-up capability so that the minute-by-minute weather messages can be accessed via telephone.

**7.2.5** AWOS information (system level, frequency, phone number) concerning specific locations is published, as the systems become operational, in the Chart Supplement U.S. and, where applicable, on published Instrument

Approach Procedure (IAP) charts. Selected individual systems may be incorporated into nationwide data collection and dissemination networks in the future.

**7.3 AWOS Broadcasts.** Computer-generated voice is used in AWOS to automate the broadcast of the minute-by-minute weather observations. In addition, some systems are configured to permit the addition of an operator-generated voice message; e.g., weather remarks, following the automated parameters. The phraseology used generally follows that used for other weather broadcasts. Following are explanations and examples of the exceptions.

**7.3.1 Location and Time.** The location/name and the phrase “AUTOMATED WEATHER OBSERVATION” followed by the time are announced.

**7.3.1.1** If the airport’s specific location is included in the airport’s name, the airport’s name is announced.

**EXAMPLE–**

*“Bremerton National Airport automated weather observation one four five six zulu.”*

*“Ravenswood Jackson County Airport automated weather observation one four five six zulu.”*

**7.3.1.2** If the airport’s specific location is not included in the airport’s name, the location is announced followed by the airport’s name.

**EXAMPLE–**

*“Sault Ste. Marie, Chippewa County International Airport automated weather observation.”*

*“Sandusky, Cowley Field automated weather observation.”*

**7.3.1.3** The word “TEST” is added following “OBSERVATION” when the system is not in commissioned status.

**EXAMPLE–**

*“Bremerton National Airport automated weather observation test one four five six zulu.”*

**7.3.1.4** The phrase “TEMPORARILY INOPERATIVE” is added when the system is inoperative.

**EXAMPLE–**

*“Bremerton National Airport automated weather observing system temporarily inoperative.”*

### **7.3.2 Ceiling and Sky Cover**

**7.3.2.1** Ceiling is announced as either “CEILING” or “INDEFINITE CEILING.” The phrases “MEASURED CEILING” and “ESTIMATED CEILING” are not used. With the exception of indefinite ceilings, all automated ceiling heights are measured.

**EXAMPLE–**

*“Bremerton National Airport automated weather observation one four five six zulu, ceiling two thousand overcast.”*

*“Bremerton National Airport automated weather observation one four five six zulu, indefinite ceiling two hundred.”*

**7.3.2.2** The word “CLEAR” is not used in AWOS due to limitations in the height ranges of the sensors. No clouds detected is announced as, “No clouds below XXX” or, in newer systems as, “Clear below XXX” (where XXX is the range limit of the sensor).

**EXAMPLE–**

*“No clouds below one two thousand.”*

*“Clear below one two thousand.”*

**7.3.2.3** A sensor for determining ceiling and sky cover is not included in some AWOS. In these systems, ceiling and sky cover are not announced. “SKY CONDITION MISSING” is announced only if the system is configured with a ceilometer, and the ceiling and sky cover information is not available.

### **7.3.3 Visibility**

**7.3.3.1** The lowest reportable visibility value in AWOS is “less than  $\frac{1}{4}$ .” It is announced as “VISIBILITY LESS THAN ONE QUARTER.”

**7.3.3.2** A sensor for determining visibility is not included in some AWOSs. In these systems, visibility is not announced. “VISIBILITY MISSING” is announced only if the system is configured with a visibility sensor and visibility information is not available.

**7.3.4 Weather.** In the future, some AWOSs are to be configured to determine the occurrence of precipitation. However, the type and intensity may not always be determined. In these systems, the word “PRECIPITATION” will be announced if precipitation is occurring, but the type and intensity are not determined.

**7.3.5 Remarks.** If remarks are included in the observation, the word “REMARKS” is announced following the altimeter setting. Remarks are announced in the following order of priority:

**7.3.5.1** Automated “remarks.”

- a) Variable visibility.
- b) Density altitude.

**7.3.5.2** Manual input remarks. Manual input remarks are prefaced with the phrase “OBSERVER WEATHER.” As a general rule the manual remarks are limited to:

- a) Type and intensity of precipitation.
- b) Thunderstorms, intensity (if applicable), and direction.
- c) Obstructions to vision when the visibility is less than 7 miles.

**EXAMPLE–**

*“Remarks...density altitude, two thousand five hundred...visibility variable between one and two...wind direction variable between two four zero and three one zero...observed weather...thunderstorm moderate rain showers and mist...thunderstorm overhead.”*

**7.3.5.3** If an automated parameter is “missing” and no manual input for that parameter is available, the parameter is announced as “MISSING.” For example, a report with the dew point “missing,” and no manual input available, would be announced as follows:

**EXAMPLE–**

*“Ceiling one thousand overcast, visibility three, precipitation, temperature three zero, dew point missing, wind calm, altimeter three zero zero one.”*

**7.3.5.4** “REMARKS” are announced in the following order of priority:

- a) Automated “REMARKS”:
  - 1) Variable visibility.
  - 2) Density altitude.

b) Manual Input “REMARKS.” As a general rule, the remarks are announced in the same order as the parameters appear in the basic text of the observation.

**EXAMPLE–**

*“Remarks, density altitude, two thousand five hundred, visibility variable between one and two, wind direction variable between two four zero and three one zero, observer ceiling estimated two thousand broken, observer temperature two, dew point minus five.”*

## **7.4 Automated Surface Observing System (ASOS)/Automated Weather Observing System (AWOS)**

**7.4.1** The ASOS/AWOS is the primary surface weather observing system of the U.S. The program to install and operate these systems throughout the U.S. is a joint effort of the NWS, the FAA and the Department of Defense. ASOS/AWOS is designed to support aviation operations and weather forecast activities. The ASOS/AWOS will provide continuous minute-by-minute observations and perform the basic observing functions necessary to

generate an aviation routine weather report (METAR) and other aviation weather information. The information may be transmitted over a discrete VHF radio frequency or the voice portion of a local NAVAID. ASOS/AWOS transmissions on a discrete VHF radio frequency are engineered to be receivable to a maximum of 25 NM from the ASOS/AWOS site and a maximum altitude of 10,000 feet AGL. At many locations, ASOS/AWOS signals may be received on the surface of the airport, but local conditions may limit the maximum reception distance and/or altitude. While the automated system and the human may differ in their methods of data collection and interpretation, both produce an observation quite similar in form and content. For the “objective” elements such as pressure, ambient temperature, dew point temperature, wind, and precipitation accumulation, both the automated system and the observer use a fixed location and time-averaging technique. The quantitative differences between the observer and the automated observation of these elements are negligible. For the “subjective” elements, however, observers use a fixed time, spatial averaging technique to describe the visual elements (sky condition, visibility and present weather), while the automated systems use a fixed location, time averaging technique. Although this is a fundamental change, the manual and automated techniques yield remarkably similar results within the limits of their respective capabilities. (See FIG GEN 3.5–26 and FIG GEN 3.5–27, Key to Decode an ASOS/AWOS (METAR) Observation.

#### **7.4.2 System Description**

**7.4.2.1** The ASOS/AWOS at each airport location consists of four main components:

- a) Individual weather sensors.
- b) Data collection and processing units.
- c) Peripherals and displays.

**7.4.2.2** The ASOS/AWOS sensors perform the basic function of data acquisition. They continuously sample and measure the ambient environment, derive raw sensor data and make them available to the collection and processing units.

**7.4.3 Every ASOS/AWOS will contain the following basic set of sensors.**

**7.4.3.1** Cloud height indicator (one or possibly three).

**7.4.3.2** Visibility sensor (one or possibly three).

**7.4.3.3** Precipitation identification sensor.

**7.4.3.4** Freezing rain sensor.

**7.4.3.5** Pressure sensors (two sensors at small airports; three sensors at large airports).

**7.4.3.6** Ambient temperature/dew point temperature sensor.

**7.4.3.7** Anemometer (wind direction and speed sensor).

**7.4.3.8** Rainfall accumulation sensor.

**7.4.3.9** Automated Lightning Detection and Reporting System (ALDARS) (excluding Alaska and Pacific Island sites).

**7.4.4 The ASOS/AWOS data outlets include:**

**7.4.4.1** Those necessary for on-site airport users.

**7.4.4.2** National communications networks.

**7.4.4.3** Computer-generated voice (available through FAA radio broadcast to pilots and dial-in telephone line).

**NOTE–**

*Wind direction is reported relative to magnetic north in ATIS as well as ASOS and AWOS radio (voice) broadcasts.*

**7.5** A comparison of weather observing programs and the elements observed by each are in TBL GEN 3.5–6, Weather Observing Programs.



**7.6 Service Standards.** During 1995, a government/industry team worked to comprehensively reassess the requirements for surface observations at the nation’s airports. That work resulted in agreement on a set of service standards and the FAA and NWS ASOS sites to which the standards would apply. The term “Service Standards” refers to the level of detail in the weather observation. The service standards consist of four different levels of service (A, B, C, and D) as described below. Specific observational elements included in each service level are listed in TBL GEN 3.5–7, Weather Observation Service Standards.

**7.6.1 Service Level D** defines the minimum acceptable level of service. It is a completely automated service in which the ASOS/AWOS observation will constitute the entire observation; i.e., no additional weather information is added by a human observer. This service is referred to as a stand alone D site.

**7.6.2 Service Level C** is a service in which the human observer, usually an air traffic controller, augments or adds information to the automated observation. Service Level C also includes backup of ASOS/AWOS elements in the event of an ASOS/AWOS malfunction or an unrepresentative ASOS/AWOS report.

**7.6.3** In backup, the human observer inserts the correct or missing value for the automated ASOS/AWOS elements. This service is provided by air traffic controllers under the Limited Aviation Weather Reporting Station (LAWRS) process, FSS and NWS observers, and, at selected sites, Non-Federal Observation Program observers.

Two categories of airports require detail beyond Service Level C in order to enhance air traffic control efficiency and increase system capacity. Services at these airports are typically provided by contract weather observers, NWS observers, and, at some locations, FSS observers.

**7.6.4 Service Level B** is a service in which weather observations consist of all elements provided under Service Level C, plus augmentation of additional data beyond the capability of the ASOS/AWOS. This category of airports includes smaller hubs or airports special in other ways that have worse than average bad weather operations for thunderstorms and/or freezing/frozen precipitation, and/or that are remote airports.

**7.6.5 Service Level A**, the highest and most demanding category, includes all the data reported in Service Standard B, plus additional requirements as specified. Service Level A covers major aviation hubs and/or high volume traffic airports with average or worse weather.

TBL GEN 3.5–6  
Weather Observing Programs

Element Reported Type	Wind	Visibility	Temperature Dew Point	Altimeter	Density Altimeter	Cloud/Ceiling	Precipitation Identification	Thunderstorm/ Lightning	Precipitation Occurrence	Rainfall Accumulation	Runway Surface Condition	Freezing Rain Occurrence	Remarks
ASOS	X	X	X	X	X	X	X			X		X	X
AWOS-A				X									
AWOS-A/V		X		X									
AWOS-1	X		X	X	X								
AWOS-2	X	X	X	X	X								
AWOS-3	X	X	X	X	X	X							
AWOS-3P	X	X	X	X	X	X	X						
AWOS-3T	X	X	X	X	X	X		X					
AWOS-3P/T	X	X	X	X	X	X	X	X					
AWOS-4	X	X	X	X	X	X	X	X	X	X	X	X	
Manual	X	X	X	X		X	X						X

REFERENCE– FAA Order JO 7900.5, Surface Weather Observing, for element reporting.

*TBL GEN 3.5–7*  
**Weather Observation Service Standards**

<b>SERVICE LEVEL A</b>	
Service Level A consists of all the elements of Service Levels B, C and D plus the elements listed to the right, if observed.	10 minute longline RVR at predated sites or additional visibility increments of 1/8, 1/16 and 0 Sector visibility Variable sky condition Cloud layers above 12,000 feet and cloud types Widespread dust, sand and other obscurations Volcanic eruptions
<b>SERVICE LEVEL B</b>	
Service Level B consists of all the elements of Service Levels C and D plus the elements listed to the right, if observed.	Longline RVR at predated sites (may be instantaneous readout) Freezing drizzle versus freezing rain Ice pellets Snow depth & snow increasing rapidly remarks Thunderstorm and lightning location remarks Observed significant weather not at the station remarks
<b>SERVICE LEVEL C</b>	
Service Level C consists of all the elements of Service Level D plus augmentation and backup by a human observer or an air traffic control specialist on location nearby. Backup consists of inserting the correct value if the system malfunctions or is unrepresentative. Augmentation consists of adding the elements listed to the right, if observed. During hours that the observing facility is closed, the site reverts to Service Level D.	Thunderstorms Tornadoes Hail Virga Volcanic ash Tower visibility Operationally significant remarks as deemed appropriate by the observer
<b>SERVICE LEVEL D</b>	
This level of service consists of an ASOS or AWOS continually measuring the atmosphere at a point near the runway. The ASOS or AWOS senses and measures the weather parameters listed to the right.	Wind Visibility Precipitation/Obstruction to vision Cloud height Sky cover Temperature Dew point Altimeter

**8. Weather Radar Services**

**8.1** The National Weather Service operates a network of radar sites for detecting coverage, intensity, and movement of precipitation. The network is supplemented by FAA and DoD radar sites in the western sections of the country. Local warning radars augment the network by operating on an as needed basis to support warning and forecast programs.

**8.2** Scheduled radar observations are taken hourly and transmitted in alpha-numeric format on weather telecommunications circuits for flight planning purposes. Under certain conditions special radar reports are issued in addition to the hourly transmittals. Data contained in the reports is also collected by the National Meteorological Center and used to prepare hourly national radar summary charts for dissemination on facsimile circuits.

**8.3** All En route Flight Advisory Service facilities and many Automated Flight Service Stations have equipment to directly access the radar displays from the individual weather radar sites. Specialists at these locations are trained to interpret the display for pilot briefing and inflight advisory services. The Center Weather Service Units

located in the ARTCCs also have access to weather radar displays and provide support to all air traffic facilities within their center's area.

**8.4** A clear radar display (no echoes) does not mean that there is no significant weather within the coverage of the radar site. Clouds and fog are not detected by the radar. However, when echoes are present, turbulence can be implied by the intensity of the precipitation, and icing is implied by the presence of the precipitation at temperatures at or below zero degrees Celsius. Used in conjunction with other weather products, radar provides invaluable information for weather avoidance and flight planning.

**8.5** Additional information on weather radar products and services can be found in FAA Advisory Circular 00–45, “Aviation Weather Services.”

**REFERENCE–**

*Pilot/Controller Glossary Term– Precipitation Radar Weather Descriptions.*

*AIP, GEN 3.5, Para 26., Thunderstorms.*

*Chart Supplement U.S., Charts, NWS Upper Air Observing Stations and Weather Network for the location of specific radar sites.*

## **9. ATC Inflight Weather Avoidance Assistance**

### **9.1 ATC Radar Weather Display**

**9.1.1** ATC radars are able to display areas of precipitation by sending out a beam of radio energy that is reflected back to the radar antenna when it strikes an object or moisture which may be in the form of rain drops, hail, or snow. The larger the object is, or the more dense its reflective surface, the stronger the return will be presented. Radar weather processors indicate the intensity of reflective returns in terms of decibels (dBZ). ATC systems cannot detect the presence or absence of clouds. The ATC systems can often determine the intensity of a precipitation area, but the specific character of that area (snow, rain, hail, VIRGA, etc.) cannot be determined. For this reason, ATC refers to all weather areas displayed on ATC radar scopes as “precipitation.”

**9.1.2** All ATC facilities using radar weather processors with the ability to determine precipitation intensity, will describe the intensity to pilots as:

**9.1.2.1** “LIGHT” (< 26 dBZ)

**9.1.2.2** “MODERATE” (26 to 40 dBZ)

**9.1.2.3** “HEAVY” (> 40 to 50 dBZ)

**9.1.2.4** “EXTREME” (> 50 dBZ)

**NOTE–**

*En Route ATC radar's Weather and Radar Processor (WARP) does not display light precipitation intensity.*

**9.1.3** ATC facilities that, due to equipment limitations, cannot display the intensity levels of precipitation, will describe the location of the precipitation area by geographic position, or position relative to the aircraft. Since the intensity level is not available, the controller will state “INTENSITY UNKNOWN.”

**9.1.4** ARTCC facilities normally use a Weather and Radar Processor (WARP) to display a mosaic of data obtained from multiple NEXRAD sites. There is a time delay between actual conditions and those displayed to the controller. For example, the precipitation data on the ARTCC controller's display could be up to 6 minutes old. When the WARP is not available, a second system, the narrowband Air Route Surveillance Radar (ARSR) can display two distinct levels of precipitation intensity that will be described to pilots as “MODERATE” (26 to 40 dBZ) and “HEAVY TO EXTREME” (> 40 dBZ). The WARP processor is only used in ARTCC facilities.

**9.1.5** *ATC radar is not able to detect turbulence.* Generally, turbulence can be expected to occur as the rate of rainfall or intensity of precipitation increases. Turbulence associated with greater rates of rainfall/precipitation will normally be more severe than any associated with lesser rates of rainfall/precipitation. Turbulence should be expected to occur near convective activity, even in clear air. Thunderstorms are a form of convective activity that imply severe or greater turbulence. Operation within 20 miles of thunderstorms should be approached with great caution, as the severity of turbulence can be markedly greater than the precipitation intensity might indicate.

## 9.2 Weather Avoidance Assistance

**9.2.1** To the extent possible, controllers will issue pertinent information of weather or chaff areas and assist pilots in avoiding such areas if requested. Pilots should respond to a weather advisory by either acknowledging the advisory or by acknowledging the advisory and requesting an alternative course of action as follows:

**9.2.1.1** Request to deviate off course by stating a heading or degrees, direction of deviation, and approximate number of miles. In this case, when the requested deviation is approved, navigation is at the pilot's prerogative, but must maintain the altitude assigned, and remain within the lateral restrictions issued by ATC.

**9.2.1.2** An approval for lateral deviation authorizes the pilot to maneuver left or right within the lateral limits specified in the clearance.

**NOTE–**

**1.** *It is often necessary for ATC to restrict the amount of lateral deviation (“twenty degrees right,” “up to fifteen degrees left,” “up to ten degrees left or right of course”).*

**2.** *The term “when able, proceed direct,” in an ATC weather deviation clearance, refers to the pilot's ability to remain clear of the weather when returning to course/route.*

**9.2.1.3** Request a new route to avoid the affected area.

**9.2.1.4** Request a change of altitude.

**9.2.1.5** Request radar vectors around the affected areas.

**9.2.2** For obvious reasons of safety, an IFR pilot must not deviate from the course or altitude/flight level without a proper ATC clearance. When weather conditions encountered are so severe that an immediate deviation is determined to be necessary and time will not permit approval by ATC, the pilot's emergency authority may be exercised.

**9.2.3** When the pilot requests clearance for a route deviation or for an ATC radar vector, the controller must evaluate the air traffic picture in the affected area and coordinate with other controllers (if ATC jurisdictional boundaries may be crossed) before replying to the request.

**9.2.4** It should be remembered that the controller's primary function is to provide safe separation between aircraft. Any additional service, such as weather avoidance assistance, can only be provided to the extent that it does not derogate the primary function. It is also worth noting that the separation workload is generally greater than normal when weather disrupts the usual flow of traffic. ATC radar limitations and frequency congestion may also be factors in limiting the controller's capability to provide additional service.

**9.2.5** It is very important that the request for deviation or radar vector be forwarded to ATC as far in advance as possible. Delay in submitting it may delay or even preclude ATC approval or require that additional restrictions be placed on the clearance. Insofar as possible, the following information should be furnished to ATC when requesting clearance to detour around weather activity:

**9.2.5.1** Proposed point where detour will commence.

**9.2.5.2** Proposed route and extent of detour (direction and distance).

**9.2.5.3** Point where original route will be resumed.

**9.2.5.4** Flight conditions (IFR or VFR).

**9.2.5.5** Any further deviation that may become necessary as the flight progresses.

**9.2.5.6** Advise if the aircraft is equipped with functioning airborne radar.

**9.2.6** To a large degree, the assistance that might be rendered by ATC will depend upon the weather information available to controllers. Due to the extremely transitory nature of severe weather situations, the controller's weather information may be of only limited value if based on weather observed on radar only. Frequent updates by pilots giving specific information as to the area affected, altitudes, intensity, and nature of the severe weather can be of considerable value. Such reports are relayed by radio or phone to other pilots and controllers, and they also receive widespread teletypewriter dissemination.

**9.2.7** Obtaining IFR clearance or an ATC radar vector to circumnavigate severe weather can often be accommodated more readily in the en route areas away from terminals because there is usually less congestion and, therefore, greater freedom of action. In terminal areas, the problem is more acute because of traffic density, ATC coordination requirements, complex departure and arrival routes, and adjacent airports. As a consequence, controllers are less likely to be able to accommodate all requests for weather detours in a terminal area or be in a position to volunteer such routes to the pilot. Nevertheless, pilots should not hesitate to advise controllers of any observed severe weather and should specifically advise controllers if they desire circumnavigation of observed weather.

### **9.3 ATC Severe Weather Avoidance Plans**

**9.3.1** Air Route Traffic Control Centers and some Terminal Radar Control facilities utilize plans for severe weather avoidance within their control areas. Aviation-oriented meteorologists provide weather information. Preplanned alternate route packages developed by the facilities are used in conjunction with flow restrictions to ensure a more orderly flow of traffic during periods of severe or adverse weather conditions.

**9.3.2** During these periods, pilots may expect to receive alternative route clearances. These routes are predicated upon the forecasts of the meteorologist and coordination between the Air Traffic Control System Command Center and the other centers. The routes are utilized as necessary in order to allow as many aircraft as possible to operate in any given area, and frequently they will deviate from the normal preferred routes. With user cooperation, this plan may significantly reduce delays.

### **9.4 Procedures for Weather Deviations and Other Contingencies in Oceanic Controlled Airspace**

**9.4.1** See ENR 7.3, Paragraph 4, Weather Deviation Procedures.

## **10. Notifications Required From Operators**

**10.1** Preflight briefing and flight documentation services provided by FSSs do not require prior notification.

**10.2** Preflight briefing and flight documentation services provided by a National Weather Service Office (or contract office) are available upon request for long-range international flights for which meteorological data packages are prepared for the pilot-in-command. Briefing times should be coordinated between the local representative and the local meteorological office.

**10.3** Flight Service Stations do not normally have the capability to prepare meteorological data packages for a preflight briefing.

## **11. Weather Observing Systems and Operating Procedures**

For surface wind readings, most meteorological reporting stations have a direct reading, 3-cup anemometer wind system for which a 1-minute mean wind speed and direction (based on true north) is taken. Some stations also have a continuous wind speed recorder which is used in determining the gustiness of the wind.

## **12. Runway Visual Range (RVR)**

There are currently two configurations of the RVR, commonly identified as Taskers and New Generation RVR. The Taskers use transmissometer technology. The New Generation RVRs use forward scatter technology and are currently being deployed to replace the existing Taskers.

**12.1** RVR values are measured by transmissometers mounted on 14-foot towers along the runway. A full RVR system consists of:

**12.1.1** A transmissometer projector and related items.

**12.1.2** A transmissometer receiver (detector) and related items.

**12.1.3** An analog recorder.

**12.1.4** A signal data converter and related items.

**12.1.5** A remote digital or remote display programmer.

**12.2** The transmissometer projector and receiver are mounted on towers 250 feet apart. A known intensity of light is emitted from the projector and is measured by the receiver. Any obscuring matter, such as rain, snow, dust, fog, haze, or smoke, reduces the light intensity arriving at the receiver. The resultant intensity measurement is then converted to an RVR value by the signal data converter. These values are displayed by readout equipment in the associated air traffic facility and updated approximately once every minute for controller issuance to pilots.

**12.3** The signal data converter receives information on the high-intensity runway edge light setting in use (step 3, 4, or 5), transmission values from the transmissometer, and the sensing of day or night conditions. From the three data sources, the system will compute appropriate RVR values.

**12.4** An RVR transmissometer established on a 250-foot baseline provides digital readouts to a minimum of 600 feet, which are displayed in 200-foot increments to 3,000 feet, and in 500-foot increments from 3,000 feet to a maximum value of 6,000 feet.

**12.5** RVR values for Category IIIa operations extend down to 700-foot RVR; however, only 600 and 800 feet are reportable RVR increments. The 800 RVR reportable value covers a range of 701 feet to 900 feet and is therefore a valid minimum indication of Category IIIa operations.

**12.6** Approach categories with the corresponding minimum RVR values are listed in TBL GEN 3.5–8.

TBL GEN 3.5–8

Category	Visibility (RVR)
Nonprecision	2,400 feet
Category I	1,800 feet*
Category II	1,000 feet
Category IIIa	700 feet
Category IIIb	150 feet
Category IIIc	0 feet

\* 1,400 feet with special equipment and authorization

**12.7** Ten-minute maximum and minimum RVR values for the designated RVR runway are reported in the body of the aviation weather report when the prevailing visibility is less than 1 mile and/or the RVR is 6,000 feet or less. ATCTs report RVR when the prevailing visibility is 1 mile or less and/or the RVR is 6,000 feet or less.

**12.8** Details on the requirements for the operational use of RVR are contained in FAA Advisory Circular 97–1, “Runway Visual Range (RVR).” Pilots are responsible for compliance with minimums prescribed for their class of operations in appropriate Federal Aviation Regulations and/or operations specifications.

**12.8.1** RVR values are also measured by forward scatter meters mounted on 14-foot frangible fiberglass poles. A full RVR system consists of:

**12.8.1.1** Forward scatter meter with a transmitter, receiver and associated items.

**12.8.1.2** A runway light intensity monitor (RLIM).

**12.8.1.3** An ambient light sensor (ALS).

**12.8.1.4** A data processor unit (DPU).

**12.8.1.5** A controller display (CD).

**12.8.2** The forward scatter meter is mounted on a 14-foot frangible pole. Infrared light is emitted from the transmitter and received by the receiver. Any obscuring matter such as rain, snow, dust, fog, haze, or smoke increases the amount of scattered light reaching the receiver. The resulting measurement along with inputs from

the runway light intensity monitor and the ambient light sensor are forwarded to the DPU which calculates the proper RVR value. The RVR values are displayed locally and remotely on controller displays.

**12.8.3** The runway light intensity monitors both the runway edge and centerline light step settings (steps 1 through 5). Centerline light step settings are used for CAT IIIb operations. Edge light step settings are used for CAT I, II, and IIIa operations.

**12.8.4** New Generation RVRs can measure and display RVR values down to the lowest limits of Category IIIb operations (150 foot RVR). RVR values are displayed in 100–foot increments and are reported as follows:

**12.8.4.1** 100–foot increments for products below 800 feet.

**12.8.4.2** 200–foot increments for products between 800 feet and 3,000 feet.

**12.8.4.3** 500–foot increments for products between 3,000 feet and 6,500 feet.

**12.8.4.4** 25–meter increments for products below 150 meters.

**12.8.4.5** 50–meter increments for products between 150 meters and 800 meters.

**12.8.4.6** 100–meter increments for products between 800 meters and 1,200 meters.

**12.8.4.7** 200–meter increments for products between 1,200 meters and 2,000 meters.

### 13. Reporting of Cloud Heights

**13.1** Ceiling, by definition in Federal Aviation Regulations, and as used in Aviation Weather Reports and Forecasts, is the height above ground (or water) level of the lowest layer of clouds or obscuring phenomenon that is reported as “broken,” “overcast,” or “the vertical visibility into an obscuration.” For example, an aerodrome forecast which reads “BKN030” refers to heights above ground level (AGL). An area forecast which reads “BKN030” states that the height is above mean sea level (MSL). See FIG GEN 3.5–24 for the Key to Routine Aviation Weather Reports and Forecasts for the definition of “broken,” “overcast,” and “obscuration.”

**13.2** Information on cloud base height is obtained by use of ceilometers (rotating or fixed beam), ceiling lights, ceiling balloons, pilot reports, and observer estimations. The systems in use by most reporting stations are either the observer estimation or the rotating beam ceilometer.

**13.3** Pilots usually report height values above mean sea level, since they determine heights by the altimeter. This is taken into account when disseminating and otherwise applying information received from pilots. (“Ceiling” heights are always above ground level.) In reports disseminated as pilot reports, height references are given the same as received from pilots; that is, above mean sea level.

**13.4** In area forecasts or inflight Advisories, ceilings are denoted by the contraction “CIG” when used with sky cover symbols as in “LWRG TO CIG OVC005,” or the contraction “AGL” after the forecast cloud height value. When the cloud base is given in height above mean sea level, it is so indicated by the contraction “MSL” or “ASL” following the height value. The heights of cloud tops, freezing level, icing, and turbulence are always given in heights above mean sea level (ASL or MSL).

### 14. Reporting Prevailing Visibility

**14.1** Surface (horizontal) visibility is reported in METAR reports in terms of statute miles and increments thereof; e.g.,  $\frac{1}{16}$ ,  $\frac{1}{8}$ ,  $\frac{3}{16}$ ,  $\frac{1}{4}$ ,  $\frac{5}{16}$ ,  $\frac{3}{8}$ ,  $\frac{1}{2}$ ,  $\frac{5}{8}$ ,  $\frac{3}{4}$ ,  $\frac{7}{8}$ , 1,  $1\frac{1}{8}$ , etc. (Visibility reported by an unaugmented automated site is reported differently than in a manual report; i.e., ASOS/AWOS: 0,  $\frac{1}{16}$ ,  $\frac{1}{8}$ ,  $\frac{1}{4}$ ,  $\frac{1}{2}$ ,  $\frac{3}{4}$ , 1,  $1\frac{1}{4}$ ,  $1\frac{1}{2}$ ,  $1\frac{3}{4}$ , 2,  $2\frac{1}{2}$ , 3, 4, 5, etc., AWOS: M $\frac{1}{4}$ ,  $\frac{1}{4}$ ,  $\frac{1}{2}$ ,  $\frac{3}{4}$ , 1,  $1\frac{1}{4}$ ,  $1\frac{1}{2}$ ,  $1\frac{3}{4}$ , 2,  $2\frac{1}{2}$ , 3, 4, 5, etc.) Visibility is determined through the ability to see and identify preselected and prominent objects at a known distance from the usual point of observation. Visibilities which are determined to be less than 7 miles, identify the obscuring atmospheric condition; e.g., fog, haze, smoke, etc., or combinations thereof.

**14.2** Prevailing visibility is the greatest visibility equaled or exceeded throughout at least one–half the horizon circle, not necessarily contiguous. Segments of the horizon circle which may have a significantly different

visibility may be reported in the remarks section of the weather report; i.e., the southeastern quadrant of the horizon circle may be determined to be 2 miles in mist while the remaining quadrants are determined to be 3 miles in mist.

**14.3** When the prevailing visibility at the usual point of observation, or at the tower level, is less than 4 miles, certificated tower personnel will take visibility observations in addition to those taken at the usual point of observation. The lower of these two values will be used as the prevailing visibility for aircraft operations.

## **15. Estimating Intensity of Rain and Ice Pellets**

### **15.1 Rain**

**15.1.1 Light.** From scattered drops that, regardless of duration, do not completely wet an exposed surface up to a condition where individual drops are easily seen.

**15.1.2 Moderate.** Individual drops are not clearly identifiable; spray is observable just above pavements and other hard surfaces.

**15.1.3 Heavy.** Rain seemingly falls in sheets; individual drops are not identifiable; heavy spray to a height of several inches is observed over hard surfaces.

### **15.2 Ice Pellets**

**15.2.1 Light.** Scattered pellets that do not completely cover an exposed surface regardless of duration. Visibility is not affected.

**15.2.2 Moderate.** Slow accumulation on the ground. Visibility is reduced by ice pellets to less than 7 statute miles.

**15.2.3 Heavy.** Rapid accumulation on the ground. Visibility is reduced by ice pellets to less than 3 statute miles.

## **16. Estimating the Intensity of Snow or Drizzle (Based on Visibility)**

**16.1 Light.** Visibility more than  $\frac{1}{2}$  statute mile.

**16.2 Moderate.** Visibility from more than  $\frac{1}{4}$  statute mile to  $\frac{1}{2}$  statute mile.

**16.3 Heavy.** Visibility  $\frac{1}{4}$  statute mile or less.

## **17. Pilot Weather Reports (PIREPs)**

**17.1** FAA air traffic facilities are required to solicit PIREPs when the following conditions are reported or forecast: ceilings at or below 5,000 feet, visibility at or below 5 miles (surface or aloft), thunderstorms and related phenomena, icing of a light degree or greater, turbulence of a moderate degree or greater, wind shear, and reported or forecast volcanic ash clouds, including the presence of sulphur gases (SO<sub>2</sub> or H<sub>2</sub>S). SO<sub>2</sub> is identifiable as the sharp, acrid odor of a freshly struck match. H<sub>2</sub>S, also known as sewer gas, has the odor of rotten eggs. Electrical smoke and fire and SO<sub>2</sub> are two odors described as somewhat similar.

### **NOTE–**

*After determining there are no secondary indications that would result from and indicate an electrical fire, the flight crew must establish whether the sulphur odor is transient or not. This is best achieved by flight crew donning oxygen mask(s) and breathing 100 percent oxygen for the period of time that results in a complete change of air within the cockpit and also allows the sense of smell to be regained. After the appropriate time period, the flight crew should remove the oxygen mask and determine if the odor is still present. The detection of sulphur gases are to be reported as SO<sub>2</sub> to conform to ICAO practices.*

**17.2** Pilots are urged to cooperate and promptly volunteer reports of these conditions and other atmospheric data, such as cloud bases, tops and layers, flight visibility, precipitation, visibility restrictions (haze, smoke, and dust), wind at altitude, and temperature aloft.

**17.3** PIREPs should be given to the ground facility with which communications are established; i.e., FSS, ARTCC, or terminal ATC. One of the primary duties of the Inflight position is to serve as a collection point for the exchange of PIREPs with en route aircraft.



**17.4** If pilots do not make PIREPs by radio, it is helpful if, upon landing, they report to the nearest FSS or Weather Forecast Office the inflight conditions which they encountered. Some of the uses made of the reports are:

**17.4.1** The ATCT uses the reports to expedite the flow of air traffic in the vicinity of the field and for hazardous weather avoidance procedures.

**17.4.2** The FSS uses the reports to brief other pilots, to provide inflight advisories and weather avoidance information to en route aircraft.

**17.4.3** The ARTCC uses the reports to expedite the flow of en route traffic, to determine most favorable altitudes, and to issue hazardous weather information within the center's area.

**17.4.4** The NWS uses the reports to verify or amend conditions contained in aviation forecasts and advisories; (In some cases, pilot reports of hazardous conditions are the triggering mechanism for the issuance of advisories.)

**17.4.5** The NWS, other government organizations, the military, and private industry groups use PIREPs for research activities in the study of meteorological phenomena.

**17.4.6** All air traffic facilities and the NWS forward the reports received from pilots into the weather distribution system to assure the information is made available to all pilots and other interested parties.

**17.5** The FAA, NWS, and other organizations that enter PIREPs into the weather reporting system use the format listed in TBL GEN 3.5-9, PIREP Element Code Chart. Items 1 through 6 are included in all transmitted PIREPs along with one or more of items 7 through 13. Although the PIREP should be as complete and concise as possible, pilots should not be overly concerned with strict format or phraseology. The important thing is that the information is relayed so other pilots may benefit from your observation. If a portion of the report needs clarification, the ground station will request the information.

**17.6** Completed PIREPs will be transmitted to weather circuits as in the following examples:

**EXAMPLE-**

*KCMH UA/OV APE 230010/TM 1516/FL085/TP BE20/SK BKN065/WX FV03SM HZ FU/TA 20/TB LGT.*

*Translation: one zero miles southwest of Appleton VOR; time 1516 UTC; altitude eight thousand five hundred; aircraft type BE20; base of the broken cloud layer is six thousand five hundred; flight visibility 3 miles with haze and smoke; air temperature 20 degrees Celsius; light turbulence.*

**EXAMPLE-**

*KCRW UA/OV KBKW 360015-KCRW/TM 1815/ FL120/TP BE99/SK IMC/WX RA-/TA M08/WV 290030/TB LGT-MDT/IC LGT RIME/RM MDT MXD ICG DURC KROA NWBND FL080-100 1750Z.*

*Translation: from 15 miles north of Beckley VOR to Charleston VOR; time 1815 UTC; altitude 12,000 feet; type aircraft, BE-99; in clouds; rain; temperature minus 8 Celsius; wind 290 degrees magnetic at 30 knots; light to moderate turbulence; light rime icing during climb northwestbound from Roanoke, VA, between 8,000 and 10,000 feet at 1750 UTC.*

**TBL GEN 3.5–9  
PIREP Element Code Chart**

	PIREP ELEMENT	PIREP CODE	CONTENTS
1.	3–letter station identifier	XXX	Nearest weather reporting location to the reported phenomenon
2.	Report type	UA or UUA	Routine or urgent PIREP
3.	Location	/OV	In relation to a VOR
4.	Time	/TM	Coordinated Universal Time
5.	Altitude	/FL	Essential for turbulence and icing reports
6.	Type aircraft	/TP	Essential for turbulence and icing reports
7.	Sky cover	/SK	Cloud height and coverage (sky clear, few, scattered, broken, or overcast)
8.	Weather	/WX	Flight visibility, precipitation, restrictions to visibility, etc.
9.	Temperature	/TA	Degrees Celsius
10.	Wind	/WV	Direction in degrees magnetic north and speed in knots
11.	Turbulence	/TB	See paragraph 21.
12.	Icing	/IC	See paragraph 19.
13.	Remarks	/RM	For reporting elements not included or to clarify previously reported items

**18. Mandatory MET Points**

**18.1** Within the ICAO CAR/SAM Regions and within the U.S. area of responsibility, several mandatory MET reporting points have been established. These points are located within the Houston, Miami, and San Juan Flight Information Regions (FIR). These points have been established for flights between the South American and Caribbean Regions and Europe, Canada and the U.S.

**18.2 Mandatory MET Reporting Points Within the Houston FIR**

Point	For Flights Between
ABBOT	Acapulco and Montreal, New York, Toronto, Mexico City and New Orleans.
ALARD	New Orleans and Belize, Guatemala, San Pedro Sula, Mexico City and Miami, Tampa.
ARGUS	Toronto and Guadalajara, Mexico City, New Orleans and Mexico City.
SWORD	Dallas–Fort Worth, New Orleans, Chicago and Cancun, Cozumel, and Central America.

**18.3 Mandatory MET Reporting Points Within the Miami FIR**

Point	For Flights Between
Grand Turk	New York and Aruba, Curacao, Kingston, Miami and Belem, St. Thomas, Rio de Janeiro, San Paulo, St. Croix, Kingston and Bermuda.
GRATX	Madrid and Miami, Havana.
MAPYL	New York and Guayaquil, Montego Bay, Panama, Lima, Atlanta and San Juan.
RESIN	New Orleans and San Juan.
SLAPP	New York and Aruba, Curacao, Kingston, Port–au–Prince. Bermuda and Freeport, Nassau. New York and Barranquilla, Bogota, Santo Domingo, Washington and Santo Domingo, Atlanta and San Juan.

### 18.4 Mandatory MET Reporting Points Within the San Juan FIR

Point	For Flights Between
GRANN	Toronto and Barbados, New York and Fort de France. At intersection of routes A321, A523, G432.
KRAFT	San Juan and Buenos Aires, Caracas, St. Thomas, St. Croix, St. Maarten, San Juan, Kingston and Bermuda.
PISAX	New York and Barbados, Fort de France, Bermuda and Antigua, Barbados.

### 19. PIREPs Relating to Airframe Icing

**19.1** The effects of ice accretion on aircraft are: cumulative–thrust is reduced, drag increases, lift lessens, weight increases. The results are an increase in stall speed and a deterioration of aircraft performance. In extreme cases, 2 to 3 inches of ice can form on the leading edge of the airfoil in less than 5 minutes. It takes but 1/2 inch of ice to reduce the lifting power of some aircraft by 50 percent and to increase the frictional drag by an equal percentage.

**19.2** A pilot can expect icing when flying in visible precipitation, such as rain or cloud droplets, and the temperature is between +02 and –10 degrees Celsius. When icing is detected, a pilot should do one of two things (particularly if the aircraft is not equipped with deicing equipment). The pilot should get out of the area of precipitation or go to an altitude where the temperature is above freezing. This “warmer” altitude may not always be a lower altitude. Proper preflight action includes obtaining information on the freezing level and the above–freezing levels in precipitation areas. Report the icing to an ATC or FSS facility, and if operating IFR, request new routing or altitude if icing will be a hazard. Be sure to give the type of aircraft to ATC when reporting icing. TBL GEN 3.5–10 describes how to report icing conditions.

TBL GEN 3.5–10

Intensity	Ice Accumulation
Trace	Ice becomes noticeable. The rate of accumulation is slightly greater than the rate of sublimation. A representative accretion rate for reference purposes is less than ¼ inch (6 mm) per hour on the outer wing. The pilot should consider exiting the icing conditions before they become worse.
Light	The rate of ice accumulation requires occasional cycling of manual deicing systems to minimize ice accretions on the airframe. A representative accretion rate for reference purposes is ¼ inch to 1 inch (0.6 to 2.5 cm) per hour on the unprotected part of the outer wing. The pilot should consider exiting the icing condition.
Moderate	The rate of ice accumulation requires frequent cycling of manual deicing systems to minimize ice accretions on the airframe. A representative accretion rate for reference purposes is 1 to 3 inches (2.5 to 7.5 cm) per hour on the unprotected part of the outer wing. The pilot should consider exiting the icing condition as soon as possible.
Severe	The rate of ice accumulation is such that ice protection systems fail to remove the accumulation of ice and ice accumulates in locations not normally prone to icing, such as areas aft of protected surfaces and any other areas identified by the manufacturer. A representative accretion rate for reference purposes is more than 3 inches (7.5 cm) per hour on the unprotected part of the outer wing. By regulation, immediate exit is required.
Pilot Report: Aircraft Identification, Location, Time (UTC), Intensity of Type <sup>1</sup> , Altitude/FL, Aircraft Type, Indicated Air Speed (IAS), and Outside Air Temperature (OAT) <sup>2</sup> .	
<sup>1</sup> Rime or Clear Ice: Rime ice is a rough, milky, opaque ice formed by the instantaneous freezing of small supercooled water droplets. Clear ice is a glossy, clear, or translucent ice formed by the relatively slow freezing of large supercooled water droplets.	
<sup>2</sup> The Outside Air Temperature (OAT) should be requested by the FSS or ATC if not included in the PIREP.	
<i>NOTE – Severe icing is aircraft dependent, as are the other categories of icing intensity. Severe icing may occur at any ice accumulation rate when the icing rate or ice accumulations exceed the tolerance of the aircraft.</i>	

## 20. Definitions of Inflight Icing Terms

See TBL GEN 3.5–11, Icing Types, and TBL GEN 3.5–12, Icing Conditions.

### TBL GEN 3.5–11 Icing Types

<b>Clear Ice</b>	See Glaze Ice.
<b>Glaze Ice</b>	Ice, sometimes clear and smooth, but usually containing some air pockets, which results in a lumpy translucent appearance. Glaze ice results from supercooled drops/droplets striking a surface but not freezing rapidly on contact. Glaze ice is denser, harder, and sometimes more transparent than rime ice. Factors, which favor glaze formation, are those that favor slow dissipation of the heat of fusion (i.e., slight supercooling and rapid accretion). With larger accretions, the ice shape typically includes “horns” protruding from unprotected leading edge surfaces. It is the ice shape, rather than the clarity or color of the ice, which is most likely to be accurately assessed from the cockpit. The terms “clear” and “glaze” have been used for essentially the same type of ice accretion, although some reserve “clear” for thinner accretions which lack horns and conform to the airfoil.
<b>Intercycle Ice</b>	Ice which accumulates on a protected surface between actuation cycles of a deicing system.
<b>Known or Observed or Detected Ice Accretion</b>	Actual ice observed visually to be on the aircraft by the flight crew or identified by on-board sensors.
<b>Mixed Ice</b>	Simultaneous appearance or a combination of rime and glaze ice characteristics. Since the clarity, color, and shape of the ice will be a mixture of rime and glaze characteristics, accurate identification of mixed ice from the cockpit may be difficult.
<b>Residual Ice</b>	Ice which remains on a protected surface immediately after the actuation of a deicing system.
<b>Rime Ice</b>	A rough, milky, opaque ice formed by the rapid freezing of supercooled drops/droplets after they strike the aircraft. The rapid freezing results in air being trapped, giving the ice its opaque appearance and making it porous and brittle. Rime ice typically accretes along the stagnation line of an airfoil and is more regular in shape and conformal to the airfoil than glaze ice. It is the ice shape, rather than the clarity or color of the ice, which is most likely to be accurately assessed from the cockpit.
<b>Runback Ice</b>	Ice which forms from the freezing or refreezing of water leaving protected surfaces and running back to unprotected surfaces.
<i>Note— Ice types are difficult for the pilot to discern and have uncertain effects on an airplane in flight. Ice type definitions will be included in the AIP for use in the “Remarks” section of the PIREP and for use in forecasting.</i>	

*TBL GEN 3.5–12*  
**Icing Conditions**

<b>Appendix C Icing Conditions</b>	Appendix C (14 CFR, Part 25 and 29) is the certification icing condition standard for approving ice protection provisions on aircraft. The conditions are specified in terms of altitude, temperature, liquid water content (LWC), representative droplet size (mean effective drop diameter [MED]), and cloud horizontal extent.
<b>Forecast Icing Conditions</b>	Environmental conditions expected by a National Weather Service or an FAA–approved weather provider to be conducive to the formation of inflight icing on aircraft.
<b>Freezing Drizzle (FZDZ)</b>	Drizzle is precipitation at ground level or aloft in the form of liquid water drops which have diameters less than 0.5 mm and greater than 0.05 mm. Freezing drizzle is drizzle that exists at air temperatures less than 0°C (supercooled), remains in liquid form, and freezes upon contact with objects on the surface or airborne.
<b>Freezing Precipitation</b>	Freezing precipitation is freezing rain or freezing drizzle falling through or outside of visible cloud.
<b>Freezing Rain (FZRA)</b>	Rain is precipitation at ground level or aloft in the form of liquid water drops which have diameters greater than 0.5 mm. Freezing rain is rain that exists at air temperatures less than 0°C (supercooled), remains in liquid form, and freezes upon contact with objects on the ground or in the air.
<b>Icing in Cloud</b>	Icing occurring within visible cloud. Cloud droplets (diameter < 0.05 mm) will be present; freezing drizzle and/or freezing rain may or may not be present.
<b>Icing in Precipitation</b>	Icing occurring from an encounter with freezing precipitation, that is, supercooled drops with diameters exceeding 0.05 mm, within or outside of visible cloud.
<b>Known Icing Conditions</b>	Atmospheric conditions in which the formation of ice is observed or detected in flight. <i>Note—</i> <i>Because of the variability in space and time of atmospheric conditions, the existence of a report of observed icing does not assure the presence or intensity of icing conditions at a later time, nor can a report of no icing assure the absence of icing conditions at a later time.</i>
<b>Potential Icing Conditions</b>	Atmospheric icing conditions that are typically defined by airframe manufacturers relative to temperature and visible moisture that may result in aircraft ice accretion on the ground or in flight. The potential icing conditions are typically defined in the Airplane Flight Manual or in the Airplane Operation Manual.
<b>Supercooled Drizzle Drops (SCDD)</b>	Synonymous with freezing drizzle aloft.
<b>Supercooled Drops or /Droplets</b>	Water drops/droplets which remain unfrozen at temperatures below 0°C. Supercooled drops are found in clouds, freezing drizzle, and freezing rain in the atmosphere. These drops may impinge and freeze after contact on aircraft surfaces.
<b>Supercooled Large Drops (SLD)</b>	Liquid droplets with diameters greater than 0.05 mm at temperatures less than 0°C, i.e., freezing rain or freezing drizzle.

**21. PIREPs Relating to Turbulence**

**21.1** When encountering turbulence, pilots are urgently requested to report such conditions to ATC as soon as practicable. PIREPs relating to turbulence should state:

**21.1.1** Aircraft location.

**21.1.2** Time of occurrence in UTC.

**21.1.3** Turbulence intensity.

**21.1.4** Whether the turbulence occurred in or near clouds.

**21.1.5** Aircraft altitude, or flight level.

**21.1.6** Type of aircraft.

**21.1.7** Duration of turbulence.

**EXAMPLE–**

1. Over Omaha, 1232Z, moderate turbulence in clouds at Flight Level three one zero, Boeing 707.
2. From five zero miles south of Albuquerque to three zero miles north of Phoenix, 1250Z, occasional moderate chop at Flight Level three three zero, DC8.

**21.2** Duration and classification of intensity should be made using TBL GEN 3.5–13, Turbulence Reporting Criteria Table.

*TBL GEN 3.5–13*  
**Turbulence Reporting Criteria Table**

Intensity	Aircraft Reaction	Reaction inside Aircraft	Reporting Term–Definition
Light	Turbulence that momentarily causes slight, erratic changes in altitude and/or attitude (pitch, roll, yaw). Report as <b>Light Turbulence</b> ; <sup>1</sup> or Turbulence that causes slight, rapid and somewhat rhythmic bumpiness without appreciable changes in altitude or attitude. Report as <b>Light Chop</b> .	Occupants may feel a slight strain against seat belts or shoulder straps. Unsecured objects may be displaced slightly. Food service may be conducted, and little or no difficulty is encountered in walking.	Occasional–Less than 1/3 of the time. Intermittent–1/3 to 2/3. Continuous–More than 2/3.
Moderate	Turbulence that is similar to Light Turbulence but of greater intensity. Changes in altitude and/or attitude occur, but the aircraft remains in positive control at all times. It usually causes variations in indicated airspeed. Report as <b>Moderate Turbulence</b> ; <sup>1</sup> or Turbulence that is similar to Light Chop but of greater intensity. It causes rapid bumps or jolts without appreciable changes in aircraft altitude or attitude. Report as <b>Moderate Chop</b> . <sup>1</sup>	Occupants feel definite strains against seat belts or shoulder straps. Unsecured objects are dislodged. Food service and walking are difficult.	<b>NOTE</b> 1. Pilots should report location(s), time (UTC), intensity, whether in or near clouds, altitude, type of aircraft and, when applicable, duration of turbulence.  2. Duration may be based on time between two locations or over a single location. All locations should be readily identifiable.
Severe	Turbulence that causes large, abrupt changes in altitude and/or attitude. It usually causes large variations in indicated airspeed. Aircraft may be momentarily out of control. Report as <b>Severe Turbulence</b> . <sup>1</sup>	Occupants are forced violently against seat belts or shoulder straps. Unsecured objects are tossed about. Food service and walking are impossible.	<b>EXAMPLES:</b> a. Over Omaha. 1232Z, Moderate Turbulence, in cloud, Flight Level 310, B707.
Extreme	Turbulence in which the aircraft is violently tossed about and is practically impossible to control. It may cause structural damage. Report as <b>Extreme Turbulence</b> . <sup>1</sup>		b. From 50 miles south of Albuquerque to 30 miles north of Phoenix, 1210Z to 1250Z, occasional Moderate Chop, Flight Level 330, DC8.
<sup>1</sup> High level turbulence (normally above 15,000 feet ASL) not associated with cumuliform cloudiness, including thunderstorms, should be reported as clear air turbulence (CAT) preceded by the appropriate intensity, or light or moderate chop.			

**22. Wind Shear PIREPs**

**22.1** Because unexpected changes in wind speed and direction can be hazardous to aircraft operations at low altitudes on approach to and departing from airports, pilots are urged to promptly volunteer reports to controllers of wind shear conditions they encounter. An advance warning of this information will assist other pilots in avoiding or coping with a wind shear on approach or departure.

**22.2** When describing conditions, the use of the terms “negative” or “positive” wind shear should be avoided. PIREPs of negative wind shear on final, intended to describe loss of airspeed and lift, have been interpreted to

mean that no wind shear was encountered. The recommended method for wind shear reporting is to state the loss/gain of airspeed and the altitude(s) at which it was encountered.

**EXAMPLE–**

1. *Denver Tower, Cessna 1234 encountered wind shear, loss of 20 knots at 400.*
2. *Tulsa Tower, American 721 encountered wind shear on final, gained 25 knots between 600 and 400 feet followed by loss of 40 knots between 400 feet and surface.*

Pilots using Inertial Navigation Systems should report the wind and altitude both above and below the shear layer.

**EXAMPLE–**

*Miami Tower, Gulfstream 403 Charlie encountered an abrupt wind shear at 800 feet on final, max thrust required.*

Pilots who are not able to report wind shear in these specific terms are encouraged to make reports in terms of the effect upon their aircraft.

### 22.3 Wind Shear Escape

**22.3.1** Pilots should report to ATC when they are performing a wind shear escape maneuver. This report should be made as soon as practicable, but not until aircraft safety and control is assured, which may not be satisfied until the aircraft is clear of the wind shear or microburst. ATC should provide safety alerts and traffic advisories, as appropriate.

**EXAMPLE–**

*“Denver Tower, United 1154, wind shear escape.”*

**22.3.2** Once the pilot initiates a wind shear escape maneuver, ATC is not responsible for providing approved separation between the aircraft and any other aircraft, airspace, terrain, or obstacle until the pilot reports that the escape procedure is complete and approved separation has been re-established. Pilots should advise ATC that they are resuming the previously assigned clearance or should request an alternate clearance.

**EXAMPLE–**

*“Denver Tower, United 1154, wind shear escape complete, resuming last assigned heading/(name) DP/clearance.”*

or

*“Denver Tower, United 1154, wind shear escape complete, request further instructions.”*

## 23. Clear Air Turbulence (CAT) PIREPs

**23.1** Clear air turbulence (CAT) has become a very serious operational factor to flight operations at all levels and especially to jet traffic flying in excess of 15,000 feet. The best available information on this phenomenon must come from pilots via the PIREP procedures. All pilots encountering CAT conditions are urgently requested to report time, location, and intensity (light, moderate, severe, or extreme) of the element to the FAA facility with which they are maintaining radio contact. If time and conditions permit, elements should be reported according to the standards for other PIREPs and position reports. See TBL GEN 3.5–13, Turbulence Reporting Criteria Table.

## 24. Microbursts

**24.1** Relatively recent meteorological studies have confirmed the existence of microburst phenomena. Microbursts are small-scale intense downdrafts which, on reaching the surface, spread outward in all directions from the downdraft center. This causes the presence of both vertical and horizontal wind shears that can be extremely hazardous to all types and categories of aircraft, especially at low altitudes. Due to their small size, short life-span, and the fact that they can occur over areas without surface precipitation, microbursts are not easily detectable using conventional weather radar or wind shear alert systems.

**24.2** Parent clouds producing microburst activity can be any of the low or middle layer convective cloud types. Note however, that microbursts commonly occur within the heavy rain portion of thunderstorms, and in much weaker, benign-appearing convective cells that have little or no precipitation reaching the ground.

**24.3** The life cycle of a microburst as it descends in a convective rain shaft is seen in FIG GEN 3.5–8, Evolution of a Microburst. An important consideration for pilots is the fact that the microburst intensifies for about 5 minutes after it strikes the ground.

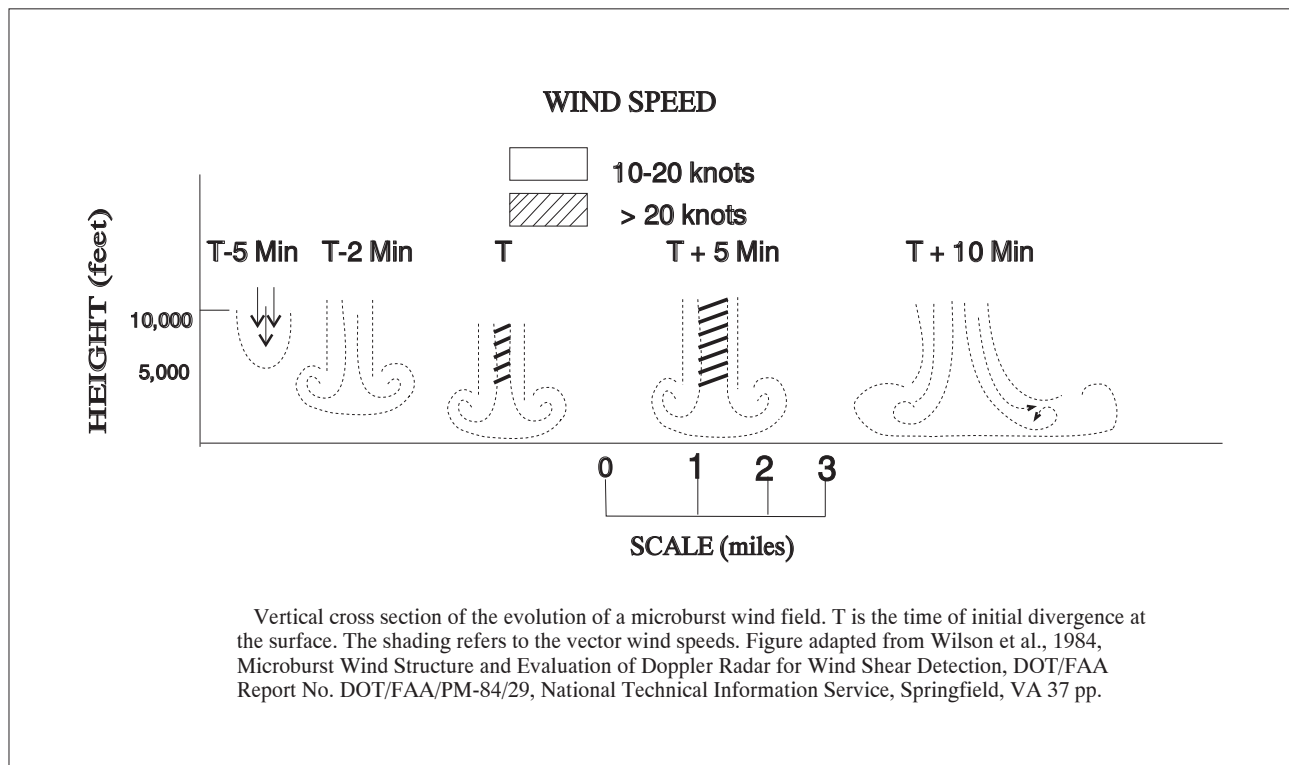
**24.4 Characteristics of microbursts include:**

**24.4.1 Size.** The microburst downdraft is typically less than 1 mile in diameter as it descends from the cloud base to about 1,000–3,000 feet above the ground. In the transition zone near the ground, the downdraft changes to a horizontal outflow that can extend to approximately 2 1/2 miles in diameter.

**24.4.2 Intensity.** The downdrafts can be as strong as 6,000 feet per minute. Horizontal winds near the surface can be as strong as 45 knots resulting in a 90–knot shear (headwind to tailwind change for a traversing aircraft) across the microburst. These strong horizontal winds occur within a few hundred feet of the ground.

**24.4.3 Visual Signs.** Microbursts can be found almost anywhere that there is convective activity. They may be embedded in heavy rain associated with a thunderstorm or in light rain in benign– appearing virga. When there is little or no precipitation at the surface accompanying the microburst, a ring of blowing dust may be the only visual clue of its existence.

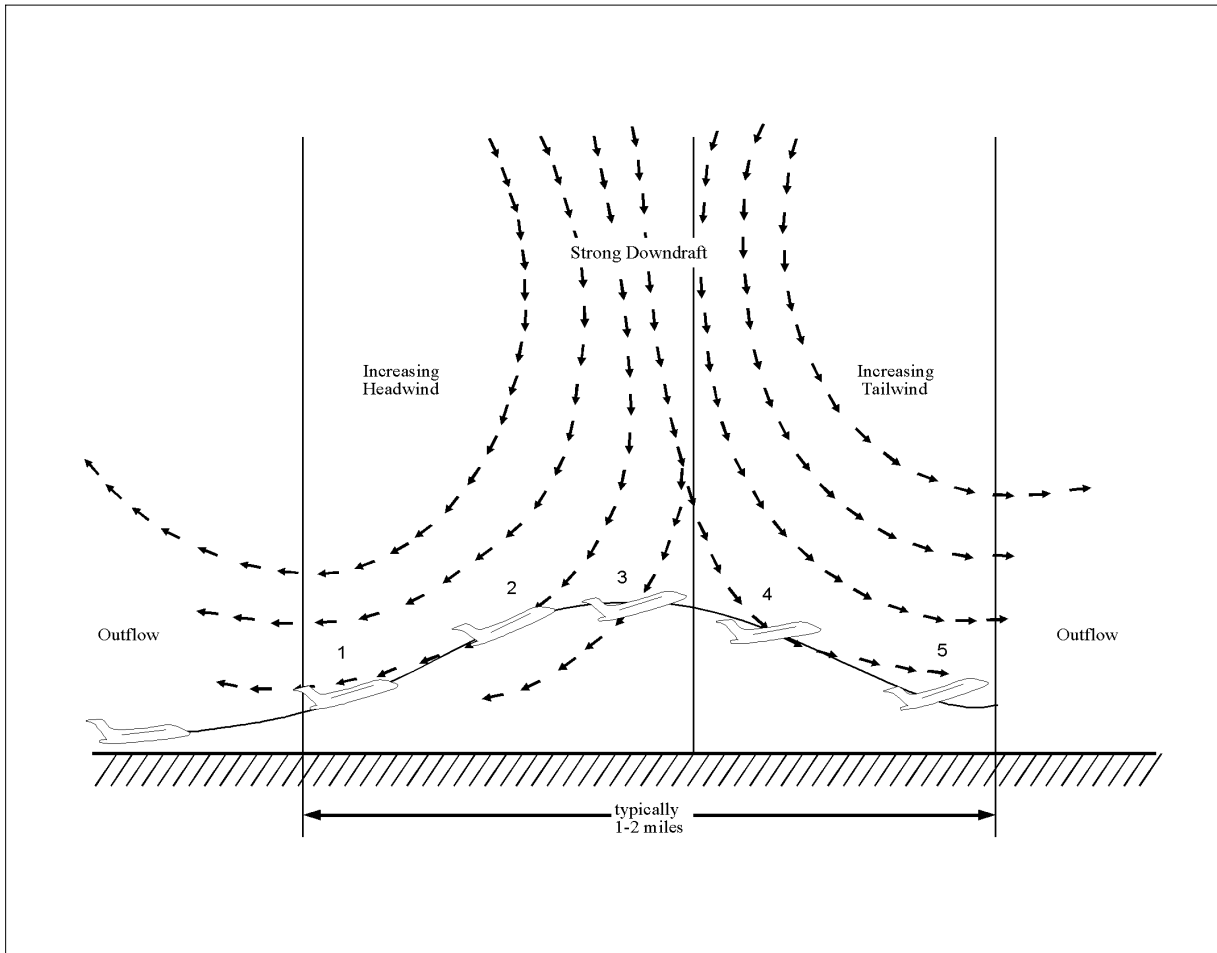
FIG GEN 3.5–8  
Evolution of a Microburst



**24.4.4 Duration.** An individual microburst will seldom last longer than 15 minutes from the time it strikes the ground until dissipation. The horizontal winds continue to increase during the first 5 minutes with the maximum intensity winds lasting approximately 2–4 minutes. Sometimes microbursts are concentrated into a line structure and, under these conditions, activity may continue for as long as 1 hour. Once microburst activity starts, multiple microbursts in the same general area are not uncommon and should be expected.



FIG GEN 3.5-9  
Microburst Encounter During Takeoff



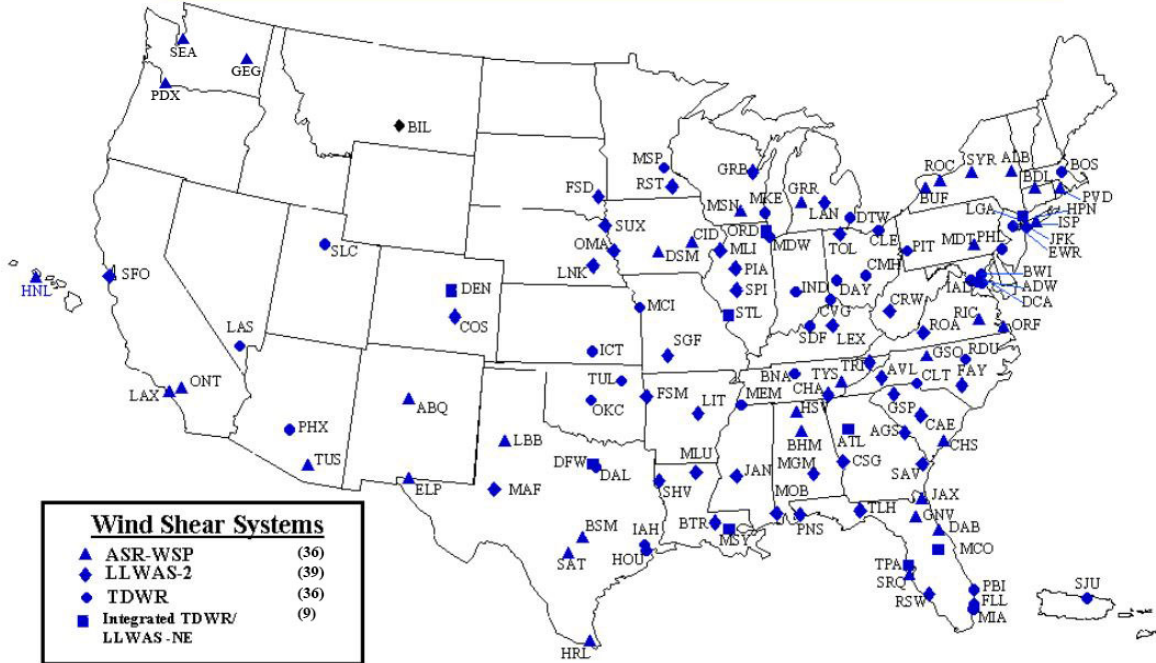
**NOTE-**

A microburst encounter during takeoff. The airplane first encounters a headwind and experiences increasing performance (1), this is followed in short succession by a decreasing headwind component (2), a downdraft (3), and finally a strong tailwind (4), where 2 through 5 all result in decreasing performance of the airplane. Position (5) represents an extreme situation just prior to impact. Figure courtesy of Walter Frost, FWG Associates, Inc., Tullahoma, Tennessee.

**24.5** Microburst wind shear may create a severe hazard for aircraft within 1,000 feet of the ground, particularly during the approach to landing and landing and take-off phases. The impact of a microburst on aircraft which have the unfortunate experience of penetrating one is characterized in FIG GEN 3.5-9. The aircraft may encounter a headwind (performance increasing), followed by a downdraft and a tailwind (both performance decreasing), possibly resulting in terrain impact.

FIG GEN 3.5–10  
NAS Wind Shear Product Systems

# NAS Wind Shear Product Systems



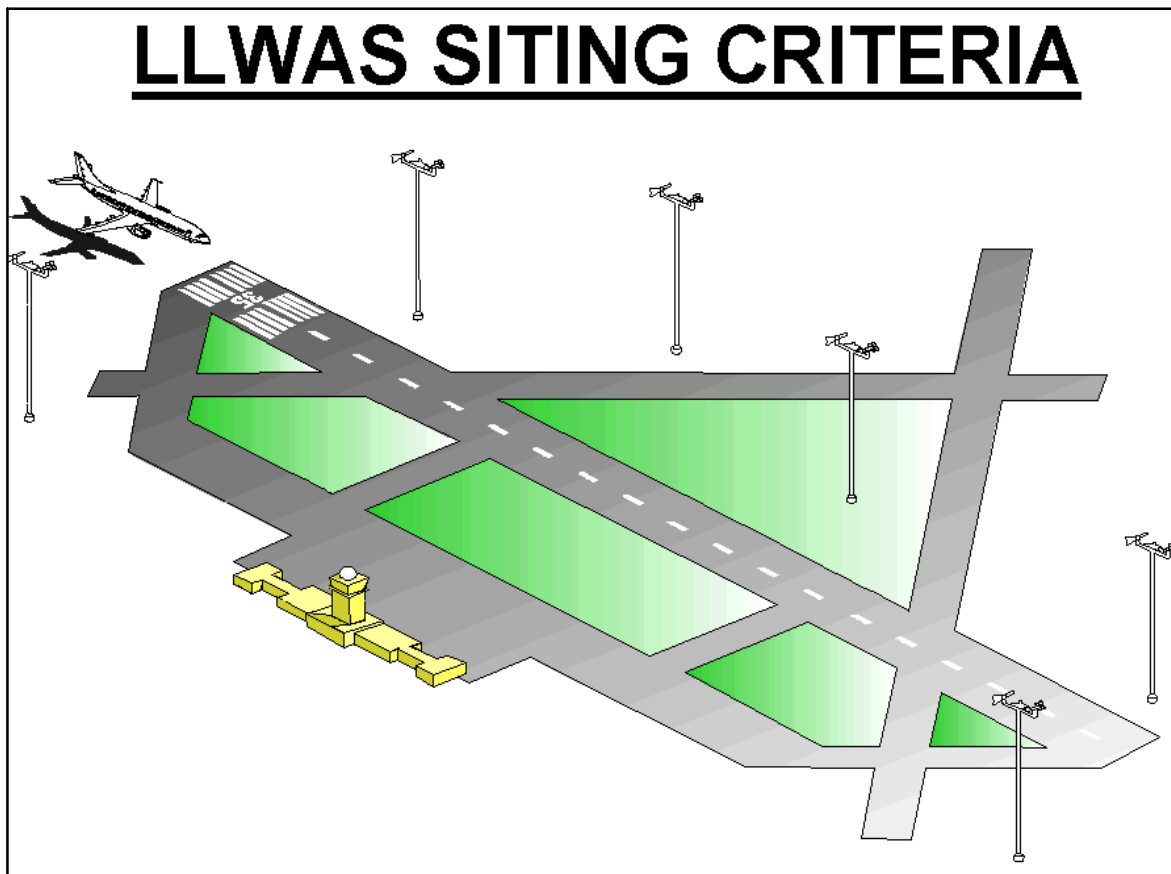
## 24.6 Detection of Microbursts, Wind Shear, and Gust Fronts

### 24.6.1 FAA’s Integrated Wind Shear Detection Plan

**24.6.1.1** The FAA currently employs an integrated plan for wind shear detection that will significantly improve both the safety and capacity of the majority of the airports currently served by the air carriers. This plan integrates several programs, such as the Integrated Terminal Weather System (ITWS), Terminal Doppler Weather Radar (TDWR), Weather System Processor (WSP), and Low Level Wind Shear Alert Systems (LLWAS) into a single strategic concept that significantly improves the aviation weather information in the terminal area. (See FIG GEN 3.5–10.)

**24.6.1.2** The wind shear/microburst information and warnings are displayed on the ribbon display terminal (RBDT) located in the tower cabs. They are identical (and standardized) to those in the LLWAS, TDWR and WSP systems, and designed so that the controller does not need to interpret the data, but simply read the displayed information to the pilot. The RBDTs are constantly monitored by the controller to ensure the rapid and timely dissemination of any hazardous event(s) to the pilot.

FIG GEN 3.5-11  
LLWAS Siting Criteria



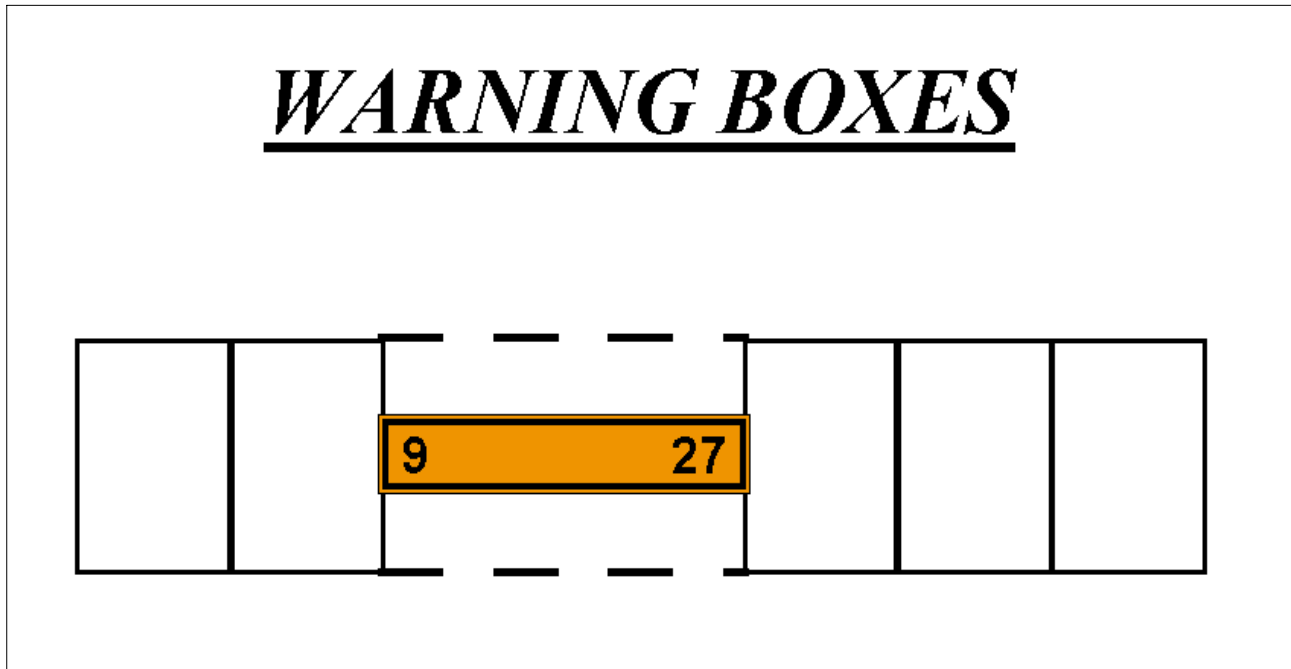
**24.6.1.3** The early detection of a wind shear/microburst event, and the subsequent warning(s) issued to an aircraft on approach or departure, will alert the pilot/crew to the potential of, and to be prepared for, a situation that could become very dangerous! Without these warnings, the aircraft may NOT be able to climb out of or safely transition the event, resulting in a catastrophe. The air carriers, working with the FAA, have developed specialized training programs using their simulators to train and prepare their pilots on the demanding aircraft procedures required to escape these very dangerous wind shear and/or microburst encounters.

**24.6.1.4 Low Level Wind Shear Alert System (LLWAS)**

a) The LLWAS provides wind data and software processes to detect the presence of hazardous wind shear and microbursts in the vicinity of an airport. Wind sensors, mounted on poles sometimes as high as 150 feet, are (ideally) located 2,000 – 3,500 feet, but not more than 5,000 feet, from the centerline of the runway. (See FIG GEN 3.5-11.)

b) The LLWAS was fielded in 1988 at 110 airports across the nation. Many of these systems have been replaced by new Terminal Doppler Weather Radar (TDWR) and Weather Systems Processor (WSP) technology. While all legacy LLWAS systems will eventually be phased out, 39 airports will be upgraded to LLWAS-NE (Network Expansion) system. The new LLWAS-NE systems not only provide the controller with wind shear warnings and alerts, including wind shear/microburst detection at the airport wind sensor location, but also provide the location of the hazards relative to the airport runway(s). It also has the flexibility and capability to grow with the airport as new runways are built. As many as 32 sensors, strategically located around the airport and in relationship to its runway configuration, can be accommodated by the LLWAS-NE network.

FIG GEN 3.5–12  
Warning Boxes



#### 24.6.1.5 Terminal Doppler Weather Radar (TDWR)

a) TDWRs have been deployed at 45 locations across the U.S. Optimum locations for TDWRs are 8 to 12 miles from the airport proper, and designed to look at the airspace around and over the airport to detect microbursts, gust fronts, wind shifts, and precipitation intensities. TDWR products advise the controller of wind shear and microburst events impacting all runways and the areas  $\frac{1}{2}$  mile on either side of the extended centerline of the runways and to a distance of 3 miles on final approach and 2 miles on departure. FIG GEN 3.5–12 is a theoretical view of the runway and the warning boxes that the software uses to determine the location(s) of wind shear or microbursts. These warnings are displayed (as depicted in the examples in subparagraph e) on the ribbon display terminal located in the tower cabs.

b) It is very important to understand what TDWR DOES NOT DO:

- 1) It **DOES NOT** warn of wind shear outside of the alert boxes (on the arrival and departure ends of the runways).
- 2) It **DOES NOT** detect wind shear that is NOT a microburst or a gust front.
- 3) It **DOES NOT** detect gusty or cross wind conditions.
- 4) It **DOES NOT** detect turbulence.

However, research and development is continuing on these systems. Future improvements may include such areas as storm motion (movement), improved gust front detection, storm growth and decay, microburst prediction, and turbulence detection.

c) TDWR also provides a geographical situation display (GSD) for supervisors and traffic management specialists for planning purposes. The GSD displays (in color) 6 levels of weather (precipitation), gust fronts and predicted storm movement(s). This data is used by the tower supervisor(s), traffic management specialists, and controllers to plan for runway changes and arrival/departure route changes in order to reduce aircraft delays and increase airport capacity.

#### 24.6.1.6 Weather Systems Processor (WSP)

a) The WSP provides the controller, supervisor, traffic management specialist, and ultimately the pilot, with the same products as the terminal doppler weather radar at a fraction of the cost. This is accomplished by utilizing

new technologies to access the weather channel capabilities of the existing ASR–9 radar located on or near the airport, thus eliminating the requirements for a separate radar location, land acquisition, support facilities, and the associated communication landlines and expenses.

b) The WSP utilizes the same RBDT display as the TDWR and LLWAS, and, like the TDWR, has a GSD for planning purposes by supervisors, traffic management specialists, and controllers. The WSP GSD emulates the TDWR display; i.e., it also depicts 6 levels of precipitation, gust fronts and predicted storm movement, and like the TDWR, GSD is used to plan for runway changes and arrival/departure route changes in order to reduce aircraft delays and to increase airport capacity.

c) This system is installed at 34 airports across the nation, substantially increasing the safety of flying.

#### 24.6.1.7 Operational Aspects of LLWAS, TDWR, and WSP

To demonstrate how this data is used by both the controller and the pilot, 3 ribbon display examples and their explanations are presented:

##### a) MICROBURST ALERTS

###### EXAMPLE–

*This is what the controller sees on his/her ribbon display in the tower cab.*

27A MBA 35K– 2MF 250 20

###### NOTE–

*(See FIG GEN 3.5–13 to see how the TDWR/WSP determines the microburst location).*

This is what the controller will say when issuing the alert.

###### PHRASEOLOGY–

*RUNWAY 27 ARRIVAL, MICROBURST ALERT, 35 KT LOSS 2 MILE FINAL, THRESHOLD WINDS 250 AT 20.*

In plain language, the controller is telling the pilot that on approach to runway 27, there is a microburst alert on the approach lane to the runway, and to anticipate or expect a 35–knot loss of airspeed at approximately 2 miles out on final approach (where the aircraft will first encounter the phenomena). With that information, the aircrew is forewarned, and should be prepared to apply wind shear/microburst escape procedures should they decide to continue the approach. Additionally, the surface winds at the airport for landing runway 27 are reported as 250 degrees at 20 knots.

###### NOTE–

*Threshold wind is at pilot’s request or as deemed appropriate by the controller.*

##### b) WIND SHEAR ALERTS

###### EXAMPLE–

*This is what the controller sees on his/her ribbon display in the tower cab.*

27A WSA 20K– 3MF 200 15

###### NOTE–

*(See FIG GEN 3.5–14 to see how the TDWR/WSP determines the wind shear location).*

This is what the controller will say when issuing the alert.

###### PHRASEOLOGY–

*RUNWAY 27 ARRIVAL, WIND SHEAR ALERT, 20 KT LOSS 3 MILE FINAL, THRESHOLD WINDS 200 AT 15.*

In plain language, the controller is advising the aircraft arriving on runway 27 that at 3 miles out the pilot should expect to encounter a wind shear condition that will decrease airspeed by 20 knots and possibly the aircraft will encounter turbulence. Additionally, the airport surface winds for landing runway 27 are reported as 200 degrees at 15 knots.

###### NOTE–

*Threshold wind is at pilot’s request or as deemed appropriate by the controller.*

FIG GEN 3.5-13  
Microburst Alert

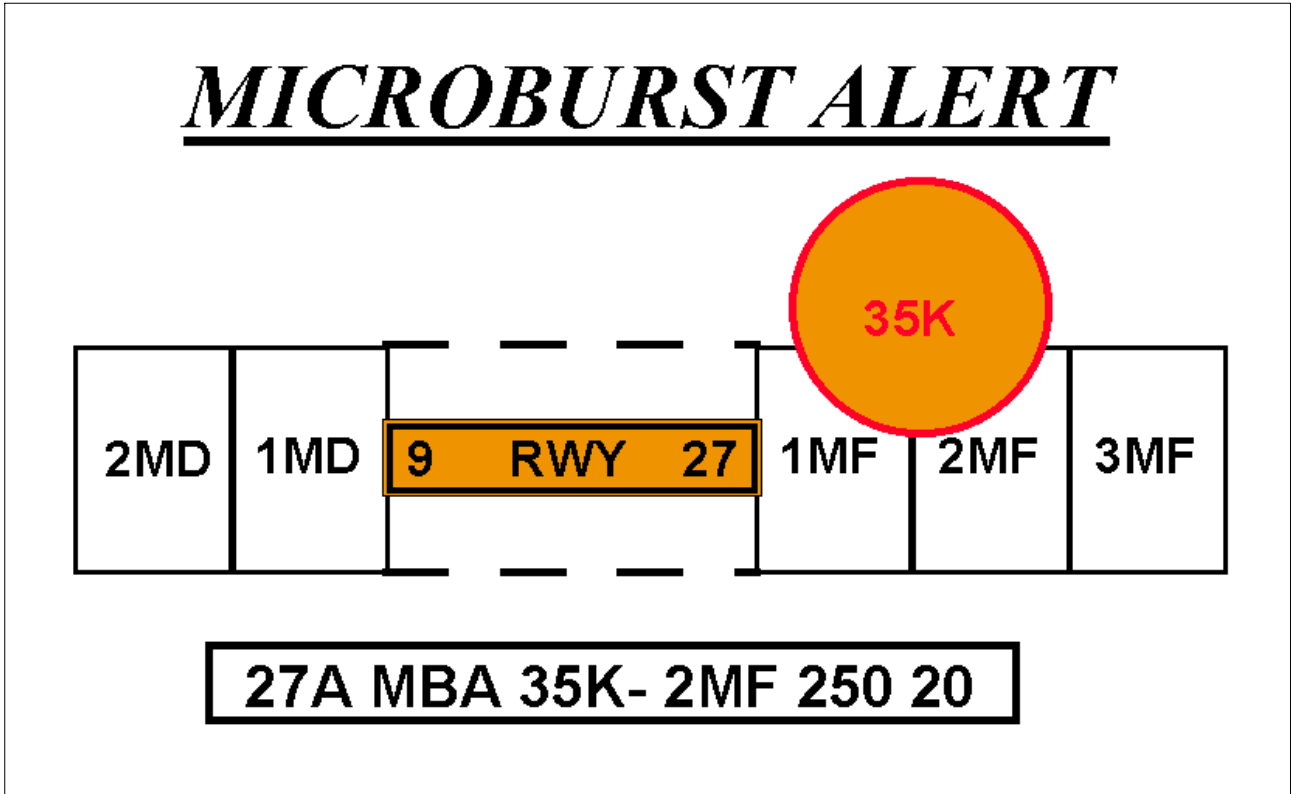


FIG GEN 3.5-14  
Weak Microburst Alert

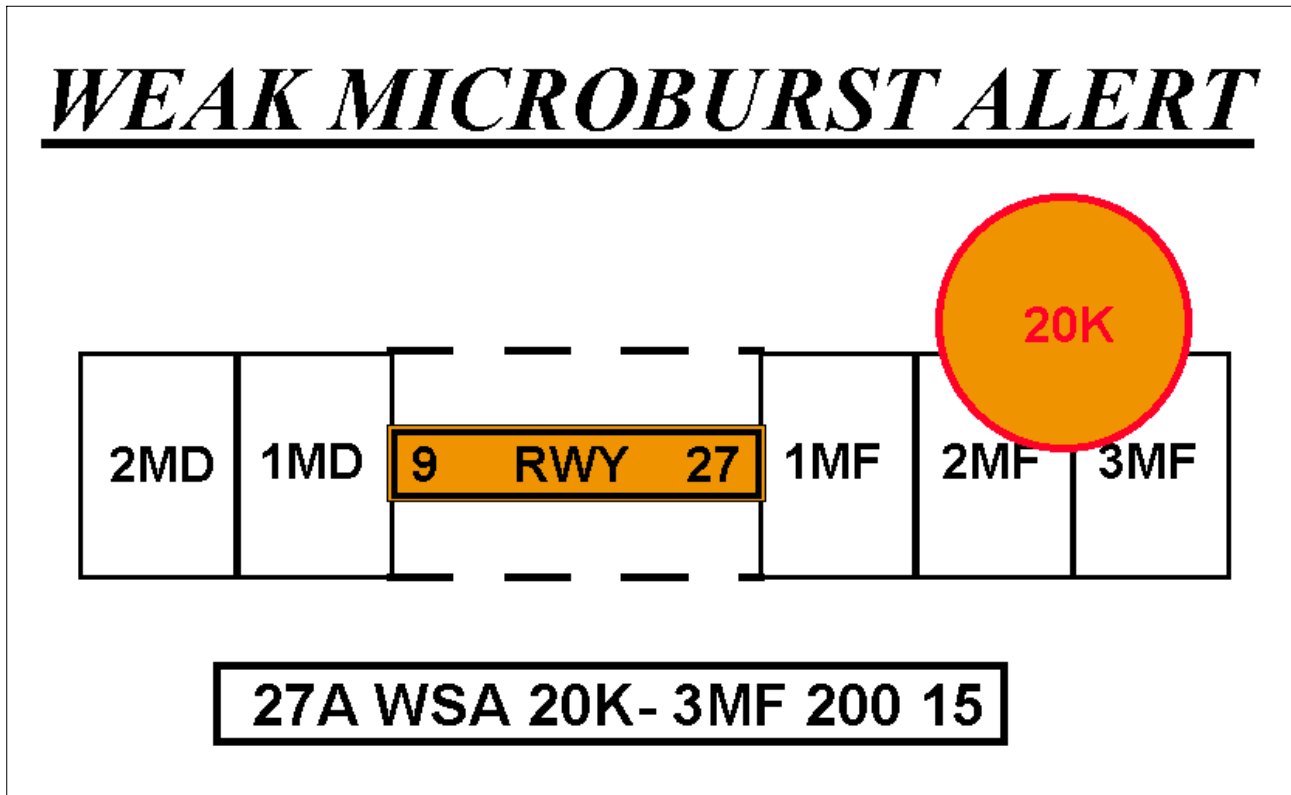
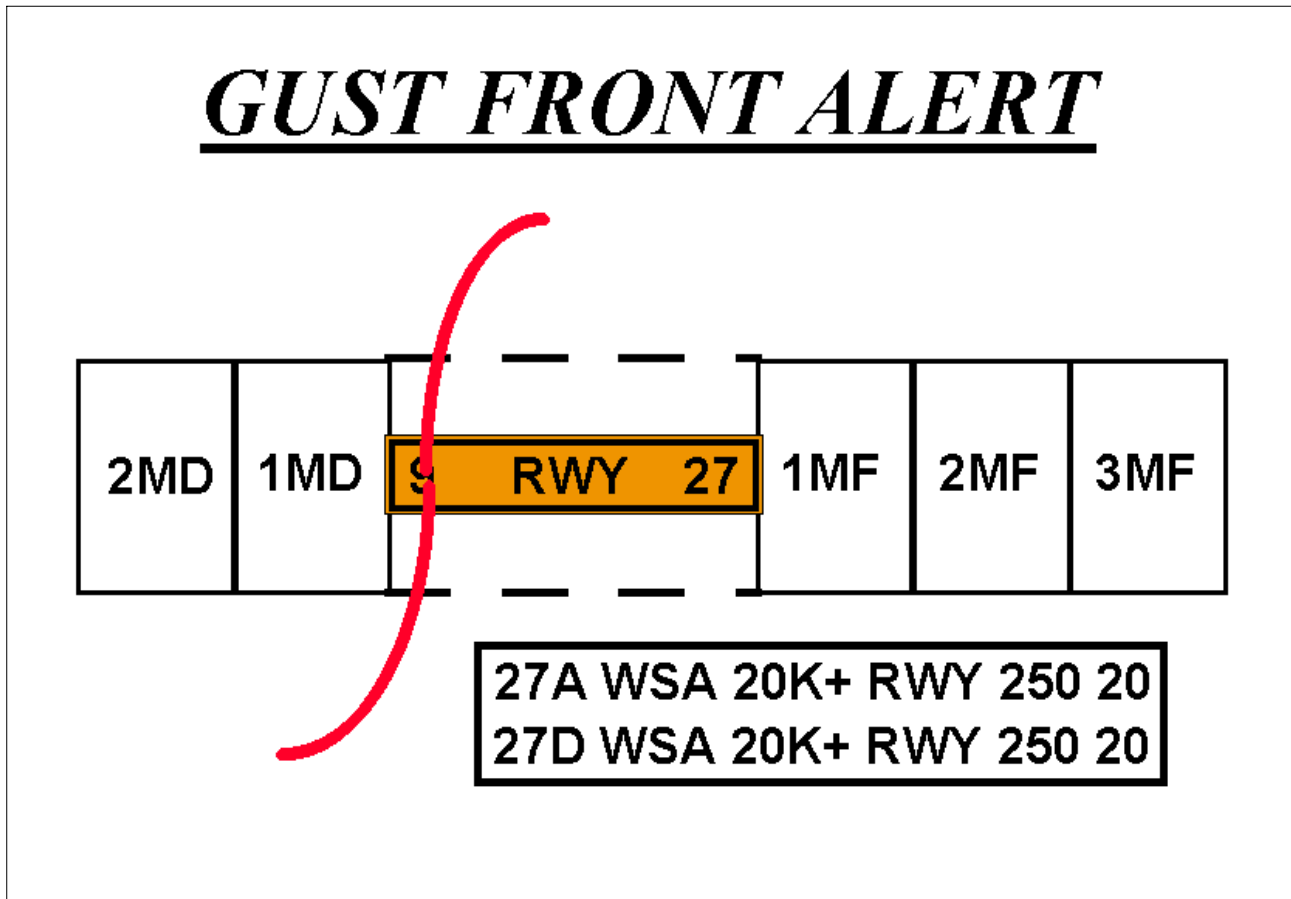


FIG GEN 3.5-15  
Gust Front Alert



**c) MULTIPLE WIND SHEAR ALERTS**

**EXAMPLE-**

*This is what the controller sees on his/her ribbon display in the tower cab.*

27A WSA 20K+ RWY 250 20
27D WSA 20K+ RWY 250 20

**NOTE-**

*(See FIG GEN 3.5-15 to see how the TDWR/WSP determines the gust front/wind shear location).*

This is what the controller will say when issuing the alert.

**PHRASEOLOGY-**

**MULTIPLE WIND SHEAR ALERTS.**

**RUNWAY 27 ARRIVAL, WIND SHEAR ALERT, 20 KT GAIN ON RUNWAY;**

**RUNWAY 27 DEPARTURE, WIND SHEAR ALERT, 20 KT GAIN ON RUNWAY, WINDS 250 AT 20.**

**EXAMPLE-**

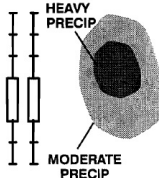
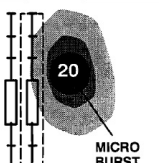
*In this example, the controller is advising arriving and departing aircraft that they could encounter a wind shear condition right on the runway due to a gust front (significant change of wind direction) with the possibility of a 20 knot gain in airspeed associated with the gust front. Additionally, the airport surface winds (for the runway in use) are reported as 250 degrees at 20 knots.*



**24.6.1.8 The Terminal Weather Information for Pilots System (TWIP)**

a) With the increase in the quantity and quality of terminal weather information available through TDWR, the next step is to provide this information directly to pilots rather than relying on voice communications from ATC. The National Airspace System (NAS) has long been in need of a means of delivering terminal weather information to the cockpit more efficiently in terms of both speed and accuracy to enhance pilot awareness of weather hazards and reduce air traffic controller workload. With the TWIP capability, terminal weather information, both alphanumerically and graphically, is now available directly to the cockpit for 46 airports in the U.S. NAS. (See FIG GEN 3.5-16.)

FIG GEN 3.5-16  
TWIP Image of Convective Weather at MCO International

WEATHER SITUATION	TWIP TEXT MESSAGE
 <p>HEAVY PRECIP MODERATE PRECIP</p>	<p>MCO 1800 TERMINAL WEATHER -STORM(S) 3NM N-E MOD PRECIP 4NM NE HVY PRECIP MOVG W AT 15KT .EXPECTED MOD PRECIP BEGIN 1805</p>
 <p>20 MICRO BURST</p>	<p>MCO 1810 TERMINAL WEATHER *MODERATE PRECIP BEGAN 1805 -STORM(S) ARPT ALQDS MOD PRECIP 1NM N-E HVY PRECIP MOVG W AT 15KT .EXPECTED HVY PRECIP BEGIN 1815</p>

b) TWIP products are generated using weather data from the TDWR or the Integrated Terminal Weather System (ITWS). These products can then be accessed by pilots using the Aircraft Communications Addressing and Reporting System (ACARS) data link services. Airline dispatchers can also access this database and send messages to specific aircraft whenever wind shear activity begins or ends at an airport.

c) TWIP products include descriptions and character graphics of microburst alerts, wind shear alerts, significant precipitation, convective activity within 30 NM surrounding the terminal area, and expected weather that will impact airport operations. During inclement weather; i.e., whenever a predetermined level of precipitation or wind shear is detected within 15 miles of the terminal area, TWIP products are updated once each minute for text messages and once every 5 minutes for character graphic messages. During good weather (below the predetermined precipitation or wind shear parameters) each message is updated every 10 minutes. These products are intended to improve the situational awareness of the pilot/flight crew, and to aid in flight planning prior to arriving or departing the terminal area. It is important to understand that, in the context of TWIP, the predetermined levels for inclement versus good weather has nothing to do with the criteria for VFR/MVFR/IFR/LIFR; it only deals with precipitation, wind shears, and microbursts.

TBL GEN 3.5–14  
**TWIP–Equipped Airports**

<b>Airport</b>	<b>Identifier</b>
Andrews AFB, MD	KADW
Hartsfield–Jackson Atlanta Intl Airport	KATL
Nashville Intl Airport	KBNA
Logan Intl Airport	KBOS
Baltimore/Washington Intl Airport	KBWI
Hopkins Intl Airport	KCLE
Charlotte/Douglas Intl Airport	KCLT
Port Columbus Intl Airport	KCMH
Cincinnati/Northern Kentucky Intl Airport	KCVG
Dallas Love Field Airport	KDAL
James M. Cox Intl Airport	KDAY
Ronald Reagan Washington National Airport	KDCA
Denver Intl Airport	KDEN
Dallas–Fort Worth Intl Airport	KDFW
Detroit Metro Wayne County Airport	KDTW
Newark Liberty Intl Airport	KEWR
Fort Lauderdale–Hollywood Intl Airport	KFLL
William P. Hobby Airport	KHOU
Washington Dulles Intl Airport	KIAD
George Bush Intercontinental Airport	KIAH
Wichita Mid–Continent Airport	KICT
Indianapolis Intl Airport	KIND
John F. Kennedy Intl Airport	KJFK

<b>Airport</b>	<b>Identifier</b>
Harry Reid Intl Airport	KLAS
LaGuardia Airport	KLGA
Kansas City Intl Airport	KMCI
Orlando Intl Airport	KMCO
Midway Intl Airport	KMDW
Memphis Intl Airport	KMEM
Miami Intl Airport	KMIA
General Mitchell Intl Airport	KMKE
Minneapolis St. Paul Intl Airport	KMSP
Louis Armstrong New Orleans Intl Airport	KMSY
Will Rogers World Airport	KOKC
O’Hare Intl Airport	KORD
Palm Beach Intl Airport	KPBI
Philadelphia Intl Airport	KPHL
Phoenix Sky Harbor Intl Airport	KPHX
Pittsburgh Intl Airport	KPIT
Raleigh–Durham Intl Airport	KRDU
Louisville Intl Airport	KSDF
Salt Lake City Intl Airport	KSLC
Lambert–St. Louis Intl Airport	KSTL
Tampa Intl Airport	KTPA
Tulsa Intl Airport	KTUL
Luis Munoz Marin Intl Airport	TJSJ

**25. PIREPs Relating to Volcanic Ash Activity**

**25.1** Volcanic eruptions which send ash into the upper atmosphere occur somewhere around the world several times each year. Flying into a volcanic ash cloud can be exceedingly dangerous. At least two B747s have lost all power in all four engines after such an encounter. Regardless of the type aircraft, some damage is almost certain to ensue after an encounter with a volcanic ash cloud. Additionally, studies have shown that volcanic eruptions are the only significant source of large quantities of sulphur dioxide (SO<sub>2</sub>) gas at jet-cruising altitudes. Therefore, the detection and subsequent reporting of SO<sub>2</sub> is of significant importance. Although SO<sub>2</sub> is colorless, its presence in the atmosphere should be suspected when a sulphur-like or rotten egg odor is present throughout the cabin.

**25.2** While some volcanoes in the U.S. are monitored, many in remote areas are not. These unmonitored volcanoes may erupt without prior warning to the aviation community. A pilot observing a volcanic eruption who has not had previous notification of it may be the only witness to the eruption. Pilots are strongly encouraged to transmit a PIREP regarding volcanic eruptions and any observed volcanic ash clouds or detection of sulphur dioxide (SO<sub>2</sub>) gas associated with volcanic activity.

**25.3** Pilots should submit PIREPs regarding volcanic activity using the Volcanic Activity Reporting form (VAR) as illustrated in FIG GEN 3.5–31. (If a VAR form is not immediately available, relay enough information to identify the position and type of volcanic activity.)

**25.4** Pilots should verbally transmit the data required in items 1 through 8 of the VAR as soon as possible. The data required in items 9 through 16 of the VAR should be relayed after landing, if possible.

## 26. Thunderstorms

**26.1** Turbulence, hail, rain, snow, lightning, sustained updrafts and downdrafts, and icing conditions are all present in thunderstorms. While there is some evidence that maximum turbulence exists at the middle level of a thunderstorm, recent studies show little variation of turbulence intensity with altitude.

**26.2** There is no useful correlation between the external visual appearance of thunderstorms and the severity or amount of turbulence or hail within them. Also, the visible thunderstorm cloud is only a portion of a turbulent system whose updrafts and downdrafts often extend far beyond the visible storm cloud. Severe turbulence can be expected up to 20 miles from severe thunderstorms. This distance decreases to about 10 miles in less severe storms. These turbulent areas may appear as a well-defined echo on weather radar.

**26.3** Weather radar, airborne or ground-based, will normally reflect the areas of moderate to heavy precipitation. (Radar does not detect turbulence.) The frequency and severity of turbulence generally increases with the areas of highest liquid water content of the storm. **NO FLIGHT PATH THROUGH AN AREA OF STRONG OR VERY STRONG RADAR ECHOES SEPARATED BY 20–30 MILES OR LESS MAY BE CONSIDERED FREE OF SEVERE TURBULENCE.**

**26.4** Turbulence beneath a thunderstorm should not be minimized. This is especially true when the relative humidity is low in any layer between the surface and 15,000 feet. Then the lower altitudes may be characterized by strong out-flowing winds and severe turbulence.

**26.5** The probability of lightning strikes occurring to aircraft is greatest when operating at altitudes where temperatures are between –5 C and +5 C. Lightning can strike aircraft flying in the clear in the vicinity of a thunderstorm.

**26.6** Current weather radar systems are able to objectively determine precipitation intensity. These precipitation intensity areas are described as “light,” “moderate,” “heavy,” and “extreme.”

### REFERENCE–

*Pilot/Controller Glossary Term– Precipitation Radar Weather Descriptions.*

### EXAMPLE–

*Alert provided by an ATC facility to an aircraft:*

*(aircraft identification) EXTREME precipitation between ten o'clock and two o'clock, one five miles. Precipitation area is two five miles in diameter.*

### EXAMPLE–

*Alert provided by an FSS:*

*(aircraft identification) EXTREME precipitation two zero miles west of Atlanta V–O–R, two five miles wide, moving east at two zero knots, tops flight level three niner zero.*

## 27. Thunderstorm Flying

**27.1** Thunderstorm Avoidance. Never regard any thunderstorm lightly, even when radar echoes are of light intensity. Avoiding thunderstorms is the best policy. Following are some Do's and Don'ts of thunderstorm avoidance:

**27.1.1** Don't land or takeoff in the face of an approaching thunderstorm. A sudden gust front of low-level turbulence could cause loss of control.

**27.1.2** Don't attempt to fly under a thunderstorm even if you can see through to the other side. Turbulence and wind shear under the storm could be disastrous.

- 27.1.3** Don't attempt to fly under the anvil of a thunderstorm. There is a potential for severe and extreme clear air turbulence.
- 27.1.4** Don't fly without airborne radar into a cloud mass containing scattered embedded thunderstorms. Scattered thunderstorms not embedded usually can be visually circumnavigated.
- 27.1.5** Don't trust the visual appearance to be a reliable indicator of the turbulence inside a thunderstorm.
- 27.1.6** Don't assume that ATC will offer radar navigation guidance or deviations around thunderstorms.
- 27.1.7** Don't use data-linked weather next generation weather radar (NEXRAD) mosaic imagery as the sole means for negotiating a path through a thunderstorm area (tactical maneuvering).
- 27.1.8** Do remember that the data-linked NEXRAD mosaic imagery shows where the weather was, not where the weather is. The weather conditions may be 15 to 20 minutes older than the age indicated on the display.
- 27.1.9** Do listen to chatter on the ATC frequency for Pilot Weather Reports (PIREP) and other aircraft requesting to deviate or divert.
- 27.1.10** Do ask ATC for radar navigation guidance or to approve deviations around thunderstorms, if needed.
- 27.1.11** Do use data-linked weather NEXRAD mosaic imagery (for example, Flight Information Service-Broadcast (FIS-B)) for route selection to avoid thunderstorms entirely (strategic maneuvering).
- 27.1.12** Do advise ATC, when switched to another controller, that you are deviating for thunderstorms before accepting to rejoin the original route.
- 27.1.13** Do ensure that after an authorized weather deviation, before accepting to rejoin the original route, that the route of flight is clear of thunderstorms.
- 27.1.14** Do avoid by at least 20 miles any thunderstorm identified as severe or giving an intense radar echo. This is especially true under the anvil of a large cumulonimbus.
- 27.1.15** Do circumnavigate the entire area if the area has 6/10 thunderstorm coverage.
- 27.1.16** Do remember that vivid and frequent lightning indicates the probability of a severe thunderstorm.
- 27.1.17** Do regard as extremely hazardous any thunderstorm with tops 35,000 feet or higher whether the top is visually sighted or determined by radar.
- 27.1.18** Do give a PIREP for the flight conditions.
- 27.1.19** Do divert and wait out the thunderstorms on the ground if unable to navigate around an area of thunderstorms.
- 27.1.20** Do contact Flight Service for assistance in avoiding thunderstorms. Flight Service specialists have NEXRAD mosaic radar imagery and NEXRAD single site radar with unique features such as base and composite reflectivity, echo tops, and VAD wind profiles.
- 27.2** If you cannot avoid penetrating a thunderstorm, following are some Do's before entering the storm:
- 27.2.1** Tighten your safety belt, put on your shoulder harness (if installed), if and secure all loose objects.
- 27.2.2** Plan and hold the course to take the aircraft through the storm in a minimum time.
- 27.2.3** To avoid the most critical icing, establish a penetration altitude below the freezing level or above the level of -15 C.
- 27.2.4** Verify that pitot heat is on and turn on carburetor heat or jet engine anti-ice. Icing can be rapid at any altitude and cause almost instantaneous power failure and/or loss of airspeed indication.
- 27.2.5** Establish power settings for turbulence penetration airspeed recommended in your aircraft manual.
- 27.2.6** Turn up cockpit lights to highest intensity to lessen danger of temporary blindness from lightning.

**27.2.7** If using automatic pilot, disengage Altitude Hold Mode and Speed Hold Mode. The automatic altitude and speed controls will increase maneuvers of the aircraft thus increasing structural stress.

**27.2.8** If using airborne radar, tilt the antenna up and down occasionally. This will permit the detection of other thunderstorm activity at altitudes other than the one being flown.

**27.3** Following are some Do's and Don'ts during the thunderstorm penetration:

**27.3.1** Do keep your eyes on your instruments. Looking outside the cockpit can increase danger of temporary blindness from lightning.

**27.3.2** Don't change power settings; maintain settings for the recommended turbulence penetration airspeed.

**27.3.3** Do maintain constant attitude. Allow the altitude and airspeed to fluctuate.

**27.3.4** Don't turn back once you are in the thunderstorm. A straight course through the storm most likely will get the aircraft out of the hazards most quickly. In addition, turning maneuvers increase stress on the aircraft.

## **28. Wake Turbulence**

### **28.1 General**

**28.1.1** Every aircraft generates wake turbulence while in flight. Wake turbulence is a function of an aircraft producing lift, resulting in the formation of two counter-rotating vortices trailing behind the aircraft.

**28.1.2** Wake turbulence from the generating aircraft can affect encountering aircraft due to the strength, duration, and direction of the vortices. Wake turbulence can impose rolling moments exceeding the roll-control authority of encountering aircraft, causing possible injury to occupants and damage to aircraft. Pilots should always be aware of the possibility of a wake turbulence encounter when flying through the wake of another aircraft, and adjust the flight path accordingly.

### **28.2 Vortex Generation**

**28.2.1** The creation of a pressure differential over the wing surface generates lift. The lowest pressure occurs over the upper wing surface and the highest pressure under the wing. This pressure differential triggers the roll up of the airflow at the rear of the wing resulting in swirling air masses trailing downstream of the wing tips. After the roll up is completed, the wake consists of two counter-rotating cylindrical vortices. (See FIG GEN 3.5–17.) The wake vortex is formed with most of the energy concentrated within a few feet of the vortex core.

**28.2.2** More aircraft are being manufactured or retrofitted with winglets. There are several types of winglets, but their primary function is to increase fuel efficiency by improving the lift-to-drag ratio. Studies have shown that winglets have a negligible effect on wake turbulence generation, particularly with the slower speeds involved during departures and arrivals.

### **28.3 Vortex Strength**

**28.3.1** Weight, speed, wingspan, and shape of the generating aircraft's wing all govern the strength of the vortex. The vortex characteristics of any given aircraft can also be changed by extension of flaps or other wing configuring devices. However, the vortex strength from an aircraft increases proportionately to an increase in operating weight or a decrease in aircraft speed. Since the turbulence from a "dirty" aircraft configuration hastens wake decay, the greatest vortex strength occurs when the generating aircraft is HEAVY, CLEAN, and SLOW.

#### **28.3.2 Induced Roll**

**28.3.2.1** In rare instances, a wake encounter could cause catastrophic inflight structural damage to an aircraft. However, the usual hazard is associated with induced rolling moments that can exceed the roll-control authority of the encountering aircraft. During inflight testing, aircraft intentionally flew directly up trailing vortex cores of larger aircraft. These tests demonstrated that the ability of aircraft to counteract the roll imposed by wake vortex depends primarily on the wingspan and counter-control responsiveness of the encountering aircraft. These tests also demonstrated the difficulty of an aircraft to remain within a wake vortex. The natural tendency is for the circulation to eject aircraft from the vortex.

**28.3.2.2** Counter-control is usually effective and induced roll minimal in cases where the wing span and ailerons of the encountering aircraft extend beyond the rotational flow field of the vortex. It is more difficult for aircraft with short wing span (relative to the generating aircraft) to counter the imposed roll induced by vortex flow. Pilots of short-span aircraft, even of the high-performance type, must be especially alert to vortex encounters. (See FIG GEN 3.5–18.)

## 28.4 Vortex Behavior

**28.4.1** Trailing vortices have certain behavioral characteristics which can help a pilot visualize the wake location and thereby take avoidance precautions.

**28.4.1.1** An aircraft generates vortices from the moment it rotates on takeoff to touchdown, since trailing vortices are a by-product of wing lift. Prior to takeoff or touchdown pilots should note the rotation or touchdown point of the preceding aircraft. (See FIG GEN 3.5–19.)

**28.4.1.2** The vortex circulation is outward, upward and around the wing tips when viewed from either ahead or behind the aircraft. Tests with larger aircraft have shown that the vortices remain spaced a bit less than a wingspan apart, drifting with the wind, at altitudes greater than a wingspan from the ground. In view of this, if persistent vortex turbulence is encountered, a slight change of altitude (upward) and lateral position (upwind) should provide a flight path clear of the turbulence.

**28.4.1.3** Flight tests have shown that the vortices from larger aircraft sink at a rate of several hundred feet per minute, slowing their descent and diminishing in strength with time and distance behind the generating aircraft. Pilots should fly at or above the preceding aircraft's flight path, altering course as necessary to avoid the area directly behind and below the generating aircraft. (See FIG GEN 3.5–20.) Pilots, in all phases of flight, must remain vigilant of possible wake effects created by other aircraft. Studies have shown that atmospheric turbulence hastens wake breakup, while other atmospheric conditions can transport wake horizontally and vertically.

FIG GEN 3.5–17  
Wake Vortex Generation

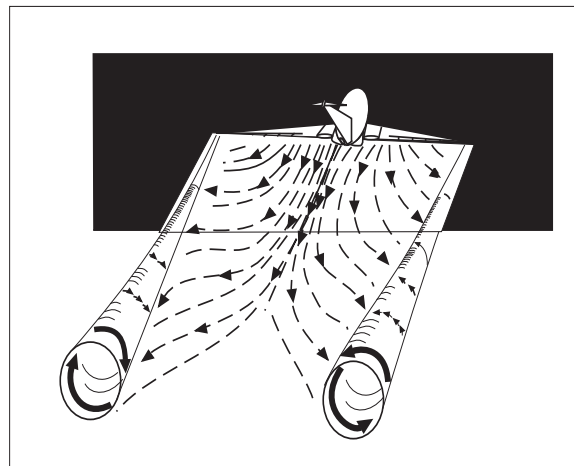


FIG GEN 3.5-18  
**Wake Encounter Counter Control**

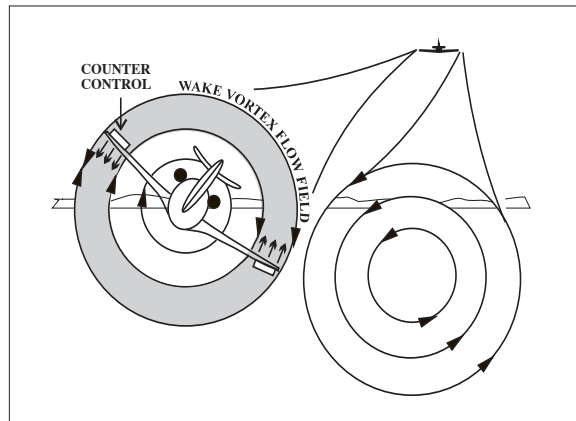


FIG GEN 3.5-19  
**Wake Ends/Wake Begins**

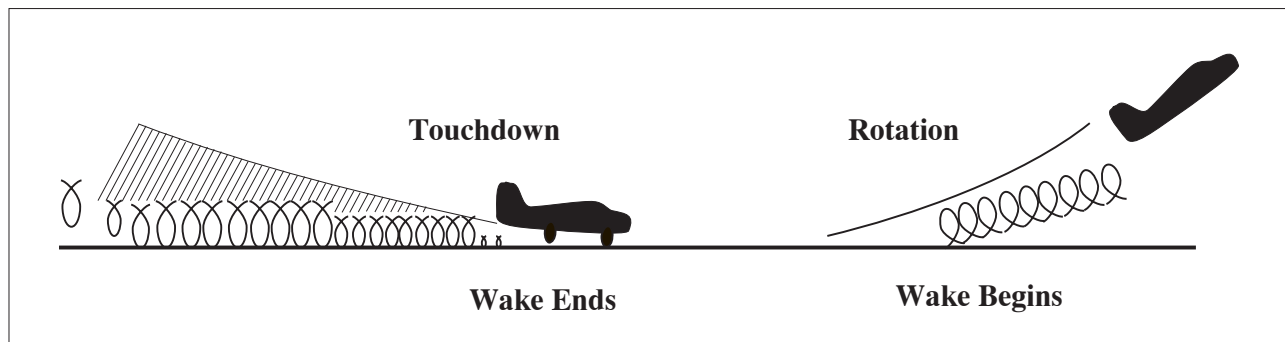


FIG GEN 3.5-20  
**Vortex Flow Field**

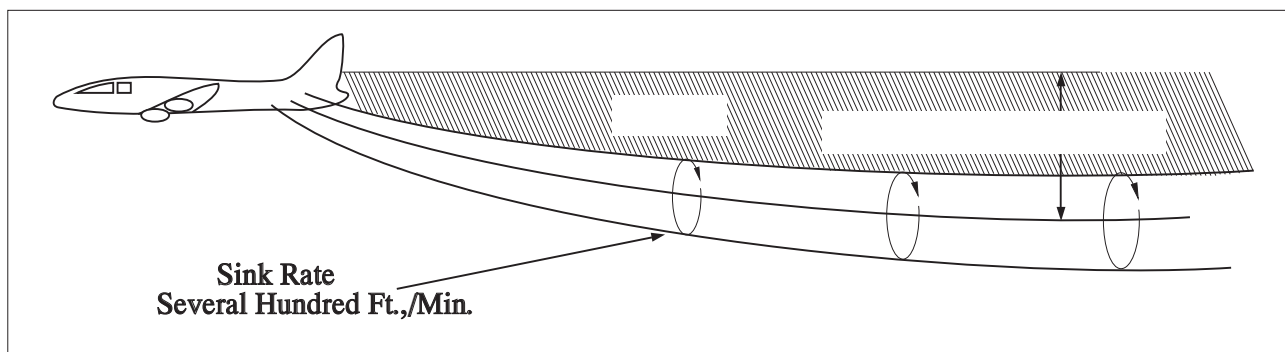
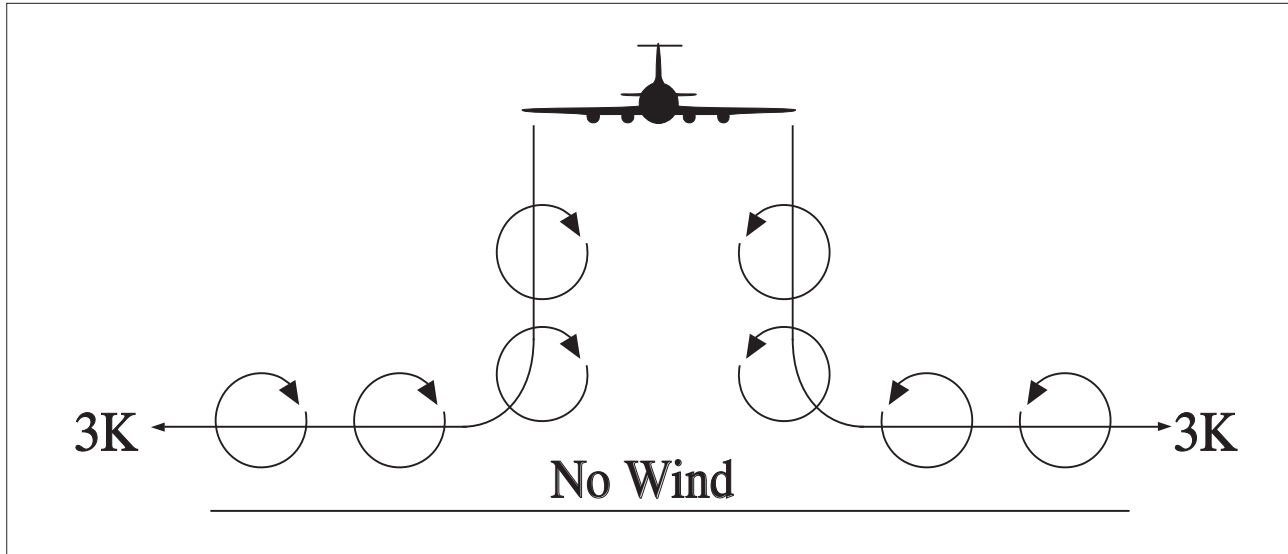


FIG GEN 3.5-21  
Vortex Movement Near Ground – No Wind



28.4.1.4 When the vortices of larger aircraft sink close to the ground (within 100 to 200 feet), they tend to move laterally over the ground at a speed of 2 or 3 knots. (See FIG GEN 3.5-21.)

28.4.1.5 Pilots should be alert at all times for possible wake vortex encounters when conducting approach and landing operations. The pilot is ultimately responsible for maintaining an appropriate interval, and should consider all available information in positioning the aircraft in the terminal area, to avoid the wake turbulence created by a preceding aircraft. Test data show that vortices can rise with the air mass in which they are embedded. The effects of wind shear can cause vortex flow field “tilting.” In addition, ambient thermal lifting and orographic effects (rising terrain or tree lines) can cause a vortex flow field to rise and possibly bounce.

FIG GEN 3.5-22  
Vortex Movement Near Ground – with Cross Winds

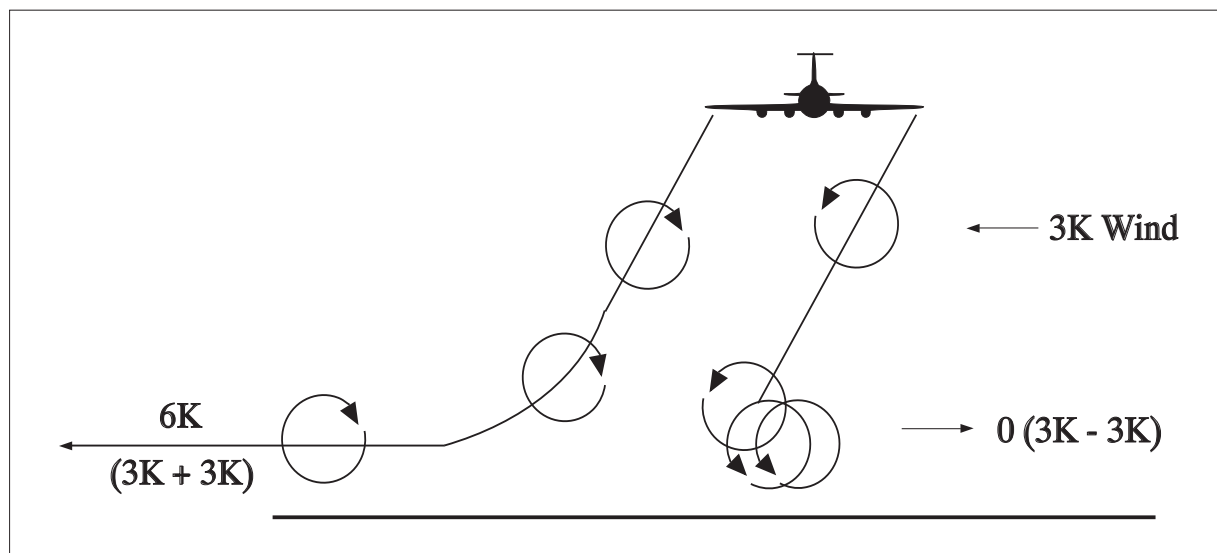
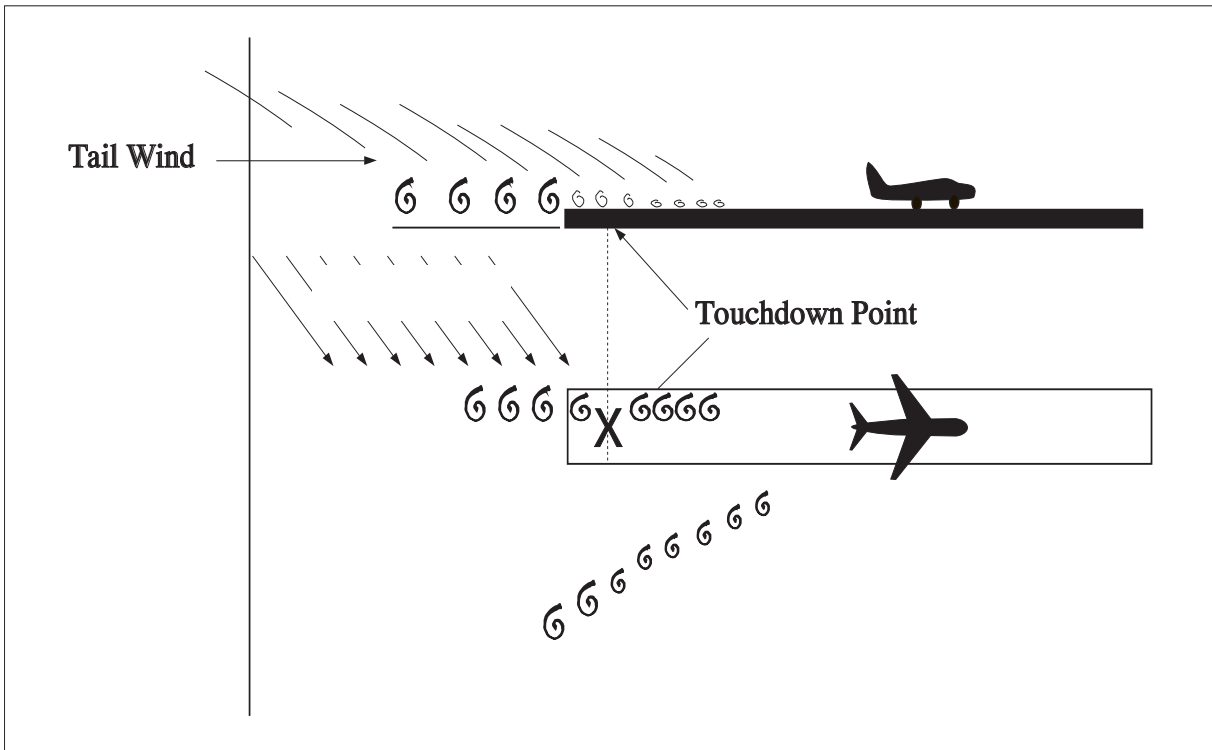




FIG GEN 3.5-23  
Vortex Movement in Ground Effect – Tailwind



**28.4.2** A crosswind will decrease the lateral movement of the upwind vortex and increase the movement of the downwind vortex. Thus, a light wind with a cross-runway component of 1 to 5 knots could result in the upwind vortex remaining in the touchdown zone for a period of time and hasten the drift of the downwind vortex toward another runway. (See FIG GEN 3.5-22.) Similarly, a tailwind condition can move the vortices of the preceding aircraft forward into the touchdown zone. **THE LIGHT QUARTERING TAILWIND REQUIRES MAXIMUM CAUTION.** Pilots should be alert to large aircraft upwind from their approach and takeoff flight paths. (See FIG GEN 3.5-23.)

### 28.5 Operations Problem Areas

**28.5.1** A wake turbulence encounter can range from negligible to catastrophic. The impact of the encounter depends on the weight, wingspan, size of the generating aircraft, distance from the generating aircraft, and point of vortex encounter. The probability of induced roll increases when the encountering aircraft's heading is generally aligned with the flight path of the generating aircraft.

**28.5.2** **AVOID THE AREA BELOW AND BEHIND THE WAKE GENERATING AIRCRAFT, ESPECIALLY AT LOW ALTITUDE WHERE EVEN A MOMENTARY WAKE ENCOUNTER COULD BE CATASTROPHIC.**

**NOTE-**

*A common scenario for a wake encounter is in terminal airspace after accepting clearance for a visual approach behind landing traffic. Pilots must be cognizant of their position relative to the traffic and use all means of vertical guidance to ensure they do not fly below the flight path of the wake generating aircraft.*

**28.5.3** Pilots should be particularly alert in calm wind conditions and situations where the vortices could:

**28.5.3.1** Remain in the touchdown area.

**28.5.3.2** Drift from aircraft operating on a nearby runway.

**28.5.3.3** Sink into the takeoff or landing path from a crossing runway.

**28.5.3.4** Sink into the traffic pattern from other airport operations.

**28.5.3.5** Sink into the flight path of VFR aircraft operating on the hemispheric altitude 500 feet below.

**28.5.4** Pilots should attempt to visualize the vortex trail of aircraft whose projected flight path they may encounter. When possible, pilots of larger aircraft should adjust their flight paths to minimize vortex exposure to other aircraft.

## **28.6 Vortex Avoidance Procedures**

**28.6.1** Under certain conditions, airport traffic controllers apply procedures for separating IFR aircraft. If a pilot accepts a clearance to visually follow a preceding aircraft, the pilot accepts responsibility for separation and wake turbulence avoidance. The controllers will also provide to VFR aircraft, with whom they are in communication and which in the tower's opinion may be adversely affected by wake turbulence from a larger aircraft, the position, altitude and direction of flight of larger aircraft followed by the phrase "CAUTION – WAKE TURBULENCE." After issuing the caution for wake turbulence, the airport traffic controllers generally do not provide additional information to the following aircraft unless the airport traffic controllers know the following aircraft is overtaking the preceding aircraft. **WHETHER OR NOT A WARNING OR INFORMATION HAS BEEN GIVEN, HOWEVER, THE PILOT IS EXPECTED TO ADJUST AIRCRAFT OPERATIONS AND FLIGHT PATH AS NECESSARY TO PRECLUDE SERIOUS WAKE ENCOUNTERS.** When any doubt exists about maintaining safe separation distances between aircraft during approaches, pilots should ask the control tower for updates on separation distance and aircraft groundspeed.

**28.6.2** The following vortex avoidance procedures are recommended for the various situations:

**28.6.2.1 Landing Behind a Larger Aircraft – Same Runway.** Stay at or above the larger aircraft's final approach flight path – note its touchdown point – land beyond it.

**28.6.2.2 Landing Behind a Larger Aircraft – When a Parallel Runway is Closer Than 2,500 Feet.** Consider possible drift to your runway. Stay at or above the larger aircraft's final approach flight path – note its touchdown point.

**28.6.2.3 Landing Behind a Larger Aircraft – Crossing Runway.** Cross above the larger aircraft's flight path.

**28.6.2.4 Landing Behind a Departing Larger Aircraft – Same Runway.** Note the larger aircraft's rotation point – land well prior to rotation point.

**28.6.2.5 Landing Behind a Departing Larger Aircraft – Crossing Runway.** Note the larger aircraft's rotation point – if past the intersection – continue the approach – land prior to the intersection. If larger aircraft rotates prior to the intersection, avoid flight below the larger aircraft's flight path. Abandon the approach unless a landing is ensured well before reaching the intersection.

**28.6.2.6 Departing Behind a Larger Aircraft.** Note the larger aircraft's rotation point – rotate prior to larger aircraft's rotation point – continue climb above the larger aircraft's climb path until turning clear of the larger aircraft's wake. Avoid subsequent headings which will cross below and behind a larger aircraft. Be alert for any critical takeoff situation which could lead to a vortex encounter.

**28.6.2.7 Intersection Takeoffs – Same Runway.** Be alert to adjacent larger aircraft operations, particularly upwind of your runway. If intersection takeoff clearance is received, avoid subsequent headings which will cross below a larger aircraft's path.

**28.6.2.8 Departing or Landing After a Larger Aircraft Executing a Low Approach, Missed Approach, Or Touch-and-go Landing.** Because vortices settle and move laterally near the ground, the vortex hazard may exist along the runway and in your flight path after a larger aircraft has executed a low approach, missed approach, or a touch-and-go landing, particular in light quartering wind conditions. You should ensure that an interval of at least 2 minutes has elapsed before your takeoff or landing.

**28.6.2.9 En Route VFR (Thousand-foot Altitude Plus 500 Feet).** Avoid flight below and behind a large aircraft's path. If a larger aircraft is observed above on the same track (meeting or overtaking) adjust your position laterally, preferably upwind.

## 28.7 Helicopters

**28.7.1** In a slow hover–taxi or stationary hover near the surface, helicopter main rotor(s) generate downwash producing high velocity outwash vortices to a distance approximately three times the diameter of the rotor. When rotor downwash hits the surface, the resulting outwash vortices have behavioral characteristics similar to wing tip vortices produced by fixed–wing aircraft. However, the vortex circulation is outward, upward, around, and away from the main rotor(s) in all directions. Pilots of small aircraft should avoid operating within three rotor diameters of any helicopter in a slow hover–taxi or stationary hover. In forward flight, departing or landing helicopters produce a pair of strong, high–speed trailing vortices similar to wing tip vortices of larger fixed–wing aircraft. Pilots of small aircraft should use caution when operating behind or crossing behind landing and departing helicopters.

## 28.8 Pilot Responsibility

**28.8.1** Research and testing have been conducted, in addition to ongoing wake initiatives, in an attempt to mitigate the effects of wake turbulence. Pilots must exercise vigilance in situations where they are responsible for avoiding wake turbulence.

**28.8.2** Pilots are reminded that in operations conducted behind all aircraft, acceptance of instructions from ATC in the following situations is an acknowledgment that the pilot will ensure safe takeoff and landing intervals and accepts the responsibility of providing his/her own wake turbulence separation:

**28.8.2.1** Traffic information.

**28.8.2.2** Instructions to follow an aircraft.

**28.8.2.3** The acceptance of a visual approach clearance.

**28.8.3** For operations conducted behind **super** or **heavy** aircraft, ATC will specify the word “**super**” or “**heavy**” as appropriate, when this information is known. Pilots of **super** or **heavy** aircraft should always use the word “**super**” or “**heavy**” in radio communications.

**28.8.4** Super, heavy and large jet aircraft operators should use the following procedures during an approach to landing. These procedures establish a dependable baseline from which pilots of in–trail, lighter aircraft may reasonably expect to make effective flight path adjustments to avoid serious wake vortex turbulence.

**28.8.4.1** Pilots of aircraft that produce strong wake vortices should make every attempt to fly on the established glidepath, not above it; or, if glidepath guidance is not available, to fly as closely as possible to a “3–1” glidepath, not above it.

### **EXAMPLE–**

*Fly 3,000 feet at 10 miles from touchdown, 1,500 feet at 5 miles, 1,200 feet at 4 miles, and so on to touchdown.*

**28.8.4.2** Pilots of aircraft that produce strong wake vortices should fly as closely as possible to the approach course centerline or to the extended centerline of the runway of intended landing as appropriate to conditions.

**28.8.5** Pilots operating lighter aircraft on visual approaches in–trail to aircraft producing strong wake vortices should use the following procedures to assist in avoiding wake turbulence. These procedures apply only to those aircraft that are on visual approaches.

**28.8.5.1** Pilots of lighter aircraft should fly on or above the glidepath. Glidepath reference may be furnished by an ILS, by a visual approach slope system, by other ground–based approach slope guidance systems, or by other means. In the absence of visible glidepath guidance, pilots may very nearly duplicate a 3–degree glideslope by adhering to the “3 to 1” glidepath principle.

### **EXAMPLE–**

*Fly 3,000 feet at 10 miles from touchdown, 1,500 feet at 5 miles, 1,200 feet at 4 miles, and so on to touchdown.*

**28.8.5.2** If the pilot of the lighter following aircraft has visual contact with the preceding heavier aircraft and also with the runway, the pilot may further adjust for possible wake vortex turbulence by the following practices:

- a) Pick a point of landing no less than 1,000 feet from the arrival end of the runway.

b) Establish a line-of-sight to that landing point that is above and in front of the heavier preceding aircraft.

c) When possible, note the point of landing of the heavier preceding aircraft and adjust point of intended landing as necessary.

**EXAMPLE–**

*A puff of smoke may appear at the 1,000-foot markings of the runway, showing that touchdown was at that point; therefore, adjust point of intended landing to the 1,500-foot markings.*

d) Maintain the line-of-sight to the point of intended landing above and ahead of the heavier preceding aircraft; maintain it to touchdown.

e) Land beyond the point of landing of the preceding heavier aircraft. Ensure you have adequate runway remaining, if conducting a touch-and-go landing, or adequate stopping distance available for a full stop landing.

**28.8.6** During visual approaches pilots may ask ATC for updates on separation and groundspeed with respect to heavier preceding aircraft, especially when there is any question of safe separation from wake turbulence.

**28.8.7** Pilots should notify ATC when a wake event is encountered. Be as descriptive as possible (i.e., bank angle, altitude deviations, intensity and duration of event, etc.) when reporting the event. ATC will record the event through their reporting system. You are also encouraged to use the Aviation Safety Reporting System (ASRS) to report wake events.

## **28.9 Air Traffic Wake Turbulence Separations**

**28.9.1** Because of the possible effects of wake turbulence, controllers are required to apply no less than minimum required separation to all aircraft operating behind a Super or Heavy, and to Small aircraft operating behind a B757, when aircraft are IFR; VFR and receiving Class B, Class C, or TRSA airspace services; or VFR and being radar sequenced.

**28.9.1.1** Separation is applied to aircraft operating directly behind a super or heavy at the same altitude or less than 1,000 feet below, and to small aircraft operating directly behind a B757 at the same altitude or less than 500 feet below:

- a) **Heavy** behind **super** – 6 miles.
- b) **Large** behind **super** – 7 miles.
- c) **Small** behind **super** – 8 miles.
- d) **Heavy** behind **heavy** – 4 miles.
- e) **Small/large** behind **heavy** – 5 miles.
- f) **Small** behind **B757** – 4 miles.

**28.9.1.2** Also, separation, measured at the time the preceding aircraft is over the landing threshold, is provided to small aircraft:

- a) **Small** landing behind **heavy** – 6 miles.
- b) **Small** landing behind **large, non-B757** – 4 miles.

**28.9.2** Additionally, appropriate time or distance intervals are provided to departing aircraft when the departure will be from the same threshold, a parallel runway separated by less than 2,500 feet with less than 500 feet threshold stagger, or on a crossing runway and projected flight paths will cross:

**28.9.2.1** Three minutes or the appropriate radar separation when takeoff will be behind a super aircraft;

**28.9.2.2** Two minutes or the appropriate radar separation when takeoff will be behind a heavy aircraft.

**28.9.2.3** Two minutes or the appropriate radar separation when a small aircraft will takeoff behind a B757.

**NOTE–**

*Controllers may not reduce or waive these intervals.*

**28.9.3** A 3–minute interval will be provided for a **small** aircraft taking off:

**28.9.3.1** From an intersection on the same runway (same or opposite direction) behind a departing **large** aircraft (except B757), or

**28.9.3.2** In the opposite direction on the same runway behind a large aircraft (except B757) takeoff or low/missed approach.

**NOTE–**

*This 3–minute interval may be waived upon specific pilot request.*

**28.9.4** A 3–minute interval will be provided when a small aircraft will takeoff:

**28.9.4.1** From an intersection on the same runway (same or opposite direction) behind a departing B757, or

**28.9.4.2** In the opposite direction on the same runway behind a B757 takeoff or low/missed approach.

**NOTE–**

*This 3–minute interval may not be waived.*

**28.9.5** A 4–minute interval will be provided for all aircraft taking off behind a super aircraft, and a 3–minute interval will be provided for all aircraft taking off behind a heavy aircraft when the operations are as described in subparagraphs 28.9.4.1 and 28.9.4.2 above, and are conducted on either the same runway or parallel runways separated by less than 2,500 feet. Controllers may not reduce or waive this interval.

**28.9.6** Pilots may request additional separation (i.e., 2 minutes instead of 4 or 5 miles) for wake turbulence avoidance. This request should be made as soon as practical on ground control and at least before taxiing onto the runway.

**NOTE–**

*Federal Aviation Administration Regulations state: “The pilot in command of an aircraft is directly responsible for and is the final authority as to the operation of that aircraft.”*

**28.9.7** Controllers may anticipate separation and need not withhold a takeoff clearance for an aircraft departing behind a **large, heavy, or super** aircraft if there is reasonable assurance the required separation will exist when the departing aircraft starts takeoff roll.

**NOTE–**

*With the advent of new wake turbulence separation methodologies known as Wake Turbulence Recategorization, some of the requirements listed above may vary at facilities authorized to operate in accordance with Wake Turbulence Recategorization directives.*

**REFERENCE–**

*FAA Order JO 7110.659 Wake Turbulence Recategorization  
FAA Order JO 7110.123 Wake Turbulence Recategorization – Phase II  
FAA Order JO 7110.126, Consolidated Wake Turbulence*

## **28.10 Development and New Capabilities**

**28.10.1** The suite of available wake turbulence tools, rules, and procedures is expanding, with the development of new methodologies. Based on extensive analysis of wake vortex behavior, new procedures and separation standards are being developed and implemented in the US and throughout the world. Wake research involves the wake generating aircraft as well as the wake toleration of the trailing aircraft.

**28.10.2** The FAA and ICAO are leading initiatives, in terminal environments, to implement next–generation wake turbulence procedures and separation standards. The FAA has undertaken an effort to recategorize the existing fleet of aircraft and modify associated wake turbulence separation minima. This initiative is termed Wake Turbulence Recategorization (RECAT), and changes the current weight–based classes (Super, Heavy, B757, Large, Small+, and Small) to a wake–based categorical system that utilizes the aircraft matrices of weight, wingspan, and approach speed. RECAT is currently in use at a limited number of airports in the National Airspace System.

## 29. International Civil Aviation Organization (ICAO) Weather Formats

**29.1** The U.S. uses the ICAO world standard for aviation weather reporting and forecasting. The World Meteorological Organization’s (WMO) publication No. 782 “Aerodrome Reports and Forecasts” contains the base METAR and TAF code as adopted by the WMO member countries.

**29.2** Although the METAR code is adopted worldwide, each country is allowed to make modifications or exceptions to the code for use in their particular country, e.g., the U.S. will continue to use statute miles for visibility, feet for RVR values, knots for wind speed, and inches of mercury for altimetry. However, temperature and dew point will be reported in degrees Celsius. The U.S reports prevailing visibility rather than lowest sector visibility. The elements in the body of a METAR report are separated with a space. The only exceptions are RVR, temperature, and dew point which are separated with a solidus (/). When an element does not occur, or cannot be observed, the preceding space and that element are omitted from that particular report. A METAR report contains the following sequence of elements in the following order:

**29.2.1** Type of report.

**29.2.2** ICAO station identifier.

**29.2.3** Date and time of report.

**29.2.4** Modifier (as required).

**29.2.5** Wind.

**29.2.6** Visibility.

**29.2.7** Runway Visual Range (RVR).

**29.2.8** Weather phenomena.

**29.2.9** Sky conditions.

**29.2.10** Temperature/Dew point group.

**29.2.11** Altimeter.

**29.2.12** Remarks (RMK).

**29.3** The following paragraphs describe the elements in a METAR report.

**29.3.1 Type of Report.** There are two types of reports:

**29.3.1.1** The METAR, an aviation routine weather report.

**29.3.1.2** The SPECI, a nonroutine (special) aviation weather report.

The type of report (METAR or SPECI) will always appear as the lead element of the report.

**29.3.2 ICAO Station Identifier.** The METAR code uses ICAO 4–letter station identifiers. In the contiguous 48 states, the 3–letter domestic station identifier is prefixed with a “K”; i.e., the domestic identifier for Seattle is SEA while the ICAO identifier is KSEA. For Alaska, all station identifiers start with “PA”; for Hawaii, all station identifiers start with “PH.” The identifier for the eastern Caribbean is “T” followed by the individual country’s letter; i.e., Puerto Rico is “TJ.” For a complete worldwide listing see ICAO Document 7910, “Location Indicators.”

**29.3.3 Date and Time of Report.** The date and time the observation is taken are transmitted as a six–digit date/time group appended with Z to denote Coordinated Universal Time (UTC). The first two digits are the date followed with two digits for hour and two digits for minutes.

**EXAMPLE–**

172345Z (the 17th day of the month at 2345Z)

**29.3.4 Modifier (As Required).** “AUTO” identifies a METAR/SPECI report as an automated weather report with no human intervention. If “AUTO” is shown in the body of the report, the type of sensor equipment used

at the station will be encoded in the remarks section of the report. The absence of “AUTO” indicates that a report was made manually by an observer or that an automated report had human augmentation/backup. The modifier “COR” indicates a corrected report that is sent out to replace an earlier report with an error.

**NOTE–**

*There are two types of automated stations, AO1 for automated weather reporting stations without a precipitation discriminator, and AO2 for automated stations with a precipitation discriminator. (A precipitation discriminator can determine the difference between liquid and frozen/freezing precipitation). This information appears in the remarks section of an automated report.*

**29.3.5 Wind.** The wind is reported as a five digit group (six digits if speed is over 99 knots). The first three digits are the direction from which the wind is blowing, in tens of degrees referenced to true north, or “VRB” if the direction is variable. The next two digits is the wind speed in knots, or if over 99 knots, the next three digits. If the wind is gusty, it is reported as a “G” after the speed followed by the highest gust reported. The abbreviation “KT” is appended to denote the use of knots for wind speed.

**EXAMPLE–**

13008KT – wind from 130 degrees at 8 knots

08032G45KT – wind from 080 degrees at 32 knots with gusts to 45 knots

VRB04KT – wind variable in direction at 4 knots

00000KT – wind calm

210103G130KT – wind from 210 degrees at 103 knots with gusts to 130 knots

*If the wind direction is variable by 60 degrees or more and the speed is greater than 6 knots, a variable group consisting of the extremes of the wind direction separated by a “V” will follow the prevailing wind group.*

32012G22KT 280V350

**29.3.5.1 Peak Wind.** Whenever the peak wind exceeds 25 knots, “PK WND” will be included in Remarks; e.g., PK WND 280045/1955 “Peak wind two eight zero at four five occurred at one niner five five.” If the hour can be inferred from the report time, only the minutes will be appended; e.g., PK WND 34050/38 “Peak wind three four zero at five zero occurred at three eight past the hour.”

**29.3.5.2 Wind Shift.** Whenever a wind shift occurs, “WSHFT” will be included in remarks followed by the time the wind shift began; e.g., WSHFT 30 FROPA “Wind shift at three zero due to frontal passage.”

**29.3.6 Visibility.** Prevailing visibility is reported in statute miles with “SM” appended to it.

**EXAMPLE–**

7SM . . . . . seven statute miles

15SM . . . . . fifteen statute miles

<sup>1</sup>/<sub>2</sub>SM . . . . . one-half statute mile

**29.3.6.1 Tower/Surface Visibility.** If either tower or surface visibility is below 4 statute miles, the lesser of the 2 will be reported in the body of the report; the greater will be reported in remarks.

**29.3.6.2 Automated Visibility.** ASOS/AWOS visibility stations will show visibility 10 or greater than 10 miles as “10SM.” AWOS visibility stations will show visibility less than <sup>1</sup>/<sub>4</sub> statute mile as “M<sup>1</sup>/<sub>4</sub>SM” and visibility 10 or greater than 10 miles as “10SM.”

**NOTE–**

*Automated sites that are augmented by human observer to meet service level requirements can report 0, 1/16 SM, and 1/8 SM visibility increments.*

**29.3.6.3 Variable Visibility.** Variable visibility is shown in remarks when rapid increase or decrease by <sup>1</sup>/<sub>2</sub> statute mile or more and the average prevailing visibility is less than 3 statute miles; e.g., VIS 1V2 means “visibility variable between 1 and 2 statute miles.”

**29.3.6.4 Sector Visibility.** Sector visibility is shown in remarks when it differs from the prevailing visibility, and either the prevailing or sector visibility is less than 3 statute miles.

**EXAMPLE–**

*VIS N2 . . . . . visibility north two*

**29.3.7 Runway Visual Range (when reported).** “R” identifies the group followed by the runway heading (and parallel runway designator, if needed) “/” and the visual range in feet (meters in other countries) followed with “FT.” (“Feet” is not spoken.)

**29.3.7.1 Variability Values.** When RVR varies by more than one reportable value, the lowest and highest values are shown with “V” between them.

**29.3.7.2 Maximum/Minimum Range.** “P” indicates an observed RVR is above the maximum value for this system (spoken as “more than”). “M” indicates an observed RVR is below the minimum value which can be determined by the system (spoken as “less than”).

**EXAMPLE–**

*R32L/1200FT – Runway Three Two Left R–V–R one thousand two hundred*

*R27R/M1000V4000FT – Runway Two Seven Right R–V–R variable from less than one thousand to four thousand.*

**29.3.8 Weather Phenomena.** In METAR, weather is reported in the format:

Intensity / Proximity / Descriptor / Precipitation / Obstruction to Visibility / Other

**NOTE–**

*The “/” above and in the following descriptions (except as the separator between the temperature and dew point) are for separation purposes in this publication and do not appear in the actual METARs.*

**29.3.8.1 Intensity** applies only to the first type of precipitation reported. A “–” denotes light, no symbol denotes moderate, and a “+” denotes heavy.

**29.3.8.2 Proximity** applies to and is reported only for weather occurring in the vicinity of the airport (between 5 and 10 miles of the point(s) of observation). It is denoted by the letters “VC.” (Intensity and “VC” will not appear together in the weather group.)

**29.3.8.3 Descriptor.** These eight descriptors apply to the precipitation or obstructions to visibility:

TS	thunderstorm
DR	low drifting
SH	showers
MI	shallow
FZ	freezing
BC	patches
BL	blowing
PR	partial

**NOTE–**

*Although “TS” and “SH” are used with precipitation and may be preceded with an intensity symbol, the intensity still applies to the precipitation not the descriptor.*



**29.3.8.4 Precipitation.** There are nine types of precipitation in the METAR code:

RA	rain
DZ	drizzle
SN	snow
GR	hail ( $\frac{1}{4}$ " or greater)
GS	small hail/snow pellets
PL	ice pellets
SG	snow grains
IC	ice crystals
UP	unknown precipitation (automated stations only)

**29.3.8.5 Obstructions to Visibility.** Obscurations are any phenomena in the atmosphere, other than precipitation, that reduce horizontal visibility. There are eight types of obscuration phenomena in the METAR code:

FG	fog (visibility less than $\frac{5}{8}$ mile)
HZ	haze
FU	smoke
PY	spray
BR	mist (visibility $\frac{5}{8}$ –6 miles)
SA	sand
DU	dust
VA	volcanic ash

**NOTE–**

*Fog (FG) is observed or forecast only when the visibility is less than  $\frac{5}{8}$  mile. Otherwise, mist (BR) is observed or forecast.*

**29.3.8.6 Other.** There are five categories of other weather phenomena which are reported when they occur:

SQ	squall
SS	sandstorm
DS	duststorm
PO	dust/sand whirls
FC +FC	funnel cloud tornado/waterspout

**EXAMPLES–**

TSRA	thunderstorm with moderate rain
+SN	heavy snow
–RA FG	light rain and fog
BRHZ	mist and haze (visibility $\frac{5}{8}$ mile or greater)
FZDZ	freezing drizzle
VCSH	rain shower in the vicinity
+SHRASNPL	heavy rain showers, snow, ice pellets (Intensity indicator refers to the predominant rain.)

**29.3.9 Sky Condition.** In METAR, sky condition is reported in the format:

Amount / Height / (Type) or Indefinite Ceiling / Height

**29.3.9.1 Amount.** The amount of sky cover is reported in eighths of sky cover, using contractions:

SKC	clear (no clouds)
FEW	> <sup>0</sup> / <sub>8</sub> to <sup>2</sup> / <sub>8</sub> cloud cover
SCT	scattered ( <sup>3</sup> / <sub>8</sub> to <sup>4</sup> / <sub>8</sub> cloud cover)
BKN	broken ( <sup>5</sup> / <sub>8</sub> to <sup>7</sup> / <sub>8</sub> cloud cover)
OVC	overcast ( <sup>8</sup> / <sub>8</sub> cloud cover)
CB	cumulonimbus when present
TCU	towering cumulus when present

**NOTE–**

1. “SKC” will be reported at manual stations. “CLR” will be used at automated stations when no clouds below 12,000 feet are reported.

2. A ceiling layer is not designated in the METAR code. For aviation purposes, the ceiling is the lowest broken or overcast layer, or vertical visibility into obscuration. Also, there is no provision for reporting thin layers in the METAR code. When clouds are thin, that layer must be reported as if it were opaque.

**29.3.9.2 Height.** Cloud bases are reported with three digits in hundreds of feet above ground level (AGL). (Clouds above 12,000 feet cannot be reported by an automated station).

**29.3.9.3 Type.** If towering cumulus clouds (TCU) or cumulonimbus clouds (CB) are present, they are reported after the height which represents their base.

**EXAMPLE–**

SCT025TCU BKN080 BKN250 – “two thousand five hundred scattered towering cumulus, ceiling eight thousand broken, two five thousand broken.”

SCT008 OVC012CB – “eight hundred scattered ceiling one thousand two hundred overcast cumulonimbus clouds.”

**29.3.9.4 Vertical Visibility (indefinite ceiling height).** The height into an indefinite ceiling is preceded by “VV” and followed by three digits indicating the vertical visibility in hundreds of feet. This layer indicates total obscuration.

**EXAMPLE–**

<sup>1</sup>/<sub>8</sub> SM FG VV006 – visibility one eighth, fog, indefinite ceiling six hundred.

**29.3.9.5 Obscurations** are reported when the sky is partially obscured by a ground-based phenomena by indicating the amount of obscuration as FEW, SCT, BKN followed by three zeros (000). In remarks, the obscuring phenomenon precedes the amount of obscuration and three zeros.

**EXAMPLE–**

BKN000 (IN BODY) – “sky partially obscured.”

FU BKN000 (IN REMARKS) – “smoke obscuring five– to seven–eighths of the sky.”

**29.3.9.6** When sky conditions include a layer aloft other than clouds, such as smoke or haze, the type of phenomena, sky cover, and height are shown in remarks.

**EXAMPLE–**

BKN020 (IN BODY) – “ceiling two thousand broken.”

RMK FU BKN020 – “broken layer of smoke aloft, based at two thousand.”

**29.3.9.7 Variable Ceiling.** When a ceiling is below three thousand and is variable, the remark “CIG” will be shown followed with the lowest and highest ceiling heights separated by a “V.”

**EXAMPLE–**

CIG 005V010 – “ceiling variable between five hundred and one thousand.”

**29.3.9.8 Second Site Sensor.** When an automated station uses meteorological discontinuity sensors, remarks will be shown to identify site specific sky conditions which differ and are lower than conditions reported in the body.

**EXAMPLE–**

*CIG 020 RY11 – “ceiling two thousand at Runway One One.”*

**29.3.9.9 Variable Cloud Layer.** When a layer is varying in sky cover, remarks will show the variability range. If there is more than one cloud layer, the variable layer will be identified by including the layer height.

**EXAMPLE–**

*SCT V BKN – “scattered layer variable to broken.”*

*BKN025 V OVC – “broken layer at two thousand five hundred variable to overcast.”*

**29.3.9.10 Significant Clouds.** When significant clouds are observed, they are shown in remarks, along with the specified information as shown below:

a) Cumulonimbus (CB), or Cumulonimbus Mammatus (CBMAM), distance (if known), direction from the station, and direction of movement, if known. If the clouds are beyond 10 miles from the airport, DSNT will indicate distance.

**EXAMPLE–**

*CB W MOVE – “cumulonimbus west moving east.”*

*CBMAM DSNT S – “cumulonimbus mammatus distant south.”*

b) Towering Cumulus (TCU), location, (if known), or direction from the station.

**EXAMPLE–**

*TCU OHD – “towering cumulus overhead.”*

*TCU W – “towering cumulus west.”*

c) Altocumulus Castellanus (ACC), Stratocumulus Standing Lenticular (SCSL), Altocumulus Standing Lenticular (ACSL), Cirrocumulus Standing Lenticular (CCSL) or rotor clouds, describing the clouds (if needed), and the direction from the station.

ACC W	“altocumulus castellanus west”
ACSL SW–S	“standing lenticular altocumulus southwest through south”
APRNT ROTOR CLD S	“apparent rotor cloud south”
CCSL OVR MT E	“standing lenticular cirrocumulus over the mountains east”

**29.3.10 Temperature/Dew Point.** Temperature and dew point are reported in two, two–digit groups in degrees Celsius, separated by a solidus (/). Temperatures below zero are prefixed with an “M.” If the temperature is available but the dew point is missing, the temperature is shown followed by a solidus. If the temperature is missing, the group is omitted from the report.

**EXAMPLE–**

*15/08 . . . . . “temperature one five, dew point 8”*

*00/M02 . . . . . “temperature zero, dew point minus 2”*

*M05/ . . . . . “temperature minus five, dew point missing”*

**29.3.11 Altimeter.** Altimeter settings are reported in a four–digit format in inches of mercury prefixed with an “A” to denote the units of pressure.

**EXAMPLE–**

*A2995 . . . . . “altimeter two niner niner five”*

**29.3.12 Remarks.** Remarks will be included in all observations, when appropriate. The contraction “RMK” denotes the start of the remarks section of a METAR report.

Except for precipitation, phenomena located within 5 statute miles of the point of observation will be reported as at the station. Phenomena between 5 and 10 statute miles will be reported in the vicinity, “VC.” Precipitation not occurring at the point of observation but within 10 statute miles is also reported as in the vicinity, “VC.” Phenomena beyond 10 statute miles will be shown as distant, “DSNT.” Distances are in statute miles except for

automated lightning remarks which are in nautical miles. Movement of clouds or weather will be indicated by the direction toward which the phenomena is moving.

There are two categories of remarks: Automated, Manual, and Plain Language; and Additive and Automated Maintenance Data.

**29.3.12.1 Automated, Manual, and Plain Language Remarks.** This group of remarks may be generated from either manual or automated weather reporting stations and generally elaborates on parameters reported in the body of the report. Plain language remarks are only provided by manual stations.

1) Volcanic Eruptions
2) Tornado, Funnel Cloud, Waterspout
3) Type of Automated Station (AO1 or AO2)
4) Peak Wind
5) Wind Shift
6) Tower or Surface Visibility
7) Variable Prevailing Visibility
8) Sector Visibility
9) Visibility at Second Location
10) Dispatch Visual Range
11) Lightning. When lightning is observed at a manual location, the frequency and location is reported. When cloud-to-ground lightning is detected by an automated lightning detection system, such as ALDARS: [a] Within 5 nautical miles (NM) of the Airport Reference Point (ARP), it will be reported as “TS” in the body of the report with no remark; [b] Between 5 and 10 NM of the ARP, it will be reported as “VCTS” in the body of the report with no remark; [c] Beyond 10 but less than 30 NM of the ARP, it will be reported in remarks as “DSNT” followed by the direction from the ARP. <b>EXAMPLE–</b> <i>LTG DSNT W or LTG DSNT ALQDS</i>

12) Beginning/Ending Time of Precipitation
13) Beginning/Ending Time of Thunderstorms
14) Thunderstorm Location; Movement Direction
15) Hailstone Size
16) Virga
17) Variable Ceiling
18) Obscurations
19) Variable Sky Condition
20) Significant Cloud Types
21) Ceiling Height at Second Location
22) Pressure Rising or Falling Rapidly
23) Sea-Level Pressure
24) Aircraft Mishap (not transmitted)
25) No SPECI Reports Taken
26) Snow Increasing Rapidly
27) Other Significant Information

**29.3.12.2 Additive and Automated Maintenance Data Remarks.**

1) Hourly Precipitation
2) Precipitation Amount
3) 24–Hour Precipitation
4) Snow Depth on Ground
5) Water Equivalent of Snow on Ground
6) Cloud Types
7) Duration of Sunshine
8) Hourly Temperature and Dew Point (Tenths)
9) 6–Hour Maximum Temperature
10) 6–Hour Minimum Temperature

11) 24–Hour Maximum/Minimum Temperatures
12) Pressure Tendency
13) Sensor Status:
WINO
ZRANO
SNO
VRNO
PNO
VISNO

**EXAMPLE–**  
*METAR report and explanation:*

*METAR KSFO 041453Z AUTO VRB02KT 3SM BR CLR 15/12 A3012 RMK AO2*

METAR	Type of report (aviation routine weather report)
KSFO	Station identifier (San Francisco, CA)
041453Z	Date/Time (4th day of month; time 1453 UTC)
AUTO	Fully automated; no human intervention
VRB02KT	Wind (wind variable at two)
3SM	Visibility (visibility three statute miles)
BR	Visibility obscured by mist
CLR	No clouds below one two thousand
15/12	Temperature one five; dew point one two
A3012	Altimeter three zero one two
RMK	Remarks
AO2	This automated station has a weather discriminator (for precipitation).

**EXAMPLE–**

*METAR report and explanation:*

*METAR KBNA 281250Z 33018KT 290V360 1/2SM R31/2700FT SN BLSN FG VV008 00/M03 A2991 RMK RAE42SNB42*

METAR	Aviation routine weather report
KBNA	Nashville, TN
281250Z	28th day of month; time 1250 UTC
(no modifier)	This is a manually generated report, due to the absence of “AUTO” and “AO1 or AO2” in remarks.
33018KT	Wind three three zero at one eight
290V360	Wind variable between two nine zero and three six zero
1/2SM	Visibility one half statute mile
R31/2700FT	Runway three one RVR two thousand seven hundred feet
SN	Moderate snow
BLSN FG	Visibility obscured by blowing snow and fog
VV008	Indefinite ceiling eight hundred
00/M03	Temperature zero; dew point minus three
A2991	Altimeter two niner niner one
RMK	Remarks
RAE36	Rain ended at three six
SNB42	Snow began at four two

**EXAMPLE–**

*SPECI report and explanation:*

*SPECI KCVG 152224Z 28024G36KT 3/4SM +TSRA BKN008 OVC020CB 28/23 A3000 RMK TSRAB24 TS W MOV E.*

SPECI	Nonroutine aviation special weather report
KCVG	Cincinnati, OH
152224Z	15th day of month; time 2224 UTC
(no modifier)	This is a manually generated report due to the absence of “AUTO” and “AO1 or AO2” in remarks.
28024G36KT	Wind two eight zero at two four gusts three six
3/4SM	Visibility three fourths statute mile
+TSRA	Thunderstorms, heavy rain
BKN008	Ceiling eight hundred broken
OVC020CB	Two thousand overcast cumulonimbus clouds
28/23	Temperature two eight; dew point two three
A3000	Altimeter three zero zero zero
RMK	Remarks
TSRAB24	Thunderstorm and rain began at two four
TS W MOV E	Thunderstorm west moving east

**29.4 Aerodrome Forecast (TAF).** A concise statement of the expected meteorological conditions at an airport during a specified period. At most locations, TAFs have a 24 hour forecast period. However, TAFs for some locations have a 30 hour forecast period. These forecast periods may be shorter in the case of an amended TAF. TAFs use the same codes as METAR weather reports. They are scheduled four times daily for 24–hour periods beginning at 0000Z, 0600Z, 1200Z, and 1800Z.

Forecast times in the TAF are depicted in two ways. The first is a 6–digit number to indicate a specific point in time, consisting of a two–digit date, two–digit hour, and two–digit minute (such as issuance time or FM). The second is a pair of four–digit numbers separated by a “/” to indicate a beginning and end for a period of time. In this case, each four–digit pair consists of a two–digit date and a two–digit hour.

TAFs are issued in the following format:

TYPE OF REPORT/ICAO STATION IDENTIFIER/DATE AND TIME OF ORIGIN/VALID PERIOD  
DATE AND TIME/FORECAST METEOROLOGICAL CONDITIONS

**NOTE–**

*The “/” above and in the following descriptions are for separation purposes in this publication and do not appear in the actual TAFs.*

TAF KORD 051130Z 0512/0618 14008KT 5SM BR BKN030  
TEMPO 0513/0516 1 1/2SM BR  
FM051600 16010KT P6SM SKC  
FM052300 20013G20KT 4SM SHRA OVC020  
PROB40 0600/0606 2SM TSRA OVC008CB  
BECMG 0606/0608 21015KT P6SM NSW SCT040

TAF format observed in the above example:

TAF = type of report

KORD = ICAO station identifier

051130Z = date and time of origin (issuance time)

0512/0618 = valid period date and times

14008KT 5SM BR BKN030 = forecast meteorological conditions

#### 29.4.1 Explanation of TAF elements

**29.4.1.1 Type of Report.** There are two types of TAF issuances, a routine forecast issuance (TAF) and an amended forecast (TAF AMD). An amended TAF is issued when the current TAF no longer adequately describes the on-going weather or the forecaster feels the TAF is not representative of the current or expected weather. Corrected (COR) or delayed (RTD) TAFs are identified only in the communications header which precedes the actual forecasts.

**29.4.1.2 ICAO Station Identifier.** The TAF code uses ICAO 4-letter location identifiers as described in the METAR section.

**29.4.1.3 Date and Time of Origin.** This element is the date and time the forecast is actually prepared. The format is a two-digit date and four-digit time followed, without a space, by the letter “Z.”

**29.4.1.4 Valid Period Date and Time.** The UTC valid period of the forecast consists of two four-digit sets, separated by a “/”. The first four-digit set is a two-digit date followed by the two-digit beginning hour, and the second four-digit set is a two-digit date followed by the two-digit ending hour. Although most airports have a 24-hour TAF, a select number of airports have a 30-hour TAF. In the case of an amended forecast, or a forecast which is corrected or delayed, the valid period may be for less than 24 hours. Where an airport or terminal operates on a part-time basis (less than 24 hours/day), the TAFs issued for those locations will have the abbreviated statement “AMD NOT SKED” added to the end of the forecasts. The time observations are scheduled to end and/or resume will be indicated by expanding the AMD NOT SKED statement. Expanded statements will include:

- a) Observation ending time (AFT DDHHmm; for example, AFT 120200)
- b) Scheduled observations resumption time (TIL DDHHmm; for example, TIL 171200Z) or
- c) Period of observation unavailability (DDHH/DDHH); for example, 2502/2512).

**29.4.1.5 Forecast Meteorological Conditions.** This is the body of the TAF. The basic format is:

Wind / Visibility / Weather / Sky Condition / Optional Data (Wind Shear)

The wind, visibility, and sky condition elements are always included in the initial time group of the forecast. Weather is included only if significant to aviation. If a significant, lasting change in any of the elements is expected during the valid period, a new time period with the changes is included. It should be noted that with the exception of an “FM” group, the new time period will include only those elements which are expected to change; i.e., if a lowering of the visibility is expected but the wind is expected to remain the same, the new time period reflecting the lower visibility would not include a forecast wind. The forecast wind would remain the same as in the previous time period.

Any temporary conditions expected during a specific time period are included with that time period. The following describes the elements in the above format.

**a) Wind.** This five (or six) digit group includes the expected wind direction (first 3 digits) and speed (last 2 digits or 3 digits if 100 knots or greater). The contraction “KT” follows to denote the units of wind speed. Wind gusts are noted by the letter “G” appended to the wind speed followed by the highest expected gust.

**NOTE–**

*A variable wind direction is noted by “VRB” where the three digit direction usually appears. A calm wind (3 knots or less) is forecast as “00000KT.”*



**EXAMPLE–**

18010KT – wind one eight zero at one zero (wind is blowing from 180 at 10 knots).

35012G20KT – wind three five zero at one two gust two zero

**b) Visibility.** The expected prevailing visibility up to and including 6 miles is forecast in statute miles, including fractions of miles, followed by “SM” to note the units of measure. Expected visibilities greater than 6 miles are forecast as P6SM (Plus six statute miles).

**EXAMPLE–**

1/2SM . . . . . visibility one-half

4SM . . . . . visibility four

P6SM . . . . . visibility more than six

**c) Weather Phenomena.** The expected weather phenomena is coded in TAF reports using the same format, qualifiers, and phenomena contractions as METAR reports (except UP).

Obscurations to vision will be forecast whenever the prevailing visibility is forecast to be 6 statute miles or less.

If no significant weather is expected to occur during a specific time period in the forecast, the weather group is omitted for that time period. If, after a time period in which significant weather has been forecast, a change to a forecast of no significant weather occurs, the contraction NSW (no significant weather) will appear as the weather group in the new time period. (NSW is included only in temporary (TEMPO) groups.)

**NOTE–**

It is very important that pilots understand that NSW only refers to weather phenomena, i.e., rain, snow, drizzle, etc. Omitted conditions, such as sky conditions, visibility, winds, etc., are carried over from the previous time group.

**d) Sky Condition.** TAF sky condition forecasts use the METAR format described in the METAR section. Cumulonimbus clouds (CB) are the only cloud type forecast in TAFs. When clear skies are forecast, the contraction “SKC” will always be used. The contraction “CLR” is never used in the aerodrome forecast (TAF). When the sky is obscured due to a surface-based phenomenon, vertical visibility (VV) into the obscuration is forecast. The format for vertical visibility is “VV” followed by a three-digit height in hundreds of feet.

**NOTE–**

As in METAR, ceiling layers are not designated in the TAF code. For aviation purposes, the ceiling is the lowest broken or overcast layer or vertical visibility into a complete obscuration.

SKC	“sky clear”
SCT005 BKN025CB	“five hundred scattered, ceiling two thousand five hundred broken cumulonimbus clouds”
VV008	“indefinite ceiling eight hundred”

**e) Optional Data (Wind Shear).** Wind Shear is the forecast of non-convective, low-level winds (up to 2,000 feet). The forecast includes the letters “WS” followed by the height of the wind shear, the wind direction and wind speed at the indicated height and the ending letters “KT” (knots). Height is given in hundreds of feet (AGL) up to and including 2,000 feet. Wind shear is encoded with the contraction “WS” followed by a three-digit height, slant character “/” and winds at the height indicated in the same format as surface winds. The wind shear element is omitted if not expected to occur.

WS010/18040KT “low level wind shear at one thousand, wind one eight zero at four zero”

**29.5 Probability Forecast.** The probability or chance of thunderstorms or other precipitation events occurring, along with associated weather conditions (wind, visibility, and sky conditions). The PROB30 group is used when the occurrence of thunderstorms or precipitation is 30–39% and the PROB40 group is used when the occurrence of thunderstorms or precipitation is 40–49%. This is followed by two four-digit groups separated by a “/”, giving the beginning date and hour, and the ending date and hour of the time period during which the thunderstorms or precipitation are expected.

**NOTE–**

NWS does not use PROB 40 in the TAF. However U.S. Military generated TAFS may include PROB40. PROB30 will not be shown during the first nine hours of a NWS forecast.

**EXAMPLE–**

*PROB40 2221/2302 1/2SM +TSRA “chance between 2100Z and 0200Z of visibility one-half statute mile in thunderstorms and heavy rain.”*

*PROB30 3010/3014 1SM RASN . “chance between 1000Z and 1400Z of visibility one statute mile in mixed rain and snow.”*

**29.6 Forecast Change Indicators.** The following change indicators are used when either a rapid, gradual, or temporary change is expected in some or all of the forecast meteorological conditions. Each change indicator marks a time group within the TAF report.

**29.6.1 From (FM) Group.** The FM group is used when a rapid change, usually occurring in less than one hour, in prevailing conditions is expected. Typically, a rapid change of prevailing conditions to more or less a completely new set of prevailing conditions is associated with a synoptic feature passing through the terminal area (cold or warm frontal passage). Appended to the “FM” indicator is the six-digit date, hour, and minute the change is expected to begin and continues until the next change group or until the end of the current forecast. A “FM” group will mark the beginning of a new line in a TAF report (indented 5 spaces). Each “FM” group contains all the required elements—wind, visibility, weather, and sky condition. Weather will be omitted in “FM” groups when it is not significant to aviation. FM groups will not include the contraction NSW.

**EXAMPLE–**

*FM210100 14010KT P6SM SKC – “after 0100Z on the 21st, wind one four zero at one zero, visibility more than six, sky clear.”*

**29.6.2 Becoming (BECMG) Group.** The BECMG group is used when a gradual change in conditions is expected over a longer time period, usually two hours. The time period when the change is expected is two four-digit groups separated by a “/”, with the beginning date and hour, and ending date and hour of the change period which follows the BECMG indicator. The gradual change will occur at an unspecified time within this time period. Only the changing forecast meteorological conditions are included in BECMG groups. The omitted conditions are carried over from the previous time group.

**NOTE–**

*The NWS does not use BECMG in the TAF.*

**EXAMPLE–**

*OVC012 BECMG 0114/0116 BKN020 – “ceiling one thousand two hundred overcast. Then a gradual change to ceiling two thousand broken between 1400Z on the 1st and 1600Z on the 1st.”*

**29.6.3 Temporary (TEMPO) Group.** The TEMPO group is used for any conditions in wind, visibility, weather, or sky condition which are expected to last for generally less than an hour at a time (occasional), and are expected to occur during less than half the time period. The TEMPO indicator is followed by two four-digit groups separated by a “/”. The first four digit group gives the beginning date and hour, and the second four digit group gives the ending date and hour of the time period during which the temporary conditions are expected. Only the changing forecast meteorological conditions are included in TEMPO groups. The omitted conditions are carried over from the previous time group.

**EXAMPLE–**

**1.** *SCT030 TEMPO 0519/0523 BKN030 – “three thousand scattered with occasional ceilings three thousand broken between 1900Z on the 5th and 2300Z on the 5th.”*

**2.** *4SM HZ TEMPO 1900/1906 2SM BR HZ – “visibility four in haze with occasional visibility two in mist and haze between 0000Z on the 19th and 0600Z on the 19th.”*

FIG GEN 3.5–24



**Key to Aerodrome Forecast (TAF) and Aviation Routine Weather Report (METAR) (Front)**



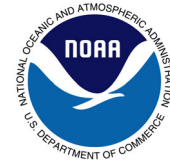
<b>TAF</b>	KPIT 091730Z 0918/1024 15005KT 5SM HZ FEW020 WS010/31022KT FM091930 30015G25KT 3SM SHRA OVC015 TEMPO 0920/0922 1/2SM +TSRA OVC008CB FM100100 27008KT 5SM SHRA BKN020 OVC040 PROB30 1004/1007 1SM -RA BR FM101015 18005KT 6SM -SHRA OVC020 BECMG 1013/1015 P6SM NSW SKC
<b>NOTE:</b> Users are cautioned to confirm <b>DATE</b> and <b>TIME</b> of the TAF. For example FM100000 is 0000Z on the <b>10th</b> . Do not confuse with <b>1000Z!</b>	
<b>METAR</b>	KPIT 091955Z COR 22015G25KT 3/4SM R28L/2600FT TSRA OVC010CB 18/16 A2992 RMK SLP045 T01820159

Forecast	Explanation	Report
<b>TAF</b>	Message type: <u>TAF</u> -routine or <u>TAF AMD</u> -amended forecast, <u>METAR</u> -hourly, <u>SPECI</u> -special or <u>TESTM</u> -non-commissioned ASOS report	<b>METAR</b>
<b>KPIT</b>	ICAO location indicator	<b>KPIT</b>
<b>091730Z</b>	Issuance time: ALL times in UTC “ <u>Z</u> ”, 2-digit date, 4-digit time	<b>091955Z</b>
<b>0918/1024</b>	Valid period, either 24 hours or 30 hours. The first two digits of EACH four digit number indicate the date of the valid period, the final two digits indicate the time (valid from 18Z on the 9 <sup>th</sup> to 24Z on the 10 <sup>th</sup> ). In U.S. METAR: <u>COR</u> rected ob; or <u>AUTOM</u> ated ob for automated report with no human intervention; omitted when observer logs on.	<b>COR</b>
<b>15005KT</b>	Wind: 3 digit true-north direction , nearest 10 degrees (or <u>VaRiA</u> ble); next 2-3 digits for speed and unit, <u>KT</u> (KMH or MPS); as needed, <u>G</u> ust and maximum speed; 00000KT for calm; for METAR, if direction varies 60 degrees or more, <u>V</u> ariability appended, e.g., 180 <u>V</u> 260	<b>22015G25KT</b>
<b>5SM</b>	Prevailing visibility; in U.S., Statute <u>M</u> iles & fractions; above 6 miles in TAF <u>Plus6SM</u> . (Or, 4-digit minimum visibility in meters and as required, lowest value with direction)	<b>¾SM</b>
	Runway Visual Range: <u>R</u> ; 2-digit runway designator <u>L</u> eft, <u>C</u> enter, or <u>R</u> ight as needed; “ <u>L</u> ”, Minus or Plus in U.S., 4-digit value, <u>F</u> ee <u>T</u> in U.S., (usually meters elsewhere); 4-digit value <u>V</u> ariability 4-digit value (and tendency <u>D</u> own, <u>U</u> p or <u>N</u> o change)	<b>R28L/2600FT</b>
<b>HZ</b>	Significant present, forecast and recent weather: see table (on back)	<b>TSRA</b>
<b>FEW020</b>	Cloud amount, height and type: <u>S</u> ky <u>C</u> lear 0/8, <u>F</u> EW >0/8-2/8, <u>S</u> ca <u>T</u> tered 3/8-4/8, <u>B</u> ro <u>K</u> e <u>N</u> 5/8-7/8, <u>O</u> ver <u>C</u> ast 8/8; 3-digit height in hundreds of ft; <u>T</u> owering <u>C</u> umulus or <u>C</u> umulonim <u>B</u> us in <b>METAR</b> ; in <b>TAF</b> , only <u>C</u> B, <u>V</u> ertical <u>V</u> isibility for obscured sky and height “VV004”. More than 1 layer may be reported or forecast. In automated <b>METAR</b> reports only, <u>C</u> lea <u>R</u> for “clear below 12,000 feet”	<b>OVC 010CB</b>
	Temperature: degrees Celsius; first 2 digits, temperature “ <u>L</u> ” last 2 digits, dew-point temperature; <u>M</u> inus for below zero, e.g., M06	<b>18/16</b>
	Altimeter setting: indicator and 4 digits; in U.S., <u>A</u> -inches and hundredths; ( <u>Q</u> -hectoPascals, e.g., Q1013)	<b>A2992</b>
<b>WS010/31022KT</b>	In U.S. <b>TAF</b> , non-convective low-level (≤2,000 ft) <u>W</u> ind <u>S</u> hear; 3-digit height (hundreds of ft); “ <u>L</u> ”; 3-digit wind direction and 2-3 digit wind speed above the indicated height, and unit, <u>KT</u>	

FIG GEN 3.5-25



**Key to Aerodrome Forecast (TAF) and Aviation Routine Weather Report (METAR) (Back)**



	In <b>METAR</b> , <b>ReMarK</b> indicator & remarks. For example: <u>Sea- Level</u> Pressure in hectoPascals & tenths, as shown: 1004.5 hPa; <u>Temp/</u> dew-point in tenths °C, as shown: temp. 18.2°C, dew-point 15.9°C	<b>RMK SLP045 T01820159</b>
<b>FM091930</b>	<b>FroM</b> : changes are expected at: 2-digit date, 2-digit hour, and 2-digit minute beginning time: indicates significant change. Each FM starts on a new line, indented 5 spaces	
<b>TEMPO 0920/0922</b>	<b>TEMPO</b> rary: changes expected for <1 hour and in total, < half of the period between the 2-digit date and 2-digit hour beginning, and 2-digit date and 2-digit hour ending time	
<b>PROB30 1004/1007</b>	<b>PROB</b> ability and 2-digit percent (30 or 40): probable condition in the period between the 2-digit date & 2-digit hour beginning time, and the 2-digit date and 2-digit hour ending time	
<b>BECMG 1013/1015</b>	<b>BECO</b> minG: change expected in the period between the 2-digit date and 2-digit hour beginning time, and the 2-digit date and 2-digit hour ending time	

<b>Table of Significant Present, Forecast and Recent Weather - Grouped in categories and used in the order listed below; or as needed in TAF, No Significant Weather.</b>			
<b>Qualifiers</b>			
<b>Intensity or Proximity</b>			
“-” = Light	<b>No sign</b> = Moderate	“+” = Heavy	
“ <b>VC</b> ” = Vicinity, but not at aerodrome. In the US METAR, 5 to 10 SM from the point of observation. In the US TAF, 5 to 10 SM from the center of the runway complex. Elsewhere, within 8000m.			
<b>Descriptor</b>			
<b>BC</b> – Patches	<b>BL</b> – Blowing	<b>DR</b> – Drifting	<b>FZ</b> – Freezing
<b>MI</b> – Shallow	<b>PR</b> – Partial	<b>SH</b> – Showers	<b>TS</b> – Thunderstorm
<b>Weather Phenomena</b>			
<b>Precipitation</b>			
<b>DZ</b> – Drizzle	<b>GR</b> – Hail	<b>GS</b> – Small Hail/Snow Pellets	
<b>IC</b> – Ice Crystals	<b>PL</b> – Ice Pellets	<b>RA</b> – Rain	<b>SG</b> – Snow Grains
<b>SN</b> – Snow	<b>UP</b> – Unknown Precipitation in automated observations		
<b>Obscuration</b>			
<b>BR</b> – Mist (≥5/8SM)	<b>DU</b> – Widespread Dust	<b>FG</b> – Fog (<5/8SM)	<b>FU</b> – Smoke
<b>HZ</b> – Haze	<b>PY</b> – Spray	<b>SA</b> – Sand	<b>VA</b> – Volcanic Ash
<b>Other</b>			
<b>DS</b> – Dust Storm	<b>FC</b> – Funnel Cloud	<b>+FC</b> – Tornado or Waterspout	
<b>PO</b> – Well developed dust or sand whirls	<b>SQ</b> – Squall	<b>SS</b> – Sandstorm	
<ul style="list-style-type: none"> <li>- Explanations in parentheses “( )” indicate different worldwide practices.</li> <li>- Ceiling is not specified; defined as the lowest broken or overcast layer, or the vertical visibility.</li> <li>- NWS TAFs exclude BECMG groups and temperature forecasts, NWS TAFS do not use PROB in the first 9 hours of a TAF; NWS METARs exclude trend forecasts. US Military TAFs include Turbulence and Icing groups.</li> </ul>			

### 30. Meteorological Broadcasts (ATIS, VHF and LF)

#### 30.1 Automatic Terminal Information Service (ATIS) Broadcasts

30.1.1 These broadcasts are made continuously and include as weather information only the ceiling, visibility, wind, and altimeter setting of the aerodrome at which they are located.

#### 30.2 Navigational Aids Providing Broadcast Services

30.2.1 A compilation of navigational aids over which weather broadcasts are transmitted is not available for this publication. Complete information concerning all navigational aids providing this service is contained in the Chart Supplement U.S. Similar information for the Pacific and Alaskan areas is contained in the Chart Supplements Pacific and Alaska.

*TBL GEN 3.5–15*  
**Meteorological Broadcasts (VOLMET)**

Name	Call Sign	Frequency	Broadcast	Form	Contents	Emission	Remarks
New York	New York Radio	3485, 6604, 10051, 13270 kHz	H00–05	Aerodrome Forecasts	KDTW Detroit KCLE Cleveland KCVG Cincinnati	Voice	Plain language English
				Hourly Reports	KDTW Detroit KCLE Cleveland KCVG Cincinnati KIND Indianapolis KPIT Pittsburgh		
			H05–10	SIGMET	Oceanic – New York FIR		
				Aerodrome Forecasts	KBGR Bangor KBDL Windsor Locks KCLT Charlotte		
				Hourly Reports	KBGR Bangor KBDL Windsor Locks KORF Norfolk KCLT Charlotte		
			H10–15	Aerodrome Forecasts	KJFK New York KEWR Newark KBOS Boston		
				Hourly Reports	KJFK New York KEWR Newark KBOS Boston KBAL Baltimore KIAD Washington		
			H15–20	SIGMET	Oceanic – Miami FIR/San Juan FIR		
				Aerodrome Forecasts	MXKF Bermuda KMIA Miami KATL Atlanta		
				Hourly Reports	MXKF Bermuda KMIA Miami MYNN Nassau KMCO Orlando KATL Atlanta		
			H30–35	Aerodrome Forecasts	KORD Chicago KMKE Milwaukee KMSP Minneapolis		
				Hourly Reports	KORD Chicago KMKE Milwaukee KMSP Minneapolis KDTW Detroit KBOS Boston		
			E35–40	SIGMET	Oceanic – New York FIR		

Name	Call Sign	Frequency	Broadcast	Form	Contents	Emission	Remarks
				Aerodrome Forecasts	KIND Indianapolis KSTL St. Louis KPIT Pittsburgh		
				Hourly Reports	KIND Indianapolis KSTL St. Louis KPIT Pittsburgh KACY Atlantic City		
			E40-45	Aerodrome Forecasts	KBAL Baltimore KPHL Philadelphia KIAD Washington		
				Hourly Reports	KBAL Baltimore KPHL Philadelphia KIAD Washington KJFK New York KEWR Newark		
			E45-50	SIGMET	Oceanic - Miami FIR/San Juan FIR		
				Aerodrome Forecasts	MYNN Nassau KMCO Orlando		
				Hourly Reports	MXKF Bermuda KMIA Miami MYNN Nassau KMCO Orlando KATL Atlanta KTPA Tampa KPBI West Palm Beach		
All stations operate on A3 emission H24.							
All broadcasts are made 24 hours daily, seven days a week.							

FIG GEN 3.5-26

Key to Decode an ASOS/AWOS (METAR) Observation (Front)

METAR KABC 121755Z AUTO 21016G24KT 180V240 1SM R11/P6000FT -RA BR BKN015 OVC025 06/04 A2990  
RMK A02 PK WND 20032/25 WSHFT 1715 VIS 3/4V1 1/2 VIS 3/4 RWY11 RAB07 CIG 013V017 CIG 017 RWY11 PRESFR  
SLP125 P0003 6009 T00640036 10066 21012 58033 TSNO \$

<b>TYPE OF REPORT</b>	METAR: hourly (scheduled report); SPECI: special (unscheduled) report.	METAR
<b>STATION IDENTIFIER</b>	Four alphabetic characters; ICAO location identifiers.	KABC
<b>DATE/TIME</b>	All dates and times in UTC using a 24-hour clock; two-digit date and four-digit time; always appended with <u>Z</u> to indicate UTC.	121755Z
<b>REPORT MODIFIER</b>	Fully automated report, no human intervention; removed when observer signed-on.	AUTO
<b>WIND DIRECTION AND SPEED</b>	Direction in tens of degrees from true north (first three digits); next two digits: speed in whole knots; as needed <u>G</u> usts (character) followed by maximum observed speed; always appended with <u>KT</u> to indicate knots; 00000KT for calm; if direction varies by 60° or more a <u>V</u> ariable wind direction group is reported.	21016G24KT 108V240
<b>VISIBILITY</b>	Prevailing visibility in statute miles and fractions (space between whole miles and fractions); always appended with <u>SM</u> to indicate statute miles.	1SM
<b>RUNWAY VISUAL RANGE</b>	10-minute RVR value in hundreds of feet; reported if prevailing visibility is ≤ one mile or RVR ≤6000 feet; always appended with <u>FT</u> to indicate feet; value prefixed with <u>M</u> or <u>P</u> to indicate value is lower or higher than the reportable RVR value.	R11/P6000FT
<b>WEATHER PHENOMENA</b>	RA: liquid precipitation that does not freeze; SN: frozen precipitation other than hail; UP: precipitation of unknown type; intensity prefixed to precipitation: light (-), moderate (no sign), heavy (+); FG: fog; FZFG: freezing fog (temperature below 0°C); BR: mist; HZ: haze; SQ: squall; maximum of three groups reported; augmented by observer: FC (funnel cloud/tornado/waterspout); TS(thunderstorm); GR (hail); GS (small hail; <1/4 inch); FZRA (intensity; freezing rain); VA (volcanic ash).	-RA BR
<b>SKY CONDITION</b>	Cloud amount and height: CLR (no clouds detected below 12000 feet); FEW (few); SCT (scattered); BKN (broken); OVC (overcast); followed by 3-digit height in hundreds of feet; or vertical visibility (VV) followed by height for indefinite ceiling.	BKN015 OVC025
<b>TEMPERATURE/DEW POINT</b>	Each is reported in whole degrees Celsius using two digits; values are separated by a solidus; sub-zero values are prefixed with an <u>M</u> (minus).	06/04
<b>ALTIMETER</b>	Altimeter always prefixed with an <u>A</u> indicating inches of mercury; reported using four digits: tens, units, tenths, and hundredths.	A2990

FIG GEN 3.5-27

**Key to Decode an ASOS/AWOS (METAR) Observation (Back)**

<b>REMARKS IDENTIFIER: RMK</b>	RMK
<b>TORNADIC ACTIVITY:</b> Augmented; report should include TORNADO, FUNNEL CLOUD, or WATERSPOUT, time begin/end, location, movement; e.g., TORNADO B25 N MOV E.	
<b>TYPE OF AUTOMATED STATION:</b> AO2; automated station with precipitation discriminator.	AO2
<b>PEAK WIND:</b> PK WND dddff(f)/(hh)mm; direction in tens of degrees, speed in whole knots, and time.	PK WND 20032/25
<b>WIND SHIFT:</b> WSHFT (hh)mm	WSHFT 1715
<b>TOWER OR SURFACE VISIBILITY:</b> TWR VIS vvvv: visibility reported by tower personnel, e.g., TWR VIS 2; SFC VIS vvvvv; visibility reported by ASOS, e.g., SFC VIS 2.	
<b>VARIABLE PREVAILING VISIBILITY:</b> VIS v <sub>n</sub> V <sub>n</sub> V <sub>n</sub> V <sub>n</sub> V <sub>n</sub> V <sub>n</sub> V <sub>n</sub> V <sub>n</sub> V <sub>n</sub> ; reported if prevailing visibility is <3 miles and variable.	VIS 3/4V1 1/2
<b>VISIBILITY AT SECOND LOCATION:</b> VIS vvvvv [LOC]; reported if different than the reported prevailing visibility in body of report.	VIS 3/4 RWY11
<b>LIGHTNING:</b> [FREQ] LTG [LOC]; when detected the frequency and location is reported, e.g., FRQ LTG NE.	
<b>BEGINNING AND ENDING OF PRECIPITATION AND THUNDERSTORMS:</b> w'w'B(hh)mmE(hh)mm	RAB07
<b>VIRGA:</b> Augmented; precipitation not reaching the ground, e.g., VIRGA.	
<b>VARIABLE CEILING HEIGHT:</b> CIG h <sub>n</sub> h <sub>n</sub> h <sub>n</sub> Vh <sub>n</sub> h <sub>n</sub> h <sub>n</sub> ; reported if ceiling in body of report is <3000 feet and variable.	CIG 013V017
<b>CEILING HEIGHT AT SECOND LOCATION:</b> CIG hhh [LOC]; Ceiling height reported if secondary ceilometer site is different than the ceiling height in the body of the report.	CIG 017 RWY11
<b>PRESSURE RISING OR FALLING RAPIDLY:</b> PRESRR or PRESFR; pressure rising or falling rapidly at time of observation.	PRESFR
<b>SEA-LEVEL PRESSURE:</b> SLPppp; tens, units, and tenths of SLP in hPa.	SLP125
<b>HOURLY PRECIPITATION AMOUNT:</b> Prrrr; in .01 inches since last METAR; a trace is P0000.	P0003
<b>3- AND 6-HOUR PRECIPITATION AMOUNT:</b> 6RRRR; precipitation amount in .01 inches for past 6 hours reported in 00, 06, 12, and 18 UTC observations and for past 3 hours in 03, 09, 15, and 21 UTC observations; a trace is 60000.	60009
<b>24-HOUR PRECIPITATION AMOUNT:</b> 7R <sub>24</sub> R <sub>24</sub> R <sub>24</sub> ; precipitation amount in .01 inches for past 24 hours reported in 12 UTC observation, e.g., 70015.	
<b>HOURLY TEMPERATURE AND DEW POINT:</b> Ts <sub>n</sub> T <sub>a</sub> T <sub>a</sub> T <sub>a</sub> T <sub>a</sub> T <sub>a</sub> T <sub>a</sub> T <sub>a</sub> T <sub>a</sub> ; tenth of degree Celsius; s <sub>n</sub> : 1 if temperature below 0° C and 0 if temperature 0° C or higher.	T00640036
<b>6-HOUR MAXIMUM TEMPERATURE:</b> 1s <sub>n</sub> T <sub>x</sub> T <sub>x</sub> T <sub>x</sub> ; tenth of degree Celsius; 00, 06, 12, 18 UTC; s <sub>n</sub> : 1 if temperature below 0° C and 0 if temperature 0° C or higher.	10066
<b>6-HOUR MINIMUM TEMPERATURE:</b> 2s <sub>n</sub> T <sub>n</sub> T <sub>n</sub> T <sub>n</sub> ; tenth of degree Celsius; 00, 06, 12, 18 UTC; s <sub>n</sub> : 1 if temperature below 0° C and 0 if temperature 0° C or higher.	21012
<b>24-HOUR MAXIMUM AND MINIMUM TEMPERATURE:</b> 4s <sub>n</sub> T <sub>x</sub> T <sub>x</sub> T <sub>x</sub> T <sub>x</sub> T <sub>n</sub> T <sub>n</sub> T <sub>n</sub> T <sub>n</sub> ; tenth of degree Celsius; reported at midnight local standard time; 1 if temperature below 0° C and 0 if temperature 0° C or higher, e.g., 400461006.	
<b>PRESSURE TENDENCY:</b> 5app; the character (a) and change in pressure (ppp); tenths of hPa) the past 3 hours.	58033
<b>SENSOR STATUS INDICATORS:</b> RVRNO: RVR missing; PWINO: precipitation identifier information not available; PNO: precipitation amount not available; FZRANO: freezing rain information not available; TSNO: thunderstorm information not available; VISNO [LOC]: visibility at secondary location not available, e.g., VISNO RWY06; CHINO [LOC]: (cloud-height-indicator) sky condition at secondary location not available, e.g., CHINO RWY06.	TSNO
<b>MAINTENANCE CHECK INDICATOR:</b> Maintenance needed on the system.	\$
If an element or phenomena does not occur, is missing, or cannot be observed, the corresponding group and space are omitted (body and/or remarks) from that particular report, except for Sea-Level Pressure (SLPppp). SLPNO shall be reported in a METAR when the SLP is not available.	

U.S. DEPARTMENT OF TRANSPORTATION • FEDERAL AVIATION ADMINISTRATION • Aviation Weather Directorate, 400 7<sup>th</sup> Street, SW, Rooms 8200-8326, Washington, D.C. 20591



FIG GEN 3.5-28  
NEXRAD Coverage

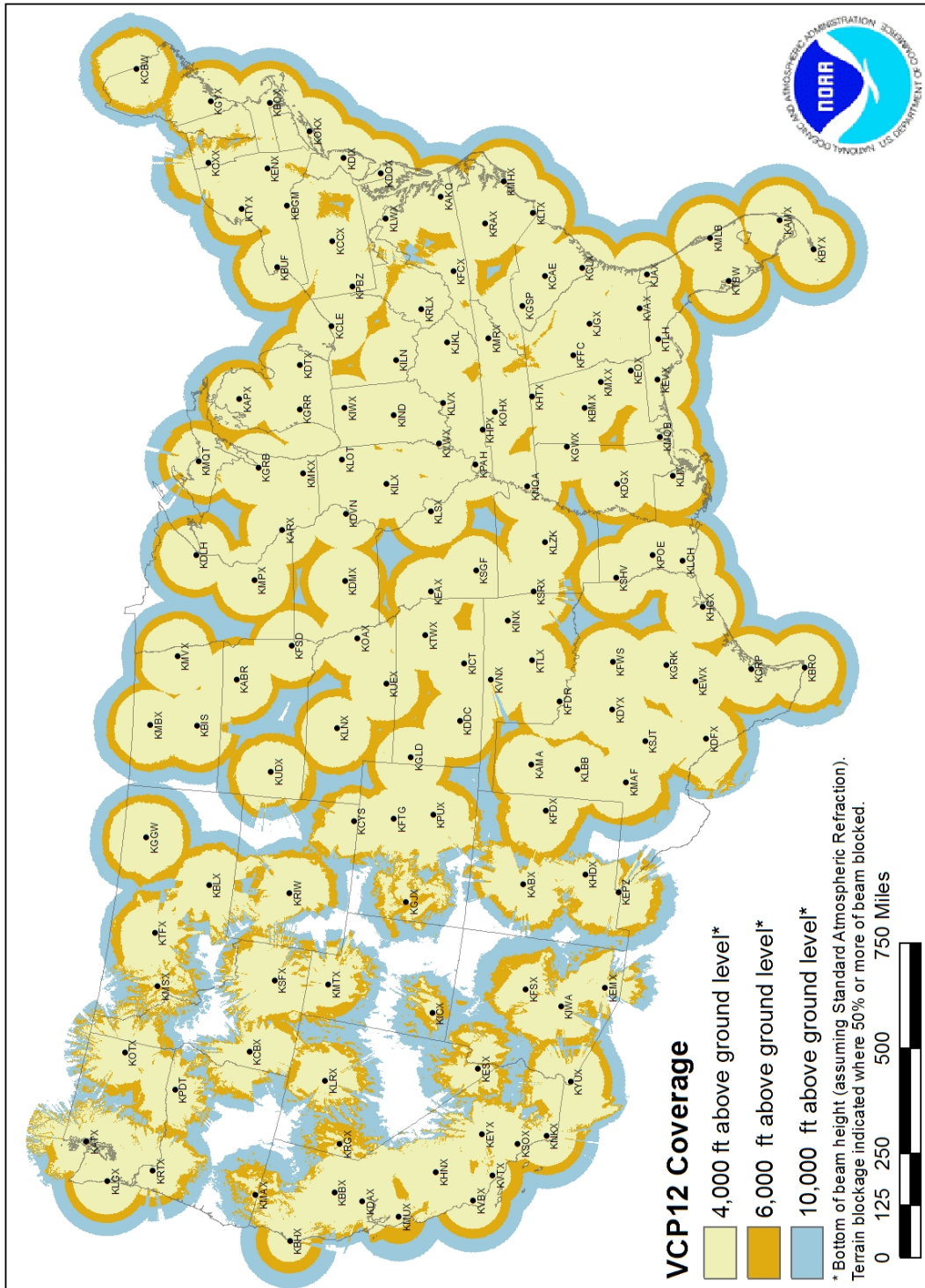


FIG GEN 3.5-29  
NEXRAD Coverage

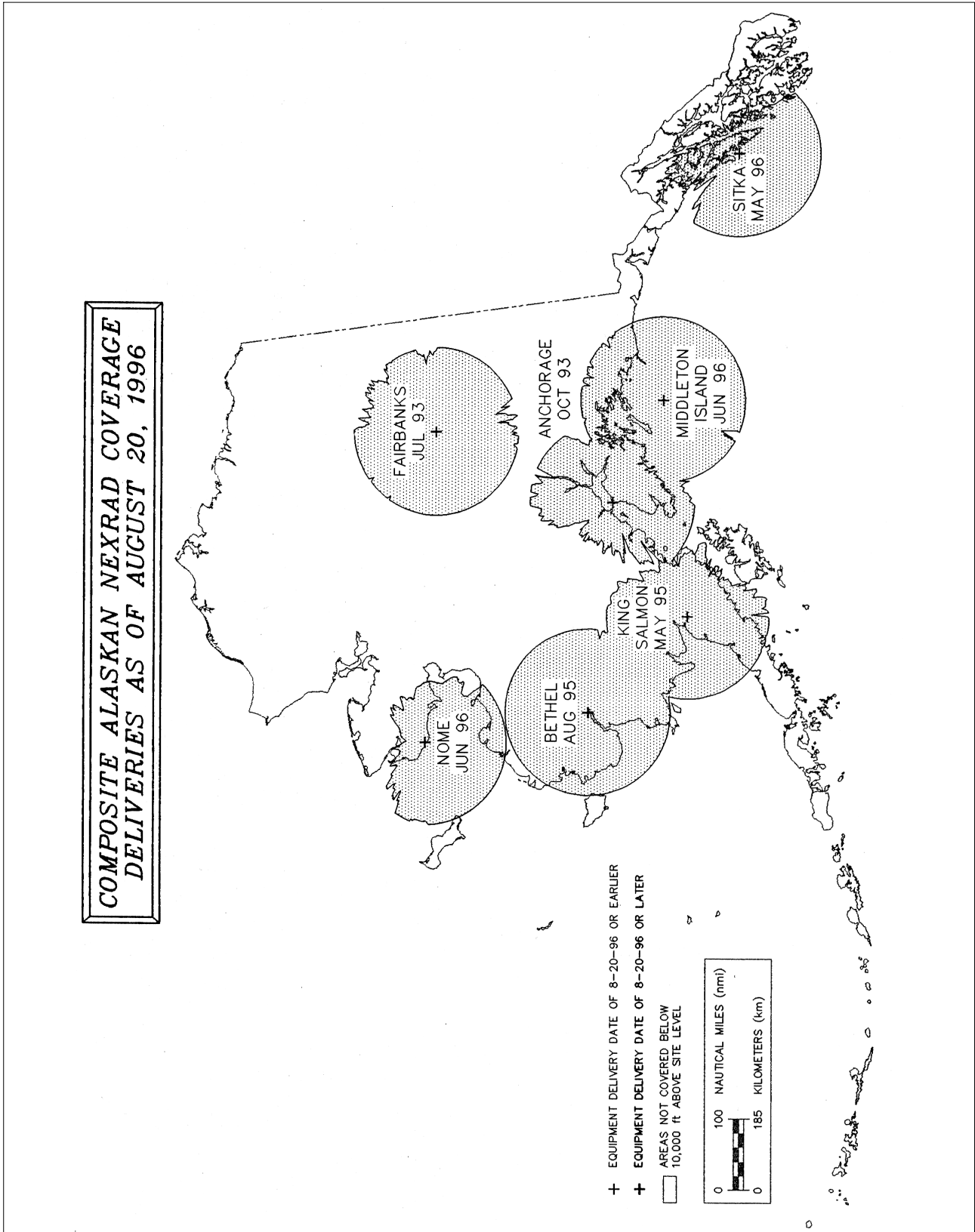
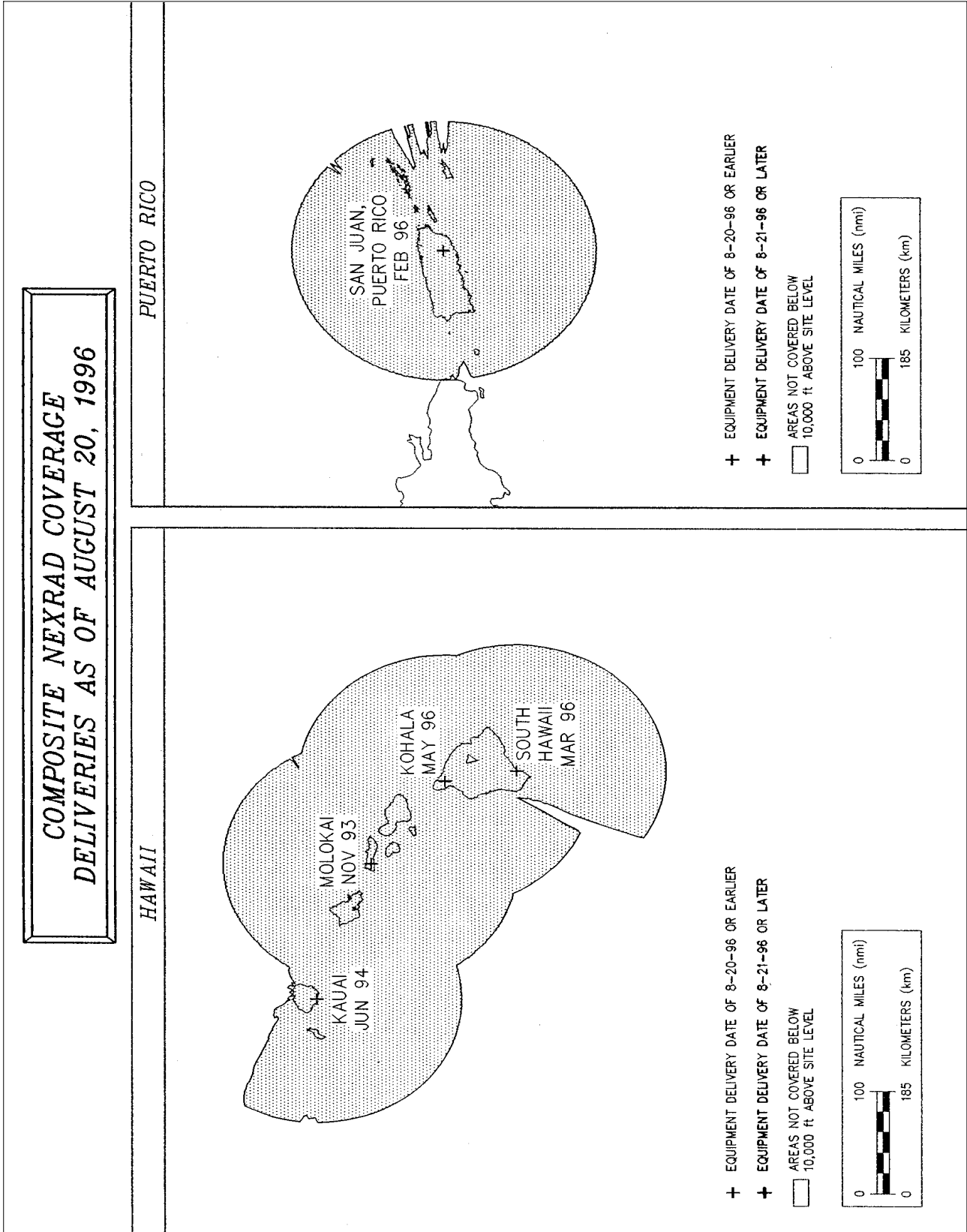


FIG GEN 3.5-30  
NEXRAD Coverage



**FIG GEN 3.5-31**  
**Volcanic Activity Reporting Form (VAR)**

Air-reports are critically important in assessing the hazards which volcanic ash cloud presents to aircraft operations.

OPERATOR:		A/C IDENTIFICATION: (as indicated on flight plan)			
PILOT-IN-COMMAND:					
DEP FROM:	DATE:	TIME; UTC:	ARR AT:	DATE:	TIME; UTC:
ADDRESSEE			AIREP SPECIAL		
<b>Items 1-8 are to be reported immediately to the ATS unit that you are in contact with.</b>					
1) AIRCRAFT IDENTIFICATION			2) POSITION		
3) TIME			4) FLIGHT LEVEL OR ALTITUDE		
5) VOLCANIC ACTIVITY OBSERVED AT (position or bearing, estimated level of ash cloud and distance from aircraft)					
6) AIR TEMPERATURE			7) SPOT WIND		
Other _____					
8) SUPPLEMENTARY INFORMATION					
SO <sub>2</sub> detected    Yes <input type="checkbox"/> No <input type="checkbox"/>					
Ash encountered    Yes <input type="checkbox"/> No <input type="checkbox"/>					
(Brief description of activity especially vertical and lateral extent of ash cloud and, where possible, horizontal movement, rate of growth, etc.)					
<b>After landing complete items 9-16 then fax form to: (Fax number to be provided by the meteorological authority based on local arrangements between the meteorological authority and the operator concerned.)</b>					
9) DENSITY OF ASH CLOUD		<input type="checkbox"/> (a) Wispy	<input type="checkbox"/> (b) Moderate dense	<input type="checkbox"/> (c) Very dense	
10) COLOUR OF ASH CLOUD		<input type="checkbox"/> (a) White	<input type="checkbox"/> (b) Light grey	<input type="checkbox"/> (c) Dark grey	
		<input type="checkbox"/> (d) Black	<input type="checkbox"/> (e) Other _____		
11) ERUPTION		<input type="checkbox"/> (a) Continuous	<input type="checkbox"/> (b) Intermittent	<input type="checkbox"/> (c) Not visible	
12) POSITION OF ACTIVITY		<input type="checkbox"/> (a) Summit	<input type="checkbox"/> (b) Side	<input type="checkbox"/> (c) Single	
		<input type="checkbox"/> (d) Multiple	<input type="checkbox"/> (e) Not observed		
13) OTHER OBSERVED FEATURES OF ERUPTION		<input type="checkbox"/> (a) Lightning	<input type="checkbox"/> (b) Glow	<input type="checkbox"/> (c) Large rocks	
		<input type="checkbox"/> (d) Ash fallout	<input type="checkbox"/> (e) Mushroom cloud	<input type="checkbox"/> (f) All	
14) EFFECT ON AIRCRAFT		<input type="checkbox"/> (a) Communication	<input type="checkbox"/> (b) Navigation systems	<input type="checkbox"/> (c) Engines	
		<input type="checkbox"/> (d) Pitot static	<input type="checkbox"/> (e) Windscreen	<input type="checkbox"/> (f) Windows	
15) OTHER EFFECTS		<input type="checkbox"/> (a) Turbulence	<input type="checkbox"/> (b) St. Elmo's Fire	<input type="checkbox"/> (c) Other fumes	
16) OTHER INFORMATION (Any information considered useful.)					

Date: 07/19/2010

## GEN 3.6 Search and Rescue

### 1. Responsible Authority

**1.1** The Search and Rescue (SAR) service in the U.S. and its area of jurisdiction is organized in accordance with the Standards and Recommended Practices of ICAO Annex 12 by the Federal Aviation Administration with the collaboration of the U.S. Coast Guard and the U.S. Air Force. The Coast Guard and the Air Force are the responsible SAR authorities and have the responsibility for making the necessary facilities available. Postal and telegraphic addresses for the Federal Aviation Administration are given in. The appropriate addresses for Coast Guard and Air Force offices are:

#### **Air Force**

*Postal Address:*

Inland SAR Coordinator

Commander ARRS

USAF RCC

Tyndall AFB, FL

*Telegraphic Address:* None.

*Telex:* None.

*Telephone:* 1-800-851-3051,

Commercial: 850-283-5955, or

Defense Switching Network: 523-5955.

#### **Coast Guard**

*Postal Address:*

United States Coast Guard

Search and Rescue Division (GOSR/73)

400 7th Street, S.W.

Washington, D.C. 20590

*Telegraphic Address:* None.

*Telex:* 89 2427

### 2. Types of Service

**2.1** Details of the Rescue Coordination Centers (RCCs) and related rescue units are given in this section. In addition, various elements of state and local police organizations are available for search and rescue missions when required. The aeronautical, maritime and public telecommunication services are available to the search and rescue organizations.

**2.2** Aircraft, both land and amphibious based, are used, as well as land and seagoing vessels, when required, and carry survival equipment. Airborne survival equipment, capable of being dropped, consists of inflatable rubber dinghies equipped with medical supplies, emergency rations and survival radio equipment. Aircraft and marine craft are equipped to communicate on 121.5, 123.1, 243.0, 500 kHz, 2182 kHz, and 8364 kHz. Ground rescue teams are equipped to communicate on 121.5 MHz, 500 kHz, and 8364 kHz. SAR aircraft and marine craft are equipped with direction finding equipment and radar.

### 3. SAR Agreements

**3.1** Bilateral agreements exist between the U.S. and the following neighboring States of the NAM region: Canada and Mexico.

**3.1.1** There are two agreements with Canada. One provides for public aircraft of either country which are engaged in air search and rescue operations to enter or leave either country without being subjected to immigration or customs formalities normally required. The other permits vessels and wrecking appliances of either country to render aid and assistance on specified border waters and on the shores and in the waters of the other country along the Atlantic and Pacific Coasts within a distance of 30 miles from the international boundary on those coasts. A post operations report is required.

**3.1.2** The agreement with Mexico applies to territorial waters and shores of each country within 200 miles of the border on the Gulf Coast and within 270 miles of the border on the Pacific Coast. It permits the vessels and aircraft of either country to proceed to the assistance of a distressed vessel or aircraft of their own registry upon notification of entry and of departure of the applicable waters and shores.

**3.2** In situations not falling under the above agreements, requests from States to participate in a SAR operation within the U.S. for aircraft of their own registry may be addressed to the nearest RCC. The RCC would reply, and issue appropriate instructions.

#### 4. General Conditions of Availability

4.1 The SAR service and facilities in the U.S. are available to the neighboring States within the NAM, NAT, CAR, PAC Regions upon request to the appropriate RCC at all times when they are not engaged in search and rescue activity in their home territory. All facilities are specialized in SAR techniques and functions.

#### 5. Applicable ICAO Documents

Annex 12 . . . . .	Search and Rescue
Annex 13 . . . . .	Aircraft Accident Inquiry
Doc 7030 . . . . .	Regional Supplementary Procedures for Alerting and Search and Rescue Services applicable to the NAM, NAT, CAR, PAC Regions.

#### 6. Differences from ICAO Standards, Recommended Practices and Procedures

6.1 Differences from ICAO Standards, Recommended Practices and Procedures are listed in GEN 1.7.

#### 7. Emergency Locator Transmitters

##### 7.1 General

7.1.1 ELTs are required for most General Aviation airplanes.

*REFERENCE-*  
*14 CFR SECTION 91.207.*

7.1.2 ELTs of various types were developed as a means of locating downed aircraft. These electronic, battery operated transmitters operate on one of three frequencies. These operating frequencies are 121.5 MHz, 243.0 MHz, and the newer 406 MHz. ELTs operating on 121.5 MHz and 243.0 MHz are analog devices. The newer 406 MHz ELT is a digital transmitter that can be encoded with the owner's contact information or aircraft data. The latest 406 MHz ELT models can also be encoded with the aircraft's position data which can help SAR forces locate the aircraft much more quickly after a crash. The 406 MHz ELTs also transmits a stronger signal when activated than the older 121.5 MHz ELTs.

7.1.2.1 The Federal Communications Commission (FCC) requires 406 MHz ELTs be registered with the National Oceanic and Atmospheric Administration (NOAA) as outlined in the ELTs documentation. The FAA's 406 MHz ELT Technical Standard Order (TSO) TSO-C126 also requires that each 406 MHz ELT be registered with NOAA. The reason is NOAA maintains the owner registration database for U.S. registered 406 MHz alerting devices, which includes ELTs. NOAA also operates the United States' portion of the Cospas-Sarsat satellite distress alerting system designed to detect activated 406 MHz ELTs and other distress alerting devices.

7.1.2.2 As of 2009, the Cospas-Sarsat system terminated monitoring and reception of the 121.5 MHz and 243.0 MHz frequencies. What this means for pilots is that those aircraft with only 121.5 MHz or 243.0 MHz ELTs onboard will have to depend upon either a nearby air traffic control facility receiving the alert signal or an overflying aircraft monitoring 121.5 MHz or 243.0 MHz detecting the alert and advising ATC.

7.1.2.3 In the event that a properly registered 406 MHz ELT activates, the Cospas-Sarsat satellite system can decode the owner's information and provide that data to the appropriate search and rescue (SAR) center. In the United States, NOAA provides the alert data to the appropriate U.S. Air Force Rescue Coordination Center (RCC) or U.S. Coast Guard Rescue Coordination Center. That RCC can then telephone or contact the owner to verify the status of the aircraft. If the aircraft is safely secured in a hangar, a costly ground or airborne search is avoided. In the case of an inadvertent 406 MHz ELT activation, the owner can deactivate the 406 MHz ELT. If the 406 MHz ELT equipped aircraft is being flown, the RCC can quickly activate a search. 406 MHz ELTs permit the Cospas-Sarsat satellite system to narrow the search area to a more confined area compared to that of a 121.5 MHz or 243.0 MHz ELT. 406 MHz ELTs also include a low-power 121.5 MHz homing transmitter to aid searchers in finding the aircraft in the terminal search phase.

**7.1.2.4** Each analog ELT emits a distinctive downward swept audio tone on 121.5 MHz and 243.0 MHz.

**7.1.2.5** If “armed” and when subject to crash-generated forces, ELTs are designed to automatically activate and continuously emit their respective signals, analog or digital. The transmitters will operate continuously for at least 48 hours over a wide temperature range. A properly installed, maintained, and functioning ELT can expedite search and rescue operations and save lives if it survives the crash and is activated.

**7.1.2.6** Pilots and their passengers should know how to activate the aircraft’s ELT if manual activation is required. They should also be able to verify the aircraft’s ELT is functioning and transmitting an alert after a crash or manual activation.

**7.1.2.7** Because of the large number of 121.5 MHz ELT false alerts and the lack of a quick means of verifying the actual status of an activated 121.5 MHz or 243.0 MHz analog ELT through an owner registration database, U.S. SAR forces do not respond as quickly to initial 121.5/243.0 MHz ELT alerts as the SAR forces do to 406 MHz ELT alerts. Compared to the almost instantaneous detection of a 406 MHz ELT, SAR forces’ normal practice is to wait for confirmation of an overdue aircraft or similar notification. In some cases, this confirmation process can take hours. SAR forces can initiate a response to 406 MHz alerts in minutes compared to the potential delay of hours for a 121.5/243.0 MHz ELT. Therefore, due to the obvious advantages of 406 MHz beacons and the significant disadvantages to the older 121.5/243.0 MHz beacons, and considering that the International Cospas-Sarsat Program stopped the monitoring of 121.5/243.0 MHz by satellites on February 1, 2009, all aircraft owners/operators are highly encouraged by both NOAA and the FAA to consider making the switch to a digital 406 MHz ELT beacon. Further, for non-aircraft owner pilots, check the ELT installed in the aircraft you are flying, and as appropriate, obtain a personal locator beacon transmitting on 406 MHz.

## **7.2 ELT Testing**

**7.2.1** ELTs should be tested in accordance with the manufacturer’s instructions, preferably in a shielded or screened room or specially designed test container to prevent the broadcast of signals which could trigger a false alert.

**7.2.2** When this cannot be done, aircraft operational testing is authorized as follows:

**7.2.2.1** Analog 121.5/243 MHz ELTs should only be tested during the first 5 minutes after any hour. If operational tests must be made outside of this period, they should be coordinated with the nearest FAA Control Tower. Tests should be no longer than three audible sweeps. If the antenna is removable, a dummy load should be substituted during test procedures.

**7.2.2.2** Digital 406 MHz ELTs should only be tested in accordance with the unit’s manufacturer’s instructions.

**7.2.2.3** Airborne tests are not authorized.

## **7.3 False Alarms**

**7.3.1** Caution should be exercised to prevent the inadvertent activation of ELTs in the air or while they are being handled on the ground. Accidental or unauthorized activation will generate an emergency signal that cannot be distinguished from the real thing, leading to expensive and frustrating searches. A false ELT signal could also interfere with genuine emergency transmissions and hinder or prevent the timely location of crash sites. Frequent false alarms could also result in complacency and decrease the vigorous reaction that must be attached to all ELT signals.

**7.3.2** Numerous cases of inadvertent activation have occurred as a result of aerobatics, hard landings, movement by ground crews and aircraft maintenance. These false alarms can be minimized by monitoring 121.5 MHz and/or 243.0 MHz as follows:

**7.3.2.1** In flight when a receiver is available.

**7.3.2.2** Before engine shut down at the end of each flight.

**7.3.2.3** When the ELT is handled during installation or maintenance.

**7.3.2.4** When maintenance is being performed near the ELT.

**7.3.2.5** When a ground crew moves the aircraft.

**7.3.2.6** If an ELT signal is heard, turn off the aircraft’s ELT to determine if it is transmitting. If it has been activated, maintenance might be required before the unit is returned to the “ARMED” position. You should contact the nearest Air Traffic facility and notify it of the inadvertent activation.

#### **7.4 Inflight Monitoring and Reporting**

**7.4.1** Pilots are encouraged to monitor 121.5 MHz and/or 243.0 MHz while in flight to assist in identifying possible emergency ELT transmissions. On receiving a signal, report the following information to the nearest air traffic facility:

**7.4.1.1** Your position at the time the signal was first heard.

**7.4.1.2** Your position at the time the signal was last heard.

**7.4.1.3** Your position at maximum signal strength.

**7.4.1.4** Your flight altitudes and frequency on which the emergency signal was heard: 121.5 MHz or 243.0 MHz. If possible, positions should be given relative to a navigation aid. If the aircraft has homing equipment, provide the bearing to the emergency signal with each reported position.

### **8. National Search and Rescue Plan**

**8.1** By federal interagency agreement, the National Search and Rescue Plan provides for the effective use of all available facilities in all types of SAR missions. These facilities include aircraft, vessels, pararescue and ground rescue teams, and emergency radio fixing. Under the Plan, the U.S. Coast Guard is responsible for the coordination of SAR in the Maritime Region, and the U.S. Air Force is responsible in the Inland Region. To carry out these responsibilities, the Coast Guard and the Air Force have established RCCs to direct SAR activities within their regions. For aircraft emergencies, distress and urgency information normally will be passed to the appropriate RCC through an air route traffic control center (ARTCC) or flight service station (FSS).

#### **8.2 Coast Guard Rescue Coordination Centers**

*TBL GEN 3.6-1*

<b>Coast Guard Rescue Coordination Centers</b>	
Alameda, CA 510-437-3701	Miami, FL 305-415-6800
Boston, MA 617-223-8555	New Orleans, LA 504-589-6225
Cleveland, OH 216-902-6117	Portsmouth, VA 757-398-6390
Honolulu, HI 808-541-2500	Seattle, WA 206-220-7001
Juneau, AK 907-463-2000	San Juan, PR 787-289-2042

**8.3** Coast Guard Rescue Coordination Centers are served by major radio stations which guard 2182 kHz (VOICE). In addition, Coast Guard units along the seacoasts of the U.S. and shores of the Great Lakes guard 2182 kHz. The call “COAST GUARD” will alert all Coast Guard Radio Stations within range. 2182 kHz is also guarded by most commercial coast stations and some ships and boats.



## 8.4 Air Force Rescue Coordination Centers

TBL GEN 3.6-2

Air Force Rescue Coordination Center	
Tyndall AFB, Florida	Phone
Commercial	850-283-5955
WATS	800-851-3051
DSN	523-5955

TBL GEN 3.6-3

### Air Command Rescue Coordination Center Alaska

Alaskan Air Command Rescue Coordination Center	
Elemendorf AFB, Alaska	Phone
Commercial	907-428-7230 or 800-420-7230 (outside Anchorage)
DSN	317-551-7230

## 8.5 Joint Rescue Coordination Center Hawaii

TBL GEN 3.6-4

Honolulu Joint Rescue Coordination Center	
HQ 14th CG District Honolulu	Phone
Commercial	808-541-2500
DSN	448-0301

## 9. Procedures and Signals for Aircraft in Emergency

### 9.1 Search and Rescue

**9.1.1** Search and Rescue is a life-saving service provided through the combined efforts of the federal agencies signatory to the National SAR Plan, and the agencies responsible for SAR within each State. Operational resources are provided by the U.S. Coast Guard, Department of Defense components, the Civil Air Patrol, the Coast Guard Auxiliary, state, county and local law enforcement and other public safety agencies, and private volunteer organizations. Services include search for missing aircraft, survival aid, rescue, and emergency medical help for the occupants after an accident site is located.

### 9.2 Emergency and Overdue Aircraft

**9.2.1** ARTCCs and FSSs will alert the SAR system when information is received from any source that an aircraft is in difficulty, overdue, or missing.

**9.2.2** Radar facilities providing radar flight following or advisories consider the loss of radar and radios, without service termination notice, to be a possible emergency. Pilots receiving VFR services from radar facilities should be aware that SAR may be initiated under these circumstances.

**9.2.3** A filed flight plan is the most timely and effective indicator that an aircraft is overdue. Flight plan information is invaluable to SAR forces for search planning and executing search efforts. Prior to departure on every flight, local or otherwise, someone at the departure point should be advised of your destination and the route of flight if other than direct. Search efforts are often wasted and rescue is often delayed because of pilots who thoughtlessly take off without telling anyone where they are going. File a flight plan for your safety.

**9.2.4** According to the National Search and Rescue Plan, “The life expectancy of an injured survivor decreases as much as 80 percent during the first 24 hours, while the chances of survival of uninjured survivors rapidly diminishes after the first 3 days.”

**9.2.5** An Air Force Review of 325 SAR missions conducted during a 23–month period revealed that “Time works against people who experience a distress but are not on a flight plan, since 36 hours normally pass before family concern initiates an (alert).”

### **9.3 VFR Search and Rescue Protection**

**9.3.1** To receive this valuable protection, file a VFR or DVFR Flight Plan with an FAA FSS. For maximum protection, file only to the point of first intended landing, and refile for each leg to final destination. When a lengthy flight plan is filed, with several stops en route and an ETE to final destination, a mishap could occur on any leg, and unless other information is received, it is probable that no one would start looking for you until 30 minutes after your ETA at your final destination.

**9.3.2** If you land at a location other than the intended destination, report the landing to the nearest FAA FSS and advise them of your original destination.

**9.3.3** If you land en route and are delayed more than 30 minutes, report this information to the nearest FSS and give them your original destination.

**9.3.4** If your ETE changes by 30 minutes or more, report a new ETA to the nearest FSS and give them your original destination. Remember that if you fail to respond within one–half hour after your ETA at final destination, a search will be started to locate you.

**9.3.5** It is important that you **CLOSE YOUR FLIGHT PLAN IMMEDIATELY AFTER ARRIVAL AT YOUR FINAL DESTINATION WITH THE FSS DESIGNATED WHEN YOUR FLIGHT PLAN WAS FILED**. The pilot is responsible for closure of a VFR or DVFR flight plan; they are not closed automatically. This will prevent needless search efforts.

**9.3.6** The rapidity of rescue on land or water will depend on how accurately your position may be determined. If a flight plan has been followed and your position is on course, rescue will be expedited.

### **9.4 Survival Equipment**

**9.4.1** For flight over uninhabited land areas, it is wise to take suitable survival equipment depending on type of climate and terrain.

**9.4.2** If forced landing occurs at sea, chances for survival are governed by degree of crew proficiency in emergency procedures and by effectiveness of water survival equipment.

### **9.5 Body Signal Illustrations**

**9.5.1** If you are forced down and are able to attract the attention of the pilot of a rescue airplane, the body signals illustrated on the following pages can be used to transmit messages to the pilot circling over your location.

**9.5.2** Stand in the open when you make the signals.

**9.5.3** Be sure the background, as seen from the air, is not confusing.

**9.5.4** Go through the motions slowly and repeat each signal until you are positive that the pilot understands you.

### **9.6 Observance of a Downed Aircraft**

**9.6.1** Determine if the crash is marked with yellow cross; if so, the crash has already been reported and identified.

**9.6.2** Determine, if possible, the type and number of the aircraft and whether there is evidence of survivors.

**9.6.3** Fix, as accurately as possible, the exact location of the crash.

**9.6.4** If circumstances permit, orbit the scene to guide in other assisting units or until relieved by another aircraft.

**9.6.5** Transmit information to the nearest FAA or other appropriate radio facility.

**9.6.6** Immediately after landing, make a complete report to nearest FAA, Air Force, or Coast Guard installation. The report may be made by long distance collect telephone.

*FIG GEN 3.6-1*  
**Ground-Air Visual Code for Use by Survivors**

NO.	MESSAGE	CODE SYMBOL
1	Require assistance	V
2	Require medical assistance	X
3	No or Negative	N
4	Yes or Affirmative	Y
5	Proceeding in this direction	↑

IF IN DOUBT, USE INTERNATIONAL SYMBOL S O S

**INSTRUCTIONS**

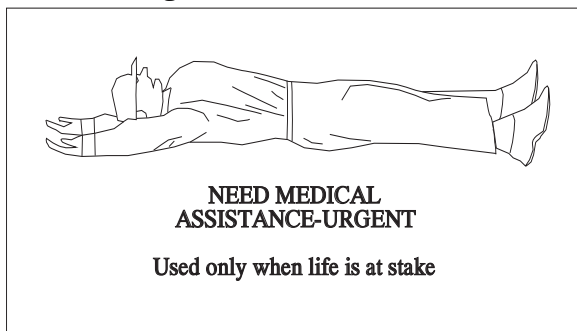
1. Lay out symbols by using strips of fabric or parachutes, pieces of wood, stones, or any available material.
2. Provide as much color contrast as possible between material used for symbols and background against which symbols are exposed.
3. Symbols should be at least 10 feet high or larger. Care should be taken to lay out symbols exactly as shown.
4. In addition to using symbols, every effort is to be made to attract attention by means of radio, flares, smoke, or other available means.
5. On snow covered ground, signals can be made by dragging, shoveling or tramping. Depressed areas forming symbols will appear black from the air.
6. Pilot should acknowledge message by rocking wings from side to side.

*FIG GEN 3.6-2*  
**Ground-Air Visual Code for use by Ground Search Parties**

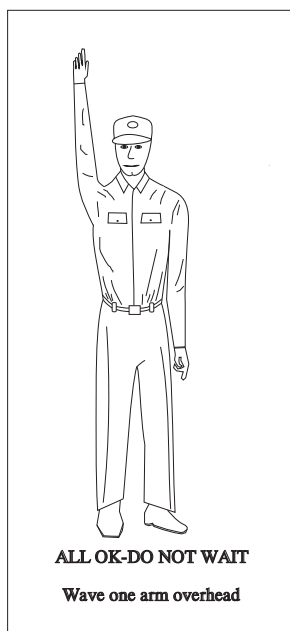
NO.	MESSAGE	CODE SYMBOL
1	Operation completed.	LLL
2	We have found all personnel.	LL
3	We have found only some personnel.	++
4	We are not able to continue. Returning to base.	XX
5	Have divided into two groups. Each proceeding in direction indicated.	↔
6	Information received that aircraft is in this direction.	→ →
7	Nothing found. Will continue search.	NN

Note: These visual signals have been accepted for international use and appear in Annex 12 to the Convention on International Civil Aviation.

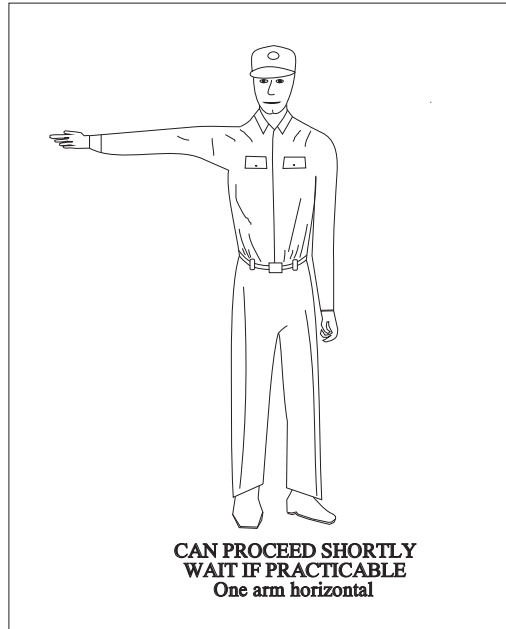
**FIG GEN 3.6-3**  
**Urgent Medical Assistance**



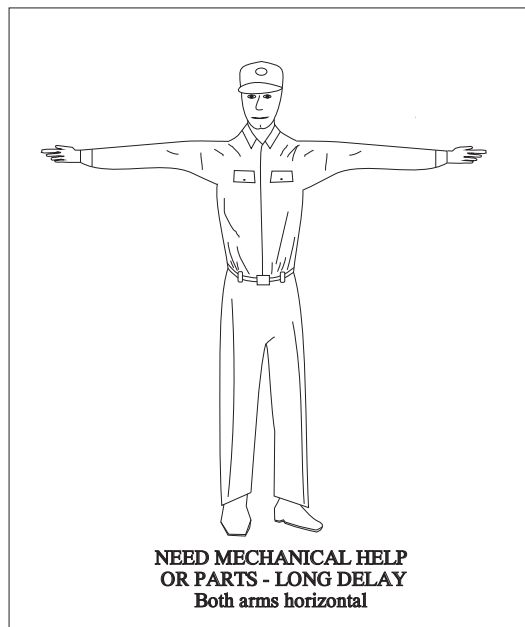
**FIG GEN 3.6-4**  
**All OK**



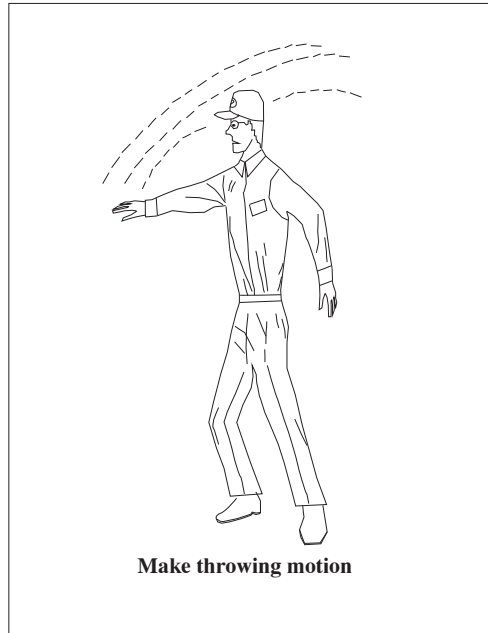
**FIG GEN 3.6-5**  
**Short Delay**



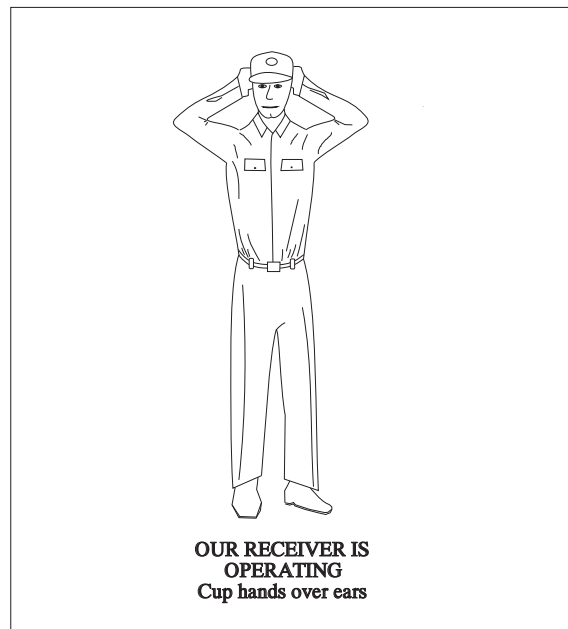
**FIG GEN 3.6-6**  
**Long Delay**



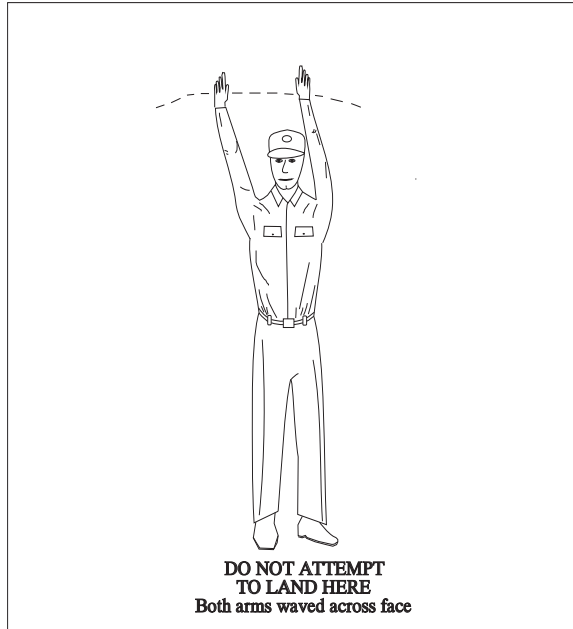
**FIG GEN 3.6-7**  
**Drop Message**



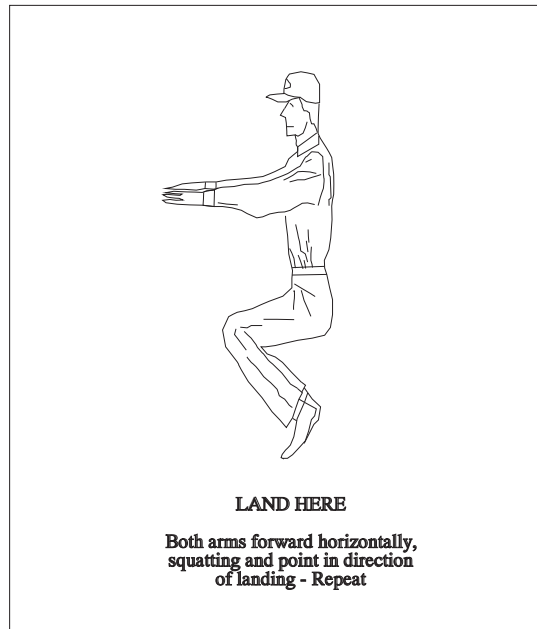
**FIG GEN 3.6-8**  
**Receiver Operates**



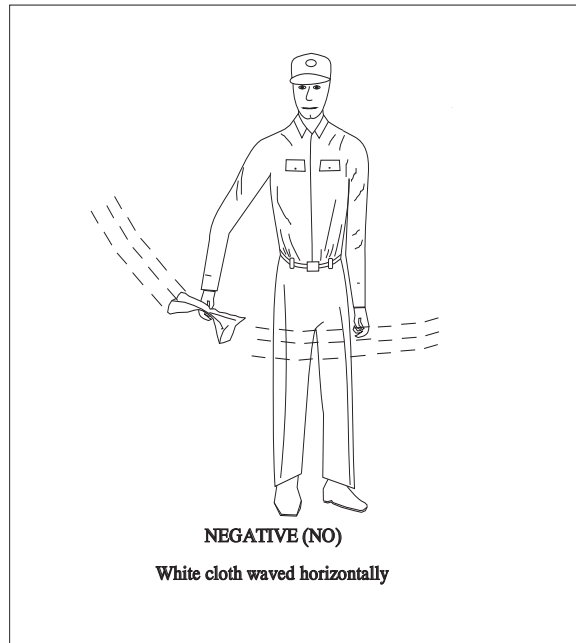
**FIG GEN 3.6-9**  
**Do Not Land Here**



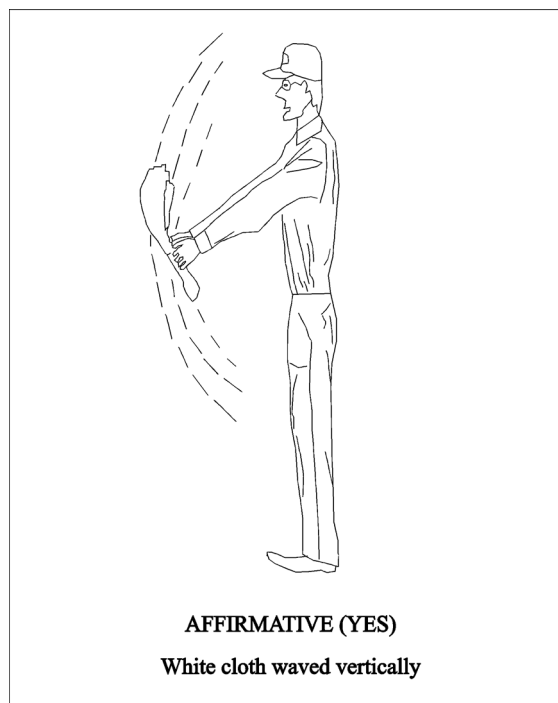
**FIG GEN 3.6-10**  
**Land Here**



**FIG GEN 3.6-11**  
**Negative (Ground)**

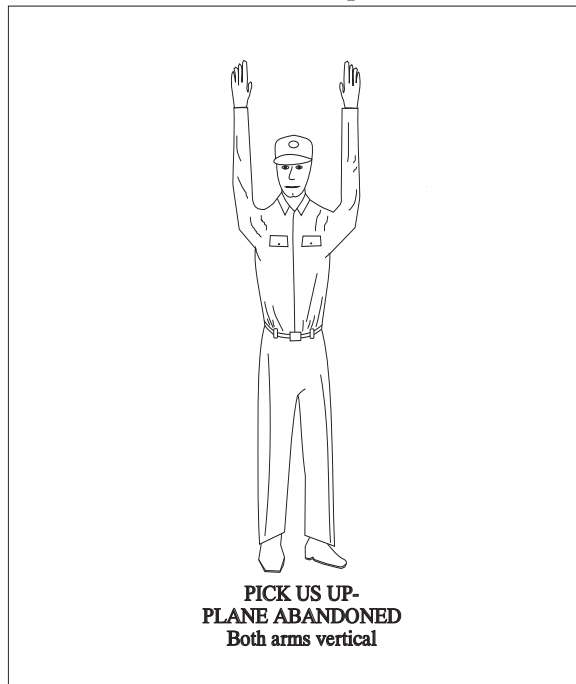


**FIG GEN 3.6-12**  
**Affirmative (Ground)**

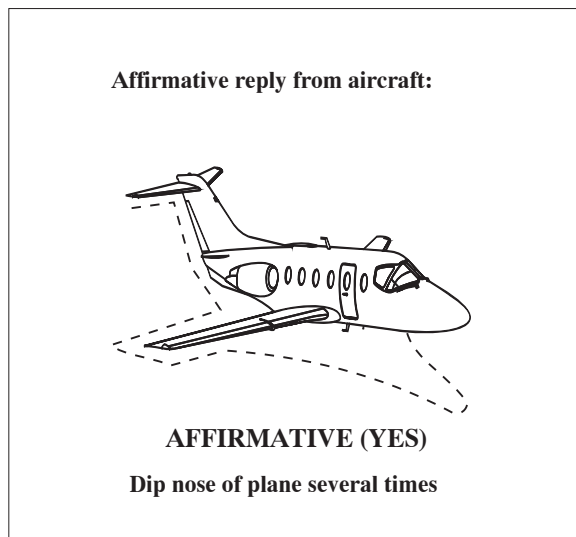




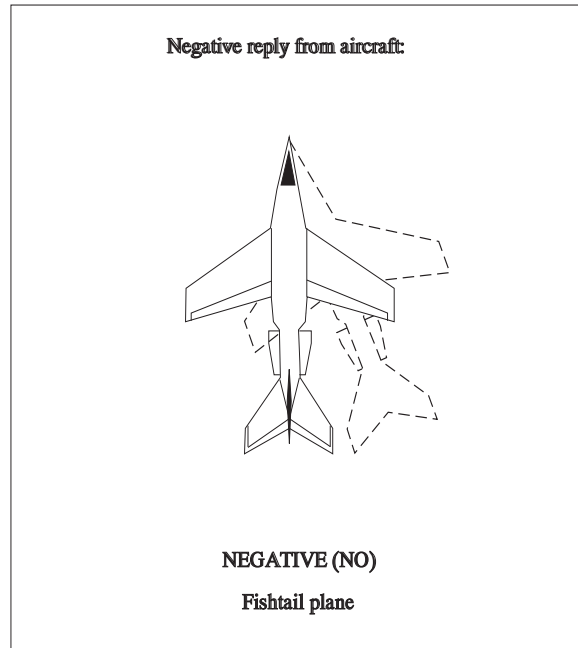
**FIG GEN 3.6-13**  
**Pick Us Up**



**FIG GEN 3.6-14**  
**Affirmative (Aircraft)**



**FIG GEN 3.6-15**  
**Negative (Aircraft)**



**FIG GEN 3.6-16**  
**Message received and understood (Aircraft)**

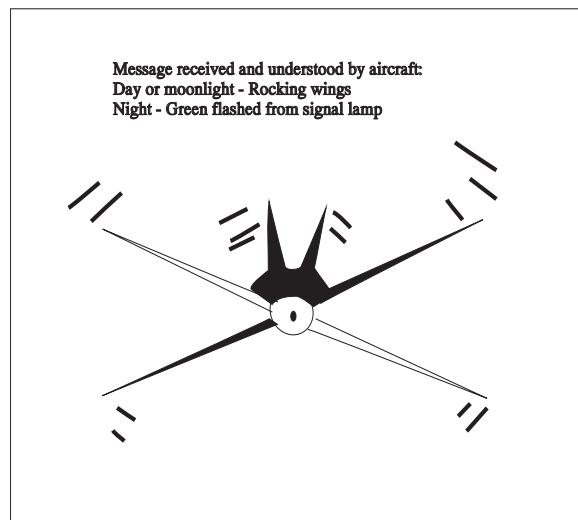
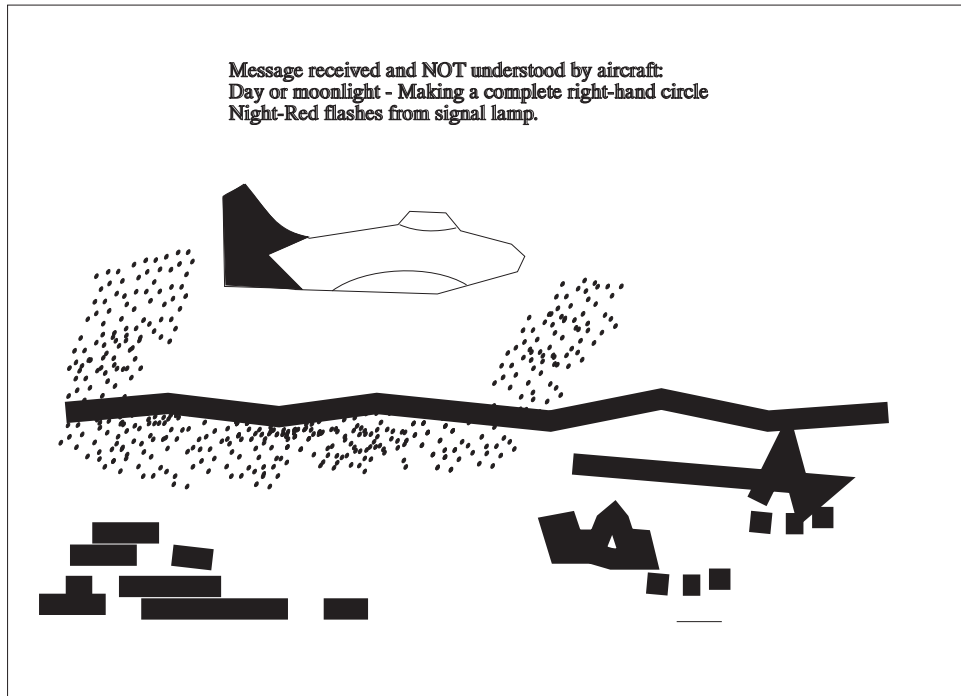


FIG GEN 3.6-17  
Message received and NOT understood (Aircraft)



## 10. Pilot Responsibility and Authority

**10.1** The pilot in command of an aircraft is directly responsible for, and is the final authority as to the operation of that aircraft. In an emergency requiring immediate action, the pilot in command may deviate from any rule in Title 14 of the Code of Federal Regulations (CFR), Part 91, Subpart A, General, and Subpart B, Flight Rules, to the extent required to meet that emergency (14 CFR Section 91.3(b)).

**NOTE-**

*In the event of a pilot incapacitation, an Emergency Autoland system or an emergency descent system may assume operation of the aircraft and deviate to meet that emergency.*

**10.2** If the emergency authority of 14 CFR Section 91.3(b) is used to deviate from the provisions of an air traffic control clearance, the pilot in command must notify ATC as soon as possible and obtain an amended clearance (14 CFR Section 91.123(c)).

**10.3** Unless deviation is necessary under the emergency authority of 14 CFR Section 91.3, pilots of IFR flights experiencing two-way radio communications failure are expected to adhere to the procedures prescribed under "IFR operations; two-way radio communications failure." (14 CFR Section 91.185)

## 11. Distress and Urgency Communications

**11.1** A pilot who encounters a distress or urgency condition can obtain assistance simply by contacting the air traffic facility or other agency in whose area of responsibility the aircraft is operating, stating the nature of the difficulty, pilot's intentions, and assistance desired. Distress and urgency communications procedures prescribed by the International Civil Aviation Organization (ICAO), however, have decided advantages over the informal procedure described above.

**11.2** Distress and urgency communications procedures discussed in the following paragraphs relate to the use of air-ground voice communications.

**11.3** The initial communication, and if considered necessary, any subsequent transmissions by an aircraft in distress should begin with the signal MAYDAY, preferably repeated three times. The signal PAN-PAN should be used in the same manner for an urgency condition.

**11.4** Distress communications have absolute priority over all other communications, and the word MAYDAY commands radio silence on the frequency in use. Urgency communications have priority over all other communications except distress, and the word PAN–PAN warns other stations not to interfere with urgency transmissions.

**11.5** Normally, the station addressed will be the air traffic facility or other agency providing air traffic services on the frequency in use at the time. If the pilot is not communicating and receiving services, the station to be called will normally be the air traffic facility or other agency in whose area of responsibility the aircraft is operating on the appropriate assigned frequency. If the station addressed does not respond, or if time or the situation dictates, the distress or urgency message may be broadcast, or a collect call may be used, addressing “Any Station (Tower) (Radio) (Radar).”

**11.6** The station addressed should immediately acknowledge a distress or urgency message, provide assistance, coordinate and direct the activities of assisting facilities, and alert the appropriate search and rescue coordinator if warranted. Responsibility will be transferred to another station only if better handling will result.

**11.7** All other stations, aircraft and ground, will continue to listen until it is evident that assistance is being provided. If any station becomes aware that the station being called either has not received a distress or urgency message, or cannot communicate with the aircraft in difficulty, it will attempt to contact the aircraft and provide assistance.

**11.8** Although the frequency in use or other frequencies assigned by ATC are preferable, the following emergency frequencies can be used for distress or urgency communications, if necessary or desirable:

**11.8.1** 121.5 MHz and 243.0 MHz – Both have a range generally limited to line of sight. 121.5 MHz is guarded by direction finding stations and some military and civil aircraft. 243.0 MHz is guarded by military aircraft. Both 121.5 MHz and 243.0 MHz are guarded by military towers, most civil towers, and radar facilities. Normally ARTCC emergency frequency capability does not extend to radar coverage limits. If an ARTCC does not respond when called on 121.5 MHz or 243.0 MHz, call the nearest tower.

## **12. Emergency Condition – Request Assistance Immediately**

**12.1** Pilots do not hesitate to declare an emergency when they are faced with distress conditions such as fire, mechanical failure, or structural damage. However, some are reluctant to report an urgency condition when they encounter situations which may not be immediately perilous, but are potentially catastrophic. An aircraft is in at least an urgency condition the moment the pilot becomes doubtful about position, fuel endurance, weather, or any other condition that could adversely affect flight safety. This is the time to ask for help, not after the situation has developed into a distress condition.

**12.2** Pilots who become apprehensive for their safety for any reason should request assistance immediately. Ready and willing help is available in the form of radio, radar, direction finding stations and other aircraft. Delay has caused accidents and cost lives. Safety is not a luxury. Take action.

## **13. Obtaining Emergency Assistance**

**13.1** A pilot in any distress or urgency condition should immediately take the following action, not necessarily in the order listed, to obtain assistance:

**13.1.1** Climb, if possible, for improved communications and better radar and direction finding detection. However, it must be understood that unauthorized climb or descent under IFR conditions within CONTROLLED AIRSPACE is prohibited, except as permitted by 14 CFR Section 91.3(b).

**13.1.2** If equipped with a radar beacon transponder (civil) or IFF/SIF (military):

**13.1.2.1** Continue squawking assigned Mode A/3 discrete code/VFR code and Mode C altitude encoding when in radio contact with an air traffic facility or other agency providing air traffic services, unless instructed to do otherwise.

**13.1.2.2** If unable to immediately establish communications with an air traffic facility/agency, squawk Mode A/3, Code 7700/Emergency and Mode C.

**13.1.2.3** Transmit a distress or urgency message consisting of as many as necessary of the following elements, preferably in the order listed:

- a) If distress, MAYDAY, MAYDAY, MAYDAY; if urgency, PAN–PAN, PAN–PAN, PAN–PAN.
- b) Name of station addressed.
- c) Aircraft identification and type.
- d) Nature of distress or urgency.
- e) Weather.
- f) Pilots intentions and request.
- g) Present position, and heading; or if lost, last known position, time, and heading since that position.
- h) Altitude or flight level.
- i) Fuel remaining in minutes.
- j) Number of people on board.
- k) Any other useful information.

**13.1.3** After establishing radio contact, comply with advice and instructions received. Cooperate. Do not hesitate to ask questions or clarify instructions when you do not understand or if you cannot comply with clearances. Assist the ground station to control communications on the frequency in use. Silence interfering radio stations. Do not change frequency or change to another ground station unless absolutely necessary. If you do, advise the ground station of the new frequency and station name prior to the change, transmitting in the blind if necessary. If two–way communications cannot be established on the frequency, return immediately to the frequency or station where two–way communications last existed.

**13.1.4** When in a distress condition with bailout, crash landing, or ditching imminent, take the following additional actions to assist search and rescue units:

**13.1.4.1** Time and circumstances permitting, transmit as many as necessary of the message elements in subparagraph 13.1.2.3 and any of the following you think might be helpful:

- a) ELT status.
- b) Visible landmarks.
- c) Aircraft color.
- d) Number of persons on board.
- e) Emergency equipment on board.

**13.1.4.2** Actuate your ELT if the installation permits.

**13.1.4.3** For bailout, and for crash landing or ditching if risk of fire is not a consideration, set your radio for continuous transmission.

**13.1.4.4** If it becomes necessary to ditch, make every effort to ditch near a surface vessel. If time permits, an FAA facility should be able to get the position of the nearest commercial or Coast Guard vessel from a Coast Guard Rescue Coordination Center.

**13.2** After a crash landing unless you have good reason to believe that you will not be located by search aircraft or ground teams, it is best to remain with your aircraft and prepare means for signalling search aircraft.

## **14. Radar Service for VFR Aircraft in Difficulty**

**14.1** Radar equipped air traffic control facilities can provide radar assistance and navigation service (vectors) to VFR aircraft in difficulty when the pilot can talk with the controller, and the aircraft is within radar coverage.

Pilots should clearly understand that authorization to proceed in accordance with such radar navigational assistance does not constitute authorization for the pilot to violate Federal Aviation Regulations. In effect, assistance is provided on the basis that navigational guidance information is advisory in nature, and the responsibility for flying the aircraft safely remains with the pilot.

**14.2** Experience has shown that many pilots who are not qualified for instrument flight cannot maintain control of their aircraft when they encounter clouds or other reduced visibility conditions. In many cases, the controller will not know whether flight into instrument conditions will result from his/her instructions. To avoid possible hazards resulting from being vectored into IFR conditions, a pilot in difficulty should keep the controller advised of the weather conditions in which he/she is operating and the weather along the course ahead, and observe the following:

**14.2.1** If a course of action is available which will permit flight and a safe landing in VFR weather conditions, noninstrument rated pilots should choose the VFR condition rather than requesting a vector or approach that will take them into IFR weather conditions; or

**14.2.2** If continued flight in VFR conditions is not possible, the noninstrument rated pilot should so advise the controller and indicating the lack of an instrument rating, declare a distress condition.

**14.2.3** If the pilot is instrument rated and current, and the aircraft is instrument equipped, the pilot should so indicate by requesting an IFR flight clearance. Assistance will then be provided on the basis that the aircraft can operate safely in IFR weather conditions.

## **15. Intercept and Escort**

**15.1** The concept of airborne intercept and escort is based on the SAR aircraft establishing visual and/or electronic contact with an aircraft in difficulty, providing inflight assistance, and escorting it to a safe landing. If bailout, crash landing or ditching becomes necessary, SAR operations can be conducted without delay. For most incidents, particularly those occurring at night and/or during instrument flight conditions, the availability of intercept and escort services will depend on the proximity of SAR units with suitable aircraft on alert for immediate dispatch. In limited circumstances, other aircraft flying in the vicinity of an aircraft in difficulty can provide these services.

**15.2** If specifically requested by a pilot in difficulty or if a distress condition is declared, SAR coordinators will take steps to intercept and escort an aircraft. Steps may be initiated for intercept and escort if an urgency condition is declared and unusual circumstances make such action advisable.

**15.3** It is the pilot's prerogative to refuse intercept and escort services. Escort services will normally be provided to the nearest adequate airport. Should the pilot receiving escort services continue on to another location after reaching a safe airport, or decide not to divert to the nearest safe airport, the escort aircraft is not obligated to continue and further escort is discretionary. The decision will depend on the circumstances of the individual incident.

## **16. Visual Emergency Signals**

### **NOTE–**

See FIG GEN 3.6–1 through FIG GEN 3.6–17.

## **17. Ditching Procedures**

**17.1** In order to select a proper ditching course for an aircraft, a basic knowledge of sea evaluation and other factors involved is required. Selection of the ditching heading may well determine the difference between survival and disaster.

(See FIG GEN 3.6–18, FIG GEN 3.6–19, FIG GEN 3.6–20, and FIG GEN 3.6–21).

### **17.2 Common Oceanographic Terminology:**

**17.2.1 Sea.** The condition of the surface that is the result of both waves and swells.

**17.2.2 Wave (or Chop).** The condition of the surface caused by local winds.

**17.2.3 Swell.** The condition of the surface which has been caused by a distant disturbance.

**17.2.4 Swell Face.** The side of the swell toward the observer. The backside is the side away from the observer. These definitions apply regardless of the direction of swell movement.

**17.2.5 Primary Swell.** The swell system having the greatest height from trough to crest.

**17.2.6 Secondary Swells.** Those swell systems of less height than the primary swell.

**17.2.7 Fetch.** The distance the waves have been driven by a wind blowing in a constant direction, without obstruction.

**17.2.8 Swell Period.** The time interval between the passage of two successive crests at the same spot in the water, measured in seconds.

**17.2.9 Swell Velocity.** The velocity with which the swell advances with relation to a fixed reference point, measured in knots. There is little movement of water in the horizontal direction. Swells move primarily in a vertical motion, similar to the motion observed when shaking out a carpet.

**17.2.10 Swell Direction.** The direction from which a swell is moving. This direction is not necessarily the result of the wind present at the scene. The swell encountered may be moving into or across the local wind. Swells, once set in motion, tend to maintain their original direction for as long as they continue in deep water, regardless of changes in wind direction.

**17.2.11 Swell Height.** The height between crest and trough, measured in feet. The vast majority of ocean swells are lower than 12 to 15 feet, and swells over 25 feet are not common at any spot on the oceans. Successive swells may differ considerably in height.

### 17.3 Swells

**17.3.1** It is extremely dangerous to land into the wind without regard to sea conditions. The swell system, or systems, must be taken into consideration.

FIG GEN 3.6-18  
Single Swell (15 knot wind)

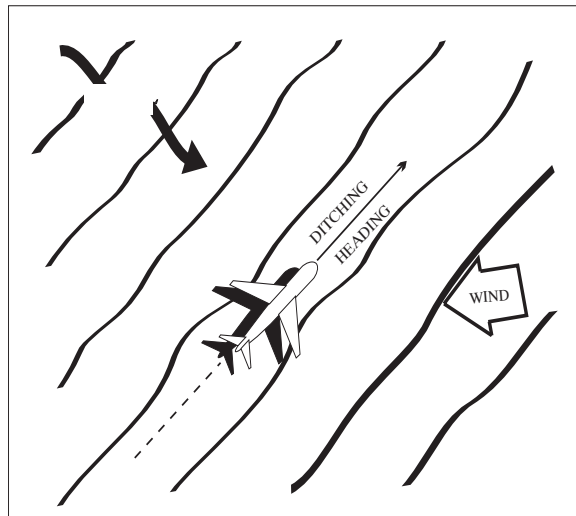


FIG GEN 3.6-19  
Double Swell (15 knot wind)

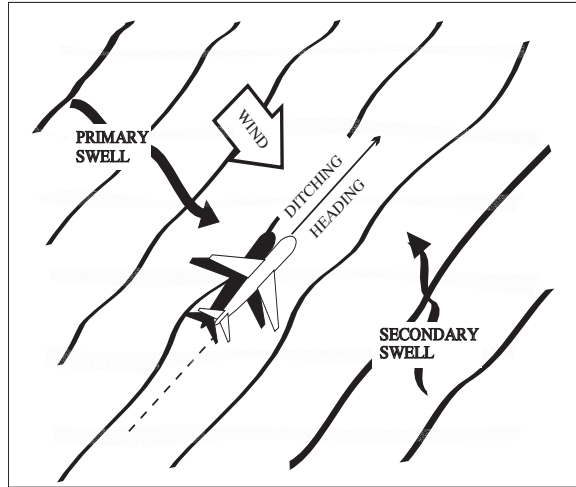


FIG GEN 3.6-20  
Double Swell (30 knot wind)

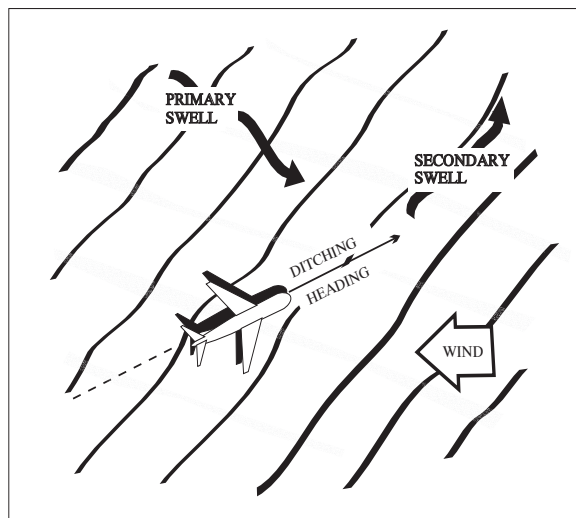




FIG GEN 3.6-21  
(50 knot wind)

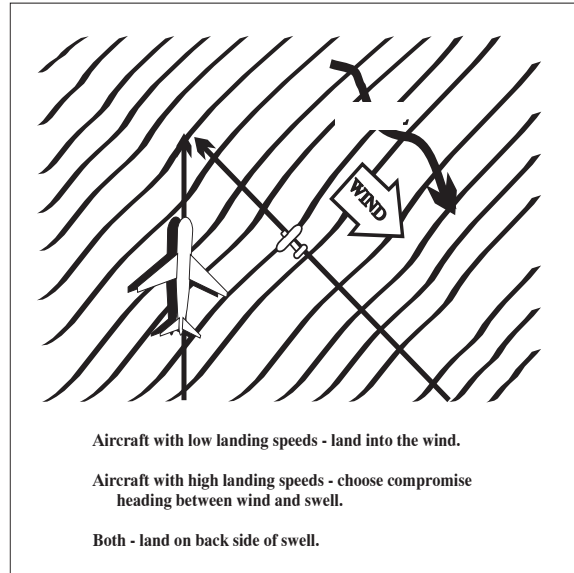
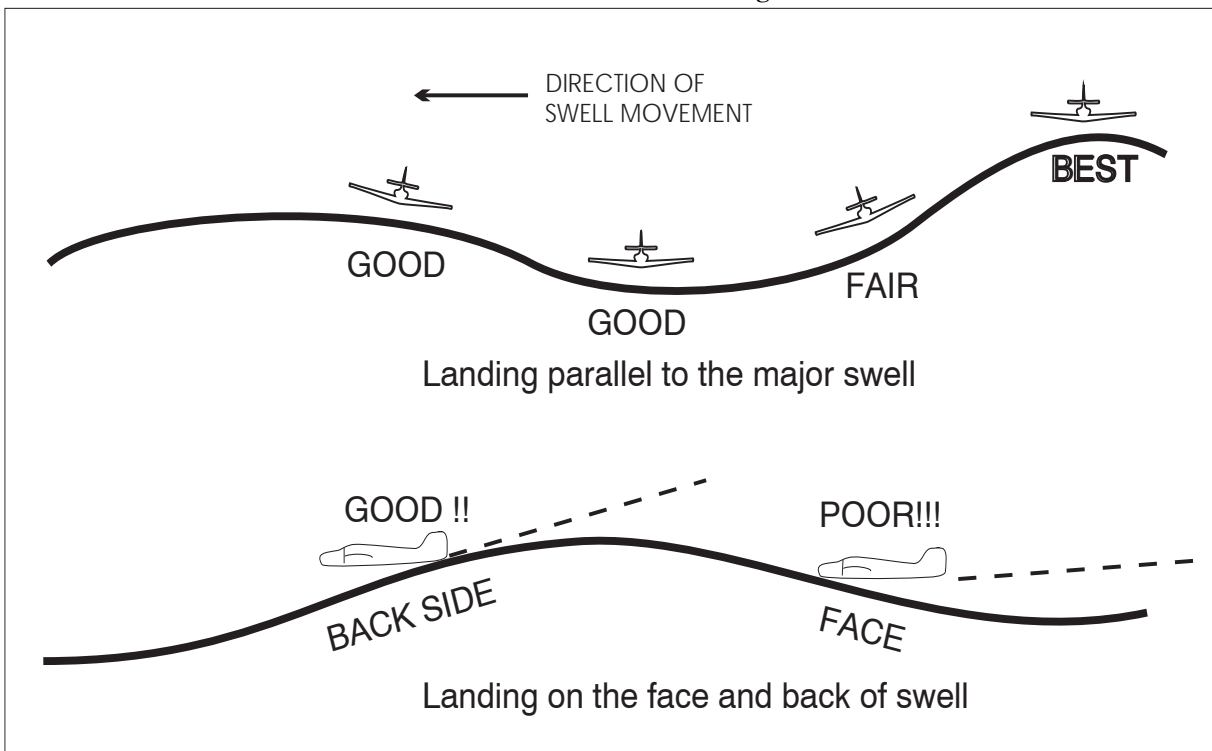


FIG GEN 3.6-22  
Wind-Swell-Ditch Heading



**17.3.2** In ditching parallel to the swell, it makes little difference whether touchdown is on top of the crest or in the trough. It is preferable, if possible, to land on the top or back side of the swell. After determining which heading (and its reciprocal) will parallel the swell, select the heading with the most into the wind component.

**17.3.3** If only one swell system exists, the problem is relatively simple – even with a high, fast system. Unfortunately, most cases involve two or more systems running in different directions. With many systems present, the sea presents a confused appearance. One of the most difficult situations occurs when two swell

systems are at right angles. For example, if one system is 8 feet high, and the other 3 feet, a landing parallel to the primary system, and down swell on the secondary system is indicated. If both systems are of equal height, a compromise may be advisable – selecting an intermediate heading at 45 degrees down swell to both systems. When landing down a secondary swell, attempt to touch down on the back side, not on the face of the swell. Remember one axiom – **AVOID THE FACE OF A SWELL.**

**17.3.4** If the swell system is formidable, it is considered advisable, in landplanes, to accept more crosswind in order to avoid landing directly into the swell.

**17.3.5** The secondary swell system is often from the same direction as the wind. Here, the landing may be made parallel to the primary system, with the wind and secondary system at an angle. There is a choice of two headings paralleling the primary system. One heading is downwind and down the secondary swell; and the other is into the wind and into the secondary swell. The choice of heading will depend on the velocity of the wind versus the velocity and height of the secondary swell.

## **17.4 Wind**

**17.4.1** The simplest method of estimating the wind direction and velocity is to examine the wind streaks on the water. These appear as long streaks up and down wind. Some persons may have difficulty determining wind direction after seeing the streaks in the water. Whitecaps fall forward with the wind but are overrun by the waves thus producing the illusion that the foam is sliding backward. Knowing this, and by observing the direction of the streaks, the wind direction is easily determined. Wind velocity can be accurately estimated by noting the appearance of the whitecaps, foam and wind streaks.

## **17.5 Preditching Preparation**

**17.5.1** A successful aircraft ditching is dependent on three primary factors. In order of importance they are:

**17.5.1.1** Sea conditions and wind.

**17.5.1.2** Type of aircraft.

**17.5.1.3** Skill and technique of pilot.

**17.5.2** The behavior of the aircraft on making contact with the water will vary within wide limits according to the state of the sea. If landed parallel to a single swell system, the behavior of the aircraft may approximate that to be expected on a smooth sea. If landed into a heavy swell or into a confused sea, the deceleration forces may be extremely great – resulting in breaking up of the aircraft. Within certain limits, the pilot is able to minimize these forces by proper sea evaluation and selection of ditching heading.

**17.5.3** When on final approach the pilot should look ahead and observe the surface of the sea. There may be shadows and whitecaps – signs of large seas. Shadows and whitecaps close together indicate that the seas are short and rough. Touchdown in these areas is to be avoided. Select and touchdown in any area (only about 500 feet is needed) where the shadows and whitecaps are not so numerous.

**17.5.4** Touchdown should be at the lowest speed and rate of descent which permit safe handling and optimum nose up attitude on impact. Once first impact has been made there is often little the pilot can do to control a landplane.

## **17.6 Ditching**

**17.6.1** Once preditching preparations are completed, the pilot should turn to the ditching heading and commence letdown. The aircraft should be flown low over the water, and slowed down until ten knots or so above stall. At this point, additional power should be used to overcome the increased drag caused by the noseup attitude. When a smooth stretch of water appears ahead, cut power, and touchdown at the best recommended speed as fully stalled as possible. By cutting power when approaching a relatively smooth area, the pilot will prevent overshooting and will touchdown with less chance of planing off into a second uncontrolled landing. Most experienced seaplane pilots prefer to make contact with the water in a semi-stalled attitude, cutting power as the tail makes contact. This technique eliminates the chance of misjudging altitude with a resultant heavy drop in

a fully stalled condition. Care must be taken not to drop in a fully stalled condition. Care must be taken not to drop the aircraft from too high altitude, or to balloon due to excessive speed. The altitude above water depends on the aircraft. Over glassy smooth water, or at night without sufficient light, it is very easy for even the most experienced pilots to misjudge altitude by 50 feet or more. Under such conditions, carry enough power to maintain 9° to 12° noseup attitude, and 10° to 20° over stalling speed until contact is made with the water. The proper use of power on the approach is of great importance. If power is available on one side only, a little power should be used to flatten the approach; however, the engine should not be used to such an extent that the aircraft cannot be turned against the good engines right down to the stall with a margin of rudder movement available. When near the stall, sudden application of excessive unbalanced power may result in loss of directional control. If power is available on one side only, a slightly higher than normal glide approach speed should be used. This will insure good control and some margin of speed after leveling off without excessive use of power. The use of power in ditching is so important that when it is certain that the coast cannot be reached, the pilot should, if possible, ditch before fuel is exhausted. The use of power in a night or instrument ditching is far more essential than under daylight contact conditions.

**17.6.2** If no power is available, a greater than normal approach speed should be used down to the flare-out. This speed margin will allow the glide to be broken early and more gradually, thereby giving the pilot time and distance to feel for the surface – decreasing the possibility of stalling high or flying into the water. When landing parallel to a swell system, little difference is noted between landing on top of a crest or in the trough. If the wings of the aircraft are trimmed to the surface of the sea rather than the horizon, there is little need to worry about a wing hitting a swell crest. The actual slope of a swell is very gradual. If forced to land into a swell, touchdown should be made just after passage of the crest. If contact is made on the face of the swell, the aircraft may be swamped or thrown violently into the air, dropping heavily into the next swell. If control surfaces remain intact, the pilot should attempt to maintain the proper nose attitude by rapid and positive use of the controls.

## **17.7 After Touchdown**

**17.7.1** In most cases drift caused by crosswind can be ignored; the forces acting on the aircraft after touchdown are of such magnitude that drift will be only a secondary consideration. If the aircraft is under good control, the “crab” may be kicked out with rudder just prior to touchdown. This is more important with high wing aircraft, for they are laterally unstable on the water in a crosswind, and may roll to the side in ditching.

### **NOTE–**

*This information has been extracted from the publication “Aircraft Emergency Procedures Over Water.”*

## **18. Fuel Dumping**

**18.1** Should it become necessary to dump fuel, the pilot should immediately advise ATC. Upon receipt of advice that an aircraft will dump fuel, ATC will broadcast or cause to be broadcast immediately and every 3 minutes thereafter on appropriate ATC, FSS, and airline company radio frequencies the following:

### **EXAMPLE–**

*ATTENTION ALL AIRCRAFT–FUEL DUMPING IN PROGRESS–OVER (location) AT (altitude) BY (type aircraft) (flight direction).*

**18.2** Upon receipt of such a broadcast, pilots of aircraft affected, which are not on IFR flight plans or special VFR clearances, should clear the area specified in the advisory. Aircraft on IFR flight plans or special VFR clearances will be provided specific separation by ATC. At the termination of the fuel dumping operation, pilots should advise ATC. Upon receipt of such information, ATC will issue, on appropriate frequencies, the following:

### **EXAMPLE–**

*ATTENTION ALL AIRCRAFT–FUEL DUMPING BY– (type aircraft) TERMINATED.*

## **19. Special Emergency (Air Piracy)**

**19.1** A special emergency is a condition of air piracy, or other hostile act by a person(s) aboard an aircraft, which threatens the safety of the aircraft or its passengers.

**19.2** The pilot of an aircraft reporting a special emergency condition should:

**19.2.1** If circumstances permit, apply distress or urgency radio – telephony procedures. Include the details of the special emergency.

**19.2.2** If circumstances do not permit the use of prescribed distress or urgency procedures, transmit:

**19.2.2.1** On the air–ground frequency in use at the time.

**19.2.2.2** As many as possible of the following elements spoken distinctly and in the following order.

- a) Name of the station addressed (time and circumstances permitting).
- b) The identification of the aircraft and present position.
- c) The nature of the special emergency condition and pilot intentions (circumstances permitting).
- d) If unable to provide this information, use code words and/or transponder setting for indicated meanings as follows:

**Spoken Words**

TRANSPONDER SEVEN FIVE ZERO ZERO

**Meaning**

Am being hijacked/forced to a new destination

**Transponder Setting**

Mode 3/A, Code 7500

**NOTE–**

*Code 7500 will never be assigned by ATC without prior notification from the pilot that the aircraft is being subjected to unlawful interference. The pilot should refuse the assignment of this code in any other situation and inform the controller accordingly. Code 7500 will trigger the special emergency indicator in all radar ATC facilities.*

**19.3** Air traffic controllers will acknowledge and confirm receipt of transponder Code 7500 by asking the pilot to verify it. If the aircraft is not being subjected to unlawful interference, the pilot should respond to the query by broadcasting in the clear that the aircraft is not being subjected to unlawful interference. Upon receipt of this information, the controller will request the pilot to verify the code selection depicted in the code selector windows in the transponder control panel and change the code to the appropriate setting. If the pilot replies in the affirmative or does not reply, the controller will not ask further questions but will flight follow, respond to pilot requests, and notify appropriate authorities.

**19.4** If it is possible to do so without jeopardizing the safety of the flight, the pilot of a hijacked U.S. passenger aircraft, after departing from the cleared routing over which the aircraft was operating, will attempt to do one or more of the following things insofar as circumstances may permit:

**19.4.1** Maintain a true airspeed of no more than 400 knots and, preferably, an altitude of between 10,000 and 25,000 feet.

**19.4.2** Fly a course toward the destination which the hijacker has announced.

**19.5** If these procedures result in either radio contact or air intercept, the pilot will attempt to comply with any instructions received which may direct the aircraft to an appropriate landing field or alter the aircraft's flight path off its current course, away from protected airspace.

## **20. FAA K–9 Explosives Detection Team Program**

**20.1** The FAA's Office of Civil Aviation Security Operations manages the FAA K–9 Explosives Detection Team Program, which was established in 1972. Through a unique agreement with law enforcement agencies and airport authorities, the FAA has strategically placed FAA–certified K–9 teams (a team is one handler and one dog) at airports throughout the country. If a bomb threat is received while an aircraft is in flight, the aircraft can be directed to an airport with this capability.

**20.2** The FAA provides initial and refresher training for all handlers, provides single purpose explosive detector dogs, and requires that each team is annually evaluated in five areas for FAA certification: aircraft (wide body and narrow body), vehicles, terminal, freight, (cargo), and luggage. If you desire this service, notify your company or an FAA air traffic control facility.

**20.3 FAA Sponsored Explosives Detection Dog/Handler Team Locations**

TBL GEN 3.6–5

<b>Airport Symbol</b>	<b>Location</b>
ATL	Atlanta, Georgia
BHM	Birmingham, Alabama
BOS	Boston, Massachusetts
BUF	Buffalo, New York
CLT	Charlotte, North Carolina
ORD	Chicago, Illinois
CVG	Cincinnati, Ohio
DFW	Dallas, Texas
DEN	Denver, Colorado
DTW	Detroit, Michigan
IAH	Houston, Texas
JAX	Jacksonville, Florida
MCI	Kansas City, Missouri
LAX	Los Angeles, California
MEM	Memphis, Tennessee
MIA	Miami, Florida
MKE	Milwaukee, Wisconsin
MSY	New Orleans, Louisiana
MCO	Orlando, Florida
PHX	Phoenix, Arizona
PIT	Pittsburgh, Pennsylvania
PDX	Portland, Oregon
SLC	Salt Lake City, Utah
SFO	San Francisco, California
SJU	San Juan, Puerto Rico
SEA	Seattle, Washington
STL	St. Louis, Missouri
TUS	Tucson, Arizona
TUL	Tulsa, Oklahoma

**20.4** If due to weather or other considerations an aircraft with a suspected hidden explosive problem were to land or intended to land at an airport other than those listed above, it is recommended they call the FAA’s Washington Operations Center (telephone 202–267–3333, if appropriate) or have an air traffic facility with which you can communicate contact the above center requesting assistance.



## GEN 3.7 Aircraft Rescue and Fire Fighting Communications

### 1. Discrete Emergency Frequency

**1.1** Direct contact between an emergency aircraft flight crew, Aircraft Rescue and Fire Fighting Incident Commander (ARFF IC), and the Airport Traffic Control Tower (ATCT) is possible on an aeronautical radio frequency (Discrete Emergency Frequency [DEF]) designated by Air Traffic Control (ATC) from the operational frequencies assigned to that facility.

**1.2** Emergency aircraft at airports without an ATCT (or when the ATCT is closed) may contact the ARFF IC (if ARFF service is provided) on the Common Traffic Advisory Frequency (CTAF) published for the airport or the civil emergency frequency 121.5 MHz.

### 2. Radio Call Signs

Preferred radio call sign for the ARFF IC is “(location/facility) Command” when communicating with the flight crew and the FAA ATCT.

**EXAMPLE-**

*LAX Command.*

*Washington Command.*

### 3. ARFF Emergency Hand Signals

In the event that electronic communications cannot be maintained between the ARFF IC and the flight crew, standard emergency hand signals as depicted in FIG GEN 3.7-1 through FIG GEN 3.7-3 should be used. These hand signals should be known and understood by all cockpit and cabin aircrew, and all ARFF firefighters.

FIG GEN 3.7-1

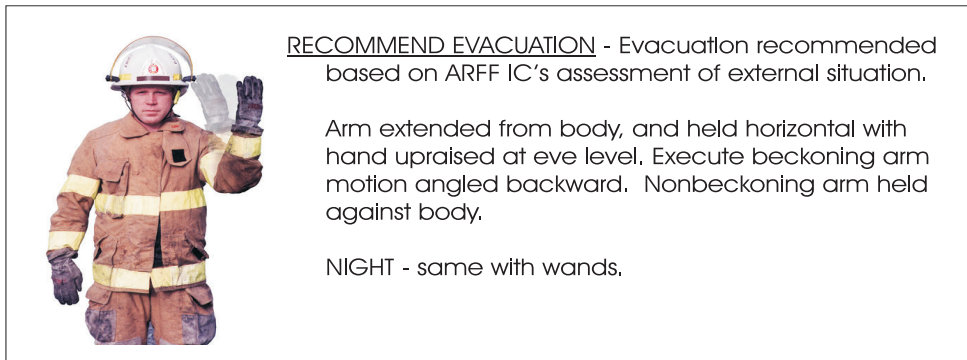


FIG GEN 3.7-2

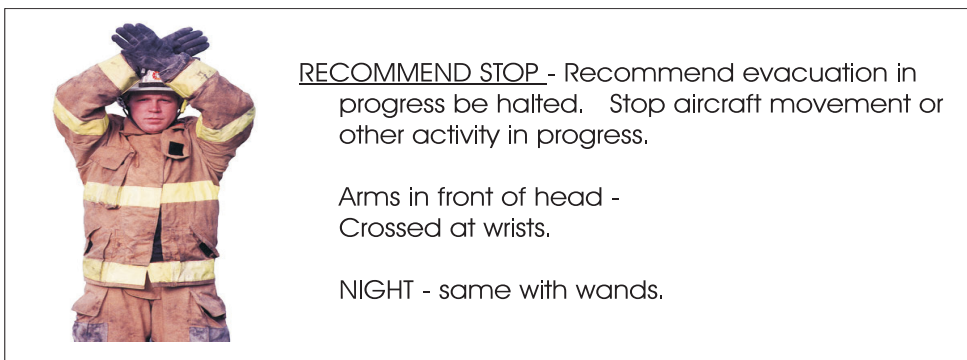
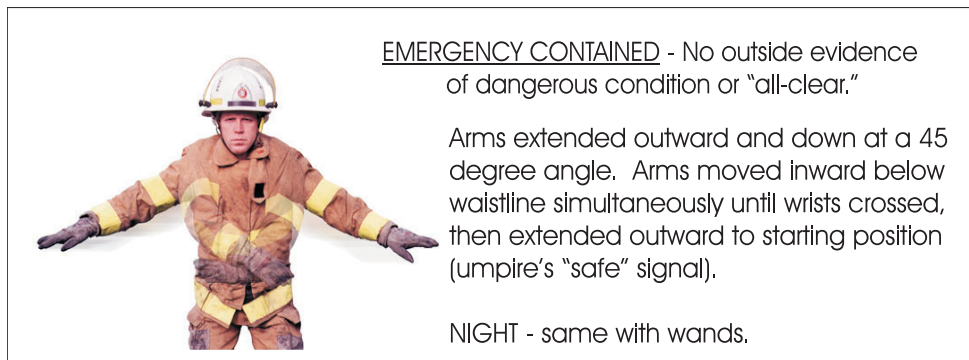


FIG GEN 3.7-3





# GEN 4. CHARGES FOR AERODROMES/HELIPORTS AND AIR NAVIGATION SERVICES

## GEN 4.1 Fees and Charges

### 1. General

**1.1** Charges for services and facilities vary from aerodrome to aerodrome, and information concerning such charges may be obtained at the aerodromes. Unless alternative arrangements have been made, all charges for the use of the aerodrome, such as landing fees, passenger service charges, cargo charges, storage charges, and the like, are payable on demand or before the aircraft departs the aerodrome. All such charges are established by and payable to the various administrative authorities of the various aerodromes.

**1.2** A private aircraft will be charged a processing fee of \$25 once every calendar year. This will be charged the first time the aircraft arrives from a foreign place in the calendar year or may be paid in advance. This fee is charged to the aircraft, not the pilot, and the receipt should be kept with the aircraft.

**1.3** Commercial aircraft operators will be charged a processing fee of \$5 per paying passenger for each arrival from foreign to the U.S. This fee will not be charged for passengers arriving from Canada, Mexico, and certain nearby Caribbean countries.

### 2. Charges for Inspection Services

**2.1** Generally speaking, free service is provided at airports during regular business hours (usually 8 a.m. to 5 p.m.), Monday through Saturday, and from 8 a.m. to 5 p.m. on Sundays and national holidays. However, tours of duty at airports are based on the need for services and are altered at some ports to coincide with schedule changes and peak workloads.

**2.2** Overtime charges may be imposed, in certain cases, for Immigration and Naturalization Services and Public Health Service quarantine inspection of aircraft whose operations are not covered by published schedules. Information concerning such charges may be obtained from the Immigration and Naturalization Office and the Public Health Service Medical Officer in Charge at, or nearest, the intended place of landing.

### 3. Penalties for Violations

**3.1** Since the law provides for substantial penalties for violations of the Customs regulations, aircraft operators and pilots should make every effort to comply with them.

**3.2** A \$5,000 penalty will be assessed for common violations such as:

**3.2.1** Failure to report arrival.

**3.2.2** Failure to obtain landing rights.

**3.2.3** Failure to provide advance notice of arrival.

**3.2.4** Failure to provide penetration report on southern border.

**3.2.5** Departing without permission or discharging passengers or cargo without permission.

**REFERENCE-**  
19 CFR 122.161.

**NOTE-**

**1.** *Importation of contraband, including agricultural materials, or undeclared merchandise can result in penalty action and seizure of aircraft, which varies according to the nature of the violation and pertinent provision of law.*

**2.** *The above penalties are double to \$10,000 for a second offense. Seizure of aircraft may occur at any time depending upon the circumstances behind the violation.*

**3.** *If a penalty is incurred, application may be made to the customs officer in charge for a reduction in amount or cancellation, giving the grounds upon which relief is believed to be justified. If the operator or pilot desires to petition further for relief of the penalty, he/she may appeal to the appropriate district Director of Customs. If still further review of the penalty is desired, written appeal may be made to the proper regional Commissioner of Customs and, in some cases, to Customs Headquarters.*

**3.3** Any person violating any provision of the Public Health Service regulations shall be subject to a fine of not more than \$1,000 or to imprisonment for not more than 1 year, or both, as provided in section 368 of the Public Health Service Act (42 U.S.C. 271).

## **GEN 4.2 Air Navigation Facility Charges**

The Federal Aviation Administration does not charge for the use of Federal air navigation facilities or telecommunications services.



**AIP**  
**AERONAUTICAL INFORMATION PUBLICATION**  
**UNITED STATES OF AMERICA**

**PART 2**  
**EN ROUTE (ENR)**



## PART 2 – EN ROUTE (ENR)

### ENR 0.

ENR 0.1 Preface – Not applicable

ENR 0.2 Record of AIP Amendments – See GEN 0.2-1

ENR 0.3 Record of AIP Supplements – Not applicable

### ENR 0.4 Checklist of Pages

PAGE	DATE
<b>PART 2 – EN ROUTE (ENR)</b>	
<b>ENR 0</b>	
0.4-1	5 OCT 23
0.4-2	5 OCT 23
0.4-3	5 OCT 23
0.4-4	5 OCT 23
0.6-1	20 APR 23
0.6-2	20 APR 23
<b>ENR 1</b>	
1.1-1	19 MAY 22
1.1-2	19 MAY 22
1.1-3	19 MAY 22
1.1-4	19 MAY 22
1.1-5	19 MAY 22
1.1-6	19 MAY 22
1.1-7	19 MAY 22
1.1-8	19 MAY 22
1.1-9	20 APR 23
1.1-10	20 APR 23
1.1-11	20 APR 23
1.1-12	20 APR 23
1.1-13	20 APR 23
1.1-14	20 APR 23
1.1-15	20 APR 23
1.1-16	20 APR 23
1.1-17	20 APR 23
1.1-18	20 APR 23
1.1-19	20 APR 23
1.1-20	20 APR 23
1.1-21	20 APR 23
1.1-22	20 APR 23
1.1-23	20 APR 23
1.1-24	20 APR 23
1.1-25	20 APR 23
1.1-26	20 APR 23
1.1-27	20 APR 23
1.1-28	20 APR 23
1.1-29	20 APR 23
1.1-30	20 APR 23
1.1-31	20 APR 23

PAGE	DATE
1.1-32	20 APR 23
1.1-33	20 APR 23
1.1-34	20 APR 23
1.1-35	20 APR 23
1.1-36	20 APR 23
1.1-37	20 APR 23
1.1-38	20 APR 23
1.1-39	20 APR 23
1.1-40	20 APR 23
1.1-41	20 APR 23
1.1-42	20 APR 23
1.1-43	20 APR 23
1.1-44	20 APR 23
1.1-45	20 APR 23
1.1-46	20 APR 23
1.1-47	20 APR 23
1.1-48	20 APR 23
1.1-49	20 APR 23
1.1-50	20 APR 23
1.1-51	20 APR 23
1.1-52	20 APR 23
1.1-53	20 APR 23
1.1-54	20 APR 23
1.1-55	20 APR 23
1.1-56	20 APR 23
1.1-57	20 APR 23
1.1-58	20 APR 23
1.1-59	20 APR 23
1.1-60	20 APR 23
1.1-61	20 APR 23
1.1-62	20 APR 23
1.1-63	20 APR 23
1.1-64	20 APR 23
1.1-65	20 APR 23
1.1-66	20 APR 23
1.1-67	20 APR 23
1.1-68	20 APR 23
1.1-69	20 APR 23
1.1-70	20 APR 23
1.1-71	20 APR 23

PAGE	DATE
1.1-72	20 APR 23
1.1-73	20 APR 23
1.1-74	20 APR 23
1.1-75	20 APR 23
1.1-76	20 APR 23
1.1-77	20 APR 23
1.1-78	20 APR 23
1.1-79	20 APR 23
1.1-80	20 APR 23
1.1-81	20 APR 23
1.1-82	20 APR 23
1.1-83	20 APR 23
1.1-84	20 APR 23
1.1-85	20 APR 23
1.1-86	20 APR 23
1.1-87	20 APR 23
1.1-88	20 APR 23
1.1-89	20 APR 23
1.1-90	20 APR 23
1.1-91	20 APR 23
1.1-92	20 APR 23
1.1-93	20 APR 23
1.1-94	20 APR 23
1.1-95	20 APR 23
1.1-96	20 APR 23
1.1-97	20 APR 23
1.1-98	20 APR 23
1.1-99	20 APR 23
1.1-100	20 APR 23
1.1-101	20 APR 23
1.2-1	19 MAY 22
1.3-1	19 MAY 22
1.4-1	19 MAY 22
1.4-2	19 MAY 22
1.4-3	19 MAY 22
1.4-4	20 APR 23
1.4-5	20 APR 23
1.4-6	20 APR 23
1.4-7	20 APR 23
1.4-8	20 APR 23

PAGE	DATE	PAGE	DATE	PAGE	DATE
1.4-9	20 APR 23	1.5-42	19 MAY 22	1.6-3	19 MAY 22
1.4-10	20 APR 23	1.5-43	19 MAY 22	1.6-4	19 MAY 22
1.4-11	20 APR 23	1.5-44	19 MAY 22	1.6-5	19 MAY 22
1.4-12	19 MAY 22	1.5-45	19 MAY 22	1.6-6	19 MAY 22
1.4-13	19 MAY 22	1.5-46	19 MAY 22	1.6-7	19 MAY 22
1.4-14	19 MAY 22	1.5-47	19 MAY 22	1.6-8	19 MAY 22
1.4-15	20 APR 23	1.5-48	19 MAY 22	1.6-9	19 MAY 22
1.4-16	20 APR 23	1.5-49	19 MAY 22	1.6-10	19 MAY 22
1.4-17	20 APR 23	1.5-50	3 NOV 22	1.6-11	19 MAY 22
1.4-18	19 MAY 22	1.5-51	19 MAY 22	1.7-1	19 MAY 22
1.4-19	20 APR 23	1.5-52	19 MAY 22	1.7-2	19 MAY 22
1.5-1	19 MAY 22	1.5-53	19 MAY 22	1.7-3	19 MAY 22
1.5-2	19 MAY 22	1.5-54	19 MAY 22	1.8-1	19 MAY 22
1.5-3	19 MAY 22	1.5-55	19 MAY 22	1.8-2	19 MAY 22
1.5-4	19 MAY 22	1.5-56	19 MAY 22	1.8-3	5 OCT 23
1.5-5	19 MAY 22	1.5-57	19 MAY 22	1.8-4	5 OCT 23
1.5-6	19 MAY 22	1.5-58	19 MAY 22	1.8-5	5 OCT 23
1.5-7	19 MAY 22	1.5-59	19 MAY 22	1.8-6	5 OCT 23
1.5-8	19 MAY 22	1.5-60	19 MAY 22	1.8-7	5 OCT 23
1.5-9	19 MAY 22	1.5-61	19 MAY 22	1.8-8	3 NOV 22
1.5-10	19 MAY 22	1.5-62	19 MAY 22	1.9-1	19 MAY 22
1.5-11	19 MAY 22	1.5-63	19 MAY 22	1.10-1	19 MAY 22
1.5-12	19 MAY 22	1.5-64	19 MAY 22	1.10-2	19 MAY 22
1.5-13	19 MAY 22	1.5-65	19 MAY 22	1.10-3	19 MAY 22
1.5-14	19 MAY 22	1.5-66	19 MAY 22	1.10-4	19 MAY 22
1.5-15	19 MAY 22	1.5-67	19 MAY 22	1.10-5	19 MAY 22
1.5-16	19 MAY 22	1.5-68	19 MAY 22	1.10-6	19 MAY 22
1.5-17	19 MAY 22	1.5-69	19 MAY 22	1.10-7	19 MAY 22
1.5-18	19 MAY 22	1.5-70	19 MAY 22	1.10-8	19 MAY 22
1.5-19	3 NOV 22	1.5-71	19 MAY 22	1.10-9	19 MAY 22
1.5-20	19 MAY 22	1.5-72	3 NOV 22	1.10-10	19 MAY 22
1.5-21	19 MAY 22	1.5-73	3 NOV 22	1.10-11	19 MAY 22
1.5-22	19 MAY 22	1.5-74	3 NOV 22	1.10-12	19 MAY 22
1.5-23	19 MAY 22	1.5-75	19 MAY 22	1.10-13	19 MAY 22
1.5-24	19 MAY 22	1.5-76	19 MAY 22	1.10-14	19 MAY 22
1.5-25	19 MAY 22	1.5-77	19 MAY 22	1.10-15	19 MAY 22
1.5-26	19 MAY 22	1.5-78	19 MAY 22	1.10-16	19 MAY 22
1.5-27	19 MAY 22	1.5-79	19 MAY 22	1.10-17	19 MAY 22
1.5-28	19 MAY 22	1.5-80	19 MAY 22	1.10-18	19 MAY 22
1.5-29	19 MAY 22	1.5-81	19 MAY 22	1.10-19	19 MAY 22
1.5-30	3 NOV 22	1.5-82	19 MAY 22	1.11-1	19 MAY 22
1.5-31	19 MAY 22	1.5-83	19 MAY 22	1.11-2	19 MAY 22
1.5-32	19 MAY 22	1.5-84	19 MAY 22	1.12-1	19 MAY 22
1.5-33	19 MAY 22	1.5-85	19 MAY 22	1.12-2	20 APR 23
1.5-34	19 MAY 22	1.5-86	19 MAY 22	1.12-3	20 APR 23
1.5-35	19 MAY 22	1.5-87	19 MAY 22	1.12-4	20 APR 23
1.5-36	3 NOV 22	1.5-88	19 MAY 22	1.12-5	20 APR 23
1.5-37	3 NOV 22	1.5-89	19 MAY 22	1.12-6	20 APR 23
1.5-38	19 MAY 22	1.5-90	19 MAY 22	1.12-7	20 APR 23
1.5-39	19 MAY 22	1.5-91	19 MAY 22	1.12-8	20 APR 23
1.5-40	19 MAY 22	1.6-1	19 MAY 22	1.12-9	20 APR 23
1.5-41	19 MAY 22	1.6-2	19 MAY 22		



PAGE	DATE
1.12-10	20 APR 23
1.12-11	20 APR 23
1.12-12	20 APR 23
1.12-13	20 APR 23
1.12-14	20 APR 23
1.12-15	19 MAY 22
1.13-1	19 MAY 22
1.14-1	19 MAY 22
1.15-1	19 MAY 22
1.15-2	19 MAY 22
1.15-3	19 MAY 22
1.15-4	19 MAY 22
1.15-5	5 OCT 23
1.15-6	19 MAY 22
1.15-7	19 MAY 22
1.15-8	19 MAY 22
1.15-9	19 MAY 22
1.16-1	19 MAY 22
1.16-2	19 MAY 22
1.16-3	19 MAY 22
1.17-1	19 MAY 22
1.17-2	19 MAY 22
1.17-3	19 MAY 22
1.17-4	19 MAY 22
1.17-5	19 MAY 22
1.17-6	19 MAY 22
1.17-7	19 MAY 22
1.17-8	20 APR 23
1.17-9	19 MAY 22
1.17-10	19 MAY 22
1.17-11	19 MAY 22
1.17-12	19 MAY 22
1.17-13	19 MAY 22
<b>ENR 2</b>	
2-1	19 MAY 22
<b>ENR 3</b>	
3.1-1	19 MAY 22
3.2-1	19 MAY 22
3.3-1	20 APR 23
3.4-1	19 MAY 22
3.5-1	20 APR 23
3.5-2	20 APR 23
3.5-3	20 APR 23
3.5-4	20 APR 23
<b>ENR 4</b>	
4.1-1	19 MAY 22
4.1-2	19 MAY 22
4.1-3	19 MAY 22
4.1-4	19 MAY 22

PAGE	DATE
4.1-5	19 MAY 22
4.1-6	19 MAY 22
4.1-7	19 MAY 22
4.1-8	19 MAY 22
4.1-9	19 MAY 22
4.1-10	19 MAY 22
4.1-11	5 OCT 23
4.1-12	5 OCT 23
4.1-13	3 NOV 22
4.1-14	3 NOV 22
4.1-15	3 NOV 22
4.1-16	3 NOV 22
4.1-17	3 NOV 22
4.1-18	3 NOV 22
4.1-19	3 NOV 22
4.1-20	3 NOV 22
4.1-21	3 NOV 22
4.1-22	3 NOV 22
4.1-23	3 NOV 22
4.1-24	3 NOV 22
4.1-25	3 NOV 22
4.1-26	3 NOV 22
4.1-27	3 NOV 22
4.1-28	3 NOV 22
4.1-29	3 NOV 22
4.1-30	3 NOV 22
4.1-31	3 NOV 22
4.1-32	3 NOV 22
4.1-33	3 NOV 22
4.1-34	3 NOV 22
4.1-35	5 OCT 23
4.1-36	5 OCT 23
4.1-37	5 OCT 23
4.1-38	5 OCT 23
4.1-39	5 OCT 23
4.1-40	5 OCT 23
4.2-1	19 MAY 22
<b>ENR 5</b>	
5.1-1	19 MAY 22
5.1-2	19 MAY 22
5.1-3	19 MAY 22
5.1-4	19 MAY 22
5.1-5	19 MAY 22
5.1-6	5 OCT 23
5.2-1	19 MAY 22
5.2-2	5 OCT 23
5.2-3	5 OCT 23
5.3-1	19 MAY 22
5.4-1	19 MAY 22
5.5-1	19 MAY 22
5.6-1	19 MAY 22

PAGE	DATE
5.6-2	19 MAY 22
5.6-3	19 MAY 22
5.7-1	19 MAY 22
5.7-2	19 MAY 22
5.7-3	19 MAY 22
5.7-4	19 MAY 22
5.7-5	3 NOV 22
5.7-6	3 NOV 22
5.7-7	19 MAY 22
5.7-8	19 MAY 22
5.7-9	19 MAY 22
5.7-10	19 MAY 22
5.7-11	19 MAY 22
5.7-12	19 MAY 22
5.7-13	19 MAY 22
5.7-14	19 MAY 22
5.7-15	19 MAY 22
5.7-16	20 APR 23
5.7-17	20 APR 23
<b>ENR 6</b>	
6.1-1	19 MAY 22
6.1-2	19 MAY 22
6.1-3	19 MAY 22
6.1-4	19 MAY 22
6.1-5	19 MAY 22
6.1-6	19 MAY 22
6.1-7	19 MAY 22
6.1-8	19 MAY 22
6.2-1	5 OCT 23
6.2-2	19 MAY 22
6.2-3	19 MAY 22
6.2-4	19 MAY 22
6.2-5	5 OCT 23
6.2-6	19 MAY 22
6.2-7	19 MAY 22
6.2-8	19 MAY 22
6.2-9	19 MAY 22
6.2-10	19 MAY 22
6.2-11	19 MAY 22
6.2-12	19 MAY 22
6.2-13	19 MAY 22
6.2-14	19 MAY 22
6.2-15	19 MAY 22
6.2-17	19 MAY 22
6.2-18	19 MAY 22
6.2-19	19 MAY 22
6.2-20	19 MAY 22
<b>ENR 7</b>	
7.1-1	19 MAY 22

PAGE	DATE
7.1-2	20 APR 23
7.1-3	19 MAY 22
7.1-4	3 NOV 22
7.1-5	19 MAY 22
7.1-6	19 MAY 22
7.1-7	3 NOV 22
7.1-8	19 MAY 22
7.2-1	5 OCT 23
7.2-2	5 OCT 23
7.2-3	5 OCT 23
7.3-1	19 MAY 22
7.3-2	19 MAY 22
7.3-3	19 MAY 22
7.3-4	19 MAY 22
7.3-5	19 MAY 22
7.4-1	3 NOV 22
7.4-2	3 NOV 22
7.4-3	19 MAY 22
7.4-4	19 MAY 22
7.4-5	3 NOV 22
7.5-1	20 APR 23
7.5-2	20 APR 23
7.5-3	20 APR 23

PAGE	DATE
7.6-1	19 MAY 22
7.6-2	19 MAY 22
7.7-1	19 MAY 22
7.8-1	3 NOV 22
7.8-2	3 NOV 22
7.8-3	19 MAY 22
7.9-1	19 MAY 22
7.10-1	19 MAY 22
7.11-1	19 MAY 22
7.11-2	20 APR 23
7.12-1	19 MAY 22
7.13-1	19 MAY 22
7.14-1	20 APR 23
<b>ENR 8</b>	
8.1-1	20 APR 23
8.1-2	20 APR 23
8.2-1	20 APR 23
8.2-2	5 OCT 23
8.2-3	20 APR 23
8.3-1	20 APR 23
8.3-2	20 APR 23
8.3-3	20 APR 23

PAGE	DATE
8.3-4	20 APR 23
8.3-5	20 APR 23
8.3-6	20 APR 23
8.4-1	20 APR 23
8.4-2	20 APR 23
8.4-3	20 APR 23
8.4-4	20 APR 23
8.4-5	20 APR 23
8.4-6	20 APR 23
8.4-7	20 APR 23
8.4-8	20 APR 23
8.4-9	20 APR 23
8.5-1	20 APR 23
8.5-2	5 OCT 23
8.5-3	20 APR 23
8.6-1	20 APR 23
8.7-1	20 APR 23
8.8-1	20 APR 23
8.8-2	20 APR 23
8.8-3	20 APR 23
8.8-4	20 APR 23

**ENR 0.5 List of Hand Amendments to the AIP – Not applicable**

ENR 0.5 List of Hand Amendments to the AIP – Not applicable



## ENR 0.6 Table of Contents to Part 2

### ENR 1. GENERAL RULES AND PROCEDURES

ENR 1.1 General Rules .....	ENR 1.1-1
ENR 1.2 Visual Flight Rules .....	ENR 1.2-1
ENR 1.3 Instrument Flight Rules .....	ENR 1.3-1
ENR 1.4 ATS Airspace Classification .....	ENR 1.4-1
ENR 1.5 Holding, Approach, and Departure Procedures .....	ENR 1.5-1
ENR 1.6 ATS Surveillance Services and Procedures .....	ENR 1.6-1
ENR 1.7 Barometric Altimeter Errors and Setting Procedures .....	ENR 1.7-1
ENR 1.8 Cold Temperature Barometric Altimeter Errors, Setting procedures, and Cold Temperature Airports (CTA) .....	ENR 1.8-1
ENR 1.9 [Reserved] .....	ENR 1.9-1
ENR 1.10 Flight Planning (Restriction, Limitation or Advisory Information) .....	ENR 1.10-1
ENR 1.11 Addressing of Flight Plans for Domestic or International Flight Planning .....	ENR 1.11-1
ENR 1.12 National Security and Interception Procedures .....	ENR 1.12-1
ENR 1.13 [Reserved] .....	ENR 1.13-1
ENR 1.14 [Reserved] .....	ENR 1.14-1
ENR 1.15 Medical Facts for Pilots .....	ENR 1.15-1
ENR 1.16 Safety, Hazard, and Accident Reports .....	ENR 1.16-1
ENR 1.17 Performance-Based Navigation (PBN) and Area Navigation (RNAV) .....	ENR 1.17-1

### ENR 2. AIR TRAFFIC SERVICES AIRSPACE .....

ENR 2-1

### ENR 3. ATS ROUTES

ENR 3.1 Lower ATS Routes .....	ENR 3.1-1
ENR 3.2 Upper ATS Routes .....	ENR 3.2-1
ENR 3.3 Area Navigation (RNAV) Routes .....	ENR 3.3-1
ENR 3.4 [Reserved] .....	ENR 3.4-1
ENR 3.5 Other Routes .....	ENR 3.5-1

### ENR 4. NAVIGATION AIDS/SYSTEMS

ENR 4.1 Navigation Aids – En Route .....	ENR 4.1-1
ENR 4.2 Special Navigation Systems .....	ENR 4.2-1

### ENR 5. NAVIGATION WARNINGS

ENR 5.1 Prohibited, Restricted, and Other Areas .....	ENR 5.1-1
ENR 5.2 Military Exercise and Training Areas .....	ENR 5.2-1
ENR 5.3 [Reserved] .....	ENR 5.3-1
ENR 5.4 [Reserved] .....	ENR 5.4-1
ENR 5.5 [Reserved] .....	ENR 5.5-1
ENR 5.6 Bird Migration and Areas with Sensitive Fauna .....	ENR 5.6-1
ENR 5.7 Potential Flight Hazards .....	ENR 5.7-1

### ENR 6. HELICOPTER OPERATIONS

ENR 6.1 Helicopter IFR Operations .....	ENR 6.1-1
ENR 6.2 Special Operations .....	ENR 6.2-1

**ENR 7. OCEANIC OPERATIONS**

ENR 7.1 General Procedures ..... ENR 7.1-1  
ENR 7.2 Data Link Procedures ..... ENR 7.2-1  
ENR 7.3 Special Procedures for In-Flight Contingencies in Oceanic Airspace ..... ENR 7.3-1  
ENR 7.4 Operational Policy 50 NM Lateral Separation ..... ENR 7.4-1  
ENR 7.5 Operational Policy Performance-Based Navigation (PBN) and Performance-  
Based Communication and Surveillance (PBCS) ..... ENR 7.5-1  
ENR 7.6 North Atlantic (NAT) Oceanic Clearance Procedures ..... ENR 7.6-1  
ENR 7.7 North Atlantic (NAT) Timekeeping Procedures ..... ENR 7.7-1  
ENR 7.8 North Atlantic (NAT) Safety Information ..... ENR 7.8-1  
ENR 7.9 San Juan FIR Customs Procedures ..... ENR 7.9-1  
ENR 7.10 Y-Routes ..... ENR 7.10-1  
ENR 7.11 Atlantic High Offshore Airspace Offshore Routes Supporting Florida Airspace  
Optimization ..... ENR 7.11-1  
ENR 7.12 Reduced Separation Climb/Descent Procedures ..... ENR 7.12-1  
ENR 7.13 New York Oceanic Control Area (OCA) West Flight Level Allocation ..... ENR 7.13-1  
ENR 7.14 Gulf of Mexico RNAV Routes Q100, Q102, and Q105 ..... ENR 7.14-1

**ENR 8. UNMANNED AIRCRAFT SYSTEMS (UAS)**

ENR 8.1 General ..... ENR 8.1-1  
ENR 8.2 Small Unmanned Aircraft System (sUAS) ..... ENR 8.2-1  
ENR 8.3 Large UAS (MCGOW 55 Pounds or More) ..... ENR 8.3-1  
ENR 8.4 Airspace Access for UAS ..... ENR 8.4-1  
ENR 8.5 UAS Pilot Testing, Certification and Responsibilities ..... ENR 8.5-1  
ENR 8.6 Advanced Air Mobility ..... ENR 8.6-1  
ENR 8.7 UAS Operations on Airports ..... ENR 8.7-1  
ENR 8.8 Other Information and Best Practices ..... ENR 8.8-1

# ENR 1. GENERAL RULES AND PROCEDURES

## ENR 1.1 General Rules

### 1. Differences between National and International Rules and Procedures

**1.1** The air traffic rules and procedures applicable to air traffic in U.S. Class A, B, C, D and E airspace conform with Annexes 2 and 11 to the Convention on International Civil Aviation and to those portions applicable to aircraft in the Procedures for Air Navigation Services – Rules of the Air and Air Traffic Services (Doc 4444 – RAC/501/10) and to the Regional Supplementary Procedures (DOC 7030) applicable to the NAM, NAT, CAR and PAC Regions, except as noted in the cases below. All differences have been registered with the International Civil Aviation Organization.

#### 1.1.1 Annex 2 – Rules of the Air

**NOTE–**  
See GEN 1.7.

#### 1.1.2 Annex 11 – Air Traffic Services

**NOTE–**  
See GEN 1.7.

#### 1.1.3 Procedures for Air Navigation Services – Rules of the Air (DOC 4444) and Air Traffic Services (RAC/501/10)

**NOTE–**  
See GEN 1.7.

#### 1.1.4 Regional Supplementary Procedures (Doc 7030)

**NOTE–**  
See GEN 1.7.

### 2. Airport Operations

#### 2.1 General

**2.1.1** Increased traffic congestion, aircraft in climb and descent attitudes, and pilots preoccupation with cockpit duties are some factors that increase the hazardous accident potential near the airport. The situation is further compounded when the weather is marginal; that is, just meeting VFR requirements. Pilots must be particularly alert when operating in the vicinity of an airport. This section defines some rules, practices, and procedures that pilots should be familiar with, and adhere to, for safe airport operations.

**2.1.2** Each airport operator regularly serving scheduled air carriers has put into use security measures designed to prevent or deter unauthorized persons from having access to “Air Operations Area.” The “Air Operations Area” means any area of the airport used or intended to be used for landing, takeoff, or surface maneuvering of aircraft. Pilots are encouraged to obtain airport security instructions by posted signs or radio communication.

### 3. Airports With an Operating Control Tower

**3.1** Towers have been established to provide for a safe, orderly, and expeditious flow of traffic on and in the vicinity of an airport. When the responsibility has been so delegated, towers also provide for the separation of IFR aircraft in the terminal areas (Approach Control).

**3.2** When operating at an airport where traffic control is being exercised by a control tower, pilots are required to maintain two-way radio contact with the tower while operating within the Class B, Class C, and Class D

surface area unless the tower authorizes otherwise. Initial callup should be made about 15 miles from the airport. Unless there is a good reason to leave the tower frequency before exiting the Class B, Class C, and Class D surface area, it is a good operating practice to remain on the tower frequency for the purpose of receiving traffic information. In the interest of reducing tower frequency congestion, pilots are reminded that it is not necessary to request permission to leave the tower frequency once outside of Class B, Class C, and Class D surface area. Not all airports with an operating control tower will have Class D airspace. These airports do not have weather reporting which is a requirement for surface-based controlled airspace, previously known as a control zone. The controlled airspace over these airports will normally begin at 700 feet or 1,200 feet above ground level and can be determined from the visual aeronautical charts. Pilots are expected to use good operating practices and communicate with the control tower as described in this section.

**3.3** When necessary, the tower controller will issue clearances or other information for aircraft to generally follow the desired flight path (traffic pattern) when flying in the Class D airspace, and the proper taxi routes when operating on the ground. If not otherwise authorized or directed by the tower, pilots approach to land in an airplane must circle the airport to the left, and pilots approaching to land in a helicopter must avoid the flow of fixed-wing traffic. However, an appropriate clearance must be received from the tower before landing.

**3.4** The following terminology for the various components of a traffic pattern has been adopted as standard for use by control towers and pilots:

**3.4.1 Upwind leg.** A flight path parallel to the landing runway in the direction of landing.

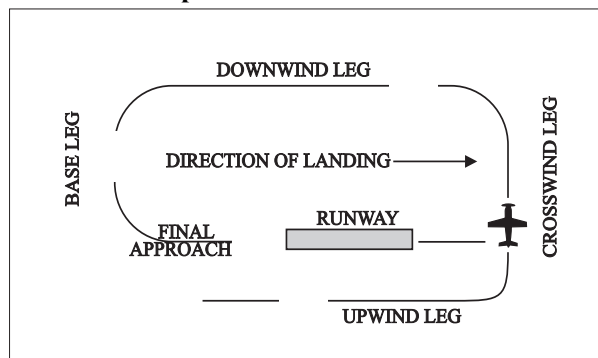
**3.4.2 Crosswind leg.** A flight path at right angles to the landing runway off its takeoff end.

**3.4.3 Downwind leg.** A flight path parallel to the landing runway in the opposite direction of landing.

**3.4.4 Base leg.** A flight path at right angles to the landing runway off its approach end and extending from the downwind leg to the intersection of the extended runway centerline.

**3.4.5 Final approach.** A flight path in the direction of landing along the extended runway centerline from the base leg to the runway.

FIG ENR 1.1-1  
Components of a Traffic Pattern



**NOTE-**

FIG ENR 1.1-1 is intended only to illustrate terminology used in identifying various components of a traffic pattern. It should not be used as a reference or guide on how to enter a traffic pattern.

**3.5** Many towers are equipped with a tower radar display. The radar uses are intended to enhance the effectiveness and efficiency of the local control, or tower, position. They are not intended to provide radar services or benefits to pilots except as they may accrue through a more efficient tower operation. The four basic uses are:

**3.5.1** To determine an aircraft's exact location. This is accomplished by radar identifying the VFR aircraft through any of the techniques available to a radar position; such as, having the aircraft ident. Once identified, the aircraft's position and spatial relationship to other aircraft can be quickly determined, and standard



instructions regarding VFR operation in the aircraft traffic area will be issued. Once initial radar identification of a VFR aircraft has been established and the appropriate instructions have been issued, radar monitoring may be discontinued; the reason being that the local controller's primary means of surveillance in VFR conditions is usually scanning the airport and local area.

**3.5.2** To provide radar traffic advisories. Radar traffic advisories may be provided to the extent that the local controller is able to monitor the radar display. Local control has primary control responsibilities to the aircraft operating on the runways which will normally supersede radar monitoring duties.

**3.5.3** To provide a direction or suggested heading. The local controller may provide pilots flying VFR with generalized instructions which will facilitate operations; e.g., "PROCEED SOUTHWEST BOUND, ENTER A RIGHT DOWNWIND RUNWAY THREE ZERO;" or provide a suggested heading to establish radar identification or as an advisory aid to navigation; e.g., "SUGGESTED HEADING TWO TWO ZERO, FOR RADAR IDENTIFICATION." In both cases, the instructions are advisory aids to the pilot flying VFR and are not radar vectors. **PILOTS HAVE COMPLETE DISCRETION REGARDING ACCEPTANCE OF THE SUGGESTED HEADING OR DIRECTION AND HAVE SOLE RESPONSIBILITY FOR SEEING AND AVOIDING OTHER AIRCRAFT.**

**3.5.4** To provide information and instructions to aircraft operating within Class D airspace. In an example of this situation, the local controller would use the radar to advise a pilot on an extended downwind when to turn base leg.

**NOTE–**

*The above tower radar applications are intended to augment the standard functions of the local control position. There is no controller requirement to maintain constant radar identification and, in fact, such a requirement could compromise the local controller's ability to visually scan the airport and local area to meet FAA responsibilities to the aircraft operating on the runways and within Class D airspace. Normally, pilots will not be advised of being in radar contact since that continued status cannot be guaranteed and since the purpose of the radar identification is not to establish a link for the provision of radar services.*

**3.6** A few of the radar-equipped towers are authorized to use the radar to ensure separation between aircraft in specific situations, while still others may function as limited radar approach controls. The various radar uses are strictly a function of FAA operational need. The facilities may be indistinguishable to pilots since they are all referred to as tower and no publication lists the degree of radar use. **THEREFORE, WHEN IN COMMUNICATION WITH A TOWER CONTROLLER WHO MAY HAVE RADAR AVAILABLE, DO NOT ASSUME THAT CONSTANT RADAR MONITORING AND COMPLETE ATC RADAR SERVICES ARE BEING PROVIDED.**

## **4. Traffic Patterns**

**4.1** It is recommended that aircraft enter the airport traffic pattern at one of the following altitudes listed below. These altitudes should be maintained unless another traffic pattern altitude is published in the Chart Supplement U.S. or unless otherwise required by the applicable distance from cloud criteria (14 CFR Section 91.155). (See FIG ENR 1.1–2 and FIG ENR 1.1–3.):

**4.1.1** Propeller-driven aircraft enter the traffic pattern at 1,000 feet above ground level (AGL).

**4.1.2** Large and turbine-powered aircraft enter the traffic pattern at an altitude of not less than 1,500 feet AGL or 500 feet above the established pattern altitude.

**4.1.3** Helicopters operating in the traffic pattern may fly a pattern similar to the fixed-wing aircraft pattern, but at a lower altitude (500 AGL) and closer to the runway. This pattern may be on the opposite side of the runway from fixed-wing traffic when airspeed requires or for practice power-off landings (autorotation) and if local policy permits. Landings not to the runway must avoid the flow of fixed wing traffic.

**4.2** A pilot may vary the size of the traffic pattern depending on the aircraft's performance characteristics. Pilots of en route aircraft should be constantly alert for aircraft in traffic patterns and avoid these areas whenever possible.

**4.3** Unless otherwise indicated, all turns in the traffic pattern must be made to the left, except for helicopters, as applicable.

**4.4** On Sectional, Aeronautical, and VFR Terminal Area Charts, right traffic patterns are indicated at public-use and joint-use airports with the abbreviation “RP” (for Right Pattern), followed by the appropriate runway number(s) at the bottom of the airport data block.

**EXAMPLE-**  
*RP 9, 18, 22R*

**NOTE-**

**1.** *Pilots are encouraged to use the standard traffic pattern. However, those pilots who choose to execute a straight-in approach, maneuvering for and execution of the approach should not disrupt the flow of arriving and departing traffic. Likewise, pilots operating in the traffic pattern should be alert at all times for aircraft executing straight-in approaches.*

**REFERENCE-**

*AC 90-66B, Non-Towered Airport Flight Operations*

**2.** *\*RP indicates special conditions exist and refers pilots to the Chart Supplement U.S.*

**3.** *Right traffic patterns are not shown at airports with full-time control towers.*

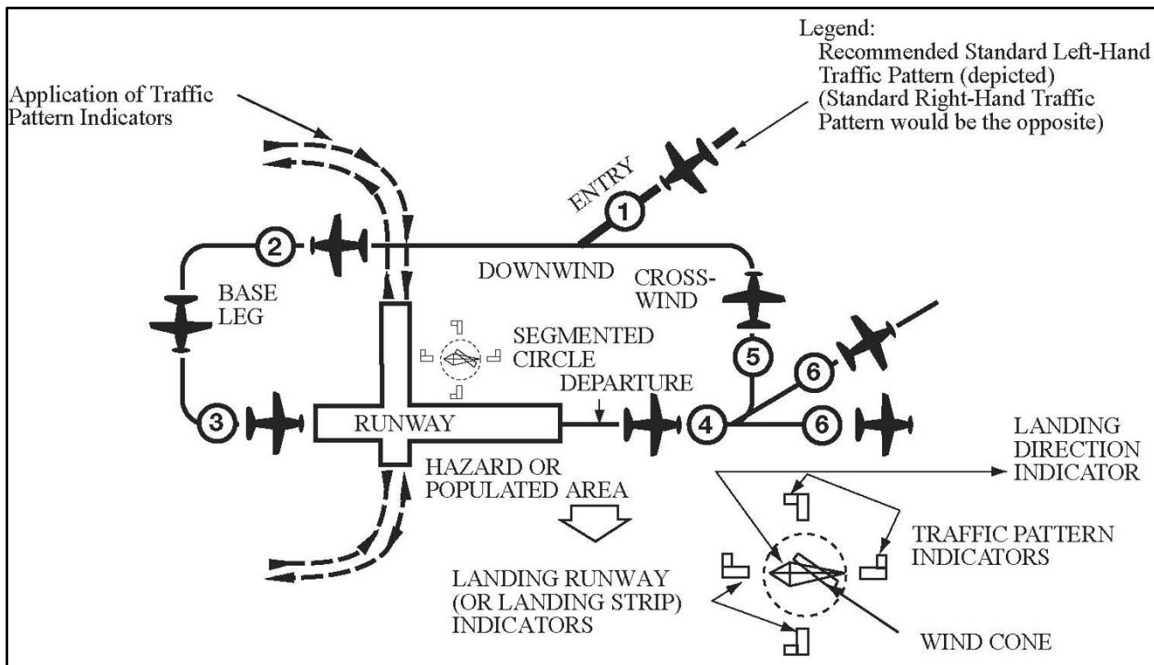
**4.5** Wind conditions affect all airplanes in varying degrees. FIG ENR 1.1-4 is an example of a chart used to determine the headwind, crosswind, and tailwind components based on wind direction and velocity relative to the runway. Pilots should refer to similar information provided by the aircraft manufacturer when determining these wind components.

#### **4.6 Unexpected Maneuvers in the Airport Traffic Pattern**

**4.6.1** There have been several incidents in the vicinity of controlled airports that were caused primarily by aircraft executing unexpected maneuvers. ATC service is based upon observed or known traffic and airport conditions. Controllers establish the sequence of arriving and departing aircraft by requiring them to adjust flight as necessary to achieve proper spacing. These adjustments can only be based on observed traffic, accurate pilot reports, and anticipated aircraft maneuvers. Pilots are expected to cooperate so as to preclude disruption of traffic flow or creation of conflicting patterns. The pilot in command of an aircraft is directly responsible for and is the final authority as to the operation of that aircraft.

**4.6.2** On occasion it may be necessary for pilots to maneuver their aircraft to maintain spacing with the traffic they have been sequenced to follow. The controller can anticipate minor maneuvering such as shallow “S” turns. The controller cannot, however, anticipate a major maneuver such as a 360-degree turn. If a pilot makes a 360-degree turn after obtaining a landing sequence, the result is usually a gap in the landing interval and more importantly it causes a chain reaction which may result in a conflict with following traffic and interruption of the sequence established by the tower or approach controller. Should a pilot decide to make maneuvering turns to maintain spacing behind a preceding aircraft, the pilot should always advise the controller if at all possible. Except when requested by the controller or in emergency situations, a 360-degree turn should never be executed in the traffic pattern or when receiving radar service without first advising the controller.

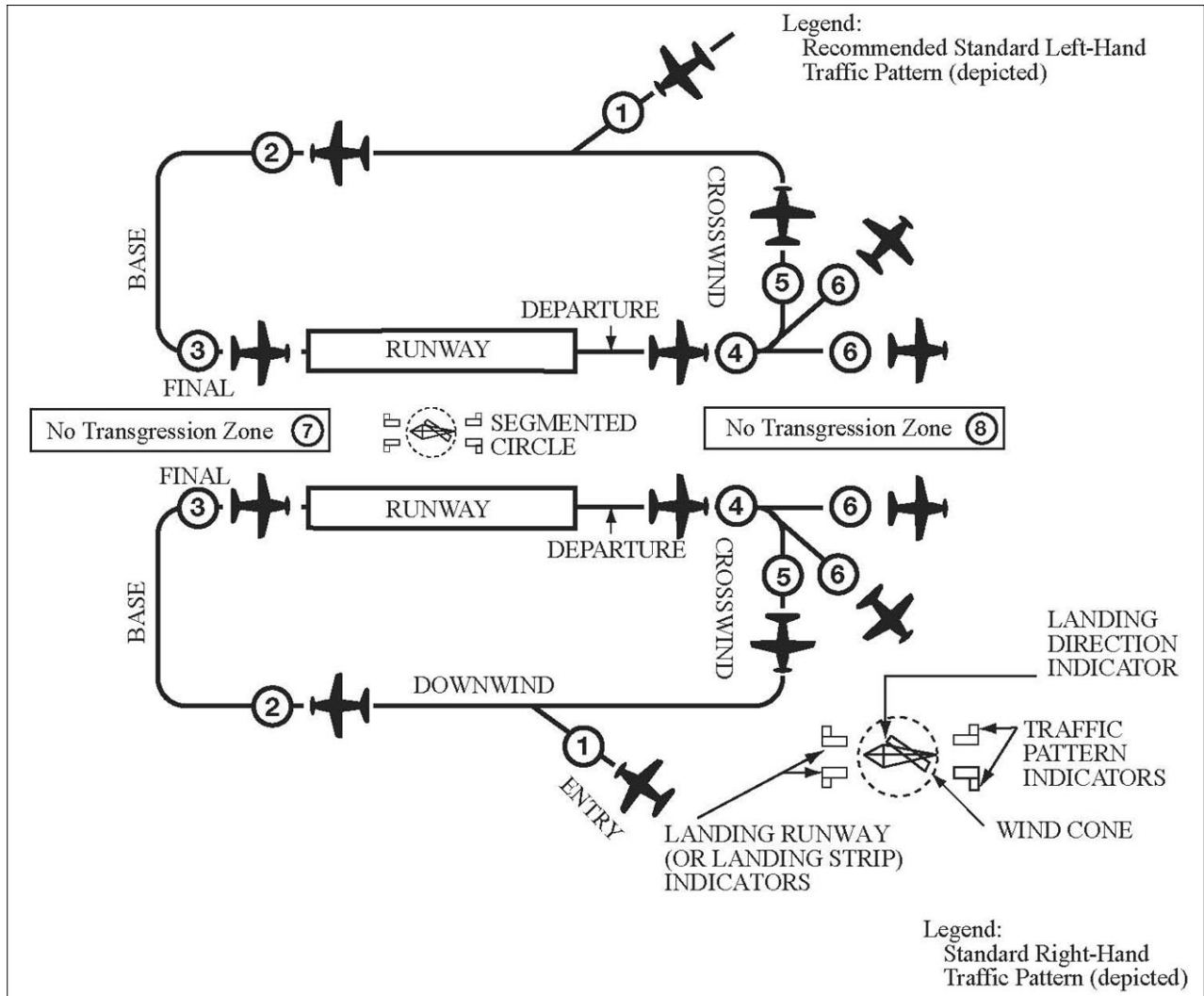
FIG ENR 1.1-2  
Traffic Pattern Operations  
Single Runway



**EXAMPLE—  
KEY TO TRAFFIC PATTERN OPERATIONS**

1. Enter pattern in level flight, abeam the midpoint of the runway, at pattern altitude.
2. Maintain pattern altitude until abeam approach end of the landing runway on downwind leg.
3. Complete turn to final at least  $\frac{1}{4}$  mile from the runway.
4. Continue straight ahead until beyond departure end of runway.
5. If remaining in the traffic pattern, commence turn to crosswind leg beyond the departure end of the runway within 300 feet of pattern altitude.
6. If departing the traffic pattern, continue straight out, or exit with a 45 degree turn (to the left when in a left-hand traffic pattern; to the right when in a right-hand traffic pattern) beyond the departure end of the runway, after reaching pattern altitude.

FIG ENR 1.1-3  
Traffic Pattern Operations  
Parallel Runways

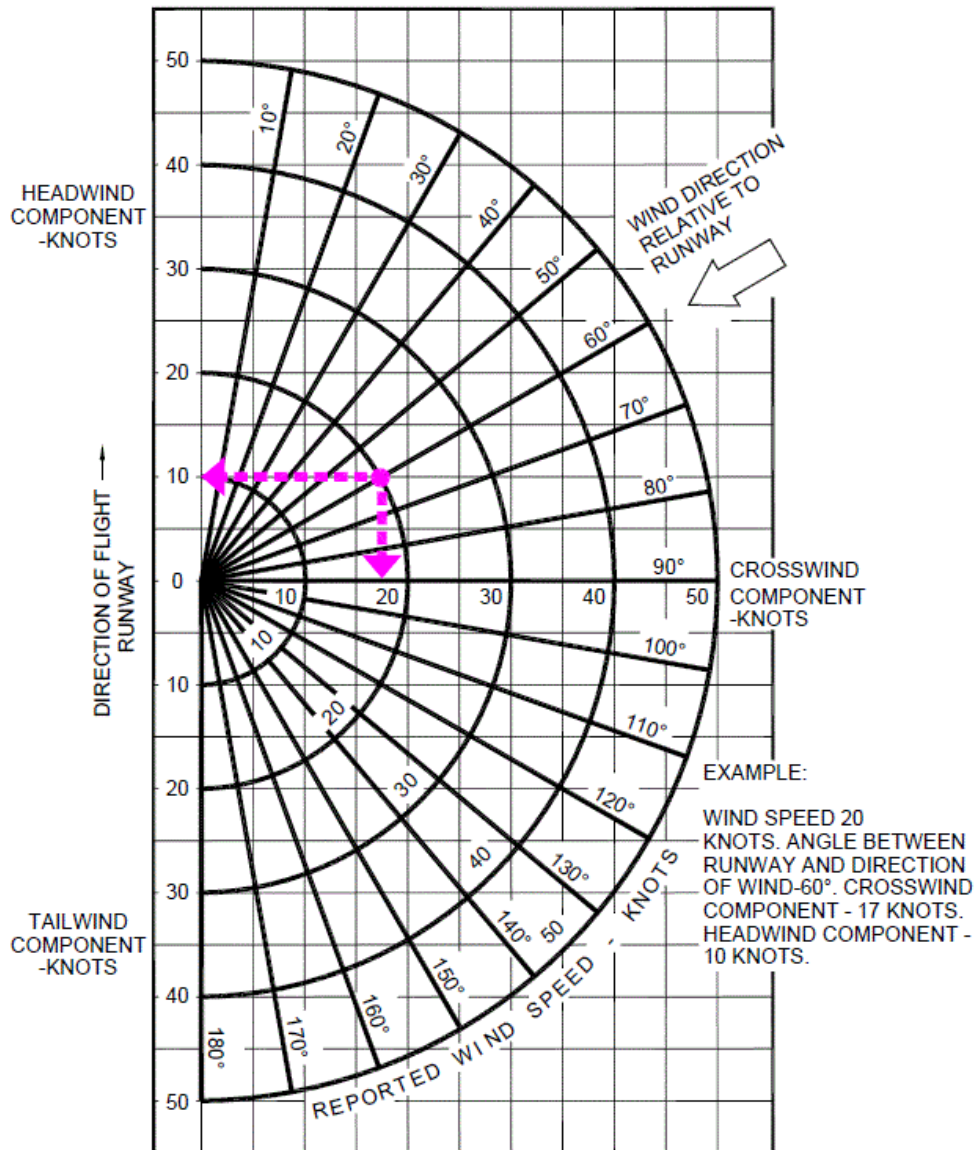


**EXAMPLE-**  
**KEY TO TRAFFIC PATTERN OPERATIONS**

1. Enter pattern in level flight, abeam the midpoint of the runway, at pattern altitude.
2. Maintain pattern altitude until abeam approach end of the landing runway on downwind leg.
3. Complete turn to final at least  $\frac{1}{4}$  mile from the runway.
4. Continue straight ahead until beyond departure end of runway.
5. If remaining in the traffic pattern, commence turn to crosswind leg beyond the departure end of the runway within 300 feet of pattern altitude.
6. If departing the traffic pattern, continue straight out, or exit with a 45 degree turn (to the left when in a left-hand traffic pattern; to the right when in a right-hand traffic pattern) beyond the departure end of the runway, after reaching pattern altitude.

- 7. Do not overshoot final or continue on a track which will penetrate the final approach of the parallel runway.
- 8. Do not continue on a track which will penetrate the departure path of the parallel runway.

FIG ENR 1.1-4  
Headwind/Tailwind/Crosswind Component Calculator



## 5. Visual Indicators at Airports Without an Operating Control Tower

**5.1** At those airports without an operating control tower, a segmented circle visual indicator system, if installed, is designed to provide traffic pattern information. The segmented circle system consists of the following components:

**5.1.1 The Segmented Circle.** Located in a position affording maximum visibility to pilots in the air and on the ground and providing a centralized location for other elements of the system.

**5.1.2 The Wind Direction Indicator.** A wind cone, wind sock, or wind tee installed near the operational runway to indicate wind direction. The large end of the wind cone/wind sock points into the wind as does the

large end (cross bar) of the wind tee. In lieu of a tetrahedron and where a wind sock or wind cone is collocated with a wind tee, the wind tee may be manually aligned with the runway in use to indicate landing direction. These signaling devices may be located in the center of the segmented circle and may be lighted for night use. Pilots are cautioned against using a tetrahedron to indicate wind direction.

**5.1.3 The Landing Direction Indicator.** A tetrahedron is installed when conditions at the airport warrant its use. It may be used to indicate the direction of landings and takeoffs. A tetrahedron may be located at the center of a segmented circle and may be lighted for night operations. The small end of the tetrahedron points in the direction of landing. Pilots are cautioned against using a tetrahedron for any purpose other than as an indicator of landing direction. Further, pilots should use extreme caution when making runway selection by use of a tetrahedron in very light or calm wind conditions as the tetrahedron may not be aligned with the designated calm–wind runway. At airports with control towers, the tetrahedron should only be referenced when the control tower is not in operation. Tower instructions supersede tetrahedron indications.

**5.1.4 Landing Strip Indicators.** Installed in pairs as shown in the segmented circle diagram, and used to show the alignment of landing strips.

**5.1.5 Traffic Pattern Indicators.** Arranged in pairs in conjunction with landing strip indicators and used to indicate the direction of turns when there is a variation from the normal left traffic pattern. If there is no segmented circle installed at the airport, traffic pattern indicators may be installed on or near the end of the runway.

**5.2** Preparatory to landing at an airport without a control tower, or when the control tower is not in operation, the pilot should concern himself with the indicator for the approach end of the runway to be used. When approaching for landing, all turns must be made to the left unless a traffic pattern indicator indicates that turns should be made to the right. If the pilot will mentally enlarge the indicator for the runway to be used, the base and final approach legs of the traffic pattern to be flown immediately become apparent. Similar treatment of the indicator at the departure end of the runway will clearly indicate the direction of turn after takeoff.

**5.3** When two or more aircraft are approaching an airport for the purpose of landing, the pilot of the aircraft at the lower altitude has the right–of–way over the pilot of the aircraft at the higher altitude. However, the pilot operating at the lower altitude should not take advantage of another aircraft, which is on final approach to land, by cutting in front of, or overtaking that aircraft.

## 6. Ground Control Frequencies

**6.1** Pilots of departing aircraft should communicate with the control tower on the appropriate ground control/clearance delivery frequency prior to starting engines to receive engine start time, taxi and/or clearance information. Unless otherwise advised by the tower, remain on that frequency during taxiing and runup, then change to local control frequency when ready to request takeoff clearance.

### **NOTE–**

*Pilots are encouraged to monitor the local tower frequency as soon as practical consistent with other ATC requirements.*

**6.2** The tower controller will consider that pilots of turbine–powered aircraft are ready for takeoff when they reach the runway or warm–up block unless advised otherwise.

**6.3** The majority of ground control frequencies are in the 121.6–121.9 MHz bandwidth. Ground control frequencies are provided to eliminate frequency congestion on the tower (local control) frequency and are limited to communications between the tower and aircraft on the ground and between the tower and utility vehicles on the airport, provide a clear VHF channel for arriving and departing aircraft. They are used for issuance of taxi information, clearances, and other necessary contacts between the tower and aircraft or other vehicles operated on the airport. A pilot who has just landed should not change from the tower frequency to the ground control frequency until directed to do so by the controller. Normally, only one ground control frequency is assigned at an airport; however, at locations where the amount of traffic so warrants, a second ground control frequency and/or another frequency designated as a clearance delivery frequency, may be assigned.

**6.4** A controller may omit the ground or local control frequency if the controller believes the pilot knows which frequency is in use. If the ground control frequency is in the 121 MHz bandwidth the controller may omit the

numbers preceding the decimal point; e.g., 121.7, “CONTACT GROUND POINT SEVEN.” However, if any doubt exists as to what frequency is in use, the pilot should promptly request the controller to provide that information.

**6.5** Controllers will normally avoid issuing a radio frequency change to helicopters, known to be single-piloted, which are hovering, air taxiing, or flying near the ground. At times, it may be necessary for pilots to alert ATC regarding single pilot operations to minimize delay of essential ATC communications. Whenever possible, ATC instructions will be relayed through the frequency being monitored until a frequency change can be accomplished. Pilots must promptly advise ATC if they are unable to comply with a frequency change. Also, pilots should advise ATC if they must land to accomplish the frequency change unless it is clear the landing; e.g., on a taxiway or in a helicopter operating area, will have no impact on other air traffic.

## 7. Traffic Control Light Signals

**7.1** The following procedures are used by airport traffic control towers in the control of aircraft, ground vehicles, equipment, and personnel not equipped with radio. These same procedures will be used to control aircraft, ground vehicles, equipment, and personnel equipped with radio if radio contact cannot be established. Airport traffic control personnel use a directive traffic control signal which emits an intense narrow beam of a selected color (either red, white, or green) when controlling traffic by light signals.

**7.2** Although the traffic signal light offers the advantage that some control may be exercised over nonradio-equipped aircraft, pilots should be cognizant of the disadvantages which are:

**7.2.1** The pilot may not be looking at the control tower at the time a signal is directed toward him/her; and

**7.2.2** The directions transmitted by a light signal are very limited since only approval of a pilot’s anticipated actions may be transmitted. No supplement or explanatory information may be transmitted except by the use of the “General Warning Signal” which advises the pilot to be on the alert.

**7.3** Between sunset and sunrise, a pilot wishing to attract the attention of the control tower should turn on a landing light and taxi the aircraft into a position, clear of the active runway, so that light is visible to the tower. The landing light should remain on until appropriate signals are received from the tower.

*TBL ENR 1.1-1*  
**Airport Traffic Control Tower Light Gun Signals**

Meaning			
Color and Type of Signal	Movement of Vehicles, Equipment and Personnel	Aircraft on the Ground	Aircraft in Flight
Steady green	Cleared to cross, proceed or go	Cleared for takeoff	Cleared to land
Flashing green	Not applicable	Cleared for taxi	Return for landing (to be followed by steady green at the proper time)
Steady red	STOP	STOP	Give way to other aircraft and continue circling
Flashing red	Clear the taxiway/runway	Taxi clear of the runway in use	Airport unsafe, do not land
Flashing white	Return to starting point on airport	Return to starting point on airport	Not applicable
Alternating red and green	Exercise extreme caution	Exercise extreme caution	Exercise extreme caution

## 8. Use of Runways/Declared Distances

**8.1** Runways are identified by numbers that indicate the nearest 10-degree increment of the azimuth of the runway centerline. For example, where the magnetic azimuth is 183 degrees, the runway designation would be 18; for a magnetic azimuth of 87 degrees, the runway designation would be 9. For a magnetic azimuth ending in the number 5, such as 185, the runway designation could be either 18 or 19. Wind direction issued by the tower is also magnetic and wind velocity is in knots.

**NOTE–**

1. At airports with multiple parallel runways whose magnetic azimuths are identical, each runway number will be supplemented by a letter and shown from left to right when viewed from the direction of approach.
2. When multiple parallel runways at the same airport are separated by a large distance, such as by a central terminal or several terminals, the runways may be designated as non-parallel runways to avoid pilot confusion.

**REFERENCE–**

AC 150/5340–1, Standards for Airport Markings, Para 2.3.5, Characteristics.

**8.2** Airport proprietors are responsible for taking the lead in local aviation noise control. Accordingly, they may propose specific noise abatement plans to the FAA. If approved, these plans are applied in the form of Formal or Informal Runway Use Programs for noise abatement purposes.

**8.2.1** ATC will assign the runway/s most nearly aligned with the wind when 5 knots or more, or the “calm wind” runway when less than 5 knots unless:

**8.2.1.1** Use of another runway is operationally advantageous, or

**8.2.1.2** A Runway Use Program is in effect.

**NOTE–**

Tailwind and crosswind considerations take precedence over delay/capacity considerations, and noise abatement operations/procedures.

**REFERENCE–**

FAA Order JO 7110.65, Para 3–5–1, Selection.

**8.3** If a pilot prefers to use a runway different from that specified, the pilot is expected to advise ATC. ATC may honor such requests as soon as is operationally practicable. ATC will advise pilots when the requested runway is noise sensitive. When use of a runway other than the one assigned is requested, pilot cooperation is encouraged to preclude disruption of traffic flows or the creation of conflicting patterns.

**REFERENCE–**

FAA Order JO 7110.65, Para 3–5–1, Selection.

**8.4 Declared Distances.**

**8.4.1** Declared distances for a runway represent the maximum distances available and suitable for meeting takeoff and landing distance performance requirements. These distances are determined in accordance with FAA runway design standards by adding to the physical length of paved runway any clearway or stopway and subtracting from that sum any lengths necessary to obtain the standard runway safety areas, runway object free areas, or runway protection zones. As a result of these additions and subtractions, the declared distances for a runway may be more or less than the physical length of the runway as depicted on aeronautical charts and related publications, or available in electronic navigation databases provided by either the U.S. Government or commercial companies.

**8.4.2** All 14 CFR Part 139 airports report declared distances for each runway. Other airports may also report declared distances for a runway if necessary to meet runway design standards or to indicate the presence of a clearway or stopway. Where reported, declared distances for each runway end are published in the Chart Supplement U.S. For runways without published declared distances, the declared distances may be assumed to be equal to the physical length of the runway unless there is a displaced landing threshold, in which case the Landing Distance Available (LDA) is shortened by the amount of the threshold displacement.

**NOTE–**

A symbol **D** is shown on U.S. Government charts to indicate that runway declared distance information is available (See appropriate Chart Supplement U.S., Alaska, or Pacific).

**8.4.2.1** The FAA uses the following definitions for runway declared distances (See FIG ENR 1.1–5).

**REFERENCE–**

Pilot/Controller Glossary Terms: “Accelerate–Stop Distance Available,” “Landing Distance Available,” “Takeoff Distance Available,” “Takeoff Run Available,” “Stopway,” and “Clearway.”

**a)** Takeoff Run Available (TORA) – The runway length declared available and suitable for the ground run of an airplane taking off.



The TORA is typically the physical length of the runway, but it may be shorter than the runway length if necessary to satisfy runway design standards. For example, the TORA may be shorter than the runway length if a portion of the runway must be used to satisfy runway protection zone requirements.

**b) Takeoff Distance Available (TODA)** – The takeoff run available plus the length of any remaining runway or clearway beyond the far end of the takeoff run available.

The TODA is the distance declared available for satisfying takeoff distance requirements for airplanes where the certification and operating rules and available performance data allow for the consideration of a clearway in takeoff performance computations.

**NOTE–**

*The length of any available clearway will be included in the TODA published in the entry for the Chart Supplement U.S. for that runway end.*

**c) Accelerate–Stop Distance Available (ASDA)** – The runway plus stopway length declared available and suitable for the acceleration and deceleration of an airplane aborting a takeoff.

The ASDA may be longer than the physical length of the runway when a stopway has been designated available by the airport operator, or it may be shorter than the physical length of the runway if necessary to use a portion of the runway to satisfy runway design standards; for example, where the airport operator uses a portion of the runway to achieve the runway safety area requirement. ASDA is the distance used to satisfy the airplane accelerate–stop distance performance requirements where the certification and operating rules require accelerate–stop distance computations.

**NOTE–**

*The length of any available stopway will be included in the ASDA published in the entry for the Chart Supplement U.S. for that runway end.*

**d) Landing Distance Available (LDA)** – The runway length declared available and suitable for a landing airplane.

The LDA may be less than the physical length of the runway or the length of the runway remaining beyond a displaced threshold if necessary to satisfy runway design standards; for example, where the airport operator uses a portion of the runway to achieve the runway safety area requirement.

Although some runway elements (such as stopway length and clearway length) may be available information, pilots must use the declared distances determined by the airport operator and not attempt to independently calculate declared distances by adding those elements to the reported physical length of the runway.

**8.4.2.2** The airplane operating rules and/or the airplane operating limitations establish minimum distance requirements for takeoff and landing and are based on performance data supplied in the Airplane Flight Manual or Pilot’s Operating Handbook. The minimum distances required for takeoff and landing obtained either in planning prior to takeoff or in performance assessments conducted at the time of landing must fall within the applicable declared distances before the pilot can accept that runway for takeoff or landing.

**8.4.2.3** Runway design standards may impose restrictions on the amount of runway available for use in takeoff and landing that are not apparent from the reported physical length of the runway or from runway markings and lighting. The runway elements of Runway Safety Area (RSA), Runway Object Free Area (ROFA), and Runway Protection Zone (RPZ) may reduce a runway’s declared distances to less than the physical length of the runway at geographically constrained airports (See FIG ENR 1.1–6). When considering the amount of runway available for use in takeoff or landing performance calculations, the declared distances published for a runway must always be used in lieu of the runway’s physical length.

**REFERENCE–**

*AC 150/5300–13, Airport Design.*

**8.4.2.4** While some runway elements associated with declared distances may be identifiable through runway markings or lighting (for example, a displaced threshold or a stopway), the individual declared distance limits are not marked or otherwise identified on the runway. An aircraft is not prohibited from operating beyond a

declared distance limit during the takeoff, landing, or taxi operation provided the runway surface is appropriately marked as usable runway (See FIG ENR 1.1–6). The following examples clarify the intent of this paragraph.

**REFERENCE–**

*AIM, Runway Markings, Paragraph 2–3–3.*  
*AC 150/5340–1, Standards for Airport Markings.*

**EXAMPLE–**

**1.** *The declared LDA for runway 9 must be used when showing compliance with the landing distance requirements of the applicable airplane operating rules and/or airplane operating limitations or when making a before landing performance assessment. The LDA is less than the physical runway length, not only because of the displaced threshold, but also because of the subtractions necessary to meet the RSA beyond the far end of the runway. However, during the actual landing operation, it is permissible for the airplane to roll beyond the unmarked end of the LDA.*

**2.** *The declared ASDA for runway 9 must be used when showing compliance with the accelerate–stop distance requirements of the applicable airplane operating rules and/or airplane operating limitations. The ASDA is less than the physical length of the runway due to subtractions necessary to achieve the full RSA requirement. However, in the event of an aborted takeoff, it is permissible for the airplane to roll beyond the unmarked end of the ASDA as it is brought to a full–stop on the remaining usable runway.*

FIG ENR 1.1-5  
Declared Distances with Full-Standard Runway Safety Areas, Runway Object Free Areas, and Runway Protection Zones

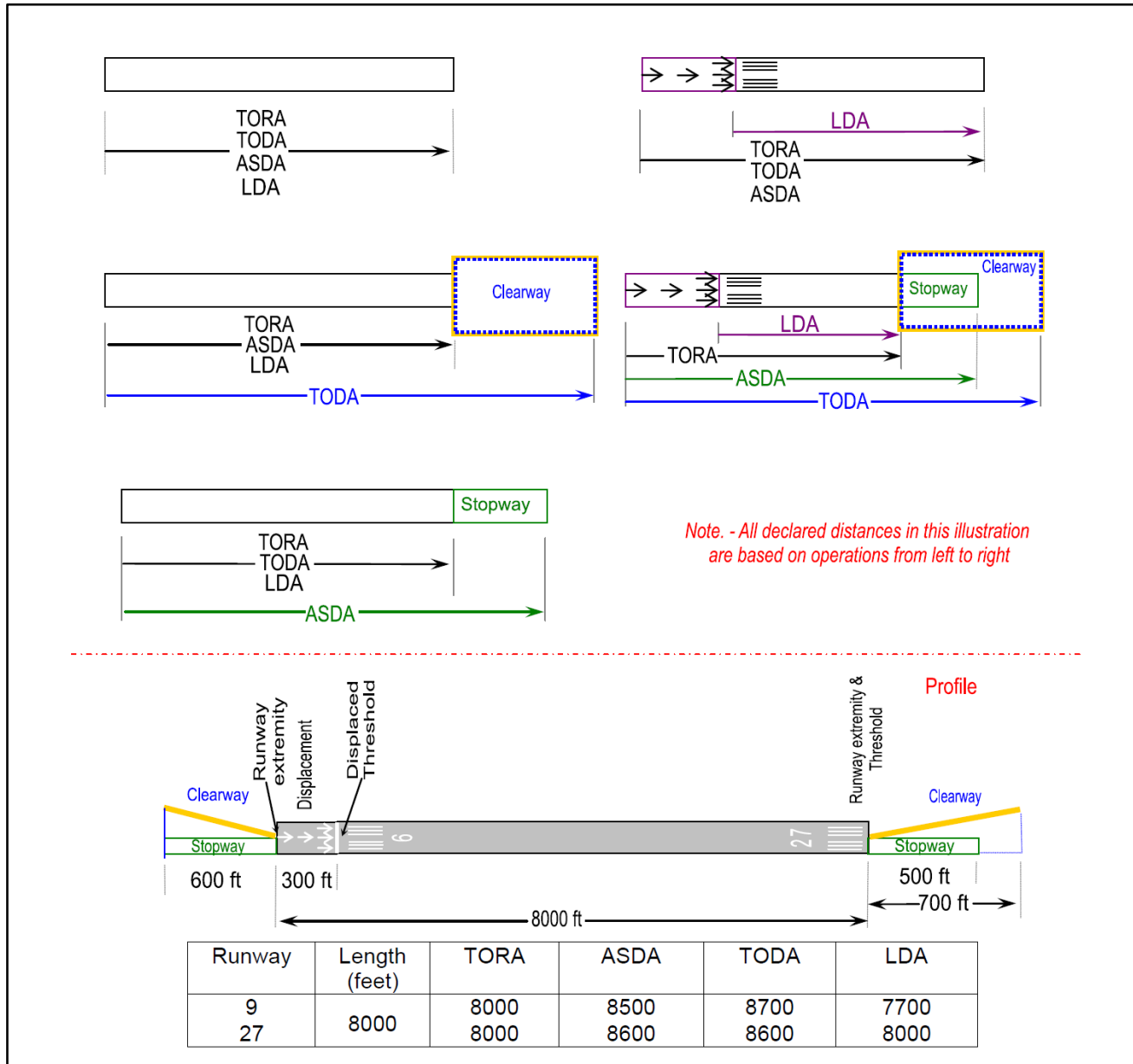
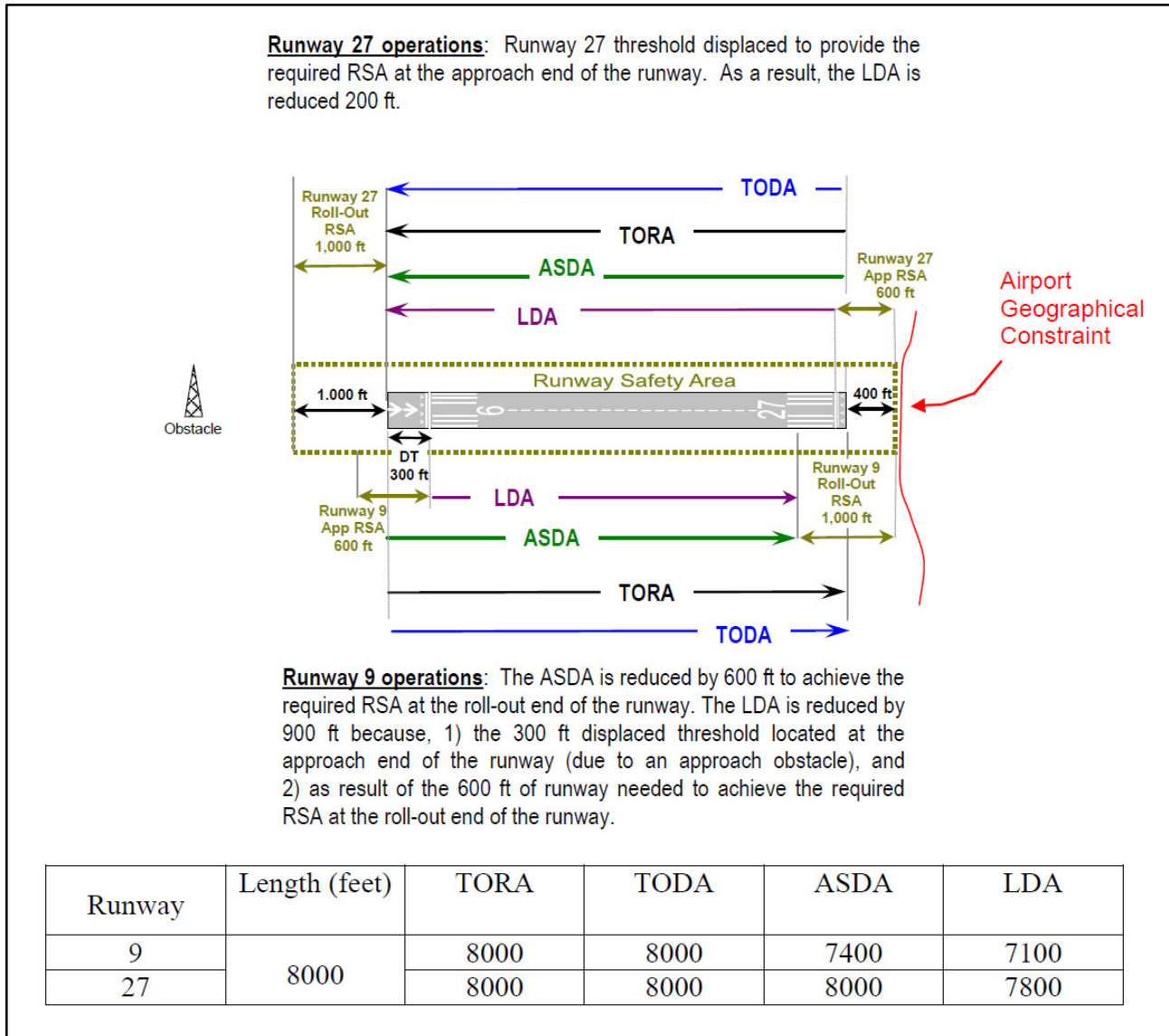


FIG ENR 1.1-6  
Effects of a Geographical Constraint on a Runway's Declared Distances



**NOTE-**

A runway's RSA begins a set distance prior to the threshold and will extend a set distance beyond the end of the runway depending on the runway's design criteria. If these required lengths cannot be achieved, the ASDA and/or LDA will be reduced as necessary to obtain the required lengths to the extent practicable.

**9. Low Level Wind Shear/Microburst Detection Systems**

**9.1** Low Level Wind Shear Alert System (LLWAS), Terminal Doppler Weather Radar (TDWR), Weather System Processor (WSP), and Integrated Terminal Weather System (ITWS) display information on hazardous wind shear and microburst activity in the vicinity of an airport to air traffic controllers who relay this information to pilots.

**9.1.1** LLWAS provides wind shear alert and gust front information but does not provide microburst alerts. The LLWAS is designed to detect low level wind shear conditions around the periphery of an airport. It does not detect wind shear beyond that limitation. Controllers will provide this information to pilots by giving the pilot the airport wind followed by the boundary wind.

**EXAMPLE–**

*Wind shear alert, airport wind 230 at 8, south boundary wind 170 at 20.*

**9.1.2** LLWAS “network expansion,” (LLWAS NE) and LLWAS Relocation/Sustainment (LLWAS–RS) are systems integrated with TDWR. These systems provide the capability of detecting microburst alerts and wind shear alerts. Controllers will issue the appropriate wind shear alerts or microburst alerts. In some of these systems controllers also have the ability to issue wind information oriented to the threshold or departure end of the runway.

**EXAMPLE–**

*Runway 17 arrival microburst alert, 40 knot loss 3 mile final.*

**NOTE–**

*Reference GEN 3.5, Paragraph 25, Microbursts.*

**9.1.3** More advanced systems are in the field or being developed such as ITWS. ITWS provides alerts for microbursts, wind shear, and significant thunderstorm activity. ITWS displays wind information oriented to the threshold or departure end of the runway.

**9.1.4** The WSP provides weather processor enhancements to selected Airport Surveillance Radar (ASR)–9 facilities. The WSP provides Air Traffic with detection and alerting of hazardous weather such as wind shear, microbursts, and significant thunderstorm activity. The WSP displays terminal area 6 level weather, storm cell locations and movement, as well as the location and predicted future position and intensity of wind shifts that may affect airport operations. Controllers will receive and issue alerts based on Areas Noted for Attention (ARENA). An ARENA extends on the runway center line from a 3 mile final to the runway to a 2 mile departure.

**9.1.5** An airport equipped with the LLWAS, ITWS, or WSP is so indicated in the Chart Supplement U.S. under Weather Data Sources for that particular airport.

## **10. Braking Action Reports and Advisories**

**10.1** When available, ATC furnishes pilots the quality of braking action received from pilots. The quality of braking action is described by the terms “good,” “good to medium,” “medium,” “medium to poor,” “poor,” and “nil.” When pilots report the quality of braking action by using the terms noted above, they should use descriptive terms that are easily understood, such as, “braking action poor the first/last half of the runway,” together with the particular type of aircraft.

**10.2** FICON NOTAMs will provide contaminant measurements for paved runways; however, a FICON NOTAM for braking action will only be used for non-paved runway surfaces, taxiways, and aprons. These NOTAMs are classified according to the most critical term (“good to medium,” “medium,” “medium to poor,” and “poor”).

**10.2.1** FICON NOTAM reporting of a braking condition for paved runway surfaces is not permissible by Federally Obligated Airports or those airports certificated under 14 CFR Part 139.

**10.2.2** A “NIL” braking condition at these airports must be mitigated by closure of the affected surface. Do not include the type of vehicle in the FICON NOTAM.

**10.3** When tower controllers receive runway braking action reports which include the terms medium, poor, or nil, or whenever weather conditions are conducive to deteriorating or rapidly changing runway braking conditions, the tower will include on the ATIS broadcast the statement, “*BRAKING ACTION ADVISORIES ARE IN EFFECT.*”

**10.4** During the time that braking action advisories are in effect, ATC will issue the most recent braking action report for the runway in use to each arriving and departing aircraft. Pilots should be prepared for deteriorating braking conditions and should request current runway condition information if not issued by controllers. Pilots should also be prepared to provide a descriptive runway condition report to controllers after landing.

## **11. Runway Condition Reports**

**11.1** Aircraft braking coefficient is dependent upon the surface friction between the tires on the aircraft wheels and the pavement surface. Less friction means less aircraft braking coefficient and less aircraft braking response.

**11.2** Runway condition code (RwyCC) values range from 1 (poor) to 6 (dry). For frozen contaminants on runway surfaces, a runway condition code reading of 4 indicates the level when braking deceleration or directional control is between good and medium.

**NOTE–**

*A RwyCC of “0” is used to delineate a braking action report of NIL and is prohibited from being reported in a FICON NOTAM.*

**11.3** Airport management should conduct runway condition assessments on wet runways or runways covered with compacted snow and/or ice.

**11.3.1** Numerical readings may be obtained by using the Runway Condition Assessment Matrix (RCAM). The RCAM provides the airport operator with data to complete the report that includes the following:

**11.3.1.1** Runway(s) in use

**11.3.1.2** Time of the assessment

**11.3.1.3** Runway condition codes for each zone (touchdown, mid–point, roll–out)

**11.3.1.4** Pilot–reported braking action report (if available)

**11.3.1.5** The contaminant (for example, wet snow, dry snow, slush, ice, etc.)

**11.3.2** Assessments for each zone (see 11.3.1.3) will be issued in the direction of takeoff and landing on the runway, ranging from “1” to “6” to describe contaminated surfaces.

**NOTE–**

*A RwyCC of “0” is used to delineate a braking action report of NIL and is prohibited from being reported in a FICON NOTAM.*

**11.3.3** When any 1 or more runway condition codes are reported as less than 6, airport management must notify ATC for dissemination to pilots.

**11.3.4** Controllers will not issue runway condition codes when all 3 segments of a runway are reporting values of 6.

**11.4** When runway condition code reports are provided by airport management, the ATC facility providing approach control or local airport advisory must provide the report to all pilots.

**11.5** Pilots should use runway condition code information with other knowledge including aircraft performance characteristics, type, and weight, previous experience, wind conditions, and aircraft tire type (such as bias ply vs. radial constructed) to determine runway suitability.

**11.6** The Runway Condition Assessment Matrix identifies the descriptive terms “good,” “good to medium,” “medium,” “medium to poor,” “poor,” and “nil” used in braking action reports.

**REFERENCE–**

*Advisory Circular AC 91–79A (Revision 1), Mitigating the Risks of a Runway Overrun Upon Landing, Appendix 1.*

FIG ENR 1.1-7  
Runway Condition Assessment Matrix (RCAM)

Assessment Criteria		Control/Braking Assessment Criteria	
Runway Condition Description	RwyCC	Deceleration or Directional Control Observation	Pilot Reported Braking Action
<ul style="list-style-type: none"> <li>Dry</li> </ul>	6	---	---
<ul style="list-style-type: none"> <li>Frost</li> <li>Wet (Includes damp and 1/8 inch depth or less of water)</li> </ul> <p><b>1/8 inch (3mm) depth or less of:</b></p> <ul style="list-style-type: none"> <li>Slush</li> <li>Dry Snow</li> <li>Wet Snow</li> </ul>	5	Braking deceleration is normal for the wheel braking effort applied AND directional control is normal.	Good
<p><b>-15°C and Colder outside air temperature:</b></p> <ul style="list-style-type: none"> <li>Compacted Snow</li> </ul>	4	Braking deceleration OR directional control is between Good and Medium.	Good to Medium
<ul style="list-style-type: none"> <li>Slippery When Wet (wet runway)</li> <li>Dry Snow or Wet Snow (any depth) over Compacted Snow</li> </ul> <p><b>Greater than 1/8 inch (3 mm) depth of:</b></p> <ul style="list-style-type: none"> <li>Dry Snow</li> <li>Wet Snow</li> </ul> <p><b>Warmer than -15°C outside air temperature:</b></p> <ul style="list-style-type: none"> <li>Compacted Snow</li> </ul>	3	Braking deceleration is noticeably reduced for the wheel braking effort applied OR directional control is noticeably reduced.	Medium
<p><b>Greater than 1/8 inch(3 mm) depth of:</b></p> <ul style="list-style-type: none"> <li>Water</li> <li>Slush</li> </ul>	2	Braking deceleration OR directional control is between Medium and Poor.	Medium to Poor
<ul style="list-style-type: none"> <li>Ice</li> </ul>	1	Braking deceleration is significantly reduced for the wheel braking effort applied OR directional control is significantly reduced.	Poor
<ul style="list-style-type: none"> <li>Wet Ice</li> <li>Slush over Ice</li> <li>Water over Compacted Snow</li> <li>Dry Snow or Wet Snow over Ice</li> </ul>	0	Braking deceleration is minimal to non-existent for the wheel braking effort applied OR directional control is uncertain.	Nil

## 12. Communications Prior to Departure

### 12.1 Nontower Controlled Airports

**12.1.1** At airports not served by a FSS located on the airport, the pilot in command should broadcast his/her intentions on the prescribed frequency prior to aircraft movement and departure.

**12.1.2** At airports served by a FSS located on the airport, the pilot in command should obtain airport advisory service prior to aircraft movement and departure.

**12.1.3** Aircraft departing on an IFR clearance must obtain the clearance prior to departure via telephone, the appropriate FSS, or via direct communications with the ATC facility issuing the clearance as appropriate. An IFR clearance does not relieve the pilot from the communication stated above prior to aircraft movement and departure.

## **12.2 Tower Controlled Airports**

**12.2.1** Pilots of departing aircraft should communicate with the control tower on the appropriate ground control/clearance delivery frequency prior to starting engines to receive engine start time, taxi, and/or clearance information. Unless otherwise advised by the tower, remain on the frequency during taxiing and run up, then change to local control frequency when ready to request takeoff clearance.

### **NOTE–**

*Refer to Automatic Terminal Information Service (ATIS) for continuous broadcast of terminal information.*

## **13. Gate Holding Due to Departure Delays**

**13.1** Pilots should contact ground control/clearance delivery prior to starting engines as gate hold procedures will be in effect whenever departure delays exceed or are anticipated to exceed 15 minutes. The sequence for departure will be maintained in accordance with initial call up unless modified by flow control restrictions. Pilots should monitor the ground control/clearance delivery frequency for engine startup advisories or new proposed start time if the delay changes.

**13.2** The tower controller will consider that pilots of turbine–powered aircraft are ready for takeoff when they reach the runway/warm–up block unless advised otherwise.

## **14. Taxiing**

**14.1 General.** Approval must be obtained prior to moving an aircraft or vehicle onto the movement area during the hours an airport traffic control tower is in operation.

**14.1.1** Always state your position on the airport when calling the tower for taxi instructions.

**14.1.2** The movement area is normally described in local bulletins issued by the airport manager or control tower. These bulletins may be found in FSSs, fixed base operators offices, air carrier offices, and operations offices.

**14.1.3** The control tower also issues bulletins describing areas where they cannot provide airport traffic control service due to nonvisibility or other reasons.

**14.1.4** A clearance must be obtained prior to taxiing on a runway, taking off, or landing during the hours an airport traffic control tower is in operation.

**14.1.5** A clearance must be obtained prior to crossing any runway. ATC will issue an explicit clearance for all runway crossings.

**14.1.6** When assigned a takeoff runway, ATC will first specify the runway, issue taxi instructions, and state any hold short instructions or runway crossing clearances if the taxi route will cross a runway. This does not authorize the aircraft to “enter” or “cross” the assigned departure runway at any point. In order to preclude misunderstandings in radio communications, ATC will not use the word “cleared” in conjunction with authorization for aircraft to taxi. **AIR TRAFFIC CONTROLLERS ARE REQUIRED TO OBTAIN A READBACK FROM THE PILOT OF ALL RUNWAY HOLD SHORT INSTRUCTIONS.**

**14.1.7** When issuing taxi instructions to any point other than an assigned takeoff runway, ATC will specify the point to taxi to, issue taxi instructions, and state any hold short instructions or runway crossing clearances if the taxi route will cross a runway.

**14.1.8** If a pilot is expected to hold short of a runway approach/departure (*Runway XX APPCH/Runway XX DEP*) hold area or ILS holding position (see FIG AD 1.1–24, Taxiways Located in Runway Approach Area, in Section AD 1.1, Aerodrome Availability), ATC will issue instructions.



**14.1.9** When taxi instructions are received from the controller, pilots should always read back:

**14.1.9.1** The runway assignment.

**14.1.9.2** Any clearance to enter a specific runway.

**14.1.9.3** Any instruction to hold short of a specific runway or line up and wait.

**14.1.10** Controllers are required to request a readback of runway hold short assignment when it is not received from the pilot/vehicle.

**14.2** ATC clearances or instructions pertaining to taxiing are predicated on known traffic and known physical airport conditions. Therefore, it is important that pilots clearly understand the clearance or instruction. Although an ATC clearance is issued for taxiing purposes, when operating in accordance with the Federal Regulations, it is the responsibility of the pilot to avoid collision with other aircraft. Since “the pilot in command of an aircraft is directly responsible for, and is the final authority as to, the operation of that aircraft” the pilot should obtain clarification of any clearance or instruction which is not understood.

**14.2.1** Good operating practice dictates that pilots acknowledge all runway crossing, hold short, or takeoff clearances unless there is some misunderstanding, at which time the pilot should query the controller until the clearance is understood. AIR TRAFFIC CONTROLLERS ARE REQUIRED TO OBTAIN FROM THE PILOT A READBACK OF ALL RUNWAY HOLD SHORT INSTRUCTIONS. Pilots operating a single pilot aircraft should monitor only assigned ATC communications after being cleared onto the active runway for departure. Single pilot aircraft should not monitor other than ATC communications until flight from Class D airspace is completed. This same procedure should be practiced from after receipt of the clearance for landing until the landing and taxi activities are complete. Proper effective scanning for other aircraft, surface vehicles, or other objects should be continuously exercised in all cases.

**14.2.2** If the pilot is unfamiliar with the airport or for any reason confusion exists as to the correct taxi routing, a request may be made for progressive taxi instructions which include step-by-step routing directions. Progressive instructions may also be issued if the controller deems it necessary due to traffic or field conditions (for example, construction or closed taxiways).

**14.3** At those airports where the United States Government operates the control tower and ATC has authorized noncompliance with the requirement for two-way radio communications while operating within Class D airspace, or at those airports where the United States Government does not operate the control tower and radio communications cannot be established, pilots must obtain a clearance by visual light signal prior to taxiing on a runway and prior to takeoff and landing.

**14.4** The following phraseologies and procedures are used in radio–telephone communications with aeronautical ground stations.

**14.4.1 Request for taxi instructions prior to departure.** State your aircraft identification, location, type of operation planned (VFR or IFR), and the point of first intended landing.

**EXAMPLE–**

**Aircraft:** “Washington ground, Beechcraft One Three One Five Niner at hangar eight, ready to taxi, I–F–R to Chicago.”

**Tower:** “Beechcraft One Three One Five Niner, Washington ground, runway two seven, taxi via taxiways Charlie and Delta, hold short of runway three three left.”

**Aircraft:** “Beechcraft One Three One Five Niner, runway two seven, hold short of runway three three left.”

**14.4.2 Receipt of Air Traffic Control Clearance.** Air route traffic control clearances are relayed to pilots by airport traffic controllers in the following manner:

**EXAMPLE–**

**Tower:** “Beechcraft One Three One Five Niner, cleared to the Chicago Midway Airport via Victor Eight, maintain eight thousand.”

**Aircraft:** “Beechcraft One Three One Five Niner, cleared to the Chicago Midway Airport via Victor Eight, maintain eight thousand.”

**NOTE–**

Normally, an ATC IFR clearance is relayed to a pilot by the ground controller. At busy locations, however, pilots may be instructed by the ground controller to “contact clearance delivery” on a frequency designated for this purpose. No surveillance or control over the movement of traffic is exercised by this position of operation. (See paragraph 27., ATC Clearances and Aircraft Separation.)

**14.4.3 Request for Taxi Instructions After Landing.** State your aircraft identification, location, and that you request taxi instructions.

**EXAMPLE–**

**Aircraft:** “Dulles ground, Beechcraft One Four Two Six One clearing runway one right on taxiway echo three, request clearance to Page.”

**Tower:** “Beechcraft One Four Two Six One, Dulles ground, taxi to Page via taxiways echo three, echo one, and echo niner.”

or

**Aircraft:** “Orlando ground, Beechcraft One Four Two Six One clearing runway one eight left at taxiway bravo three, request clearance to Page.”

**Tower:** “Beechcraft One Four Two Six One, Orlando ground, hold short of runway one eight right.”

**Aircraft:** “Beechcraft One Four Two Six One, hold short of runway one eight right.”

**14.5** During ground operations, jet blast, prop wash, and rotor wash can cause damage and upsets if encountered at close range. Pilots should consider the effects of jet blast, prop wash, and rotor wash on aircraft, vehicles, and maintenance equipment during ground operations.

## **15. Taxi During Low Visibility**

**15.1** Pilots and aircraft operators should be constantly aware that during certain low visibility conditions the movement of aircraft and vehicles on airports may not be visible to the tower controller. This may prevent visual confirmation of an aircraft’s adherence to taxi instructions.

**15.2** Of vital importance is the need for pilots to notify the controller when difficulties are encountered or at the first indication of becoming disoriented. Pilots should proceed with extreme caution when taxiing toward the sun. When vision difficulties are encountered, pilots should immediately inform the controller.

**15.3** Advisory Circular 120–57, Low Visibility Operations Surface Movement Guidance and Control System, commonly known as LVOSMGCS (pronounced “LVO SMIGS”) describes an adequate example of a low visibility taxi plan for any airport which has takeoff or landing operations in less than 1,200 feet runway visual range (RVR) visibility conditions. These plans, which affect aircrew and vehicle operators, may incorporate additional lighting, markings, and procedures to control airport surface traffic. They will be addressed at two levels; operations less than 1,200 feet RVR to 500 feet RVR and operations less than 500 feet RVR.

**NOTE–**

Specific lighting systems and surface markings may be found in Paragraph 14, Taxiway Lights, and Paragraph 18, Taxiway Markings, in Section AD 1.1, Aerodrome Availability.

**15.4** When low visibility conditions exist, pilots should focus their entire attention on the safe operation of the aircraft while it is moving. Checklists and nonessential communication should be withheld until the aircraft is stopped and the brakes set.

## **16. Intersection Takeoffs**

**16.1** In order to enhance airport capacities, reduce taxiing distances, minimize departure delays, and provide for more efficient movement of air traffic, controllers may initiate intersection takeoffs as well as approve them when

the pilot requests. If for ANY reason a pilot prefers to use a different intersection or the full length of the runway or desires to obtain the distance between the intersection and the runway end, THE PILOT IS EXPECTED TO INFORM ATC ACCORDINGLY.

**16.2** An aircraft is expected to taxi to (but not onto) the end of the assigned runway unless prior approval for an intersection departure is received from ground control.

**16.3** Pilots should state their position on the airport when calling the tower for takeoff from a runway intersection.

**EXAMPLE–**

*Cleveland Tower, Apache Three Seven Two Two Papa, at the intersection of taxiway oscar and runway two three right, ready for departure.*

**16.4** Controllers are required to separate small aircraft that are departing from an intersection on the same runway (same or opposite direction) behind a large nonheavy aircraft (except B757), by ensuring that at least a 3–minute interval exists between the time the preceding large aircraft has taken off and the succeeding small aircraft begins takeoff roll. The 3–minute separation requirement will also be applied to small aircraft with a maximum certificated takeoff weight of 12,500 pounds or less departing behind a small aircraft with a maximum certificated takeoff weight of more than 12,500 pounds. To inform the pilot of the required 3–minute hold, the controller will state, “Hold for wake turbulence.” If after considering wake turbulence hazards, the pilot feels that a lesser time interval is appropriate, the pilot may request a waiver to the 3–minute interval. To initiate such a request, simply say “Request waiver to 3–minute interval” or a similar statement. Controllers may then issue a takeoff clearance if other traffic permits, since the pilot has accepted the responsibility for wake turbulence separation.

**16.5** The 3–minute interval is not required when the intersection is 500 feet or less from the departure point of the preceding aircraft and both aircraft are taking off in the same direction. Controllers may permit the small aircraft to alter course after takeoff to avoid the flight path of the preceding departure.

**16.6** A 4–minute interval is mandatory for small, large, and heavy aircraft behind a super aircraft. The 3–minute interval is mandatory behind a heavy aircraft in all cases, and for small aircraft behind a B757.

## **17. VFR Flights in Terminal Areas**

**17.1** Use reasonable restraint in exercising the prerogative of VFR flight, especially in terminal areas. The weather minimums and distances from clouds are minimums. Giving yourself a greater margin in specific instances is just good judgment.

**17.1.1** Approach Area. Conducting a VFR operation in Class D and E Airspace when the official visibility is 3 or 4 miles is not prohibited, but good judgment would dictate that you keep out of the approach area.

**17.1.2** Reduced Visibility. It has always been recognized that precipitation reduces forward visibility. Consequently, although again it may be perfectly legal to cancel your IFR flight plan at any time you can proceed VFR, it is good practice, when precipitation is occurring, to continue IFR operation into a terminal area until you are reasonably close to your destination.

**17.1.3** Simulated Instrument Flights. In conducting simulated instrument flights, be sure that the weather is good enough to compensate for the restricted visibility of the safety pilot and your greater concentration on your flight instruments. Give yourself a greater margin when your flight plan lies in or near a busy airway or close to an airport.

## **18. Low Approach**

**18.1** A low approach (sometimes referred to as a low pass) is the go–around maneuver following approach. Instead of landing or making a touch–and–go, a pilot may wish to go around (low approach) in order to expedite a particular operation—a series of practice instrument approaches is an example of such an operation. Unless

otherwise authorized by ATC, the low approach should be made straight ahead with no turns or climb made until the pilot has made a thorough visual check for other aircraft in the area.

**18.2** When operating within Class D airspace, a pilot intending to make a low approach should contact the tower for approval. This request should be made prior to starting the final approach.

**18.3** When operating to an airport within Class E airspace, a pilot intending to make a low approach should, prior to leaving the final approach fix inbound (nonprecision approach) or the outer marker or fix used in lieu of the outer marker inbound (precision approach), so advise the FSS, UNICOM, or make a broadcast as appropriate.

## **19. Practice Instrument Approaches**

**19.1** Various air traffic incidents required adoption of measures to achieve more organized and controlled operations where practice instrument approaches are conducted. Practice instrument approaches are considered to be instrument approaches made by either a VFR aircraft not on an IFR flight plan or an aircraft on an IFR flight plan. To achieve this and thereby enhance air safety, it is Air Traffic Operations policy to provide for separation of such operations at locations where approach control facilities are located and, as resources permit, at certain other locations served by ARTCCs or approach control facilities. Pilot requests to practice instrument approaches may be approved by ATC subject to traffic and workload conditions. Pilots should anticipate that in some instances the controller may find it necessary to deny approval or withdraw previous approval when traffic conditions warrant. It must be clearly understood, however, that even though the controller may be providing separation, pilots on VFR flight plans are required to comply with basic visual flight rules (14 CFR Section 91.155). Application of ATC procedures or any action taken by the controller to avoid traffic conflicts does not relieve IFR and VFR pilots of their responsibility to see and avoid other traffic while operating in VFR conditions (14 CFR Section 91.113). In addition to the normal IFR separation minimums (which includes visual separation) during VFR conditions, 500 feet vertical separation may be applied between VFR aircraft and between a VFR aircraft and an IFR aircraft. Pilots not on IFR flight plans desiring practice instrument approaches should always state “practice” when making requests to ATC. Controllers will instruct VFR aircraft requesting an instrument approach to maintain VFR. This is to preclude misunderstandings between the pilot and controller as to the status of the aircraft. If the pilot wishes to proceed in accordance with instrument flight rules, he/she must specifically request and obtain an IFR clearance.

**19.2** Before practicing an instrument approach, pilots should inform the approach control facility or the tower of the type of practice approach they desire to make and how they intend to terminate it; i.e., full-stop landing, touch-and-go, or missed/low approach maneuver. This information may be furnished progressively when conducting a series of approaches. Pilots on an IFR flight plan, who have made a series of instrument approaches to full stop landings, should inform ATC when they make their final landing. The controller will control flights practicing instrument approaches so as to ensure that they do not disrupt the flow of arriving and departing itinerant IFR or VFR aircraft. The priority afforded itinerant aircraft over practice instrument approaches is not intended to be so rigidly applied that it causes a grossly inefficient application of services. A minimum delay to itinerant traffic may be appropriate to allow an aircraft practicing an approach to complete that approach.

### **NOTE–**

*A clearance to land means that appropriate separation on the landing runway will be ensured. A landing clearance does not relieve the pilot from compliance with any previously issued restriction.*

**19.3** At airports without a tower, pilots wishing to make practice instrument approaches should notify the facility having control jurisdiction of the desired approach as indicated on the approach chart. All approach control facilities and ARTCCs are required to publish a Letter to Airmen depicting those airports where they provide standard separation to both VFR and IFR aircraft conducting practice instrument approaches.

**19.4** The controller will provide approved separation between both VFR and IFR aircraft when authorization is granted to make practice approaches to airports where an approach control facility is located and to certain other airports served by approach control or an ARTCC. Controller responsibility for separation of VFR aircraft begins at the point where the approach clearance becomes effective or when the aircraft enters Class B or TRSA airspace whichever comes first.

**19.5** VFR aircraft practicing instrument approaches are not automatically authorized to execute the missed approach procedure. This authorization must be specifically requested by the pilot and approved by the controller. Where ATC procedures require application of IFR separation to VFR aircraft practicing instrument approaches, separation will be provided throughout the procedure including the missed approach. Where no separation services are provided during the practice approach, no separation services will be provided during the missed approach.

**19.6** Except in an emergency, aircraft cleared to practice instrument approaches must not deviate from the approved procedure until cleared to do so by the controller.

**19.7** At radar approach control locations when a full approach procedure (procedure turn, etc.) cannot be approved, pilots should expect to be vectored to a final approach course for a practice instrument approach which is compatible with the general direction of traffic at that airport.

**19.8** When granting approval for a practice instrument approach, the controller will usually ask the pilot to report to the tower prior to or over the final approach fix inbound (nonprecision approaches) or over the outer marker or fix used in lieu of the outer marker inbound (precision approaches).

**19.9** When authorization is granted to conduct practice instrument approaches to an airport with a tower but where approved standard separation is not provided to aircraft conducting practice instrument approaches, the tower will approve the practice approach, instruct the aircraft to maintain VFR, and issue traffic information, as required.

**19.10** When a pilot notifies an FSS providing Airport Advisory Service of intent to conduct a practice instrument approach and if separation will be provided, he/she will be instructed to contact the appropriate facility on a specified frequency prior to initiating the approach. At airports where separation is not provided, the FSS will acknowledge the message and issue known traffic information but will neither approve or disapprove the approach.

**19.11** Pilots conducting practice instrument approaches should be particularly alert for other aircraft operating in the local traffic pattern or in proximity to the airport.

## **20. Option Approach**

**20.1** The “Cleared for the Option” procedure will permit an instructor, flight examiner or pilot the option to make a touch-and-go, low approach, missed approach, stop-and-go, or full stop landing. This procedure can be very beneficial in a training situation in that neither the student pilot nor examinee would know what maneuver would be accomplished. The pilot should make a request for this procedure passing the final approach fix inbound on an instrument approach or entering downwind for a VFR traffic pattern. After ATC approval of the option, the pilot should inform ATC as soon as possible of any delay on the runway during their stop-and-go or full stop landing. The advantages of this procedure as a training aid are that it enables an instructor or examiner to obtain the reaction of a trainee or examinee under changing conditions, the pilot would not have to discontinue an approach in the middle of the procedure due to student error or pilot proficiency requirements, and finally it allows more flexibility and economy in training programs. This procedure will only be used at those locations with an operational control tower and will be subject to ATC approval.

## **21. Communications Release of IFR Aircraft Landing at an Airport Without an Operating Control Tower**

**21.1** Aircraft operating on an IFR flight plan, landing at an airport without an operating control tower will be advised to change to the airport advisory frequency when direct communication with ATC is no longer required.

## **22. Pilot Responsibilities When Conducting Land and Hold Short Operations (LAHSO)**

**22.1** LAHSO is an acronym for “Land And Hold Short Operations.” These operations include landing and holding short of an intersecting runway, an intersecting taxiway, or some other designated point on a runway other than an intersecting runway or taxiway. (See FIG ENR 1.1–8, FIG ENR 1.1–9, FIG ENR 1.1–10.)

## 22.2 Pilot Responsibilities and Basic Procedures

**22.2.1** LAHSO is an air traffic control procedure that requires pilot participation to balance the needs for increased airport capacity and system efficiency, consistent with safety. This procedure can be done safely provided pilots and controllers are knowledgeable and understand their responsibilities. The following paragraphs outline specific pilot/operator responsibilities when conducting LAHSO.

**22.2.2** At controlled airports, air traffic may clear a pilot to land and hold short. Pilots may accept such a clearance provided that the pilot-in-command determines that the aircraft can safely land and stop within the Available Landing Distance (ALD). ALD data are published in the special notices section of the Chart Supplement U.S. and in the U.S. Terminal Procedures Publications. Controllers will also provide ALD data upon request. Student pilots or pilots not familiar with LAHSO should not participate in the program.

FIG ENR 1.1-8  
**Land and Hold Short of an Intersecting Runway**

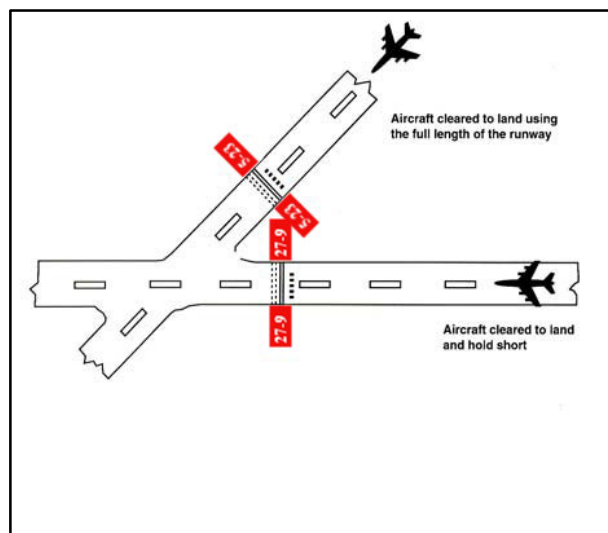
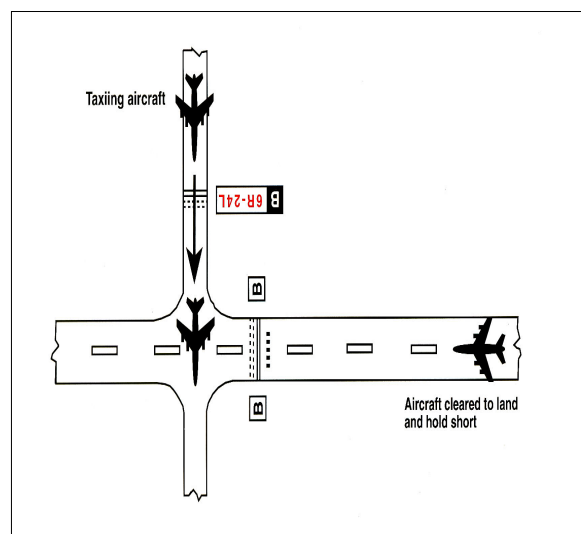


FIG ENR 1.1-9  
**Land and Hold Short of an Intersecting Taxiway**



**EXAMPLE-**  
FIG ENR 1.1-10 – Holding short at a designated point may be required to avoid conflicts with the runway safety area/flight path of a nearby runway.

**NOTE–**

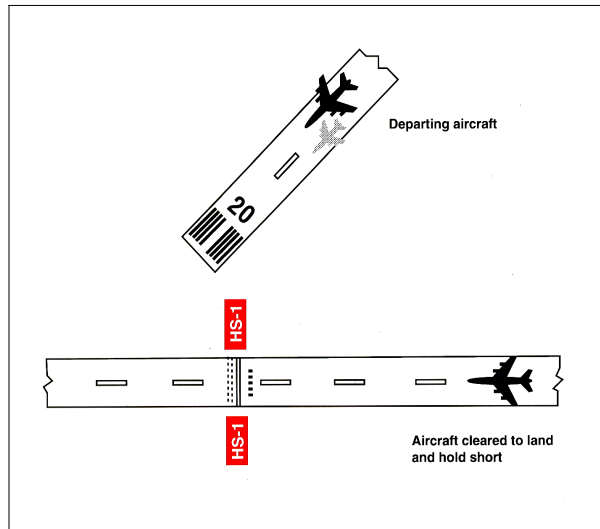
Each figure shows the approximate location of LAHSO markings, signage, and in-pavement lighting when installed.

**REFERENCE–**

AIP, Part 3 – Aerodromes.

FIG ENR 1.1–10

**Land and Hold Short of a Designated Point on a Runway Other Than an Intersecting Runway or Taxiway**



**22.2.3** The pilot-in-command has the final authority to accept or decline any land and hold short clearance. The safety and operation of the aircraft remain the responsibility of the pilot. Pilots are expected to decline a LAHSO clearance if they determine it will compromise safety.

**22.2.4** To conduct LAHSO, pilots should become familiar with all available information concerning LAHSO at their destination airport. Pilots should have, *readily available*, the published ALD and runway slope information for all LAHSO runway combinations at each airport of intended landing. Additionally, knowledge about landing performance data permits the pilot to *readily* determine that the ALD for the assigned runway is sufficient for safe LAHSO. As part of a pilot’s preflight planning process, pilots should determine if their destination airport has LAHSO. If so, their preflight planning process should include an assessment of which LAHSO combinations would work for them given their aircraft’s required landing distance. Good pilot decision-making is knowing in advance whether one can accept a LAHSO clearance if offered.

**22.2.5** For those airplanes flown with two crewmembers, effective intra-cockpit communication between cockpit crewmembers is also critical. There have been several instances where the pilot working the radios accepted a LAHSO clearance but then simply forgot to tell the pilot flying the aircraft.

**22.2.6** If, for any reason, such as difficulty in discerning the location of a LAHSO intersection, wind conditions, aircraft condition, etc., the pilot elects to request to land on the full length of the runway, to land on another runway, or to decline LAHSO, a pilot is expected to promptly inform ATC, ideally even before the clearance is issued. A LAHSO clearance, once accepted, must be adhered to, just as any other ATC clearance, unless an amended clearance is obtained or an emergency occurs. A LAHSO clearance does not preclude a rejected landing.

**22.2.7** A pilot who accepts a LAHSO clearance should land and exit the runway at the first convenient taxiway (unless directed otherwise) before reaching the hold short point. Otherwise, the pilot must stop and hold at the hold short point. If a rejected landing becomes necessary after accepting a LAHSO clearance, the pilot should maintain safe separation from other aircraft or vehicles, and should promptly notify the controller.

**22.2.8** Controllers need a full read back of all LAHSO clearances. Pilots should read back their LAHSO clearance and include the words, “HOLD SHORT OF (RUNWAY/TAXIWAY/OR POINT)” in their

acknowledgment of all LAHSO clearances. In order to reduce frequency congestion, pilots are encouraged to read back the LAHSO clearance without prompting. Don't make the controller have to ask for a read back!

### 22.3 LAHSO Situational Awareness

**22.3.1** Situational awareness is vital to the success of LAHSO. Situational awareness starts with having current airport information in the cockpit, readily accessible to the pilot. (An airport diagram assists pilots in identifying their location on the airport, thus reducing requests for “progressive taxi instructions” from controllers.)

**22.3.2** Situational awareness includes effective pilot–controller radio communication. ATC expects pilots to specifically acknowledge and read back all LAHSO clearances as follows:

**EXAMPLE–**

*ATC: “(Aircraft ID) cleared to land runway six right, hold short of taxiway bravo for crossing traffic (type aircraft).”*

*Aircraft: “(Aircraft ID), wilco, cleared to land runway six right to hold short of taxiway bravo.”*

*ATC: “(Aircraft ID) cross runway six right at taxiway bravo, landing aircraft will hold short.”*

*Aircraft: “(Aircraft ID), wilco, cross runway six right at bravo, landing traffic (type aircraft) to hold.”*

**22.3.3** Situational awareness also includes a thorough understanding of the airport markings, signage, and lighting associated with LAHSO. These visual aids consist of a three–part system of yellow hold–short markings, red and white signage and, in certain cases, in–pavement lighting. Visual aids assist the pilot in determining where to hold short. FIG ENR 1.1–8, FIG ENR 1.1–9, FIG ENR 1.1–10 depict how these markings, signage, and lighting combinations will appear once installed. Pilots are cautioned that not all airports conducting LAHSO have installed any or all of the above markings, signage, or lighting.

**22.3.4** Pilots should only receive a LAHSO clearance when there is a minimum ceiling of 1,000 feet and 3 statute miles visibility. The intent of having “basic” VFR weather conditions is to allow pilots to maintain visual contact with other aircraft and ground vehicle operations. Pilots should consider the effects of prevailing inflight visibility (such as landing into the sun) and how it may affect overall situational awareness. Additionally, surface vehicles and aircraft being taxied by maintenance personnel may also be participating in LAHSO, especially in those operations that involve crossing an active runway.

## 23. Exiting the Runway after Landing

**23.1** The following procedures must be followed after landing and reaching taxi speed.

**23.1.1** Exit the runway without delay at the first available taxiway or on a taxiway as instructed by ATC. Pilots must not exit the landing runway onto another runway unless authorized by ATC. At airports with an operating control tower, pilots should not stop or reverse course on the runway without first obtaining ATC approval.

**23.1.2** Taxi clear of the runway unless otherwise directed by ATC. An aircraft is considered clear of the runway when all parts of the aircraft are past the runway edge and there are no restrictions to its continued movement beyond the runway holding position markings. In the absence of ATC instructions, the pilot is expected to taxi clear of the landing runway by taxiing beyond the runway holding position markings associated with the landing runway, even if that requires the aircraft to protrude into or cross another taxiway or ramp area. Once all parts of the aircraft have crossed the runway holding position markings, the pilot must hold unless further instructions have been issued by ATC.

**NOTE–**

**1.** The tower will issue the pilot instructions which will permit the aircraft to enter another taxiway, runway, or ramp area when required.

**2.** Guidance contained in subparagraphs 23.1.1 and 23.1.2 above is considered an integral part of the landing clearance and satisfies the requirement of 14 CFR Section 91.129.

**23.1.3** Immediately change to ground control frequency when advised by the tower and obtain a taxi clearance.

**NOTE–**

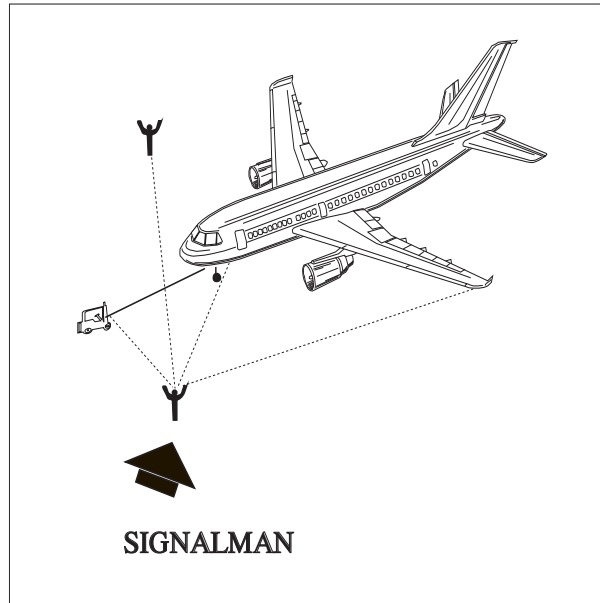
**1.** The tower will issue instructions required to resolve any potential conflicts with other ground traffic prior to advising the pilot to contact ground control.



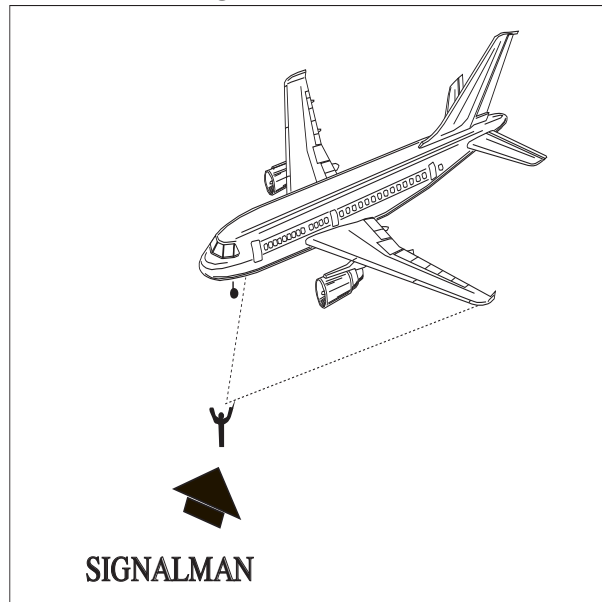
2. Ground control will issue taxi clearance to parking. That clearance does not authorize the aircraft to “enter” or “cross” any runways. Pilots not familiar with the taxi route should request specific taxi instructions from ATC.

## 24. Hand Signals

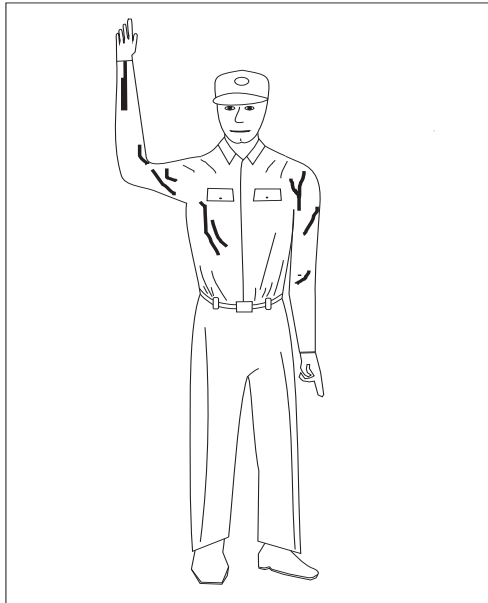
**FIG ENR 1.1-11**  
**Signalman Directs Towing**



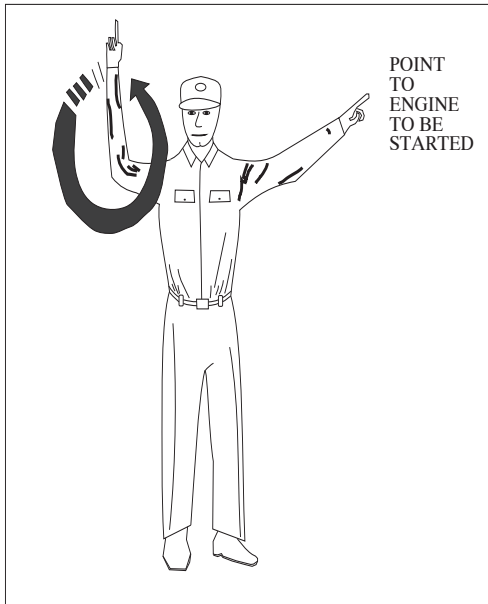
**FIG ENR 1.1-12**  
**Signalman's Position**



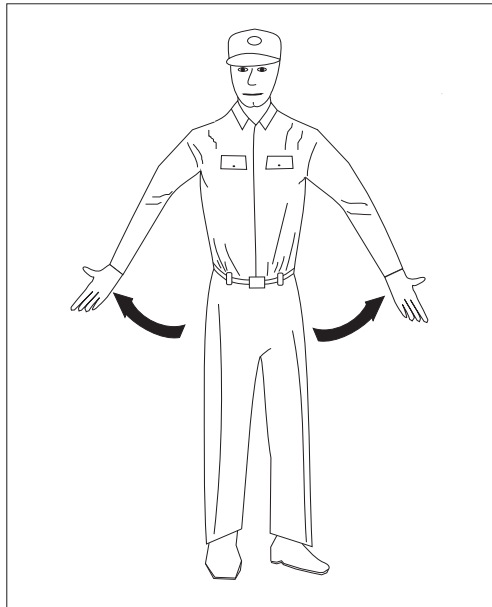
**FIG ENR 1.1-13**  
**All Clear**  
**(O.K.)**



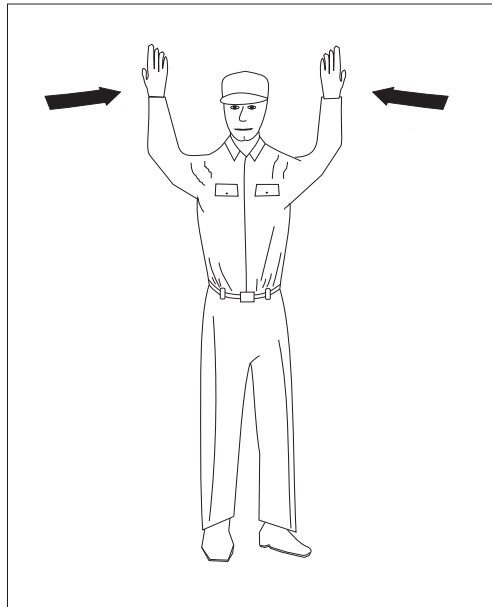
**FIG ENR 1.1-14**  
**Start Engine**



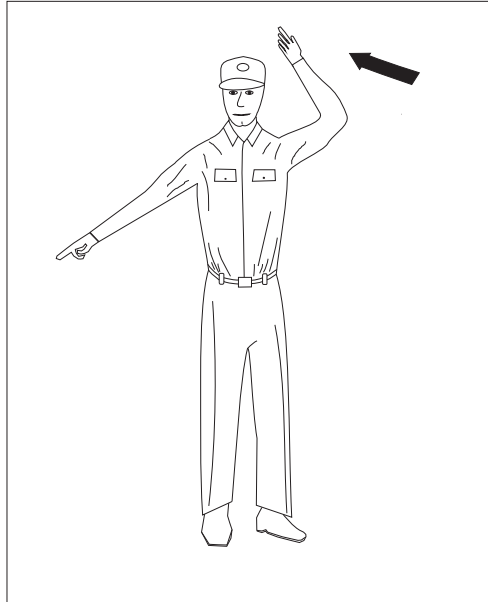
**FIG ENR 1.1-15**  
**Pull Checks**



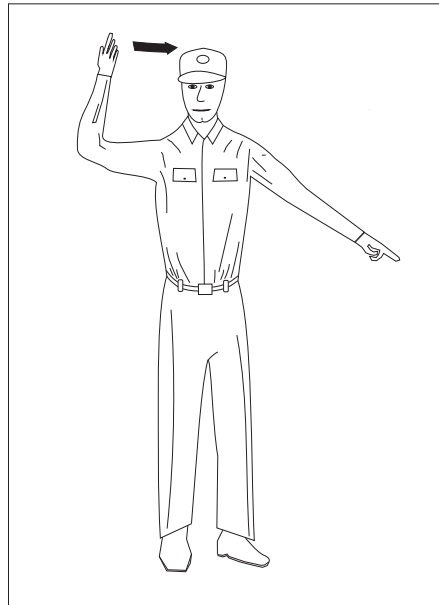
**FIG ENR 1.1-16**  
**Proceed Straight Ahead**



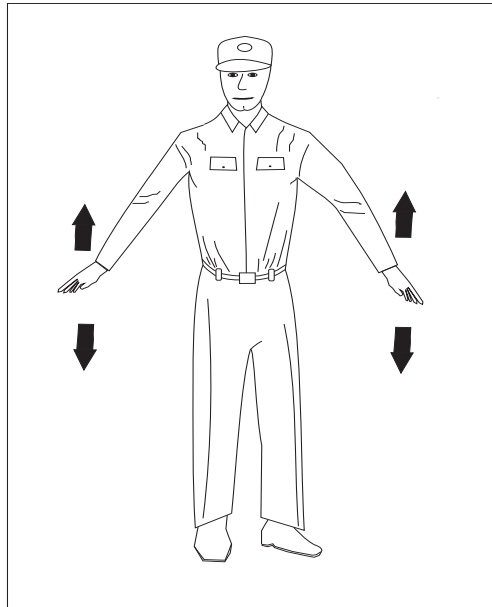
**FIG ENR 1.1-17**  
**Left Turn**



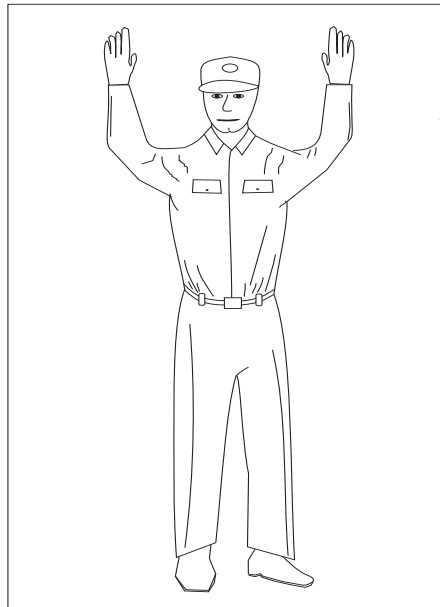
**FIG ENR 1.1-18**  
**Right Turn**



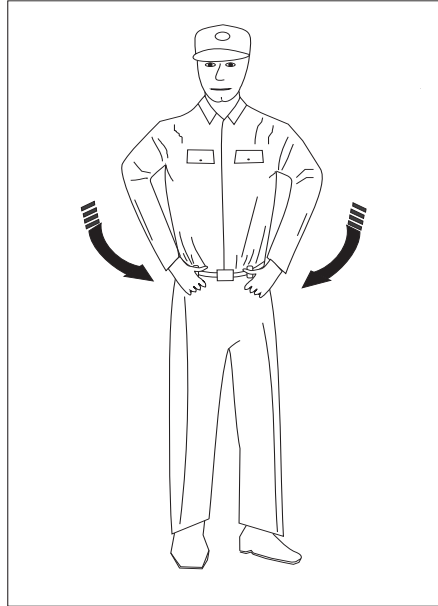
**FIG ENR 1.1-19**  
**Slow Down**



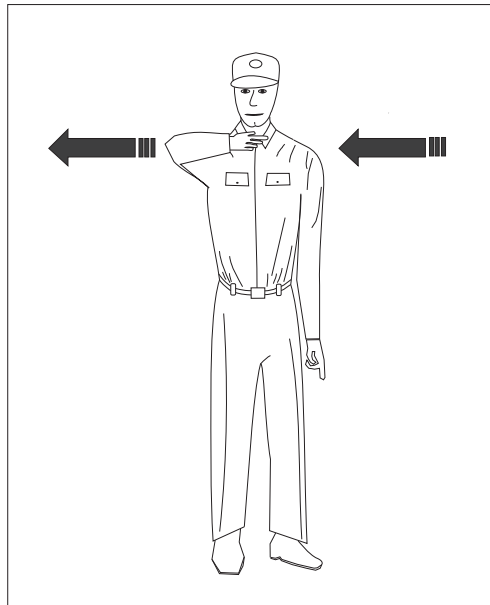
**FIG ENR 1.1-20**  
**Flagman Directs Pilot**



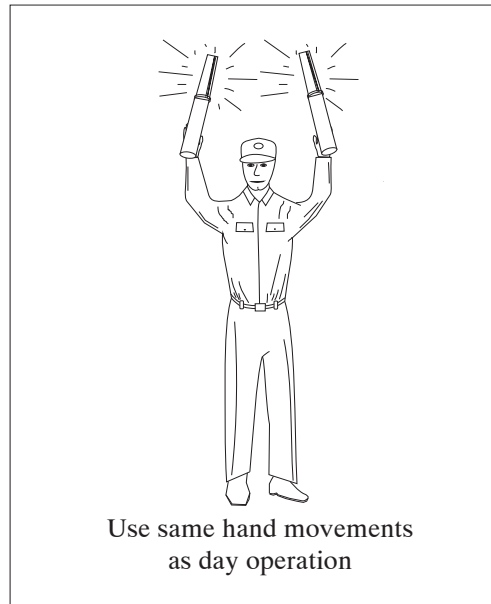
**FIG ENR 1.1-21**  
**Insert Chocks**



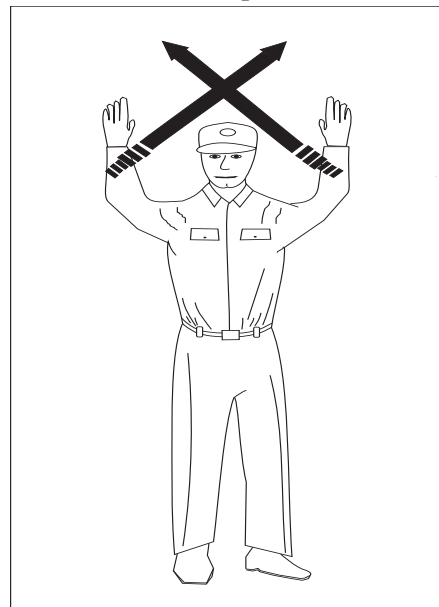
**FIG ENR 1.1-22**  
**Cut Engines**



**FIG ENR 1.1-23**  
**Night Operation**



**FIG ENR 1.1-24**  
**Stop**



## 25. Use of Aircraft Lights

**25.1** Aircraft position lights are required to be lighted on aircraft operated on the surface and in flight from sunset to sunrise. In addition, aircraft equipped with an anti-collision light system are required to operate that light system during all types of operations (day and night). However, during any adverse meteorological conditions, the pilot-in-command may determine that the anti-collision lights should be turned off when their light output would constitute a hazard to safety (14 CFR Section 91.209). Supplementary strobe lights should be turned off on the ground when they adversely affect ground personnel or other pilots, and in flight when there are adverse reflection from clouds.

**25.2** An aircraft anti-collision light system can use one or more rotating beacons and/or strobe lights, be colored either red or white, and have different (higher than minimum) intensities when compared to other aircraft. Many aircraft have both a rotating beacon and a strobe light system.

**25.3** The FAA has a voluntary pilot safety program, *Operation Lights On*, to enhance the see-and-avoid concept. Pilots are encouraged to turn on their landing lights during takeoff; i.e., either after takeoff clearance has been received or when beginning takeoff roll. Pilots are further encouraged to turn on their landing lights when operating below 10,000 feet, day or night, especially when operating within 10 miles of any airport or in conditions of reduced visibility and in areas where flocks of birds may be expected; i.e., coastal areas, lake areas, around refuse dumps, etc. Although turning on aircraft lights does enhance the see-and-avoid concept, pilots should not become complacent about keeping a sharp lookout for other aircraft. Not all aircraft are equipped with lights, and some pilots may not have their lights turned on. Aircraft manufacturers' recommendations for operation of landing lights and electrical systems should be observed.

**25.4** Prop and jet blast forces generated by large aircraft have overturned or damaged several smaller aircraft taxiing behind them. To avoid similar results and in the interest of preventing upsets and injuries to ground personnel from such forces, the FAA recommends that air carriers and commercial operators turn on their rotating beacons anytime their aircraft engines are in operation. General aviation pilots using rotating beacon-equipped aircraft are also encouraged to participate in this program which is designed to alert others to the potential hazard. Since this is a voluntary program, exercise caution and do not rely solely on the rotating beacon as an indication that aircraft engines are in operation.

**25.5** Prior to commencing taxi, it is recommended to turn on navigation, position, anti-collision, and logo lights (if equipped). To signal intent to other pilots, consider turning on the taxi light when the aircraft is moving or intending to move on the ground, and turning it off when stopped or yielding to other ground traffic. Strobe lights should not be illuminated during taxi if they will adversely affect the vision of other pilots or ground personnel.

**25.6** At the discretion of the pilot-in-command, all exterior lights should be illuminated when taxiing on or across any runway. This increases the conspicuity of the aircraft to controllers and other pilots approaching to land, taxiing, or crossing the runway. Pilots should comply with any equipment operating limitations and consider the effects of landing and strobe lights on other aircraft in their vicinity.

**25.7** When entering the departure runway for takeoff or to "line up and wait," all lights, except for landing lights, should be illuminated to make the aircraft conspicuous to ATC and other aircraft on approach. Landing lights should be turned on when takeoff clearance is received or when commencing takeoff roll at an airport without an operating control tower.

## **26. Flight Inspection/"Flight Check" Aircraft in Terminal Areas**

**26.1** "Flight Check" is a call sign used to alert pilots and air traffic controllers when an FAA aircraft is engaged in flight inspection/certification of NAVAIDs and flight procedures. Flight check aircraft fly preplanned high/low altitude flight patterns such as grids, orbits, DME arcs, and tracks, including low passes along the full length of the runway to verify NAVAID performance.

**26.2** Pilots should be especially watchful and avoid the flight paths of any aircraft using the call sign "Flight Check." These flights will normally receive special handling from ATC. Pilot patience and cooperation in allowing uninterrupted recordings can significantly help expedite flight inspections, minimize costly, repetitive runs, and reduce the burden on the U.S. taxpayer.

## **27. ATC Clearances and Aircraft Separation**

### **27.1 Clearance**

**27.1.1** A clearance issued by ATC is predicated on known traffic and known physical airport conditions. An ATC clearance means an authorization by ATC, for the purpose of preventing collision between known aircraft, for an aircraft to proceed under specified conditions within Classes A, B, C, D, and E airspace. IT IS NOT



AUTHORIZATION FOR A PILOT TO DEVIATE FROM ANY RULE, REGULATION OR MINIMUM ALTITUDE NOR TO CONDUCT UNSAFE OPERATION OF THE AIRCRAFT.

**27.1.2** 14 CFR Section 91.3(a) states: “The pilot in command of an aircraft is directly responsible for, and is the final authority as to, the operation of that aircraft.” If ATC issues a clearance that would cause a pilot to deviate from a rule or regulation, or in the pilot’s opinion, would place the aircraft in jeopardy, **IT IS THE PILOT’S RESPONSIBILITY TO REQUEST AN AMENDED CLEARANCE.** Similarly, if a pilot prefers to follow a different course of action, such as make a 360–degree turn for spacing to follow traffic when established in a landing or approach sequence, land on a different runway, takeoff from a different intersection, takeoff from the threshold instead of an intersection, or delay operation, **THE PILOT IS EXPECTED TO INFORM ATC ACCORDINGLY.** When the pilot requests a different course of action, however, the pilot is expected to cooperate so as to preclude the disruption of the traffic flow or the creation of conflicting patterns. The pilot is also expected to use the appropriate aircraft call sign to acknowledge all ATC clearances, frequency changes, or advisory information.

**27.1.3** Each pilot who deviates from an ATC clearance in response to a traffic alert and collision avoidance system resolution advisory must notify ATC of that deviation as soon as possible.

**27.1.4** When weather conditions permit, during the time an IFR flight is operating, it is the direct responsibility of the pilot to avoid other aircraft since VFR flights may be operating in the same area without the knowledge of ATC, and traffic clearances provide standard separation only between IFR flights.

## **27.2 Clearance Prefix**

A clearance, information, or request for information originated by an ATC facility and relayed to the pilot through an air/ground communication station will be prefixed by “ATC CLEARS,” “ATC ADVISES,” or “ATC REQUESTS.”

## **27.3 Clearance Items**

**27.3.1** An ATC clearance normally contains the following:

**27.3.1.1 Clearance Limit.** The traffic clearance issued prior to departure will normally authorize flight to the airport of intended landing. Many airports and associated NAVAIDs are collocated with the same name and/or identifier, so care should be exercised to ensure a clear understanding of the clearance limit. When the clearance limit is the airport of intended landing, the clearance should contain the airport name followed by the word “airport.” Under certain conditions, a clearance limit may be a NAVAID or other fix. When the clearance limit is a NAVAID, intersection, or waypoint and the type is known, the clearance should contain type. Under certain conditions at some locations, a short–range clearance procedure is utilized whereby a clearance is issued to a fix within or just outside the terminal area, and pilots are advised of the frequency on which they will receive the long–range clearance direct from the center controller.

**27.3.1.2 Departure Procedure.** Headings to fly and altitude restrictions may be issued to separate a departure from other air traffic in the terminal area. Where the volume of traffic warrants, instrument departure procedures (DPs) have been developed. (See ENR 1.5.)

### **27.3.1.3 Route of Flight**

a) Clearances are normally issued for the altitude/flight level and route filed by the pilot. However, due to traffic conditions, it is frequently necessary for ATC to specify an altitude/flight level or route different from that requested by the pilot. In addition, flow patterns have been established in certain congested areas, or between congested areas, whereby traffic capacity is increased by routing all traffic on preferred routes. Information on these flow patterns is available in offices where preflight briefing is furnished or where flight plans are accepted.

b) When required, air traffic clearances include data to assist pilots in identifying radio reporting points. It is the responsibility of a pilot to notify ATC immediately if the radio equipment cannot receive the type of signals the pilot must utilize to comply with the clearance.

### **27.3.1.4 Altitude Data**

a) The altitude/flight level instructions in an ATC clearance normally require that a pilot “MAINTAIN” the altitude/flight level to which the flight will operate when in Classes A, B, C, D, and E airspace. Altitude/flight level changes while en route should be requested prior to the time the change is desired.

b) When possible, if the altitude assigned is different than that requested by the pilot, ATC will inform an aircraft when to expect climb or descent clearance or to request altitude change from another facility. If this has not been received prior to crossing the boundary of the ATC facility’s area and assignment at a different flight level is still desired, the pilot should reinitiate the request with the next facility.

c) The term “CRUISE” may be used instead of “MAINTAIN” to assign a block of airspace, to a pilot, from the minimum IFR altitude up to and including the altitude specified in the cruise clearance. The pilot may level off at any intermediate altitude within this block of airspace. Climb/descent within the block is to be made at the discretion of the pilot. However, once the pilot starts descent and verbally reports leaving an altitude in the block, the pilot may not return to that altitude without additional ATC clearance.

## 27.4 Amended Clearances

27.4.1 Amendments to the initial clearance will be issued at any time an air traffic controller deems such action necessary to avoid possible conflict between aircraft. Clearances will require that a flight “hold” or change altitude prior to reaching the point where standard separation from other IFR traffic would no longer exist.

### NOTE–

*Some pilots have questioned this action and requested “traffic information” and were at a loss when the reply indicated “no traffic reported.” In such cases the controller has taken action to prevent a traffic conflict which would have occurred at a distant point.*

27.4.2 A pilot may wish an explanation of the handling of the flight at the time of occurrence; however, controllers are not able to take time from their immediate control duties, nor can they afford to overload the ATC communications channels to furnish explanations. Pilots may obtain an explanation by directing a letter or telephone call to the chief controller of the facility involved.

27.4.3 Pilots have the privilege of requesting a different clearance from that which has been issued by ATC if they feel that they have information which would make another course of action more practicable or if aircraft equipment limitations or company procedures forbid compliance with the clearance issued.

27.4.4 Pilots should pay particular attention to the clearance and not assume that the route and altitude/flight level are the same as requested in the flight plan. It is suggested that pilots make a written report of clearances at the time they are received, and verify, by a repeat back, any portions that are complex or about which a doubt exists. It will be the responsibility of each pilot to accept or refuse the clearance issued.

## 27.5 Special VFR Clearance

27.5.1 An ATC clearance must be obtained *prior* to operating within a Class B, Class C, Class D, and Class E surface area when the weather is less than that required for VFR flight. A VFR pilot may request and be given a clearance to enter, leave or operate within most Class D and Class E surface areas and some Class B and Class C surface areas in special VFR conditions, traffic permitting, and providing such flight will not delay IFR operations. All special VFR flights must remain clear of clouds. The visibility requirements for Special VFR aircraft (other than helicopters) are:

27.5.1.1 At least one statute mile flight visibility for operations within Classes B, C, D, and E surface areas.

27.5.1.2 At least one statute mile ground visibility if taking off or landing. If ground visibility is not reported at that airport, the flight visibility must be at least one statute mile.

27.5.1.3 The restrictions in subparagraphs 27.5.1.1 and 27.5.1.2 do not apply to helicopters. Helicopters must remain clear of clouds and may operate in Classes B, C, D, and E surface areas with less than one statute mile visibility.

27.5.2 When a control tower is located within a Class B, Class C, and Class D surface area, requests for clearances should be to the tower. If no tower is located within the surface area, a clearance may be obtained from the nearest tower, FSS or ARTCC.

**27.5.3** It is not necessary to file a complete flight plan with the request for clearance, but pilots should state their intentions in sufficient detail to permit ATC to fit their flight into the traffic flow. The clearance will not contain a specific altitude as the pilot must remain clear of clouds. The controller may require the pilot to fly at or below a certain altitude due to other traffic, but the altitude specified will permit flight at or above the minimum safe altitude. In addition, at radar locations, flight may be vectored if necessary for control purposes or on pilot request.

**NOTE–**

*The pilot is responsible for obstacle or terrain clearance (reference 14 CFR Section 91.119).*

**27.5.4** Special VFR clearances are effective within Classes B, C, D, and E surface areas only. ATC does not provide separation after an aircraft leaves Class D surface area on a special VFR clearance.

**27.5.5** Special VFR operations by fixed-wing aircraft are prohibited in some Classes B and C surface areas due to the volume of IFR traffic. A list of these Classes B and C surface areas is contained in 14 CFR Part 91, Appendix D, Section 3 and also depicted on Sectional Aeronautical Charts.

**27.5.6** ATC provides separation between special VFR flights and between them and other IFR flights.

**27.5.7** Special VFR operations by fixed-wing aircraft are prohibited between sunset and sunrise unless the pilot is instrument rated and the aircraft is equipped for IFR flight.

**27.5.8** Pilots arriving or departing an uncontrolled airport that has automated weather broadcast capability (ASOS/AWOS) should monitor the broadcast frequency, advise the controller that they have the “one-minute weather,” and state intentions prior to operating within the Class B, Class C, Class D, or Class E surface areas.

**NOTE–**

*One-minute weather is the most recent one minute updated weather broadcast received by a pilot from an uncontrolled airport ASOS/AWOS.*

## **28. Pilot Responsibilities Upon Clearance Issuance**

**28.1 Record ATC Clearance.** When conducting an IFR operation, make a written record of your ATC clearance. The specified conditions which are a part of your air traffic clearance may be somewhat different from those included in your flight plan. Additionally, ATC may find it necessary to ADD conditions, such as a particular departure route. The very fact that ATC specifies different or additional conditions means that other aircraft are involved in the traffic situation.

**28.2 ATC Clearance/Instruction Readback.** Pilots of airborne aircraft should read back *those parts* of ATC clearances and instructions containing altitude assignments, vectors, or runway assignments as a means of mutual verification. The read back of the “numbers” serves as a double check between pilots and controllers and reduces the kinds of communications errors that occur when a number is either “misheard” or is incorrect.

**28.2.1** Include the aircraft identification in all readbacks and acknowledgments. This aids controllers in determining that the correct aircraft received the clearance or instruction. The requirement to include aircraft identification in all readbacks and acknowledgments becomes more important as frequency congestion increases and when aircraft with similar call signs are on the same frequency.

**EXAMPLE–**

*“Climbing to Flight Level three three zero, United Twelve” or “November Five Charlie Tango, roger, cleared to land runway nine left.”*

**28.2.2** Read back altitudes, altitude restrictions, and vectors in the same sequence as they are given in the clearance/instruction.

**28.2.3** Altitudes contained in charted procedures such as DPs, instrument approaches, etc., should not be read back unless they are specifically stated by the controller.

**28.2.4** Initial read back of a taxi, departure or landing clearance should include the runway assignment, including left, right, center, etc. if applicable.

**28.3** It is the responsibility of the pilot to accept or refuse the clearance issued.

## **29. IFR Clearance VFR–On–Top**

**29.1** A pilot on an IFR flight plan operating in VFR weather conditions, may request VFR–on–top in lieu of an assigned altitude. This would permit pilots to select an altitude or flight level of their choice (subject to any ATC restrictions).

**29.2** Pilots desiring to climb through a cloud, haze, smoke, or other meteorological formation and then either cancel their IFR flight plan or operate VFR–on–top may request a climb to VFR–on–top. The ATC authorization must contain either a top report or a statement that no top report is available, and a request to report reaching VFR–on–top. Additionally, the ATC authorization may contain a clearance limit, routing and an alternative clearance if VFR–on–top is not reached by a specified altitude.

**29.3** A pilot on an IFR flight plan operating in VFR conditions may request to climb/descend in VFR conditions.

**29.4** ATC may not authorize VFR–on–top/VFR conditions operations unless the pilot requests the VFR operation or a clearance to operate in VFR conditions will result in noise abatement benefits where part of the IFR departure route does not conform to an FAA approved noise abatement route or altitude.

**29.5** When operating in VFR conditions with an ATC authorization to “maintain VFR–on–top” or “maintain VFR conditions,” pilots on IFR flight plans must:

**29.5.1** Fly at the appropriate VFR altitude as prescribed in 14 CFR Section 91.159.

**29.5.2** Comply with the VFR visibility and distance from cloud criteria in 14 CFR Section 91.155 (Basic VFR Weather Minimums).

**NOTE–**

*See AIP, GEN 1.7, Annex 2, Rules of the Air, for a table showing basic VFR weather minimums.*

**29.5.3** Comply with instrument flight rules that are applicable to this flight; i.e., minimum IFR altitude, position reporting, radio communications, course to be flown, adherence to ATC clearance, etc. Pilots should advise ATC prior to any altitude change to ensure the exchange of accurate traffic information.

**29.6** ATC authorization to “maintain VFR–on–top” is not intended to restrict pilots so that they must operate only above an obscuring meteorological formation (layer). Instead, it permits operation above, below, between layers or in areas where there is no meteorological obscuration. It is imperative that clearance to operate “VFR–on–top/VFR conditions” does not imply cancellation of the IFR flight plan.

**29.7** Pilots operating VFR–on–top/VFR conditions may receive traffic information from ATC on other pertinent IFR or VFR aircraft. However, aircraft operating in Class B or Class C airspace and TRSAs must be separated as required by FAA Order JO 7110.65, Air Traffic Control.

**NOTE–**

*When operating in VFR weather conditions, it is the pilot’s responsibility to be vigilant so as to see and avoid other aircraft.*

## **30. VFR/IFR Flights**

**30.1** A pilot departing VFR, either intending to or needing to obtain an IFR clearance en route, must be aware of the position of the aircraft and the relative terrain/obstructions. When accepting a clearance below the minimum en route altitude (MEA)/minimum IFR altitude (MIA)/minimum vector altitude (MVA)/off route obstruction clearance altitude (OROCA), pilots are responsible for their own terrain/obstruction clearance until reaching the MEA/MIA/MVA/OROCA. If the pilots are unable to maintain terrain/obstruction clearance, the controller should be advised and pilots should state their intentions. Pilots are reminded that on composite VFR to IFR flight plan, or on an IFR clearance, while flying unpublished departures via RNAV into uncontrolled airspace, the PIC is responsible for terrain and obstruction clearance until reaching the MEA/MIA/MVA/OROCA.

**NOTE–**

*OROCA is a published altitude which provides 1,000 feet of terrain and obstruction clearance in the US (2,000 feet of clearance in designated mountainous areas). These altitudes are not assessed for NAVAID signal coverage, air traffic control surveillance, or communications coverage, and are published for general situational awareness, flight planning and in-flight contingency use.*

**31. Adherence to Clearance**

**31.1** When air traffic clearance has been obtained under either the Visual or Instrument Flight Rules, the pilot in command of the aircraft must not deviate from the provisions thereof unless an amended clearance is obtained. When ATC issues a clearance or instruction, pilots are expected to execute its provisions upon receipt. ATC, in certain situations, will include the word “IMMEDIATELY” in a clearance or instruction to impress urgency of an imminent situation, and expeditious compliance by the pilot is expected and necessary for safety. The addition of a VFR or other restriction; i.e., climb or descent point or time, crossing altitude, etc., does not authorize a pilot to deviate from the route of flight or any other provision of the ATC clearance.

**31.2** When a heading is assigned or a turn is requested by ATC, pilots are expected to promptly initiate the turn, to complete the turn, and to maintain the new heading unless issued additional instructions.

**31.3** The term “at pilot’s discretion” included in the altitude information of an ATC clearance means that ATC has offered the pilot the option to start climb or descent when the pilot wishes, is authorized to conduct the climb or descent at any rate, and to temporarily level off at any intermediate altitude as desired. However, once the aircraft has vacated an altitude, it may not return to that altitude.

**31.4** When ATC has not used the term “AT PILOT’S DISCRETION” nor imposed any climb or descent restrictions, pilots should initiate climb or descent promptly on acknowledgement of the clearance. Descend or climb at an optimum rate consistent with the operating characteristics of the aircraft to 1,000 feet above or below the assigned altitude, and then attempt to descend or climb at a rate of between 500 and 1,500 fpm until the assigned altitude is reached. If at anytime the pilot is unable to climb or descend at a rate of at least 500 feet a minute, advise ATC. If it is necessary to level off at an intermediate altitude during climb or descent, advise ATC, except when leveling off at 10,000 feet MSL on descent, or 2,500 feet above airport elevation (prior to entering a Class C or Class D surface area), when required for speed reduction (14 CFR Section 91.117).

**NOTE–**

*Leveling off at 10,000 feet MSL on descent or 2,500 feet above airport elevation (prior to entering a Class C or Class D surface area) to comply with 14 CFR Section 91.117 airspeed restrictions is commonplace. Controllers anticipate this action and plan accordingly. Leveling off at any other time on climb or descent may seriously affect air traffic handling by ATC. Consequently, it is imperative that pilots make every effort to fulfill the above expected actions to aid ATC in safely handling and expediting traffic.*

**31.5** If the altitude information of an ATC DESCENT clearance includes a provision to “CROSS (fix) AT” or “AT OR ABOVE/BELOW (altitude),” the manner in which the descent is executed to comply with the crossing altitude is at the pilot’s discretion. This authorization to descend at pilot’s discretion is only applicable to that portion of the flight to which the crossing altitude restriction applies, and the pilot is expected to comply with the crossing altitude as a provision of the clearance. Any other clearance in which pilot execution is optional will so state: “AT PILOT’S DISCRETION.”

**EXAMPLE–**

1. “United Four Seventeen, descend and maintain six thousand.”

**NOTE–**

1. *The pilot is expected to commence descent upon receipt of the clearance and to descend at the suggested rates until reaching the assigned altitude of 6,000 feet.*

**EXAMPLE–**

2. “United Four Seventeen, descend at pilot’s discretion, maintain six thousand.”

**NOTE–**

2. *The pilot is authorized to conduct descent within the context of the term at pilot’s discretion as described above.*

**EXAMPLE-**

3. “United Four Seventeen, cross Lakeview V-O-R at or above Flight Level two zero zero, descend and maintain six thousand.”

**NOTE-**

3. The pilot is authorized to conduct descent at pilot’s discretion until reaching Lakeview VOR and must comply with the clearance provision to cross the Lakeview VOR at or above FL 200. After passing Lakeview VOR, the pilot is expected to descend at the suggested rates until reaching the assigned altitude of 6,000 feet.

**EXAMPLE-**

4. “United Four Seventeen, cross Lakeview V-O-R at six thousand, maintain six thousand.”

**NOTE-**

4. The pilot is authorized to conduct descent at pilot’s discretion, however, must comply with the clearance provision to cross the Lakeview VOR at 6,000 feet.

**EXAMPLE-**

5. “United Four Seventeen, descend now to Flight Level two seven zero, cross Lakeview V-O-R at or below one zero thousand, descend and maintain six thousand.”

**NOTE-**

5. The pilot is expected to promptly execute and complete descent to FL 270 upon receipt of the clearance. After reaching FL 270 the pilot is authorized to descend “at pilot’s discretion” until reaching Lakeview VOR. The pilot must comply with the clearance provision to cross Lakeview VOR at or below 10,000 feet. After Lakeview VOR the pilot is expected to descend at the suggested rates until reaching 6,000 feet.

**EXAMPLE-**

6. “United Three Ten, descend now and maintain Flight Level two four zero, pilot’s discretion after reaching Flight Level two eight zero.”

**NOTE-**

6. The pilot is expected to commence descent upon receipt of the clearance and to descend at the suggested rates until reaching FL 280. At that point, the pilot is authorized to continue descent to FL 240 within the context of the term “at pilot’s discretion” as described above.

**31.6** In case emergency authority is used to deviate from the provisions of an ATC clearance, the pilot in command must notify ATC as soon as possible and obtain an amended clearance. In an emergency situation which results in no deviation from the rules prescribed in 14 CFR Part 91 but which requires ATC to give priority to an aircraft, the pilot of such aircraft must, when requested by ATC, make a report within 48 hours of such emergency situation to the manager of that ATC facility.

**31.7** The guiding principle is that the last ATC clearance has precedence over the previous ATC clearance. When the route or altitude in a previously issued clearance is amended, the controller will restate applicable altitude restrictions. If altitude to maintain is changed or restated, whether prior to departure or while airborne, and previously issued altitude restrictions are omitted, those altitude restrictions are canceled, including Departure Procedures and Standard Terminal Arrival Route (STAR) altitude restrictions.

**EXAMPLE-**

1. A departure flight receives a clearance to destination airport to maintain FL 290. The clearance incorporates a DP which has certain altitude crossing restrictions. Shortly after takeoff, the flight receives a new clearance changing the maintaining FL from 290 to 250. If the altitude restrictions are still applicable, the controller restates them.

2. A departing aircraft is cleared to cross Fluky Intersection at or above 3,000 feet, Gordonville VOR at or above 12,000 feet, maintain FL 200. Shortly after departure, the altitude to be maintained is changed to FL 240. If the altitude restrictions are still applicable, the controller issues an amended clearance as follows: “cross Fluky Intersection at or above three thousand, cross Gordonville V-O-R at or above one two thousand, maintain Flight Level two four zero.”

3. An arriving aircraft is cleared to the destination airport via V45 Delta VOR direct; the aircraft is cleared to cross Delta VOR at 10,000 feet, and then to maintain 6,000 feet. Prior to Delta VOR, the controller issues an amended clearance as follows: “turn right heading one eight zero for vector to runway three six I-L-S approach, maintain six thousand.”

**NOTE-**

Because the altitude restriction “cross Delta V-O-R at 10,000 feet” was omitted from the amended clearance, it is no longer in effect.

**31.8** Pilots of turbojet aircraft equipped with afterburner engines should advise ATC prior to takeoff if they intend to use afterburning during their climb to the en route altitude. Often, the controller may be able to plan traffic to accommodate a high performance climb and allow the aircraft to climb to the planned altitude without restriction.

**31.9** If an “expedite” climb or descent clearance is issued by ATC, and the altitude to maintain is subsequently changed or restated without an expedite instruction, the expedite instruction is canceled. Expedite climb/descent normally indicates to the pilot that the approximate best rate of climb/descent should be used without requiring an exceptional change in aircraft handling characteristics. Normally controllers will inform pilots of the reason for an instruction to expedite.

## **32. IFR Separation Standards**

**32.1** ATC effects separation of aircraft vertically by assigning different altitudes; longitudinally by providing an interval expressed in time or distance between aircraft on the same, converging, or crossing courses; and laterally by assigning different flight paths.

**32.2** Separation will be provided between all aircraft operating on IFR flight plans except during that part of the flight (outside Class B airspace or a TRSA) being conducted on a VFR–on–top/VFR conditions clearance. Under these conditions, ATC may issue traffic advisories, but it is the sole responsibility of the pilot to be vigilant so as to see and avoid other aircraft.

**32.3** When radar is employed in the separation of aircraft at the same altitude, a minimum of 3 miles separation is provided between aircraft operating within 40 miles of the radar antenna site, and 5 miles between aircraft operating beyond 40 miles from the antenna site. These minimums may be increased or decreased in certain specific situations.

## **33. Speed Adjustments**

**33.1** ATC will issue speed adjustments to pilots of radar–controlled aircraft to achieve or maintain appropriate spacing. If necessary, ATC will assign a speed when approving deviations or radar vectoring off procedures that include published speed restrictions. If no speed is assigned, speed becomes pilot’s discretion. However, when the aircraft reaches the end of the STAR, the last published speed on the STAR must be maintained until ATC deletes it, assigns a new speed, issues a vector, assigns a direct route, or issues an approach clearance.

**33.2** ATC will express all speed adjustments in terms of knots based on indicated airspeed (IAS) in 5 or 10 knot increments except that at or above FL 240 speeds may be expressed in terms of Mach numbers in 0.01 increments. The use of Mach numbers is restricted to turbojet aircraft with Mach meters.

**33.3** Pilots of aircraft in U.S. domestic Class A, B, C, D, and E airspace complying with speed adjustments (published or assigned) should maintain a speed within plus or minus 10 knots or 0.02 Mach number, whichever is less, of the assigned speed.

**33.4** Pilots of aircraft in offshore controlled airspace or oceanic controlled airspace must adhere to the ATC assigned airspeed and must request ATC approval before making any change thereto. If it is essential to make an immediate temporary change in the Mach number (e.g., due to turbulence), ATC must be notified as soon as possible. If it is not feasible to maintain the last assigned Mach number during an en route climb or descent due to aircraft performance, advise ATC at the time of the request.

**33.5** When ATC assigns speed adjustments, it will be in accordance with the following recommended minimums:

**33.5.1** To aircraft operating between FL 280 and 10,000 feet, a speed not less than 250 knots or the equivalent Mach number.

### **NOTE–**

**1.** On a standard day the Mach numbers equivalent to 250 knots CAS (subject to minor variations) are:

FL 240-0.6  
FL 250-0.61  
FL 260-0.62  
FL 270-0.64  
FL 280-0.65  
FL 290-0.66.

2. When an operational advantage will be realized, speeds lower than the recommended minima may be applied.

**33.5.2** To arriving turbojet aircraft operating below 10,000 feet, a speed not less than 210 knots, except within 20 flying miles of the airport of intended landing, a speed not less than 170 knots.

**33.5.3** To arriving reciprocating engine or turboprop aircraft within 20 flying miles of the runway threshold of the airport of intended landing, a speed not less than 150 knots.

**33.5.4** Departures, for turbojet aircraft, a speed not less than 230 knots; for reciprocating engine aircraft, a speed not less than 150 knots.

**33.6** When ATC combines a speed adjustment with a descent clearance, the sequence of delivery with the word “then” between, indicates the expected order of execution; i.e., “DESCEND AND MAINTAIN (altitude); THEN, REDUCE SPEED TO (speed),” or “REDUCE SPEED TO (speed); THEN, DESCEND AND MAINTAIN (altitude).”

**NOTE-**

*The maximum speeds below 10,000 feet as established in 14 CFR Section 91.117 still apply. If there is any doubt concerning the manner in which such a clearance is to be executed, request clarification from ATC.*

**33.7** If ATC determines (before an approach clearance is issued) that it is no longer necessary to apply speed adjustment procedures, they will:

**33.7.1** Advise the pilot to “resume normal speed.” Normal speed is used to terminate ATC assigned speed adjustments on segments where no published speed restrictions apply. It does not cancel published restrictions on upcoming procedures. This does not relieve the pilot of those speed restrictions which are applicable to 14 CFR Section 91.117.

**EXAMPLE-**

*(An aircraft is flying a SID with no published speed restrictions. ATC issues a speed adjustment and instructs the aircraft where the adjustment ends): “Maintain two two zero knots until BALTR then resume normal speed.”*

**NOTE-**

*The ATC assigned speed assignment of two two zero knots would apply until BALTR. The aircraft would then resume a normal operating speed while remaining in compliance with 14 CFR Section 91.117.*

**33.7.2** Instruct pilots to “comply with speed restrictions” when the aircraft is joining or resuming a charted procedure or route with published speed restrictions.

**EXAMPLE-**

*(ATC vectors an aircraft off of a SID to rejoin the procedure at a subsequent waypoint. When instructing the aircraft to resume the procedure, ATC also wants the aircraft to comply with the published procedure speed restrictions): “Resume the SALTY ONE departure. Comply with speed restrictions.”*

**CAUTION-**

*The phraseology “Descend via/Climb via SID” requires compliance with all altitude and/or speed restrictions depicted on the procedure.*

**33.7.3** Instruct the pilot to “resume published speed.” Resume published speed is issued to terminate a speed adjustment where speed restrictions are published on a charted procedure.

**NOTE-**

*When instructed to “comply with speed restrictions” or to “resume published speed,” ATC anticipates pilots will begin adjusting speed the minimum distance necessary prior to a published speed restriction so as to cross the waypoint/fix at the published speed. Once at the published speed, ATC expects pilots will maintain the published speed until additional adjustment is required to comply with further published or ATC assigned speed restrictions or as required to ensure compliance with 14 CFR Section 91.117.*



**EXAMPLE-**

*(An aircraft is flying a SID/STAR with published speed restrictions. ATC issues a speed adjustment and instructs the aircraft where the adjustment ends): “Maintain two two zero knots until BALTR then resume published speed.”*

**NOTE-**

*The ATC assigned speed assignment of two two zero knots would apply until BALTR. The aircraft would then comply with the published speed restrictions.*

**33.7.4** Advise the pilot to “delete speed restrictions” when either ATC assigned or published speed restrictions on a charted procedure are no longer required.

**EXAMPLE-**

*(An aircraft is flying a SID with published speed restrictions designed to prevent aircraft overtake on departure. ATC determines there is no conflicting traffic and deletes the speed restriction): “Delete speed restrictions.”*

**NOTE-**

*When deleting published restrictions, ATC must ensure obstacle clearance until aircraft are established on a route where no published restrictions apply. This does not relieve the pilot of those speed restrictions which are applicable to 14 CFR Section 91.117.*

**33.7.5** Instruct the pilot to “climb via” or “descend via.” A climb via or descend via clearance cancels any previously issued speed restrictions and, once established on the depicted departure or arrival, to climb or descend, and to meet all published or assigned altitude and/or speed restrictions.

**EXAMPLE-**

**1.** *(An aircraft is flying a SID with published speed restrictions. ATC has issued a speed restriction of 250 knots for spacing. ATC determines that spacing between aircraft is adequate and desires the aircraft to comply with published restrictions): “United 436, Climb via SID.”*

**2.** *(An aircraft is established on a STAR. ATC must slow an aircraft for the purposes of spacing and assigns it a speed of 280 knots. When spacing is adequate, ATC deletes the speed restriction and desires that the aircraft comply with all published restrictions on the STAR): “Gulfstream two three papa echo, descend via the TYLER One arrival.”*

**NOTE-**

**1.** *In example 1, when ATC issues a “Climb via SID” clearance, it deletes any previously issued speed and/or altitude restrictions. The pilot should then vertically navigate to comply with all speed and/or altitude restrictions published on the SID.*

**2.** *In example 2, when ATC issues a “Descend via <STAR name> arrival,” ATC has canceled any previously issued speed and/or altitude restrictions. The pilot should vertically navigate to comply with all speed and/or altitude restrictions published on the STAR.*

**CAUTION-**

*When descending on a STAR, pilots should not speed up excessively beyond the previously issued speed. Otherwise, adequate spacing between aircraft descending on the STAR that was established by ATC with the previous restriction may be lost.*

**33.8** Approach clearances supersede any prior speed adjustment assignments, and pilots are expected to make their own speed adjustments as necessary to complete the approach. However, under certain circumstances, it may be necessary for ATC to issue further speed adjustments after approach clearance is issued to maintain separation between successive arrivals. Under such circumstances, previously issued speed adjustments will be restated if that speed is to be maintained or additional speed adjustments are requested. Speed adjustments should not be assigned inside the final approach fix on final or a point 5 miles from the runway, whichever is closer to the runway.

**33.9** The pilots retain the prerogative of rejecting the application of speed adjustment by ATC if the minimum safe airspeed for any particular operation is greater than the speed adjustment. IN SUCH CASES, PILOTS ARE EXPECTED TO ADVISE ATC OF THE SPEED THAT WILL BE USED.

**33.10** Pilots are reminded that they are responsible for rejecting the application of speed adjustment by ATC if, in their opinion, it will cause them to exceed the maximum indicated airspeed prescribed by 14 CFR Section 91.117(a), (c) and (d). IN SUCH CASES, THE PILOT IS EXPECTED TO SO INFORM ATC. Pilots operating at or above 10,000 feet MSL who are issued speed adjustments which exceed 250 knots IAS and are subsequently cleared below 10,000 feet MSL are expected to comply with 14 CFR Section 91.117(a).

**33.11** Speed restrictions of 250 knots do not apply to U.S. registered aircraft operating beyond 12 nautical miles from the coastline within the U.S. Flight Information Region, in Class E airspace below 10,000 feet MSL. However, in airspace underlying a Class B airspace area designated for an airport, or in a VFR corridor designated through such as a Class B airspace area, pilots are expected to comply with the 200 knot speed limit specified in 14 CFR Section 91.117(c).

**33.12** For operations in a Class C and Class D surface area, ATC is authorized to request or approve a speed greater than the maximum indicated airspeeds prescribed for operation within that airspace (14 CFR Section 91.117(b)).

**NOTE-**

*Pilots are expected to comply with the maximum speed of 200 knots when operating beneath Class B airspace or in a Class B VFR corridor (14 CFR Section 91.117(c) and (d)).*

**33.13** When in communication with the ARTCC or approach control facility, pilots should, as a good operating practice, state any ATC assigned speed restriction on initial radio contact associated with an ATC communications frequency change.

## **34. Runway Separation**

**34.1** Tower controllers establish the sequence of arriving and departing aircraft by requiring them to adjust flight or ground operation as necessary to achieve proper spacing. They may “HOLD” an aircraft short of the runway to achieve spacing between it and another arriving aircraft; the controller may instruct a pilot to “EXTEND DOWNWIND” in order to establish spacing from another arriving or departing aircraft. At times a clearance may include the word “IMMEDIATE.” For example: “CLEARED FOR IMMEDIATE TAKEOFF.” In such cases “IMMEDIATE” is used for purposes of air traffic separation. It is up to the pilot to refuse the clearance if, in the pilot’s opinion, compliance would adversely affect the operation.

## **35. Visual Separation**

**35.1** Visual separation is a means employed by ATC to separate aircraft in terminal areas and en route airspace. There are two methods employed to effect this separation:

**35.1.1** The tower controller sees the aircraft involved and issues instructions, as necessary, to ensure that the aircraft avoid each other.

**35.1.2** A pilot sees the other aircraft involved and upon instructions from the controller provides separation by maneuvering the aircraft to avoid it. When pilots accept responsibility to maintain visual separation, they must maintain constant visual surveillance and not pass the other aircraft until it is no longer a factor.

**NOTE-**

*Traffic is no longer a factor when during approach phase the other aircraft is in the landing phase of flight or executes a missed approach; and during departure or en route, when the other aircraft turns away or is on a diverging course.*

**35.2** A pilot’s acceptance of instructions to follow another aircraft or provide visual separation from it is an acknowledgment that the pilot will maneuver the aircraft as necessary to avoid the other aircraft or to maintain in-trail separation. In operations conducted behind heavy aircraft, or a small aircraft behind a B757 or other large aircraft, it is also an acknowledgment that the pilot accepts the responsibility for wake turbulence separation. Visual separation is prohibited behind super aircraft.

**NOTE-**

*When a pilot has been told to follow another aircraft or to provide visual separation from it, the pilot should promptly notify the controller if visual contact with the other aircraft is lost or cannot be maintained or if the pilot cannot accept the responsibility for the separation for any reason.*

**35.3** Scanning the sky for other aircraft is a key factor in collision avoidance. Pilots and copilots (or the right seat passenger) should continuously scan to cover all areas of the sky visible from the cockpit. Pilots must develop an effective scanning technique which maximizes one’s visual capabilities. Spotting a potential collision

threat increases directly as more time is spent looking outside the aircraft. One must use timesharing techniques to effectively scan the surrounding airspace while monitoring instruments as well.

**35.4** Since the eye can focus only on a narrow viewing area, effective scanning is accomplished with a series of short, regularly spaced eye movements that bring successive areas of the sky into the central visual field. Each movement should not exceed ten degrees, and each area should be observed for at least one second to enable collision detection. Although many pilots seem to prefer the method of horizontal back-and-forth scanning every pilot should develop a scanning pattern that is not only comfortable but assures optimum effectiveness. Pilots should remember, however, that they have a regulatory responsibility (14 CFR Section 91.113) to see and avoid other aircraft when weather conditions permit.

## **36. Use of Visual Clearing Procedures and Scanning Techniques**

**36.1 Before Takeoff.** Prior to taxiing onto a runway or landing area in preparation for takeoff, pilots should scan the approach areas for possible landing traffic, executing appropriate clearing maneuvers to provide them a clear view of the approach areas.

**36.2 Climbs and Descents.** During climbs and descents in flight conditions which permit visual detection of other traffic, pilots should execute gentle banks, left and right at a frequency which permits continuous visual scanning of the airspace about them.

**36.3 Straight and Level.** Sustained periods of straight and level flight in conditions which permit visual detection of other traffic should be broken at intervals with appropriate clearing procedures to provide effective visual scanning.

**36.4 Traffic Patterns.** Entries into traffic patterns while descending create specific collision hazards and should be avoided.

**36.5 Traffic at VOR Sites.** All operators should emphasize the need for sustained vigilance in the vicinity of VORs and airway intersections due to the convergence of traffic.

**36.6 Training Operations.** Operators of pilot training programs are urged to adopt the following practices:

**36.6.1** Pilots undergoing flight instruction at all levels should be requested to verbalize clearing procedures (call out, “Clear” left, right, above, or below) to instill and sustain the habit of vigilance during maneuvering.

**36.6.2 High-wing Airplane.** Momentarily raise the wing in the direction of the intended turn and look.

**36.6.3 Low-wing Airplane.** Momentarily lower the wing in the direction of the intended turn and look.

**36.6.4** Appropriate clearing procedures should precede the execution of all turns including chandelles, lazy eights, stalls, slow flight, climbs, straight and level, spins, and other combination maneuvers.

### **36.7 Scanning Techniques for Traffic Avoidance.**

**36.7.1** Pilots must be aware of the limitations inherent in the visual scanning process. These limitations may include:

**36.7.1.1** Reduced scan frequency due to concentration on flight instruments or tablets and distraction with passengers.

**36.7.1.2** Blind spots related to high-wing and low-wing aircraft in addition to windshield posts and sun visors.

**36.7.1.3** Prevailing weather conditions including reduced visibility and the position of the sun.

**36.7.1.4** The attitude of the aircraft will create additional blind spots.

**36.7.1.5** The physical limitations of the human eye, including the time required to (re)focus on near and far objects, from the instruments to the horizon for example; empty field myopia, narrow field of vision and atmospheric lighting all affect our ability to detect another aircraft.

**36.7.2** Best practices to see and avoid:

**36.7.2.1** ADS-B In is an effective system to help pilots see and avoid other aircraft. If your aircraft is equipped with ADS-B In, it is important to understand its features and how to use it properly. Many units provide visual and/or audio alerts to supplement the system’s traffic display. Pilots should incorporate the traffic display in their normal traffic scan to provide awareness of nearby aircraft. Prior to taxiing onto an airport movement area, ADS-B In can provide advance indication of arriving aircraft and aircraft in the traffic pattern. Systems that incorporate a traffic–alerting feature can help minimize the pilot’s inclination to fixate on the display. Refer to ENR 1.1–45.5, ADS-B Limitations.

**36.7.2.2** Understand the limitations of ADS-B In. In certain airspace, not all aircraft will be equipped with ADS-B Out or transponders and will not be visible on your ADS-B In display.

**36.7.2.3** Limit the amount of time that you focus on flight instruments or tablets.

**36.7.2.4** Develop a strategic approach to scanning for traffic. Scan the entire sky and try not to focus straight ahead.

## 37. Surveillance Systems

### 37.1 Radar

#### 37.1.1 Capabilities

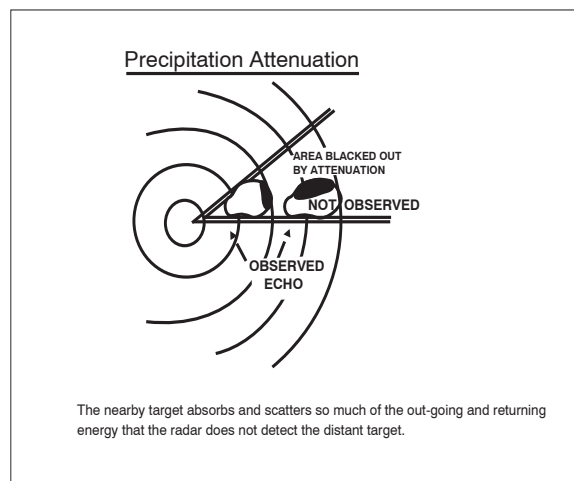
**37.1.1.1** Radar is a method whereby radio waves are transmitted into the air and are then received when they have been reflected by an object in the path of the beam. Range is determined by measuring the time it takes (at the speed of light) for the radio wave to go out to the object and then return to the receiving antenna. The direction of a detected object from a radar site is determined by the position of the rotating antenna when the reflected portion of the radio wave is received.

**37.1.1.2** More reliable maintenance and improved equipment have reduced radar system failures to a negligible factor. Most facilities actually have some components duplicated – one operating and another which immediately takes over when a malfunction occurs to the primary component.

#### 37.1.2 Limitations

**37.1.2.1** It is very important for the aviation community to recognize the fact that there are limitations to radar service and that ATC controllers may not always be able to issue traffic advisories concerning aircraft which are not under ATC control and cannot be seen on radar. (See FIG ENR 1.1–25).

FIG ENR 1.1–25  
Limitations to Radar Service



a) The characteristics of radio waves are such that they normally travel in a continuous straight line unless they are:

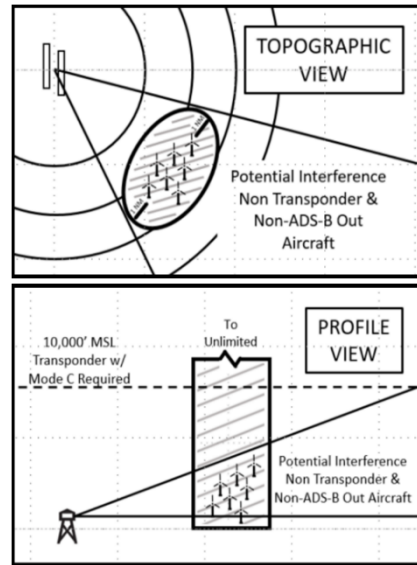
- 1) “Bent” by abnormal atmospheric phenomena such as temperature inversions.
  - 2) Reflected or attenuated by dense objects such as heavy clouds, precipitation, ground obstacles, mountains, etc.
  - 3) Screened by high terrain features.
- b) The bending of radar pulses, often called anomalous propagation or ducting, may cause many extraneous blips to appear on the radar operator’s display if the beam has been bent toward the ground, or may decrease the detection range if the wave is bent upward. It is difficult to solve the effects of anomalous propagation, but using beacon radar and electronically eliminating stationary and slow moving targets by a method called moving target indicator (MTI) usually negate the problem.
- c) Radar energy that strikes dense objects will be reflected and displayed on the operator’s scope, thereby blocking out aircraft at the same range and greatly weakening or completely eliminating the display of targets at a greater range. Again, radar beacon and MTI are effectively used to combat ground clutter and weather phenomena, and a method of circularly polarizing the radar beam will eliminate some weather returns. A negative characteristic of MTI is that an aircraft flying a speed that coincides with the canceling signal of the MTI (tangential or “blind” speed) may not be displayed to the radar controller.
- d) Relatively low altitude aircraft will not be seen if they are screened by mountains or are below the radar beam due to earth curvature. The historical solution to screening has been the installation of strategically placed multiple radars, which has been done in some areas, but ADS-B now provides ATC surveillance in some areas with challenging terrain where multiple radar installations would be impractical.
- e) There are several other factors which affect radar control. The amount of reflective surface of an aircraft will determine the size of the radar return. Therefore, a small light airplane or a sleek jet fighter will be more difficult to see on primary radar than a large commercial jet or military bomber. Here again, the use of transponder or ADS-B equipment is invaluable. In addition, all FAA ATC facilities display automatically reported altitude information to the controller from appropriately equipped aircraft.
- f) At some locations within the ATC en route environment, secondary-radar-only (no primary radar) gap filler radar systems are used to give lower altitude radar coverage between two larger radar systems, each of which provides both primary and secondary radar coverage. ADS-B serves this same role, supplementing both primary and secondary radar. In those geographical areas served by secondary radar only or ADS-B, aircraft without either transponders or ADS-B equipment cannot be provided with radar service. Additionally, transponder or ADS-B equipped aircraft cannot be provided with radar advisories concerning primary targets and ATC radar-derived weather.
- g) With regard to air traffic radar reception, wind turbines generally do not affect the quality of air traffic surveillance radar returns for transponder and ADS-B Out equipped aircraft. Air traffic interference issues apply to the search radar and Non-Transponder/Non-ADS-B Out-equipped aircraft.

**NOTE-**

*Generally, one or two wind turbines don’t present a significant radar reception loss. A rule of thumb is three (3) or more turbines constitute a wind turbine farm and thus negatively affect the search radar product.*

- 1) Detection loss in the area of a wind turbine farm is substantial. In extreme circumstances, this can extend for more than 1.0 nautical mile (NM) horizontally around the nearest turbine and at all altitudes above the wind turbine farm. (See FIG ENR 1.1-26.)

FIG ENR 1.1-26  
Wind Turbine Farm Area of Potential Interference



**NOTE-**

All aircraft should comply with 14 CFR §91.119(c) "...aircraft may not be operated closer than 500 feet to any person, vessel, vehicle, or structure."

2) To avoid interference, Non-Transponder/Non-ADS-B Out equipped aircraft should avoid flight within 1.0 NM horizontally, at all altitudes, from the wind turbine farms.

3) Because detection loss near and above wind turbine farms for search-only targets causes dropped tracks, erroneous tracks, and can result in loss of separation, it is imperative that Non-Transponder/Non-ADS-B Out equipped aircraft operate at the proper VFR altitudes per the hemispheric rule and utilize see-and-avoid techniques.

4) Pilots should be aware that air traffic controllers cannot provide separation from Non-Transponder/Non-ADS-B Out equipped aircraft in the vicinity of wind turbine farms. See-and-avoid is the pilot's responsibility, as these non-equipped aircraft may not appear on radar and will not appear on Traffic Information Service-Broadcast (TIS-B).

h) The controller's ability to advise a pilot flying on instruments or in visual conditions of the aircraft's proximity to another aircraft will be limited if the unknown aircraft is not observed on radar, if no flight plan information is available, or if the volume of traffic and workload prevent issuing traffic information. First priority is given to establishing vertical, lateral, or longitudinal separation between aircraft flying IFR under the control of ATC.

**37.2 Air Traffic Control Radar Beacon System (ATCRBS)**

**37.2.1** The ATCRBS, sometimes referred to as a secondary surveillance radar, consists of three main components:

**37.2.1.1 Interrogator.** Primary radar relies on a signal being transmitted from the radar antenna site and for this signal to be reflected or "bounced back" from an object (such as an aircraft). This reflected signal is then displayed as a "target" on the controller's radar scope. In the ATCRBS, the Interrogator, a ground-based radar beacon transmitter-receiver, scans in synchronism with the primary radar and transmits discrete radio signals which repetitiously requests all transponders, on the mode being used, to reply. The replies received are then mixed with the primary returns and both are displayed on the same radar scope.

**37.2.1.2 Transponder.** This airborne radar beacon transmitter-receiver automatically receives the signals from the interrogator and selectively replies with a specific pulse group (code) only to those interrogations being

received on the mode to which it is set. These replies are independent of, and much stronger than a primary radar return.

**37.2.1.3 Radar scope.** The radar scope used by the controller displays returns from both the primary radar system and the ATCRBS. These returns, called targets, are what the controller refers to in the control and separation of traffic.

**37.2.2** The job of identifying and maintaining identification of primary radar targets is a long and tedious task for the controller. Some of the advantages of ATCRBS over primary radar are:

**37.2.2.1** Reinforcement of radar targets.

**37.2.2.2** Rapid target identification.

**37.2.2.3** Unique display of selected codes.

**37.2.3** A part of the ATCRBS ground equipment is the decoder. This equipment enables the controller to assign discrete transponder codes to each aircraft under his/her control. Normally only one code will be assigned for the entire flight. Assignments are made by the ARTCC computer on the basis of the National Beacon Code Allocation Plan. The equipment is also designed to receive Mode C altitude information from the aircraft. See FIG ENR 1.1–27 and FIG ENR 1.1–28 for an illustration of the target symbology depicted on radar scopes in the NAS Stage A (en route), the ARTS III (terminal) Systems, and other nonautomated (broadband) radar systems.

### **37.3 Surveillance Radar**

**37.3.1** Surveillance radars are divided into two general categories: Airport Surveillance Radar (ASR) and Air Route Surveillance Radar (ARSR).

**37.3.1.1** ASR is designed to provide relatively short range coverage in the general vicinity of an airport and to serve as an expeditious means of handling terminal area traffic through observation of precise aircraft locations on a radar scope. The ASR can also be used as an instrument approach aid.

**37.3.1.2** ARSR is a long-range radar system designed primarily to provide a display of aircraft locations over large areas.

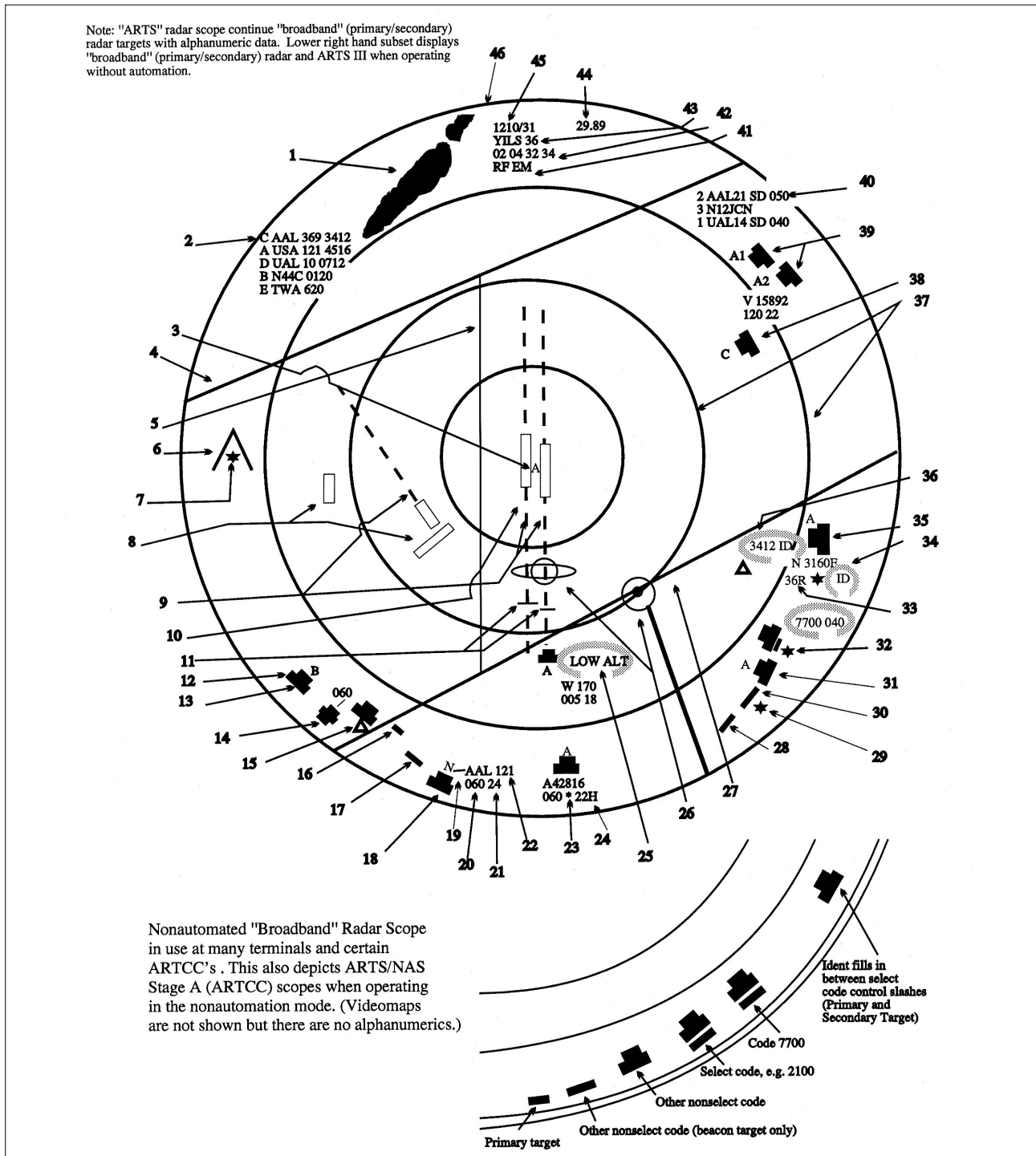
**37.3.2** Surveillance radars scan through 360 degrees of azimuth and present target information on a radar display located in a tower or center. This information is used independently or in conjunction with other navigational aids in the control of air traffic.

### **37.4 Precision Approach Radar (PAR)**

**37.4.1** PAR is designed for use as a landing aid rather than an aid for sequencing and spacing aircraft. PAR equipment may be used as a primary landing aid (See ENR 1.5 for additional information), or it may be used to monitor other types of approaches. It is designed to display range, azimuth, and elevation information.

**37.4.2** Two antennas are used in the PAR array, one scanning a vertical plane, and the other scanning horizontally. Since the range is limited to 10 miles, azimuth to 20 degrees, and elevation to 7 degrees, only the final approach area is covered. Each scope is divided into two parts. The upper half presents altitude and distance information, and the lower half presents azimuth and distance.

FIG ENR 1.1-27  
ARTS III Radar Scope With Alphanumeric Data



**NOTE-**

A number of radar terminals do not have ARTS equipment. Those facilities and certain ARTCCs outside the contiguous U.S. would have radar displays similar to the lower right hand subset. ARTS facilities and NAS Stage A ARTCCs, when operating in the nonautomation mode, would also have similar displays and certain services based on automation may not be available.

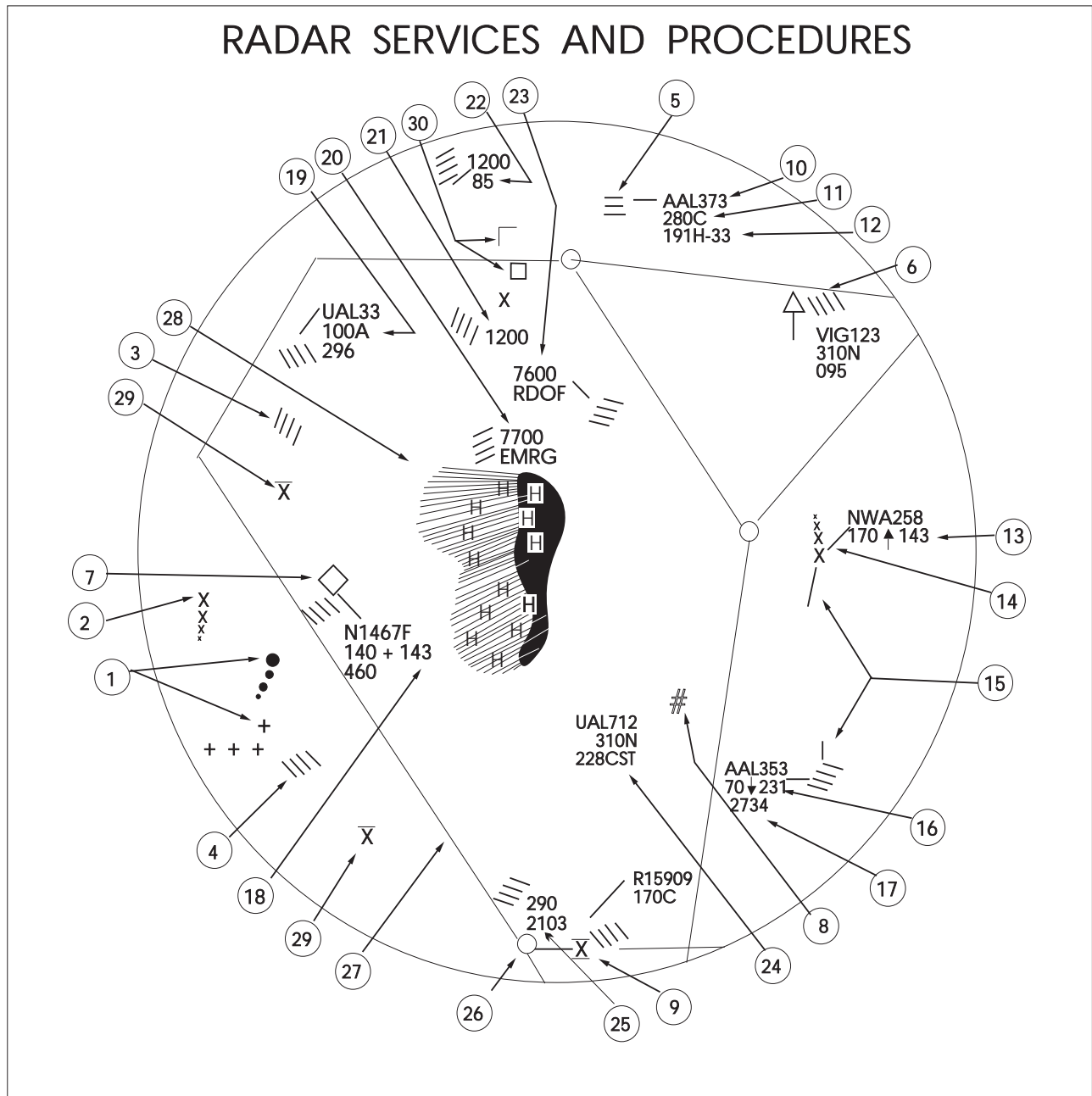


**EXAMPLE–**

1. Areas of precipitation (can be reduced by CP)
2. Arrival/departure tabular list
3. Trackball (control) position symbol (A)
4. Airway (lines are sometimes deleted in part)
5. Radar limit line for control
6. Obstruction (video map)
7. Primary radar returns of obstacles or terrain (can be removed by MTI)
8. Satellite airports
9. Runway centerlines (marks and spaces indicate miles)
10. Primary airport with parallel runways
11. Approach gates
12. Tracked target (primary and beacon target)
13. Control position symbol
14. Untracked target select code (monitored) with Mode C readout of 6,000'
15. Untracked target without Mode C
16. Primary target
17. Beacon target only (secondary radar) (transponder)
18. Primary and beacon target
19. Leader line
20. Altitude Mode C readout is 6,000'  
(Note: readouts may not be displayed because of nonreceipt of beacon information, garbled beacon signals, and flight plan data which is displayed alternately with the altitude readout)
21. Ground speed readout is 240 knots  
(Note: readouts may not be displayed because of a loss of beacon signal, a controller alert that a pilot was squawking emergency, radio failure, etc.)
22. Aircraft ID
23. Asterisk indicates a controller entry in Mode C block. In this case 5,000' is entered and "05" would alternate with Mode C readout.
24. Indicates heavy
25. "Low ALT" flashes to indicate when an aircraft's predicted descent places the aircraft in an unsafe proximity to terrain.  
(Note: this feature does not function if the aircraft is not squawking Mode C. When a helicopter or aircraft is known to be operating below the lower safe limit, the "low ALT" can be changed to "inhibit" and flashing ceases.)
26. NAVAIDs
27. Airways

28. *Primary target only*
29. *Nonmonitored. No Mode C (an asterisk would indicate nonmonitored with Mode C)*
30. *Beacon target only (secondary radar based on aircraft transponder)*
31. *Tracked target (primary and beacon target) control position A*
32. *Aircraft is squawking emergency code 7700 and is nonmonitored, untracked, Mode C*
33. *Controller assigned runway 36 right alternates with Mode C readout  
(Note: a three letter identifier could also indicate the arrival is at specific airport)*
34. *Ident flashes*
35. *Identifying target blossoms*
36. *Untracked target identifying on a selected code*
37. *Range marks (10 and 15 miles) (can be changed/ offset)*
38. *Aircraft controlled by center*
39. *Targets in suspend status*
40. *Coast/suspend list (aircraft holding, temporary loss of beacon/target, etc.)*
41. *Radio failure (emergency information)*
42. *Select beacon codes (being monitored)*
43. *General information (ATIS, runway, approach in use)*
44. *Altimeter setting*
45. *Time*
46. *System data area*

FIG ENR 1.1-28  
NAS Stage A Controller's View Plan Display



**NOTE-**  
FIG ENR 1.1-28 illustrates the controller's radar scope (PVD) when operating in the full automation (RDP) mode, which is normally 20 hours per day. When not in automation mode, the display is similar to the broadband mode shown in the ARTS III Radar Scope (FIG ENR 1.1-27). Certain ARTCCs outside the contiguous U.S. also operate in "broadband" mode.

**EXAMPLE-**

**Target symbols:**

1. Uncorrelated primary radar target [○] [+]
2. Correlated primary radar target [×]  
\*See note below.
3. Uncorrelated beacon target [ / ]
4. Correlated beacon target [ \ ]
5. Identifying beacon target [ ]

\*Note: in Number 2 correlated means the association of radar data with the computer projected track of an identified aircraft.

**Position symbols:**

6. Free track (no flight plan tracking) [△]
7. Flat track (flight plan tracking) [◇]
8. Coast (beacon target lost) [#]
9. Present position hold [⊠]

**Data block information:**

10. Aircraft ident  
\*See note below.

11. Assigned altitude FL 280, Mode C altitude same or within 200' of assigned altitude.  
\*See note below.

12. Computer ID #191, handoff is to sector 33  
(0-33 would mean handoff accepted)  
\*See note below.

13. Assigned altitude 17,000', aircraft is climbing, Mode C readout was 14,300 when last beacon interrogation was received.

14. Leader line connecting target symbol and data block.

15. Track velocity and direction vector line (projected ahead of target)

16. Assigned altitude 7,000, aircraft is descending, last Mode C readout (or last reported altitude) was 100' above FL 230

17. Transponder code shows in full data block only when different than assigned code

18. Aircraft is 300' above assigned altitude

19. Reported altitude (no Mode C readout) same as assigned. (An "n" would indicate no reported altitude.)

20. Transponder set on emergency Code 7700. (EMRG flashes to attract attention.)

21. *Transponder Code 1200 (VFR) with no Mode C*
22. *Code 1200 (VFR) with Mode C and last altitude readout*
23. *Transponder set on radio failure Code 7600 (RDOF flashes)*
24. *Computer ID #228, CST indicates target is in coast status*
25. *Assigned altitude FL 290, transponder code (these two items constitute a “limited data block”)*

✱*Note: numbers 10, 11, and 12 constitute a “full data block”*

**Other symbols:**

26. *Navigational aid*
27. *Airway or jet route*
28. *Outline of weather returns based on primary radar. “H” represents areas of high density precipitation which might be thunderstorms. Radial lines indicated lower density precipitation.*
29. *Obstruction*
30. *Airports*
  - Major:
  - Small:

**37.5 Airport Surface Detection Equipment (ASDE–X)/Airport Surface Surveillance Capability (ASSC)**

**37.5.1** ASDE–X/ASSC is a multi–sensor surface surveillance system the FAA is acquiring for airports in the United States. This system provides high resolution, short–range, clutter free surveillance information about aircraft and vehicles, both moving and fixed, located on or near the surface of the airport’s runways and taxiways under all weather and visibility conditions. The system consists of:

**37.5.1.1 A Primary Radar System.** ASDE–X/ASSC system coverage includes the airport surface and the airspace 5 miles from the arrival and departure ends of the runway and up to 200 feet above the surface. Typically located on the control tower or other strategic location on the airport, the Primary Radar antenna is able to detect and display aircraft that are not equipped with or have malfunctioning transponders or ADS–B.

**37.5.1.2 Interfaces.** ASDE–X/ASSC contains an automation interface for flight identification via all automation platforms and interfaces with the terminal radar for position information.

**37.5.1.3 ASDE–X/ASSC Automation.** A Multi–sensor Data Processor (MSDP) combines all sensor reports into a single target which is displayed to the air traffic controller.

**37.5.1.4 Air Traffic Control Tower Display.** A high resolution, color monitor in the control tower cab provides controllers with a seamless picture of airport operations on the airport surface.

**37.5.2** The combination of data collected from the multiple sensors ensures that the most accurate information about aircraft location is received in the tower, thereby increasing surface safety and efficiency.

**37.5.3** The following facilities are operational with ASDE–X:

*TBL ENR 1.1–2*

BWI	Baltimore Washington International	LAS	Las Vegas Harry Reid International
BOS	Boston Logan International	LAX	Los Angeles International
BDL	Bradley International	SDF	Louisville International
MDW	Chicago Midway	MEM	Memphis International
ORD	Chicago O’Hare International	MIA	Miami International
CLT	Charlotte Douglas International	MSP	Minneapolis St. Paul International
DFW	Dallas/Fort Worth International	EWR	Newark International
DEN	Denver International	MCO	Orlando International
DTW	Detroit Metro Wayne County	PHL	Philadelphia International
FLL	Fort Lauderdale/Hollywood Intl	PHX	Phoenix Sky Harbor International
MKE	General Mitchell International	DCA	Ronald Reagan Washington National
IAH	George Bush International	SAN	San Diego International
ATL	Hartsfield–Jackson Atlanta Intl	SLC	Salt Lake City International
HNL	Honolulu International	SEA	Seattle–Tacoma International
JFK	John F. Kennedy International	PVD	Theodore Francis Green State
SNA	John Wayne–Orange County	IAD	Washington Dulles International
LGA	LaGuardia	HOU	William P. Hobby International
STL	Lambert St. Louis International		

**37.5.4** The following facilities have been projected to receive ASSC:

*TBL ENR 1.1–3*

SFO	San Francisco International	MSY	Louis Armstrong New Orleans Intl
CLE	Cleveland–Hopkins International	PIT	Pittsburgh International
MCI	Kansas City International	ANC	Ted Stevens Anchorage International
CVG	Cincinnati/Northern Kentucky Intl	ADW	Joint Base Andrews AFB
PDX	Portland International		

### 37.6 Radar Availability

**37.6.1** FAA radar units operate continuously at the locations shown in the Chart Supplement U.S., and their services are available to all pilots, both civil and military. Contact the associated FAA control tower or ARTCC on any frequency guarded for initial instructions, or in an emergency, any FAA facility for information on the nearest radar service.

### 37.7 Transponder and ADS–B Out Operation

#### 37.7.1 General

**37.7.1.1** Pilots should be aware that proper application of transponder and ADS-B operating procedures will provide both VFR and IFR aircraft with a higher degree of safety while operating on the ground and airborne. Transponder/ADS-B panel designs differ; therefore, a pilot should be thoroughly familiar with the operation of their particular equipment to maximize its full potential. ADS-B Out, and transponders with altitude reporting mode turned ON (Mode C or S), substantially increase the capability of surveillance systems to see an aircraft. This provides air traffic controllers, as well as pilots of suitably equipped aircraft (TCAS and ADS-B In),

increased situational awareness and the ability to identify potential traffic conflicts. Even VFR pilots who are not in contact with ATC will be afforded greater protection from IFR aircraft and VFR aircraft that are receiving traffic advisories. Nevertheless, pilots should never relax their visual scanning for other aircraft, and should include the ADS-B In display (if equipped) in their normal traffic scan.

**37.7.1.2** ATCRBS is similar to and compatible with military coded radar beacon equipment. Civil Mode A is identical to military Mode 3.

**37.7.1.3 Transponder and ADS-B operations on the ground.** Civil and military aircraft should operate with the transponder in the altitude reporting mode (consult the aircraft's flight manual to determine the specific transponder position to enable altitude reporting) and ADS-B Out transmissions enabled at all airports, any time the aircraft is positioned on any portion of the airport movement area. This includes all defined taxiways and runways. Pilots must pay particular attention to ATIS and airport diagram notations, General Notes (included on airport charts), and comply with directions pertaining to transponder and ADS-B usage. Generally, these directions are:

**a) Departures.** Select the transponder mode which allows altitude reporting and enable ADS-B during pushback or taxi-out from parking spot. Select TA or TA/RA (if equipped with TCAS) when taking the active runway.

**b) Arrivals.** If TCAS equipped, deselect TA or TA/RA upon leaving the active runway, but continue transponder and ADS-B transmissions in the altitude reporting mode. Select STBY or OFF for transponder and ADS-B upon arriving at the aircraft's parking spot or gate.

**37.7.1.4 Transponder and ADS-B Operations While Airborne.**

**a)** Unless otherwise requested by ATC, aircraft equipped with an ATC transponder maintained in accordance with 14 CFR Section 91.413 MUST operate with this equipment on the appropriate Mode 3/A code, or other code as assigned by ATC, and with altitude reporting enabled whenever in controlled airspace. If practicable, aircraft SHOULD operate with the transponder enabled in uncontrolled airspace.

**b)** Aircraft equipped with ADS-B Out MUST operate with this equipment in the transmit mode at all times, unless otherwise requested by ATC.

**37.7.1.5 Transponder and ADS-B Operation Under Visual Flight Rules (VFR)**

**a)** Unless otherwise instructed by an ATC facility, adjust transponder/ADS-B to reply on Mode 3/A Code 1200 regardless of altitude.

**b)** When required to operate their transponder/ADS-B, pilots must always operate that equipment with altitude reporting enabled unless otherwise instructed by ATC or unless the installed equipment has not been tested and calibrated as required by 14 CFR Section 91.217. If deactivation is required, turn off altitude reporting.

**c)** When participating in a VFR standard formation flight that is not receiving ATC services, only the lead aircraft should operate its transponder and ADS-B Out and squawk code 1203. Once established in formation, all other aircraft should squawk standby and disable ADS-B transmissions.

**NOTE–**

**1.** If the formation flight is receiving ATC services, pilots can expect ATC to direct all non-lead aircraft to STOP Squawk, and should not do so until instructed.

**2.** Firefighting aircraft not in contact with ATC may squawk 1255 in lieu of 1200 while en route to, from, or within the designated firefighting area(s).

**3.** VFR aircraft flying authorized SAR missions for the USAF or USCG may be advised to squawk 1277 in lieu of 1200 while en route to, from, or within the designated search area.

**4.** VFR gliders should squawk 1202 in lieu of 1200.

**REFERENCE–**

FAA Order JO 7110.66, National Beacon Code Allocation Plan (NBCAP).

**37.7.1.6** A pilot on an IFR flight who elects to cancel the IFR flight plan prior to reaching their destination, should adjust the transponder/ADS-B according to VFR operations.

**37.7.1.7** If entering a U.S. OFFSHORE AIRSPACE AREA from outside the U.S., the pilot should advise on first radio contact with a U.S. radar ATC facility that such equipment is available by adding “transponder” or “ADS–B” (if equipped) to the aircraft identification.

**37.7.1.8** It should be noted by all users of ATC transponders and ADS–B Out systems that the surveillance coverage they can expect is limited to “line of sight” with ground radar and ADS–B radio sites. Low altitude or aircraft antenna shielding by the aircraft itself may result in reduced range or loss of aircraft contact. Though ADS–B often provides superior reception at low altitudes, poor coverage from any surveillance system can be improved by climbing to a higher altitude.

**NOTE–**

*Pilots should refer to AIP, ENR 1.1 Paragraph 45., Automatic Dependent Surveillance – Broadcast Services (ADS–B) Services, for a complete description of operating limitations and procedures.*

**37.7.2 Transponder/ADS–B Code Designation**

**37.7.2.1** For ATC to utilize one of the 4096 discrete codes, a four–digit code designation will be used; for example, code 2102 will be expressed as “TWO ONE ZERO TWO.”

**NOTE–**

*Circumstances may occasionally require ATC to assign a non–discrete code; i.e., a code ending in “00.”*

**REFERENCE–**

*FAA Order JO 7110.66, National Beacon Code Allocation Plan (NBCAP).*

**37.7.3 Automatic Altitude Reporting**

**37.7.3.1** Most transponders (Modes C and S) and all ADS–B Out systems are capable of automatic altitude reporting. This system converts aircraft altitude in 100–foot increments to coded digital information that is transmitted to the appropriate surveillance facility as well as to ADS–B In and TCAS systems.

**37.7.3.2** Adjust the transponder/ADS–B to reply on the Mode 3/A code specified by ATC and with altitude reporting enabled, unless otherwise directed by ATC or unless the altitude reporting equipment has not been tested and calibrated as required by 14 CFR Section 91.217. If deactivation is required by ATC, turn off the altitude reporting feature of your transponder/ADS–B. An instruction by ATC to “STOP ALTITUDE SQUAWK, ALTITUDE DIFFERS BY (number of feet) FEET,” may be an indication that the transmitted altitude information is incorrect, or that the aircraft’s altimeter setting is incorrect. While an incorrect altimeter setting has no effect on the transmitted altitude information, it will cause the aircraft to fly at a true altitude different from the assigned altitude. When a controller indicates that an altitude readout is invalid, the pilot should verify that the aircraft altimeter is set correctly.

**NOTE–**

*Altitude encoders are preset at standard atmospheric pressure. Local altimeter correction is applied by the surveillance facility before the altitude information is presented to ATC.*

**37.7.3.3** Pilots should report exact altitude or flight level to the nearest hundred foot increment when establishing initial contact with an ATC facility. Exact altitude or flight level reports on initial contact provide ATC with information that is required prior to using automatically reported altitude information for separation purposes. This will significantly reduce altitude verification requests.

**37.7.4 IDENT Feature**

**37.7.4.1** Transponder/ADS–B Out equipment must be operated only as specified by ATC. Activate the “IDENT” feature only when requested by ATC.

**37.7.5 Code Changes**

**37.7.5.1** When making routine code changes, pilots should avoid inadvertent selection of Codes 7500, 7600, or 7700 thereby causing momentary false alarms at automated ground facilities. For example when switching from Code 2700 to Code 7200, switch first to 2200 then 7200, NOT to 7700 and then 7200. This procedure applies to nondiscrete Code 7500 and all discrete codes in the 7600 and 7700 series (i.e., 7600–7677, 7700–7777) which will trigger special indicators in automated facilities. Only nondiscrete Code 7500 will be decoded as the hijack code.



**37.7.5.2** Under no circumstances should a pilot of a civil aircraft operate the transponder on Code 7777. This code is reserved for military interceptor operations.

**37.7.5.3** Military pilots operating VFR or IFR within restricted/warning areas should adjust their transponders to Code 4000, unless another code has been assigned by ATC.

### **37.7.6 Mode C Transponder and ADS–B Out Requirements**

**37.7.6.1** Specific details concerning requirements to carry and operate Mode C transponders and ADS–B Out, as well as exceptions and ATC authorized deviations from those requirements, are found in 14 CFR Sections 91.215, 91.225, and 99.13.

**37.7.6.2** In general, the CFRs require aircraft to be equipped with an operable Mode C transponder and ADS–B Out when operating:

- a) In Class A, Class B, or Class C airspace areas;
- b) Above the ceiling and within the lateral boundaries of Class B or Class C airspace up to 10,000 feet MSL;
- c) Class E airspace at and above 10,000 feet MSL within the 48 contiguous states and the District of Columbia, excluding the airspace at and below 2,500 feet AGL;
- d) Within 30 miles of a Class B airspace primary airport, below 10,000 feet MSL (commonly referred to as the “Mode C Veil”);
- e) For ADS–B Out: Class E airspace at and above 3,000 feet MSL over the Gulf of Mexico from the coastline of the United States out to 12 nautical miles.

#### **NOTE–**

*The airspace described in (e) above is specified in 14 CFR § 91.225 for ADS–B Out requirements. However, 14 CFR § 91.215 does not include this airspace for ATC transponder requirements.*

f) Transponder and ADS–B Out requirements do not apply to any aircraft that was not originally certificated with an electrical system, or that has not subsequently been certified with such a system installed, including balloons and gliders. These aircraft may conduct operations without a transponder or ADS–B Out when operating:

- 1) Outside any Class B or Class C airspace area; and
- 2) Below the altitude of the ceiling of a Class B or Class C airspace area designated for an airport, or 10,000 feet MSL, whichever is lower.

**37.7.6.3** 14 CFR Section 99.13 requires all aircraft flying into, within, or across the contiguous U.S. ADIZ be equipped with a Mode C or Mode S transponder. Balloons, gliders, and aircraft not equipped with an engine–driven electrical system are excepted from this requirement.

#### **REFERENCE–**

*AIP, ENR 1.12, National Security and Interception Procedures.*

**37.7.6.4** Pilots must ensure that their aircraft transponder/ADS–B is operating on an appropriate ATC–assigned VFR/IFR code with altitude reporting enabled when operating in such airspace. If in doubt about the operational status of either feature of your transponder while airborne, contact the nearest ATC facility or FSS and they will advise you what facility you should contact for determining the status of your equipment.

**37.7.6.5** In–flight requests for “immediate” deviation from the transponder requirements may be approved by controllers only for failed equipment, and only when the flight will continue IFR or when weather conditions prevent VFR descent and continued VFR flight in airspace not affected by the CFRs. All other requests for deviation should be made at least 1 hour before the proposed operation by contacting the nearest Flight Service or Air Traffic facility in person or by telephone. The nearest ARTCC will normally be the controlling agency and is responsible for coordinating requests involving deviations in other ARTCC areas.

**37.7.6.6** In–flight requests for “immediate” deviation from the ADS–B Out requirements may be approved by ATC only for failed equipment, and may be accommodated based on workload, alternate surveillance

availability, or other factors. All other requests for deviation must be made at least 1 hour before the proposed operation, following the procedures contained in Advisory Circular (AC) 90–114, Automatic Dependent Surveillance–Broadcast Operations.

**37.7.7 Cooperative Surveillance Phraseology.** Air traffic controllers, both civil and military, will use the following phraseology when referring to operation of cooperative ATC surveillance equipment. Except as noted, the following ATC instructions do not apply to military transponders operating in other than Mode 3/A/C/S.

**37.7.7.1 SQUAWK (number).** Operate radar beacon transponder/ADS–B on designated code with altitude reporting enabled.

**37.7.7.2 IDENT.** Engage the “IDENT” feature (military I/P) of the transponder/ADS–B.

**37.7.7.3 SQUAWK (number) AND IDENT.** Operate transponder/ADS–B on specified code with altitude reporting enabled, and engage the “IDENT” (military I/P) feature.

**37.7.7.4 SQUAWK STANDBY.** Switch transponder/ADS–B to standby position.

**37.7.7.5 SQUAWK NORMAL.** Resume normal transponder/ADS–B operation on previously assigned code. (Used after “SQUAWK STANDBY,” or by military after specific transponder tests).

**37.7.7.6 SQUAWK ALTITUDE.** Activate Mode C with automatic altitude reporting.

**37.7.7.7 STOP ALTITUDE SQUAWK.** Turn off automatic altitude reporting.

**37.7.7.8 STOP SQUAWK (Mode in use).** Stop transponder and ADS–B Out transmissions, or switch off only specified mode of the aircraft transponder (military).

**37.7.7.9 SQUAWK MAYDAY.** Operate transponder/ADS–B in the emergency position (Mode A Code 7700 for civil transponder. Mode 3 Code 7700 and emergency feature for military transponder.)

**37.7.7.10 SQUAWK VFR.** Operate radar beacon transponder/ADS–B on Code 1200 in the Mode A/3, or other appropriate VFR code, with altitude reporting enabled.

## **37.8 Emergency Operation**

**37.8.1** When an emergency occurs, the pilot of an aircraft equipped with a coded radar beacon transponder who desires to alert a ground radar facility to an emergency condition and who cannot establish communications without delay with an ATC facility may adjust the transponder to reply on Mode A/3, Code 7700.

**37.8.2** Pilots should understand that they may not be within a radar coverage area and that, even if they are, certain radar facilities are not yet equipped to automatically recognize Code 7700 as an emergency signal. Therefore, they should establish radio communications with an ATC facility as soon as possible.

## **37.9 Radio Failure Operation**

**37.9.1** Should the pilot of an aircraft equipped with a coded radar beacon transponder experience a loss of two–way radio capability the pilot should:

**37.9.1.1** Adjust the transponder to reply on MODE A/3, Code 7600.

**37.9.1.2** Understand that the aircraft may not be in an area of radar coverage.

**37.9.2** Pilots should understand that they may not be in an area of radar coverage. Also, many radar facilities are not presently equipped to automatically display Code 7600 and will interrogate 7600 only when the aircraft is under direct radar control at the time of radio failure. However, replying on Code 7700 first, increases the probability of early detection of a radio failure condition.

## **37.10 Radar Services**

### **37.10.1 Safety Alert**

**37.10.1.1** A safety alert will be issued to pilots of aircraft being controlled by ATC if the controller is aware the aircraft is at an altitude which, in the controller’s judgment, places the aircraft in unsafe proximity to terrain,

obstructions, or other aircraft. The provision of this service is contingent upon the capability of the controller to have an awareness of situations involving unsafe proximity to terrain, obstructions, and uncontrolled aircraft. The issuance of a safety alert cannot be mandated, but it can be expected on a reasonable, though intermittent, basis. Once the alert is issued, it is solely the pilot's prerogative to determine what course of action, if any, will be taken. This procedure is intended for use in time critical situations where aircraft safety is in question. Noncritical situations should be handled via the normal traffic alert procedures.

### **37.10.2 Terrain/Obstruction Alert**

**37.10.2.1** Controllers will immediately issue an alert to the pilots of aircraft under their control when they recognize that the aircraft is at an altitude which, in their judgment, may be in unsafe proximity to terrain/obstructions. The primary method of detecting unsafe proximity is through Mode C automatic altitude reports.

**EXAMPLE-**

*Low altitude alert Cessna Three Four Juliet, check your altitude immediately. And if the aircraft is not yet on final approach, the MVA (MEA/MIA/MOCA) in your area is six thousand.*

**37.10.2.2** Most En Route and Terminal radar facilities have an automated function which, if operating, alerts controllers when a tracked Mode C equipped aircraft under their control is below or is predicted to be below a predetermined minimum safe altitude. This function, called Minimum Safe Altitude Warning (MSAW), is designed solely as a controller aid in detecting potentially unsafe aircraft proximity to terrain/obstructions. The radar facility will, when MSAW is operating, provide MSAW monitoring for all aircraft with an operating Mode C altitude encoding transponder that are tracked by the system and are:

- a) Operating on a IFR flight plan.
- b) Operating VFR and have requested MSAW monitoring.

**NOTE-**

*Pilots operating VFR may request MSAW or monitoring if their aircraft are equipped with Mode C transponders.*

**EXAMPLE-**

*Apache Three Three Papa requests MSAW monitoring.*

**37.10.2.3** Due to the lack of terrain and obstacle clearance data, accurate automation databases may not be available for providing MSAW information to aircraft overflying Mexico and Canada. Air traffic facilities along the United States/Mexico/Canada borders may have MSAW computer processing inhibited where accurate terrain data is not available.

### **37.10.3 Aircraft Conflict Alert**

**37.10.3.1** Controllers will immediately issue an alert to the pilots of aircraft under their control if they are aware of an aircraft that is not under their control at an altitude which, in the controller's judgment, places both aircraft in unsafe proximity to each other. With the alert, when feasible, the controller will offer the pilot the position of the traffic if time permits and an alternate course(s) of action. Any alternate course of action the controller may recommend to the pilot will be predicated only on other traffic in the controller's jurisdiction.

**EXAMPLE-**

*American Three, traffic alert, (position of traffic, if time permits), advise you turn right/left heading (degrees) and/or climb/descend to (altitude) immediately.*

### **37.10.4 Radar Traffic Information Service (RTIS)**

**37.10.4.1** This is a service provided by radar ATC facilities. Pilots receiving this service are advised of any radar target observed on the radar display which may be in such proximity to the position of their aircraft or its intended route of flight that it warrants their attention. This service is not intended to relieve the pilot of the responsibility for continual vigilance to see and avoid other aircraft.

**a) Purpose of this Service**

1) The issuance of traffic information as observed on a radar display is based on the principle of assisting and advising a pilot that a particular radar target's position and track indicates it may intersect or pass in such

proximity to the intended flight path that it warrants the pilot's attention. This is to alert the pilot to the traffic, to be on the lookout for it, and thereby be in a better position to take appropriate action should the need arise.

2) Pilots are reminded that the surveillance radar used by ATC does not provide altitude information unless the aircraft is equipped with Mode C and the radar facility is capable of displaying altitude information.

**b) Provisions of the Service**

1) Many factors, such as limitations of the radar, volume of traffic, controller workload, and communications frequency congestion could prevent the controller from providing this service. Controllers possess complete discretion for determining whether they are able to provide or continue to provide this service in a specific case. The controller's reason against providing or continuing to provide the service in a particular case is not subject to question nor need it be communicated to the pilot. In other words, the provision of this service is entirely dependent upon whether controllers believe they are in a position to provide it. Traffic information is routinely provided to all aircraft operating on IFR flight plans except when the pilot declines the service, or the pilot is operating within Class A airspace. Traffic information may be provided to flights not operating on IFR Flight Plans when requested by pilots of such flights.

**NOTE-**

*Radar ATC facilities normally display and monitor both primary and secondary radar as well as ADS-B, except that secondary radar or ADS-B may be used as the sole display source in Class A airspace, and under some circumstances outside of Class A airspace (beyond primary coverage and in en route areas where only secondary and/or ADS-B is available). Secondary radar and/or ADS-B may also be used outside Class A airspace as the sole display source when the primary radar is temporarily unusable or out of service. Pilots in contact with the affected ATC facility are normally advised when a temporary outage occurs; i.e., "primary radar out of service; traffic advisories available on transponder or ADS-B aircraft only." This means simply that only aircraft that have transponders and ADS-B installed and in use will be depicted on ATC displays when the primary and/or secondary radar is temporarily out of service.*

2) When receiving VFR radar advisory service, pilots should monitor the assigned frequency at all times. This is to preclude controllers' concern for radio failure of emergency assistance to aircraft under the controller's jurisdiction. VFR radar advisory service does not include vectors away from conflicting traffic unless requested by the pilot. When advisory service is no longer desired, advise the controller before changing frequencies, then change your transponder code to 1200 if applicable. THE, as appropriate, MEA/MVA/MOCA IN YOUR AREA IS (altitude) or if past the final approach fix, THE, as appropriate, MDA/DH (if known) is (altitude). Except in programs where radar service is automatically terminated, the controller will advise the aircraft when radar is terminated.

**NOTE-**

*Participation by VFR pilots in formal programs implemented at certain terminal locations constitutes pilot request. This also applies to participating pilots at those locations where arriving VFR flights are encouraged to make their first contact with the tower on the approach control frequency.*

**c) Issuance of Traffic Information.** Traffic information will include the following concerning a target which may constitute traffic for an aircraft that is:

**1) Radar identified.**

(a) Azimuth from the aircraft in terms of the twelve hour clock.

(b) When rapidly maneuvering civil test or military aircraft prevent accurate issuance of traffic as in a) above, specify the direction from an aircraft's position in terms of the eight cardinal compass points (N, NE, E, SE, S, SW, W, NW). This method must be terminated at the pilot's request.

(c) Distance from the aircraft in nautical miles.

(d) Direction in which the target is proceeding.

(e) Type of aircraft and altitude if known.

**EXAMPLE-**

*Traffic 10 o'clock, 3 miles, west-bound (type aircraft and altitude, if known, of the observed traffic). The altitude may be*

known, by means of Mode C, but not verified with the pilot for accuracy. (To be valid for separation purposes by ATC, the accuracy of Mode C readouts must be verified. This is usually accomplished upon initial entry into the radar system by a comparison of the readout to pilot stated altitude, or the field elevation in the case of continuous readout being received from an aircraft on the airport.) When necessary to issue traffic advisories containing unverified altitude information, the controller will issue the indicated altitude of the aircraft. The pilot may upon receipt of traffic information, request a vector (heading) to avoid such traffic. The vector will be provided to the extent possible as determined by the controller provided the aircraft to be vectored is within the airspace under the jurisdiction of the controller.

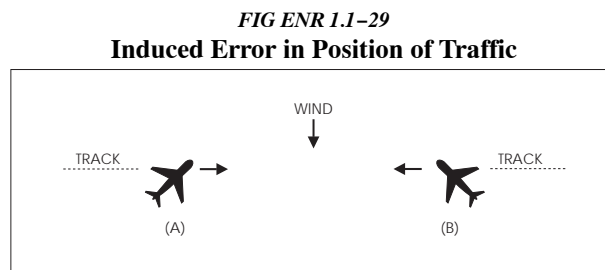
**2) Not radar identified**

- (a) Distance and direction with respect to a fix.
- (b) Direction in which the target is proceeding.
- (c) Type of aircraft and altitude if known.

**EXAMPLE–**

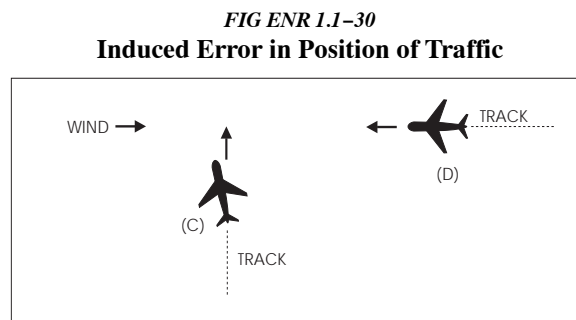
Traffic 8 miles south of the airport northeastbound, (type aircraft and altitude if known).

(d) The examples depicted in FIG ENR 1.1–29 and FIG ENR 1.1–30 point out the possible error in the position of this traffic when it is necessary for a pilot to apply drift correction to maintain this track. This error could also occur in the event a change in course is made at the time radar traffic information is issued.



**EXAMPLE–**

In FIG ENR 1.1–29, traffic information would be issued to the pilot of aircraft “A” as 12 o’clock. The actual position of the traffic as seen by the pilot of aircraft “A” would be one o’clock. Traffic information issued to aircraft “B” would also be given as 12 o’clock, but in this case, the pilot of “B” would see the traffic at 11 o’clock.



**EXAMPLE–**

In FIG ENR 1.1–30, traffic information would be issued to the pilot of aircraft “C” as two o’clock. The actual position of the traffic as seen by the pilot of aircraft “C” would be three o’clock. Traffic information issued to aircraft “D” would be at an 11 o’clock position. Since it is not necessary for the pilot of aircraft “D” to apply wind correction (CRAB) to remain on track, the actual position of the traffic issued would be correct. Since the radar controller can only observe aircraft track (course) on the radar display, traffic advisories are issued accordingly, and pilots should give due consideration to this fact when looking for reported traffic.

**37.11 Radar Assistance to VFR Aircraft**

**37.11.1** Radar equipped FAA ATC facilities provide radar assistance and navigation service (vectors) to VFR aircraft provided the aircraft can communicate with the facility, are within radar coverage, and can be radar identified.

**37.11.2** Pilots should clearly understand that authorization to proceed in accordance with such radar navigational assistance does not constitute authorization for the pilot to violate Federal Aviation Regulations. In effect, assistance provided is on the basis that navigational guidance information issued is advisory in nature and the job of flying the aircraft safely remains with the pilot.

**37.11.3** In many cases, controllers will be unable to determine if flight into instrument conditions will result from their instructions. To avoid possible hazards resulting from being vectored into IFR conditions, pilots should keep controllers advised of the weather conditions in which they are operating and along the course ahead.

**37.11.4** Radar navigation assistance (vectors) may be initiated by the controller when one of the following conditions exist:

**37.11.4.1** The controller suggests the vector and the pilot concurs.

**37.11.4.2** A special program has been established and vectoring service has been advertised.

**37.11.4.3** In the controller's judgment the vector is necessary for air safety.

**37.11.5** Radar navigation assistance (vectors) and other radar derived information may be provided in response to pilot requests. Many factors, such as limitations of radar, volume of traffic, communications frequency, congestion, and controller workload could prevent the controller from providing it. Controllers have complete discretion for determining if they are able to provide the service in a particular case. Their decision not to provide the service in a particular case is not subject to question.

## **38. Operational Policy/Procedures for Reduced Vertical Separation Minimum (RVSM) in the Domestic U.S., Alaska, Offshore Airspace and the San Juan FIR**

### **38.1 Applicability and RVSM Mandate (Date/Time and Area)**

**38.1.1 Applicability.** The policies, guidance and direction in this section are consistent with the policies and procedures used in Domestic U.S. RVSM Airspace, as specified in the Aeronautical Information Manual, Chapter 4, Section 6. For any oceanic area specific items, see Part II, ENR 7. Oceanic Procedures.

**38.1.2 Requirement.** The FAA implemented RVSM between flight level (FL) 290–410 (inclusive) in the following airspace: the airspace of the lower 48 states of the United States, Alaska, Atlantic and Gulf of Mexico High Offshore Airspace and the San Juan FIR. RVSM has been implemented worldwide and may be applied in all ICAO Flight Information Regions (FIR).

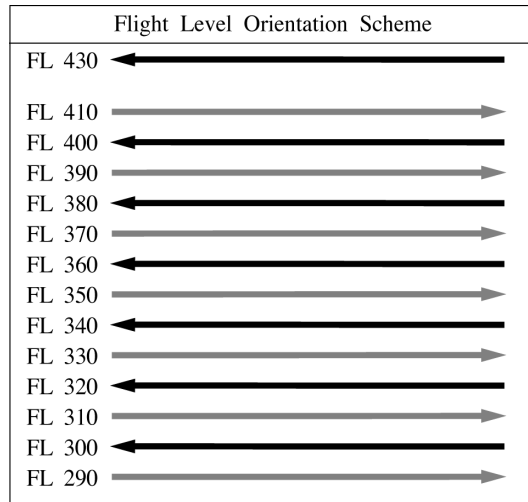
**38.1.3** In accordance with 14 CFR Section 91.706, with only limited exceptions, prior to operating in RVSM airspace, operators must comply with the standards of Part 91, Appendix G, and be authorized by the Administrator. If the operator has not been authorized for RVSM operations, or the aircraft is not RVSM compliant, the aircraft will be referred to as “non–RVSM” aircraft. Paragraph 38.10 discusses ATC policies for accommodation of non–RVSM aircraft flown by the Department of Defense, Air Ambulance (MEDEVAC) operators, foreign State governments and aircraft flown for certification and development. Paragraph 38.11, Non–RVSM Aircraft Requesting Climb to and Descent from Flight Levels Above RVSM Airspace Without Intermediate Level Off, contains policies for non–RVSM aircraft climbing and descending through RVSM airspace to/from flight levels above RVSM airspace.

**38.1.4 Benefits.** RVSM enhances ATC flexibility, mitigates conflict points, enhances sector throughput, reduces controller workload and enables crossing traffic. Operators gain fuel savings and operating efficiency benefits by flying at more fuel efficient flight levels and on more user preferred routings.

### **38.2 Flight Level Orientation Scheme**

Altitude assignments for direction of flight follow a scheme of odd altitude assignment for magnetic courses 000–179 degrees and even altitudes for magnetic courses 180–359 degrees for flights up to and including FL 410, as indicated in FIG ENR 1.1–31.

FIG ENR 1.1-31  
Flight Level Orientation Scheme



**NOTE-**  
*Odd Flight Levels: Magnetic Course 000–179 Degrees Even Flight Levels: Magnetic Course 180–359 Degrees.*

### 38.3 Aircraft and Operator Approval Policy/Procedures, RVSM Monitoring and Databases for Aircraft and Operator Approval

**38.3.1 RVSM Authority.** 14 CFR Section 91.180 applies to RVSM operations within the U.S. 14 CFR Section 91.706 applies to RVSM operations outside the U.S. Both sections require that the operator obtain authorization prior to operating in RVSM airspace.

**38.3.2 Sources of Information.** Advisory Circular (AC) 91–85, Authorization of Aircraft and Operators for Flight in Reduced Vertical Separation Minimum (RVSM) Airspace, and the FAA RVSM Website.

**38.3.3 TCAS Equipage.** TCAS equipage requirements are contained in 14 CFR Sections 121.356, 125.224, 129.18 and 135.189. Part 91 Appendix G does not contain TCAS equipage requirements specific to RVSM, however, Appendix G does require that aircraft equipped with TCAS II and flown in RVSM airspace be modified to incorporate TCAS II Version 7.0 or a later version.

**38.3.4 Aircraft Monitoring.** Operators are required to participate in the RVSM altitude-keeping performance monitoring program that is appropriate for the type of operation being conducted. The monitoring programs are described in FAA AC 91–85, Authorization of Aircraft and Operators for Flight in Reduced Vertical Separation Minimum Airspace. Monitoring is a quality control program that enables the FAA and other civil aviation authorities to assess the in-service altitude-keeping performance of aircraft and operators.

**38.3.5 RVSM Approvals Databases for U.S. operators** can be found on the RVSM Documentation Webpage in the “RVSM Approvals” section.

### 38.4 Flight Planning into RVSM Airspace

**38.4.1** Operators that do not file the correct aircraft equipment suffix on the FAA or ICAO Flight Plan may be denied clearance into RVSM airspace. Policies for the FAA Flight Plan are detailed in subparagraph 38.4.3 below. Policies for the ICAO Flight Plan are detailed in subparagraph 38.4.4.

**38.4.2** The operator will annotate the equipment block of the FAA or ICAO Flight Plan with an aircraft equipment suffix indicating RVSM capability only after the responsible civil aviation authority has determined that both the operator and its aircraft are RVSM-compliant and has issued RVSM authorization to the operator.

**38.4.3** General Policies for FAA Flight Plan Equipment Suffix. Appendix 2, TBL 2–2, allows operators to indicate that the aircraft has both RVSM and Advanced Area Navigation (RNAV) capabilities or has only RVSM capability.

**38.4.3.1** The operator will annotate the equipment block of the FAA Flight Plan with the appropriate aircraft equipment suffix from Appendix 2, TBL 2-2 and/or TBL 2-3.

**38.4.3.2** Operators can only file one equipment suffix in block 3 of the FAA Flight Plan. Only this equipment suffix is displayed directly to the controller.

**38.4.3.3** Aircraft with RNAV Capability. For flight in RVSM airspace, aircraft with RNAV capability, but not Advanced RNAV capability, will file “/W”. Filing “/W” will not preclude such aircraft from filing and flying direct routes in en route airspace.

**38.4.4** Policy for ICAO Flight Plan Equipment Suffixes.

**38.4.4.1** Operators/aircraft that are RVSM-compliant and that file ICAO flight plans will file “/W” in block 10 (Equipment) to indicate RVSM authorization and will also file the appropriate ICAO Flight Plan suffixes to indicate navigation and communication capabilities.

**38.4.4.2** Operators/aircraft that file ICAO flight plans that include flight in Domestic U.S. RVSM airspace must file “/W” in block 10 to indicate RVSM authorization.

**38.4.5** Importance of Flight Plan Equipment Suffixes. Military users, and civilians who file stereo route flight plans, must file the appropriate equipment suffix in the equipment block of the FAA Form 7233-1, Flight Plan, or DD Form 175, Military Flight Plan, or FAA Form 7233-4, International Flight Plan, or DD Form 1801, DOD International Flight Plan. All other users must file the appropriate equipment suffix in the equipment block of FAA Form 7233-4, International Flight Plan. The equipment suffix informs ATC:

**38.4.5.1** Whether or not the operator and aircraft are authorized to fly in RVSM airspace.

**38.4.5.2** The navigation and/or transponder capability of the aircraft (e.g., advanced RNAV, Transponder with Mode C).

**38.4.6** Significant ATC uses of the flight plan equipment suffix information are:

**38.4.6.1** To issue or deny clearance into RVSM airspace.

**38.4.6.2** To apply a 2,000 foot vertical separation minimum in RVSM airspace to aircraft that are not authorized for RVSM, but are in one of the limited categories that the FAA has agreed to accommodate. (See paragraphs 38.10, Procedures for Accommodation of Non-RVSM Aircraft, and 38.11, Non-RVSM Aircraft Requesting Climb to and Descent from Flight Levels Above RVSM Airspace Without Intermediate Level Off, for policy on limited operation of unapproved aircraft in RVSM airspace).

**38.4.7** Improperly changing an aircraft equipment suffix and/or adding “NON-RVSM” in the NOTES or REMARKS section (Field 18) while not removing the “W” from Field 10, will not provide air traffic control with the proper visual indicator necessary to detect Non-RVSM aircraft. To ensure information processes correctly for Non-RVSM aircraft, the “W” in Field 10 must be removed. Entry of information in the NOTES or REMARKS section (Field 18) will not affect the determination of RVSM capability and must not be used to indicate a flight is Non-RVSM.

## **38.5 Pilot RVSM Operating Practices and Procedures**

**38.5.1 RVSM Requirement.** If either the operator is not authorized for RVSM operations, or the aircraft is not RVSM compliant, the pilot will neither request nor accept a clearance into RVSM airspace unless:

**38.5.1.1** The flight is conducted by a non-RVSM DOD, MEDEVAC, certification/development or foreign State (government) aircraft in accordance with Paragraph 38.10, Procedures for Accommodation of Non-RVSM Aircraft.

**38.5.1.2** The pilot intends to climb to or descend from FL 430 or above in accordance with Paragraph 38.11, Non-RVSM Aircraft Requesting Climb to and Descent from Flight Levels Above RVSM Airspace Without Intermediate Level Off.

**38.5.1.3** An emergency situation exists.



**38.5.2 Basic RVSM Operating Practices and Procedures.** FAA AC 91-85 contains pilot practices and procedures for RVSM. Operators must incorporate RVSM practices and procedures, as supplemented by the applicable paragraphs of this section, into operator training or pilot knowledge programs and operator documents containing RVSM operational policies.

**38.5.3** FAA AC 91-85 contains practices and procedures for flight planning, preflight procedures at the aircraft, procedures prior to RVSM airspace entry, inflight (en route) procedures, contingency procedures and post flight.

**38.5.4** The following paragraphs either clarify or supplement FAA AC 91-85 practices and procedures.

## **38.6 Guidance on Severe Turbulence and Mountain Wave Activity (MWA)**

### **38.6.1 Introduction/Explanation**

**38.6.1.1** The information and practices in this paragraph are provided to emphasize to pilots and controllers the importance of taking appropriate action in RVSM airspace when aircraft experience severe turbulence and/or MWA that is of sufficient magnitude to significantly affect altitude-keeping.

**38.6.1.2 Severe Turbulence.** Severe turbulence causes large, abrupt changes in altitude and/or attitude usually accompanied by large variations in indicated airspeed. Aircraft may be momentarily out of control. Encounters with severe turbulence must be remedied immediately in any phase of flight. Severe turbulence may be associated with MWA.

### **38.6.1.3 Mountain Wave Activity (MWA)**

a) Significant MWA occurs both below and above the floor of RVSM airspace, FL 290. MWA often occurs in western states in the vicinity of mountain ranges. It may occur when strong winds blow perpendicular to mountain ranges resulting in up and down or wave motions in the atmosphere. Wave action can produce altitude excursions and airspeed fluctuations accompanied by only light turbulence. With sufficient amplitude, however, wave action can induce altitude and airspeed fluctuations accompanied by severe turbulence. MWA is difficult to forecast and can be highly localized and short lived.

b) Wave activity is not necessarily limited to the vicinity of mountain ranges. Pilots experiencing wave activity anywhere that significantly affects altitude-keeping can follow the guidance provided below.

c) Inflight MWA Indicators (Including Turbulence). Indicators that the aircraft is being subjected to MWA are:

- 1) Altitude excursions and/or airspeed fluctuations with or without associated turbulence.
- 2) Pitch and trim changes required to maintain altitude with accompanying airspeed fluctuations.
- 3) Light to severe turbulence depending on the magnitude of the MWA.

### **38.6.1.4 Priority for Controller Application of Merging Target Procedures**

a) **Explanation of Merging Target Procedures.** As described in subparagraph 38.6.3.3 below, ATC will use “merging target procedures” to mitigate the effects of both severe turbulence and MWA. The procedures in subparagraph 38.6.3.3 have been adapted from existing procedures published in FAA Order JO 7110.65, Air Traffic Control, paragraph 5-1-4, Merging Target Procedures. paragraph 5-1-4 calls for en route controllers to advise pilots of potential traffic that they perceive may fly directly above or below his/her aircraft at minimum vertical separation. In response, pilots are given the option of requesting a radar vector to ensure their radar target will not merge or overlap with the traffic’s radar target.

b) The provision of “merging target procedures” to mitigate the effects of severe turbulence and/or MWA is not optional for the controller, but rather is a priority responsibility. Pilot requests for vectors for traffic avoidance when encountering MWA or pilot reports of “Unable RVSM due turbulence or MWA” are considered first priority aircraft separation and sequencing responsibilities. (FAA Order JO 7110.65, paragraph 2-1-2, Duty Priority, states that the controller’s first priority is to separate aircraft and issue safety alerts).

c) Explanation of the term “traffic permitting.” The contingency actions for MWA and severe turbulence detailed in Paragraph 38.9, Contingency Actions: Weather Encounters and Aircraft System Failures that Occur

After Entry into RVSM Airspace, state that the controller will “vector aircraft to avoid merging targets with traffic at adjacent flight levels, traffic permitting.” The term “traffic permitting” is not intended to imply that merging target procedures are not a priority duty. The term is intended to recognize that, as stated in FAA Order JO 7110.65, paragraph 2-1-2, Duty Priority, there are circumstances when the controller is required to perform more than one action and must “exercise their best judgment based on the facts and circumstances known to them” to prioritize their actions. Further direction given is: “That action which is most critical from a safety standpoint is performed first.”

**38.6.1.5 TCAS Sensitivity.** For both MWA and severe turbulence encounters in RVSM airspace, an additional concern is the sensitivity of collision avoidance systems when one or both aircraft operating in close proximity receive TCAS advisories in response to disruptions in altitude hold capability.

**38.6.2 Pre-flight tools.** Sources of observed and forecast information that can help the pilot ascertain the possibility of MWA or severe turbulence are: Forecast Winds and Temperatures Aloft (FD), Area Forecast (FA), Graphical Turbulence Guidance (GTG), SIGMETs and PIREPs.

### **38.6.3 Pilot Actions When Encountering Weather (for example, Severe Turbulence or MWA)**

**38.6.3.1 Weather Encounters Inducing Altitude Deviations of Approximately 200 feet.** When the pilot experiences weather induced altitude deviations of approximately 200 feet, the pilot will contact ATC and state “Unable RVSM Due (state reason)” (e.g., turbulence, mountain wave). See contingency actions in paragraph 38.9.

**38.6.3.2 Severe Turbulence (including that associated with MWA).** When pilots encounter severe turbulence, they should contact ATC and report the situation. Until the pilot reports clear of severe turbulence, the controller will apply merging target vectors to one or both passing aircraft to prevent their targets from merging:

**EXAMPLE-**

*“Yankee 123, FL 310, unable RVSM due severe turbulence.”*

*“Yankee 123, fly heading 290; traffic twelve o’clock, 10 miles, opposite direction; eastbound MD-80 at FL 320” (or the controller may issue a vector to the MD-80 traffic to avoid Yankee 123).*

**38.6.3.3 MWA.** When pilots encounter MWA, they should contact ATC and report the magnitude and location of the wave activity. When a controller makes a merging targets traffic call, the pilot may request a vector to avoid flying directly over or under the traffic. In situations where the pilot is experiencing altitude deviations of 200 feet or greater, the pilot will request a vector to avoid traffic. Until the pilot reports clear of MWA, the controller will apply merging target vectors to one or both passing aircraft to prevent their targets from merging:

**EXAMPLE-**

*“Yankee 123, FL 310, unable RVSM due mountain wave.”*

*“Yankee 123, fly heading 290; traffic twelve o’clock, 10 miles, opposite direction; eastbound MD-80 at FL 320” (or the controller may issue a vector to the MD-80 traffic to avoid Yankee 123).*

**38.6.3.4 FL Change or Re-route.** To leave airspace where MWA or severe turbulence is being encountered, the pilot may request a FL change and/or re-route, if necessary.

## **38.7 Guidance on Wake Turbulence**

**38.7.1** Pilots should be aware of the potential for wake turbulence encounters in RVSM airspace. Experience gained since 1997 has shown that such encounters in RVSM airspace are generally moderate or less in magnitude.

**38.7.2** Prior to DRVSM implementation, the FAA established provisions for pilots to report wake turbulence events in RVSM airspace using the NASA Aviation Safety Reporting System (ASRS). A “Safety Reporting” section established on the FAA RVSM Documentation webpage provides contacts, forms, and reporting procedures.

**38.7.3** To date, wake turbulence has not been reported as a significant factor in DRVSM operations. European authorities also found that reports of wake turbulence encounters did not increase significantly after RVSM

implementation (eight versus seven reports in a ten-month period). In addition, they found that reported wake turbulence was generally similar to moderate clear air turbulence.

#### **38.7.4 Pilot Action to Mitigate Wake Turbulence Encounters**

**38.7.4.1** Pilots should be alert for wake turbulence when operating:

- a) In the vicinity of aircraft climbing or descending through their altitude.
- b) Approximately 10–30 miles after passing 1,000 feet below opposite-direction traffic.
- c) Approximately 10–30 miles behind and 1,000 feet below same-direction traffic.

**38.7.4.2** Pilots encountering or anticipating wake turbulence in DRVSM airspace have the option of requesting a vector, FL change, or if capable, a lateral offset.

**NOTE–**

1. *Offsets of approximately a wing span upwind generally can move the aircraft out of the immediate vicinity of another aircraft's wake vortex.*
2. *In domestic U.S. airspace, pilots must request clearance to fly a lateral offset. Strategic lateral offsets flown in oceanic airspace do not apply.*

#### **38.8 Pilot/Controller Phraseology**

TBL ENR 1.1–4 shows standard phraseology that pilots and controllers will use to communicate in DRVSM operations.

**TBL ENR 1.1–4  
Pilot/Controller Phraseology**

<b>Message</b>	<b>Phraseology</b>
For a controller to ascertain the RVSM approval status of an aircraft:	(call sign) confirm RVSM approved
Pilot indication that flight is RVSM approved	Affirm RVSM
Pilot report of lack of RVSM approval (non–RVSM status). Pilot will report non–RVSM status, as follows: <b>a.</b> On the initial call on any frequency in the RVSM airspace and . . . <b>b.</b> In all requests for flight level changes pertaining to flight levels within the RVSM airspace and . . . <b>c.</b> In all read backs to flight level clearances pertaining to flight levels within the RVSM airspace and . . . <b>d.</b> In read back of flight level clearances involving climb and descent through RVSM airspace (FL 290 – 410)	Negative RVSM, (supplementary information, e.g., “Certification flight”).
Pilot report of one of the following after entry into RVSM airspace: all primary altimeters, automatic altitude control systems or altitude alerters have failed. (See Paragraph 38.9, Contingency Actions: Weather Encounters and Aircraft System Failures that Occur After Entry into RVSM Airspace).  <b>NOTE–</b> <i>This phrase is to be used to convey both the initial indication of RVSM aircraft system failure and on initial contact on all frequencies in RVSM airspace until the problem ceases to exist or the aircraft has exited RVSM airspace.</i>	Unable RVSM Due Equipment
ATC denial of clearance into RVSM airspace	Unable issue clearance into RVSM airspace, maintain FL
*Pilot reporting inability to maintain cleared flight level due to weather encounter. (See Paragraph 38.9, Contingency Actions: Weather Encounters and Aircraft System Failures that Occur after Entry into RVSM Airspace).	*Unable RVSM due (state reason) (e.g., turbulence, mountain wave)
ATC requesting pilot to confirm that an aircraft has regained RVSM–approved status or a pilot is ready to resume RVSM	Confirm able to resume RVSM
Pilot ready to resume RVSM after aircraft system or weather contingency	Ready to resume RVSM

**38.9 Contingency Actions: Weather Encounters and Aircraft System Failures that Occur After Entry into RVSM Airspace**

TBL ENR 1.1–5 provides pilot guidance on actions to take under certain conditions of aircraft system failure that occur after entry into RVSM airspace and weather encounters. It also describes the expected ATC controller actions in these situations. It is recognized that the pilot and controller will use judgment to determine the action most appropriate to any given situation.

TBL ENR 1.1-5

**Contingency Actions: Weather Encounters and Aircraft System Failures that Occur After Entry into RVSM Airspace**

<b>Initial Pilot Actions in Contingency Situations</b>	
<p>Initial pilot actions when unable to maintain flight level (FL) or unsure of aircraft altitude—keeping capability:</p> <ul style="list-style-type: none"> <li>•Notify ATC and request assistance as detailed below.</li> <li>•Maintain cleared flight level, to the extent possible, while evaluating the situation.</li> <li>•Watch for conflicting traffic both visually and by reference to TCAS, if equipped.</li> <li>•Alert nearby aircraft by illuminating exterior lights (commensurate with aircraft limitations).</li> </ul>	
<b>Severe Turbulence and/or Mountain Wave Activity (MWA) Induced Altitude Deviations of Approximately 200 feet</b>	
<p><b>Pilot will:</b></p> <ul style="list-style-type: none"> <li>•When experiencing severe turbulence and/or MWA induced altitude deviations of approximately 200 feet or greater, pilot will contact ATC and state “Unable RVSM Due (state reason)” (e.g., turbulence, mountain wave)</li> <li>•If not issued by the controller, request vector clear of traffic at adjacent FLs</li> <li>•If desired, request FL change or re-route</li> <li>•Report location and magnitude of turbulence or MWA to ATC</li> </ul> <p>See Paragraph 38.6, Guidance on Severe Turbulence and Mountain Wave Activity (MWA), for detailed guidance.</p>	<p><b>Controller will:</b></p> <ul style="list-style-type: none"> <li>•Vector aircraft to avoid merging target with traffic at adjacent flight levels, traffic permitting</li> <li>•Advise pilot of conflicting traffic</li> <li>•Issue FL change or re-route, traffic permitting</li> <li>•Issue PIREP to other aircraft</li> </ul> <p>Paragraph 38.6 explains “traffic permitting.”</p>
<b>Mountain Wave Activity (MWA) Encounters – General</b>	
<p><b>Pilot actions:</b></p> <ul style="list-style-type: none"> <li>•Contact ATC and report experiencing MWA</li> <li>•If so desired, pilot may request a FL change or re-route</li> <li>•Report location and magnitude of MWA to ATC</li> </ul> <p>See paragraph 38.6 for guidance on MWA.</p>	<p><b>Controller actions:</b></p> <ul style="list-style-type: none"> <li>•Advise pilot of conflicting traffic at adjacent FL</li> <li>•If pilot requests, vector aircraft to avoid merging target with traffic at adjacent RVSM flight levels, traffic permitting</li> <li>•Issue FL change or re-route, traffic permitting</li> <li>•Issue PIREP to other aircraft</li> </ul> <p>Paragraph 38.6 explains “traffic permitting.”</p>
<p><i>NOTE— MWA encounters do not necessarily result in altitude deviations on the order of 200 feet. The guidance below is intended to address less significant MWA encounters.</i></p>	

<b>Wake Turbulence Encounters</b>	
<p><b>Pilot should:</b></p> <ul style="list-style-type: none"> <li>•Contact ATC and request vector, FL change or, if capable, a lateral offset</li> </ul> <p>See Paragraph 38.7, Guidance on Wake Turbulence.</p>	<p><b>Controller should:</b></p> <ul style="list-style-type: none"> <li>•Issue vector, FL change or lateral offset clearance, traffic permitting</li> </ul> <p>Paragraph 38.6 explains “traffic permitting.”</p>
<b>“Unable RVSM Due Equipment” Failure of Automatic Altitude Control System, Altitude Alerter or All Primary Altimeters</b>	
<p><b>Pilot will:</b></p> <ul style="list-style-type: none"> <li>•Contact ATC and state “Unable RVSM Due Equipment”</li> <li>•Request clearance out of RVSM airspace unless operational situation dictates otherwise</li> </ul>	<p><b>Controller will:</b></p> <ul style="list-style-type: none"> <li>•Provide 2,000 feet vertical separation or appropriate horizontal separation</li> <li>•Clear aircraft out of RVSM airspace unless operational situation dictates otherwise</li> </ul>
<b>One Primary Altimeter Remains Operational</b>	
<p><b>Pilot will:</b></p> <ul style="list-style-type: none"> <li>•Cross check stand-by altimeter</li> <li>•Notify ATC of operation with single primary altimeter</li> <li>•If unable to confirm primary altimeter accuracy, follow actions for failure of all primary altimeters</li> </ul>	<p><b>Controller will:</b></p> <ul style="list-style-type: none"> <li>•Acknowledge operation with single primary altimeter</li> </ul>
<b>Transponder Failure</b>	
<p><b>Pilot will:</b></p> <ul style="list-style-type: none"> <li>•Contact ATC and request authority to continue to operate at cleared flight level</li> <li>•Comply with revised ATC clearance, if issued</li> </ul>	<p><b>Controller will:</b></p> <ul style="list-style-type: none"> <li>•Consider request to continue to operate at cleared flight level</li> <li>•Issue revised clearance, if necessary</li> </ul>
<p><b>NOTE-</b> 14 CFR Section 91.215 (ATC transponder and altitude reporting equipment and use) regulates operation with the transponder inoperative.</p>	

### 38.10 Procedures for Accommodation of Non-RVSM Aircraft

#### 38.10.1 General Policies for Accommodation of Non-RVSM Aircraft

**38.10.1.1** The RVSM mandate calls for only RVSM authorized aircraft/operators to fly in designated RVSM airspace with limited exceptions. The policies detailed below are intended exclusively for use by aircraft that the FAA has agreed to accommodate. They are not intended to provide other operators a means to circumvent the normal RVSM approval process.

**38.10.1.2** If either the operator is not authorized or the aircraft is not RVSM-compliant, the aircraft will be referred to as a “non-RVSM” aircraft. 14 CFR Section 91.180 and Part 91 Appendix G enable the FAA to authorize a deviation to operate a non-RVSM aircraft in RVSM airspace.

**38.10.1.3** Non–RVSM aircraft flights will be handled on a workload permitting basis. The vertical separation standard applied between aircraft not approved for RVSM and all other aircraft must be 2,000 feet.

**38.10.1.4 Required Pilot Calls.** The pilot of non–RVSM aircraft will inform the controller of the lack of RVSM approval in accordance with the direction provided in Paragraph 38.8, Pilot/Controller Phraseology.

### **38.10.2 Categories of Non–RVSM Aircraft that may be Accommodated**

Subject to FAA approval and clearance, the following categories of non–RVSM aircraft may operate in domestic U.S. RVSM airspace provided they have an operational transponder.

**38.10.2.1** Department of Defense (DOD) aircraft.

**38.10.2.2** Flights conducted for aircraft certification and development purposes.

**38.10.2.3** Active air ambulance flights utilizing a “MEDEVAC” call sign.

**38.10.2.4** Aircraft climbing/descending through RVSM flight levels (without intermediate level off) to/from FLs above RVSM airspace (Policies for these flights are detailed in paragraph 38.11, Non–RVSM Aircraft Requesting Climb to and Descent from Flight Levels Above RVSM Airspace Without Intermediate Level Off.

**38.10.2.5** Foreign State (government) aircraft.

**38.10.3** Methods for operators of non–RVSM aircraft to request access to RVSM Airspace. Operators may:

**38.10.3.1 LOA/MOU.** Enter into a Letter of Agreement (LOA)/Memorandum of Understanding (MOU) with the RVSM facility (the Air Traffic facility that provides air traffic services in RVSM airspace). Operators must comply with LOA/MOU.

**38.10.3.2 File–and–Fly.** File a flight plan to notify the FAA of their intention to request access to RVSM airspace.

#### **NOTE–**

*Priority for access to RVSM airspace will be afforded to RVSM compliant aircraft, then File–and–Fly flights.*

### **38.11 Non–RVSM Aircraft Requesting Climb to and Descent from Flight Levels Above RVSM Airspace Without Intermediate Level Off**

**38.11.1 File–and–Fly.** Operators of Non–RVSM aircraft climbing to and descending from RVSM flight levels should just file a flight plan.

**38.11.2** Non–RVSM aircraft climbing to and descending from flight levels above RVSM airspace will be handled on a workload permitting basis. The vertical separation standard applied in RVSM airspace between non–RVSM aircraft and all other aircraft must be 2,000 feet.

**38.11.3** Non–RVSM aircraft climbing to/descending from RVSM airspace can only be considered for accommodation provided:

**38.11.3.1** Aircraft is capable of a continuous climb/descent and does not need to level off at an intermediate altitude for any operational considerations and

**38.11.3.2** Aircraft is capable of climb/descent at the normal rate for the aircraft.

**38.11.4 Required Pilot Calls.** The pilot of non–RVSM aircraft will inform the controller of the lack of RVSM approval in accordance with the direction provided in paragraph 38.8, Pilot/Controller Phraseology.

## **39. Terminal Radar Services for VFR Aircraft**

### **39.1 Basic Radar Service**

**39.1.1** In addition to the use of radar for the control of IFR aircraft, all commissioned radar facilities provide the following basic radar services for VFR aircraft:

**39.1.1.1** Safety alerts.

**39.1.1.2** Traffic advisories.

**39.1.1.3** Limited radar vectoring (on a workload permitting basis).

**39.1.1.4** Sequencing at locations where procedures have been established for this purpose and/or when covered by a letter of agreement.

**NOTE-**

*When the stage services were developed, two basic radar services (traffic advisories and limited vectoring) were identified as “Stage I.” This definition became unnecessary and the term “Stage I” was eliminated from use. The term “Stage II” has been eliminated in conjunction with the airspace reclassification, and sequencing services to locations with local procedures and/or letters of agreement to provide this service have been included in basic services to VFR aircraft. These basic services will still be provided by all terminal radar facilities whether they include Class B, C, D, or E airspace. “Stage III” services have been replaced with “Class B” and “Terminal Radar Service Area” service where applicable.*

**39.1.2** Vectoring service may be provided when requested by the pilot or with pilot concurrence when suggested by ATC.

**39.1.3** Pilots of arriving aircraft should contact approach control on the publicized frequency and give their position, altitude, aircraft call sign, type aircraft, radar beacon code (if transponder equipped), destination, and should request traffic information.

**39.1.4** Approach control will issue wind and runway, except when the pilot states “have numbers” or this information is contained in the ATIS broadcast and the pilot states that the current ATIS information has been received. Traffic information is provided on a workload permitting basis. Approach control will specify the time or place at which the pilot is to contact the tower on local control frequency for further landing information. Radar service is automatically terminated and the aircraft need not be advised of termination when an arriving VFR aircraft receiving radar services to a tower-controlled airport where basic radar service is provided has landed, or to all other airports, is instructed to change to tower or advisory frequency.

**39.1.5** Sequencing for VFR aircraft is available at certain terminal locations (see locations listed in the Chart Supplement U.S.). The purpose of the service is to adjust the flow of arriving VFR and IFR aircraft into the traffic pattern in a safe and orderly manner and to provide radar traffic information to departing VFR aircraft. Pilot participation is urged but is not mandatory. Traffic information is provided on a workload permitting basis. Standard radar separation between VFR or between VFR and IFR aircraft is not provided.

**39.1.5.1** Pilots of arriving VFR aircraft should initiate radio contact on the publicized frequency with approach control when approximately 25 miles from the airport at which sequencing services are being provided. On initial contact by VFR aircraft, approach control will assume that sequencing service is requested. After radar contact is established, the pilot may use pilot navigation to enter the traffic pattern or, depending on traffic conditions, approach control may provide the pilot with routings or vectors necessary for proper sequencing with other participating VFR and IFR traffic en route to the airport. When a flight is positioned behind a preceding aircraft and the pilot reports having that aircraft in sight, the pilot will be instructed to follow the preceding aircraft. **THE ATC INSTRUCTION TO FOLLOW THE PRECEDING AIRCRAFT DOES NOT AUTHORIZE THE PILOT TO COMPLY WITH ANY ATC CLEARANCE OR INSTRUCTION ISSUED TO THE PRECEDING AIRCRAFT.** If other “nonparticipating” or “local” aircraft are in the traffic pattern, the tower will issue a landing sequence. If an arriving aircraft does not want radar service, the pilot should state “NEGATIVE RADAR SERVICE” or make a similar comment, on initial contact with approach control.

**39.1.5.2** Pilots of departing VFR aircraft are encouraged to request radar traffic information by notifying ground control, or where applicable, clearance delivery, on initial contact with their request and proposed direction of flight.

**EXAMPLE-**

*Xray ground control, November One Eight Six, Cessna One Seventy Two, ready to taxi, VFR southbound at 2,500, have information bravo and request radar traffic information.*

**NOTE-**

*Following takeoff, the tower will advise when to contact departure control.*



**39.1.5.3** Pilots of aircraft transiting the area and in radar contact/communication with approach control will receive traffic information on a controller workload permitting basis. Pilots of such aircraft should give their position, altitude, aircraft call sign, aircraft type, radar beacon code (if transponder equipped), destination, and/or route of flight.

**39.2 Terminal Radar Service Area (TRSA) Service (Radar Sequencing and Separation Service for VFR Aircraft in a TRSA).**

**39.2.1** This service has been implemented at certain terminal locations. The service is advertised in the Chart Supplement U.S. The purpose of this service is to provide separation between all participating VFR aircraft and all IFR aircraft operating within the airspace defined as the TRSA. Pilot participation is urged but is not mandatory.

**39.2.2** If any aircraft does not want the service, the pilot should state “NEGATIVE TRSA SERVICE” or make a similar comment, on initial contact with approach control or ground control, as appropriate.

**39.2.3** TRSAs are depicted on sectional aeronautical charts and listed in the Chart Supplement U.S.

**39.2.4** While operating within a TRSA, pilots are provided TRSA service and separation as prescribed in this paragraph. In the event of a radar outage, separation and sequencing of VFR aircraft will be suspended as this service is dependent on radar. The pilot will be advised that the service is not available and will be issued wind, runway information, and the time or place to contact the tower. Traffic information will be provided on a workload permitting basis.

**39.2.5** Visual separation is used when prevailing conditions permit and it will be applied as follows:

**39.2.5.1** When a VFR flight is positioned behind a preceding aircraft and the pilot reports having that aircraft in sight, the pilot will be instructed by ATC to follow the preceding aircraft. **THE ATC INSTRUCTION TO FOLLOW THE PRECEDING AIRCRAFT DOES NOT AUTHORIZE THE PILOT TO COMPLY WITH ANY ATC CLEARANCE OR INSTRUCTION ISSUED TO THE PRECEDING AIRCRAFT.** Radar service will be continued to the runway.

**39.2.5.2** If other “nonparticipating” or “local” aircraft are in the traffic pattern, the tower will issue a landing sequence.

**39.2.5.3** Departing VFR aircraft may be asked if they can visually follow a preceding departure out of the TRSA. The pilot will be instructed to follow the other aircraft provided that the pilot can maintain visual contact with that aircraft.

**39.2.6** Participating VFR aircraft will be separated from IFR and other participating VFR aircraft by one of the following:

**39.2.6.1** 500 feet vertical separation.

**39.2.6.2** Visual separation.

**39.2.6.3** Target resolution (a process to ensure that correlated radar targets do not touch).

**39.2.7** Participating pilots operating VFR in a TRSA:

**39.2.7.1** Must maintain an altitude when assigned by ATC unless the altitude assignment is to maintain at or below a specified altitude. ATC may assign altitudes for separation that do not conform to 14 CFR Section 91.159. When the altitude assignment is no longer needed for separation or when leaving the TRSA, the instruction will be broadcast, “RESUME APPROPRIATE VFR ALTITUDES.” Pilots must then return to an altitude that conforms to 14 CFR Section 91.159 as soon as practicable.

**39.2.7.2** When not assigned an altitude, the pilot should coordinate with ATC prior to any altitude change.

**39.2.8** Within the TRSA, traffic information on observed but unidentified targets will, to the extent possible, be provided to all IFR and participating VFR aircraft. The pilot will be vectored upon request to avoid the observed traffic, provided the aircraft to be vectored is within the airspace under the jurisdiction of the controller.

**39.2.9** Departing aircraft should inform ATC of their intended destination and/or route of flight and proposed cruising altitude.

**39.2.10** ATC will normally advise participating VFR aircraft when leaving the geographical limits of the TRSA. Radar service is not automatically terminated with this advisory unless specifically stated by the controller.

**39.3 Class C Service.** This service provides, in addition to basic radar service, approved separation between IFR and VFR aircraft, and sequencing of VFR arrivals to the primary airport.

**39.4 Class B Service.** This service provides, in addition to basic radar service, approved separation of aircraft based on IFR, VFR, and/or weight, and sequencing of VFR arrivals to the primary airport(s).

**39.5 PILOT RESPONSIBILITY.** THESE SERVICES ARE NOT TO BE INTERPRETED AS RELIEVING PILOTS OF THEIR RESPONSIBILITIES TO SEE AND AVOID OTHER TRAFFIC OPERATING IN BASIC VFR WEATHER CONDITIONS, TO ADJUST THEIR OPERATIONS AND FLIGHT PATH AS NECESSARY TO PRECLUDE SERIOUS WAKE ENCOUNTERS, TO MAINTAIN APPROPRIATE TERRAIN AND OBSTRUCTION CLEARANCE, OR TO REMAIN IN WEATHER CONDITIONS EQUAL TO OR BETTER THAN THE MINIMUMS REQUIRED BY 14 CFR SECTION 91.155. WHENEVER COMPLIANCE WITH AN ASSIGNED ROUTE, HEADING AND/OR ALTITUDE IS LIKELY TO COMPROMISE PILOT RESPONSIBILITY RESPECTING TERRAIN AND OBSTRUCTION CLEARANCE, VORTEX EXPOSURE, AND WEATHER MINIMUMS, APPROACH CONTROL SHOULD BE SO ADVISED AND A REVISED CLEARANCE OR INSTRUCTION OBTAINED.

**39.6** ATC services for VFR aircraft participating in terminal radar services are dependent on ATC radar. Services for VFR aircraft are not available during periods of radar outages. The pilot will be advised when VFR services are limited or not available.

**NOTE-**

*Class B and Class C airspace are areas of regulated airspace. The absence of ATC radar does not negate the requirement of an ATC clearance to enter Class B airspace or two-way radio contact with ATC to enter Class C airspace.*

## **40. Tower En Route Control (TEC)**

**40.1** TEC is an ATC program to provide a service to aircraft proceeding to and from metropolitan areas. It links designated approach control areas by a network of identified routes made up of the existing airway structure of the National Airspace System. The FAA has initiated an expanded TEC program to include as many facilities as possible. The program's intent is to provide an overflow resource in the low altitude system which would enhance ATC services. A few facilities have historically allowed turbojets to proceed between certain city pairs, such as Milwaukee and Chicago, via tower en route and these locations may continue this service. However, the expanded TEC program will be applied, generally, for nonturbojet aircraft operating at and below 10,000 feet. The program is entirely within the approach control airspace of multiple terminal facilities. Essentially, it is for relatively short flights. Participating pilots are encouraged to use TEC for flights of 2 hours duration or less. If longer flights are planned, extensive coordination may be required with the multiple complex which could result in unanticipated delays.

**40.2** There are no unique requirements upon pilots to use the TEC program. Normal flight plan filing procedures will ensure proper flight plan processing. Pilots should include the acronym "TEC" in the remarks selection of the flight plan when requesting tower en route.

**40.3** All approach controls in the system may not operate up to the maximum TEC altitude of 10,000 feet. IFR flight may be planned to any satellite airport in proximity to the major primary airport via the same routing.

## **41. Services in Offshore Controlled Airspace**

**41.1** Pilots requesting TEC are subject to the same delay factor at the destination airport as other aircraft in the ATC system. In addition, departure and en route delays may occur depending upon individual facility workload. When a major metropolitan airport is incurring significant delays, pilots in the TEC program may want to consider an alternative airport experiencing no delay.

**41.2** Flights which operate between the U.S. 3–mile territorial limit and the adjoining oceanic controlled airspace/flight information region (CTA/FIR) boundaries generally operate in airspace designated by federal regulation as “controlled airspace,” or “offshore controlled airspace.”

**41.3** Within the designated areas ATC radar surveillance, ground based navigational signal coverage, and air/ground communications are capable of supporting air traffic services comparable to those provided over U.S. domestic controlled airspace.

**41.4** Pilots should be aware that domestic procedures will be applied in offshore controlled airspace to both VFR and IFR aircraft using ATC services.

## **42. Pilot/Controller Roles/Responsibilities**

### **42.1 General**

**42.1.1** The roles and responsibilities of the pilot and controller for effective participation in the ATC system are contained in several documents. Pilot responsibilities are in the Federal Aviation Regulations (Title 14 of the U.S. Code of Federal Regulations) and the air traffic controller’s are in FAA Order JO 7110.65, Air Traffic Control, and supplemental FAA directives. Additional and supplemental information for pilots can be found in the current Aeronautical Information Manual, Notices to Air Missions, advisory circulars, and aeronautical charts. Since there are many other excellent publications produced by nongovernment organizations as well as other Government organizations with various updating cycles, questions concerning the latest or most current material can be resolved by cross–checking with the above mentioned documents.

**42.1.2** The pilot in command of an aircraft is directly responsible for and is the final authority as to the safe operation of that aircraft. In an emergency requiring immediate action, the pilot in command may deviate from any rule in the General, Subpart A, and Flight Rules, Subpart B, in accordance with 14 CFR Section 91.3.

**42.1.3** The air traffic controller is responsible to give first priority to the separation of aircraft and to the issuance of radar safety alerts; second priority to other services that are required, but do not involve separation of aircraft; and third priority to additional services to the extent possible.

**42.1.4** In order to maintain a safe and efficient air traffic system, it is necessary that every party fulfill their responsibilities to the fullest.

**42.1.5** The responsibilities of the pilot and the controller intentionally overlap in many areas providing a degree of redundancy. Should one or the other fail in any manner, this overlapping responsibility is expected to compensate, in many cases, for failures that may affect safety.

**42.1.6** The following, while not intended to be all inclusive, is a brief listing of pilot and controller responsibilities for some commonly used procedures or phases of flight. More detailed explanations are contained in the appropriate Federal Aviation Regulations, Advisory Circulars, and similar publications. The information provided here is an overview of the principles involved and is not meant as an interpretation of the rules nor is it intended to extend or diminish responsibilities.

### **42.2 Air Traffic Clearance**

#### **42.2.1 Pilot**

**42.2.1.1** Acknowledges receipt and understanding of an ATC clearance.

**42.2.1.2** Reads back any hold short of runway instructions issued by ATC.

**42.2.1.3** Requests clarification or amendment, as appropriate, any time a clearance is not fully understood, or considered unacceptable from a safety standpoint.

**42.2.1.4** Promptly complies with an air traffic clearance upon receipt, except as necessary to cope with an emergency. Advises ATC as soon as possible and obtains an amended clearance if deviation is necessary.

#### **NOTE–**

*A clearance to land means that appropriate separation on the landing runway will be ensured. A landing clearance does not relieve the pilot from compliance with any previously issued altitude crossing restriction.*

## **42.2.2 Controller**

**42.2.2.1** Issues appropriate clearances for the operation being, or to be, conducted in accordance with established criteria.

**42.2.2.2** Assigns altitudes in IFR clearances that are at or above the minimum IFR altitudes in Classes A, B, C, D, and E airspace.

**42.2.2.3** Ensures acknowledgements by the pilot for issued information, clearance, or instructions.

**42.2.2.4** Ensures that readbacks by the pilot of altitude, heading, or other items are correct. If incorrect, distorted, or incomplete, makes corrections as appropriate.

## **42.3 Contact Approach**

### **42.3.1 Pilot**

**42.3.1.1** This approach must be requested by the pilot and is made in lieu of a standard or special instrument approach.

**42.3.1.2** By requesting the contact approach, the pilot indicates that the flight is operating clear of clouds, has at least 1 mile flight visibility, and can reasonably expect to continue to the destination airport in those conditions.

**42.3.1.3** Be aware that while conducting a contact approach, the pilot assumes responsibility for obstruction clearance.

**42.3.1.4** Advises ATC immediately if you are unable to continue the contact approach or if you encounter less than 1 mile flight visibility.

**42.3.1.5** Be aware that, if radar service is being received, it may automatically terminate when the pilot is told to contact the tower. “Radar service terminated” is used by ATC to inform a pilot that he/she will no longer be provided any of the services that could be received while in radar contact.

#### **REFERENCE-**

*The Pilot/Controller Glossary is published in the Aeronautical Information Manual (AIM) and FAA Orders JO 7110.10, Flight Services, and JO 7110.65, Air Traffic Control.*

### **42.3.2 Controller**

**42.3.2.1** Issues clearance for contact approach only when requested by the pilot. Does not solicit the use of this procedure.

**42.3.2.2** Before issuing clearance, ascertains that reported ground visibility at destination airport is at least 1 mile.

**42.3.2.3** Provides approved separation between aircraft cleared for contact approach and other IFR or special VFR aircraft. When using vertical separation, does not assign a fixed altitude but clears the aircraft at or below an altitude which is at least 1,000 feet below any IFR traffic but not below minimum safe altitudes prescribed in 14 CFR Section 91.119.

**42.3.2.4** Issues alternative instructions if, in the controller’s judgment, weather conditions may make completion of the approach impractical.

## **42.4 Instrument Approach**

### **42.4.1 Pilot**

**42.4.1.1** Be aware that the controller issues clearance for approach based only on known traffic.

**42.4.1.2** Follows the procedures as shown on the instrument approach chart including all restrictive notations, such as:

- a) Procedure not authorized at night.
- b) Approach not authorized when local area altimeter not available.

- c) Procedure not authorized when control tower not in operation.
- d) Procedure not authorized when glide slope not used.
- e) Straight-in minimums not authorized at night.
- f) Radar required.

g) The circling minimums published on the instrument approach chart provide adequate obstruction clearance. The pilot should not descend below the circling altitude until the aircraft is in a position to make final descent for landing. Sound judgment and knowledge of the pilot's and the aircraft's capabilities are the criteria for a pilot to determine the exact maneuver in each instance since airport design and the aircraft position, altitude, and airspeed must all be considered. (See ENR 1.5, Paragraph 11.6, Circling Minimums.)

**42.4.1.3** Upon receipt of an approach clearance while on an unpublished route or being radar vectored:

- a) Complies with the minimum altitude for IFR.
- b) Maintains last assigned altitude until established on a segment of a published route or Instrument Approach Procedure (IAP), at which time published altitudes apply.

**42.4.1.4** There are currently two temperature limitations that may be published in the notes box of the middle briefing strip on an instrument approach procedure (IAP). The two published temperature limitations are:

- a) A temperature range limitation associated with the use of Baro-VNAV that may be published on an United States PBN IAP titled RNAV (GPS) or RNAV (RNP); and/or
- b) A Cold Temperature Airport (CTA) limitation designated by a snowflake ICON and temperature in Celsius (C) that is published on every IAP for the airfield.

**42.4.1.5** Any planned altitude correction for the intermediate and/or missed approach holding segments must be coordinated with ATC. Pilots do not have to advise ATC of a correction in the final segment.

**REFERENCE–**

*AIP, Section ENR 1.8, Cold Temperature Barometric Altimeter Errors, Setting Procedures, and Cold Temperature Airports (CTA).*

**42.4.2 Controller**

**42.4.2.1** Issues an approach clearance based on known traffic.

**42.4.2.2** Issues an IFR approach clearance only after aircraft is established on a segment of published route or IAP; or assigns an appropriate altitude for the aircraft to maintain until so established.

**42.5 Missed Approach**

**42.5.1 Pilot**

**42.5.1.1** Executes a missed approach when one of the following conditions exist:

- a) Arrival at the missed approach point (MAP) or the decision height (DH) and visual reference to the runway environment is insufficient to complete the landing.
- b) Determines that a safe approach or landing is not possible (see ENR 1.5 paragraph 27.8).
- c) Instructed to do so by ATC.

**42.5.1.2** Advises ATC that a missed approach will be made. Include the reason for the missed approach unless initiated by ATC.

**42.5.1.3** Complies with the missed approach instructions for the IAP being executed from the MAP, unless other missed approach instructions are specified by ATC.

**42.5.1.4** If executing a missed approach prior to reaching the MAP, fly the lateral navigation path of the instrument procedure to the MAP. Climb to the altitude specified in the missed approach procedure, except when a maximum altitude is specified between the final approach fix (FAF) and the MAP. In that case, comply with the maximum altitude restriction. Note, this may require a continued descent on the final approach.

**42.5.1.5** Cold Temperature Airports (CTA) are designated by a snowflake ICON and temperature in Celsius (C) that are published in the notes box of the middle briefing strip on an instrument approach procedure (IAP). Pilots should apply a cold temperature correction to the final missed approach holding altitude when the reported temperature is at or below the CTA temperature limitation, if applicable. Pilots must inform ATC of the correction.

**REFERENCE–**

*AIP, Section ENR 1.8, Cold Temperature Barometric Altimeter Errors, Setting Procedures, and Cold Temperature Airports (CTA).*

**42.5.1.6** Following a missed approach, requests clearance for specific action; i.e., another approach, hold for improved conditions, proceed to an alternate airport, etc.

**42.5.2 Controller**

**42.5.2.1** Issues an approved alternate missed approach procedure if it is desired that the pilot execute a procedure other than as depicted on the instrument approach chart.

**42.5.2.2** May vector a radar identified aircraft executing a missed approach when operationally advantageous to the pilot or the controller.

**42.5.2.3** In response to the pilot's stated intentions, issues a clearance to an alternate airport, to a holding fix, or for reentry into the approach sequence, as traffic conditions permit.

**42.6 Vectors**

**42.6.1 Pilot**

**42.6.1.1** Promptly complies with headings and altitudes assigned to you by the controller.

**42.6.1.2** Questions any assigned heading or altitude believed to be incorrect.

**42.6.1.3** If operating VFR and compliance with any radar vector or altitude would cause a violation of any Federal Aviation Regulation, advises ATC and obtain a revised clearance or instruction.

**42.6.2 Controller**

**42.6.2.1 Vectors aircraft in Class A, B, C, D, and E airspace:**

- a) For separation.
- b) For noise abatement.
- c) To obtain an operational advantage for the pilot or the controller.

**42.6.2.2** Vectors aircraft in Class A, B, C, D, E, and G airspace when requested by the pilot.

**42.6.2.3** Except where authorized for radar approaches, radar departures, special VFR, or when operating in accordance with vectors below minimum altitude procedures, vector IFR aircraft at or above minimum vectoring altitudes.

**42.6.2.4** May vector aircraft off assigned procedures. When published altitude or speed restrictions are included, controllers must assign an altitude, or if necessary, a speed.

**42.6.2.5** May vector VFR aircraft, not at an ATC assigned altitude, at any altitude. In these cases, terrain separation is the pilot's responsibility.

**42.7 Speed Adjustments**

**42.7.1 Pilot (In U.S. Domestic Class A, B, C, D, and E airspace)**

**42.7.2** Except as stated in paragraphs 42.7.5 and 42.7.6, advises ATC anytime the true airspeed at cruising level varies or is expected to vary by plus or minus 10 knots or 0.02 Mach number, whichever is less, of the filed true airspeed.

**42.7.3** Complies with speed adjustments from ATC unless:

**42.7.3.1** Except as stated in paragraphs 42.7.5 and 42.7.6, advises ATC anytime the true airspeed at cruising level varies or is expected to vary by plus or minus 10 knots or 0.02 Mach number, whichever is less, of the filed true airspeed.

**42.7.3.2** Complies with speed adjustments from ATC unless:

a) The minimum or maximum safe airspeed for any particular operation is greater or less than the requested airspeed. In such cases, advises ATC.

b) Operating at or above 10,000 feet MSL on an ATC assigned SPEED ADJUSTMENT of more than 250 knots IAS and subsequent clearance is received for descent below 10,000 feet MSL. In such cases, pilots are expected to comply with 14 CFR Section 97.117(a).

**42.7.4** Controller (In U.S. Domestic Class A, B, C, D, and E Airspaces)

**42.7.4.1** Assigns aircraft to speed adjustments when necessary, but not as a substitute for good vectoring technique.

**42.7.4.2** Adheres to the restrictions of FAA Order JO 7110.65, Air Traffic Control, as to when speed adjustment procedures may be applied.

**42.7.4.3** Avoids speed adjustments requiring alternate decreases and increases.

**42.7.4.4** Assigns speed adjustments to a specified IAS knots/Mach number or to increase or decrease speed utilizing increments of 5 knots or multiples thereof.

**42.7.4.5** Terminates ATC-assigned speed adjustments when no longer required by issuing further instructions to pilots in the following manner:

a) Advises pilots to “resume normal speed” when the aircraft is on a heading, random routing, charted procedure, or route without published speed restrictions.

b) Instructs pilots to “comply with speed restrictions” when the aircraft is joining or resuming a charted procedure or route with published speed restrictions.

**CAUTION-**

*The phraseology “Climb via SID” requires compliance with all altitude and/or speed restrictions depicted on the procedure.*

c) Instructs pilots to “resume published speed” when aircraft are cleared via a charted instrument flight procedure that contains published speed restrictions.

d) Advises aircraft to “delete speed restrictions” when ATC assigned or published speed restrictions on a charted procedure are no longer required.

e) Clears pilots for approach without restating previously issued speed adjustments.

**42.7.4.6** Gives due consideration to aircraft capabilities to reduce speed while descending.

**42.7.5 Pilot (In Oceanic Class A and E Airspace)**

**42.7.5.1** If ATC has not assigned an airspeed, advises ATC anytime the true airspeed at cruising level varies or is expected to vary by  $\pm 10$  knots or 0.02 Mach number, whichever is less, of the filed true airspeed.

**42.7.5.2** If ATC has assigned an airspeed, aircraft must adhere to the ATC assigned airspeed and must request ATC approval before making any change thereto. If it is essential to make an immediate temporary change in the Mach number (e.g., due to turbulence), ATC must be notified as soon as possible. If it is not feasible, due to aircraft performance, to maintain the last assigned Mach number during an en route climb or descent, advises ATC at the time of the request.

**42.7.6 Controller (In Oceanic Class A and E Airspace)**

**42.7.6.1** Assigns airspeed when necessary for separation of aircraft to comply with 14 CFR, ICAO regulations and procedures, or letters of agreement.

**42.8 Traffic Advisories (Traffic Information)**

**42.8.1 Pilot**

**42.8.1.1** Acknowledges receipt of traffic advisories.

**42.8.1.2** Informs controller if traffic is in sight.

**42.8.1.3** Advises ATC if a vector to avoid traffic is desired.

**42.8.1.4** Does not expect to receive radar traffic advisories on all traffic. Some aircraft may not appear on the radar display. Be aware that the controller may be occupied with high priority duties and unable to issue traffic information for a variety of reasons.

**42.8.1.5** Advises controller if service is not desired.

## **42.8.2 Controller**

**42.8.2.1** Issues radar traffic to the maximum extent consistent with higher priority duties except in Class A airspace.

**42.8.2.2** Provides vectors to assist aircraft to avoid observed traffic when requested by the pilot.

**42.8.2.3** Issues traffic information to aircraft in Class D airspace for sequencing purposes.

**42.8.2.4** Controllers are required to issue traffic advisories to each aircraft operating on intersecting or nonintersecting converging runways where projected flight paths will cross.

## **42.9 Safety Alert**

### **42.9.1 Pilot**

**42.9.1.1** Initiates appropriate action if a safety alert is received from ATC.

**42.9.1.2** Be aware that this service is not always available and that many factors affect the ability of the controller to be aware of a situation in which unsafe proximity to terrain, obstructions, or another aircraft may be developing.

### **42.9.2 Controller**

**42.9.2.1** Issues a safety alert if aware an aircraft under their control is at an altitude which, in the controller's judgment, places the aircraft in unsafe proximity to terrain, obstructions, or another aircraft. Types of safety alerts are:

a) **Terrain/Obstruction Alerts.** Immediately issued to an aircraft under their control if aware the aircraft is at an altitude believed to place the aircraft in unsafe proximity to terrain/obstruction.

b) **Aircraft Conflict Alerts.** Immediately issued to an aircraft under their control if aware of an aircraft not under their control at an altitude believed to place the aircraft in unsafe proximity to each other. With the alert, they offer the pilot an alternative if feasible.

**42.9.2.2** Discontinues further alerts if informed by the pilot action is being taken to correct the situation or that the other aircraft is in sight.

## **42.10 See and Avoid**

### **42.10.1 Pilot**

**42.10.1.1** When meteorological conditions permit, regardless of type of flight plan or whether or not under control of a radar facility, the pilot is responsible to see and avoid other traffic, terrain, or obstacles.

### **42.10.2 Controller**

**42.10.2.1** Provides radar traffic information to radar identified aircraft operating outside positive control airspace on a workload permitting basis.

**42.10.2.2** Issues a safety advisory to an aircraft under their control if aware the aircraft is at an altitude believed to place the aircraft in unsafe proximity to terrain, obstructions or other aircraft.



## **42.11 Visual Approach**

### **42.11.1 Pilot**

**42.11.1.1** If a visual approach is not desired, advises ATC.

**42.11.1.2** Complies with controller's instructions for vectors toward the airport of intended landing or to a visual position behind a preceding aircraft.

**42.11.1.3** The pilot must, at all times, have either the airport or the preceding aircraft in sight. After being cleared for a visual approach, proceed to the airport in a normal manner or follow the preceding aircraft. Remain clear of clouds while conducting a visual approach.

**42.11.1.4** If the pilot accepts a visual approach clearance to visually follow a preceding aircraft, you are required to establish a safe landing interval behind the aircraft you were instructed to follow. You are responsible for wake turbulence separation.

**42.11.1.5** Advise ATC immediately if the pilot is unable to continue following the preceding aircraft, cannot remain clear of clouds, needs to climb, or loses sight of the airport.

**42.11.1.6** In the event of a go-around, the pilot is responsible to maintain terrain and obstruction avoidance until reaching an ATC assigned altitude if issued.

**42.11.1.7** Be aware that radar service is automatically terminated, without being advised by ATC, when the pilot is instructed to change to advisory frequency.

**42.11.1.8** Be aware that there may be other traffic in the traffic pattern and the landing sequence may differ from the traffic sequence assigned by the approach control or ARTCC.

### **42.11.2 Controller**

**42.11.2.1** Does not clear an aircraft for a visual approach unless reported weather at the airport is ceiling at or above 1,000 feet and visibility is 3 miles or greater. When weather is not available for the destination airport, informs the pilot and does not initiate a visual approach to that airport unless there is reasonable assurance that descent and flight to the airport can be made visually.

**42.11.2.2** Issues visual approach clearance when the pilot reports sighting either the airport or a preceding aircraft which is to be followed.

**42.11.2.3** Provides separation except when visual separation is being applied by the pilot.

**42.11.2.4** Continues flight following and traffic information until the aircraft has landed or has been instructed to change to advisory frequency.

**42.11.2.5** For all aircraft, inform the pilot when the preceding aircraft is a heavy. Inform the pilot of a small aircraft when the preceding aircraft is a B757. Visual separation is prohibited behind super aircraft.

**42.11.2.6** When weather is available for the destination airport, does not initiate a vector for a visual approach unless the reported ceiling at the airport is 500 feet or more above the MVA and visibility is 3 miles or more. If vectoring weather minima are not available but weather at the airport is ceiling at or above 1,000 feet and visibility of 3 miles or greater, visual approaches may still be conducted.

**42.11.2.7** Informs the pilot conducting the visual approach of the aircraft class when pertinent traffic is known to be a heavy aircraft.

## **42.12 Visual Separation**

### **42.12.1 Pilot**

**42.12.1.1** Acceptance of instructions to follow another aircraft or to provide visual separation from it is an acknowledgment that the pilot will maneuver the aircraft as necessary to avoid the other aircraft or to maintain in-trail separation. Pilots are responsible to maintain visual separation until flight paths (altitudes and/or courses) diverge.

**42.12.1.2** If instructed by ATC to follow another aircraft or to provide visual separation from it, promptly notify the controller if you lose sight of that aircraft, are unable to maintain continued visual contact with it, or cannot accept the responsibility for your own separation for any reason.

**42.12.1.3** The pilot also accepts responsibility for wake turbulence separation under these conditions.

**42.12.2 Controller Applies Visual Separation Only:**

**42.12.2.1** Within the terminal area when a controller has both aircraft in sight or by instructing a pilot who sees the other aircraft to maintain visual separation from it.

**42.12.2.2** Pilots are responsible to maintain visual separation until flight paths (altitudes and/or courses) diverge.

**42.12.2.3** Within en route airspace when aircraft are on opposite courses and one pilot reports having seen the other aircraft and that the aircraft have passed each other.

**42.13 VFR-on-top**

**42.13.1 Pilot**

**42.13.1.1** This clearance must be requested by the pilot on an IFR flight plan, and if approved, allows the pilot the choice to select (subject to any ATC restrictions) an altitude or flight level in lieu of an assigned altitude.

**NOTE-**

**1.** *VFR-on-top is not permitted in certain airspace areas, such as Class A airspace, certain restricted areas, etc. Consequently, IFR flights operating VFR-on-top will avoid such airspace.*

**2.** *See paragraph 32. of this section, IFR Separation Standards; GEN 3.3, Paragraph 6, Position Reporting; and GEN 3.3, Paragraph 7, Additional Reports.*

**42.13.1.2** By requesting a VFR-on-top clearance, the pilot assumes the sole responsibility to be vigilant so as to see and avoid other aircraft and to:

- a) Fly at the appropriate VFR altitude as prescribed in 14 CFR Section 91.159.
- b) Comply with the VFR visibility and distance from clouds criteria in 14 CFR Section 91.155 (Basic VFR Weather Minimums).
- c) Comply with instrument flight rules that are applicable to this flight; i.e., minimum IFR altitudes, position reporting, radio communications, course to be flown, adherence to ATC clearance, etc.
- d) Advise ATC prior to any altitude change to ensure the exchange of accurate traffic information.

**42.13.2 Controller**

**42.13.2.1** May clear an aircraft to maintain VFR-on-top if the pilot of an aircraft on an IFR flight plan requests the clearance.

**42.13.2.2** Informs the pilot of an aircraft cleared to climb to VFR-on-top the reported height of the tops or that no top report is available; issues an alternate clearance if necessary; and once the aircraft reports reaching VFR-on-top, reclears the aircraft to maintain VFR-on-top.

**42.13.2.3** Before issuing clearance, ascertains that the aircraft is not in or will not enter Class A airspace.

**42.14 Instrument Departures**

**42.14.1 Pilot**

**42.14.1.1** Prior to departure, considers the type of terrain and other obstructions on or in the vicinity of the departure airport.

**42.14.1.2** Determines if obstruction avoidance can be maintained visually or that the departure procedure should be followed.

**42.14.1.3** Determines whether an obstacle departure procedure (ODP) and/or DP is available for obstruction avoidance. One option may be a Visual Climb Over Airport (VCOA). Pilots must advise ATC as early as possible of the intent to fly the VCOA prior to departure.

**42.14.1.4** At airports where instrument approach procedures have not been published, hence no published departure procedure, determines what action will be necessary and takes such action that will assure a safe departure.

#### **42.14.2 Controller**

**42.14.2.1** At locations with airport traffic control service, when necessary, specifies direction of takeoff, turn, or initial heading to be flown after takeoff, consistent with published departure procedures (DP) or diverse vector areas (DVA), where applicable.

**42.14.2.2** At locations without airport traffic control service but within Class E surface area, when necessary to specify direction of takeoff/turn or initial heading to be flown, obtains pilot's concurrence that the procedure will allow him/her to comply with local traffic patterns, terrain, and obstruction avoidance.

**42.14.2.3** When the initial heading will take the aircraft off an assigned procedure (for example, an RNAV SID with a published lateral path to a waypoint and crossing restrictions from the departure end of runway), the controller will assign an altitude to maintain with the initial heading.

**42.14.2.4** Includes established departure procedures as part of the air traffic control clearance when pilot compliance is necessary to ensure separation.

**42.14.2.5** At locations with both SIDs and DVAs, ATC will provide an amended departure clearance to cancel a previously assigned SID and subsequently utilize a DVA or vice versa. The amended clearance will be provided to the pilot in a timely manner so that the pilot may confirm adequate climb performance exists to determine if the amended clearance is acceptable, and brief the changes in advance of entering the runway.

**42.14.2.6** At locations with a DVA, ATC is not permitted to utilize a SID and DVA concurrently.

#### **42.15 Minimum Fuel Advisory**

##### **42.15.1 Pilot**

**42.15.1.1** Advises ATC of your "minimum fuel" status when your fuel supply has reached a state where, upon reaching destination, you cannot accept any undue delay.

**42.15.1.2** Be aware that this is not an emergency situation but merely an advisory that indicates an emergency situation is possible should any undue delay occur.

**42.15.1.3** On initial contact the term "minimum fuel" should be used after stating call sign.

##### **EXAMPLE–**

*Salt Lake Approach, United 621, "minimum fuel."*

**42.15.1.4** Be aware a minimum fuel advisory does not imply a need for traffic priority.

**42.15.1.5** If the remaining usable fuel supply suggests the need for traffic priority to ensure a safe landing, you should declare an emergency due to low fuel, and report the fuel remaining in minutes.

##### **42.15.2 Controller**

**42.15.2.1** When an aircraft declares a state of "minimum fuel," relay this information to the facility to whom control jurisdiction is transferred.

**42.15.2.2** Be alert for any occurrence which might delay the aircraft.

#### **43. Traffic Alert and Collision Avoidance System (TCAS I & II)**

**43.1 TCAS I** provides proximity warning only, to assist the pilot in the visual acquisition of intruder aircraft. No recommended avoidance maneuvers are provided nor authorized as a direct result of a TCAS I warning. It is intended for use by smaller commuter aircraft holding 10 to 30 passenger seats, and general aviation aircraft.

**43.2 TCAS II** provides traffic advisories (TA) and resolution advisories (RA). Resolution advisories provide recommended maneuvers in a vertical direction (climb or descend only) to avoid conflicting traffic. Transport category aircraft, and larger commuter and business aircraft holding 31 passenger seats or more, are required to be TCAS II equipped.

**43.2.1** When a TA occurs, attempt to establish visual contact with the traffic but do not deviate from an assigned clearance based only on TA information.

**43.2.2** When an RA occurs, pilots should respond immediately to the RA displays and maneuver as indicated unless doing so would jeopardize the safe operation of the flight, or the flight crew can ensure separation with the help of definitive visual acquisition of the aircraft causing the RA.

**43.2.3** Each pilot who deviates from an ATC clearance in response to an RA must notify ATC of that deviation as soon as practicable, and notify ATC when clear of conflict and returning to their previously assigned clearance.

**43.3** Deviations from rules, policies, or clearances should be kept to the minimum necessary to satisfy an RA. Most RA maneuvering requires minimum excursion from assigned altitude.

**43.4** The serving IFR air traffic facility is not responsible to provide approved standard IFR separation to an IFR aircraft, from other aircraft, terrain, or obstructions after an RA maneuver until one of the following conditions exists:

**43.4.1** The aircraft has returned to its assigned altitude and course.

**43.4.2** Alternate ATC instructions have been issued.

**43.4.3** A crew member informs ATC that the TCAS maneuver has been completed.

**NOTE–**

*TCAS does not alter or diminish the pilot's basic authority and responsibility to ensure safe flight. Since TCAS does not respond to aircraft which are not transponder equipped or aircraft with a transponder failure, TCAS alone does not ensure safe separation in every case. At this time, no air traffic service nor handling is predicated on the availability of TCAS equipment in the aircraft.*

## **44. Traffic Information Service (TIS)**

### **44.1 Introduction**

The Traffic Information Service (TIS) provides information to the cockpit via data link, that is similar to VFR radar traffic advisories normally received over voice radio. Among the first FAA–provided data services, TIS is intended to improve the safety and efficiency of “see and avoid” flight through an automatic display that informs the pilot of nearby traffic and potential conflict situations. This traffic display is intended to assist the pilot in visual acquisition of these aircraft. TIS employs an enhanced capability of the terminal Mode S radar system, which contains the surveillance data, as well as the data link required to “uplink” this information to suitably–equipped aircraft (known as a TIS “client”). TIS provides estimated position, altitude, altitude trend, and ground track information for up to 8 intruder aircraft within 7 NM horizontally, +3,500 and –3,000 feet vertically of the client aircraft (see FIG ENR 1.1–32, TIS Proximity Coverage Volume). The range of a target reported at a distance greater than 7 NM only indicates that this target will be a threat within 34 seconds and does not display a precise distance. TIS will alert the pilot to aircraft (under surveillance of the Mode S radar) that are estimated to be within 34 seconds of potential collision, regardless of distance or altitude. TIS surveillance data is derived from the same radar used by ATC; this data is uplinked to the client aircraft on each radar scan (nominally every 5 seconds).

### **44.2 Requirements**

**44.2.1** In order to use TIS, the client and any intruder aircraft must be equipped with the appropriate cockpit equipment and fly within the radar coverage of a Mode S radar capable of providing TIS. Typically, this will be within 55 NM of the sites depicted in FIG ENR 1.1–33, Terminal Mode S Radar Sites. ATC communication is not a requirement to receive TIS, although it may be required by the particular airspace or flight operations in which TIS is being used.

FIG ENR 1.1-32  
TIS Proximity Coverage Volume

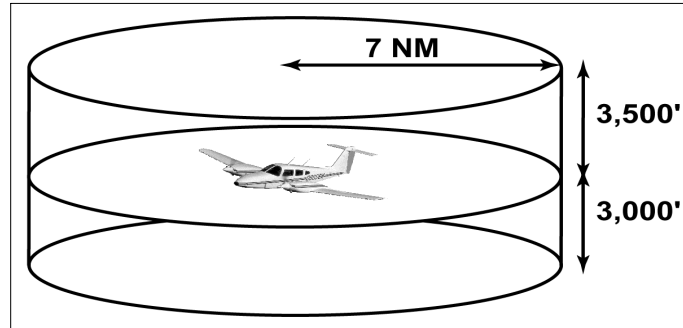


FIG ENR 1.1-33  
Terminal Mode S Radar Sites

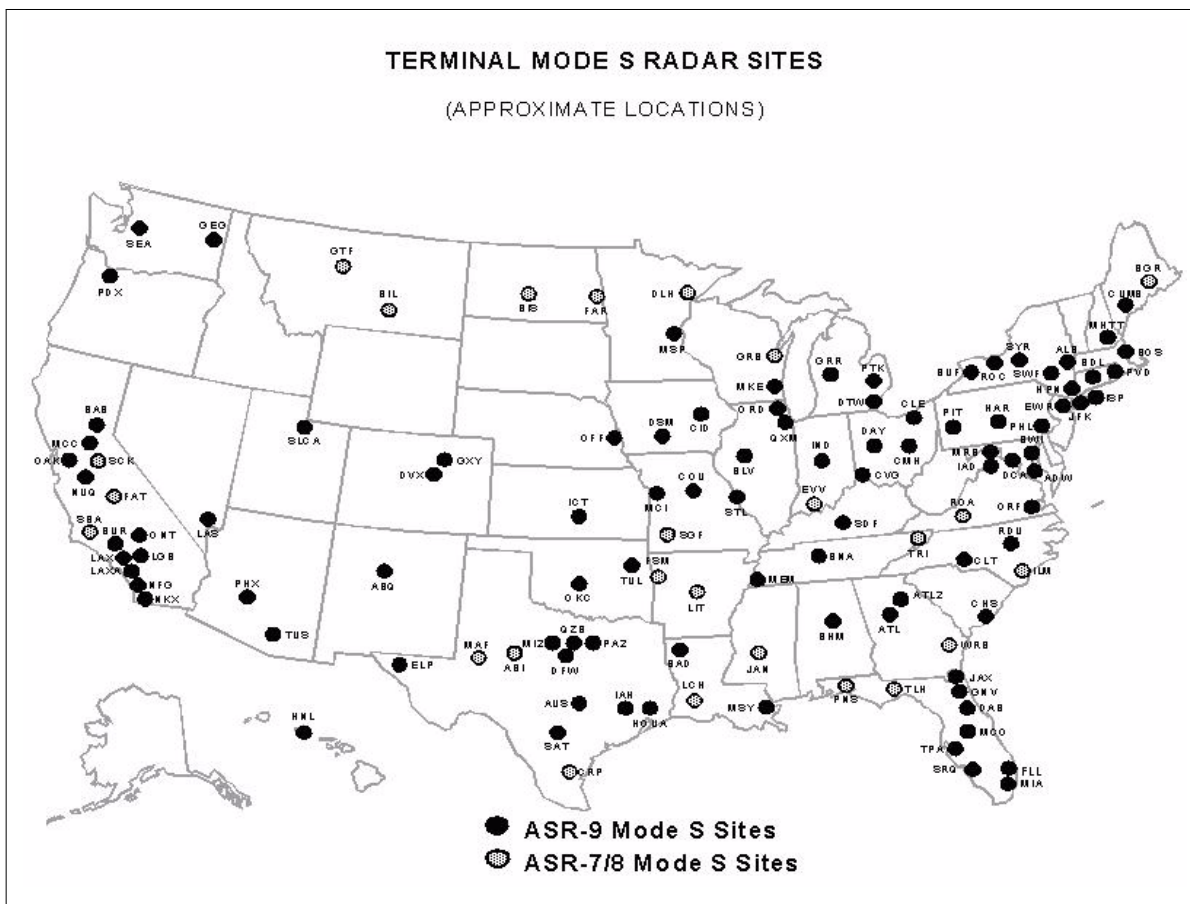
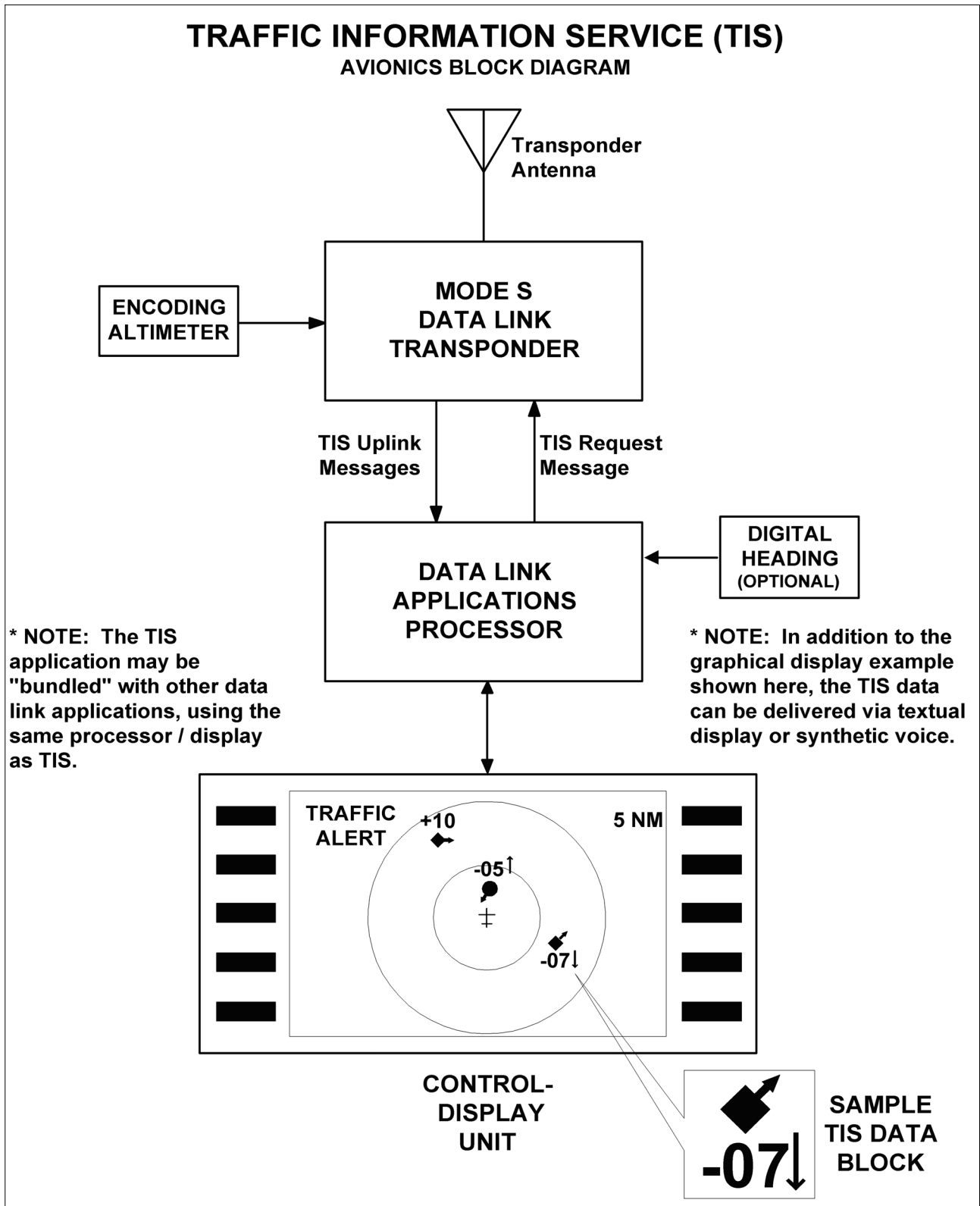


FIG ENR 1.1-34  
Traffic Information Service (TIS)  
Avionics Block Diagram



**44.2.2** The cockpit equipment functionality required by a TIS client aircraft to receive the service consists of the following (refer to FIG ENR 1.1–34):

**44.2.2.1** Mode S data link transponder with altitude encoder.

**44.2.2.2** Data link applications processor with TIS software installed.

**44.2.2.3** Control–display unit.

**44.2.2.4** Optional equipment includes a digital heading source to correct display errors caused by “crab angle” and turning maneuvers.

**NOTE–**

*Some of the above functions will likely be combined into single pieces of avionics, such as subparagraphs 44.2.2.1 and 44.2.2.2.*

**44.2.3** To be visible to the TIS client, the intruder aircraft must, at a minimum, have an operating transponder (Mode A, C or S). All altitude information provided by TIS from intruder aircraft is derived from Mode C reports, if appropriately equipped.

**44.2.4** TIS will initially be provided by the terminal Mode S systems that are paired with ASR–9 digital primary radars. These systems are in locations with the greatest traffic densities, thus will provide the greatest initial benefit. The remaining terminal Mode S sensors, which are paired with ASR–7 or ASR–8 analog primary radars, will provide TIS pending modification or relocation of these sites. See FIG ENR 1.1–33, Terminal Mode S Radar Sites, for site locations. There is no mechanism in place, such as NOTAMs, to provide status update on individual radar sites since TIS is a nonessential, supplemental information service.

The FAA also operates en route Mode S radars (not illustrated) that rotate once every 12 seconds. These sites will require additional development of TIS before any possible implementation. There are no plans to implement TIS in the en route Mode S radars at the present time.

### **44.3 Capabilities**

**44.3.1** TIS provides ground–based surveillance information over the Mode S data link to properly equipped client aircraft to aid in visual acquisition of proximate air traffic. The actual avionics capability of each installation will vary and the supplemental handbook material must be consulted prior to using TIS. A maximum of eight (8) intruder aircraft may be displayed; if more than eight aircraft match intruder parameters, the eight “most significant” intruders are uplinked. These “most significant” intruders are usually the ones in closest proximity and/or the greatest threat to the TIS client.

**44.3.2** TIS, through the Mode S ground sensor, provides the following data on each intruder aircraft:

**44.3.2.1** Relative bearing information in 6–degree increments.

**44.3.2.2** Relative range information in 1/8 NM to 1 NM increments (depending on range).

**44.3.2.3** Relative altitude in 100–foot increments (within 1,000 feet) or 500–foot increments (from 1,000–3,500 feet) if the intruder aircraft has operating altitude reporting capability.

**44.3.2.4** Estimated intruder ground track in 45–degree increments.

**44.3.2.5** Altitude trend data (level within 500 fpm or climbing/descending >500 fpm) if the intruder aircraft has operating altitude reporting capability.

**44.3.2.6** Intruder priority as either a “traffic advisory” or “proximate” intruder.

**44.3.3** When flying from surveillance coverage of one Mode S sensor to another, the transfer of TIS is an automatic function of the avionics system and requires no action from the pilot.

**44.3.4** There are a variety of status messages that are provided by either the airborne system or ground equipment to alert the pilot of high priority intruders and data link system status. These messages include the following:

**44.3.4.1 Alert.** Identifies a potential collision hazard within 34 seconds. This alert may be visual and/or audible, such as a flashing display symbol or a headset tone. A target is a threat if the time to the closest approach

in vertical and horizontal coordinates is less than 30 seconds and the closest approach is expected to be within 500 feet vertically and 0.5 nautical miles laterally.

**44.3.4.2 TIS Traffic.** TIS traffic data is displayed.

**44.3.4.3 Coasting.** The TIS display is more than 6 seconds old. This indicates a missing uplink from the ground system. When the TIS display information is more than 12 seconds old, the “No Traffic” status will be indicated.

**44.3.4.4 No Traffic.** No intruders meet proximate or alert criteria. This condition may exist when the TIS system is fully functional or may indicate “coasting” between 12 and 59 seconds old (see paragraph 44.3.4.3 above).

**44.3.4.5 TIS Unavailable.** The pilot has requested TIS, but no ground system is available. This condition will also be displayed when TIS uplinks are missing for 60 seconds or more.

**44.3.4.6 TIS Disabled.** The pilot has not requested TIS or has disconnected from TIS.

**44.3.4.7 Good-bye.** The client aircraft has flown outside of TIS coverage.

**NOTE–**

*Depending on the avionics manufacturer implementation, it is possible that some of these messages will not be directly available to the pilot.*

**44.3.5** Depending on avionics system design, TIS may be presented to the pilot in a variety of different displays, including text and/or graphics. Voice annunciation may also be used, either alone or in combination with a visual display. FIG ENR 1.1–34, Traffic Information Service (TIS), Avionics Block Diagram, shows an example of a TIS display using symbology similar to the Traffic Alert and Collision Avoidance System (TCAS) installed on most passenger air carrier/commuter aircraft in the U.S. The small symbol in the center represents the client aircraft and the display is oriented “track up,” with the 12 o’clock position at the top. The range rings indicate 2 and 5 NM. Each intruder is depicted by a symbol positioned at the approximate relative bearing and range from the client aircraft. The circular symbol near the center indicates an “alert” intruder and the diamond symbols indicate “proximate” intruders.

**44.3.6** The inset in the lower right corner of FIG ENR 1.1–34, Traffic Information Service (TIS), Avionics Block Diagram, shows a possible TIS data block display. The following information is contained in this data block:

**44.3.6.1** The intruder, located approximately four o’clock, three miles, is a “proximate” aircraft and currently not a collision threat to the client aircraft. This is indicated by the diamond symbol used in this example.

**44.3.6.2** The intruder ground track diverges to the right of the client aircraft, indicated by the small arrow.

**44.3.6.3** The intruder altitude is 700 feet less than or below the client aircraft, indicated by the “–07” located under the symbol.

**44.3.6.4** The intruder is descending >500 fpm, indicated by the downward arrow next to the “–07” relative altitude information. The absence of this arrow when an altitude tag is present indicates level flight or a climb/descent rate less than 500 fpm.

**NOTE–**

*If the intruder did not have an operating altitude encoder (Mode C), the altitude and altitude trend “tags” would have been omitted.*

**44.4 Limitations**

**44.4.1** TIS is NOT intended to be used as a collision avoidance system and does not relieve the pilot’s responsibility to “see and avoid” other aircraft (see Paragraph 42.10, See and Avoid). TIS must not be used for avoidance maneuvers during IMC or other times when there is no visual contact with the intruder aircraft. TIS provides proximity warning only, to assist the pilot in the visual acquisition of intruder aircraft. It is intended for use by aircraft in which TCAS is not required. Avoidance maneuvers are neither provided nor authorized, as a direct result of a TIS intruder display or TIS alert.



**44.4.2** TIS does not alter or diminish the pilot’s basic authority and responsibility to ensure safe flight. Since TIS does not respond to aircraft which are not transponder equipped, aircraft with a transponder failure, or aircraft out of radar coverage, TIS alone does not ensure safe separation in every case.

**44.4.3** At this time, no air traffic service nor handling is predicated on the availability of TIS equipment in the aircraft.

**44.4.4** While TIS is a useful aid to visual traffic avoidance, it has some system limitations that must be fully understood to ensure proper use. Many of these limitations are inherent in secondary radar surveillance. In other words, the information provided by TIS will be no better than that provided to ATC. Other limitations and anomalies are associated with the TIS predictive algorithm.

**44.4.4.1 Intruder Display Limitations.** TIS will only display aircraft with operating transponders installed. TIS relies on surveillance of the Mode S radar, which is a “secondary surveillance” radar similar to the ATCRBS described in paragraph 37.2, Air Traffic Control Radar Beacon System (ATCRBS).

**44.4.4.2 TIS Client Altitude Reporting Requirement.** Altitude reporting is required by the TIS client aircraft in order to receive TIS. If the altitude encoder is inoperative or disabled, TIS will be unavailable, as TIS requests will not be honored by the ground system. As such, TIS requires altitude reporting to determine the Proximity Coverage Volume as indicated in FIG ENR 1.1–32. TIS users must be alert to altitude encoder malfunctions, as TIS has no mechanism to determine if client altitude reporting is correct. A failure of this nature will cause erroneous and possibly unpredictable TIS operation. If this malfunction is suspected, confirmation of altitude reporting with ATC is suggested.

**44.4.4.3 Intruder Altitude Reporting.** Intruders without altitude reporting capability will be displayed without the accompanying altitude tag. Additionally, nonaltitude reporting intruders are assumed to be at the same altitude as the TIS client for alert computations. This helps to ensure that the pilot will be alerted to all traffic under radar coverage, but the actual altitude difference may be substantial. Therefore, visual acquisition may be difficult in this instance.

**44.4.4.4 Coverage Limitations.** Since TIS is provided by ground–based, secondary surveillance radar, it is subject to all limitations of that radar. If an aircraft is not detected by the radar, it cannot be displayed on TIS. Examples of these limitations are as follows:

a) TIS will typically be provided within 55 NM of the radars depicted in FIG ENR 1.1–33, Terminal Mode S Radar Sites. This maximum range can vary by radar site and is always subject to “line of sight” limitations; the radar and data link signals will be blocked by obstructions, terrain, and curvature of the earth.

b) TIS will be unavailable at low altitudes in many areas of the country, particularly in mountainous regions. Also, when flying near the “floor” of radar coverage in a particular area, intruders below the client aircraft may not be detected by TIS.

c) TIS will be temporarily disrupted when flying directly over the radar site providing coverage if no adjacent site assumes the service. A ground–based radar, similar to a VOR or NDB, has a zenith cone, sometimes referred to as the cone of confusion or cone of silence. This is the area of ambiguity directly above the station where bearing information is unreliable. The zenith cone setting for TIS is 34 degrees: any aircraft above that angle with respect to the radar horizon will lose TIS coverage from that radar until it is below this 34 degree angle. The aircraft may not actually lose service in areas of multiple radar coverage since an adjacent radar will provide TIS. If no other TIS–capable radar is available, the “Good–bye” message will be received and TIS terminated until coverage is resumed.

**44.4.4.5 Intermittent Operations.** TIS operation may be intermittent during turns or other maneuvering, particularly if the transponder system does not include antenna diversity (antenna mounted on the top and bottom of the aircraft). As in subparagraph 44.4.4.4 above, TIS is dependent on two–way, “line of sight” communications between the aircraft and the Mode S radar. Whenever the structure of the client aircraft comes between the transponder antenna (usually located on the underside of the aircraft) and the ground–based radar antenna, the signal may be temporarily interrupted.

**44.4.4.6 TIS Predictive Algorithm.** TIS information is collected one radar scan prior to the scan during which the uplink occurs. Therefore, the surveillance information is approximately 5 seconds old. In order to present the intruders in a “real time” position, TIS uses a “predictive algorithm” in its tracking software. This algorithm uses track history data to extrapolate intruders to their expected positions consistent with the time of display in the cockpit. Occasionally, aircraft maneuvering will cause this algorithm to induce errors in the TIS display. These errors primarily affect relative bearing information; intruder distance and altitude will remain relatively accurate and may be used to assist in “see and avoid.” Some of the more common examples of these errors are as follows:

a) When client or intruder aircraft maneuver excessively or abruptly, the tracking algorithm will report incorrect horizontal position until the maneuvering aircraft stabilizes.

b) When a rapidly closing intruder is on a course that crosses the client at a shallow angle (either overtaking or head on) and either aircraft abruptly changes course within ¼ NM, TIS will display the intruder on the opposite side of the client than it actually is.

These are relatively rare occurrences and will be corrected in a few radar scans once the course has stabilized.

**44.4.4.7 Heading/Course Reference.** Not all TIS aircraft installations will have onboard heading reference information. In these installations, aircraft course reference to the TIS display is provided by the Mode S radar. The radar only determines ground track information and has no indication of the client aircraft heading. In these installations, all intruder bearing information is referenced to ground track and does not account for wind correction. Additionally, since ground-based radar will require several scans to determine aircraft course following a course change, a lag in TIS display orientation (intruder aircraft bearing) will occur. As in subparagraph 44.4.4.6 above, intruder distance and altitude are still usable.

**44.4.4.8 Closely-Spaced Intruder Errors.** When operating more than 30 NM from the Mode S sensor, TIS forces any intruder within 3/8 NM of the TIS client to appear at the same horizontal position as the client aircraft. Without this feature, TIS could display intruders in a manner confusing to the pilot in critical situations (for example, a closely-spaced intruder that is actually to the right of the client may appear on the TIS display to the left). At longer distances from the radar, TIS cannot accurately determine relative bearing/distance information on intruder aircraft that are in close proximity to the client.

Because TIS uses a ground-based, rotating radar for surveillance information, the accuracy of TIS data is dependent on the distance from the sensor (radar) providing the service. This is much the same phenomenon as experienced with ground-based navigational aids, such as a VOR. As distance from the radar increases, the accuracy of surveillance decreases. Since TIS does not inform the pilot of distance from the Mode S radar, the pilot must assume that any intruder appearing at the same position as the client aircraft may actually be up to 3/8 NM away in any direction. Consistent with the operation of TIS, an alert on the display (regardless of distance from the radar) should stimulate an outside visual scan, intruder acquisition, and traffic avoidance based on outside reference.

## 44.5 Reports of TIS Malfunctions

**44.5.1** Users of TIS can render valuable assistance in the early correction of malfunctions by reporting their observations of undesirable performance. Reporters should identify the time of observation, location, type and identity of aircraft, and describe the condition observed; the type of transponder processor, and software in use can also be useful information. Since TIS performance is monitored by maintenance personnel rather than ATC, it is suggested that malfunctions be reported by radio or telephone to the nearest Flight Service Station (FSS) facility.

### NOTE–

*TIS operates at only those terminal Mode S radar sites depicted in FIG ENR 1.1–33. Though similar in some ways, TIS is not related to TIS–B (Traffic Information Service–Broadcast).*

## 45. Automatic Dependent Surveillance–Broadcast (ADS–B) Services

### 45.1 Introduction

**45.1.1** Automatic Dependent Surveillance–Broadcast (ADS–B) is a surveillance technology deployed throughout the NAS (see FIG ENR 1.1–35). The ADS–B system is composed of aircraft avionics and a ground infrastructure. Onboard avionics determine the position of the aircraft by using the GNSS and transmit its position along with additional information about the aircraft to ground stations for use by ATC and other ADS–B services. This information is transmitted at a rate of approximately once per second. (See FIG ENR 1.1–36 and FIG ENR 1.1–37.)

**45.1.2** In the United States, ADS–B equipped aircraft exchange information on one of two frequencies: 978 or 1090 MHz. The 1090 MHz frequency is also associated with Mode A, C, and S transponder operations. 1090 MHz transponders with integrated ADS–B functionality extend the transponder message sets with additional ADS–B information. This additional information is known as an “extended squitter” message and is referred to as 1090ES. ADS–B equipment operating on 978 MHz is known as the Universal Access Transceiver (UAT).

**45.1.3** ADS–B avionics can have the ability to both transmit and receive information. The transmission of ADS–B information from an aircraft is known as ADS–B Out. The receipt of ADS–B information by an aircraft is known as ADS–B In. All aircraft operating within the airspace defined in 14 CFR § 91.225 are required to transmit the information defined in § 91.227 using ADS–B Out avionics.

**45.1.4** In general, operators flying at 18,000 feet and above (Class A airspace) are required to have 1090ES equipment. Those that do not fly above 18,000 may use either UAT or 1090ES equipment. (Refer to 14 CFR §§ 91.225 and 91.227.) While the regulations do not require it, operators equipped with ADS–B In will realize additional benefits from ADS–B broadcast services: Traffic Information Service – Broadcast (TIS–B) (paragraph 46.) and Flight Information Service – Broadcast (FIS–B) (paragraph 47.).

**FIG ENR 1.1–35**  
**ADS–B, TIS–B, and FIS–B:**  
**Broadcast Services Architecture**

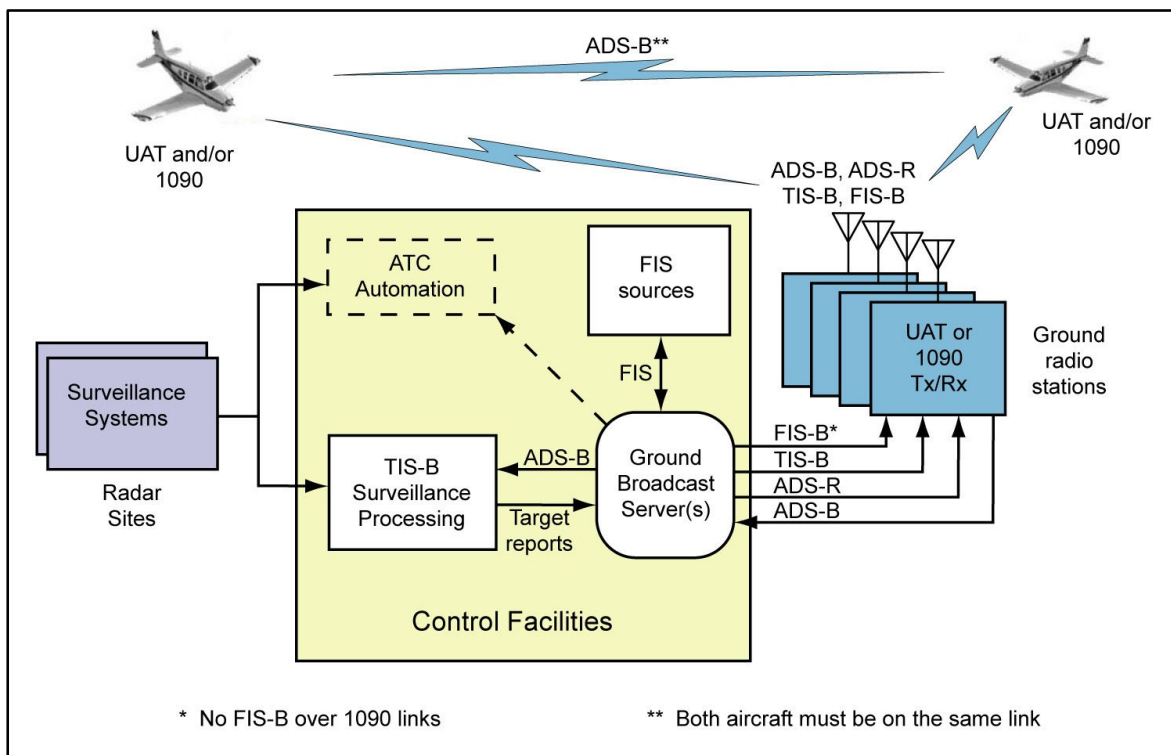


FIG ENR 1.1-36  
En Route – ADS-B/ADS-R/TIS-B/FIS-B Service Ceilings/Floors

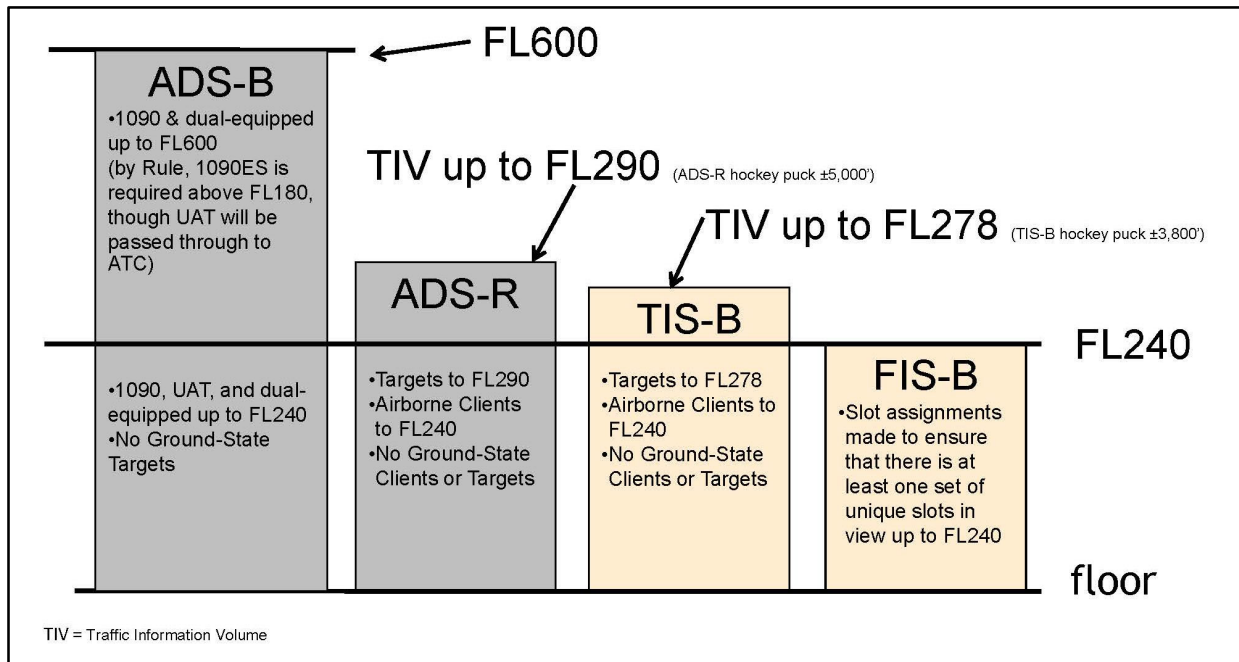
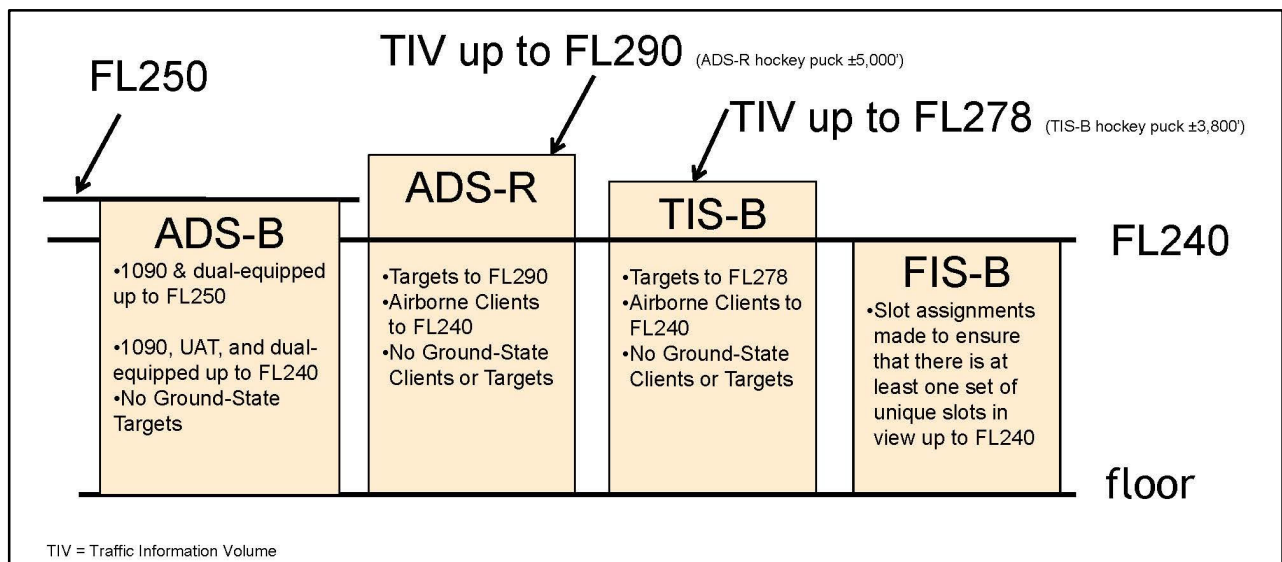


FIG ENR 1.1-37  
Terminal – ADS-B/ADS-R/TIS-B/FIS-B Service Ceilings/Floors



## 45.2 ADS-B Certification and Performance Requirements

ADS-B equipment may be certified as a surveillance source for air traffic separation services using ADS-B Out. ADS-B equipment may also be certified for use with ADS-B In advisory services that enable appropriately equipped aircraft to display traffic and flight information. Refer to the aircraft's flight manual supplement or Pilot Operating Handbook for the capabilities of a specific aircraft installation.

## 45.3 ADS-B Capabilities and Procedures

**45.3.1** ADS-B enables improved surveillance services, both air-to-air and air-to-ground, especially in areas where radar is ineffective due to terrain or where it is impractical or cost prohibitive. Initial NAS applications

of air-to-air ADS-B are for “advisory” use only, enhancing a pilot’s visual acquisition of other nearby equipped aircraft either when airborne or on the airport surface. Additionally, ADS-B will enable ATC and fleet operators to monitor aircraft throughout the available ground station coverage area.

**45.3.2** One of the data elements transmitted by ADS-B is the aircraft’s Flight Identification (FLT ID). The FLT ID is comprised of a maximum of seven alphanumeric characters and must correspond to the aircraft identification filed in the flight plan. For airline and commuter aircraft, the FLT ID is usually the company name and flight number (for example, AAL3432), and is typically entered into the avionics by the flight crew during preflight. For general aviation (GA), if aircraft avionics allow dynamic modification of the FLT ID, the pilot can enter it prior to flight. However, some ADS-B avionics require the FLT ID to be set to the aircraft registration number (for example, N1234Q) by the installer and cannot be changed by the pilot from the cockpit. In both cases, the FLT ID must correspond to the aircraft identification filed in its flight plan.

ATC automation systems use the transmitted ADS-B FLT ID to uniquely identify each aircraft within a given airspace, and to correlate it to its filed flight plan for the purpose of providing surveillance and separation services. If the FLT ID and the filed aircraft identification are not identical, a Call Sign Mis-Match (CSMM) is generated and ATC automation systems may not associate the aircraft with its filed flight plan. In this case, air traffic services may be delayed or unavailable until the CSMM is corrected. Consequently, it is imperative that flight crews and GA pilots ensure the FLT ID entry correctly matches the aircraft identification filed in their flight plan.

**45.3.3** Each ADS-B aircraft is assigned a unique ICAO address (also known as a 24-bit address) that is broadcast by the ADS-B transmitter. This ICAO address is programmed at installation. Should multiple aircraft broadcast the same ICAO address while transiting the same ADS-B Only Service Volume, the ADS-B network may be unable to track the targets correctly. If radar reinforcement is available, tracking will continue. If radar is unavailable, the controller may lose target tracking entirely on one or both targets. Consequently, it is imperative that the ICAO address entry is correct.

**45.3.4** Aircraft that are equipped with ADS-B avionics on the UAT datalink have a feature that allows them to broadcast an anonymous 24-bit ICAO address. In this mode, the UAT system creates a randomized address that does not match the actual ICAO address assigned to the aircraft. The UAT anonymous 24-bit address feature may only be used when the operator has not filed an IFR flight plan and is not requesting ATC services. In the anonymity mode, the aircraft’s beacon code must be set to 1200 and, depending on the manufacturer’s implementation, the aircraft FLT ID might not be transmitted. Pilots should be aware that while in UAT anonymity mode, they will not be eligible to receive ATC separation and flight following services, and may not benefit from enhanced ADS-B search and rescue capabilities.

**45.3.5** ADS-B systems integrated with the transponder will automatically set the applicable emergency status when 7500, 7600, or 7700 are entered into the transponder. ADS-B systems not integrated with the transponder, or systems with optional emergency codes, will require that the appropriate emergency code is entered through a pilot interface. ADS-B is intended for inflight and airport surface use. Unless otherwise directed by ATC, transponder/ADS-B systems should be turned “on” and remain “on” whenever operating in the air or on the airport surface movement area.

#### **45.4 ATC Surveillance Services using ADS-B – Procedures and Recommended Phraseology**

Radar procedures, with the exceptions found in this paragraph, are identical to those procedures prescribed for radar in the AIP.

##### **45.4.1 Preflight:**

If ATC services are anticipated when either a VFR or IFR flight plan is filed, the aircraft identification (as entered in the flight plan) must be entered as the FLT ID in the ADS-B avionics as described in paragraph 45.3.2.

##### **45.4.2 Inflight:**

When requesting surveillance services while airborne, pilots must disable the anonymous feature, if so equipped, prior to contacting ATC. Pilots must also ensure that their transmitted ADS-B FLT ID matches the aircraft identification as entered in their flight plan.

#### **45.4.3 Aircraft with an Inoperative/Malfunctioning ADS–B Transmitter:**

**45.4.3.1** ATC will inform the flight crew when the aircraft’s ADS–B transmitter appears to be inoperative or malfunctioning:

**PHRASEOLOGY–**

*YOUR ADS–B TRANSMITTER APPEARS TO BE INOPERATIVE/MALFUNCTIONING. STOP ADS–B TRANSMISSIONS.*

**45.4.3.2** ATC will inform the flight crew if it becomes necessary to turn off the aircraft’s ADS–B transmitter.

**PHRASEOLOGY–**

*STOP ADS–B TRANSMISSIONS.*

**45.4.3.3** Other malfunctions and considerations: Loss of automatic altitude reporting capabilities (encoder failure) will result in loss of ATC altitude advisory services.

#### **45.4.4 Procedures for Accommodation of Non–ADS–B Equipped Aircraft:**

**45.4.4.1** Pilots of aircraft not equipped with ADS–B may only operate outside airspace designated as ADS–B airspace in 14 CFR §91.225. Pilots of unequipped aircraft wishing to fly any portion of a flight in ADS–B airspace may seek a deviation from the regulation to conduct operations without the required equipment. Direction for obtaining this deviation are available in Advisory Circular 90–114.

**45.4.4.2** While air traffic controllers can identify which aircraft are ADS–B equipped and which are not, there is no indication if a non–equipped pilot has obtained a preflight authorization to enter ADS–B airspace. Situations may occur when the pilot of a non–equipped aircraft, without an authorization to operate in ADS–B airspace receives an ATC–initiated in–flight clearance to fly a heading, route, or altitude that would penetrate ADS–B airspace. Such clearances may be for traffic, weather, or simply to shorten the aircraft’s route of flight. When this occurs, the pilot should acknowledge and execute the clearance, but must advise the controller that they are not ADS–B equipped and have not received prior authorization to operate in ADS–B airspace. The controller, at their discretion, will either acknowledge and proceed with the new clearance, or modify the clearance to avoid ADS–B airspace. In either case, the FAA will normally not take enforcement action for non–equipped in these circumstances.

**NOTE–**

*Pilots operating without ADS–B equipment must not request route or altitude changes that will result in an incursion into ADS–B airspace except for safety of flight; for example, weather avoidance. Unequipped aircraft that have not received a pre–flight deviation authorization will only be considered in compliance with regulation if the amendment to flight is initiated by ATC.*

**EXAMPLE–**

**1. ATC:** “November Two Three Quebec, turn fifteen degrees left, proceed direct Bradford when able, rest of route unchanged.”

**Aircraft:** “November Two Three Quebec, turning fifteen degrees left, direct Bradford when able, rest of route unchanged. Be advised, we are negative ADS–B equipment and have not received authorization to operate in ADS–B airspace.”

**ATC:** “November Two Three Quebec, roger”

or

“November Two Three Quebec, roger, turn twenty degrees right, rejoin Victor Ten, rest of route unchanged.”

**2. ATC:** “November Four Alpha Tango, climb and maintain one zero thousand for traffic.”

**Aircraft:** “November Four Alpha Tango, leaving eight thousand for one zero thousand. Be advised, we are negative ADS–B equipment and have not received authorization to operate in ADS–B airspace.”

**ATC:** “November Four Alpha Tango, roger”

or

“November Four Alpha Tango, roger, cancel climb clearance, maintain eight thousand.”

**REFERENCE–**

*Federal Register Notice, Volume 84, Number 62, dated April 1, 2019*

### **45.5 ADS–B Limitations**

**45.5.1** The ADS–B cockpit display of traffic is NOT intended to be used as a collision avoidance system and does not relieve the pilot’s responsibility to “see and avoid” other aircraft. (See Paragraph 42.10, See and Avoid).

ADS-B provides proximity warning only to assist the pilot in the visual acquisition of other aircraft. ADS-B must not be used for avoidance maneuvers during IMC or other times when there is no visual contact with the intruder aircraft. No avoidance maneuvers are provided or authorized, as a direct result of an ADS-B display or an ADS-B alert.

**45.5.2** ADS-B does not alter or diminish the pilot's basic authority and responsibility to ensure safe flight. ADS-B only displays aircraft that are ADS-B equipped; therefore, aircraft that are not ADS-B equipped or aircraft that are experiencing an ADS-B failure will not be displayed. ADS-B alone does not ensure safe separation.

**45.5.3** Presently, no air traffic services or handling is predicated on the availability of an ADS-B cockpit display. A "traffic-in-sight" reply to ATC must be based on seeing an aircraft out-the-window, NOT on the cockpit display.

#### **45.6 Reports of ADS-B Malfunctions**

Users of ADS-B can provide valuable assistance in the correction of malfunctions by reporting instances of undesirable system performance. Since ADS-B performance is monitored by maintenance personnel rather than ATC, report malfunctions to the nearest Flight Service Station (FSS) facility by radio or telephone, or by sending an email to the ADS-B help desk at [adsb@faa.gov](mailto:adsb@faa.gov). Reports should include:

**45.6.1** Condition observed;

**45.6.2** Date and time of observation;

**45.6.3** Altitude and location of observation;

**45.6.4** Type and call sign of the aircraft; and

**45.6.5** Type and software version of avionics system.

### **46. Traffic Information Service-Broadcast (TIS-B)**

#### **46.1 Introduction**

TIS-B is the broadcast of ATC derived traffic information to ADS-B equipped (1090ES or UAT) aircraft from ground radio stations. The source of this traffic information is derived from ground-based air traffic surveillance sensors. TIS-B service will be available throughout the NAS where there are both adequate surveillance coverage from ground sensors and adequate broadcast coverage from ADS-B ground radio stations. The quality level of traffic information provided by TIS-B is dependent upon the number and type of ground sensors available as TIS-B sources and the timeliness of the reported data. (See FIG ENR 1.1-36 and FIG ENR 1.1-37.)

#### **46.2 TIS-B Requirements**

In order to receive TIS-B service, the following conditions must exist:

**46.2.1** Aircraft must be equipped with an ADS-B transmitter/receiver or transceiver, and a cockpit display of traffic information (CDTI).

**46.2.2** Aircraft must fly within the coverage volume of a compatible ground radio station that is configured for TIS-B uplinks. (Not all ground radio stations provide TIS-B due to a lack of radar coverage or because a radar feed is not available).

**46.2.3** Aircraft must be within the coverage of and detected by at least one ATC radar serving the ground radio station in use.

#### **46.3 TIS-B Capabilities**

**46.3.1** TIS-B is intended to provide ADS-B equipped aircraft with a more complete traffic picture in situations where not all nearby aircraft are equipped with ADS-B Out. This advisory-only application is intended to enhance a pilot's visual acquisition of other traffic.

**46.3.2** Only transponder–equipped targets (i.e., Mode A/C or Mode S transponders) are transmitted through the ATC ground system architecture. Current radar siting may result in limited radar surveillance coverage at lower altitudes near some airports, with subsequently limited TIS–B service volume coverage. If there is no radar coverage in a given area, then there will be no TIS–B coverage in that area.

#### **46.4 TIS–B Limitations**

**46.4.1** TIS–B is **NOT** intended to be used as a collision avoidance system and does not relieve the pilot’s responsibility to “see and avoid” other aircraft, in accordance with 14CFR §91.113b. TIS–B must not be used for avoidance maneuvers during times when there is no visual contact with the intruder aircraft. TIS–B is intended only to assist in the visual acquisition of other aircraft.

**NOTE–**

*No aircraft avoidance maneuvers are authorized as a direct result of a TIS–B target being displayed in the cockpit.*

**46.4.2** While TIS–B is a useful aid to visual traffic avoidance, its inherent system limitations must be understood to ensure proper use.

**46.4.2.1** A pilot may receive an intermittent TIS–B target of themselves, typically when maneuvering (e.g., climbing turns) due to the radar not tracking the aircraft as quickly as ADS–B.

**46.4.2.2** The ADS–B–to–radar association process within the ground system may at times have difficulty correlating an ADS–B report with corresponding radar returns from the same aircraft. When this happens the pilot may see duplicate traffic symbols (i.e., “TIS–B shadows”) on the cockpit display.

**46.4.2.3** Updates of TIS–B traffic reports will occur less often than ADS–B traffic updates. TIS–B position updates will occur approximately once every 3–13 seconds depending on the type of radar system in use within the coverage area. In comparison, the update rate for ADS–B is nominally once per second.

**46.4.2.4** The TIS–B system only uplinks data pertaining to transponder–equipped aircraft. Aircraft without a transponder will not be displayed as TIS–B traffic.

**46.4.2.5** There is no indication provided when any aircraft is operating inside or outside the TIS–B service volume, therefore it is difficult to know if one is receiving uplinked TIS–B traffic information.

**46.4.3** Pilots and operators are reminded that the airborne equipment that displays TIS–B targets is for pilot situational awareness only and is not approved as a collision avoidance tool. Unless there is an imminent emergency requiring immediate action, any deviation from an air traffic control clearance in response to perceived converging traffic appearing on a TIS–B display must be approved by the controlling ATC facility before commencing the maneuver, except as permitted under certain conditions in 14CFR §91.123. Uncoordinated deviations may place an aircraft in close proximity to other aircraft under ATC control not seen on the airborne equipment and may result in a pilot deviation or other incident.

#### **46.5 Reports of TIS–B Malfunctions**

Users of TIS–B can provide valuable assistance in the correction of malfunctions by reporting instances of undesirable system performance. Since TIS–B performance is monitored by maintenance personnel rather than ATC, report malfunctions to the nearest Flight Service Station (FSS) facility by radio or telephone, or by sending an email to the ADS–B help desk at [adsb@faa.gov](mailto:adsb@faa.gov). Reports should include:

**46.5.1** Condition observed;

**46.5.2** Date and time of observation;

**46.5.3** Altitude and location of observation;

**46.5.4** Type and call sign of the aircraft; and

**46.5.5** Type and software version of avionics system.

### **47. Flight Information Service– Broadcast (FIS–B)**

#### **47.1 Introduction.**



FIS–B is a ground broadcast service provided through the ADS–B Services network over the 978 MHz UAT data link. The FAA FIS–B system provides pilots and flight crews of properly equipped aircraft with a cockpit display of certain aviation weather and aeronautical information. FIS–B reception is line–of–sight within the service volume of the ground infrastructure. (See FIG ENR 1.1–36 and FIG ENR 1.1–37.)

#### **47.2 Weather Products Provided by FIS–B.**

FIS-B does not replace a preflight weather briefing from a source listed in GEN 3.5, paragraph 3.5, FAA Weather Services, or inflight updates from an FSS or ATC. FIS-B information may be used by the pilot for the safe conduct of flight and aircraft movement; however, the information should not be the only source of weather or aeronautical information. A pilot should be particularly alert and understand the limitations and quality assurance issues associated with individual products. This includes graphical representation of next generation weather radar (NEXRAD) imagery and Notices to Air Missions (NOTAM)/temporary flight restrictions (TFR).

#### **REFERENCE–**

AIP, ENR 3.5 Paragraph 7, *Flight Information Services (FIS)*.  
Advisory Circular AC 00–63, “Use of Cockpit Displays of Digital Weather and Aeronautical Information”

#### **47.3 Reports of FIS–B Malfunctions.**

Users of FIS–B can provide valuable assistance in the correction of malfunctions by reporting instances of undesirable system performance. Since FIS–B performance is monitored by maintenance personnel rather than ATC, report malfunctions to the nearest Flight Service Station (FSS) facility by radio or telephone, or by sending an email to the ADS–B help desk at [adsb@faa.gov](mailto:adsb@faa.gov). Reports should include:

- 47.3.1** Condition observed;
- 47.3.2** Date and time of observation;
- 47.3.3** Altitude and location of observation;
- 47.3.4** Type and call sign of the aircraft; and
- 47.3.5** Type and software version of avionics system.

*TBL ENR 1.1-6*  
**FIS-B Over UAT Product Update and Transmission Intervals**

<b>Product</b>	<b>Update Interval<sup>1</sup></b>	<b>Transmission Interval (95%)<sup>2</sup></b>	<b>Basic Product</b>
AIRMET	As Available	5 minutes	Yes
AWW/WW	As Available, then at 15 minute intervals for 1 hour	5 minutes	No
Ceiling	As Available	10 minutes	No
Convective SIGMET	As Available, then at 15 minute intervals for 1 hour	5 minutes	Yes
D-ATIS	As Available	1 minute	No
Echo Top	5 minutes	5 minutes	No
METAR/SPECI	1 minute (where available), As Available otherwise	5 minutes	Yes
MRMS NEXRAD (CONUS)	2 minutes	15 minutes	Yes
MRMS NEXRAD (Regional)	2 minutes	2.5 minutes	Yes
NOTAMs-D/FDC	As Available	10 minutes	Yes
NOTAMs-TFR	As Available	10 minutes	Yes
PIREP	As Available	10 minutes	Yes
SIGMET	As Available, then at 15 minute intervals for 1 hour	5 minutes	Yes
SUA Status	As Available	10 minutes	Yes
TAF/AMEND	6 Hours (±15 minutes)	10 minutes	Yes
Temperature Aloft	12 Hours (±15 minutes)	10 minutes	Yes
TWIP	As Available	1 minute	No
Winds aloft	12 Hours (±15 minutes)	10 minutes	Yes
Lightning strikes <sup>3</sup>	5 minutes	5 minutes	Yes
Turbulence <sup>3</sup>	1 minute	15 minutes	Yes
Icing, Forecast Potential (FIP) <sup>3</sup>	60 minutes	15 minutes	Yes
Cloud tops <sup>3</sup>	30 minutes	15 minutes	Yes
1 Minute AWOS <sup>3</sup>	1 minute	10 minutes	No
Graphical-AIRMET <sup>3</sup>	As Available	5 minutes	Yes
Center Weather Advisory (CWA) <sup>3</sup>	As Available	10 minutes	Yes
Temporary Restricted Areas (TRA)	As Available	10 minutes	Yes
Temporary Military Operations Areas (TMOA)	As Available	10 minutes	Yes

<sup>1</sup> The Update Interval is the rate at which the product data is available from the source.

<sup>2</sup> The Transmission Interval is the amount of time within which a new or updated product transmission must be completed (95%) and the rate or repetition interval at which the product is rebroadcast (95%).

<sup>3</sup> The transmission and update intervals for the expanded set of basic meteorological products may be adjusted based on FAA and vendor agreement on the final product formats and performance requirements.

**NOTE–**

1. Details concerning the content, format, and symbols of the various data link products provided should be obtained from the specific avionics manufacturer.
2. NOTAM–D and NOTAM–FDC products broadcast via FIS–B are limited to those issued or effective within the past 30 days.

## **48. Automatic Dependent Surveillance–Rebroadcast (ADS–R)**

### **48.1 Introduction.**

ADS–R is a datalink translation function of the ADS–B ground system required to accommodate the two separate operating frequencies (978 MHz and 1090 ES). The ADS–B system receives the ADS–B messages transmitted on one frequency and ADS–R translates and reformats the information for rebroadcast and use on the other frequency. This allows ADS–B In equipped aircraft to see nearby ADS–B Out traffic regardless of the operating link of the other aircraft. Aircraft operating on the same ADS–B frequency exchange information directly and do not require the ADS–R translation function. (See FIG ENR 1.1–36 and FIG ENR 1.1–37.)

### **48.2 Reports of ADS–R Malfunctions.**

Users of ADS–R can provide valuable assistance in the correction of malfunctions by reporting instances of undesirable system performance. Since ADS–R performance is monitored by maintenance personnel rather than ATC, report malfunctions to the nearest Flight Service Station (FSS) facility by radio or telephone, or by sending an email to the ADS–B help desk at [adsb@faa.gov](mailto:adsb@faa.gov). Reports should include:

- 48.2.1 Condition observed;
- 48.2.2 Date and time of observation;
- 48.2.3 Altitude and location of observation;
- 48.2.4 Type and call sign of the aircraft; and
- 48.2.5 Type and software version of avionics system.

## **49. Heavy Traffic Around Military Fields**

**49.1** Pilots are advised to exercise vigilance when in close proximity to most military airports. These airports may have jet aircraft traffic patterns extending up to 2,500 feet above the surface. In addition, they may have an unusually heavy concentration of jet aircraft operating within a 25–nautical mile radius and from the surface to all altitudes. The precautionary note also applies to the larger civil airports.



## **ENR 1.2 Visual Flight Rules**

See ENR 1.1, ENR 1.4, and ENR 1.10.



## **ENR 1.3 Instrument Flight Rules**

See ENR 1.1, ENR 1.4, and ENR 1.10.





## ENR 1.4 ATS Airspace Classification

### 1. General

1.1 There are two categories of airspace or airspace areas:

1.1.1 Regulatory (Class A, B, C, D, and E airspace areas, restricted and prohibited areas).

1.1.2 Nonregulatory (military operations areas [MOA], warning areas, alert areas, controlled firing areas [CFA], and national security areas [NSA]).

**NOTE-**

*Additional information on special use airspace (prohibited areas, restricted areas [permanent or temporary], warning areas, MOAs [permanent or temporary], alert areas, CFAs, and NSAs) may be found in Section ENR 5.1, Prohibited, Restricted and Other Areas, paragraph 1 and Section ENR 5.2, Military Exercise and Training Areas, paragraphs 1. through 3.*

1.2 Within these two categories, there are four types:

1.2.1 Controlled.

1.2.2 Uncontrolled.

1.2.3 Special use.

1.2.4 Other airspace.

1.3 The categories and types of airspace are dictated by:

1.3.1 The complexity or density of aircraft movements.

1.3.2 The nature of the operations conducted within the airspace.

1.3.3 The level of safety required.

1.3.4 The national and public interest.

1.4 It is important that pilots be familiar with the operational requirements for each of the various types or classes of airspace. Subsequent sections will cover each class in sufficient detail to facilitate understanding.

### 1.5 General Dimensions of Airspace Segments

1.5.1 Refer to Title 14 of the U.S. Code of Federal Regulations (14 CFR) for specific dimensions, exceptions, geographical areas covered, exclusions, specific transponder/ADS-B or other equipment requirements, and flight operations.

**REFERENCE-**

*See GEN 1.7, Annex 2, for U.S. Differences From ICAO Standards, Recommended Practices and Procedures.*

### 1.6 Hierarchy of Overlapping Airspace Designations

1.6.1 When overlapping airspace designations apply to the same airspace, the operating rules associated with the more restrictive airspace designation apply.

1.6.2 For the purpose of clarification:

1.6.2.1 Class A airspace is more restrictive than Class B, Class C, Class D, Class E, or Class G airspace.

1.6.2.2 Class B airspace is more restrictive than Class C, Class D, Class E, or Class G airspace.

1.6.2.3 Class C airspace is more restrictive than Class D, Class E, or Class G airspace.

1.6.2.4 Class D airspace is more restrictive than Class E or Class G airspace.

1.6.2.5 Class E is more restrictive than Class G airspace.

## **1.7 Basic VFR Weather Minimums**

**1.7.1** No person may operate an aircraft under basic VFR when the flight visibility is less, or at a distance from clouds that is less, than that prescribed for the corresponding altitude and class of airspace. (See TBL ENR 1.4-1.)

**NOTE-**

*Student pilots must comply with 14 CFR Section 61.89(A) (6) and (7).*

**1.7.2** Except as provided in 14 CFR Section 91.157, Special VFR Minimums, no person may operate an aircraft beneath the ceiling under VFR within the lateral boundaries of controlled airspace designated to the surface for an airport when the ceiling is less than 1,000 feet. (See 14 CFR Section 91.155(c).)

## **1.8 VFR Cruising Altitudes and Flight Levels**

(See TBL ENR 1.4-2.)

**TBL ENR 1.4-1**  
**Basic VFR Weather Minimums**

Airspace	Flight Visibility	Distance from Clouds
Class A .....	Not Applicable	Not Applicable
Class B .....	3 statute miles	Clear of Clouds
Class C .....	3 statute miles	500 feet below 1,000 feet above 2,000 feet horizontal
Class D .....	3 statute miles	500 feet below 1,000 feet above 2,000 feet horizontal
Class E Less than 10,000 feet MSL .....	3 statute miles	500 feet below 1,000 feet above 2,000 feet horizontal
At or above 10,000 feet MSL .....	5 statute miles	1,000 feet below 1,000 feet above 1 statute mile horizontal
Class G 1,200 feet or less above the surface (regardless of MSL altitude). For aircraft other than helicopters: Day, except as provided in 14 CFR § 91.155(b) .....	1 statute mile	Clear of clouds
Night, except as provided in 14 CFR § 91.155(b) .....	3 statute miles	500 feet below 1,000 feet above 2,000 feet horizontal
For helicopters: Day .....	½ statute mile	Clear of clouds
Night, except as provided in §91.155(b) .....	1 statute mile	Clear of clouds
More than 1,200 feet above the surface but less than 10,000 feet MSL. Day .....	1 statute mile	500 feet below 1,000 feet above 2,000 feet horizontal
Night .....	3 statute miles	500 feet below 1,000 feet above 2,000 feet horizontal
More than 1,200 feet above the surface and at or above 10,000 feet MSL. ....	5 statute miles	1,000 feet below 1,000 feet above 1 statute mile horizontal

**TBL ENR 1.4-2**  
**VFR Cruising Altitudes and Flight Levels**

If your magnetic course (ground track) is:	And you are more than 3,000 feet above the surface but below 18,000 feet MSL, fly:	And you are above 18,000 feet MSL to FL 290, fly:
0° to 179° .....	Odd thousands MSL, plus 500 feet (3,500; 5,500; 7,500, etc.)	Odd Flight Levels plus 500 feet (FL 195; FL 215; FL 235, etc.)
180° to 359° .....	Even thousands MSL, plus 500 feet (4,500; 6,500; 8,500, etc.)	Even Flight Levels plus 500 feet (FL 185; FL 205; FL 225, etc.)

## 2. Controlled Airspace

### 2.1 General

**2.1.1 Controlled Airspace.** A generic term that covers the different classification of airspace (Class A, Class B, Class C, Class D, and Class E airspace) and defined dimensions within which air traffic control service is provided to IFR flights and to VFR flights in accordance with the airspace classification. (See FIG ENR 1.4-1 for Airspace Classes). Airspace classes are pronounced in the ICAO phonetics for clarification. The term “class” may be dropped when referring to airspace in pilot/controller communications.

**2.1.2 IFR Requirements.** IFR operations in any class of controlled airspace requires that a pilot must file an IFR flight plan and receive an appropriate ATC clearance.

**2.1.3 IFR Separation.** Standard IFR separation is provided to all aircraft operating under IFR in controlled airspace.

**2.1.4 VFR Requirements.** It is the responsibility of the pilot to insure that ATC clearance or radio communication requirements are met prior to entry into Class B, Class C, or Class D airspace. The pilot retains this responsibility when receiving ATC radar advisories. (See 14 CFR Part 91.)

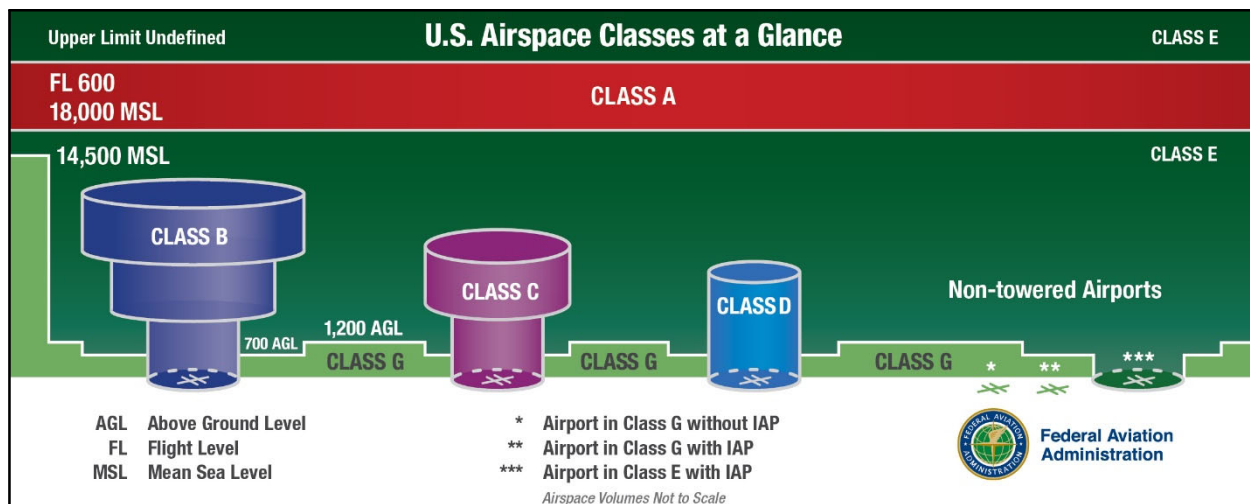
*REFERENCE—  
14 CFR Part 91.*

**2.1.5 Traffic Advisories.** Traffic advisories will be provided to all aircraft as the controller’s work situation permits.

**2.1.6 Safety Alerts.** Safety Alerts are mandatory services and are provided to ALL aircraft. There are two types of Safety Alerts, Terrain/Obstruction Alert and Aircraft Conflict/Mode Intruder Alert.

**2.1.6.1 Terrain/Obstruction Alert.** A Terrain/Obstruction Alert is issued when, in the controller’s judgment, an aircraft’s altitude places it in unsafe proximity to terrain and/or obstructions.

FIG ENR 1.4-1  
Airspace Classes



**2.1.6.2 Aircraft Conflict/Mode C Intruder Alert.** An Aircraft Conflict/Mode C Intruder Alert is issued if the controller observes another aircraft which places it in an unsafe proximity. When feasible, the controller will offer the pilot an alternative course of action.

**2.1.7 Ultralight Vehicles.** No person may operate an ultralight vehicle within Class A, Class B, Class C, or Class D airspace or within the lateral boundaries of the surface area of Class E airspace designated for an airport unless that person has prior authorization from the ATC facility having jurisdiction over that airspace. (See 14 CFR Part 103.)

**2.1.8 Unmanned Free Balloons.** Unless otherwise authorized by ATC, no person may operate an unmanned free balloon below 2,000 feet above the surface within the lateral boundaries of Class B, Class C, Class D, or Class E airspace designated for an airport. (See 14 CFR Part 101.)

**2.1.9 Parachute Jumps.** No person may make a parachute jump, and no pilot in command may allow a parachute jump to be made from that aircraft, in or into Class A, Class B, Class C, or Class D airspace without, or in violation of, the terms of an ATC authorization issued by the ATC facility having jurisdiction over the airspace. (See 14 CFR Part 105.)

## 2.2 Class A Airspace

**2.2.1 Definition.** Generally, that airspace from 18,000 feet MSL up to and including FL 600, including the airspace overlying the waters within 12 nautical miles off the coast of the 48 contiguous States and Alaska; and designated international airspace beyond 12 nautical miles off the coast of the 48 contiguous States and Alaska within areas of domestic radio navigational signal or ATC radar coverage, and within which domestic procedures are applied.

**2.2.2 Operating Rules and Pilot/Equipment Requirements.** Unless otherwise authorized, all persons must operate their aircraft under IFR.

*REFERENCE—*

*14 CFR Section 71.33, Sections 91.167 through 91.193, Sections 91.215 through 91.217, and Sections 91.225 through 91.227.*

**2.2.3 Charts.** Class A airspace is not specifically charted.

## 2.3 Class B Airspace

**2.3.1 Definition.** Generally, that airspace from the surface to 10,000 feet MSL surrounding the nation’s busiest airports in terms of IFR operations or passenger enplanements. The configuration of each Class B airspace area is individually tailored and consists of a surface area and two or more layers (some Class B airspace areas resemble upside-down wedding cakes), and is designed to contain all published instrument procedures once an aircraft enters the airspace. An ATC clearance is required for all aircraft to operate in the area, and all aircraft that are so cleared receive separation services within the airspace. The cloud clearance requirement for VFR operations is “clear of clouds.”

**2.3.2 Operating Rules and Pilot/Equipment Requirements.** Regardless of weather conditions, an ATC clearance is required prior to operating within Class B airspace. Pilots should not request a clearance to operate within Class B airspace unless the requirements of 14 CFR Sections 91.131, 91.215, and 91.225 are met. Included among these requirements are:

**2.3.2.1** Unless otherwise authorized by ATC, aircraft must be equipped with an operable two-way radio capable of communicating with ATC on appropriate frequencies for that Class B airspace.

**2.3.2.2** No person may take off or land a civil aircraft at the following primary airports within Class B airspace unless the pilot in command holds at least a private pilot certificate:

- a) Andrews Air Force Base, MD.
- b) Atlanta Hartsfield Airport, GA.
- c) Boston Logan Airport, MA.
- d) Chicago O’Hare Intl. Airport, IL.
- e) Dallas/Fort Worth Intl. Airport, TX.
- f) Los Angeles Intl. Airport, CA.
- g) Miami Intl. Airport, FL.
- h) Newark Intl. Airport, NJ.
- i) New York Kennedy Airport, NY.

- j) New York La Guardia Airport, NY.
- k) Ronald Reagan Washington National Airport, DC.
- l) San Francisco Intl. Airport, CA.

**2.3.2.3** No person may take off or land a civil aircraft at an airport within Class B airspace or operate a civil aircraft within Class B airspace unless:

- a) The pilot in command holds at least a private pilot certificate; or
- b) The pilot-in-command holds a recreational pilot certificate and has met the requirements of 14 CFR Section 61.101; or
- c) The pilot-in-command holds a sport pilot certificate and has met the requirements of 14 CFR Section 61.325; or
- d) The aircraft is operated by a student pilot:
  - 1) Who seeks a private pilot certificate and has met the requirements of 14 CFR Section 61.95.
  - 2) Who seeks a recreational pilot or sport pilot certificate and has met the requirements of 14 CFR Section 61.94.

**2.3.2.4** Unless otherwise authorized by ATC, each person operating a large turbine engine-powered airplane to or from a primary airport must operate at or above the designated floors while within the lateral limits of Class B airspace.

**2.3.2.5** Unless otherwise authorized by ATC, each aircraft must be equipped as follows:

- a) For IFR operations, an operable VOR or TACAN receiver or an operable and suitable RNAV system; and
- b) For all operations, a two-way radio capable of communications with ATC on appropriate frequencies for that area.
- c) Unless otherwise authorized by ATC, an operable radar beacon transponder with automatic altitude reporting capability and operable ADS-B Out equipment.

**NOTE-**

*ATC may, upon notification, immediately authorize a deviation from the altitude reporting equipment requirement; however, a request for a deviation from the 4096 transponder equipment requirement must be submitted to the controlling ATC facility at least one hour before the proposed operation. A request for a deviation from the ADS-B equipage requirement must be submitted using the FAA's automated web authorization tool at least one hour but not more than 24 hours before the proposed operation. (See ENR 1.1, Paragraph 37.7, Transponder Operation).*

**2.3.2.6 Mode C Veil**

a) The airspace within 30 nautical miles of an airport listed in Appendix D, Section 1 of 14 CFR Part 91 (generally primary airports within Class B airspace areas), from the surface upward to 10,000 feet mean seal level (MSL). Unless otherwise authorized by air traffic control, aircraft operating within this airspace must be equipped with operable radar beacon transponder with automatic altitude reporting capability and operable ADS-B Out equipment.

b) However, aircraft that were not originally certificated with an engine-driven electrical system or that have not subsequently been certified with a system installed may conduct operations within a Mode C veil provided the aircraft remains outside Class A, B or C airspace; and below the altitude of the ceiling of a Class B or Class C airspace area designated for an airport or 10,000 feet MSL, whichever is lower.

**2.3.3 Charts.** Class B airspace is charted on Sectional Charts, IFR En Route Low Altitude Charts, and Terminal Area Charts.

**2.3.4 Flight Procedures**

**2.3.4.1 Flights.** Aircraft within Class B airspace are required to operate in accordance with current IFR procedures. A clearance for a visual approach to a primary airport is not authorization for turbine powered airplanes to operate below the designated floors of the Class B airspace.

### 2.3.4.2 VFR Flights

a) Arriving aircraft must obtain an ATC clearance prior to entering Class B airspace and must contact ATC on the appropriate frequency, and in relation to geographical fixes shown on local charts. Although a pilot may be operating beneath the floor of the Class B airspace on initial contact, communications with ATC should be established in relation to the points indicated for spacing and sequencing purposes.

b) Departing aircraft require a clearance to depart Class B airspace and should advise the clearance delivery position of their intended altitude and route of flight. ATC will normally advise VFR aircraft when leaving the geographical limits of the Class B airspace. Radar service is not automatically terminated with this advisory unless specifically stated by the controller.

c) Aircraft not landing or departing the primary airport may obtain an ATC clearance to transit the Class B airspace when traffic conditions permit and provided the requirements of 14 CFR Section 91.131 are met. Such VFR aircraft are encouraged, to the extent possible, to operate at altitudes above or below the Class B airspace or transit through established VFR corridors. Pilots operating in VFR corridors are urged to use frequency 122.750 MHz for the exchange of aircraft position information.

**2.3.5 ATC Clearances and Separation.** An ATC clearance is required to enter and operate within Class B airspace. VFR pilots are provided sequencing and separation from other aircraft while operating within Class B airspace. (See ENR 1.1, Paragraph 39., Terminal Radar Service for VFR Aircraft.)

**NOTE-**

*Separation and sequencing of VFR will be suspended in the event of a power outage as this service is dependent on radar. The pilot will be advised that the service is not available and issued wind, runway information, and the time or place to contact the tower.*

**2.3.5.1** VFR aircraft are separated from all VFR/IFR aircraft which weigh 19,000 pounds or less by a minimum of:

- a) Target resolution; or
- b) 500 feet vertical separation; or
- c) Visual separation.

**2.3.5.2** VFR aircraft are separated from all VFR/IFR aircraft which weigh more than 19,000 and turbojets by no less than:

- a) 1 1/2 miles lateral separation; or
- b) 500 feet vertical separation; or
- c) Visual separation.

**2.3.5.3** This program is not to be interpreted as relieving pilots of their responsibilities to see and avoid other traffic operating in basic VFR weather conditions, to adjust their operations and flight path as necessary to preclude serious wake encounters, to maintain appropriate terrain and obstruction clearance, or to remain in weather conditions equal to or better than the minimums required by 14 CFR Section 91.155. Approach control should be advised and a revised clearance or instruction obtained when compliance with an assigned route, heading, and/or altitude is likely to compromise pilot responsibility with respect to terrain and obstruction clearance, vortex exposure, and weather minimums.

**2.3.5.4** ATC may assign altitudes to VFR aircraft that do not conform to 14 CFR Section 91.159. "RESUME APPROPRIATE VFR ALTITUDES" will be broadcast when the altitude assignment is no longer needed for separation or when leaving Class B airspace. Pilots must return to an altitude that conforms to 14 CFR Section 91.159.

**2.3.5.5 Proximity Operations.** VFR aircraft operating in proximity to Class B airspace are cautioned against operating too closely to the boundaries, especially where the floor of the Class B airspace is 3,000 feet or less above the surface or where VFR cruise altitudes are at or near the floor of higher levels. Observance of this

precaution will reduce the potential for encountering an aircraft operating at the altitudes of Class B floors. Additionally, VFR aircraft are encouraged to utilize the VFR Planning Chart as a tool for planning flight in proximity to Class B airspace. Charted VFR Flyway Planning charts are published on the back of the existing VFR Terminal Area Charts.

## 2.4 Class C Airspace

**2.4.1 Definition.** Generally, that airspace from the surface to 4,000 feet above the airport elevation (charted in MSL) surrounding those airports that have an operational control tower, are serviced by a radar approach control, and that have a certain number of IFR operations or passenger enplanements. Although the configuration of each Class C airspace area is individually tailored, the airspace usually consists of a surface area with a 5 NM radius, and an outer area with a 10 NM radius that extends no lower than 1,200 feet up to 4,000 feet above the airport elevation.

**2.4.2 Outer Area.** Class C airspace areas have a procedural (nonregulatory) Outer Area. Normally this area is 20 NM from the primary Class C airspace airport. Its vertical limit extends from the lower limits of radio/radar coverage up to the ceiling of the approach control's delegated airspace, excluding the Class C airspace itself, and other airspace as appropriate. (This outer area is not charted.)

**2.4.3 Charts.** Class C airspace is charted on Sectional Charts, IFR En Route Low Altitude, and Terminal Area Charts where appropriate.

## 2.4.4 Operating Rules and Pilot Equipment Requirements

**2.4.4.1 Pilot Certification.** No specific certification required.

### 2.4.4.2 Equipment

a) Two-way radio.

b) Unless otherwise authorized by ATC, an operable radar beacon transponder with automatic altitude reporting capability and operable ADS-B Out equipment.

1) Within the 48 contiguous states and the District of Columbia at and above 10,000 feet MSL, excluding the airspace at and below 2,500 feet above the surface, and

2) At and above 3,000 feet MSL over the Gulf of Mexico from the coastline of the United States out to 12 nautical miles.

#### NOTE-

See Section ENR 1.1, paragraph 37.7, Transponder/ADS-B Operation, subparagraph 37.7.6 for Mode C Transponder Requirements and ENR 1.1, paragraph 45, for ADS-B requirements for operating above Class C airspace.

c) **Arrival or Through Flight Entry Requirements.** Two-way radio communication must be established with the ATC facility providing ATC services prior to entry and thereafter maintain those communications while in Class C airspace. Pilots of arriving aircraft should contact the Class C airspace ATC facility on the publicized frequency and give their position, altitude, radar beacon code, destination, and request Class C service. Radio contact should be initiated far enough from the Class C airspace boundary to preclude entering Class C airspace before two-way radio communications are established.

#### NOTE-

1. If the controller responds to a radio call with, "(aircraft callsign) standby," radio communications have been established and the pilot can enter the Class C airspace.

2. If workload or traffic conditions prevent immediate provision of Class C services, the controller will inform the pilot to remain outside the Class C airspace until conditions permit the services to be provided.

3. It is important to understand that if the controller responds to the initial radio call without using the aircraft identification, radio communications have not been established and the pilot may not enter the Class C airspace.

4. Class C airspace areas have a procedural Outer Area. Normally this area is 20 NM from the primary Class C airspace airport. Its vertical limit extends from the lower limits of radio/radar coverage up to the ceiling of the approach control's delegated airspace, excluding the Class C airspace itself, and other airspace as appropriate. (This outer area is not charted.)



5. Pilots approaching an airport with Class C service should be aware that if they descend below the base altitude of the 5 to 10 mile shelf during an instrument or visual approach, they may encounter non-transponder/non-ADS-B VFR aircraft.

**EXAMPLE-**

1. [Aircraft callsign] “remain outside the Class Charlie airspace and standby.”
2. “Aircraft calling Dulles approach control, standby.”

**d) Departures from:**

1) A primary or satellite airport with an operating control tower. Two-way radio communications must be established and maintained with the control tower, and thereafter as instructed by ATC while operating in Class C airspace.

2) A satellite airport without an operating control tower. Two-way radio communications must be established as soon as practicable after departing with the ATC facility having jurisdiction over the Class C airspace.

**e) Aircraft Speed.** Unless otherwise authorized or required by ATC, no person may operate an aircraft at or below 2,500 feet above the surface within 4 nautical miles of the primary airport of a Class C airspace area at an indicated airspeed of more than 200 knots (230 mph).

**2.4.5 Air Traffic Services.** When two-way radio communications and radar contact are established, all VFR aircraft are:

**2.4.5.1** Sequenced to the primary airport.

**2.4.5.2** Provided Class C services within the Class C airspace and the Outer Area.

**2.4.5.3** Provided basic radar services beyond the outer area on a workload permitting basis. This can be terminated by the controller if workload dictates.

**2.4.6 Aircraft Separation.** Separation is provided within the Class C airspace and the Outer Area after two-way radio communications and radar contact are established. VFR aircraft are separated from IFR aircraft within the Class C airspace by any of the following:

**2.4.6.1** Visual separation.

**2.4.6.2** 500 feet vertical separation.

**2.4.6.3** Target resolution.

**2.4.6.4** Wake turbulence separation will be provided to all aircraft operating:

- a) Behind and less than 1,000 feet below super or heavy aircraft,
- b) To small aircraft operating behind and less than 500 feet below B757 aircraft, and
- c) To small aircraft following a large aircraft on final approach.

**NOTE-**

1. Separation and sequencing of VFR aircraft will be suspended in the event of a radar outage as this service is dependent on radar. The pilot will be advised that the service is not available and issued wind, runway information, and the time or place to contact the tower.

2. Pilot participation is voluntary within the outer area and can be discontinued within the outer area at the pilots request. Class C services will be provided in the outer area unless the pilot requests termination of the service.

3. Some facilities provide Class C services only during published hours. At other times, terminal IFR radar service will be provided. It is important to note that the communications and transponder/ADS-B requirements are dependent on the class of airspace established outside of the published hours.

**2.4.7 Secondary Airports**

**2.4.7.1** In some locations, Class C airspace may overlie the Class D surface area of a secondary airport. In order to allow that control tower to provide service to aircraft, portions of the overlapping Class C airspace may be

procedurally excluded when the secondary airport tower is in operation. Aircraft operating in these procedurally excluded areas will only be provided airport traffic control services when in communication with the secondary airport tower.

**2.4.7.2** Aircraft proceeding inbound to a satellite airport will be terminated at a sufficient distance to allow time to change to the appropriate tower or advisory frequency. Class C services to these aircraft will be discontinued when the aircraft is instructed to contact the tower or change to advisory frequency.

**2.4.7.3** Aircraft departing secondary controlled airports will not receive Class C services until they have been radar identified and two-way communications have been established with the Class C airspace facility.

**2.4.7.4** This program is not to be interpreted as relieving pilots of their responsibilities to see and avoid other traffic operating in basic VFR weather conditions, to adjust their operations and flight path as necessary to preclude serious wake encounters, to maintain appropriate terrain and obstruction clearance, or to remain in weather conditions equal to or better than the minimums required by 14 CFR Section 91.155. Approach control should be advised and a revised clearance or instruction obtained when compliance with an assigned route, heading, and/or altitude is likely to compromise pilot responsibility with respect to terrain and obstruction clearance, vortex exposure, and weather minimums.

#### **2.4.8 Class C Airspace Areas By State**

These states currently have designated Class C airspace areas that are depicted on sectional charts. Pilots should consult current sectional charts and NOTAMs for the latest information on services available. Pilots should be aware that some Class C airspace underlies or is adjacent to Class B airspace. (See TBL ENR 1.4–3.)

TBL ENR 1.4-3  
Class C Airspace Areas by State

State/City	Airport
<b>ALABAMA</b>	
Birmingham . . . . .	Birmingham–Shuttlesworth International
Huntsville . . . . .	International–Carl T Jones Fld
Mobile . . . . .	Regional
<b>ALASKA</b>	
Anchorage . . . . .	Ted Stevens International
<b>ARIZONA</b>	
Davis–Monthan . . . . .	AFB
Tucson . . . . .	International
<b>ARKANSAS</b>	
Fayetteville (Springdale)	Northwest Arkansas Regional
Little Rock . . . . .	Adams Field
<b>CALIFORNIA</b>	
Beale . . . . .	AFB
Burbank . . . . .	Bob Hope
Fresno . . . . .	Yosemite International
Monterey . . . . .	Peninsula
Oakland . . . . .	Metropolitan Oakland International
Ontario . . . . .	International
Riverside . . . . .	March AFB
Sacramento . . . . .	International
San Jose . . . . .	Norman Y. Mineta International
Santa Ana . . . . .	John Wayne/Orange County
Santa Barbara . . . . .	Municipal
<b>COLORADO</b>	
Colorado Springs . . . . .	Municipal
<b>CONNECTICUT</b>	
Windsor Locks . . . . .	Bradley International
<b>FLORIDA</b>	
Daytona Beach . . . . .	International
Fort Lauderdale . . . . .	Hollywood International
Fort Myers . . . . .	SW Florida Regional
Jacksonville . . . . .	International
Orlando . . . . .	Sanford International
Palm Beach . . . . .	International
Pensacola . . . . .	NAS
Pensacola . . . . .	Regional
Sarasota . . . . .	Bradenton International
Tallahassee . . . . .	Regional
Whiting . . . . .	NAS
<b>GEORGIA</b>	
Savannah . . . . .	Hilton Head International
<b>HAWAII</b>	
Kahului . . . . .	Kahului
<b>IDAHO</b>	
Boise . . . . .	Air Terminal
<b>ILLINOIS</b>	
Champaign . . . . .	Urbana U of Illinois–Willard
Chicago . . . . .	Midway International
Moline . . . . .	Quad City International

State/City	Airport
Peoria . . . . .	Greater Peoria Regional
Springfield . . . . .	Abraham Lincoln Capital
<b>INDIANA</b>	
Evansville . . . . .	Regional
Fort Wayne . . . . .	International
Indianapolis . . . . .	International
South Bend . . . . .	Regional
<b>IOWA</b>	
Cedar Rapids . . . . .	The Eastern Iowa
Des Moines . . . . .	International
<b>KANSAS</b>	
Wichita . . . . .	Mid–Continent
<b>KENTUCKY</b>	
Lexington . . . . .	Blue Grass
Louisville . . . . .	International–Standiford Field
<b>LOUISIANA</b>	
Baton Rouge . . . . .	Metropolitan, Ryan Field
Lafayette . . . . .	Regional
Shreveport . . . . .	Barksdale AFB
Shreveport . . . . .	Regional
<b>MAINE</b>	
Bangor . . . . .	International
Portland . . . . .	International Jetport
<b>MICHIGAN</b>	
Flint . . . . .	Bishop International
Grand Rapids . . . . .	Gerald R. Ford International
Lansing . . . . .	Capital City
<b>MISSISSIPPI</b>	
Columbus . . . . .	AFB
Jackson . . . . .	Jackson–Evers International
<b>MISSOURI</b>	
Springfield . . . . .	Springfield–Branson National
<b>MONTANA</b>	
Billings . . . . .	Logan International
<b>NEBRASKA</b>	
Lincoln . . . . .	Lincoln
Omaha . . . . .	Eppley Airfield
Offutt . . . . .	AFB
<b>NEVADA</b>	
Reno . . . . .	Reno/Tahoe International
<b>NEW HAMPSHIRE</b>	
Manchester . . . . .	Manchester
<b>NEW JERSEY</b>	
Atlantic City . . . . .	International
<b>NEW MEXICO</b>	
Albuquerque . . . . .	International Sunport
<b>NEW YORK</b>	
Albany . . . . .	International
Buffalo . . . . .	Niagara International
Islip . . . . .	Long Island MacArthur
Rochester . . . . .	Greater Rochester International
Syracuse . . . . .	Hancock International

State/City	Airport
<b>NORTH CAROLINA</b>	
Asheville . . . . .	Regional
Fayetteville . . . . .	Regional/Grannis Field
Greensboro . . . . .	Piedmont Triad International
Pope . . . . .	AFB
Raleigh . . . . .	Raleigh–Durham International
<b>OHIO</b>	
Akron . . . . .	Akron–Canton Regional
Columbus . . . . .	Port Columbus International
Dayton . . . . .	James M. Cox International
Toledo . . . . .	Express
<b>OKLAHOMA</b>	
Oklahoma City . . . . .	Will Rogers World
Tinker . . . . .	AFB
Tulsa . . . . .	International
<b>OREGON</b>	
Portland . . . . .	International
<b>PENNSYLVANIA</b>	
Allentown . . . . .	Lehigh Valley International
<b>PUERTO RICO</b>	
San Juan . . . . .	Luis Munoz Marin International
<b>RHODE ISLAND</b>	
Providence . . . . .	Theodore Francis Green State
<b>SOUTH CAROLINA</b>	
Charleston . . . . .	AFB/International
Columbia . . . . .	Metropolitan
Greer . . . . .	Greenville–Spartanburg International
Myrtle Beach . . . . .	Myrtle Beach International
Shaw . . . . .	AFB
<b>TENNESSEE</b>	
Chattanooga . . . . .	Lovell Field
Knoxville . . . . .	McGhee Tyson
Nashville . . . . .	International

State/City	Airport
<b>TEXAS</b>	
Abilene . . . . .	Regional
Amarillo . . . . .	Rick Husband International
Austin . . . . .	Austin–Bergstrom International
Corpus Christi . . . . .	International
Dyess . . . . .	AFB
El Paso . . . . .	International
Harlingen . . . . .	Valley International
Laughlin . . . . .	AFB
Lubbock . . . . .	Preston Smith International
Midland . . . . .	International
San Antonio . . . . .	International
<b>VERMONT</b>	
Burlington . . . . .	International
<b>VIRGIN ISLANDS</b>	
St. Thomas . . . . .	Charlotte Amalie Cyril E. King
<b>VIRGINIA</b>	
Richmond . . . . .	International
Norfolk . . . . .	International
Roanoke . . . . .	Regional/Woodrum Field
<b>WASHINGTON</b>	
Point Roberts . . . . .	Vancouver International
Spokane . . . . .	Fairchild AFB
Spokane . . . . .	International
Whidbey Island . . . . .	NAS, Ault Field
<b>WEST VIRGINIA</b>	
Charleston . . . . .	Yeager
<b>WISCONSIN</b>	
Green Bay . . . . .	Austin Straubel International
Madison . . . . .	Dane County Regional–Traux Field
Milwaukee . . . . .	General Mitchell International

**2.5 Class D Airspace**

**2.5.1 Definition.** Generally, Class D airspace extends upward from the surface to 2,500 feet above the airport elevation (charted in MSL) surrounding those airports that have an operational control tower. The configuration of each Class D airspace area is individually tailored and when instrument procedures are published, the airspace will normally be designed to contain the procedures.

**2.5.1.1** Class D surface areas may be designated as full-time or part-time. Part-time Class D effective times are published in the Chart Supplement U.S.

**2.5.1.2** Part–time Class D surface areas may default to either a Class E surface area or Class G airspace. When a part–time Class D surface area defaults to Class G, the surface area airspace becomes Class G up to, but not including, the overlying controlled airspace. Normally, the overlying controlled airspace is the Class E transition area airspace that begins at either 700 feet or 1200 feet AGL. This may be determined by consulting the applicable VFR Sectional or Terminal Area Charts.

**2.5.2 Operating Rules and Pilot Equipment Requirements**

**2.5.2.1 Pilot Certification.** No specific certification required.

**2.5.2.2 Equipment.** Unless otherwise authorized by ATC, an operable two–way radio is required.

**2.5.2.3 Arrival or Through Flight Entry Requirements.** Two-way radio communication must be established with the ATC facility providing ATC services prior to entry and thereafter maintain those communications while in the Class D airspace. Pilots of arriving aircraft should contact the control tower on the publicized frequency and give their position, altitude, destination, and any request(s). Radio contact should be initiated far enough from the Class D airspace boundary to preclude entering the Class D airspace before two-way radio communications are established.

**NOTE–**

1. If the controller responds to a radio call with, “(aircraft callsign) standby,” radio communications have been established, and the pilot can enter the Class D airspace.

2. If workload or traffic conditions prevent immediate entry into Class D airspace, the controller will inform the pilot to remain outside the Class D airspace until conditions permit entry.

**EXAMPLE–**

1. “[Aircraft callsign] remain outside the Class Delta airspace and standby.”

It is important to understand that if the controller responds to the initial radio call without using the aircraft callsign, radio communications have not been established, and the pilot may not enter the Class D airspace.

2. “Aircraft calling Manassas tower standby.”

At those airports where the control tower does not operate 24 hours a day, the operating hours of the tower will be listed on the appropriate charts and in the Chart Supplement U.S. During the hours the tower is not in operation, the Class E surface area rules or a combination of Class E rules to 700 feet above ground level and Class G rules to the surface will become applicable. Check the Chart Supplement U.S. for specifics.

**2.5.2.4 Departures from:**

a) A primary or satellite airport with an operating control tower. Two-way radio communications must be established and maintained with the control tower, and thereafter as instructed by ATC while operating in the Class D airspace.

b) A satellite airport without an operating control tower. Two-way radio communications must be established with the ATC facility having jurisdiction over the Class D airspace as soon as practicable after departing.

**2.5.2.5 Aircraft Speed.** Unless otherwise authorized or required by ATC, no person may operate an aircraft at or below 2,500 feet above the surface within 4 nautical miles of the primary airport of a Class D airspace area at an indicated airspeed of more than 200 knots (230 mph).

**2.5.3** Class D airspace areas are depicted on Sectional and Terminal charts with blue segmented lines, and on IFR En Route Low Altitude charts with a boxed [D].

**2.5.4 Arrival extensions.**

**2.5.4.1** Class D airspace arrival extensions for instrument approach procedures may be Class D or Class E airspace. As a general rule, if all extensions are 2 miles or less, they remain part of the Class D surface area. However, if any one extension is greater than 2 miles, then all extensions become Class E.

**2.5.4.2** Surface area arrival extensions are effective concurrent with the published times of the Class D surface area. For example, if a part-time Class D surface area changes to Class E airspace, the arrival extensions will remain in effect as Class E airspace. If a part-time Class D surface area changes to Class G airspace, the associated arrival extensions will become Class G at the same time.

**2.5.5 Separation for VFR Aircraft.** No separation services are provided to VFR aircraft.

**2.6 Class E Airspace**

**2.6.1 Definition.** Class E airspace is a type of controlled airspace that is designated to serve a variety of terminal or en route purposes as described below.

**2.6.2 Operating Rules and Pilot/Equipment Requirements.**

**2.6.2.1 Pilot Certification.** No specific certification required.

**2.6.2.2 Equipment.** Unless otherwise authorized by ATC:

a) An operable radar beacon transponder with automatic altitude reporting capability and operable ADS-B Out equipment are required at and above 10,000 feet MSL within the 48 contiguous states and the District of Columbia, excluding the airspace at and below 2,500 feet above the surface, and

b) Operable ADS-B Out equipment at and above 3,000 feet MSL over the Gulf of Mexico from the coastline of the United States out to 12 nautical miles.

**NOTE-**

*The airspace described in (b) is specified in 14 CFR § 91.225 for ADS-B Out requirements. However, 14 CFR § 91.215 does not include this airspace for transponder requirements.*

**2.6.2.3 Arrival or Through Flight Entry Requirements.** No specific requirements.

**2.6.3 Charts.** Class E airspace below 14,500 feet MSL is charted on Sectional, Terminal, and IFR Enroute Low Altitude charts.

**2.6.4 Vertical limits.** Except where designated at a lower altitude, Class E airspace in the United States consists of the airspace extending upward from 14,500 feet MSL to, but not including, 18,000 feet MSL overlying: the 48 contiguous states, including the waters within 12 miles from the coast of the 48 contiguous states; the District of Columbia; Alaska, including the waters within 12 miles from the coast of Alaska, and that airspace above FL 600; excluding:

**2.6.4.1** The Alaska peninsula west of longitude 160°00'00"W.; and

**2.6.4.2** The airspace below 1,500 feet above the surface of the earth unless specifically designated lower.

**NOTE-**

*Class E airspace above FL 600 has no upper limit.*

**2.6.5 Types of Class E Airspace**

**2.6.5.1 Surface area designated for an airport.** Class E designated as a surface area for an airport where a control tower is not in operation. The airspace will be configured to contain all instrument procedures. Class E surface areas normally extend from the surface up to but not including the overlying controlled airspace.

**2.6.5.2 Extension to a surface area:**

a) Class E airspace areas may be designated as extensions to Class B, Class C, and Class D surface areas. Such extensions provide controlled airspace to contain standard instrument approach procedures without imposing a communications requirement on pilots operating under VFR. Surface area arrival extensions for instrument approach procedures become part of the primary core surface area and are effective concurrent with the times of the primary core surface area.

b) When a part-time Class C or Class D surface area defaults to Class E, the arrival extensions will remain in effect as Class E airspace. When a part-time Class C, Class D, or Class E surface area defaults to Class G, the associated arrival extensions will default to Class G at the same time.

**2.6.5.3 Airspace used for transition:**

a) Class E airspace areas extending upward from either 700 feet AGL (shown as magenta vignette on sectional charts) or 1,200 feet AGL (blue vignette) are designated in conjunction with an airport with an approved instrument procedure. These areas are used for transitioning aircraft to/from the terminal or en route environment.

b) Unless otherwise specified, 700/1200-foot AGL Class E airspace areas remain in effect continuously, regardless of airport operating hours or surface area status. The 700/1200-foot transition areas should not be confused with surface areas or arrival extensions.

**2.6.5.4 En Route Domestic Areas.** There are Class E airspace areas that extend upward from a specified altitude and are en route domestic airspace areas that provide controlled airspace in those areas where there is a requirement to provide IFR en route ATC services, but the Federal airway system is inadequate.

**2.6.5.5 Federal Airways and Low–altitude RNAV Routes.** Federal airways and low–altitude RNAV routes are Class E airspace areas and, unless otherwise specified, they extend upward from 1,200 feet AGL to, but not including, 18,000 feet MSL. Federal airways consist of L/MF airways (colored Federal airways) and VOR Federal airways. L/MF airways are green, red, amber, and blue. VOR Federal airways are classified as Domestic, Alaskan, and Hawaiian. Low–altitude RNAV routes include T–routes and helicopter RNAV routes (TK–routes).

**2.6.5.6 Offshore Airspace Areas.** There are Class E airspace areas that extend upward from a specified altitude to, but not including, 18,000 feet MSL and are designated as offshore airspace areas. These areas provide controlled airspace beyond 12 nautical miles from the coast of the U.S. in those areas where there is a requirement to provide IFR en route ATC services and within which the U.S. is applying domestic procedures.

**2.6.6 Separation for VFR Aircraft.** No separation services are provided to VFR aircraft.

### 3. Class G Airspace

#### 3.1 General

Class G airspace (uncontrolled) is that portion of airspace that has not been designated as Class A, Class B, Class C, Class D, or Class E airspace.

#### 3.2 VFR Requirements

Rules governing VFR flight have been adopted to assist the pilot in meeting his/her responsibility to see and avoid other aircraft. Minimum flight visibility and distance from clouds required for VFR flight are contained in 14 CFR Section 91.155. (See TBL ENR 1.4–1 for a tabular presentation of these rules).

#### 3.3 IFR Requirements

**3.3.1** Title 14 CFR specifies the pilot and aircraft equipment requirements for IFR flight. Pilots are reminded that in addition to altitude or flight level requirements, 14 CFR Section 91.177 includes a requirement to remain at least 1,000 feet (2,000 feet in designated mountainous terrain) above the highest obstacle within a horizontal distance of 4 nautical miles from the course to be flown.

**3.3.2** IFR Altitudes. (See TBL ENR 1.4–4.)

### 4. Other Airspace Areas

#### 4.1 Airport Advisory/Information Services

**4.1.1** There are two advisory type services available at selected airports. Airports offering these services are listed in the Chart Supplement U.S. and the published service hours may be changed by NOTAM D.

**4.1.1.1** Local Airport Advisory (LAA) service is available only in Alaska and is operated within 10 statute miles of an airport where a control tower is not operating but where a FSS is located on the airport. At such locations, the FSS provides a complete local airport advisory service to arriving and departing aircraft. During periods of fast changing weather the FSS will automatically provide Final Guard as part of the service from the time the aircraft reports “on–final” or “taking–the–active–runway” until the aircraft reports “on–the–ground” or “airborne.”

**NOTE–**

*Current FAA policy, when requesting remote ATC services, requires that a pilot monitor the automated weather broadcast at the landing airport prior to requesting ATC services. The FSS automatically provides Final Guard, when appropriate, during LAA operations. Final Guard is a value added wind/altimeter monitoring service, which provides an automatic wind and altimeter check during active weather situations when the pilot reports on–final or taking the active runway. During the landing or take–off operation when the winds or altimeter are actively changing the FSS will blind broadcast significant changes when the specialist believes the change might affect the operation. Pilots should acknowledge the first wind/altimeter check but due to cockpit activity no acknowledgement is expected for the blind broadcasts. It is prudent for a pilot to report on–the–ground or airborne to end the service.*

**TBL ENR 1.4–4  
IFR Altitudes  
Class G Airspace**

<b>If your magnetic course (ground track) is:</b>	<b>And you are below 18,000 feet MSL, fly:</b>
0° to 179°	Odd thousands MSL, (3,000; 5,000; 7,000, etc.)
180° to 359°	Even thousands MSL, (2,000; 4,000; 6,000, etc.)

**4.1.1.2** Remote Airport Information Service (RAIS) is provided in support of short term special events like small to medium fly-ins. The service is advertised by NOTAM D only. The FSS will not have access to a continuous readout of the current winds and altimeter; therefore, RAIS does not include weather and/or Final Guard service. However, known traffic, special event instructions, and all other services are provided.

**NOTE–**

*The airport authority and/or manager should request RAIS support on official letterhead directly with the manager of the FSS that will provide the service at least 60 days in advance. Approval authority rests with the FSS manager and is based on workload and resource availability.*

**REFERENCE–**

*See GEN 3.3, Air Traffic Services, Paragraph 9.2, Traffic Advisory Practices at Airports Without Operating Control Towers.*

**4.1.1.3** It is not mandatory that pilots participate in the Airport Advisory programs. Participation enhances safety for everyone operating around busy GA airports; therefore, everyone is encouraged to participate and provide feedback that will help improve the program.

**4.2 Published VFR Routes.** Published VFR routes for transitioning around, under, and through complex airspace such as Class B airspace were developed through a number of FAA and industry initiatives. All of the following terms; i.e., “VFR Flyway,” “VFR Corridor,” “Class B Airspace VFR Transition Route,” and “Terminal Area VFR Route” have been used when referring to the same or different types of routes or airspace. The following paragraphs identify and clarify the functionality of each type of route, and specify where and when an ATC clearance is required.

**4.2.1 VFR Flyways**

**4.2.1.1** VFR Flyways and their associated Flyway Planning charts were developed from the recommendations of a National Airspace Review Task Group. A VFR Flyway is defined as a general flight path not defined as a specific course, for use by pilots in planning flights into, out of, through, or near complex terminal airspace to avoid Class B airspace. An ATC clearance is NOT required to fly these routes.

**4.2.1.2** VFR Flyways are depicted on the reverse side of some of the VFR Terminal Area Charts (TAC), commonly referred to as Class B airspace charts. Eventually all TACs will include a VFR Flyway Planning Chart. These charts identify VFR flyways designed to help VFR pilots avoid major controlled traffic flows. They may further depict multiple VFR routings throughout the area which may be used as an alternative to flight within Class B airspace. The ground references provide a guide for improved visual navigation. These routes are not intended to discourage requests for VFR operations within Class B airspace but are designed solely to assist pilots in planning for flights under and around busy Class B airspace without actually entering Class B airspace.

**4.2.1.3** It is very important to remember that these suggested routes are not sterile of other traffic. The entire Class B airspace, and the airspace underneath it, may be heavily congested with many different types of aircraft. Pilot adherence to VFR rules must be exercised at all times. Further, when operating beneath Class B airspace, communications must be established and maintained between your aircraft and any control tower while transiting the Class B, Class C, and Class D surface areas of those airports under Class B Airspace.

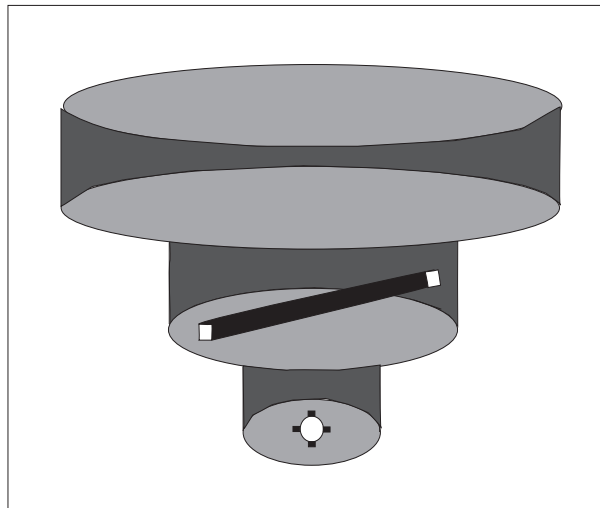
**4.2.2 VFR Corridors**

**4.2.2.1** The design of a few of the first Class B airspace areas provided a corridor for the passage of uncontrolled traffic. A VFR corridor is defined as airspace through Class B airspace, with defined vertical and lateral boundaries, in which aircraft may operate without an ATC clearance or communication with air traffic control.



**4.2.2.2** These corridors are, in effect, a “hole” through Class B airspace. (See FIG ENR 1.4-2.) A classic example would be the corridor through the Los Angeles Class B airspace, which has been subsequently changed to Special Flight Rules airspace (SFR). A corridor is surrounded on all sides by Class B airspace and does not extend down to the surface like a VFR Flyway. Because of their finite lateral and vertical limits, and the volume of VFR traffic using a corridor, extreme caution and vigilance must be exercised.

**FIG ENR 1.4-2  
Class B Airspace**



**4.2.2.3** Because of the heavy traffic volume and the procedures necessary to efficiently manage the flow of traffic, it has not been possible to incorporate VFR corridors in the development or modifications of Class B airspace in recent years.

### **4.2.3 Class B Airspace VFR Transition Routes**

**4.2.3.1** To accommodate VFR traffic through certain Class B airspace, such as Seattle, Phoenix, and Los Angeles, Class B Airspace VFR Transition Routes were developed. A Class B Airspace VFR Transition Route is defined as a specific flight course depicted on a Terminal Area Chart (TAC) for transiting a specific Class B airspace. These routes include specific ATC assigned altitudes, and pilots must obtain an ATC clearance prior to entering Class B airspace on the route.

**4.2.3.2** These routes, as depicted in FIG ENR 1.4-3, are designed to show the pilot where to position his/her aircraft outside of, or clear of, the Class B airspace where an ATC clearance can normally be expected with minimal or no delay. Until ATC authorization is received, pilots must remain clear of Class B airspace. On initial contact, pilots should advise ATC of their position, altitude, route name desired, and direction of flight. After a clearance is received, the pilot must fly the route as depicted and, most importantly, adhere to ATC instructions.

### **4.3 Terminal Radar Service Area (TRSA)**

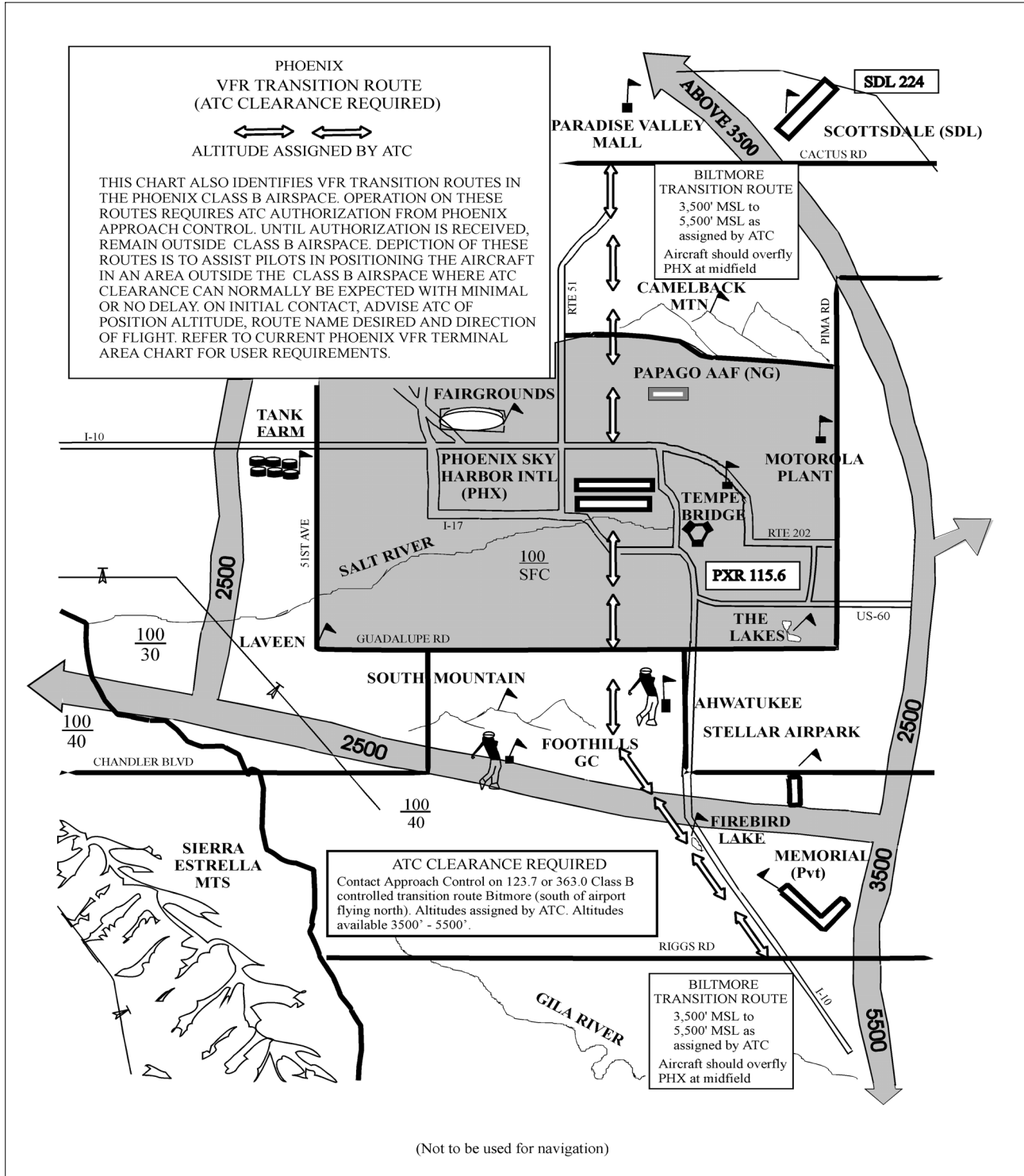
**4.3.1 Background.** The terminal radar service areas (TRSA) were originally established as part of the Terminal Radar Program at selected airports. TRSAs were never controlled airspace from a regulatory standpoint because the establishment of TRSAs were never subject to the rulemaking process; consequently, TRSAs are not contained in 14 CFR Part 71 nor are there any TRSA operating rules in Part 91. Part of the Airport Radar Service Area (ARSA) program was to eventually replace all TRSAs. However, the ARSA requirements became relatively stringent, and it was subsequently decided that TRSAs would have to meet ARSA criteria before they would be converted. TRSAs do not fit into any of the U.S. Airspace Classes; therefore, they will continue to be non-Part 71 airspace areas where participating pilots can receive additional radar services which have been redefined as TRSA Service.

**4.3.2 TRSA Areas.** The primary airport(s) within the TRSA become(s) Class D airspace. The remaining portion of the TRSA overlies other controlled airspace which is normally Class E airspace beginning at 700 or 1,200 feet and established to transition to/from the en route/terminal environment.

**4.3.3 Participation.** Pilots operating under VFR are encouraged to contact the radar approach control and avail themselves of the TRSA Services. However, participation is voluntary on the part of the pilot. See ENR 1.1, paragraph 39.2, for details and procedures.

**4.3.4 Charts.** TRSAs are depicted on VFR sectional and terminal area charts with a solid black line and altitudes for each segment. The Class D portion is charted with a blue segmented line.

FIG ENR 1.4-3  
VFR Transition Route





## ENR 1.5 Holding, Approach, and Departure Procedures

### 1. Holding Procedures

**1.1** Whenever an aircraft is cleared to a fix other than the destination airport and delay is expected, it is the responsibility of ATC to issue complete holding instructions (unless the pattern is charted), an EFC time and best estimate of any additional en route/terminal delay.

**NOTE-**

*Only those holding patterns depicted on U.S. government or commercially produced (meeting FAA requirements) low/high altitude en route, and area or STAR charts should be used.*

**1.2** If the holding pattern is charted and the controller doesn't issue complete holding instructions, the pilot is expected to hold as depicted on the appropriate chart. When the pattern is charted on the assigned procedure or route being flown, ATC may omit all holding instructions except the charted holding direction and the statement *AS PUBLISHED*; for example, *HOLD EAST AS PUBLISHED*. ATC must always issue complete holding instructions when pilots request them.

**1.3** If no holding pattern is charted and holding instructions have not been issued, the pilot should ask ATC for holding instructions prior to reaching the fix. This procedure will eliminate the possibility of an aircraft entering a holding pattern other than that desired by ATC. If unable to obtain holding instructions prior to reaching the fix (due to frequency congestion, stuck microphone, etc.), then enter a standard pattern on the course on which the aircraft approached the fix and request further clearance as soon as possible. In this event, the altitude/flight level of the aircraft at the clearance limit will be protected so that separation will be provided as required.

**1.4** When an aircraft is 3 minutes or less from a clearance limit and a clearance beyond the fix has not been received, the pilot is expected to start a speed reduction so that the aircraft will cross the fix, initially, at or below the maximum holding airspeed.

**1.5** When no delay is expected, the controller should issue a clearance beyond the fix as soon as possible and, whenever possible, at least 5 minutes before the aircraft reaches the clearance limit.

**1.6** Pilots should report to ATC the time and altitude/flight level at which the aircraft reaches the clearance limit and report leaving the clearance limit.

**NOTE-**

*In the event of two-way communications failure, pilots are required to comply with 14 CFR Section 91.185.*

**1.7** Patterns at the most generally used holding fixes are depicted (charted) on U.S. Government or commercially produced (meeting FAA requirements) Low or High Altitude En Route, Area, Departure Procedure, and STAR Charts. Pilots are expected to hold in the pattern depicted unless specifically advised otherwise by ATC. (See ENR 1.1, Paragraph 27. ATC Clearances and Aircraft Separations.)

**NOTE-**

*Holding patterns that protect for a maximum holding airspeed other than the standard may be depicted by an icon, unless otherwise depicted. The icon is a standard holding pattern symbol (racetrack) with the airspeed restriction shown in the center. In other cases, the airspeed restriction will be depicted next to the standard holding pattern symbol.*

**1.8** An ATC clearance requiring an aircraft to hold at a fix where the pattern is not charted will include the following information:

**1.8.1** Direction of holding from the fix in terms of the eight cardinal compass points; i.e., N, NE, E, SE, etc.

**1.8.2** Holding fix. (The fix may be omitted if it is included at the beginning of the transmission as the clearance limit.)

**1.8.3** Radial, course, bearing, airway, or route on which the aircraft is to hold.

**1.8.4** Leg length in miles if DME or RNAV is to be used. (Leg length will be specified in minutes on pilot request or if the controller considers it necessary.)

**1.8.5** Direction of turn if left turns are to be made, the pilot requests, or the controller considers it necessary.

**1.8.6** Time to expect further clearance, and any pertinent additional delay information.

### 1.9 Typical Holding Pattern Example

**1.9.1** When holding at a VOR station, pilots should begin the turn to the outbound leg at the time of the first complete reversal of the “to–from” indicator. See GEN 3.4, Paragraph 12, Two–Way Radio Communications Failure, for holding at the approach fix when radio failure occurs.

#### 1.9.2 Holding Pattern Airspace Protection

Holding pattern airspace protection is based on the following procedures.

**NOTE–**

*Holding pattern airspace protection design criteria is contained in FAA Order 8260.3, United States Standard for Terminal Instrument Procedures (TERPS.)*

##### 1.9.2.1 Airspeeds

- a) All aircraft may hold at the following altitudes and maximum holding airspeeds:

*TBL ENR 1.5-1*

Altitude (MSL)	Airspeed (KIAS)
MHA – 6,000’	200
6,001’ – 14,000’	230
14,001’ and above	265

**NOTE–**

*These are the maximum indicated air speeds applicable to all holding.*

- b) The following are exceptions to the maximum holding airspeeds:

1) Holding patterns from 6,001’ to 14,000’ may be restricted to a maximum airspeed of 210 KIAS. This nonstandard pattern will be depicted by an icon.

2) Holding patterns may be restricted to a maximum speed. The speed restriction is depicted in parenthesis inside the holding pattern on the chart: for example, (175). The aircraft should be at or below the maximum speed prior to initially crossing the holding fix to avoid exiting the protected airspace. Pilots unable to comply with the maximum airspeed restriction should notify ATC.

3) Holding patterns at USAF airfields only – 310 KIAS maximum, unless otherwise depicted.

4) Holding patterns at Navy fields only – 230 KIAS maximum, unless otherwise depicted.

5) All helicopter/power lift aircraft holding on a “COPTER” instrument procedure is predicated on a minimum airspeed of 90 KIAS unless charted otherwise.

6) When a climb–in hold is specified by a published procedure (for example, “Climb–in holding pattern to depart XYZ VORTAC at or above 10,000.” or “All aircraft climb–in TRUCK holding pattern to cross TRUCK Int at or above 11,500 before proceeding on course.”), additional obstacle protection area has been provided to allow for greater airspeeds in the climb for those aircraft requiring them. A maximum airspeed of 310 KIAS is permitted in Climb–in–holding, unless a maximum holding airspeed is published, in which case that maximum airspeed is applicable. The airspeed limitations in 14 CFR Section 91.117, Aircraft Speed, still apply.

- c) The following phraseology may be used by an ATC specialist to advise a pilot of the maximum holding airspeed for a holding pattern airspace area.

**PHRASEOLOGY–**

*(AIRCRAFT IDENTIFICATION) (holding instructions, when needed) MAXIMUM HOLDING AIRSPEED IS (speed in knots).*

FIG ENR 1.5-1  
Holding Pattern Descriptive Terms

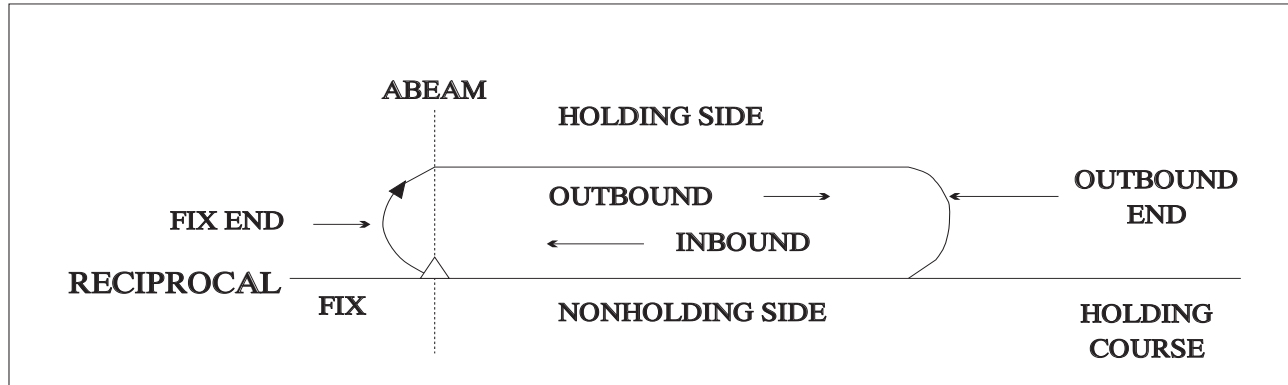


FIG ENR 1.5-2  
Holding Patterns

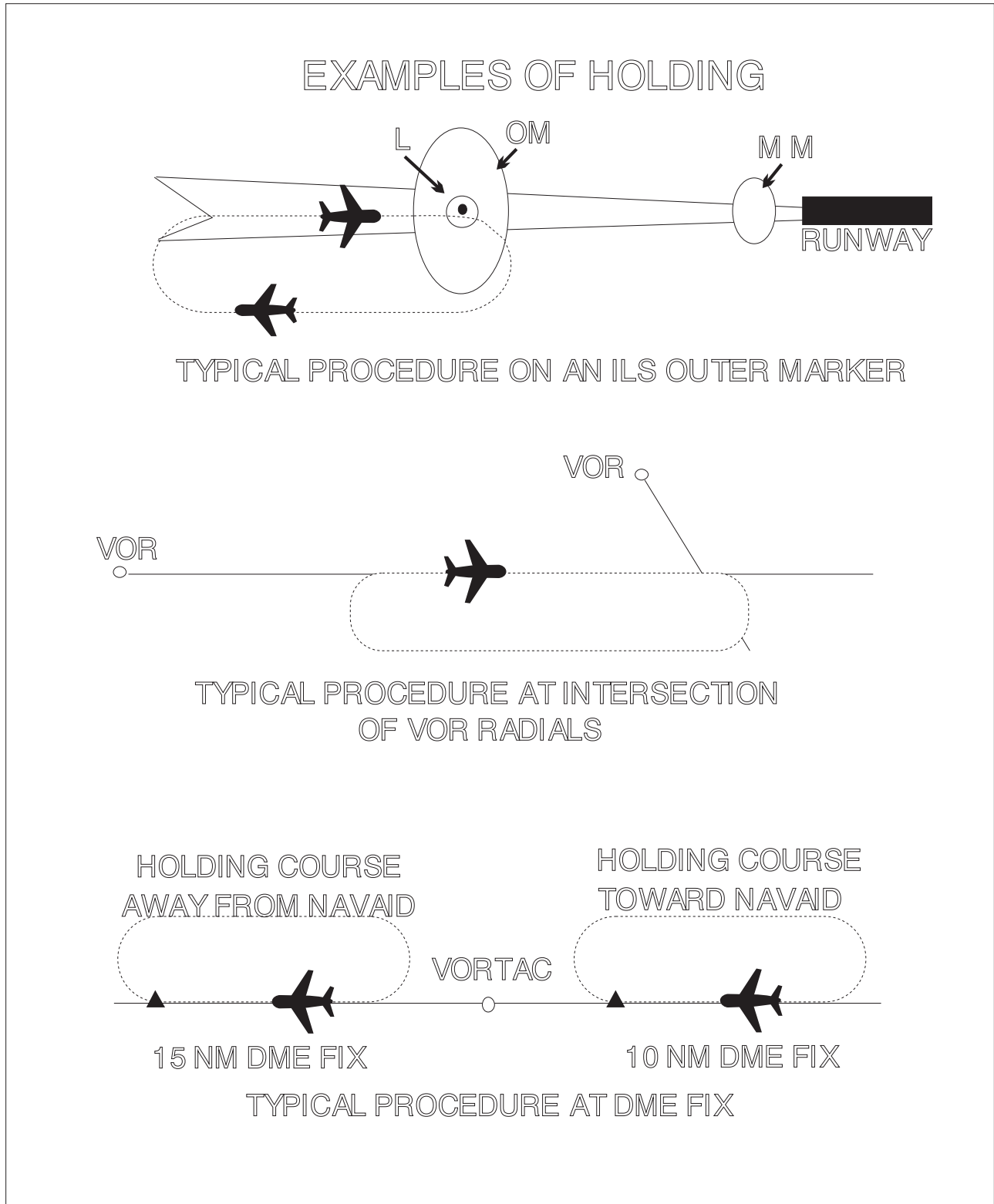
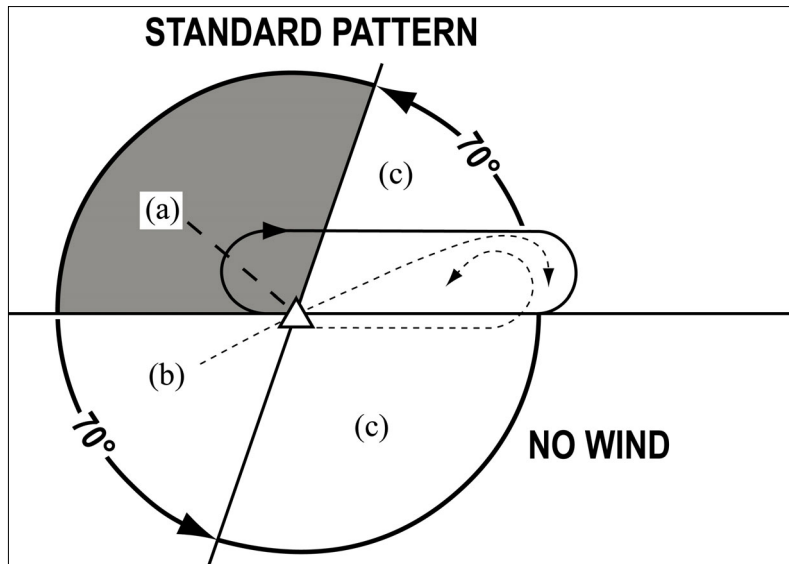




FIG ENR 1.5-3  
Holding Pattern Entry Procedures



**1.9.2.2 Entry Procedures.** Holding protected airspace is designed based in part on pilot compliance with the three recommended holding pattern entry procedures discussed below. Deviations from these recommendations, coupled with excessive airspeed crossing the holding fix, may in some cases result in the aircraft exceeding holding protected airspace. (See FIG ENR 1.5-3.)

**a) Parallel Procedure.** When approaching the holding fix from anywhere in sector (a), the parallel entry procedure would be to turn to a heading to parallel the holding course outbound on the nonholding side for one minute, turn in the direction of the holding pattern through more than 180 degrees, and return to the holding fix or intercept the holding course inbound.

**b) Teardrop Procedure.** When approaching the holding fix from anywhere in sector (b), the teardrop entry procedure would be to fly to the fix, turn outbound to a heading for a 30 degree teardrop entry within the pattern (on the holding side) for a period of one minute, then turn in the direction of the holding pattern to intercept the inbound holding course.

**c) Direct Entry Procedure.** When approaching the holding fix from anywhere in sector (c), the direct entry procedure would be to fly directly to the fix and turn to follow the holding pattern.

**d)** While other entry procedures may enable the aircraft to enter the holding pattern and remain within protected airspace, the parallel, teardrop and direct entries are the procedures for entry and holding recommended by the FAA, and were derived as part of the development of the size and shape of the obstacle protection areas for holding.

**e) Nonstandard Holding Pattern.** Fix end and outbound end turns are made to the left. Entry procedures to a nonstandard pattern are oriented in relation to the 70 degree line on the holding side just as in the standard pattern.

### 1.9.2.3 Timing

#### a) Inbound Leg

- 1) At or below 14,000 feet MSL: 1 minute.
- 2) Above 14,000 feet MSL: 1<sup>1</sup>/<sub>2</sub> minutes.

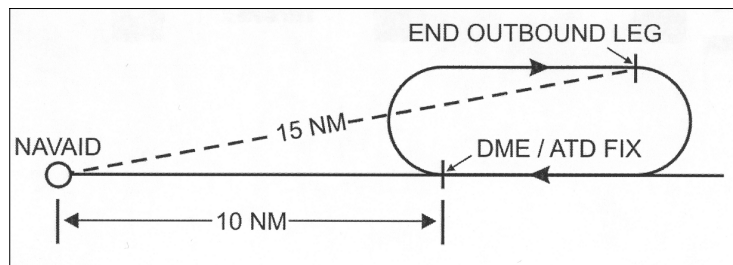
**NOTE-**

*The initial outbound leg should be flown for 1 minute or 1<sup>1</sup>/<sub>2</sub> minutes (appropriate to altitude). Timing for subsequent outbound legs should be adjusted, as necessary, to achieve proper inbound leg time. Pilots may use any navigational means available; i.e. DME, RNAV, etc., to insure the appropriate inbound leg times.*

b) **Outbound Leg** timing begins *over/abeam* the fix, whichever occurs later. If the abeam position cannot be determined, start timing when turn to outbound is completed.

**1.9.2.4 Distance Measuring Equipment (DME)/ GPS Along-Track Distance (ATD).** DME/GPS holding is subject to the same entry and holding procedures except that distances (nautical miles) are used in lieu of time values. The outbound course of the DME/GPS holding pattern is called the outbound leg of the pattern. The controller or the instrument approach procedure chart will specify the length of the outbound leg. The end of the outbound leg is determined by the DME or ATD readout. The holding fix on conventional procedures, or controller defined holding based on a conventional navigation aid with DME, is a specified course or radial and distances are from the DME station for both the inbound and outbound ends of the holding pattern. When flying published GPS overlay or stand alone procedures with distance specified, the holding fix will be a waypoint in the database and the end of the outbound leg will be determined by the ATD. Some GPS overlay and early stand alone procedures may have timing specified. (See FIG ENR 1.5-4, FIG ENR 1.5-5 and FIG ENR 1.5-6.) See ENR 4.1, Paragraph 16. Global Positioning System (GPS), for requirements and restriction on using GPS for IFR operations.

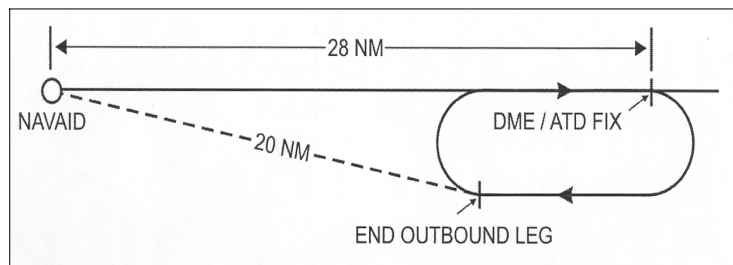
FIG ENR 1.5-4  
**Inbound Toward NAVAID**



**NOTE-**

When the inbound course is toward the NAVAID, the fix distance is 10 NM, and the leg length is 5 NM, then the end of the outbound leg will be reached when the DME reads 15 NM.

FIG ENR 1.5-5  
**Inbound Leg Away from NAVAID**



**NOTE-**

When the inbound course is away from the NAVAID and the fix distance is 28 NM, and the leg length is 8 NM, then the end of the outbound leg will be reached when the DME reads 20 NM.

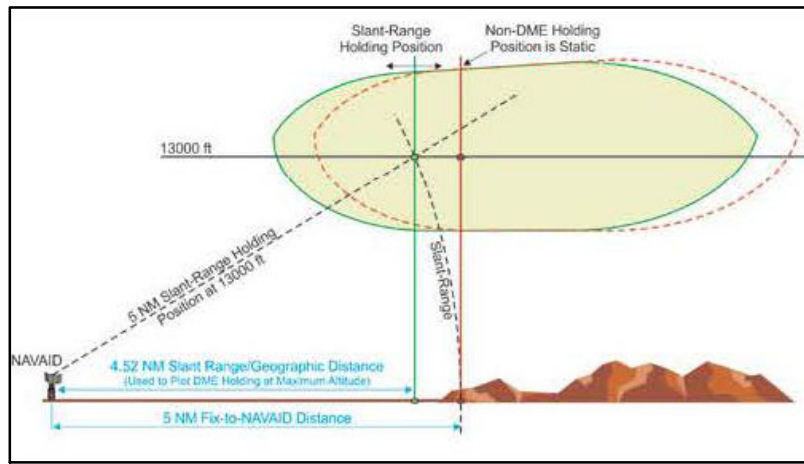
**1.9.2.5 Use of RNAV Distance in lieu of DME Distance.** Substitution of RNAV computed distance to or from a NAVAID in place of DME distance is permitted when holding. However, the actual holding location and pattern flown will be further from the NAVAID than designed due to the lack of slant range in the position solution (see FIG ENR 1.5-6). This may result in a slight difference between RNAV distance readout in reference to the NAVAID and the DME readout, especially at higher altitudes. When used solely for DME substitution, the difference between RNAV distance to/from a fix and DME slant range distance can be considered negligible and no pilot action is required.

**REFERENCE-**

AIP ENR 1.17, Paragraph 3. Use of Suitable Area Navigation (RNAV) Systems on Conventional Procedures and Routes.

**FIG ENR 1.5-6**

**Difference Between DME Distance From NAVAID & RNAV Computed Distance From NAVAID**



**1.9.2.6 Use of RNAV Guidance and Holding.** RNAV systems, including multi-sensor Flight Management Systems (FMS) and stand-alone GPS receivers, may be used to furnish lateral guidance when executing a hold. The manner in which holding is implemented in an RNAV system varies widely between aircraft and RNAV system manufacturers. Holding pattern data may be extracted from the RNAV database for published holds or may be manually entered for ad-hoc ATC-assigned holds. Pilots are expected to be familiar with the capabilities and limitations of the specific RNAV system used for holding.

a) All holding, including holding defined on an RNAV or RNP procedure, is based on the conventional NAVAID holding design criteria, including the holding protected airspace construction. There are differences between the holding entry and flight track assumed in conventional holding pattern design and the entry and track that may be flown when RNAV guidance is used to execute holding. Individually, these differences may not affect the ability of the aircraft to remain within holding pattern protected airspace. However, cumulatively, they can result in deviations sufficient to result in excursions up to limits of the holding pattern protected airspace, and in some circumstances beyond protected airspace. The following difference and considerations apply when an RNAV system furnishes the lateral guidance used to fly a holding pattern:

1) Many systems use ground track angle instead of heading to select the entry method. While the holding pattern design allows a 5 degree tolerance, this may result in an unexpected entry when the winds induce a large drift angle.

2) The holding protected airspace is based on the assumption that the aircraft will fly-over the holding fix upon initial entry. RNAV systems may execute a “fly-by” turn when approaching the holding fix prior to entry. A “fly-by” turn during a direct entry from the holding pattern side of holding course may result in excursions beyond protected airspace, especially as the intercept angle and ground speed increase.

3) During holding, RNAV systems furnish lateral steering guidance using either a constant bank or constant radius to achieve the desired inbound and outbound turns. An aircraft’s flight guidance system may use reduced bank angles for all turns including turns in holding, especially at higher altitudes, that may result in exceeding holding protected airspace. Use of a shallower bank angle will expand both the width and length of the aircraft track, especially as wind speed increases. If the flight guidance system’s bank angle limit feature is pilot-selectable, a minimum 25 degree bank angle should be selected regardless of altitude unless aircraft operating limitations specify otherwise and the pilot advises ATC.

4) Where a holding distance is published, the turn from the outbound leg begins at the published distance from the holding fix, thus establishing the design turn point required to remain within protected airspace. RNAV systems apply a database coded or pilot-entered leg distance as a maximum length of the *inbound* leg to the

holding fix. The RNAV system then calculates a turn point from the outbound leg required to achieve this inbound leg length. This often results in an RNAV-calculated turn point on the outbound leg beyond the design turn point. (See FIG ENR 1.5-7). With a strong headwind against the outbound leg, RNAV systems may fly up to and possibly beyond the limits of protected airspace before turning inbound. (See FIG ENR 1.5-8.) This is especially true at higher altitudes where wind speeds are greater and ground speed results in a wider holding pattern.

FIG ENR 1.5-7  
RNAV Lateral Guidance and Holding – No Wind

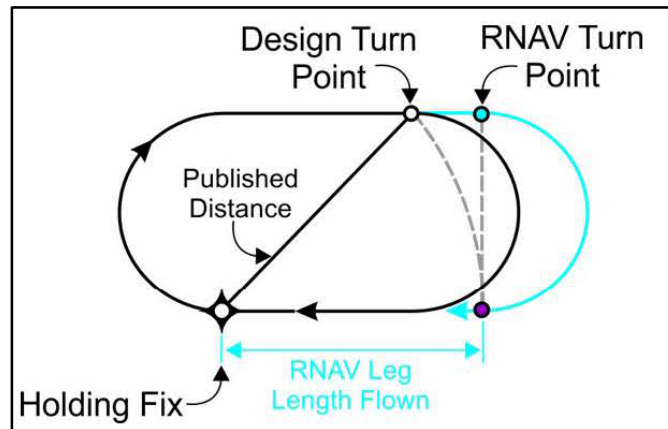
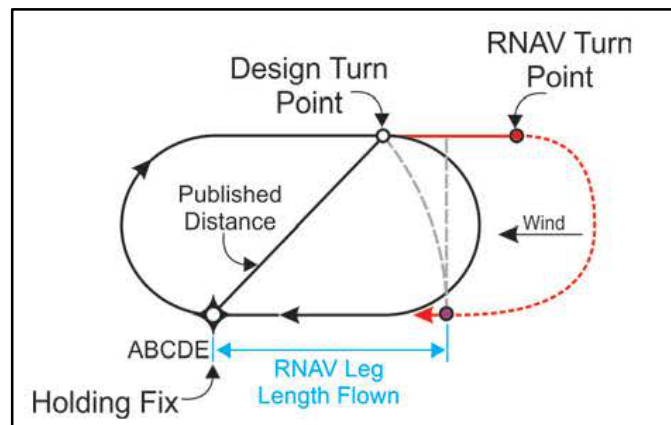


FIG ENR 1.5-8  
RNAV Lateral Guidance and Holding – Effect of Wind



5) Some RNAV systems compute the holding pattern based on the aircraft's altitude and speed at a point prior to entering the hold. If the indicated airspeed is not reduced to comply with the maximum holding speed before this point, the computed pattern may exceed the protected airspace. Loading or executing a holding pattern may result in the speed and time limits applicable to the aircraft's current altitude being used to define the holding pattern for RNAV lateral guidance. This may result in an incorrect hold being flown by the RNAV system. For example, entering or executing the holding pattern above 14,000 feet when intending to hold below 14,000 feet may result in applying 1 ½ minute timing below 14,000 feet.

**NOTE-**

*Some systems permit the pilot to modify leg time of holding patterns defined in the navigation database; for example, a hold-in-lieu of procedure turn. In most RNAV systems, the holding pattern time remains at the pilot-modified time and will not revert back to the coded time if the aircraft descends to a lower altitude where a shorter time interval applies.*

b) RNAV systems are not able to alert the pilot for excursions outside of holding pattern protected airspace since the dimensions of this airspace are not included in the navigation database. In addition, the dimensions of holding pattern protected airspace vary with altitude for a charted holding pattern, even when the hold is used

for the same application. Close adherence to the pilot actions described in this section reduce the likelihood of exceeding the boundary of holding pattern protected airspace when using RNAV lateral guidance to conduct holding.

c) Holding patterns may be stored in the RNAV system's navigation database and include coding with parameters defining how the RNAV system will conduct the hold. For example, coding will determine whether holding is conducted to manual termination (HM), continued holding until the aircraft reaches a specified altitude (HA), or holding is conducted until the holding fix is crossed the first time after entry (HF). Some systems do not store all holding patterns, and may only store patterns associated with missed approaches and hold-in-lieu of procedure turn (HILPT). Some store all holding as standard patterns and require pilot action to conduct non-standard holding (left turns).

1) Pilots are cautioned that multiple holding patterns may be established at the same fix. These holding patterns may differ in respect to turn directions and leg lengths depending on their application as an en route holding pattern, a holding pattern charted on a SID or STAR, or when used on an instrument approach procedure. Many RNAV systems limit the database coding at a particular fix to a single holding pattern definition. Pilots extracting the holding pattern from the navigation database are responsible for confirming that the holding pattern conforms to the assigned charted holding pattern in terms of turn direction, speed limit, timing, and distance.

2) If ATC assigns holding that is not charted, then the pilot is responsible for programming the RNAV system with the assigned holding course, turn direction, speed limit, leg length, or leg time.

3) Changes made after the initial execution may not apply until the next circuit of the holding pattern if the aircraft is in close proximity to the holding fix.

**1.9.2.7 Pilot Action.** The following actions are recommended to ensure that the aircraft remains within holding protected airspace when holding is performed using either conventional NAVAID guidance or when using RNAV lateral guidance.

a) Speed. When ATC furnishes advance notice of holding, start speed reduction to be at or below the maximum holding speed allowed at least 3 minutes prior to crossing the holding fix. If advance notice by ATC is not provided, begin speed reduction as expeditiously as practical. It is acceptable to allow RNAV systems to determine an appropriate deceleration point prior to the holding fix and to manage the speed reduction to the RNAV computed holding speed. If the pilot does not permit the RNAV system to manage the deceleration from the computed point, the actual hold pattern size at holding entry may differ from the holding pattern size computed by the RNAV system.

1) Aircraft are expected to enter holding at or below the maximum holding speed established in paragraph 1.9.2.1a or the charted maximum holding speed.

(a) All fixed wing aircraft conducting holding should fly at speeds at or above 90 KIAS to minimize the influence of wind drift.

(b) When RNAV lateral guidance is used in fixed wing airplanes, it is desirable to enter and conduct holding at the lowest practical airspeed consistent with the airplane's recommended holding speed to address the cumulative errors associated with RNAV holding and increase the probability of remaining within protected airspace. It is acceptable to allow RNAV systems to determine a recommended holding speed *that is at or below the maximum holding speed*.

(c) Helicopter holding is based on a minimum airspeed of 90 KIAS.

2) Advise ATC immediately if unable to comply with the maximum holding airspeed and request an alternate clearance.

**NOTE-**

*Speeds above the maximum or published holding speed may be necessary due to turbulence, icing, etc. Exceeding maximum holding airspeed may result in aircraft excursions beyond the holding pattern protected airspace. In a non-radar environment, the pilot should advise ATC that they cannot accept the assigned hold.*

3) Ensure the RNAV system applies the proper time and speed restrictions to a holding pattern. This is especially critical when climbing or descending to a holding pattern altitude where time and speed restrictions are different than at the present aircraft altitude.

b) **Bank Angle.** For holding not involving the use of RNAV lateral guidance, make all turns during entry and while holding at:

- 1) 3 degrees per second, or
- 2) 30 degree bank angle, or
- 3) 25 degree bank angle, provided a flight director system is used.

**NOTE–**

*Use whichever requires the least bank angle.*

4) When using RNAV lateral guidance to conduct holding, it is acceptable to permit the RNAV system to calculate the appropriate bank angle for the outbound and inbound turns. Do not use flight guidance system bank angle limiting functions of less than 25 degrees unless the feature is not pilot-selectable, required by the aircraft limitations, or its use is necessary to comply with the aircraft's minimum maneuvering speed margins. If the bank angle must be limited to less than 25 degrees, advise ATC that additional area for holding is required.

c) Compensate for wind effect primarily by drift correction on the inbound and outbound legs. When outbound, triple the inbound drift correction to avoid major turning adjustments; for example, if correcting left by 8 degrees when inbound, correct right by 24 degrees when outbound.

d) Determine entry turn from aircraft heading upon arrival at the holding fix; +/- 5 degrees in heading is considered to be within allowable good operating limits for determining entry. When using RNAV lateral guidance for holding, it is permissible to allow the system to compute the holding entry.

e) RNAV lateral guidance may execute a fly-by turn beginning at an excessively large distance from the holding fix. Reducing speed to the maximum holding speed at least 3 minutes prior to reaching the holding fix and using the recommended 25 degree bank angle will reduce potential excursions beyond protected airspace.

f) When RNAV guidance is used for holding, pilots should be prepared to intervene if the turn from outbound leg to the inbound leg does not begin within a reasonable distance of the charted leg length, especially when holding is used as a course reversal HILPT. Pilot intervention is not required when holding in an ATC-assigned holding pattern that is not charted. However, notify ATC when the outbound leg length becomes excessive when RNAV guidance is used for holding.

g) When holding at a fix and instructions are received specifying the time of departure from the fix, the pilot should adjust the aircraft's flight path within the limits of the established holding pattern in order to leave the fix at the exact time specified. After departing the holding fix, normal speed is to be resumed with respect to other governing speed requirements such as terminal area speed limits, specific ATC requests, etc. Where the fix is associated with an instrument approach, and timed approaches are in effect, a procedure turn must not be executed unless the pilot advises ATC, since aircraft holding are expected to proceed inbound on final approach directly from the holding pattern when approach clearance is received.

### **1.10 Radar Surveillance of Holding Pattern Airspace Areas**

**1.10.1** Whenever aircraft are holding, ATC will usually provide radar surveillance of the holding airspace on the controller's radar display.

**1.10.2** The controller will attempt to detect any holding aircraft that stray outside the holding airspace and will assist any detected aircraft to return to the assigned airspace.

**1.10.3** Many factors could prevent ATC from providing this additional service, such as workload, number of targets, precipitation, ground clutter, and radar system capability. These circumstances may make it unfeasible to maintain radar identification of aircraft or to detect aircraft straying from the holding pattern. The provision of this service depends entirely upon whether the controller is in a position to provide it and does not relieve a pilot of the responsibility to adhere to an accepted ATC clearance.

**1.10.4** ATC is responsible for traffic and obstruction separation when they have assigned holding that is not associated with a published (charted) holding pattern. Altitudes assigned will be at or above the minimum vectoring or minimum IFR altitude.

## **2. Approach Procedures**

### **2.1 Approach Control**

**2.1.1** Approach control is responsible for controlling all instrument flight operating within its area of responsibility. Approach control may serve one or more airfields, and control is exercised primarily by direct pilot/controller communications. Prior to arriving at the destination radio facility, instructions will be received from ARTCC to contact approach control on a specified frequency.

### **2.2 Radar Approach Control**

**2.2.1** Where radar is approved for approach control service, it is used not only for radar approaches (Airport Surveillance Radar (ASR) and Precision Approach Radar (PAR)) but is also used to provide vectors in conjunction with published nonradar approaches based on radio NAVAIDs (ILS, VOR, NDB, TACAN). Radar vectors can provide course guidance and expedite traffic to the final approach course of any established instrument approach procedure or to the traffic pattern for a visual approach. Approach control facilities that provide this radar service will operate in the following manner:

**2.2.1.1** Arriving aircraft are either cleared to an outer fix most appropriate to the route being flown with vertical separation and, if required, given holding information or, when radar handoffs are effected between the ARTCC and approach control, or between two approach control facilities, aircraft are cleared to the airport or to a fix so located that the handoff will be completed prior to the time the aircraft reaches the fix. When radar handoffs are utilized, successive arriving flights may be handed off to approach control with radar separation in lieu of vertical separation.

**2.2.1.2** After release to approach control, aircraft are vectored to the appropriate final approach course (ILS, RNAV, GLS, VOR, ADF, etc.). Radar vectors and altitude or flight levels will be issued as required for spacing and separating aircraft. *Therefore, pilots must not deviate from the headings issued by approach control.* Aircraft will normally be informed when it is necessary to vector across the final approach course for spacing or other reasons. If approach course crossing is imminent and the pilot has not been informed that the aircraft will be vectored across the final approach course, the pilot should query the controller.

**2.2.1.3** The pilot is not expected to turn inbound on the final approach course unless an approach clearance has been issued. This clearance will normally be issued with the final vector for interception of the final approach course, and the vector will be such as to enable the pilot to establish the aircraft on the final approach course prior to reaching the final approach fix.

**2.2.1.4** In the case of aircraft already inbound on the final approach course, approach clearance will be issued prior to the aircraft reaching the final approach fix. When established inbound on the final approach course, radar separation will be maintained, and the pilot will be expected to complete the approach utilizing the approach aid designated in the clearance (ILS, RNAV, GLS, VOR, radio beacons, etc.) as the primary means of navigation. Therefore, once established on the final approach course, pilots must not deviate from it unless a clearance to do so is received from ATC.

**2.2.1.5** After passing the final approach fix on final approach, aircraft are expected to continue inbound on the final approach course and complete the approach or effect the missed approach procedure published for that airport.

**2.2.2** ARTCCs are approved for and may provide approach control services to specific airports. The radar systems used by these centers do not provide the same precision as an ASR/PAR used by approach control facilities and towers, and the update rate is not as fast. Therefore, pilots may be requested to report established on the final approach course.

**2.2.3** Whether aircraft are vectored to the appropriate final approach course or provide their own navigation on published routes to it, radar service is automatically terminated when the landing is completed or when instructed to change to advisory frequency at uncontrolled airports, whichever occurs first.

### **3. Standard Terminal Arrival (STAR) Procedures**

**3.1** A STAR is an ATC coded IFR arrival route established for application to arriving IFR aircraft destined for certain airports. STARs simplify clearance delivery procedures, and also facilitate transition between en route and instrument approach procedures.

**3.1.1** STAR procedures may have mandatory speeds and/or crossing altitudes published. Other STARs may have planning information depicted to inform pilots what clearances or restrictions to “**expect.**” “**Expect**” altitudes/speeds are not considered STAR procedures crossing restrictions unless verbally issued by ATC. Published speed restrictions are independent of altitude restrictions and are mandatory unless modified by ATC. Pilots should plan to cross waypoints with a published speed restriction, at the published speed, and should not exceed this speed past the associated waypoint unless authorized by ATC or a published note to do so.

**NOTE–**

*The “**expect**” altitudes/speeds are published so that pilots may have the information for planning purposes. These altitudes/speeds must not be used in the event of lost communications unless ATC has specifically advised the pilot to expect these altitudes/speeds as part of a further clearance.*

**REFERENCE–**

*14 CFR Section 91.185c(2)(iii).*

**3.1.2** Pilots navigating on, or navigating a published route inbound to, a STAR procedure must maintain last assigned altitude until receiving authorization to descend so as to comply with all published/issued restrictions. This authorization will contain the phraseology “DESCEND VIA.” If vectored or cleared to deviate off a STAR, pilots must consider the STAR canceled, unless the controller adds “expect to resume STAR”; pilots should then be prepared to rejoin the STAR at a subsequent fix or procedure leg. If a descent clearance has been received that included a crossing restriction, pilots should expect the controller to issue an altitude to maintain. If the STAR contains published altitude and/or speed restrictions, those restrictions are canceled and pilots will receive an altitude to maintain and, if necessary, a speed.

**3.1.2.1** Clearance to “descend via” authorizes pilots to:

- a) Descend at pilot’s discretion to meet published restrictions and laterally navigate on a STAR.
- b) When cleared to a waypoint depicted on a STAR, to descend from a previously assigned altitude at pilot’s discretion to the altitude depicted at that waypoint.
- c) Once established on the depicted arrival, to descend and to meet all published or assigned altitude and/or speed restrictions.

**NOTE–**

**1.** *When otherwise cleared along a route or procedure that contains published speed restrictions, the pilot must comply with those speed restrictions independent of any descend via clearance.*

**2.** *ATC anticipates pilots will begin adjusting speed the minimum distance necessary prior to a published speed restriction so as to cross the waypoint/fix at the published speed. Once at the published speed, ATC expects pilots will maintain the published speed until additional adjustment is required to comply with further published or ATC assigned speed restrictions or as required to ensure compliance with 14 CFR Section 91.117.*

**3.** *The “descend via” is used in conjunction with STARs to reduce phraseology by not requiring the controller to restate the altitude at the next waypoint/fix to which the pilot has been cleared.*

**4.** *Air traffic will assign an altitude to cross the waypoint/ fix, if no altitude is depicted at the waypoint/fix, for aircraft on a direct routing to a STAR. Air traffic must ensure obstacle clearance when issuing a “descend via” instruction to the pilot.*

**5.** *Minimum en route altitudes (MEA) are not considered restrictions; however, pilots must remain above all MEAs, unless receiving an ATC instruction to descend below the MEA.*



**EXAMPLE–**

**1. Lateral/routing clearance only.**

*“Cleared Tyler One arrival.”*

**NOTE–**

*In Example 1, pilots are cleared to fly the lateral path of the procedure. Compliance with any published speed restrictions is required. No descent is authorized.*

**2. Routing with assigned altitude:**

*“Cleared Tyler One arrival, descend and maintain flight level two four zero.”*

*“Cleared Tyler One arrival, descend at pilot’s discretion, maintain flight level two four zero.”*

**NOTE–**

*In Example 2, the first clearance requires the pilot to descend to FL 240 as directed, comply with any published speed restrictions, and maintain FL 240 until cleared for further vertical navigation with a newly assigned altitude or a “descend via” clearance.*

*The second clearance authorizes the pilot to descend to FL 240 at his discretion, to comply with any published speed restrictions, and then maintain FL 240 until issued further instructions.*

**3. Lateral/routing and vertical navigation clearance.**

*“Descend via the Eagul Five arrival.”*

*“Descend via the Eagul Five arrival, except, cross Vnnom at or above one two thousand.”*

**NOTE–**

*In Example 3, the first clearance authorized the aircraft to descend at pilot’s discretion on the Eagul Five arrival; the pilot must descend so as to comply with all published altitude and speed restrictions.*

*The second clearance authorizes the same, but requires the pilot to descend so as to cross at Vnnom at or above 12,000.*

**4. Lateral/routing and vertical navigation clearance when assigning altitude not published on procedure.**

*“Descend via the Eagul Five arrival, except after Geeno, maintain one zero thousand.”*

*“Descend via the Eagul Five arrival, except cross Geeno at one one thousand then maintain seven thousand.”*

**NOTE–**

*In Example 4, the first clearance authorized the aircraft to track laterally on the Eagul Five Arrival and to descend at pilot’s discretion so as to comply with all altitude and speed restrictions until reaching Geeno and then maintain 10,000. Upon reaching 10,000, aircraft should maintain 10,000 until cleared by ATC to continue to descend.*

*The second clearance requires the same, except the aircraft must cross Geeno at 11,000 and is then authorized to continue descent to and maintain 7,000.*

**5. Direct routing to intercept a STAR and vertical navigation clearance.**

*“Proceed direct Leoni, descend via the Leoni One arrival.”*

*“Proceed direct Denis, cross Denis at or above flight level two zero zero, then descend via the Mmell One arrival.”*

**NOTE–**

*In Example 5, in the first clearance an altitude is published at Leoni; the aircraft proceeds to Leoni, crosses Leoni at the published altitude and then descends via the arrival. If a speed restrictions is published at Leoni, the aircraft will slow to comply with the published speed.*

*In the second clearance, there is no altitude published at Denis; the aircraft must cross Denis at or above FL200, and then descends via the arrival.*

**3.1.2.2** Pilots cleared for vertical navigation using the phraseology “descend via” must inform ATC upon initial contact with a new frequency, of the altitude leaving, “descending via (procedure name),” the runway transition or landing direction if assigned, and any assigned restrictions not published on the procedure.

**EXAMPLE–**

**1.** Delta 121 is cleared to descend via the Eagul Five arrival, runway 26 transition: *“Delta One Twenty One leaving flight level one niner zero, descending via the Eagul Five arrival runway two-six transition.”*

2. Delta 121 is cleared to descend via the Eagul Five arrival, but ATC has changed the bottom altitude to 12,000: “Delta One Twenty One leaving flight level one niner zero for one two thousand, descending via the Eagul Five arrival, runway two-six transition.”

3. (JetBlue 602 is cleared to descend via the Ivane Two arrival, landing south): “JetBlue six zero two leaving flight level two one zero descending via the Ivane Two arrival landing south.”

**NOTE–**

In reference to published altitude restrictions on a STAR or STAR runway transition, the “bottom altitude” is the lowest altitude authorized.

**3.1.2.3** Pilots of IFR aircraft destined to locations for which STARs have been published may be issued a clearance containing a STAR whenever ATC deems it appropriate.

**3.2** Use of STARs requires pilot possession of at least the approved chart. RNAV STARs must be retrievable by the procedure name from the aircraft database and conform to charted procedure. As with any ATC clearance or portion thereof, it is the responsibility of each pilot to accept or refuse an issued STAR. Pilots should notify ATC if they do not wish to use a STAR by placing “NO STAR” in the remarks section of the flight plan or by the less desirable method of verbally stating the same to ATC.

**3.3** STAR charts are published in the Terminal Procedures Publication (TPP) and are available on subscription from the National Aeronautical Charting Office.

**3.4 PBN STAR.**

**3.4.1** Public PBN STARs are normally designed using RNAV 1, RNP 1, or A–RNP NavSpecs. These procedures require system performance currently met by GPS or DME/DME/IRU PBN systems that satisfy the criteria discussed in the current publication of AC 90–100, U.S. Terminal and En Route Area Navigation (RNAV) Operations. These procedures, using RNAV 1 and RNP 1 NavSpecs, must maintain a total system error of not more than 1 NM for 95% of the total flight time. Minimum values for A–RNP procedures will be charted in the PBN box (for example, 1.00 or 0.30).

**3.4.2** In the U.S., a specific procedure’s PBN requirements will be prominently displayed in separate, standardized notes boxes. For procedures with PBN elements, the “PBN box” will contain the procedure’s NavSpec(s); and, if required: specific sensors or infrastructure needed for the navigation solution, any additional or advanced functional requirements, the minimum RNP value, and any amplifying remarks. Items listed in this PBN box are REQUIRED for the procedure’s PBN elements.

**3.4.3** For procedures requiring GPS, if the navigation system does not automatically alert the flight crew of a loss of GPS, the operator must develop procedures to verify correct GPS operation.

**REFERENCE–**

ENR 4.1 Paragraph 16.2.5.10, *Impact of Magnetic Variation on PBN Systems*

**4. Local Flow Traffic Management Program**

**4.1** This program is a continuing effort by the FAA to enhance safety, minimize the impact of aircraft noise, and conserve aviation fuel. The enhancement of safety and reduction of noise are achieved in this program by minimizing low altitude maneuvering of arriving turbojet and turboprop aircraft weighing more than 12,500 pounds and, by permitting departure aircraft to climb to high altitudes sooner, as arrivals are operating at higher altitudes at the points where their flight paths cross. The application of these procedures also reduces exposure time between controlled aircraft and uncontrolled aircraft at the lower altitudes in and around the terminal environment. Fuel conservation is accomplished by absorbing any necessary arrival delays for aircraft included in this program operating at the higher and more fuel efficient altitudes.

**4.2** A fuel efficient descent is basically an uninterrupted descent (except where level flight is required for speed adjustment) from cruising altitude to the point when level flight is necessary for the pilot to stabilize the aircraft on final approach. The procedure for a fuel efficient descent is based on an altitude loss which is most efficient for the majority of aircraft being served. This will generally result in a descent gradient window of 250–350 feet per nautical mile.

**4.3** When crossing altitudes and speed restrictions are issued verbally or are depicted on a chart, ATC will expect the pilot to descend first to the crossing altitude and then reduce speed. Verbal clearances for descent will normally permit an uninterrupted descent in accordance with the procedure as described in paragraph 4.2 above. Acceptance of a charted fuel efficient descent (Runway Profile Descent) clearance requires the pilot to adhere to the altitudes, speeds, and headings depicted on the charts unless otherwise instructed by ATC. **PILOTS RECEIVING A CLEARANCE FOR A FUEL EFFICIENT DESCENT ARE EXPECTED TO ADVISE ATC IF THEY DO NOT HAVE RUNWAY PROFILE DESCENT CHARTS PUBLISHED FOR THAT AIRPORT OR ARE UNABLE TO COMPLY WITH THE CLEARANCE.**

## **5. Advance Information on Instrument Approaches**

**5.1** When landing at airports with approach control services and where two or more instrument approach procedures are published, pilots will be provided in advance of their arrival with the type of approach to expect or that they may be vectored for a visual approach. This information will be broadcast either by a controller or on ATIS. It will not be furnished when the visibility is three miles or better and the ceiling is at or above the highest initial approach altitude established for any low altitude instrument approach procedure for the airport.

**5.2** The purpose of this information is to aid the pilot in planning arrival actions; however, it is not an ATC clearance or commitment and is subject to change. Pilots should bear in mind that fluctuating weather, shifting winds, blocked runway, etc., are conditions which may result in changes to approach information previously received. It is important that pilots advise ATC immediately if they are unable to execute the approach ATC advised will be used, or if they prefer another type of approach.

**5.3** Aircraft destined to uncontrolled airports which have automated weather data with broadcast capability should monitor the ASOS/AWOS frequency to ascertain the current weather for the airport. The pilot must advise ATC when he/she has received the broadcast weather and state his/her intentions.

### **NOTE—**

**1.** *ASOS/AWOS should be set to provide one-minute broadcast weather updates at uncontrolled airports that are without weather broadcast capability by a human observer.*

**2.** *Controllers will consider the long line disseminated weather from an automated weather system at an uncontrolled airport as trend and planning information only and will rely on the pilot for current weather information for the airport. If the pilot is unable to receive the current broadcast weather, the last long-line disseminated weather will be issued to the pilot. When receiving IFR services, the pilot/aircraft operator is responsible for determining if weather/visibility is adequate for approach/landing.*

**5.4** When making an IFR approach to an airport not served by a tower or FSS, after the ATC controller advises “CHANGE TO ADVISORY FREQUENCY APPROVED,” you should broadcast your intentions, including the type of approach being executed, your position, and when over the final approach fix inbound (nonprecision approach) or when over the outer marker or the fix used in lieu of the outer marker inbound (precision approach). Continue to monitor the appropriate frequency (UNICOM, etc.) for reports from other pilots.

## **6. Approach Clearance**

**6.1** An aircraft which has been cleared to a holding fix and subsequently “cleared . . . approach” has not received new routing. Even though clearance for the approach may have been issued prior to the aircraft reaching the holding fix, ATC would expect the pilot to proceed via the holding fix (the last assigned route), and the feeder route associated with that fix (if a feeder route is published on the approach chart) to the initial approach fix (IAF) to commence the approach. **WHEN CLEARED FOR THE APPROACH, THE PUBLISHED OFF AIRWAY (FEEDER) ROUTES THAT LEAD FROM THE EN ROUTE STRUCTURE TO THE IAF ARE PART OF THE APPROACH CLEARANCE.**

**6.2** If a feeder route to an IAF begins at a fix located along the route of flight prior to reaching the holding fix, and clearance for an approach is issued, a pilot should commence the approach via the published feeder route; i.e., the aircraft would not be expected to overfly the feeder route and return to it. The pilot is expected to commence the approach in a similar manner at the IAF, if the IAF for the procedure is located along the route of flight to the holding fix.

**6.3** If a route of flight directly to the initial approach fix is desired, it should be so stated by the controller with phraseology to include the words “direct . . .,” “proceed direct” or a similar phrase which the pilot can interpret without question. If a pilot is uncertain of the clearance, immediately query ATC as to what route of flight is desired.

**6.4** The name of an instrument approach, as published, is used to identify the approach, even though a component of the approach aid, such as the glideslope on an Instrument Landing System, is inoperative or unreliable. The controller will use the name of the approach as published, but must advise the aircraft at the time an approach clearance is issued that the inoperative or unreliable approach aid component is unusable, except when the title of the published approach procedures otherwise allows, for example, ILS or LOC.

**6.5** The following applies to aircraft on radar vectors and/or cleared “direct to” in conjunction with an approach clearance:

**6.5.1** Maintain the last altitude assigned by ATC until the aircraft is established on a published segment of a transition route, or approach procedure segment, or other published route, for which a lower altitude is published on the chart. If already on an established route, or approach or arrival segment, you may descend to whatever minimum altitude is listed for that route or segment

**6.5.2** Continue on the vector heading until intercepting the next published ground track applicable to the approach clearance.

**6.5.3** Once reaching the final approach fix via the published segments, the pilot may continue on approach to a landing.

**6.5.4** If proceeding to an IAF with a published course reversal (procedure turn or hold-in-lieu of PT pattern), except when cleared for a straight in approach by ATC, the pilot must execute the procedure turn/hold-in-lieu of PT, and complete the approach.

**6.5.5** If cleared to an IAF/IF via a NoPT route, or no procedure turn/hold-in-lieu of PT is published, continue with the published approach.

**6.5.6** In addition to the above, RNAV aircraft may be issued a clearance direct to the IAF/IF at intercept angles not greater than 90 degrees for both conventional and RNAV instrument approaches. Controllers may issue a heading or a course direct to a fix between the IF and FAF at intercept angles not greater than 30 degrees for both conventional and RNAV instrument approaches. In all cases, controllers will assign altitudes that ensure obstacle clearance and will permit a normal descent to the FAF. When clearing aircraft direct to the IF, ATC will radar monitor the aircraft until the IF and will advise the pilot to expect clearance direct to the IF at least 5 miles from the fix. ATC must issue a straight-in approach clearance when clearing an aircraft direct to an IAF/IF with a procedure turn or hold-in-lieu of a procedure turn, and ATC does not want the aircraft to execute the course reversal.

**NOTE–**

*Refer to 14 CFR 91.175 (i).*

**6.6** RNAV aircraft may be issued a clearance direct to the FAF that is also charted as an IAF, in which case the pilot is expected to execute the depicted procedure turn or hold-in-lieu of procedure turn. ATC will not issue a straight-in approach clearance. If the pilot desires a straight-in approach, they must request vectors to the final approach course outside of the FAF or fly a published “NoPT” route. When visual approaches are in use, ATC may clear an aircraft direct to the FAF.

**NOTE–**

**1.** *In anticipation of a clearance by ATC to any fix published on an instrument approach procedure, pilots of RNAV aircraft are advised to select an appropriate IAF or feeder fix when loading an instrument approach procedure into the RNAV system.*

**2.** *Selection of “Vectors-to-Final” or “Vectors” option for an instrument approach may prevent approach fixes located outside of the FAF from being loaded into an RNAV system. Therefore, the selection of these options is discouraged due to increased workload for pilots to reprogram the navigation system.*

**6.7 Arrival Holding.** Some approach charts have an arrival holding pattern depicted at an IAF or at a feeder fix located along an airway. The arrival hold is depicted using a “thin line” since it is not always a mandatory part of the instrument procedure.

**6.7.1** Arrival holding is charted where holding is frequently required prior to starting the approach procedure so that detailed holding instructions are not required. The arrival holding pattern is not authorized unless assigned by ATC. Holding at the same fix may also be depicted on the en route chart.

**6.7.2** Arrival holding is also charted where it is necessary to use a holding pattern to align the aircraft for procedure entry from an airway due to turn angle limitations imposed by procedure design standards. When the turn angle from an airway into the approach procedure exceeds the permissible limits, an arrival holding pattern may be published along with a note on the procedure specifying the fix, the airway, and arrival direction where use of the arrival hold is required for procedure entry. Unlike a hold-in-lieu of procedure turn, use of the arrival holding pattern is not authorized until assigned by ATC. If ATC does not assign the arrival hold before reaching the holding fix, the pilot should request the hold for procedure entry. Once established on the inbound holding course and an approach clearance has been received, the published procedure can commence. Alternatively, if using the holding pattern for procedure entry is not desired, the pilot may ask ATC for maneuvering airspace to align the aircraft with the feeder course.

**EXAMPLE–**

*Planview Chart Note: “Proc NA via V343 northeast bound without holding at JOXIT. ATC CLNC REQD.”*

**6.8** An RF leg is defined as a constant radius circular path around a defined turn center that starts and terminates at a fix. An RF leg may be published as part of a procedure. Since not all aircraft have the capability to fly these leg types, pilots are responsible for knowing if they can conduct an RNAV approach with an RF leg. Requirements for RF legs will be indicated on the approach chart in the notes section or at the applicable initial approach fix. Controllers will clear RNAV-equipped aircraft for instrument approach procedures containing RF legs:

**6.8.1** Via published transitions, or

**6.8.2** In accordance with paragraph 6.5.6 above, and

**6.8.3** ATC will not clear aircraft direct to any waypoint beginning or within an RF leg, and will not assign fix/waypoint crossing speeds in excess of charted speed restrictions.

**EXAMPLE–**

**1.** *Controllers will not clear aircraft direct to THIRD because that waypoint begins the RF leg, and aircraft cannot be vectored or cleared to TURNN or vectored to intercept the approach segment at any point between THIRD and FORTH because this is the RF leg. (See FIG ENR 1.5–9.)*

**6.9** When necessary to cancel a previously issued approach clearance, the controller will advise the pilot “Cancel Approach Clearance” followed by any additional instructions when applicable.

## **7. Landing Priority**

**7.1** A clearance for a specific type of approach (ILS, RNAV, GLS, ADF, VOR, or visual approach) to an aircraft operating on an IFR flight plan does not mean that landing priority will be given over other traffic. Traffic control towers handle all aircraft, regardless of the type of flight plan, on a “first-come, first-served” basis. Therefore, because of local traffic or runway in use, it may be necessary for the controller, in the interest of safety, to provide a different landing sequence. In any case, a landing sequence will be issued to each aircraft as soon as possible to enable the pilot to properly adjust the aircraft’s flight path.

## **8. Procedure Turn and Hold-in-lieu of Procedure Turn**

**8.1** A procedure turn is the maneuver prescribed when it is necessary to reverse direction to establish the aircraft inbound on an intermediate or final approach course. The procedure turn or hold-in-lieu-of-PT is a required maneuver when it is depicted on the approach chart, unless cleared by ATC for a straight-in approach.

Additionally, the procedure turn or hold-in-lieu-of-PT is not permitted when the symbol “No PT” is depicted on the initial segment being used, when a RADAR VECTOR to the final approach course is provided, or when conducting a timed approach from a holding fix. The altitude prescribed for the procedure turn is a minimum altitude until the aircraft is established on the inbound course. The maneuver must be completed within the distance specified in the profile view. For a hold-in-lieu-of-PT, the holding pattern should be flown as depicted and the specified leg length/timing must not be exceeded.

**NOTE–**

*The pilot may elect to use the procedure turn or hold-in-lieu-of-PT when it is not required by the procedure, but must first receive an amended clearance from ATC. If the pilot is uncertain whether the ATC clearance intends for a procedure turn to be conducted or to allow for a straight-in approach, the pilot must immediately request clarification from ATC (14 CFR Section 91.123).*

**8.1.1** On U.S. Government charts, a barbed arrow indicates the maneuvering side of the outbound course on which the procedure turn is made. Headings are provided for course reversal using the 45 degree type procedure turn. However, the point at which the turn may be commenced and the type and rate of turn is left to the discretion of the pilot (limited by the charted remain within xx NM distance). Some of the options are the 45 degree procedure turn, the racetrack pattern, the teardrop procedure turn, or the 80 degree ↔ 260 degree course reversal. Racetrack entries should be conducted on the maneuvering side where the majority of protected airspace resides. If an entry places the pilot on the non-maneuvering side of the PT, correction to intercept the outbound course ensures remaining within protected airspace. Some procedure turns are specified by procedural track. These turns must be flown exactly as depicted.

**8.1.2** Descent to the procedure turn (PT) completion altitude from the PT fix altitude (when one has been published or assigned by ATC) must not begin until crossing over the PT fix or abeam and proceeding outbound. Some procedures contain a note in the chart profile view that says “Maintain (altitude) or above until established outbound for procedure turn” (See FIG ENR 1.5–10). Newer procedures will simply depict an “at or above” altitude at the PT fix without a chart note (See FIG ENR 1.5–11). Both are there to ensure required obstacle clearance is provided in the procedure turn entry zone (See FIG ENR 1.5–12). Absence of a chart note or specified minimum altitude adjacent to the PT fix is an indication that descent to the procedure turn altitude can commence immediately upon crossing over the PT fix, regardless of the direction of flight. This is because the minimum altitudes in the PT entry zone and the PT maneuvering zone are the same.

**8.1.3** When the approach procedure involves a procedure turn, a maximum speed of not greater than 200 knots (IAS) should be observed from first overheading the course reversal IAF through the procedure turn maneuver to ensure containment within the obstruction clearance area. Pilots should begin the outbound turn immediately after passing the procedure turn fix. The procedure turn maneuver must be executed within the distance specified in the profile view. The normal procedure turn distance is 10 miles. This may be reduced to a minimum of 5 miles where only Category A or helicopter aircraft are to be operated or increased to as much as 15 miles to accommodate high performance aircraft.

**8.1.4** A teardrop procedure or penetration turn may be specified in some procedures for a required course reversal. The teardrop procedure consists of departure from an initial approach fix on an outbound course followed by a turn toward and intercepting the inbound course at or prior to the intermediate fix or point. Its purpose is to permit an aircraft to reverse direction and lose considerable altitude within reasonably limited airspace. Where no fix is available to mark the beginning of the intermediate segment, it must be assumed to commence at a point 10 miles prior to the final approach fix. When the facility is located on the airport, an aircraft is considered to be on final approach upon completion of the penetration turn. However, the final approach segment begins on the final approach course 10 miles from the facility.

FIG ENR 1.5-9  
Example of an RNAV Approach with RF Leg

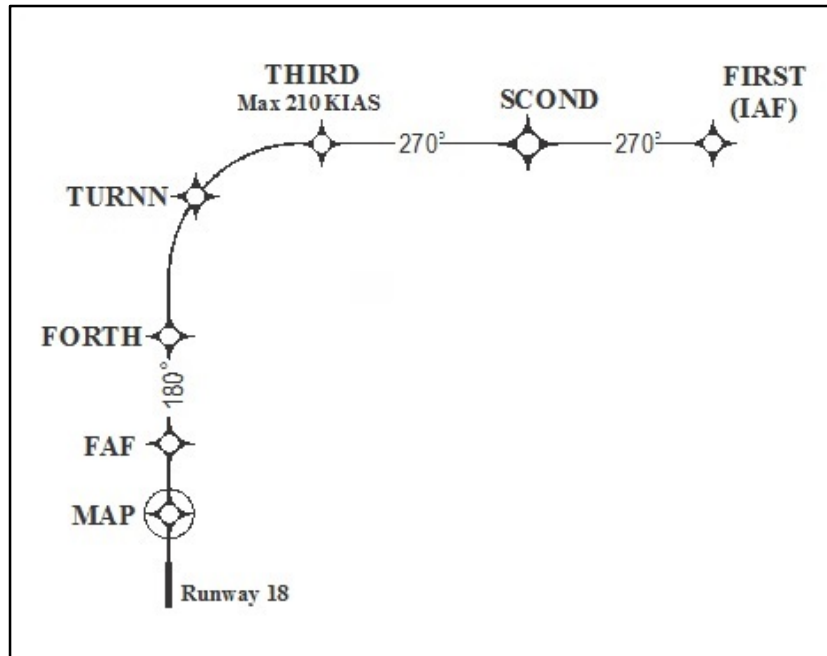


FIG ENR 1.5-10

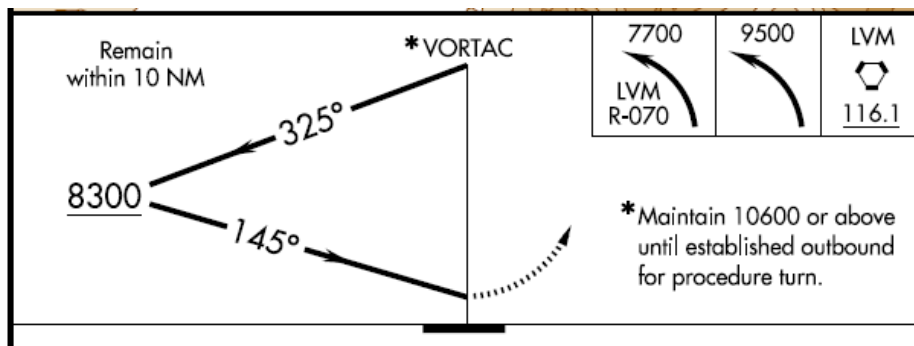
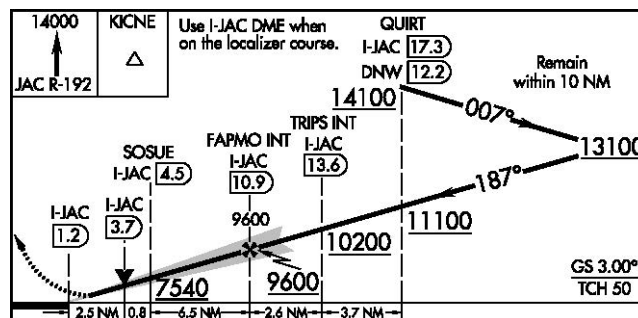


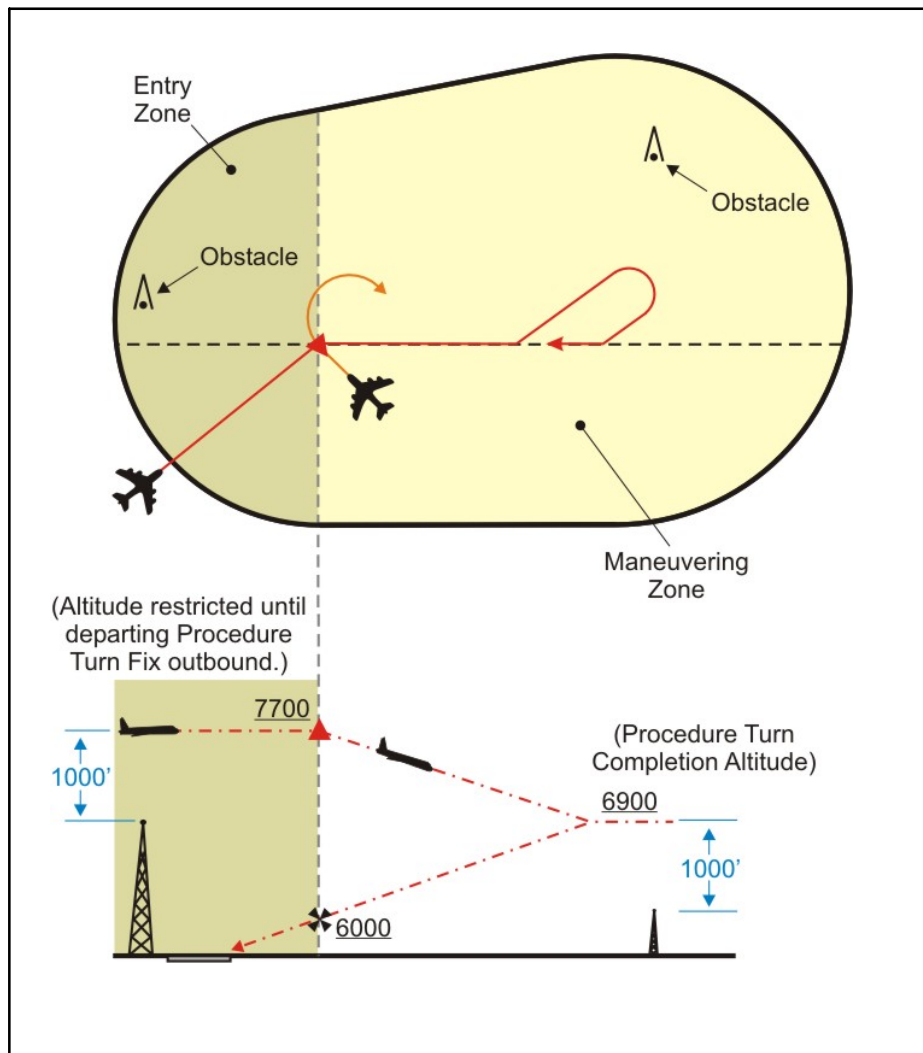
FIG ENR 1.5-11



**8.1.5** A holding pattern in lieu of procedure turn may be specified for course reversal in some procedures. In such cases, the holding pattern is established over an intermediate fix or a final approach fix. The holding pattern distance or time specified in the profile view must be observed. For a hold-in-lieu-of-PT, the holding pattern direction must be flown as depicted and the specified leg length/timing must not be exceeded. Maximum holding airspeed limitations as set forth for all holding patterns apply. The holding pattern maneuver is completed when the aircraft is established on the inbound course after executing the appropriate entry. If cleared for the approach prior to returning to the holding fix, and the aircraft is at the prescribed altitude, additional circuits of the holding pattern are not necessary nor expected by ATC. If pilots elect to make additional circuits to lose excessive altitude or to become better established on course, it is their responsibility to so advise ATC upon receipt of their approach clearance.

**8.1.6** A procedure turn is not required when an approach can be made directly from a specified intermediate fix to the final approach fix. In such cases, the term “NoPT” is used with the appropriate course and altitude to denote that the procedure turn is not required. If a procedure turn is desired, and when cleared to do so by ATC, descent below the procedure turn altitude should not be made until the aircraft is established on the inbound course, since some NoPT altitudes may be lower than the procedure turn altitudes.

FIG ENR 1.5-12





## 8.2 Limitations on Procedure Turns

**8.2.1** In the case of a radar initial approach to a final approach fix or position, or a timed approach from a holding fix, or where the procedure specifies NoPT, no pilot may make a procedure turn unless, when final approach clearance is received, the pilot so advises ATC and a clearance is received to execute a procedure turn.

**8.2.2** When a teardrop procedure turn is depicted and a course reversal is required, this type turn must be executed.

**8.2.3** When a holding pattern replaces a procedure turn, the holding pattern must be followed, except when RADAR VECTORING is provided or when NoPT is shown on the approach course. The recommended entry procedures will ensure the aircraft remains within the holding pattern's protected airspace. As in the procedure turn, the descent from the minimum holding pattern altitude to the final approach fix altitude (when lower) may not commence until the aircraft is established on the inbound course. Where a holding pattern is established in-lieu-of a procedure turn, the maximum holding pattern airspeeds apply.

**NOTE–**

See paragraph 1.9.2.1, Airspeeds.

**8.2.4** The absence of the procedure turn barb in the plan view indicates that a procedure turn is not authorized for that procedure.

## 9. RNP AR (Authorization Required) Instrument Procedures

**9.1** RNP AR procedures require authorization analogous to the special authorization required for Category II or III ILS procedures. All operators require specific authorization from the FAA to fly any RNP AR approach or departure procedure. The FAA issues RNP AR authorization via operations specification (OpSpec), management specification (Mspec), or letter of authorization (LOA). There are no exceptions. Operators can find comprehensive information on RNP AR aircraft eligibility, operating procedures, and training requirements in AC 90–101, Approval Guidance for RNP Procedures with AR.

**9.2** Unique characteristics of RNP AR Operations Approach title. The FAA titles all RNP AR instrument approach procedures (IAP) as “RNAV (RNP) RWY XX.” All RNP AR procedures will clearly state “Authorization Required” on the procedure chart.

**9.3** RNP value. RNP AR procedures are characterized by use of a lateral Obstacle Evaluation Area (OEA) equal to two times the RNP value (2 x RNP) in nautical miles. No secondary lateral OEA or additional buffers are used. RNP AR procedures require a minimum lateral accuracy value of RNP 0.30. Each published line of minima in an RNP AR procedure has an associated RNP value that defines the procedure's lateral performance requirement in the Final Approach Segment. Each approved RNP AR operator's FAA-issued authorization will identify a minimum authorized RNP approach value. This value may vary depending on aircraft configuration or operational procedures (e.g., use of flight director or autopilot).

**9.4** Radius-to-fix (RF) legs. Many RNP AR IFPs contain RF legs. Aircraft eligibility for RF legs is required in any authorization for RNP AR operations.

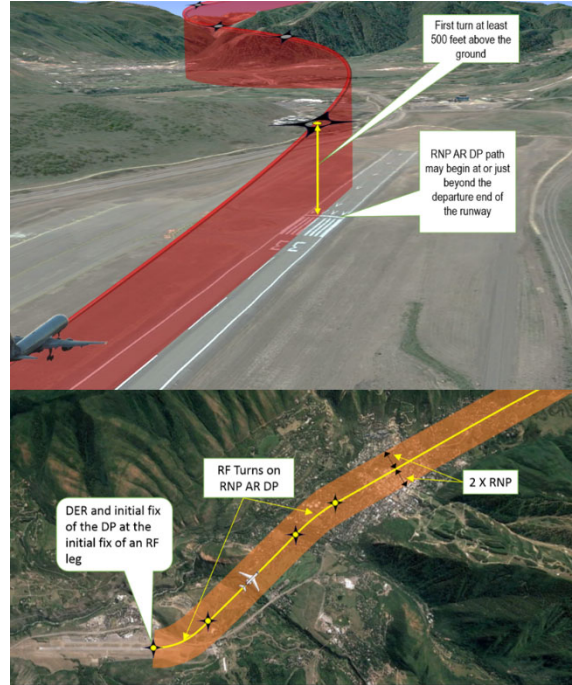
**9.5** Missed Approach RNP value less than 1.00 NM. Some RNP AR IFPs require an RNP lateral accuracy value of less than 1.00 NM in the missed approach segment. The operator's FAA-issued RNP AR authorization will specify whether the operator may fly a missed approach procedure requiring a lateral accuracy value less than 1.00 NM. AC 90–101 identifies specific operating procedures and training requirements applicable to this aspect of RNP AR procedures.

**9.6** Non-standard speeds or climb gradients. RNP AR approaches may require non-standard approach speeds and/or missed approach climb gradients. RNP AR approach charts will reflect any non-standard requirements and pilots must confirm they can meet those requirements before commencing the approach.

**9.7** RNP AR Departure Procedures (RNP AR DP). RNP AR approach authorization is a mandatory prerequisite for an operator to be eligible to perform RNP AR DPs. RNP AR DPs can utilize a minimum RNP value of RNP

0.30, may include higher than standard climb gradients, and may include RF turns. Close in RF turns associated with RNP AR DPs may begin as soon as the departure end of the runway (DER). For specific eligibility guidance, operators should refer to AC 90–101.

**FIG ENR 1.5–13**  
**Example of an RNP AR DP**



## 10. Side-step Maneuver

**10.1** ATC may authorize a standard instrument approach procedure which serves either one of parallel runways that are separated by 1,200 feet or less followed by a straight-in landing on the adjacent runway.

**10.2** Aircraft that will execute a side-step maneuver will be cleared for a specified approach procedure and landing on the adjacent parallel runway. Example, “cleared ILS runway 7 left approach, side-step to runway 7 right.” Pilots are expected to commence the side-step maneuver as soon as possible after the runway or runway environment is in sight. Compliance with minimum altitudes associated with stepdown fixes is expected even after the side-step maneuver is initiated.

**NOTE–**

*Side-step minima are flown to a Minimum Descent Altitude (MDA) regardless of the approach authorized.*

**10.3** Landing minimums to the adjacent runway will be based on nonprecision criteria and therefore higher than the precision minimums to the primary runway, but will normally be lower than the published circling minimums.

## 11. Approach and Landing Minimums

**11.1 Landing Minimums.** The rules applicable to landing minimums are contained in 14 CFR Section 91.175. TBL ENR 1.5–2 may be used to convert RVR to ground or flight visibility. For converting RVR values that fall between listed values, use the next higher RVR value; do not interpolate. For example, when converting 1800 RVR, use 2400 RVR with the resultant visibility of  $\frac{1}{2}$  mile.

TBL ENR 1.5–2  
RVR Value Conversions

RVR	Visibility (statute miles)
1600	$\frac{1}{4}$
2400	$\frac{1}{2}$
3200	$\frac{5}{8}$
4000	$\frac{3}{4}$
4500	$\frac{7}{8}$
5000	1
6000	$1\frac{1}{4}$

**11.1.1** Aircraft approach category means a grouping of aircraft based on a speed of  $V_{REF}$  at the maximum certified landing weight, if specified, or if  $V_{REF}$  is not specified,  $1.3V_{SO}$  at the maximum certified landing weight.  $V_{REF}$ ,  $V_{SO}$ , and the maximum certified landing weight are those values as established for the aircraft by the certification authority of the country of registry. A pilot must maneuver the aircraft within the circling approach protected area (see FIG ENR 1.5–14) to achieve the obstacle and terrain clearances provided by procedure design criteria.

**11.1.2** In addition to pilot techniques for maneuvering, one acceptable method to reduce the risk of flying out of the circling approach protected area is to use either the minima corresponding to the category determined during certification or minima associated with a higher category. Helicopters may use Category A minima. If it is necessary to operate at a speed in excess of the upper limit of the speed range for an aircraft’s category, the minimums for the higher category should be used. This may occur with certain aircraft types operating in heavy/gusty wind, icing, or non-normal conditions. For example, an airplane which fits into Category B, but is circling to land at a speed of 145 knots, should use the approach Category D minimums. As an additional example, a Category A airplane (or helicopter) which is operating at 130 knots on a straight-in approach should use the approach Category C minimums.

**11.1.3** A pilot who chooses an alternative method when it is necessary to maneuver at a speed that exceeds the category speed limit (for example, where higher category minimums are not published) should consider the following factors that can significantly affect the actual ground track flown:

**11.1.3.1** Bank angle. For example, at 165 knots groundspeed, the radius of turn increases from 4,194 feet using 30 degrees of bank to 6,654 feet when using 20 degrees of bank. When using a shallower bank angle, it may be necessary to modify the flightpath or indicated airspeed to remain within the circling approach protected area. Pilots should be aware that excessive bank angle can lead to a loss of aircraft control.

**11.1.3.2** Indicated airspeed. Procedure design criteria typically utilize the highest speed for a particular category. If a pilot chooses to operate at a higher speed, other factors should be modified to ensure that the aircraft remains within the circling approach protected area.

**11.1.3.3** Wind speed and direction. For example, it is not uncommon to maneuver the aircraft to a downwind leg where the groundspeed will be considerably higher than the indicated airspeed. Pilots must carefully plan the initiation of all turns to ensure that the aircraft remains within the circling approach protected area.

**11.1.3.4** Pilot technique. Pilots frequently have many options with regard to flightpath when conducting circling approaches. Sound planning and judgment are vital to proper execution. The lateral and vertical path to be flown should be carefully considered using current weather and terrain information to ensure that the aircraft remains within the circling approach protected area.

**11.1.4** It is important to remember that 14 CFR Section 91.175(c) requires that “where a DA/DH or MDA is applicable, no pilot may operate an aircraft below the authorized MDA or continue an approach below the authorized DA/DH unless the aircraft is continuously in a position from which a descent to a landing on the

intended runway can be made at a normal rate of descent using normal maneuvers, and for operations conducted under Part 121 or Part 135 unless that descent rate will allow touchdown to occur within the touchdown zone of the runway of intended landing.”

**11.1.5** See the following category limits:

**11.1.5.1** Category A: Speed less than 91 knots.

**11.1.5.2** Category B: Speed 91 knots or more but less than 121 knots.

**11.1.5.3** Category C: Speed 121 knots or more but less than 141 knots.

**11.1.5.4** Category D: Speed 141 knots or more but less than 166 knots.

**11.1.5.5** Category E: Speed 166 knots or more.

**NOTE–**

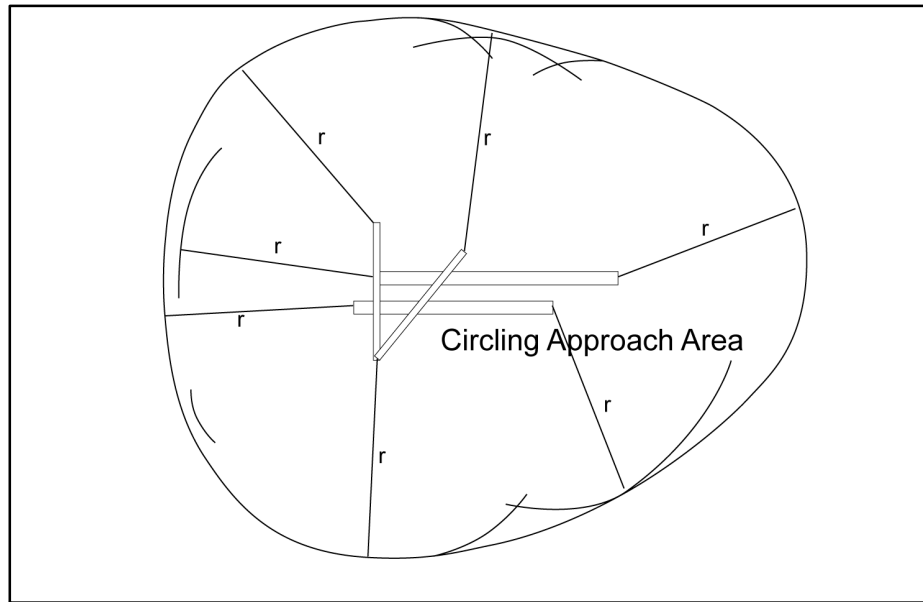
*V<sub>REF</sub>* in the above definition refers to the speed used in establishing the approved landing distance under the airworthiness regulations constituting the type certification basis of the airplane, regardless of whether that speed for a particular airplane is 1.3 V<sub>SO</sub>, 1.23 V<sub>SR</sub>, or some higher speed required for airplane controllability. This speed, at the maximum certificated landing weight, determines the lowest applicable approach category for all approaches regardless of actual landing weight.

**11.2 Published Approach Minimums.** Approach minimums are published for different aircraft categories and consist of a minimum altitude (DA, DH, MDA) and required visibility. These minimums are determined by applying the appropriate TERPS criteria. When a fix is incorporated in a nonprecision final segment, two sets of minimums may be published; one for the pilot that is able to identify the fix, and a second for the pilot that cannot. Two sets of minimums may also be published when a second altimeter source is used in the procedure. When a nonprecision procedure incorporates both a stepdown fix in the final segment and a second altimeter source, two sets of minimums are published to account for the stepdown fix and a note addresses minimums for the second altimeter source.

**11.3 Obstacle Clearance.** Final approach obstacle clearance is provided from the start of the final segment to the runway or missed approach point, whichever occurs last. Side-step obstacle protection is provided by increasing the width of the final approach obstacle clearance area.

**11.3.1** Circling approach protected areas are defined by the tangential connection of arcs drawn from each runway end (see FIG ENR 1.5–14). Circling approach protected areas developed prior to late 2012 used fixed radius distances, dependent on aircraft approach category, as shown in the table on page B2 of the U.S. TPP. The approaches using standard circling approach areas can be identified by the absence of the “negative C” symbol on the circling line of minima. Circling approach protected areas developed after late 2012 use the radius distance shown in the table on page B2 of the U.S. TPP, dependent on aircraft approach category, and the altitude of the circling MDA, which accounts for true airspeed increase with altitude. The approaches using expanded circling approach areas can be identified by the presence of the “negative C” symbol on the circling line of minima (see FIG ENR 1.5–15). Because of obstacles near the airport, a portion of the circling area may be restricted by a procedural note; for example, “Circling NA E of RWY 17–35.” Obstacle clearance is provided at the published minimums (MDA) for the pilot who makes a straight-in approach, side-steps, or circles. Once below the MDA the pilot must see and avoid obstacles. Executing the missed approach after starting to maneuver usually places the aircraft beyond the MAP. The aircraft is clear of obstacles when at or above the MDA while inside the circling area, but simply joining the missed approach ground track from the circling maneuver may not provide vertical obstacle clearance once the aircraft exits the circling area. Additional climb inside the circling area may be required before joining the missed approach track. See ENR 1.5–27., Missed Approach, for additional considerations when starting a missed approach at other than the MAP.

FIG ENR 1.5-14  
Final Approach Obstacle Clearance



**NOTE-**  
Circling approach area radii vary according to approach category and MSL circling altitude due to TAS changes – see FIG ENR 1.5-15.

FIG ENR 1.5-15  
Standard and Expanded Circling Approach Radii in the U.S. TPP

STANDARD CIRCLING APPROACH MANEUVERING RADIUS

Circling approach protected areas developed prior to late 2012 used the radius distances shown in the following table, expressed in nautical miles (NM), dependent on aircraft approach category. The approaches using standard circling approach areas can be identified by the absence of the **C** symbol on the circling line of minima.

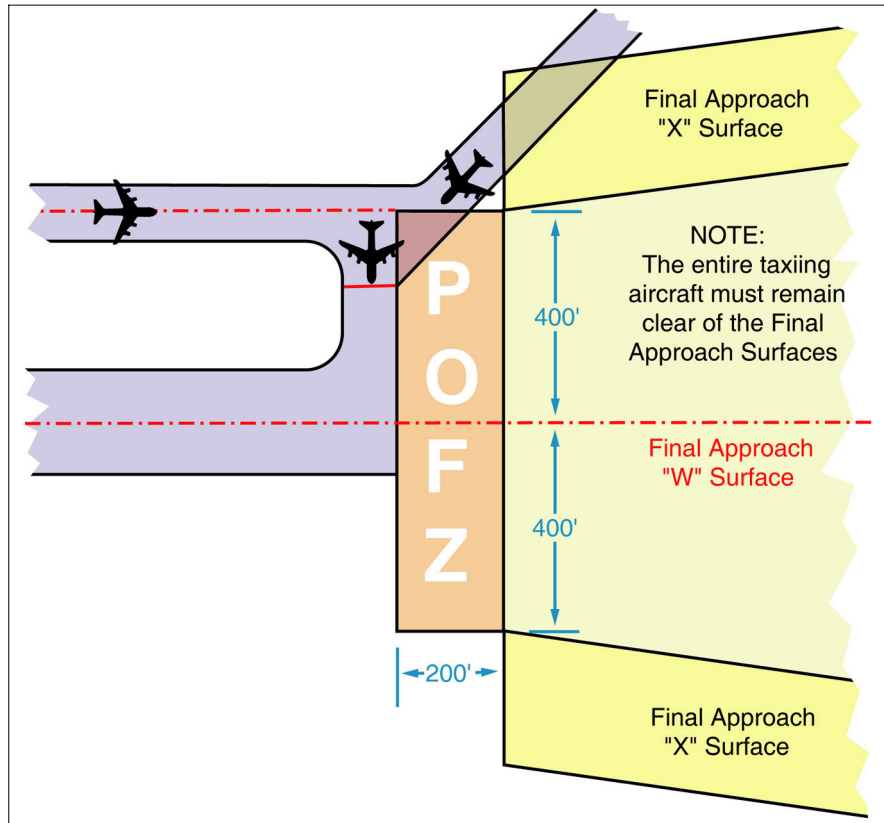
Circling MDA in feet MSL	Approach Category and Circling Radius (NM)				
	CAT A	CAT B	CAT C	CAT D	CAT E
All Altitudes	1.3	1.5	1.7	2.3	4.5

**C** EXPANDED CIRCLING APPROACH MANEUVERING AIRSPACE RADIUS

Circling approach protected areas developed after late 2012 use the radius distance shown in the following table, expressed in nautical miles (NM), dependent on aircraft approach category, and the altitude of the circling MDA, which accounts for true airspeed increase with altitude. The approaches using expanded circling approach areas can be identified by the presence of the **C** symbol on the circling line of minima.

Circling MDA in feet MSL	Approach Category and Circling Radius (NM)				
	CAT A	CAT B	CAT C	CAT D	CAT E
1000 or less	1.3	1.7	2.7	3.6	4.5
1001-3000	1.3	1.8	2.8	3.7	4.6
3001-5000	1.3	1.8	2.9	3.8	4.8
5001-7000	1.3	1.9	3.0	4.0	5.0
7001-9000	1.4	2.0	3.2	4.2	5.3
9001 and above	1.4	2.1	3.3	4.4	5.5

FIG ENR 1.5–16  
Precision Obstacle Free Zone (POFZ)



**11.3.2 Precision Obstacle Free Zone (POFZ).** A volume of airspace above an area beginning at the runway threshold, at the threshold elevation, and centered on the extended runway centerline. The POFZ is 200 feet (60m) long and 800 feet (240m) wide. The POFZ must be clear when an aircraft on a vertically guided final approach is within 2 nautical miles of the runway threshold and the official weather observation is a ceiling below 250 feet or visibility less than  $\frac{3}{4}$  statute mile (SM) (or runway visual range below 4,000 feet). If the POFZ is not clear, the MINIMUM authorized height above touchdown (HAT) and visibility is 250 feet and  $\frac{3}{4}$  SM. The POFZ is considered clear even if the wing of the aircraft holding on a taxiway waiting for runway clearance penetrates the POFZ; however, neither the fuselage nor the tail may infringe on the POFZ. The POFZ is applicable at all runway ends including displaced thresholds. (See FIG ENR 1.5–16.)

**11.4 Straight-In Minimums** are shown on the IAP when the final approach course is within 30 degrees of the runway alignment and a normal descent can be made from the IFR altitude shown on the IAP to the runway surface. When either the normal rate of descent or the runway alignment factor of 30 degrees is exceeded, a straight-in minimum is not published and a circling minimum applies. The fact that a straight-in minimum is not published does not preclude pilots from landing straight-in if they have the active runway in sight and have sufficient time to make a normal approach for landing. Under such conditions and when ATC has cleared them for landing on that runway, pilots are not expected to circle even though only circling minimums are published. If they desire to circle, they should advise ATC.

**11.5 Side-Step Maneuver Minimums.** Landing minimums for a side-step maneuver to the adjacent runway will normally be higher than the minimums to the primary runway.

**11.6 Circling Minimums.** In some busy terminal areas, ATC may not allow circling and circling minimums will not be published. Published circling minimums provide obstacle clearance when pilots remain within the appropriate area of protection. Pilots should remain at or above the circling altitude until the aircraft is continuously in a position from which a descent to a landing on the intended runway can be made at a normal

rate of descent using normal maneuvers. Circling may require maneuvers at low altitude, at low airspeed, and in marginal weather conditions. Pilots must use sound judgment, have an in-depth knowledge of their capabilities, and fully understand the aircraft performance to determine the exact circling maneuver since weather, unique airport design, and the aircraft position, altitude, and airspeed must all be considered. The following basic rules apply:

**11.6.1** Maneuver the shortest path to the base or downwind leg, as appropriate, considering existing weather conditions. There is no restriction from passing over the airport or other runways.

**11.6.2** It should be recognized that circling maneuvers may be made while VFR or other flying is in progress at the airport. Standard left turns or specific instruction from the controller for maneuvering must be considered when circling to land.

**11.6.3** At airports without a control tower, it may be desirable to fly over the airport to observe wind and turn indicators and other traffic which may be on the runway or flying in the vicinity of the airport.

**REFERENCE–**

*AC 90–66A, Recommended Standards Traffic patterns for Aeronautical Operations at Airports without Operating Control Towers.*

**11.6.4** The missed approach point (MAP) varies depending upon the approach flown. For vertically guided approaches, the MAP is at the decision altitude/decision height. Non-vertically guided and circling procedures share the same MAP and the pilot determines this MAP by timing from the final approach fix, by a fix, a NAVAID, or a waypoint. Circling from a GLS, an ILS without a localizer line of minima or an RNAV (GPS) approach without an LNAV line of minima is prohibited.

**11.7 Instrument Approaches at a Military Field.** When instrument approaches are conducted by civil aircraft at military airports, they must be conducted in accordance with the procedures and minimums approved by the military agency having jurisdiction over the airport.

## 12. Instrument Approach Procedure (IAP) Charts

**12.1** 14 CFR Section 91.175(a), Instrument approaches to civil airports, requires the use of SIAPs prescribed for the airport in 14 CFR Part 97 unless otherwise authorized by the Administrator (including ATC). If there are military procedures published at a civil airport, aircraft operating under 14 CFR Part 91 must use the civil procedure(s). Civil procedures are defined with “FAA” in parenthesis; e.g., (FAA), at the top, center of the procedure chart. DOD procedures are defined using the abbreviation of the applicable military service in parenthesis; for example, (USAF), (USN), (USA). 14 CFR Section 91.175(g), Military airports, requires civil pilots flying into or out of military airports to comply with the IAP’s and takeoff and landing minimums prescribed by the authority having jurisdiction at those airports. Unless an emergency exists, civil aircraft operating at military airports normally require advance authorization, commonly referred to as “Prior Permission Required” or “PPR.” Information on obtaining a PPR for a particular military airport can be found in the Chart Supplement U.S.

**NOTE–**

*Civil aircraft may conduct practice VFR approaches using DOD instrument approach procedures when approved by the air traffic controller.*

**12.1.1** IAPs (standard and special, civil and military) are based on joint civil and military criteria contained in the U.S. Standard for TERPS. The design of IAPs based on criteria contained in TERPS, takes into account the interrelationship between airports, facilities, and the surrounding environment, terrain, obstacles, noise sensitivity, etc. Appropriate altitudes, courses, headings, distances, and other limitations are specified and, once approved, the procedures are published and distributed by government and commercial cartographers as instrument approach charts.

**12.1.2** Not all IAPs are published in chart form. Radar IAPs are established where requirements and facilities exist but they are printed in tabular form in appropriate U.S. Government Flight Information Publications.

**12.1.3** The navigation equipment required to join and fly an instrument approach procedure is indicated by the title of the procedure and notes on the chart.

**12.1.3.1** Straight-in IAPs are identified by the navigational system providing the final approach guidance and the runway to which the approach is aligned (e.g., VOR RWY 13). Circling only approaches are identified by the navigational system providing final approach guidance and a letter (e.g., VOR A). More than one navigational system separated by a slash indicates that more than one type of equipment must be used to execute the final approach (e.g., VOR/DME RWY 31). More than one navigational system separated by the word “or” indicates either type of equipment may be used to execute the final approach (for example, VOR or GPS RWY 15).

**12.1.3.2** In some cases, other types of navigation systems including radar may be required to execute other portions of the approach or to navigate to the IAF (e.g., an NDB procedure turn to an ILS, an NDB in the missed approach, or radar required to join the procedure or identify a fix). When radar or other equipment is required for procedure entry from the en route environment, a note will be charted in the planview of the approach procedure chart (for example, RADAR REQUIRED or ADF REQUIRED). When radar or other equipment is required on portions of the procedure outside the final approach segment, including the missed approach, a note will be charted in the notes box of the pilot briefing portion of the approach chart (for example, RADAR REQUIRED or DME REQUIRED). Notes are not charted when VOR is required outside the final approach segment. Pilots should ensure that the aircraft is equipped with the required NAVAID(s) in order to execute the approach, including the missed approach.

**NOTE–**

*Some military (i.e., U.S. Air Force and U.S. Navy) IAPs have these “additional equipment required” notes charted only in the planview of the approach procedure and do not conform to the same application standards used by the FAA.*

**12.1.3.3** The FAA has initiated a program to provide a new notation for LOC approaches when charted on an ILS approach requiring other navigational aids to fly the final approach course. The LOC minimums will be annotated with the NAVAID required (for example, “DME Required” or “RADAR Required”). During the transition period, ILS approaches will still exist without the annotation.

**12.1.3.4** Many ILS approaches having minima based on RVR are eligible for a landing minimum of RVR 1800. Some of these approaches are to runways that have touchdown zone and centerline lights. For many runways that do not have touchdown and centerline lights, it is still possible to allow a landing minimum of RVR 1800. For these runways, the normal ILS minimum of RVR 2400 can be annotated with a single or double asterisk or the dagger symbol “†”; for example “\*\* 696/24 200 (200/1/2).” A note is included on the chart stating “\*\*RVR 1800 authorized with use of FD or AP or HUD to DA.” The pilot must use the flight director, or autopilot with an approved approach coupler, or head up display to decision altitude or to the initiation of a missed approach. In the interest of safety, single pilot operators should not fly approaches to 1800 RVR minimums on runways without touchdown and centerline lights using only a flight director, unless accompanied by the use of an autopilot with an approach coupler.

**12.1.3.5** The naming of multiple approaches of the same type to the same runway is also changing. Multiple approaches with the same guidance will be annotated with an alphabetical suffix beginning at the end of the alphabet and working backwards for subsequent procedures (e.g., ILS Z RWY 28, ILS Y RWY 28, etc.). The existing annotations such as ILS 2 RWY 28 or Silver ILS RWY 28 will be phased out and replaced with the new designation. The Cat II and Cat III designations are used to differentiate between multiple ILSs to the same runway unless there are multiples of the same type.

**12.1.3.6** RNAV (GPS) approaches to LNAV, LP, LNAV/VNAV and LPV lines of minima using WAAS and RNAV (GPS) approaches to LNAV and LNAV/VNAV lines of minima using GPS are charted as RNAV (GPS) RWY (Number) (e.g., RNAV (GPS) RWY 21).

**12.1.3.7** Performance-Based Navigation (PBN) Box. As charts are updated, a procedure’s PBN requirements and conventional equipment requirements will be prominently displayed in separate, standardized notes boxes. For procedures with PBN elements, the PBN box will contain the procedure’s navigation specification(s); and, if required: specific sensors or infrastructure needed for the navigation solution, any additional or advanced functional requirements, the minimum Required Navigation Performance (RNP) value, and any amplifying remarks. Items listed in this PBN box are REQUIRED for the procedure’s PBN elements. For example, an ILS



with an RNAV missed approach would require a specific capability to fly the missed approach portion of the procedure. That required capability will be listed in the PBN box. The separate Equipment Requirements box will list ground-based equipment requirements. On procedures with both PBN elements and equipment requirements, the PBN requirements box will be listed first. The publication of these notes will continue incrementally until all charts have been amended to comply with the new standard.

**12.1.4** Approach minimums are based on the local altimeter setting for that airport, unless annotated otherwise; for example, Oklahoma City/Will Rogers World approaches are based on having a Will Rogers World altimeter setting. When a different altimeter source is required, or more than one source is authorized, it will be annotated on the approach chart; e.g., use Sidney altimeter setting, if not received, use Scottsbluff altimeter setting. Approach minimums may be raised when a nonlocal altimeter source is authorized. When more than one altimeter source is authorized, and the minima are different, they will be shown by separate lines in the approach minima box or a note; e.g., use Manhattan altimeter setting; when not available use Salina altimeter setting and increase all MDAs 40 feet. When the altimeter must be obtained from a source other than air traffic a note will indicate the source; e.g., Obtain local altimeter setting on CTAF. When the altimeter setting(s) on which the approach is based is not available, the approach is not authorized. Baro-VNAV must be flown using the local altimeter setting only. Where no local altimeter is available, the LNAV/VNAV line will still be published for use by WAAS receivers with a note that Baro-VNAV is not authorized. When a local and at least one other altimeter setting source is authorized and the local altimeter is not available Baro-VNAV is not authorized; however, the LNAV/VNAV minima can still be used by WAAS receivers using the alternate altimeter setting source.

**NOTE–**

*Barometric Vertical Navigation (baro-VNAV). An RNAV system function which uses barometric altitude information from the aircraft's altimeter to compute and present a vertical guidance path to the pilot. The specified vertical path is computed as a geometric path, typically computed between two waypoints or an angle based computation from a single waypoint. Further guidance may be found in Advisory Circular 90–105.*

**12.1.5** A pilot adhering to the altitudes, flight paths, and weather minimums depicted on the IAP chart or vectors and altitudes issued by the radar controller, is assured of terrain and obstruction clearance and runway or airport alignment during approach for landing.

**12.1.6** IAPs are designed to provide an IFR descent from the en route environment to a point where a safe landing can be made. They are prescribed and approved by appropriate civil or military authority to ensure a safe descent during instrument flight conditions at a specific airport. It is important that pilots understand these procedures and their use prior to attempting to fly instrument approaches.

**12.1.7** TERPS criteria are provided for the following types of instrument approach procedures:

**12.1.7.1** Precision Approach (PA). An instrument approach based on a navigation system that provides course and glidepath deviation information meeting the precision standards of ICAO Annex 10. For example, PAR, ILS, and GLS are precision approaches.

**12.1.7.2** Approach with Vertical Guidance (APV). An instrument approach based on a navigation system that is not required to meet the precision approach standards of ICAO Annex 10 but provides course and glidepath deviation information. For example, Baro-VNAV, LDA with glidepath, LNAV/VNAV and LPV are APV approaches.

**12.1.7.3** Nonprecision Approach (NPA). An instrument approach based on a navigation system which provides course deviation information, but no glidepath deviation information. For example, VOR, NDB and LNAV. As noted in subparagraph 12.10, Vertical Descent Angle (VDA) on Nonprecision Approaches, some approach procedures may provide a Vertical Descent Angle as an aid in flying a stabilized approach, without requiring its use in order to fly the procedure. This does not make the approach an APV procedure, since it must still be flown to an MDA and has not been evaluated with a glidepath.

**12.2** The method used to depict prescribed altitudes on instrument approach charts differs according to techniques employed by different chart publishers. Prescribed altitudes may be depicted in four different configurations: minimum, maximum, mandatory, and recommended. The U.S. Government distributes charts

produced by National Geospatial–Intelligence Agency (NGA) and FAA. Altitudes are depicted on these charts in the profile view with underscore, overscore, both or none to identify them as minimum, maximum, mandatory or recommended.

**12.2.1** Minimum altitude will be depicted with the altitude value underscored. Aircraft are required to maintain altitude at or above the depicted value, for example, 3000.

**12.2.2** Maximum altitude will be depicted with the altitude value overscored. Aircraft are required to maintain altitude at or below the depicted value, for example, 4000.

**12.2.3** Mandatory altitude will be depicted with the altitude value both underscored and overscored. Aircraft are required to maintain altitude at the depicted value, for example, 5000.

**12.2.4** Recommended altitude will be depicted with no overscore or underscore. These altitudes are depicted for descent planning, for example, 6000.

**NOTE–**

**1.** *Pilots are cautioned to adhere to altitudes as prescribed because, in certain instances, they may be used as the basis for vertical separation of aircraft by ATC. When a depicted altitude is specified in the ATC clearance, that altitude becomes mandatory as defined above.*

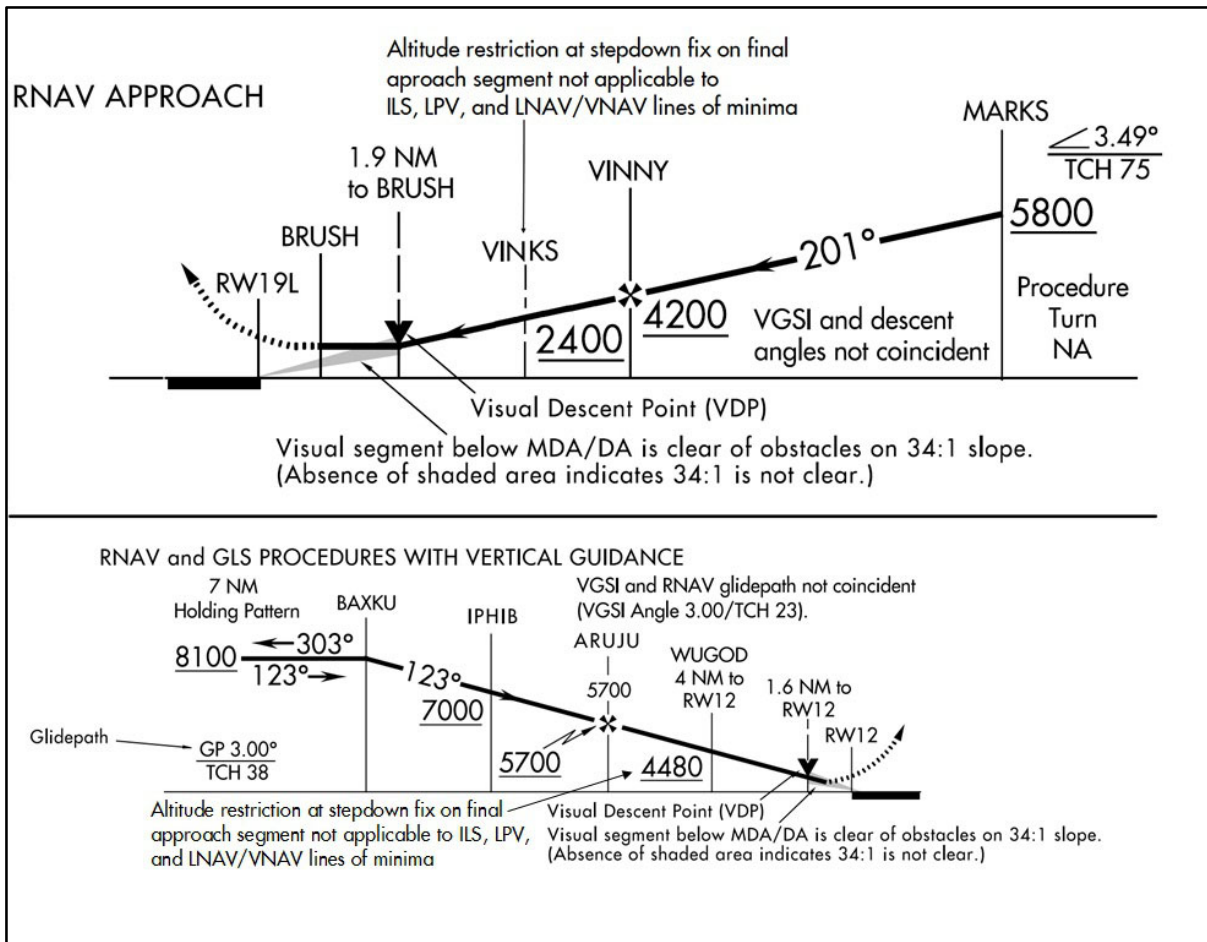
**2.** *The ILS glide slope is intended to be intercepted at the published glide slope intercept altitude. This point marks the PFAF and is depicted by the “lightning bolt” symbol on U.S. Government charts. Intercepting the glide slope at this altitude marks the beginning of the final approach segment and ensures required obstacle clearance during descent from the glide slope intercept altitude to the lowest published decision altitude for the approach. Interception and tracking of the glide slope prior to the published glide slope interception altitude does not necessarily ensure that minimum, maximum, and/or mandatory altitudes published for any preceding fixes will be complied with during the descent. If the pilot chooses to track the glide slope prior to the glide slope interception altitude, they remain responsible for complying with published altitudes for any preceding stepdown fixes encountered during the subsequent descent.*

**3.** *Approaches used for simultaneous (parallel) independent and simultaneous close parallel operations procedurally require descending on the glideslope from the altitude at which the approach clearance is issued (refer to ENR 1.5–19. and ENR 1.5–20.). For simultaneous close parallel (PRM) approaches, the Attention All Users Page (AAUP) may publish a note which indicates that descending on the glideslope/glidepath meets all crossing restrictions. However, if no such note is published, and for simultaneous independent approaches (4300 and greater runway separation) where an AAUP is not published, pilots are cautioned to monitor their descent on the glideslope/path outside of the PFAF to ensure compliance with published crossing restrictions during simultaneous operations.*

**4.** *When parallel approach courses are less than 2500 feet apart and reduced in-trail spacing is authorized for simultaneous dependent operations, a chart note will indicate that simultaneous operations require use of vertical guidance and that the pilot should maintain last assigned altitude until established on glide slope. These approaches procedurally require utilization of the ILS glide slope for wake turbulence mitigation. Pilots should not confuse these simultaneous dependent operations with (SOIA) simultaneous close parallel PRM approaches, where PRM appears in the approach title.*

**12.2.5** Altitude restrictions depicted at stepdown fixes within the final approach segment are applicable only when flying a Non–Precision Approach to a straight–in or circling line of minima identified as an MDA. These altitude restrictions may be annotated with a note “LOC only” or “LNAV only.” Stepdown fix altitude restrictions within the final approach segment do not apply to pilots using Precision Approach (ILS) or Approach with Vertical Guidance (LPV, LNAV/VNAV) lines of minima identified as a DA, since obstacle clearance on these approaches is based on the aircraft following the applicable vertical guidance. Pilots are responsible for adherence to stepdown fix altitude restrictions when outside the final approach segment (i.e., initial or intermediate segment), regardless of which type of procedure the pilot is flying. (See FIG ENR 1.5–17).

FIG ENR 1.5-17  
Instrument Approach Procedure Stepdown Fixes



**12.3 The Minimum Safe Altitudes (MSA)** is published for emergency use on IAP or departure procedure (DP) graphic charts. MSAs provide 1,000 feet of clearance over all obstacles, but do not necessarily assure acceptable navigation signal coverage. The MSA depiction on the plan view of an approach chart or on a DP graphic chart contains the identifier of the center point of the MSA, the applicable radius of the MSA, a depiction of the sector(s), and the minimum altitudes above mean sea level which provide obstacle clearance. For conventional navigation systems, the MSA is normally based on the primary omnidirectional facility on which the IAP or DP graphic chart is predicated, but may be based on the airport reference point (ARP) if no suitable facility is available. For RNAV approaches or DP graphic charts, the MSA is based on an RNAV waypoint. MSAs normally have a 25 NM radius; however, for conventional navigation systems, this radius may be expanded to 30 NM if necessary to encompass the airport landing surfaces. A single sector altitude is normally established, however when the MSA is based on a facility and it is necessary to obtain relief/DA from obstacles, an MSA with up to four sectors may be established.

**12.4 Terminal Arrival Area (TAA)**

**12.4.1** The TAA provides a transition from the en route structure to the terminal environment with little required pilot/air traffic control interface for aircraft equipped with Area Navigation (RNAV) systems. A TAA provides minimum altitudes with standard obstacle clearance when operating within the TAA boundaries. TAAs are primarily used on RNAV approaches but may be used on an ILS approach when RNAV is the sole means for navigation to the IF; however, they are not normally used in areas of heavy concentration of air traffic.

**12.4.2** The basic design of the RNAV procedure underlying the TAA is normally the “T” design (also called the “Basic T”). The “T” design incorporates two IAFs plus a dual purpose IF/IAF that functions as both an intermediate fix and an initial approach fix. The T configuration continues from the IF/IAF to the final approach fix (FAF) and then to the missed approach point (MAP). The two base leg IAFs are typically aligned in a straight-line perpendicular to the intermediate course connecting at the IF/IAF. A Hold-in-Lieu-of Procedure Turn (HILPT) is anchored at the IF/IAF and depicted on U.S. Government publications using the “hold-in-lieu-of-PT” holding pattern symbol. When the HILPT is necessary for course alignment and/or descent, the dual purpose IF/IAF serves as an IAF during the entry into the pattern. Following entry into the HILPT pattern and when flying a route or sector labeled “NoPT,” the dual-purpose fix serves as an IF, marking the beginning of the Intermediate Segment. See FIG ENR 1.5–18 and FIG ENR 1.5–19 for the Basic “T” TAA configuration.

**FIG ENR 1.5–18**  
**Basic “T” Design**

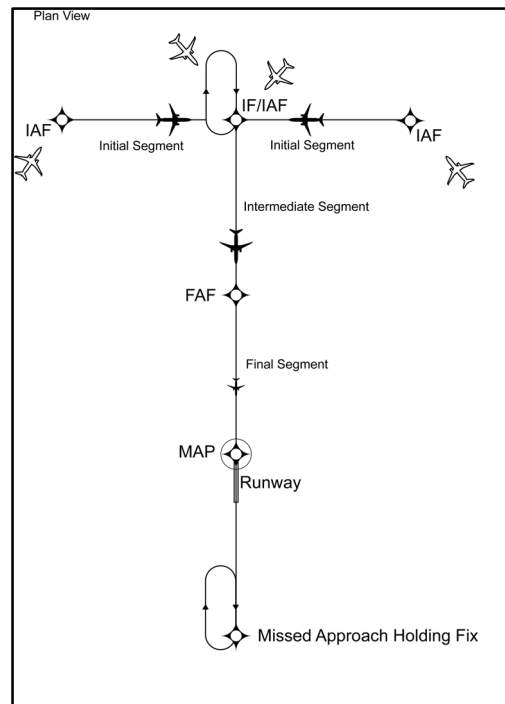
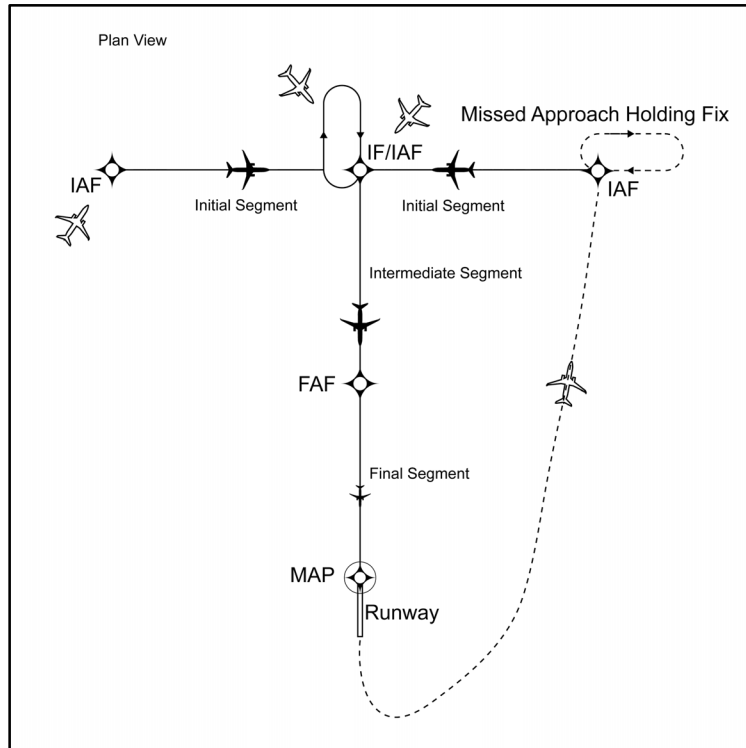
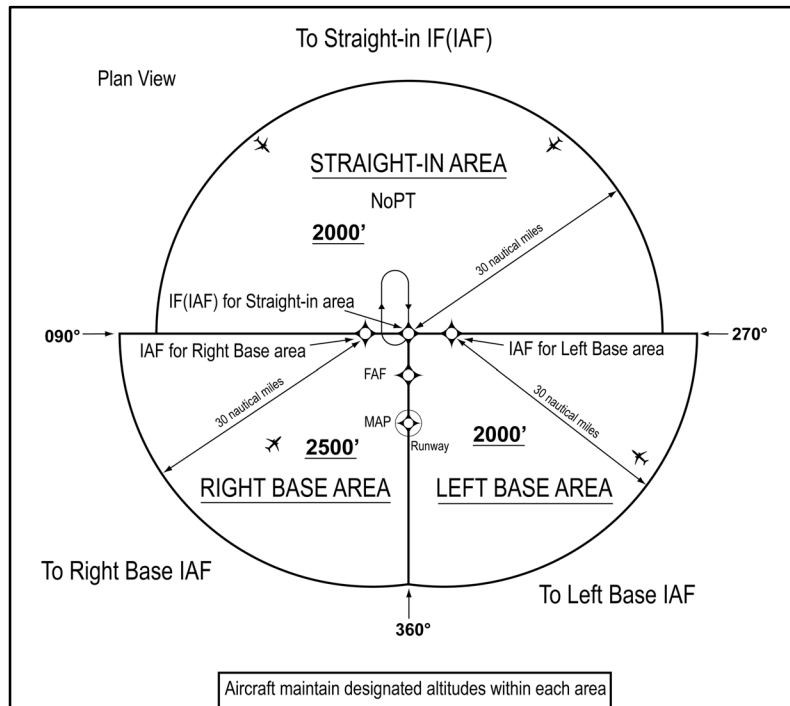


FIG ENR 1.5-19  
Basic "T" Design



**12.4.3** The standard TAA based on the "T" design consists of three areas defined by the Initial Approach Fix (IAF) legs and the intermediate segment course beginning at the IF/IAF. These areas are called the straight-in, left-base, and right-base areas. (See FIG ENR 1.5-20). TAA area lateral boundaries are identified by magnetic courses TO the IF/IAF. The straight-in area can be further divided into pie-shaped sectors with the boundaries identified by magnetic courses TO the (IF/ IAF), and may contain stepdown sections defined by arcs based on RNAV distances from the IF/IAF. (See FIG ENR 1.5-21). The right/left-base areas can only be subdivided using arcs based on RNAV distances from the IAFs for those areas.

FIG ENR 1.5–20  
TAA Area



**12.4.4** Entry from the terminal area onto the procedure is normally accomplished via a no procedure turn (NoPT) routing or via a course reversal maneuver. The published procedure will be annotated “NoPT” to indicate when the course reversal is not authorized when flying within a particular TAA sector. Otherwise, the pilot is expected to execute the course reversal under the provisions of 14 CFR Section 91.175. The pilot may elect to use the course reversal pattern when it is not required by the procedure, but must receive clearance from air traffic control before beginning the procedure.

**12.4.4.1** ATC should not clear an aircraft to the left base leg or right base leg IAF within a TAA at an intercept angle exceeding 90 degrees. Pilots must not execute the HILPT course reversal when the sector or procedure segment is labeled “NoPT.”

**12.4.4.2** ATC may clear aircraft direct to the fix labeled IF/IAF if the course to the IF/IAF is within the straight-in sector labeled “NoPT” and the intercept angle does not exceed 90 degrees. Pilots are expected to proceed direct to the IF/IAF and accomplish a straight-in approach. Do not execute HILPT course reversal. Pilots are also expected to fly the straight-in approach when ATC provides radar vectors and monitoring to the IF/IAF and issues a “straight-in” approach clearance; otherwise, the pilot *is expected* to execute the HILPT course reversal.

**12.4.4.3** On rare occasions, ATC may clear the aircraft for an approach at the airport without specifying the approach procedure by name or by a specific approach (for example, “cleared RNAV Runway 34 approach”) without specifying a particular IAF. In either case, the pilot should proceed direct to the IAF or to the IF/IAF associated with the sector that the aircraft will enter the TAA and join the approach course from that point and if required by that sector (i.e., sector is not labeled “NoPT”), complete the HILPT course reversal.

**NOTE–**

*If approaching with a TO bearing that is on a sector boundary, the pilot is expected to proceed in accordance with a “NoPT” routing unless otherwise instructed by ATC.*

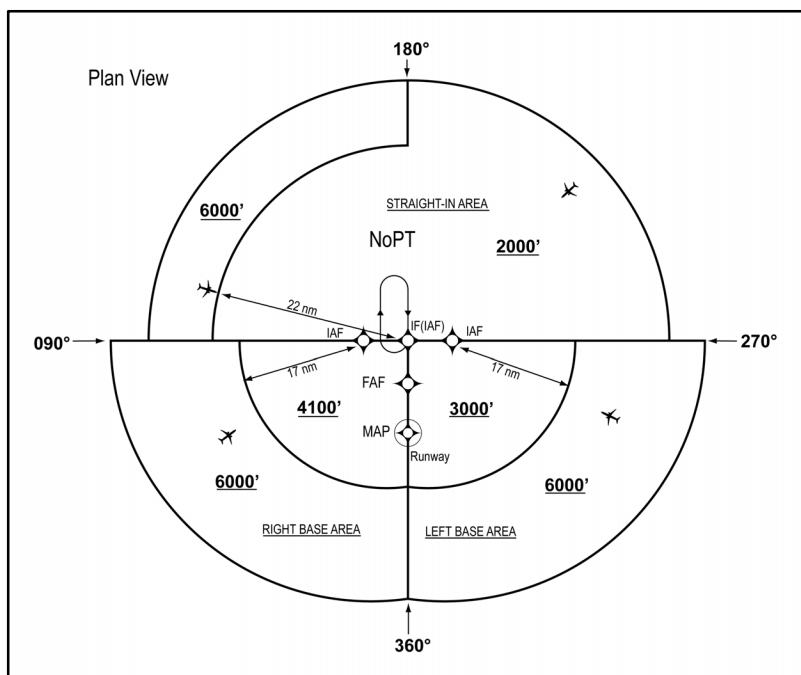
**12.4.5** Altitudes published within the TAA replace the MSA altitude. However, unlike MSA altitudes the TAA altitudes are operationally usable altitudes. These altitudes provide at least 1,000 feet of obstacle clearance, more in mountainous areas. It is important that the pilot knows which area of the TAA the aircraft will enter in order to comply with the minimum altitude requirements. The pilot can determine which area of the TAA the aircraft

will enter by determining the magnetic bearing of the aircraft TO the fix labeled IF/IAF. The bearing should then be compared to the published lateral boundary bearings that define the TAA areas. Do not use magnetic bearing to the right-base or left-base IAFs to determine position.

**12.4.5.1** An ATC clearance direct to an IAF or to the IF/IAF without an approach clearance does not authorize a pilot to descend to a lower TAA altitude. If a pilot desires a lower altitude without an approach clearance, request the lower TAA altitude from ATC. Pilots not sure of the clearance should confirm their clearance with ATC or request a specific clearance. Pilots entering the TAA with two-way radio communications failure (14 CFR Section 91.185, IFR Operations: Two-way Radio Communications Failure), must maintain the highest altitude prescribed by Section 91.185(c)(2) until arriving at the appropriate IAF.

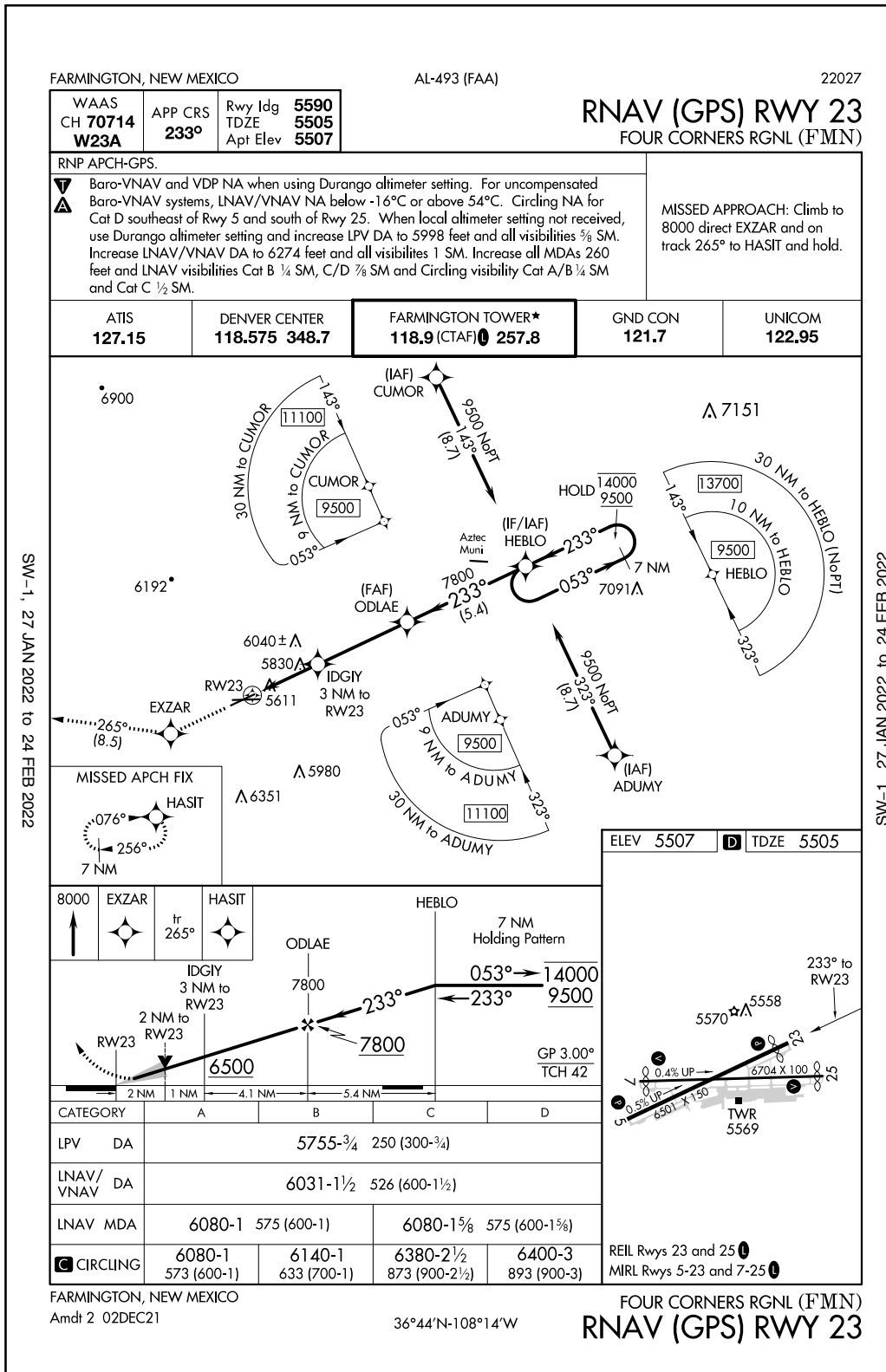
**12.4.5.2** Once cleared for the approach, pilots may descend in the TAA sector to the minimum altitude depicted within the defined area/subdivision, unless instructed otherwise by air traffic control. Pilots should plan their descent within the TAA to permit a normal descent from the IF/IAF to the FAF. In FIG ENR 1.5–21, pilots within the left or right-base areas are expected to maintain a minimum altitude of 6,000 feet until within 17 NM of the associated IAF. After crossing the 17 NM arc, descent is authorized to the lower charted altitudes. Pilots approaching from the northwest are expected to maintain a minimum altitude of 6,000 feet, and when within 22 NM of the IF/IAF, descend to a minimum altitude of 2,000 feet MSL until crossing the IF/IAF.

FIG ENR 1.5–21  
Sectored TAA Areas



**12.4.6** U.S. Government charts depict TAAs using icons located in the plan view outside the depiction of the actual approach procedure. (See FIG ENR 1.5–22). Use of icons is necessary to avoid obscuring any portion of the “T” procedure (altitudes, courses, minimum altitudes, etc.). The icon for each TAA area will be located and oriented on the plan view with respect to the direction of arrival to the approach procedure, and will show all TAA minimum altitudes and sector/radius subdivisions. The IAF for each area of the TAA is included on the icon where it appears on the approach to help the pilot orient the icon to the approach procedure. The IAF name and the distance of the TAA area boundary from the IAF are included on the outside arc of the TAA area icon.

FIG ENR 1.5-22  
RNAV (GPS) Approach Chart

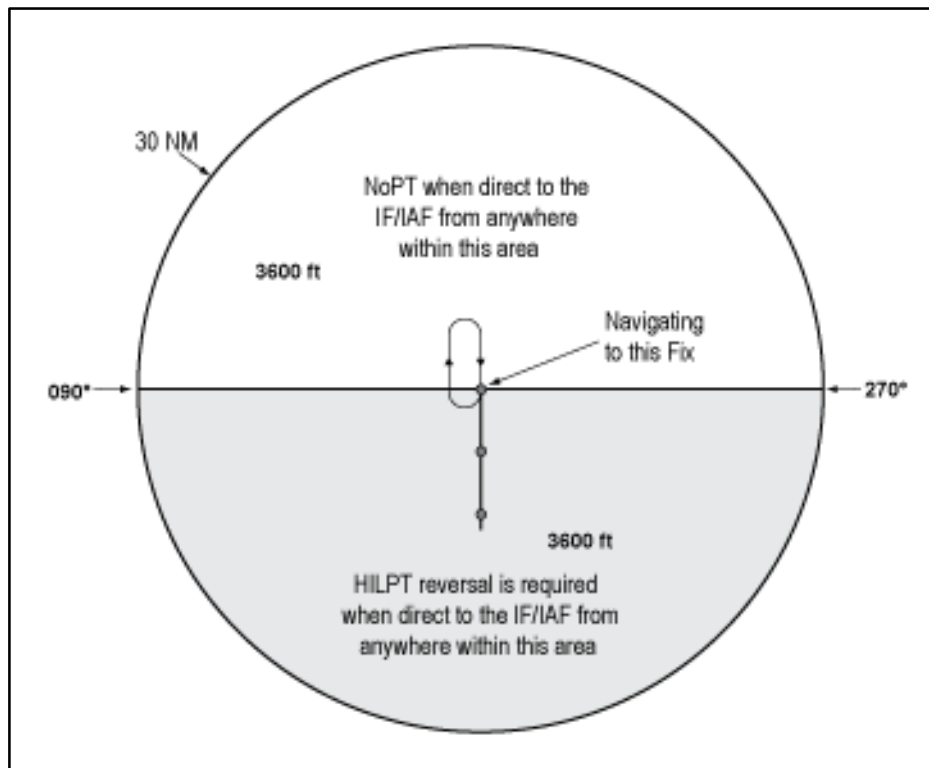




**12.4.7** TAAs may be modified from the standard size and shape to accommodate operational or ATC requirements. Some areas may be eliminated, while the other areas are expanded. The “T” design may be modified by the procedure designers where required by terrain or ATC considerations. For instance, the “T” design may appear more like a regularly or irregularly shaped “Y,” upside down “L,” or an “I.”

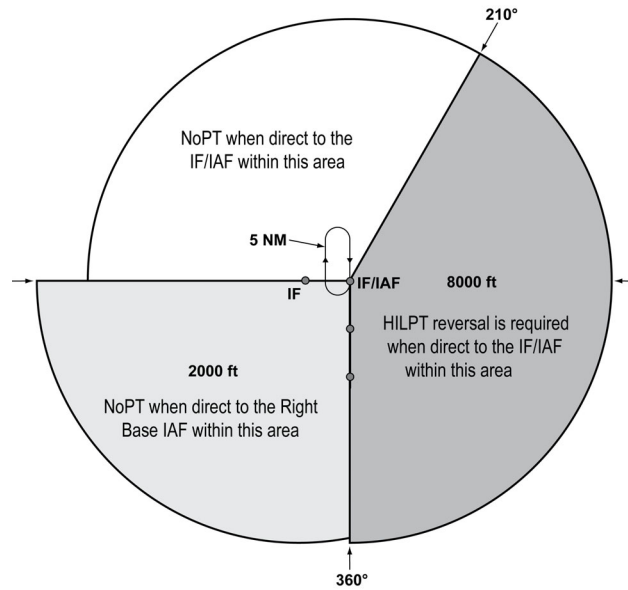
**12.4.7.1** FIG ENR 1.5–23 depicts a TAA without a left base leg and right base leg. In this generalized example, pilots approaching on a bearing TO the IF/IAF from 271 clockwise to 089 are expected to execute a course reversal because the amount of turn required at the IF/IAF exceeds 90 degrees. The term “NoPT” will be annotated on the boundary of the TAA icon for the other portion of the TAA.

FIG ENR 1.5–23  
TAA with Left and Right Base Areas Eliminated



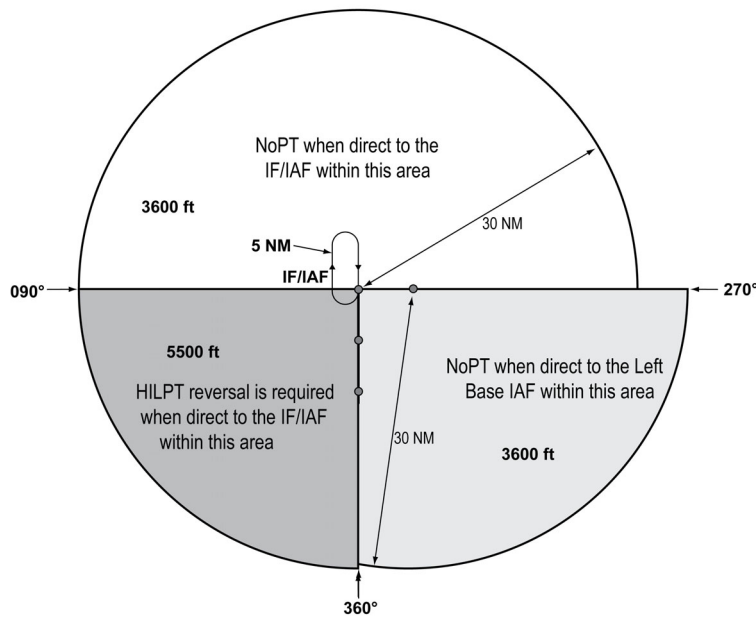
**12.4.7.2** FIG ENR 1.5–24 depicts another TAA modification that pilots may encounter. In this generalized example, the left base area and part of the straight-in area have been eliminated. Pilots operating within the TAA between 210 clockwise to 360 bearing TO the IF/IAF are expected to proceed direct to the IF/IAF and then execute the course reversal in order to properly align the aircraft for entry onto the intermediate segment or to avoid an excessive descent rate. Aircraft operating in areas from 001 clockwise to 090 bearing TO the IF/IAF are expected to proceed direct to the right base IAF and not execute course reversal maneuver. Aircraft cleared direct the IF/IAF by ATC in this sector will be expected to accomplish HILTP. Aircraft operating in areas 091 clockwise to 209 bearing TO the IF/IAF are expected to proceed direct to the IF/IAF and not execute the course reversal. These two areas are annotated “NoPT” at the TAA boundary of the icon in these areas when displayed on the approach chart’s plan view.

**FIG ENR 1.5-24**  
**TAA with Left Base and Part of Straight-In Area Eliminated**

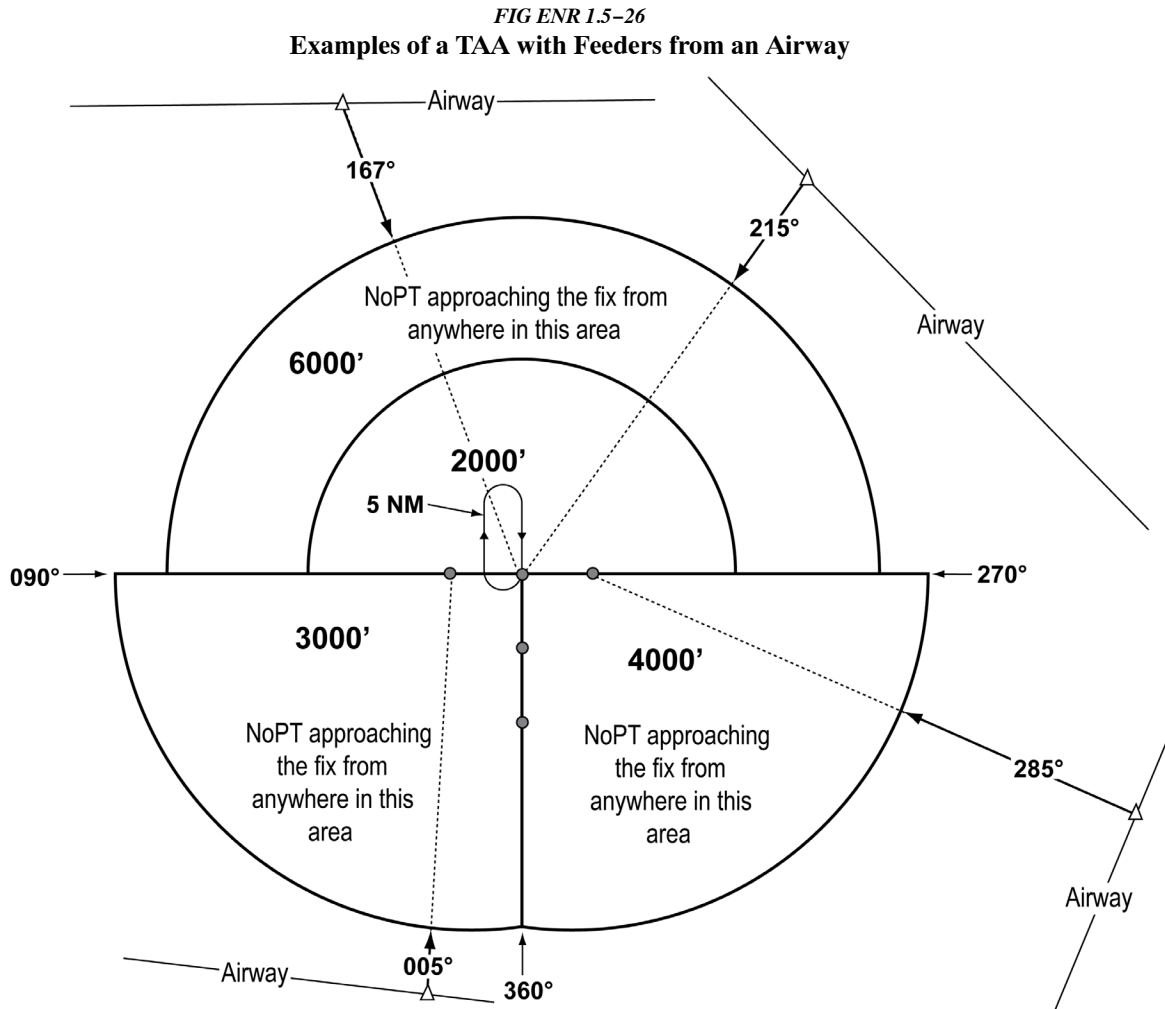


12.4.7.3 FIG ENR 1.5-25 depicts a TAA with right base leg and part of the straight-in area eliminated.

**FIG ENR 1.5-25**  
**TAA with Right Base Eliminated**

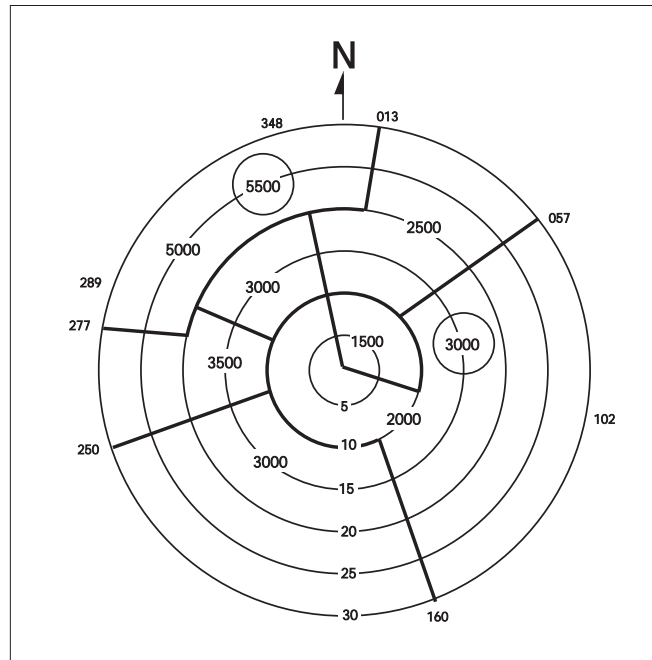


**12.4.8** When an airway does not cross the lateral TAA boundaries, a feeder route will be established from an airway fix or NAVAID to the TAA boundary to provide a transition from the en route structure to the appropriate IAF. Each feeder route will terminate at the TAA boundary and will be aligned along a path pointing to the associated IAF. Pilots should descend to the TAA altitude after crossing the TAA boundary and cleared for the approach by ATC. (See FIG ENR 1.5-26.)



**12.4.9** Each waypoint on the "T" is assigned a pronounceable 5-letter name, except the missed approach waypoint. These names are used for ATC communications, RNAV databases, and aeronautical navigation products. The missed approach waypoint is assigned a pronounceable name when it is not located at the runway threshold.

FIG ENR 1.5-27  
Minimum Vectoring Altitude Charts



**12.5 Minimum Vectoring Altitudes (MVAs)** are established for use by ATC when radar ATC is exercised. MVA charts are prepared by air traffic facilities at locations where there are numerous different minimum IFR altitudes. Each MVA chart has sectors large enough to accommodate vectoring of aircraft within the sector at the MVA. Each sector boundary is at least 3 miles from the obstruction determining the MVA. To avoid a large sector with an excessively high MVA due to an isolated prominent obstruction, the obstruction may be enclosed in a buffer area whose boundaries are at least 3 miles from the obstruction. This is done to facilitate vectoring around the obstruction. (See FIG ENR 1.5-27.)

**12.5.1** The minimum vectoring altitude in each sector provides 1,000 feet above the highest obstacle in nonmountainous areas and 2,000 feet above the highest obstacle in designated mountainous areas. Where lower MVAs are required in designated mountainous areas to achieve compatibility with terminal routes or to permit vectoring to an IAP, 1,000 feet of obstacle clearance may be authorized with the use of ATC Surveillance. The minimum vectoring altitude will provide at least 300 feet above the floor of controlled airspace.

**NOTE-**

*OROCA is a published altitude which provides 1,000 feet of terrain and obstruction clearance in the US (2,000 feet of clearance in designated mountainous areas). These altitudes are not assessed for NAVAID signal coverage, air traffic control surveillance, or communications coverage, and are published for general situational awareness, flight planning and in-flight contingency use.*

**12.5.2** Because of differences in the areas considered for MVA, and those applied to other minimum altitudes, and the ability to isolate specific obstacles, some MVAs may be lower than the nonradar Minimum En Route Altitudes (MEAs), Minimum Obstruction Clearance Altitudes (MOCAs) or other minimum altitudes depicted on charts for a given location. While being radar vectored, IFR altitude assignments by ATC will be at or above MVA.

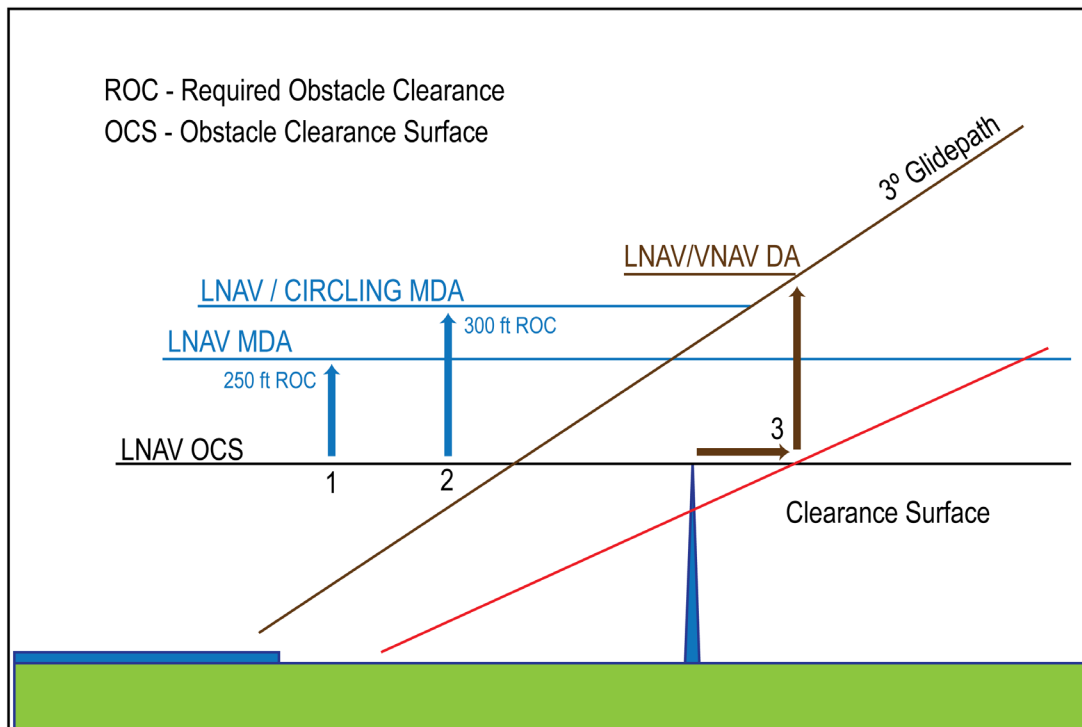
**12.5.3** The MVA/MIA may be lower than the TAA minimum altitude. If ATC has assigned an altitude to an aircraft that is below the TAA minimum altitude, the aircraft will either be assigned an altitude to maintain until established on a segment of a published route or instrument approach procedure, or climbed to the TAA altitude.

**12.6 Circling.** Circling minimums charted on an RNAV (GPS) approach chart may be lower than the LNAV/VNAV line of minima, but never lower than the LNAV line of minima (straight-in approach). Pilots may safely perform the circling maneuver at the circling published line of minima if the approach and circling maneuver is properly performed according to aircraft category and operational limitations.

FIG ENR 1.5-28  
Example of LNAV and Circling Minima Lower Than LNAV/VNAV DA.  
Harrisburg International RNAV (GPS) RWY 13

CATEGORY	A	B	C	D
LPV DA	558/24 250 (300 - 1/2)			
LNAV/VNAV DA	1572 - 5 1264 (1300 - 5)			
LNAV MDA	1180 / 24 872 (900 - 1/2)	1180 / 40 872 (900 - 3/4)	1180 / 2 872 (900 - 2)	1180 / 2 1/4 872 (900 - 2 1/4)
CIRCLING	1180 - 1 870 (900 - 1)	1180 - 1 1/4 870 (900 - 1 1/4)	1180 - 2 1/2 870 (900 - 2 1/2)	1180 - 2 3/4 870 (900 - 2 3/4)

FIG ENR 1.5-29  
Explanation of LNAV and/or Circling Minima Lower than LNAV/VNAV DA



**12.7** FIG ENR 1.5-29 provides a visual representation of an obstacle evaluation and calculation of LNAV MDA, Circling MDA, LNAV/VNAV DA.

**12.7.1 No vertical guidance (LNAV).** A line is drawn horizontal at obstacle height and 250 feet added for Required Obstacle Clearance (ROC). The controlling obstacle used to determine LNAV MDA can be different than the controlling obstacle used in determining ROC for circling MDA. Other factors may force a number larger than 250 ft to be added to the LNAV OCS. The number is rounded up to the next higher 20 foot increment.

**12.7.2 Circling MDA.** The circling MDA will provide 300 foot obstacle clearance within the area considered for obstacle clearance and may be lower than the LNAV/VNAV DA, but never lower than the straight in LNAV MDA. This may occur when different controlling obstacles are used or when other controlling factors force the LNAV MDA to be higher than 250 feet above the LNAV OCS. In FIG ENR 1.5–28, the required obstacle clearance for both the LNAV and Circle resulted in the same MDA, but lower than the LNAV/VNAV DA. FIG ENR 1.5–29 provides an illustration of this type of situation.

**12.7.3 Vertical guidance (LNAV/VNAV).** A line is drawn horizontal at obstacle height until reaching the obstacle clearance surface (OCS). At the OCS, a vertical line is drawn until reaching the glide path. This is the DA for the approach. This method places the offending obstacle in front of the LNAV/VNAV DA so it can be seen and avoided. In some situations, this may result in the LNAV/VNAV DA being higher than the LNAV and/or Circling MDA.

**12.8 The Visual Descent Point (VDP)** identified by the symbol (V), is a defined point on the final approach course of a nonprecision straight-in approach procedure from which a stabilized visual descent from the MDA to the runway touchdown point may be commenced. The pilot should not descend below the MDA prior to reaching the VDP. The VDP will be identified by DME or RNAV along-track distance to the MAP. The VDP distance is based on the lowest MDA published on the IAP and harmonized with the angle of the visual glide slope indicator (VGSI) (if installed) or the procedure VDA (if no VGSI is installed). A VDP may not be published under certain circumstances which may result in a destabilized descent between the MDA and the runway touchdown point. Such circumstances include an obstacle penetrating the visual surface between the MDA and runway threshold, lack of distance measuring capability, or the procedure design prevents a VDP to be identified.

**12.8.1** VGSI systems may be used as a visual aid to the pilot to determine if the aircraft is in a position to make a stabilized descent from the MDA. When the visibility is close to minimums, the VGSI may not be visible at the VDP due to its location beyond the MAP.

**12.8.2** Pilots not equipped to receive the VDP should fly the approach procedure as though no VDP had been provided.

**12.8.3** On a straight-in nonprecision IAP, descent below the MDA between the VDP and the MAP may be inadvisable or impossible. Aircraft speed, height above the runway, descent rate, amount of turn, and runway length are some of the factors which must be considered by the pilot to determine if a safe descent and landing can be accomplished.

**12.9** A visual segment obstruction evaluation is accomplished during procedure design on all IAPs. Obstacles (both lighted and unlighted) are allowed to penetrate the visual segment obstacle identification surfaces. Identified obstacle penetrations may cause restrictions to instrument approach operations which may include an increased approach visibility requirement, not publishing a VDP, and/or prohibiting night instrument operations to the runway. There is no implicit obstacle protection from the MDA/DA to the touchdown point. Accordingly, it is the responsibility of the pilot to visually acquire and avoid obstacles below the MDA/DA during transition to landing.

**12.9.1** Unlighted obstacle penetrations may result in prohibiting night instrument operations to the runway. A chart note will be published in the pilot briefing strip “Procedure NA at Night.”

**12.9.2** Use of a VGSI may be approved in lieu of obstruction lighting to restore night instrument operations to the runway. A chart note will be published in the pilot briefing strip “Straight-in Rwy XX at Night, operational VGSI required, remain on or above VGSI glidepath until threshold.”

**12.10** The highest obstacle (man-made, terrain, or vegetation) will be charted on the planview of an IAP. Other obstacles may be charted in either the planview or the airport sketch based on distance from the runway and available chart space. The elevation of the charted obstacle will be shown to the nearest foot above mean sea level. Obstacles without a verified accuracy are indicated by a  $\pm$  symbol following the elevation value.

**12.11 Vertical Descent Angle (VDA).** FAA policy is to publish a VDA/TCH on all nonprecision approaches except those published in conjunction with vertically guided minimums (i.e., ILS or LOC RWY XX) or no-FAF

procedures without a step-down fix (i.e., on-airport VOR or NDB). A VDA does not guarantee obstacle protection below the MDA in the visual segment. The presence of a VDA does not change any nonprecision approach requirements.

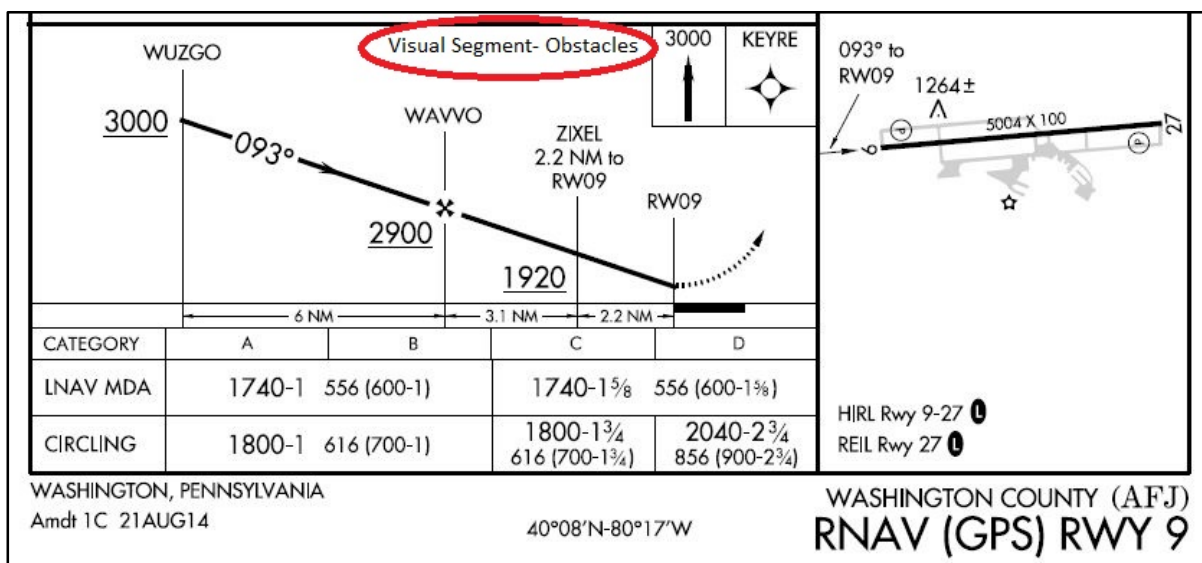
**12.11.1** Obstacles may penetrate the obstacle identification surface below the MDA in the visual segment of an IAP that has a published VDA/TCH. When the VDA/TCH is not authorized due to an obstacle penetration that would require a pilot to deviate from the VDA between MDA and touchdown, the VDA/TCH will be replaced with the note “Visual Segment- Obstacles” in the profile view of the IAP (See FIG ENR 1.5-30). Accordingly, pilots are advised to carefully review approach procedures to identify where the optimum stabilized descent to landing can be initiated. Pilots that follow the previously published descent angle, provided by the RNAV system, below the MDA on procedures with this note may encounter obstacles in the visual segment. Pilots must visually avoid any obstacles below the MDA.

**12.11.1.1** VDA/TCH data is furnished by FAA on the official source document for publication on IAP charts and for coding in the navigation database unless, as noted previously, replaced by the note “Visual Segment – Obstacles.”

**12.11.1.2** Commercial chart providers and navigation systems may publish or calculate a VDA/TCH even when the FAA does not provide such data. Pilots are cautioned that they are responsible for obstacle avoidance in the visual segment regardless of the presence or absence of a VDA/TCH and associated navigation system advisory vertical guidance.

**12.11.2** The threshold crossing height (TCH) used to compute the descent angle is published with the VDA. The VDA and TCH information are charted on the profile view of the IAP following the fix (FAF/stepdown) used to compute the VDA. If no PA/APV IAP is established to the same runway, the VDA will be equal to or higher than the glide path angle of the VGSI installed on the same runway provided it is within instrument procedure criteria. A chart note will indicate if the VGSI is not coincident with the VDA. Pilots must be aware that the published VDA is for advisory information only and not to be considered instrument procedure derived vertical guidance. The VDA solely offers an aid to help pilots establish a continuous, stabilized descent during final approach.

FIG ENR 1.5-30  
Example of a Chart Note



**12.11.3** Pilots may use the published angle and estimated/actual groundspeed to find a target rate of descent from the rate of descent table published in the back of the U.S. Terminal Procedures Publication. This rate of descent can be flown with the Vertical Velocity Indicator (VVI) in order to use the VDA as an aid to flying a stabilized descent. No special equipment is required.

**12.11.4** A straight-in aligned procedure may be restricted to circling only minimums when an excessive descent gradient necessitates. The descent angle between the FAF/stepdown fix and the Circling MDA must not exceed the maximum descent angle allowed by TERPS criteria. A published VDA on these procedures does not imply that landing straight ahead is recommended or even possible. The descent rate based on the VDA may exceed the capabilities of the aircraft and the pilot must determine how to best maneuver the aircraft within the circling area in order to land safely.

**12.12** In isolated cases, an IAP may contain a published visual flight path. These procedures are annotated “Fly Visual to Airport” or “Fly Visual.” A dashed arrow indicating the visual flight path will be included in the profile and plan views with an approximate heading and distance to the end of the runway.

**12.12.1** The depicted ground track associated with the “Fly Visual to Airport” segment should be flown as a “Dead Reckoning” course. When executing the “Fly Visual to Airport” segment, the flight visibility must not be less than that prescribed in the IAP; the pilot must remain clear of clouds and proceed to the airport maintaining visual contact with the ground. Altitude on the visual flight path is at the discretion of the pilot, and it is the responsibility of the pilot to visually acquire and avoid obstacles in the “Fly Visual to Airport” segment.

**12.12.2** Missed approach obstacle clearance is assured only if the missed approach is commenced at the published MAP. Before initiating an IAP that contains a “Fly Visual to Airport” segment, the pilot should have preplanned climb out options based on aircraft performance and terrain features. Obstacle clearance is the responsibility of the pilot when the approach is continued beyond the MAP.

**NOTE–**

*The FAA Administrator retains the authority to approve instrument approach procedures where the pilot may not necessarily have one of the visual references specified in 14 CFR § 91.175 and related rules. It is not a function of procedure design to ensure compliance with § 91.175. The annotation “Fly Visual to Airport” provides relief from § 91.175 requirements that the pilot have distinctly visible and identifiable visual references prior to descent below MDA/DA.*

**12.13 Area Navigation (RNAV) Instrument Approach Charts.** Reliance on RNAV systems for instrument operations is becoming more commonplace as new systems such as GPS and augmented GPS such as the Wide Area Augmentation System (WAAS) are developed and deployed. In order to support full integration of RNAV procedures into the National Airspace System (NAS), the FAA developed a new charting format for IAPs (See FIG ENR 1.5–22). This format avoids unnecessary duplication and proliferation of instrument approach charts. The original stand alone GPS charts, titled simply “GPS,” are being converted to the newer format as the procedures are revised. One reason for the revision is the addition of WAAS based minima to the approach chart. The reformatted approach chart is titled “RNAV (GPS) RWY XX.” Up to four lines of minima are included on these charts. GLS (Ground Based Augmentation System (GBAS) Landing System) was a placeholder for future WAAS and LAAS minima, and the minima was always listed as N/A. The GLS minima line has now been replaced by the WAAS LPV (Localizer Performance with Vertical Guidance) minima on most RNAV (GPS) charts. LNAV/VNAV (lateral navigation/vertical navigation) was added to support both WAAS electronic vertical guidance and Barometric VNAV. LPV and LNAV/VNAV are both APV procedures as described in paragraph 12.1.7. The original GPS minima, titled “S–XX,” for straight in runway XX, is retitled LNAV (lateral navigation). Circling minima may also be published. A new type of nonprecision WAAS minima will also be published on this chart and titled LP (localizer performance). LP will be published in locations where vertically guided minima cannot be provided due to terrain and obstacles and therefore, no LPV or LNAV/VNAV minima will be published. GBAS procedures are published on a separate chart and the GLS minima line is to be used only for GBAS. ATC clearance for the RNAV procedure authorizes a properly certified pilot to utilize any minimums for which the aircraft is certified (for example, a WAAS equipped aircraft utilizes the LPV or LP minima but a GPS only aircraft may not). The RNAV chart includes information formatted for quick reference by the pilot or flight crew at the top of the chart. This portion of the chart, developed based on a study by the Department of Transportation, Volpe National Transportation System Center, is commonly referred to as the pilot briefing.

**12.13.1** The minima lines are:



**12.13.1.1 GLS.** “GLS” is the acronym for GBAS Landing System. The U.S. version of GBAS has traditionally been referred to as LAAS. The worldwide community has adopted GBAS as the official term for this type of navigation system. To coincide with international terminology, the FAA is also adopting the term GBAS to be consistent with the international community. This line was originally published as a placeholder for both WAAS and LAAS minima and marked as N/A since no minima was published. As the concepts for GBAS and WAAS procedure publication have evolved, GLS will now be used only for GBAS minima, which will be on a separate approach chart. Most RNAV(GPS) approach charts have had the GLS minima line replaced by a WAAS LPV line of minima.

**12.13.1.2 LPV.** “LPV” is the acronym for localizer performance with vertical guidance. RNAV (GPS) approaches to LPV lines of minima take advantage of the improved accuracy of WAAS lateral and vertical guidance to provide an approach that is very similar to a Category I Instrument Landing System (ILS). The approach to LPV line of minima is designed for angular guidance with increasing sensitivity as the aircraft gets closer to the runway. The sensitivities are nearly identical to those of the ILS at similar distances. This was done intentionally to allow the skills required to proficiently fly an ILS to readily transfer to flying RNAV (GPS) approaches to the LPV line of minima. Just as with an ILS, the LPV has vertical guidance and is flown to a DA. Aircraft can fly this minima line with a statement in the Aircraft Flight Manual that the installed equipment supports LPV approaches. This includes Class 3 and 4 TSO–C146 GPS/WAAS equipment.

**12.13.1.3 LNAV/VNAV.** LNAV/VNAV identifies APV minimums developed to accommodate an RNAV IAP with vertical guidance, usually provided by approach certified Baro–VNAV, but with lateral and vertical integrity limits larger than a precision approach or LPV. LNAV stands for Lateral Navigation; VNAV stands for Vertical Navigation. This minima line can be flown by aircraft with a statement in the Aircraft Flight Manual that the installed equipment supports GPS approaches and has an approach–approved barometric VNAV, or if the aircraft has been demonstrated to support LNAV/VNAV approaches. This includes Class 2, 3 and 4 TSO–C146 GPS/WAAS equipment. Aircraft using LNAV/VNAV minimums will descend to landing via an internally generated descent path based on satellite or other approach approved VNAV systems. Since electronic vertical guidance is provided, the minima will be published as a DA. Other navigation systems may be specifically authorized to use this line of minima. (See Section A, Terms/Landing Minima Data, of the U.S. Terminal Procedures books.)

**12.13.1.4 LP.** “LP” is the acronym for localizer performance. Approaches to LP lines of minima take advantage of the improved accuracy of WAAS to provide approaches, with lateral guidance and angular guidance. Angular guidance does not refer to a glideslope angle but rather to the increased lateral sensitivity as the aircraft gets closer to the runway, similar to localizer approaches. However, the LP line of minima is a Minimum Descent Altitude (MDA) rather than a DA (H). Procedures with LP lines of minima will not be published with another approach that contains approved vertical guidance (LNAV/VNAV or LPV). It is possible to have LP and LNAV published on the same approach chart but LP will only be published if it provides lower minima than an LNAV line of minima. LP is not a fail–down mode for LPV. LP will only be published if terrain, obstructions, or some other reason prevent publishing a vertically guided procedure. WAAS avionics may provide GNSS–based advisory vertical guidance during an approach to an LP line of minima. Barometric altimeter information remains the primary altitude reference for complying with any altitude restrictions. WAAS equipment may not support LP, even if it supports LPV, if it was approved before TSO–C145b and TSO–C146b. Receivers approved under previous TSOs may require an upgrade by the manufacturer in order to be used to fly to LP minima. Receivers approved for LP must have a statement in the approved Flight Manual or Supplemental Flight Manual including LP as one of the approved approach types.

**12.13.1.5 LNAV.** This minima is for lateral navigation only, and the approach minimum altitude will be published as a minimum descent altitude (MDA). LNAV provides the same level of service as the present GPS stand alone approaches. LNAV minimums support the following navigation systems: WAAS, when the navigation solution will not support vertical navigation; and, GPS navigation systems which are presently authorized to conduct GPS approaches.

**NOTE–**

*GPS receivers approved for approach operations in accordance with: AC 20–138, Airworthiness Approval of Positioning*

and Navigation Systems, qualify for this minima. WAAS navigation equipment must be approved in accordance with the requirements specified in TSO–C145() or TSO–C146() and installed in accordance with Advisory Circular AC 20–138.

**12.13.2** Other systems may be authorized to utilize these approaches. See the description in Section A of the U.S. Terminal Procedures books for details. Operational approval must also be obtained for Baro–VNAV systems to operate to the LNAV/VNAV minimums. Baro–VNAV may not be authorized on some approaches due to other factors, such as no local altimeter source being available. Baro–VNAV is not authorized on LPV procedures. Pilots are directed to their local Flight Standards District Office (FSDO) for additional information.

**NOTE–**

*RNAV and Baro–VNAV systems must have a manufacturer supplied electronic database which must include the waypoints, altitudes, and vertical data for the procedure to be flown. The system must be able to retrieve the procedure by name from the aircraft navigation database, not just as a manually entered series of waypoints.*

**12.13.3 ILS or RNAV (GPS) Charts.**

**12.13.3.1** Some RNAV (GPS) charts will also contain an ILS line of minima to make use of the ILS precision final in conjunction with the RNAV GPS capabilities for the portions of the procedure prior to the final approach segment and for the missed approach. Obstacle clearance for the portions of the procedure other than the final approach segment is still based on GPS criteria.

**NOTE–**

*Some GPS receiver installations inhibit GPS navigation whenever ANY ILS frequency is tuned. Pilots flying aircraft with receivers installed in this manner must wait until they are on the intermediate segment of the procedure prior to the PFAF (PFAF is the active waypoint) to tune the ILS frequency and must tune the ILS back to a VOR frequency in order to fly the GPS based missed approach.*

**12.13.3.2 Charting.** There are charting differences between ILS, RNAV (GPS), and GLS approaches.

- a) The LAAS procedure is titled “GLS RWY XX” on the approach chart.
- b) The VDB provides information to the airborne receiver where the guidance is synthesized.
- c) The LAAS procedure is identified by a four alpha–numeric character field referred to as the RPI or approach ID and is similar to the IDENT feature of the ILS.
- d) The RPI is charted.
- e) Most RNAV(GPS) approach charts have had the GLS (NA) minima line replaced by an LPV line of minima.
- f) Since the concepts for LAAS and WAAS procedure publication have evolved, GLS will now be used only for LAAS minima, which will be on a separate approach chart.

**12.13.4 Required Navigation Performance (RNP)**

**12.13.4.1** Pilots are advised to refer to the “TERMS/LANDING MINIMUMS DATA” (Section A) of the U.S. Government Terminal Procedures books for aircraft approach eligibility requirements by specific RNP level requirements.

**12.13.4.2** Some aircraft have RNP approval in their AFM without a GPS sensor. The lowest level of sensors that the FAA will support for RNP service is DME/DME. However, necessary DME signal may not be available at the airport of intended operations. For those locations having an RNAV chart published with LNAV/VNAV minimums, a procedure note may be provided such as “DME/DME RNP–0.3 NA.” This means that RNP aircraft dependent on DME/DME to achieve RNP–0.3 are not authorized to conduct this approach. Where DME facility availability is a factor, the note may read “DME/DME RNP–0.3 Authorized; ABC and XYZ Required.” This means that ABC and XYZ facilities have been determined by flight inspection to be required in the navigation solution to assure RNP–0.3. VOR/DME updating must not be used for approach procedures.

**12.13.5 Chart Terminology**

**12.13.5.1** Decision Altitude (DA) replaces the familiar term Decision Height (DH). DA conforms to the international convention where altitudes relate to MSL and heights relate to AGL. DA will eventually be

published for other types of instrument approach procedures with vertical guidance, as well. DA indicates to the pilot that the published descent profile is flown to the DA (MSL), where a missed approach will be initiated if visual references for landing are not established. Obstacle clearance is provided to allow a momentary descent below DA while transitioning from the final approach to the missed approach. The aircraft is expected to follow the missed instructions while continuing along the published final approach course to at least the published runway threshold waypoint or MAP (if not at the threshold) before executing any turns.

**12.13.5.2** Minimum Descent Altitude (MDA) has been in use for many years, and will continue to be used for the LNAV only and circling procedures.

**12.13.5.3** Threshold Crossing Height (TCH) has been traditionally used in “precision” approaches as the height of the glide slope above threshold. With publication of LNAV/VNAV minimums and RNAV descent angles, including graphically depicted descent profiles, TCH also applies to the height of the “descent angle,” or glidepath, at the threshold. Unless otherwise required for larger type aircraft which may be using the IAP, the typical TCH is 30 to 50 feet.

**12.13.6** The MINIMA FORMAT will also change slightly.

**12.13.6.1** Each line of minima on the RNAV IAP is titled to reflect the level of service available; e.g., GLS, LPV, LNAV/VNAV, LP, and LNAV. CIRCLING minima will also be provided.

**12.13.6.2** The minima title box indicates the nature of the minimum altitude for the IAP. For example:

a) DA will be published next to the minima line title for minimums supporting vertical guidance such as for GLS, LPV or LNAV/VNAV.

b) MDA will be published as the minima line on approaches with lateral guidance only, LNAV, or LP. Descent below the MDA must meet the conditions stated in 14 CFR Section 91.175.

c) Where two or more systems, such as LPV and LNAV/VNAV, share the same minima, each line of minima will be displayed separately.

**12.13.7** Chart Symbolology changed slightly to include:

**12.13.7.1 Descent Profile.** The published descent profile and a graphical depiction of the vertical path to the runway will be shown. Graphical depiction of the RNAV vertical guidance will differ from the traditional depiction of an ILS glide slope (feather) through the use of a shorter vertical track beginning at the decision altitude.

a) It is FAA policy to design IAPs with minimum altitudes established at fixes/waypoints to achieve optimum stabilized (constant rate) descents within each procedure segment. This design can enhance the safety of the operations and contribute toward reduction in the occurrence of controlled flight into terrain (CFIT) accidents. Additionally, the National Transportation Safety Board (NTSB) recently emphasized that pilots could benefit from publication of the appropriate IAP descent angle for a stabilized descent on final approach. The RNAV IAP format includes the descent angle to the hundredth of a degree; e.g., 3.00 degrees. The angle will be provided in the graphically depicted descent profile.

b) The stabilized approach may be performed by reference to vertical navigation information provided by WAAS or LNAV/VNAV systems; or for LNAV-only systems, by the pilot determining the appropriate aircraft attitude/groundspeed combination to attain a constant rate descent which best emulates the published angle. To aid the pilot, U.S. Government Terminal Procedures Publication charts publish an expanded Rate of Descent Table on the inside of the back hard cover for use in planning and executing precision descents under known or approximate groundspeed conditions.

**12.13.7.2 Visual Descent Point (VDP).** A VDP will be published on most RNAV IAPs. VDPs apply only to aircraft utilizing LP or LNAV minima, not LPV or LNAV/VNAV minimums.

**12.13.7.3 Missed Approach Symbolology.** In order to make missed approach guidance more readily understood, a method has been developed to display missed approach guidance in the profile view through the

use of quick reference icons. Due to limited space in the profile area, only four or fewer icons can be shown. However, the icons may not provide representation of the entire missed approach procedure. The entire set of textual missed approach instructions are provided at the top of the approach chart in the pilot briefing. (See FIG ENR 1.5–22.)

**12.13.7.4 Waypoints.** All RNAV or GPS stand-alone IAPs are flown using data pertaining to the particular IAP obtained from an onboard database, including the sequence of all WPs used for the approach and missed approach, except that step down waypoints may not be included in some TSO-C-129 receiver databases. Included in the database, in most receivers, is coding that informs the navigation system of which WPs are fly-over (FO) or fly-by (FB). The navigation system may provide guidance appropriately – including leading the turn prior to a fly-by WP; or causing overflight of a fly-over WP. Where the navigation system does not provide such guidance, the pilot must accomplish the turn lead or waypoint overflight manually. Chart symbology for the FB WP provides pilot awareness of expected actions. Refer to the legend of the U.S. Terminal Procedures books.

**12.13.7.5** TAAs are described in subparagraph 12.4, Terminal Arrival Area (TAA). When published, the RNAV chart depicts the TAA areas through the use of “icons” representing each TAA area associated with the RNAV procedure (See FIG ENR 1.5–22). These icons are depicted in the plan view of the approach chart, generally arranged on the chart in accordance with their position relative to the aircrafts arrival from the en route structure. The WP, to which navigation is appropriate and expected within each specific TAA area, will be named and depicted on the associated TAA icon. Each depicted named WP is the IAF for arrivals from within that area. TAAs may not be used on all RNAV procedures because of airspace congestion or other reasons.

**12.13.7.6 Published Temperature Limitations.** There are currently two temperature limitations that may be published in the notes box of the middle briefing strip on an instrument approach procedure (IAP). The two published temperature limitations are:

- a) A temperature range limitation associated with the use of Baro-VNAV that may be published on an United States PBN IAP titled RNAV (GPS) or RNAV (RNP); and/or
- b) A Cold Temperature Airport (CTA) limitation designated by a snowflake ICON and temperature in Celsius (C) that is published on every IAP for the airfield.

**REFERENCE–**

*AIP, Section ENR 1.8, Cold Temperature Barometric Altimeter Errors, Setting Procedures, and Cold Temperature Airports (CTA).*

**12.13.7.7 WAAS Channel Number/Approach ID.** The WAAS Channel Number is an optional equipment capability that allows the use of a 5-digit number to select a specific final approach segment without using the menu method. The Approach ID is an airport unique 4-character combination for verifying the selection and extraction of the correct final approach segment information from the aircraft database. It is similar to the ILS ident, but displayed visually rather than aurally. The Approach ID consists of the letter W for WAAS, the runway number, and a letter other than L, C or R, which could be confused with Left, Center and Right, e.g., W35A. Approach IDs are assigned in the order that WAAS approaches are built to that runway number at that airport. The WAAS Channel Number and Approach ID are displayed in the upper left corner of the approach procedure pilot briefing.

**12.13.7.8** At locations where outages of WAAS vertical guidance may occur daily due to initial system limitations, a negative W symbol (**W**) will be placed on RNAV (GPS) approach charts. Many of these outages will be very short in duration, but may result in the disruption of the vertical portion of the approach. The **W** symbol indicates that NOTAMs or Air Traffic advisories are not provided for outages which occur in the WAAS LNAV/VNAV or LPV vertical service. Use LNAV or circling minima for flight planning at these locations, whether as a destination or alternate. For flight operations at these locations, when the WAAS avionics indicate that LNAV/VNAV or LPV service is available, then vertical guidance may be used to complete the approach using the displayed level of service. Should an outage occur during the procedure, reversion to LNAV minima may be required. As the WAAS coverage is expanded, the **W** will be removed.

**NOTE–**

*Properly trained and approved, as required, TSO-C145() and TSO-C146() equipped users (WAAS users) with and using*

*approved baro-VNAV equipment may plan for LNAV/VNAV DA at an alternate airport. Specifically authorized WAAS users with and using approved baro-VNAV equipment may also plan for RNP 0.3 DA at the alternate airport as long as the pilot has verified RNP availability through an approved prediction program.*

### 13. Special Instrument Approach Procedures

**13.1** Instrument Approach Procedure (IAP) charts reflect the criteria associated with the U.S. Standard for Terminal Instrument [Approach] Procedures (TERPs), which prescribes standardized methods for use in developing IAPs. Standard IAPs are published in the Federal Register (FR) in accordance with Title 14 of the Code of Federal Regulations, Part 97, and are available for use by appropriately qualified pilots operating properly equipped and airworthy aircraft in accordance with operating rules and procedures acceptable to the FAA. Special IAPs are also developed using TERPS but are not given public notice in the FR. The FAA authorizes only certain individual pilots and/or pilots in individual organizations to use special IAPs, and may require additional crew training and/or aircraft equipment or performance, and may also require the use of landing aids, communications, or weather services not available for public use. Additionally, IAPs that service private use airports or heliports are generally special IAPs. FDC NOTAMs for Specials, FDC T-NOTAMs, may also be used to promulgate safety-of-flight information relating to Specials provided the location has a valid landing area identifier and is serviced by the United States NOTAM system. Pilots may access NOTAMs online or through an FAA Flight Service Station (FSS). FSS specialists will not automatically provide NOTAM information to pilots for special IAPs during telephone pre-flight briefings. Pilots who are authorized by the FAA to use special IAPs must specifically request FDC NOTAM information for the particular special IAP they plan to use.

### 14. Radar Approaches

**14.1** The only airborne radio equipment required for radar approaches is a functioning radio transmitter and receiver. The radar controller vectors the aircraft to align it with the runway centerline. The controller continues the vectors to keep the aircraft on course until the pilot can complete the approach and landing by visual reference to the surface. There are two types of radar approaches, “Precision” (PAR) and “Surveillance” (ASR).

**14.2** A radar approach may be given to any aircraft upon request and may be offered to pilots of aircraft in distress or to expedite traffic; however, a surveillance approach might not be approved unless there is an ATC operational requirement, or in an unusual or emergency situation. Acceptance of a precision or surveillance approach by a pilot does not waive the prescribed weather minimums for the airport or for the particular aircraft operator concerned. The decision to make a radar approach when the reported weather is below the established minimums rests with the pilot.

**14.3** Precision and surveillance approach minimums are published on separate pages in the Federal Aviation Administration Instrument Approach Procedure charts.

**14.3.1 A Precision Approach (PAR)** is one in which a controller provides highly accurate navigational guidance in azimuth and elevation to a pilot. Pilots are given headings to fly to direct them to and keep their aircraft aligned with the extended centerline of the landing runway. They are told to anticipate glidepath interception approximately 10 to 30 seconds before it occurs and when to start descent. The published decision height will be given only if the pilot requests it. If the aircraft is observed to deviate above or below the glidepath, the pilot is given the relative amount of deviation by use of terms “slightly” or “well” and is expected to adjust the aircraft’s rate of descent to return to the glidepath. Trend information is also issued with respect to the elevation of the aircraft and may be modified by the terms “rapidly” and “slowly”; e.g., “well above glidepath, coming down rapidly.” Range from touchdown is given at least once each mile. If an aircraft is observed by the controller to proceed outside of specified safety zone limits in azimuth and/or elevation and continues to operate outside these prescribed limits, the pilot will be directed to execute a missed approach or to fly a specified course unless the pilot has the runway environment (runway, approach lights, etc.) in sight. Navigational guidance in azimuth and elevation is provided the pilot until the aircraft reaches the published decision height (DH). Advisory course and glidepath information is furnished by the controller until the aircraft passes over the landing threshold,

at which point the pilot is advised of any deviation from the runway centerline. Radar service is automatically terminated upon completion of the approach.

**14.3.2 A Surveillance Approach (ASR)** is one in which a controller provides navigational guidance in azimuth only. The pilot is furnished headings to fly to align the aircraft with the extended centerline of the landing runway. Since the radar information used for a surveillance approach is considerably less precise than that used for a precision approach, the accuracy of the approach will not be as great, and higher minimums will apply. Guidance in elevation is not possible but the pilot will be advised when to commence descent to the minimum descent altitude (MDA) or, if appropriate, to an intermediate “step down fix” minimum crossing altitude and subsequently to the prescribed MDA. In addition, the pilot will be advised of the location of the missed approach point (MAP) prescribed for the procedure and the aircraft’s position each mile on final from the runway, airport/heliport, or MAP, as appropriate. If requested by the pilot, recommended altitudes will be issued at each mile, based on the descent gradient established for the procedure, down to the last mile that is at or above the MDA. Normally, navigational guidance will be provided until the aircraft reaches the MAP. Controllers will terminate guidance and instruct the pilot to execute a missed approach unless at the MAP the pilot has the runway, airport/heliport in sight or, for a helicopter point-in-space approach, the prescribed visual reference with the surface is established. Also, if at any time during the approach the controller considers that safe guidance for the remainder of the approach cannot be provided, the controller will terminate guidance and instruct the pilot to execute a missed approach. Similarly, guidance termination and missed approach will be effected upon pilot request, and for civil aircraft only, controllers may terminate guidance when the pilot reports the runway, airport/heliport, or visual surface route (point-in-space approach) in sight or otherwise indicates that continued guidance is not required. Radar service is automatically terminated at the completion of a radar approach.

**NOTE–**

*The published MDA for straight-in approaches will be issued to the pilot before beginning descent. When a surveillance approach will terminate in a circle-to-land maneuver, the pilot must furnish the aircraft approach category to the controller. The controller will then provide the pilot with the appropriate MDA.*

**14.3.3 A No-Gyro Approach** is available to a pilot under radar control who experiences circumstances wherein the directional gyro or other stabilized compass is inoperative or inaccurate. When this occurs, the pilot should so advise ATC and request a No-Gyro vector or approach. Pilots of aircraft not equipped with a directional gyro or other stabilized compass who desire radar handling may also request a No-Gyro vector or approach. The pilot should make all turns at standard rate and should execute the turn immediately upon receipt of instructions. For example, “TURN RIGHT,” “STOP TURN.” When a surveillance or precision approach is made, the pilot will be advised after the aircraft has been turned onto final approach to make turns at half standard rate.

## **15. Radar Monitoring of Instrument Approaches**

**15.1** PAR facilities operated by the FAA and the military services at some joint-use (civil/military) and military installations monitor aircraft on instrument approaches and issue radar advisories to the pilot when weather is below VFR minimum (1,000 and 3), at night, or when requested by a pilot. This service is provided only when the PAR final approach course coincides with the final approach of the navigational aid and only during the operational hours of the PAR. The radar advisories serve only as a secondary aid since the pilot has selected the navigational aid as the primary aid for the approach.

**15.2** Prior to starting final approach, the pilot will be advised of the frequency on which the advisories will be transmitted. If, for any reason, radar advisories cannot be furnished, the pilot will be so advised.

**15.3** Advisory information, derived from radar observations, includes information on:

**15.3.1** Passing the final approach fix inbound (nonprecision approach) or passing the outer marker or the fix used in lieu of the outer marker inbound (precision approach).

**15.3.2** Trend advisories with respect to elevation and/or azimuth radar position and movement will be provided.

**NOTE–**

*At this point, the pilot may be requested to report sighting the approach lights or the runway.*

**NOTE-**

*Whenever the aircraft nears the PAR safety limit, the pilot will be advised that the aircraft is well above or below the glidepath or well left or right of course. Glidepath information is given only to those aircraft executing a precision approach, such as ILS. Altitude information is not transmitted to aircraft executing other than precision approaches because the descent portions of these approaches generally do not coincide with the depicted PAR glidepath.*

**15.3.3** If, after repeated advisories, the aircraft proceeds outside the PAR safety limit or if a radical deviation is observed, the pilot will be advised to execute a missed approach if not visual.

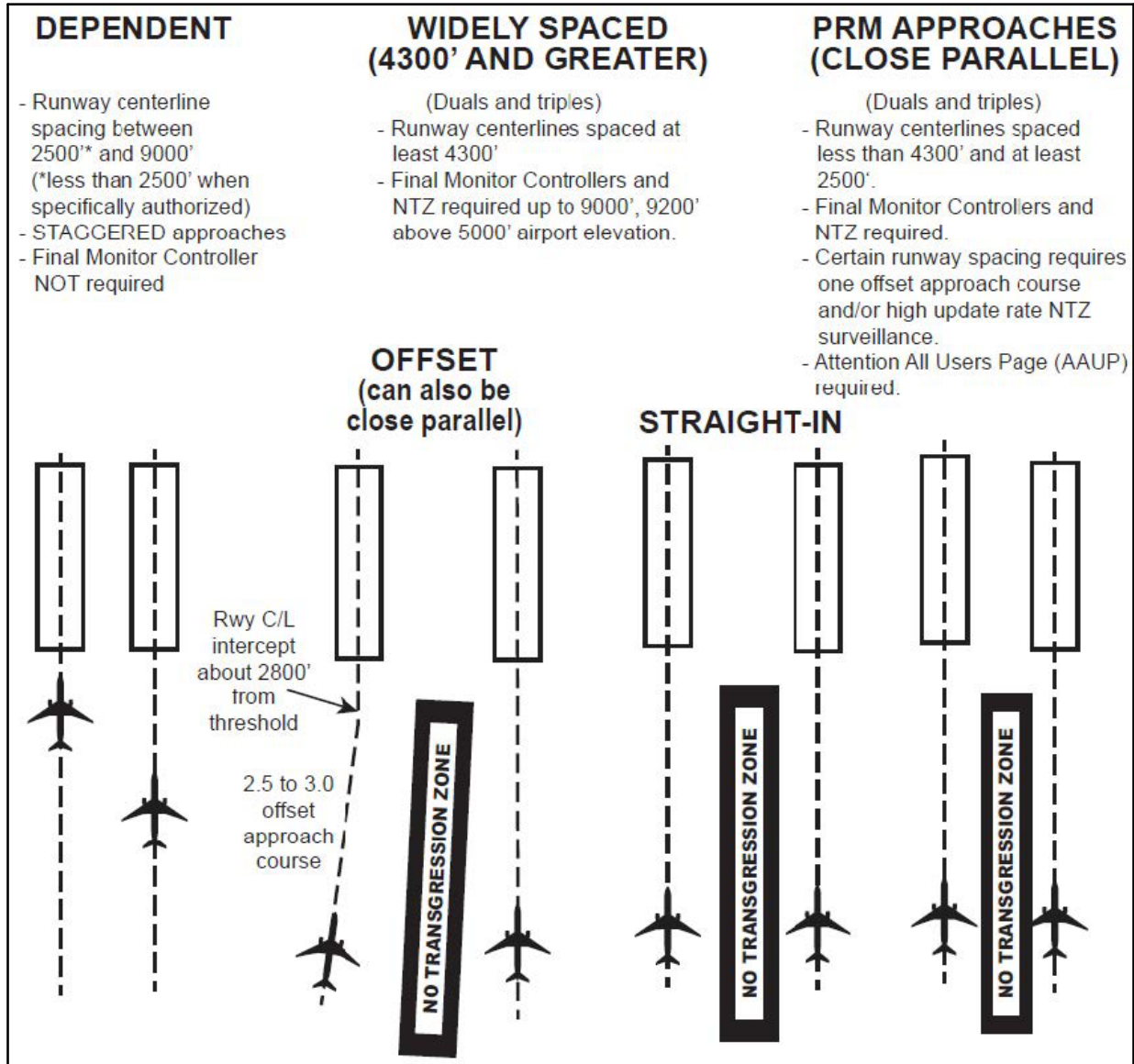
**15.4** Radar service is automatically terminated upon completion of the approach.

## **16. ILS Approach**

**16.1** Communications should be established with the appropriate FAA control tower or with the FAA FSS where there is no control tower, prior to starting an ILS approach. This is in order to receive advisory information as to the operation of the facility. It is also recommended that the aural signal of the ILS be monitored during an approach as to assure continued reception and receipt of advisory information, when available.

## 17. Simultaneous Approaches to Parallel Runways

FIG ENR 1.5-31  
Simultaneous Approaches  
(Approach Courses Parallel and Offset between 2.5 and 3.0 degrees)



**17.1** ATC procedures permit ILS/RNAV/GLS instrument approach operations to dual or triple parallel runway configurations. ILS/RNAV/GLS approaches to parallel runways are grouped into three classes: Simultaneous Dependent Approaches; Simultaneous Independent Approaches; and Simultaneous Close Parallel PRM Approaches. RNAV approach procedures that are approved for simultaneous operations require GPS as the sensor for position updating. VOR/DME, DME/DME and IRU RNAV updating is not authorized. The classification of a parallel runway approach procedure is dependent on adjacent parallel runway centerline separation, ATC procedures, and airport ATC final approach radar monitoring and communications capabilities. At some airports, one or more approach courses may be offset up to 3 degrees. ILS approaches with offset localizer configurations result in loss of Category II/III capabilities and an increase in decision altitude/height (50').



**17.2** Depending on weather conditions, traffic volume, and the specific combination of runways being utilized for arrival operations, a runway may be used for different types of simultaneous operations, including closely spaced dependent or independent approaches. Pilots should ensure that they understand the type of operation that is being conducted, and ask ATC for clarification if necessary.

**17.3** Parallel approach operations demand heightened pilot situational awareness. A thorough Approach Procedure Chart review should be conducted with, as a minimum, emphasis on the following approach chart information: name and number of the approach, localizer frequency, inbound localizer/azimuth course, glideslope/glidepath intercept altitude, glideslope crossing altitude at the final approach fix, decision height, missed approach instructions, special notes/procedures, and the assigned runway location/proximity to adjacent runways. Pilots are informed by ATC or through the ATIS that simultaneous approaches are in use.

**17.4** The close proximity of adjacent aircraft conducting simultaneous independent approaches, especially simultaneous close parallel PRM approaches mandates strict pilot compliance with all ATC clearances. ATC assigned airspeeds, altitudes, and headings must be complied with in a timely manner. Autopilot coupled approaches require pilot knowledge of procedures necessary to comply with ATC instructions. Simultaneous independent approaches, particularly simultaneous close parallel PRM approaches necessitate precise approach course tracking to minimize final monitor controller intervention, and unwanted No Transgression Zone (NTZ) penetration. In the unlikely event of a breakout, ATC will not assign altitudes lower than the minimum vectoring altitude. Pilots should notify ATC immediately if there is a degradation of aircraft or navigation systems.

**17.5** Strict radio discipline is mandatory during simultaneous independent and simultaneous close parallel PRM approach operations. This includes an alert listening watch and the avoidance of lengthy, unnecessary radio transmissions. Attention must be given to proper call sign usage to prevent the inadvertent execution of clearances intended for another aircraft. Use of abbreviated call signs must be avoided to preclude confusion of aircraft with similar sounding call signs. Pilots must be alert to unusually long periods of silence or any unusual background sounds in their radio receiver. A stuck microphone may block the issuance of ATC instructions on the tower frequency by the final monitor controller during simultaneous independent and simultaneous close parallel PRM approaches. In the case of PRM approaches, the use of a second frequency by the monitor controller mitigates the “stuck mike” or other blockage on the tower frequency.

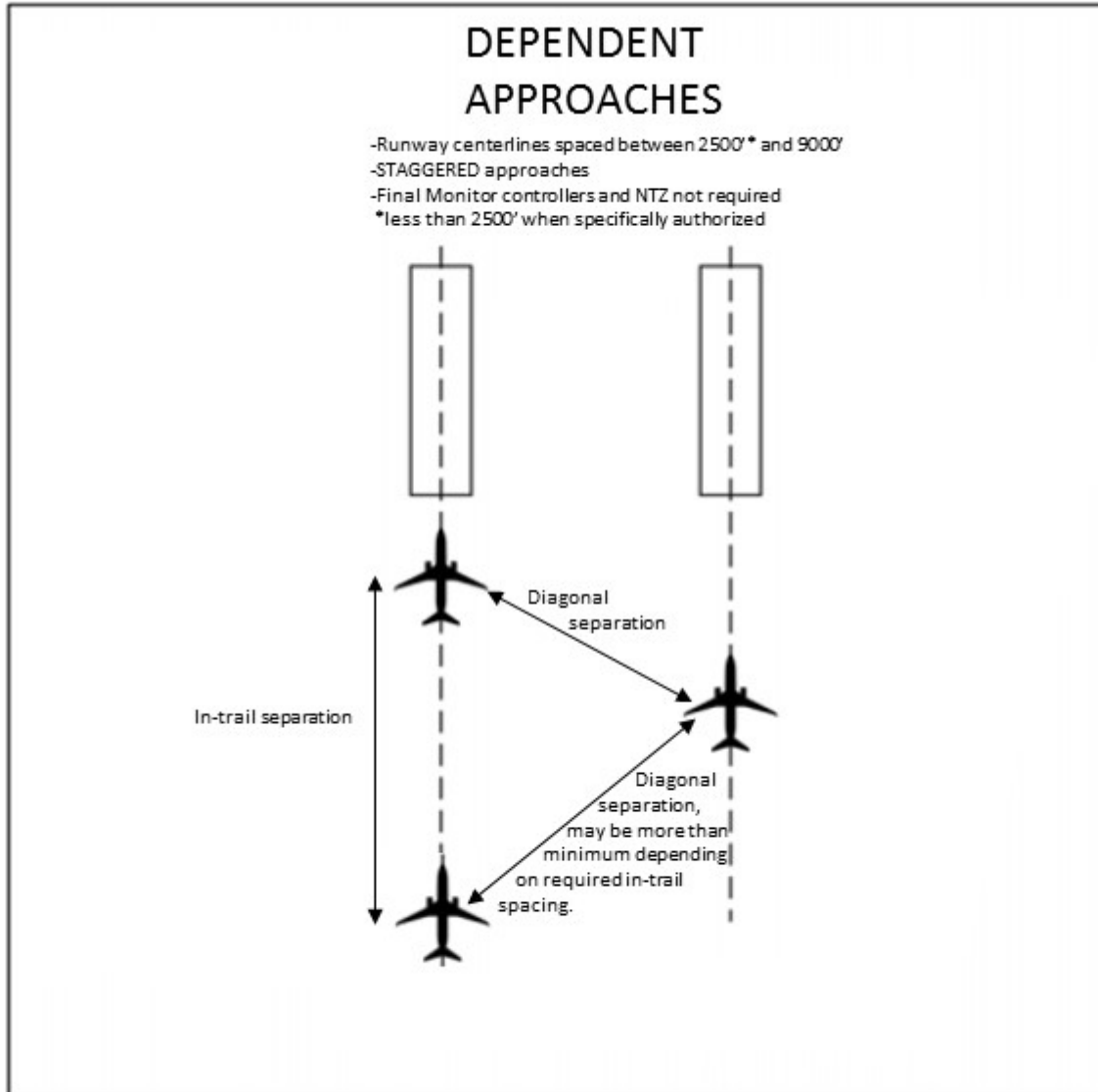
**REFERENCE–**

*AIP GEN 3.4, Paragraph 4.4, Radio Communications Phraseology and Techniques, gives additional communications information.*

**17.6** Use of Traffic Collision Avoidance Systems (TCAS) provides an additional element of safety to parallel approach operations. Pilots should follow recommended TCAS operating procedures presented in approved flight manuals, original equipment manufacturer recommendations, professional newsletters, and FAA publications.

## 18. Simultaneous Dependent Approaches

FIG ENR 1.5-32  
Simultaneous Approaches  
(Parallel Runways and Approach Courses)



**18.1** Simultaneous dependent approaches are an ATC procedure permitting approaches to airports having parallel runway centerlines separated by at least 2,500 feet up to 9,000 feet. Integral parts of a total system are ILS or other system providing approach navigation, radar, communications, ATC procedures, and required airborne equipment. RNAV equipment in the aircraft or GLS equipment on the ground and in the aircraft may replace the required airborne and ground based ILS equipment. Although non-precision minimums may be published, pilots must only use those procedures specifically authorized by chart note. For example, the chart note "LNAV NA during simultaneous operations," requires vertical guidance. When given a choice, pilots should always fly a precision approach whenever possible.

**18.2** A simultaneous dependent approach differs from a simultaneous independent approach in that, the minimum distance between parallel runway centerlines may be reduced; there is no requirement for radar monitoring or advisories; and a staggered separation of aircraft on the adjacent final course is required.

**18.3** A minimum of 1.0 NM radar separation (diagonal) is required between successive aircraft on the adjacent final approach course when runway centerlines are at least 2,500 feet but no more than 3,600 feet apart. A minimum of 1.5 NM radar separation (diagonal) is required between successive aircraft on the adjacent final approach course when runway centerlines are more than 3,600 feet but no more than 8,300 feet apart. When runway centerlines are more than 8,300 feet but no more than 9,000 feet apart a minimum of 2 NM diagonal radar separation is provided. Aircraft on the same final approach course within 10 NM of the runway end are provided a minimum of 3 NM radar separation, reduced to 2.5 NM in certain circumstances. In addition, a minimum of 1,000 feet vertical or a minimum of three miles radar separation is provided between aircraft during turn on to the parallel final approach course.

**18.4** Whenever parallel approaches are in use, pilots are informed by ATC or via the ATIS that approaches to both runways are in use. The charted IAP also notes which runways may be used simultaneously. In addition, the radar controller will have the interphone capability of communicating with the tower controller where separation responsibility has not been delegated to the tower.

**NOTE–**

*ATC will not specifically identify these operations as being dependent when advertised on the ATIS.*

**EXAMPLE–**

*Simultaneous ILS Runway 19 right and ILS Runway 19 left in use.*

**18.5** At certain airports, simultaneous dependent approaches are permitted to runways spaced less than 2,500 feet apart. In this case, ATC will provide no less than the minimum authorized diagonal separation with the leader always arriving on the same runway. The trailing aircraft is permitted reduced diagonal separation, instead of the single runway separation normally utilized for runways spaced less than 2,500 feet apart. For wake turbulence mitigation reasons:

**18.5.1** Reduced diagonal spacing is only permitted when certain aircraft wake category pairings exist; typically when the leader is either in the large or small wake turbulence category, and

**18.5.2** All aircraft must descend on the glideslope from the altitude at which they were cleared for the approach during these operations.

When reduced separation is authorized, the IAP briefing strip indicates that simultaneous operations require the use of vertical guidance and that the pilot should maintain last assigned altitude until intercepting the glideslope. No special pilot training is required to participate in these operations.

**NOTE–**

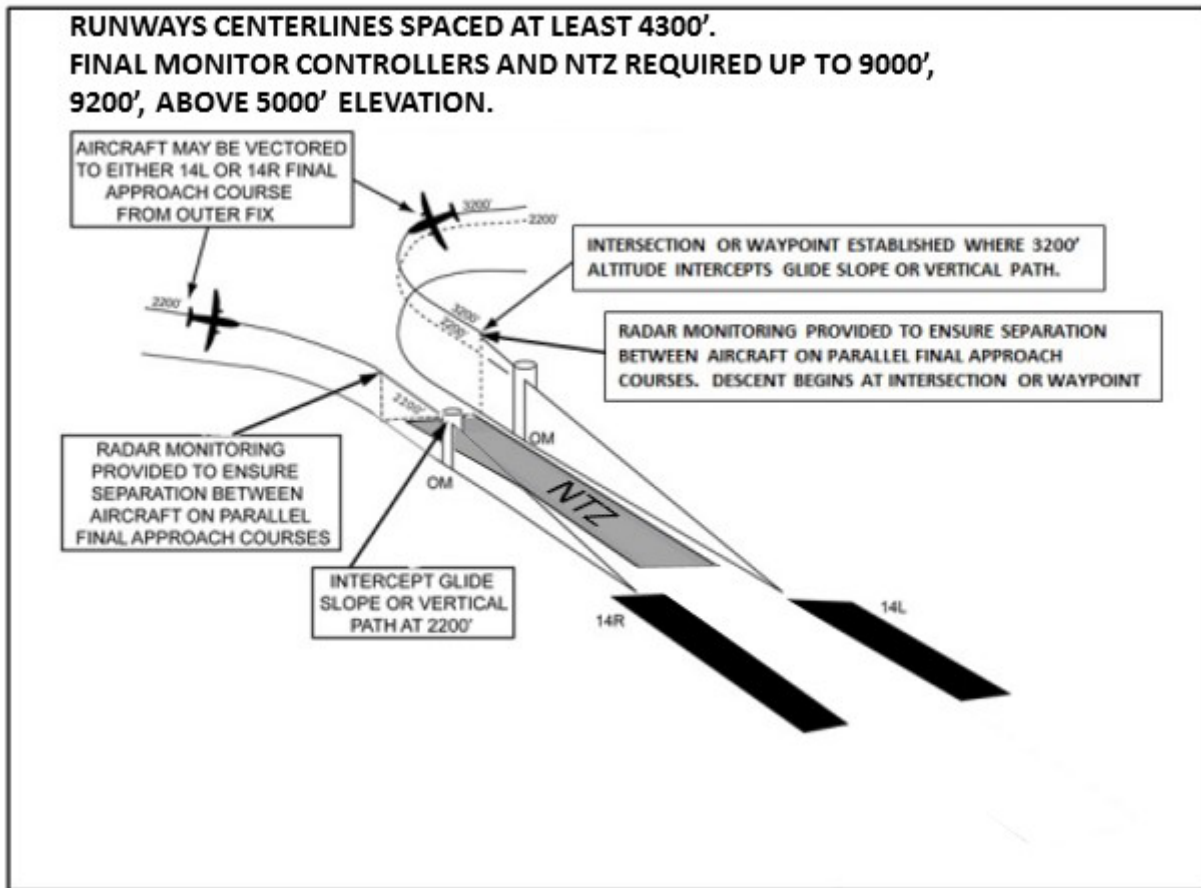
*Either simultaneous dependent approaches with reduced separation or SOIA PRM approaches may be conducted to Runways 28R and 28L at KSFO spaced 750 feet apart, depending on weather conditions and traffic volume. Pilots should use caution so as not to confuse these operations. Plan for SOIA procedures only when ATC assigns a PRM approach or the ATIS advertises PRM approaches are in use. KSFO is the only airport where both procedures are presently conducted.*

**REFERENCE–**

*ENR 1.5, Para 20. Simultaneous Close Parallel PRM Approaches and Simultaneous Offset Instrument Approaches (SOIA)*

## 19. Simultaneous Independent ILS/RNAV/GLS Approaches

FIG ENR 1.5-33  
Simultaneous Independent ILS/RNAV/GLS Approaches



**19.1 System.** An approach system permitting simultaneous approaches to parallel runways with centerlines separated by at least 4,300 feet. Separation between 4,300 and 9,000 feet (9,200' for airports above 5,000') utilizing NTZ final monitor controllers. Simultaneous independent approaches require NTZ radar monitoring to ensure separation between aircraft on the adjacent parallel approach course. Aircraft position is tracked by final monitor controllers who will issue instructions to aircraft observed deviating from the assigned final approach course. Staggered radar separation procedures are not utilized. Integral parts of a total system are radar, communications, ATC procedures, and ILS or other required airborne equipment. A chart note identifies that the approach is authorized for simultaneous use.

When simultaneous operations are in use, it will be advertised on the ATIS. When advised that simultaneous approaches are in use, pilots must advise approach control immediately of malfunctioning or inoperative receivers, or if a simultaneous approach is not desired. Although non-precision minimums may be published, pilots must only use those procedures specifically authorized by chart note. For example, the chart note "LNAV NA during simultaneous operations," requires vertical guidance. When given a choice, pilots should always fly a precision approach whenever possible.

**NOTE-**

ATC does not use the word *independent* or *parallel* when advertising these operations on the ATIS.

**EXAMPLE-**

*Simultaneous ILS Runway 24 left and ILS Runway 24 right approaches in use.*

**19.2 Radar Services.** These services are provided for each simultaneous independent approach.

**19.2.1** During turn on to parallel final approach, aircraft are normally provided 3 miles radar separation or a minimum of 1,000 feet vertical separation. The assigned altitude must be maintained until intercepting the glidepath, unless cleared otherwise by ATC. Aircraft will not be vectored to intercept the final approach course at an angle greater than thirty degrees.

**NOTE–**

*Some simultaneous operations permit the aircraft to track an RNAV course beginning on downwind and continuing in a turn to intercept the final approach course. In this case, separation with the aircraft on the adjacent final approach course is provided by the monitor controller with reference to an NTZ.*

**19.2.2** The final monitor controller will have the capability of overriding the tower controller on the tower frequency.

**19.2.3** Pilots will be instructed to contact the tower frequency prior to the point where NTZ monitoring begins.

**19.2.4** Aircraft observed to overshoot the turn-on or to continue on a track which will penetrate the NTZ will be instructed to return to the correct final approach course immediately. The final monitor controller may cancel the approach clearance, and issue missed approach or other instructions to the deviating aircraft.

**PHRASEOLOGY–**

*“(Aircraft call sign) YOU HAVE CROSSED THE FINAL APPROACH COURSE. TURN (left/right) IMMEDIATELY AND RETURN TO THE FINAL APPROACH COURSE,”*

*or*

*“(aircraft call sign) TURN (left/right) AND RETURN TO THE FINAL APPROACH COURSE.”*

**19.2.5** If a deviating aircraft fails to respond to such instructions or is observed penetrating the NTZ, the aircraft on the adjacent final approach course (if threatened), will be issued a breakout instruction.

**PHRASEOLOGY–**

*“TRAFFIC ALERT (aircraft call sign) TURN (left/right) IMMEDIATELY HEADING (degrees), (climb/descend) AND MAINTAIN (altitude).”*

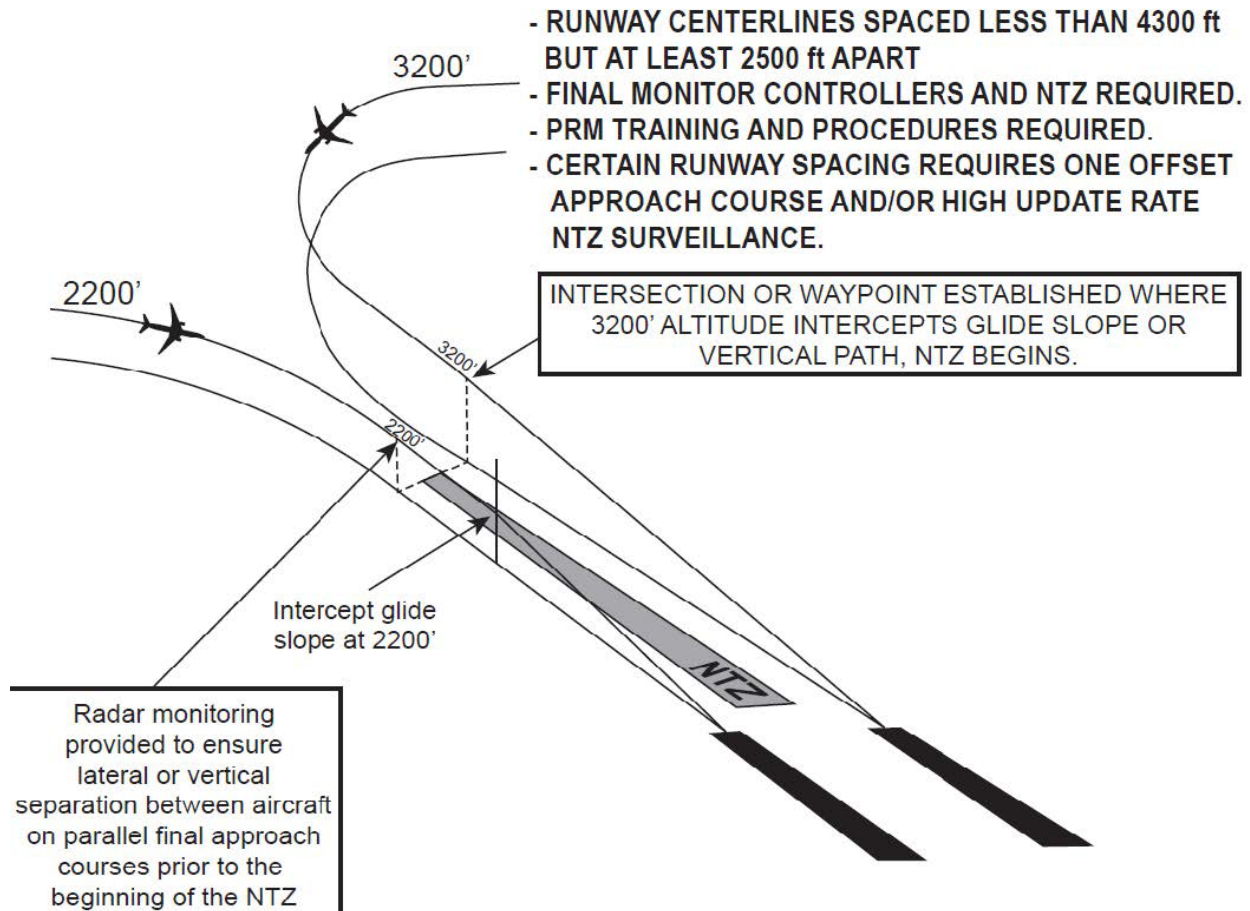
**19.2.6** Radar monitoring will automatically be terminated when visual separation is applied, the aircraft reports the approach lights or runway in sight, or the aircraft is 1 NM or less from the runway threshold. Final monitor controllers will not advise pilots when radar monitoring is terminated.

**NOTE–**

*Simultaneous independent approaches conducted to runways spaced greater than 9,000 feet (or 9,200' at airports above 5,000') do not require an NTZ. However, from a pilot's perspective, the same alerts relative to deviating aircraft will be provided by ATC as are provided when an NTZ is being monitored. Pilots may not be aware as to whether or not an NTZ is being monitored.*

## 20. Simultaneous Close Parallel PRM Approaches and Simultaneous Offset Instrument Approaches (SOIA)

FIG ENR 1.5-34  
PRM Approaches  
Simultaneous Close Parallel



### 20.1 System

**20.1.1** PRM is an acronym for the high update rate Precision Runway Monitor surveillance system which is required to monitor the No Transgression Zone (NTZ) for specific parallel runway separations used to conduct simultaneous close parallel approaches. PRM is also published in the title as part of the approach name for IAPs used to conduct Simultaneous Close Parallel approaches. “PRM” alerts pilots that specific airborne equipment, training, and procedures are applicable.

Because Simultaneous Close Parallel PRM approaches are independent, the NTZ and normal operating zone (NOZ) airspace between the final approach courses is monitored by two monitor controllers, one for each approach course. The NTZ monitoring system (final monitor aid) consists of a high resolution ATC radar display with automated tracking software which provides monitor controllers with aircraft identification, position, speed, and a ten-second projected position, as well as visual and aural NTZ penetration alerts. A PRM high update rate surveillance sensor is a component of this system only for specific runway spacing. Additional procedures for simultaneous independent approaches are described in ENR 1.5, paragraph 19. Simultaneous Independent ILS/RNAV/GLS Approaches.

**20.1.2** Simultaneous Close Parallel PRM approaches, whether conducted utilizing a high update rate PRM surveillance sensor or not, must meet all of the following requirements: pilot training, PRM in the approach

title, NTZ monitoring utilizing a final monitor aid, radar display, publication of an AAUP, and use of a secondary PRM communications frequency. PRM approaches are depicted on a separate IAP titled (Procedure type) PRM Rwy XXX (Simultaneous Close Parallel or Close Parallel).

**NOTE–**

*ATC does not use the word “independent” when advertising these operations on the ATIS.*

**EXAMPLE–**

*Simultaneous ILS PRM Runway 33 left and ILS PRM Runway 33 right approaches in use.*

**20.1.2.1** The pilot may request to conduct a different type of PRM approach to the same runway other than the one that is presently being used; for example, RNAV instead of ILS. However, pilots must always obtain ATC approval to conduct a different type of approach. Also, in the event of the loss of ground-based NAVAIDS, the ATIS may advertise other types of PRM approaches to the affected runway or runways.

**20.1.2.2** The Attention All Users Page (AAUP) will address procedures for conducting PRM approaches.

**20.2** Requirements and Procedures. Besides system requirements and pilot procedures as identified in subparagraph 20.1.1 above, all pilots must have completed special training before accepting a clearance to conduct a PRM approach.

**20.2.1** Pilot Training Requirement. Pilots must complete special pilot training, as outlined below, before accepting a clearance for a simultaneous close parallel PRM approach.

**20.2.1.1** For operations under 14 CFR Parts 121, 129, and 135, pilots must comply with FAA–approved company training as identified in their Operations Specifications. Training includes the requirement for pilots to view the FAA training slide presentation, “Precision Runway Monitor (PRM) Pilot Procedures.” Refer to [https://www.faa.gov/training\\_testing/training/prm/](https://www.faa.gov/training_testing/training/prm/) or search key words “FAA PRM” for additional information and to view or download the slide presentation.

**20.2.1.2** For operations under Part 91:

a) Pilots operating transport category aircraft must be familiar with PRM operations as contained in this section of the AIM. In addition, pilots operating transport category aircraft must view the slide presentation, “Precision Runway Monitor (PRM) Pilot Procedures.” Refer to [https://www.faa.gov/training\\_testing/training/prm/](https://www.faa.gov/training_testing/training/prm/) or search key words “FAA PRM” for additional information and to view or download the slide presentation.

b) Pilots *not* operating transport category aircraft must be familiar with PRM and SOIA operations as contained in this section of the AIM. The FAA strongly recommends that pilots *not* involved in transport category aircraft operations view the FAA training slide presentation, “Precision Runway Monitor (PRM) Pilot Procedures.” Refer to [https://www.faa.gov/training\\_testing/training/prm/](https://www.faa.gov/training_testing/training/prm/) or search key words “FAA PRM” for additional information and to view or download the slide presentation.

**NOTE–**

*Depending on weather conditions, traffic volume, and the specific combination of runways being utilized for arrival operations, a runway may be used for different types of simultaneous operations, including closely spaced dependent or independent approaches. Use PRM procedures only when the ATIS advertises their use. For other types of simultaneous approaches, see ENR 1.5 paragraphs 17 and 18.*

**20.3 ATC Directed Breakout.** An ATC directed “breakout” is defined as a vector off the final approach course of a threatened aircraft in response to another aircraft penetrating the NTZ.

**20.4 Dual Communications.** The aircraft flying the PRM approach must have the capability of enabling the pilot/s to listen to two communications frequencies simultaneously. To avoid blocked transmissions, each runway will have two frequencies, a primary and a PRM monitor frequency. The tower controller will transmit on both frequencies. The monitor controller’s transmissions, if needed, will override both frequencies. Pilots will ONLY transmit on the tower controller’s frequency, but will listen to both frequencies. Select the PRM monitor frequency audio only when instructed by ATC to contact the tower. The volume levels should be set about the same on both radios so that the pilots will be able to hear transmissions on the PRM frequency if the tower is blocked. Site–specific procedures take precedence over the general information presented in this paragraph. Refer to the AAUP for applicable procedures at specific airports.

## 20.5 Radar Services

**20.5.1** During turn on to parallel final approach, aircraft will be provided 3 miles radar separation or a minimum of 1,000 feet vertical separation. The assigned altitude must be maintained until intercepting the glideslope/glidepath, unless cleared otherwise by ATC. Aircraft will not be vectored to intercept the final approach course at an angle greater than thirty degrees.

**20.5.2** The final monitor controller will have the capability of overriding the tower controller on the tower frequency as well as transmitting on the PRM frequency.

**20.5.3** Pilots will be instructed to contact the tower frequency prior to the point where NTZ monitoring begins. Pilots will begin monitoring the secondary PRM frequency at that time (see Dual VHF Communications Required below).

**20.5.4** To ensure separation is maintained, and in order to avoid an imminent situation during PRM approaches, pilots must immediately comply with monitor controller instructions.

**20.5.5** Aircraft observed to overshoot the turn or to continue on a track which will penetrate the NTZ will be instructed to return to the correct final approach course immediately. The final monitor controller may cancel the approach clearance, and issue missed approach or other instructions to the deviating aircraft.

### **PHRASEOLOGY–**

*“(Aircraft call sign) YOU HAVE CROSSED THE FINAL APPROACH COURSE. TURN (left/right) IMMEDIATELY AND RETURN TO THE FINAL APPROACH COURSE,”*

*or*

*“(Aircraft call sign) TURN (left/right) AND RETURN TO THE FINAL APPROACH COURSE.”*

**20.5.6** If a deviating aircraft fails to respond to such instructions or is observed penetrating the NTZ, the aircraft on the adjacent final approach course (if threatened) will be issued a breakout instruction.

### **PHRASEOLOGY–**

*“TRAFFIC ALERT (aircraft call sign) TURN (left/right) IMMEDIATELY HEADING (degrees), (climb/descend) AND MAINTAIN (altitude).”*

**20.5.7** Radar monitoring will automatically be terminated when visual separation is applied, or the aircraft reports the approach lights or runway in sight or within 1 NM of the runway threshold. Final monitor controllers will not advise pilots when radar monitoring is terminated.

**20.6 Attention All Users Page (AAUP).** At airports that conduct PRM operations, the AAUP informs pilots under the “General” section of information relative to all the PRM approaches published at a specific airport, and this section must be briefed in its entirety. Under the “Runway Specific” section, only items relative to the runway to be used for landing need be briefed. (See FIG ENR 1.5–35.) A single AAUP is utilized for multiple PRM approach charts at the same airport, which are listed on the AAUP. The requirement for informing ATC if the pilot is unable to accept a PRM clearance is also presented. The “General” section of AAUP addresses the following:

**20.6.1** Review of the procedure for executing a climbing or descending breakout;

**20.6.2** Breakout phraseology beginning with the words, “Traffic Alert;”

**20.6.3** Descending on the glideslope/glidepath meets all crossing restrictions;

**20.6.4** Briefing the PRM approach also satisfies the non-PRM approach briefing of the same type of approach to the same runway; and

**20.6.5** Description of the dual communications procedure.

The “Runway Specific” section of the AAUP addresses those issues which only apply to certain runway ends that utilize PRM approaches. There may be no Runway Specific procedures, a single item applicable to only one runway end, or multiple items for a single or multiple runway end/s. Examples of SOIA runway specific procedures are as follows:



FIG ENR 1.5-35  
PRM Attention All Users Page (AAUP)

15288 PRM APPROACH AAUP AL 166 (FAA) USA INTL (USA)  
USA CITY

**ATTENTION ALL USERS PAGE (AAUP)**  
(PRM CLOSE PARALLEL)

Pilots who are unable to participate will be afforded appropriate arrival services as operational conditions permit and must notify the controlling ATC facility as soon as practical, but at least 120 miles from destination.

ILS PRM or LOC PRM Rwy's 10R, 10C, 28L, 28C  
RNAV (GPS) PRM RWYS 10R, 10C, 28L, 28C

**General**

- Review procedure for executing a climbing and descending PRM breakout.
- Breakout phraseology: "TRAFFIC ALERT (call sign) TURN (left/right) IMMEDIATELY HEADING (degrees) CLIMB/DESCEND AND MAINTAIN (altitude)."
- All breakouts: Hand flown, initiate immediately.
- Descending on the glideslope/glidepath ensures compliance with any charted crossing restrictions.
- Dual VHF COMM: When assigned or planning a specific PRM approach, tune a second receiver to the PRM monitor frequency or, if silent, other active frequency (i.e., ATIS), set the volume, retune the PRM frequency if necessary, then deselect the audio. When directed by ATC, immediately switch to the tower frequency and select the secondary radio audio to ON.
- If later assigned the same runway, non-PRM approach, consider it briefed provided the same minimums are utilized. PRM related chart notes and frequency no longer apply.
- TCAS during breakout: Follow TCAS climb/descend if it differs from ATC, while executing the breakout turn.

**Runway Specific**

- Runway 10R: Exit at taxiway Tango whenever practical.

PRM APPROACH AAUP 41°59'N 87°54'W USA INTL (USA)  
USA CITY

**20.7 Simultaneous Offset Instrument Approach (SOIA).**

**20.7.1** SOIA is a procedure used to conduct simultaneous approaches to runways spaced less than 3,000 feet, but at least 750 feet apart. The SOIA procedure utilizes a straight-in PRM approach to one runway, and a PRM offset approach with glideslope/glidepath to the adjacent runway. In SOIA operations, aircraft are paired, with the aircraft conducting the straight-in PRM approach always positioned slightly ahead of the aircraft conducting the offset PRM approach.

**20.7.2** The straight-in PRM approach plates used in SOIA operations are identical to other straight-in PRM approach plates, with an additional note, which provides the separation between the two runways used for

simultaneous SOIA approaches. The offset PRM approach plate displays the required notations for closely spaced approaches as well as depicts the visual segment of the approach.

**20.7.3** Controllers monitor the SOIA PRM approaches in exactly the same manner as is done for other PRM approaches. The procedures and system requirements for SOIA PRM approaches are identical with those used for simultaneous close parallel PRM approaches until near the offset PRM approach missed approach point (MAP), where visual acquisition of the straight-in aircraft by the aircraft conducting the offset PRM approach occurs. Since SOIA PRM approaches are identical to other PRM approaches (except for the visual segment in the offset approach), an understanding of the procedures for conducting PRM approaches is essential before conducting a SOIA PRM operation.

**20.7.4** In SOIA, the approach course separation (instead of the runway separation) meets established close parallel approach criteria. (See FIG ENR 1.5–36 for the generic SOIA approach geometry.) A visual segment of the offset PRM approach is established between the offset MAP and the runway threshold. Aircraft transition in visual conditions from the offset course, beginning at the offset MAP, to align with the runway and can be stabilized by 500 feet above ground level (AGL) on the extended runway centerline. A cloud ceiling for the approach is established so that the aircraft conducting the offset approach has nominally at least 30 seconds or more to acquire the leading straight-in aircraft prior to reaching the offset MAP. If visual acquisition is not accomplished prior to crossing the offset MAP, a missed approach must be executed.

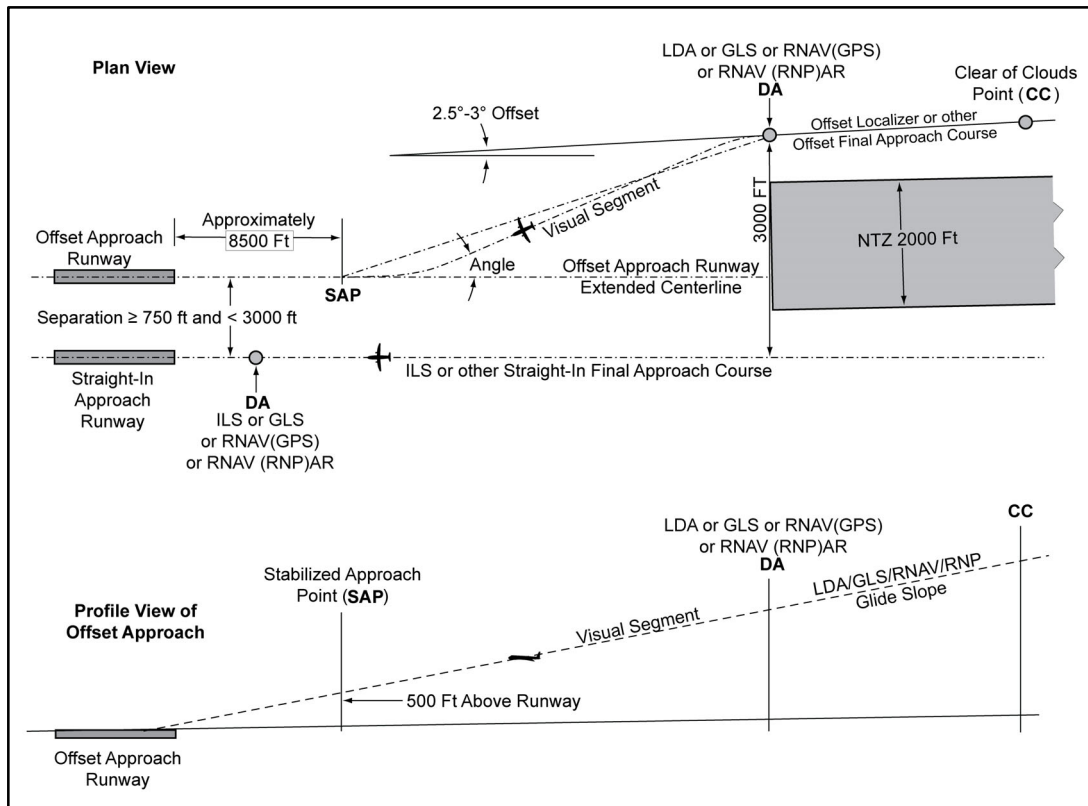
**20.7.5** Flight Management System (FMS) coding of the offset RNAV PRM and GLS PRM approaches in a SOIA operation is different than other RNAV and GLS approach coding in that it does not match the initial missed approach procedure published on the charted IAP. In the SOIA design of the offset approach, lateral course guidance terminates at the fictitious threshold point (FTP), which is an extension of the final approach course beyond the offset MAP to a point near the runway threshold. The FTP is designated in the approach coding as the MAP so that vertical guidance is available to the pilot to the runway threshold, just as vertical guidance is provided by the offset LDA glideslope. No matter what type of offset approach is being conducted, reliance on lateral guidance is discontinued at the charted MAP and replaced by visual maneuvering to accomplish runway alignment.

**20.7.5.1** As a result of this approach coding, when executing a missed approach at and after passing the charted offset MAP, a heading must initially be flown (either hand-flown or using autopilot “heading mode”) before engaging LNAV. If the pilot engages LNAV immediately, the aircraft may continue to track toward the FTP instead of commencing a turn toward the missed approach holding fix. Notes on the charted IAP and in the AAUP make specific reference to this procedure.

**20.7.5.2** Some FMSs do not code waypoints inside of the FAF as part of the approach. Therefore, the depicted MAP on the charted IAP may not be included in the offset approach coding. Pilots utilizing those FMSs may identify the location of the waypoint by noting its distance from the FTP as published on the charted IAP. In those same FMSs, the straight-in SOIA approach will not display a waypoint inside the PFAF. The same procedures may be utilized to identify an uncoded waypoint. In this case, the location is determined by noting its distance from the runway waypoint or using an authorized distance as published on the charted IAP.

**20.7.5.3** Because the FTP is coded as the MAP, the FMS map display will depict the initial missed approach course as beginning at the FTP. This depiction does not match the charted initial missed approach procedure on the IAP. Pilots are reminded that charted IAP guidance is to be followed, not the map display. Once the aircraft completes the initial turn when commencing a missed approach, the remainder of the procedure coding is standard and can be utilized as with any other IAP.

FIG ENR 1.5-36  
SOIA Approach Geometry



**NOTE-**

**SAP** The stabilized approach point is a design point along the extended centerline of the intended landing runway on the glide slope/glide path at 500 feet above the runway threshold elevation. It is used to verify a sufficient distance is provided for the visual maneuver after the offset course approach DA to permit the pilots to conform to approved, stabilized approach criteria. The SAP is not published on the IAP.

**Offset Course DA** The point along the LDA, or other offset course, where the course separation with the adjacent ILS, or other straight-in course, reaches the minimum distance permitted to conduct closely spaced approaches. Typically that minimum distance will be 3,000 feet without the use of high update radar; with high update radar, course separation of less than 3,000 ft may be used when validated by a safety study. The altitude of the glide slope/glide path at that point determines the offset course approach decision altitude and is where the NTZ terminates. Maneuvering inside the DA is done in visual conditions.

**Visual Segment Angle** Angle, as determined by the SOIA design tool, formed by the extension of the straight segment of the calculated flight track (between the offset course MAP/DA and the SAP) and the extended runway centerline. The size of the angle is dependent on the aircraft approach categories (Category D or only selected categories/speeds) that are authorized to use the offset course approach and the spacing between the runways.

**Visibility** Distance from the offset course approach DA to runway threshold in statute mile.

**Procedure** The aircraft on the offset course approach must see the runway-landing environment and, if ATC has advised that traffic on the straight-in approach is a factor, the offset course approach aircraft must visually acquire the straight-in approach aircraft and report it in sight to ATC prior to reaching the DA for the offset course approach.

**CC** *The Clear of Clouds point is the position on the offset final approach course where aircraft first operate in visual meteorological conditions below the ceiling, when the actual weather conditions are at, or near, the minimum ceiling for SOIA operations. Ceiling is defined by the Aeronautical Information Manual.*

**20.7.6** SOIA PRM approaches utilize the same dual communications procedures as do other PRM approaches.

**NOTE–**

*At KSFO, pilots conducting SOIA operations select the monitor frequency audio when communicating with the final radar controller, not the tower controller as is customary. In this special case, the monitor controller’s transmissions, if required, override the final controller’s frequency. This procedure is addressed on the AAUP.*

**20.7.6.1** SOIA utilizes the same AAUP format as do other PRM approaches. The minimum weather conditions that are required are listed. Because of the more complex nature of instructions for conducting SOIA approaches, the “Runway Specific” items are more numerous and lengthy.

**20.7.6.2** Examples of SOIA offset runway specific notes:

a) Aircraft must remain on the offset course until passing the offset MAP prior to maneuvering to align with the centerline of the offset approach runway.

b) Pilots are authorized to continue past the offset MAP to align with runway centerline when:

1) the straight-in approach traffic is in sight and is expected to remain in sight,

2) ATC has been advised that “traffic is in sight.” (ATC is not required to acknowledge this transmission),

3) the runway environment is in sight. Otherwise, a missed approach must be executed. Between the offset MAP and the runway threshold, pilots conducting the offset PRM approach must not pass the straight-in aircraft and are responsible for separating themselves visually from traffic conducting the straight-in PRM approach to the adjacent runway, which means maneuvering the aircraft as necessary to avoid that traffic until landing, and providing wake turbulence avoidance, if applicable. Pilots maintaining visual separation should advise ATC, as soon as practical, if visual contact with the aircraft conducting the straight-in PRM approach is lost and execute a missed approach unless otherwise instructed by ATC.

**20.7.6.3** Examples of SOIA straight-in runway specific notes:

a) To facilitate the offset aircraft in providing wake mitigation, pilots should descend on, not above, the glideslope/glidepath.

b) Conducting the straight-in approach, pilots should be aware that the aircraft conducting the offset approach will be approaching from the right/left rear and will be operating in close proximity to the straight-in aircraft.

**20.7.7 Recap.**

The following are differences between widely spaced simultaneous approaches (at least 4,300 feet between the runway centerlines) and Simultaneous PRM close parallel approaches which are of importance to the pilot:

**20.7.7.1 Runway Spacing.** Prior to PRM simultaneous close parallel approaches, most ATC-directed breakouts were the result of two aircraft in-trail on the same final approach course getting too close together. Two aircraft going in the same direction did not mandate quick reaction times. With PRM closely spaced approaches, two aircraft could be alongside each other, navigating on courses that are separated by less than 4,300 feet and as close as 3,000 feet. In the unlikely event that an aircraft “blunders” off its course and makes a worst case turn of 30 degrees toward the adjacent final approach course, closing speeds of 135 feet per second could occur that constitute the need for quick reaction. A blunder has to be recognized by the monitor controller, and breakout instructions issued to the endangered aircraft. The pilot will not have any warning that a breakout is imminent because the blundering aircraft will be on another frequency. It is important that, when a pilot receives breakout instructions, the assumption is made that a blundering aircraft is about to (or has penetrated the NTZ) and is heading toward his/her approach course. The pilot must initiate a breakout as soon as safety allows. While

conducting PRM approaches, pilots must maintain an increased sense of awareness in order to immediately react to an ATC (breakout) instruction and maneuver (as instructed by ATC) away from a blundering aircraft.

**20.7.7.2 Communications.** Dual VHF communications procedures should be carefully followed. One of the assumptions made that permits the safe conduct of PRM approaches is that there will be no blocked communications.

**20.7.7.3 Hand–flown Breakouts.** The use of the autopilot is encouraged while flying a PRM approach, but the autopilot must be disengaged in the rare event that a breakout is issued. Simulation studies of breakouts have shown that a hand–flown breakout can be initiated consistently faster than a breakout performed using the autopilot.

**20.7.7.4 TCAS.** The ATC breakout instruction is the primary means of conflict resolution. TCAS, if installed, provides another form of conflict resolution in the unlikely event other separation standards would fail. TCAS is not required to conduct a closely spaced approach.

The TCAS provides only vertical resolution of aircraft conflicts, while the ATC breakout instruction provides both vertical and horizontal guidance for conflict resolutions. Pilots should always immediately follow the TCAS Resolution Advisory (RA), whenever it is received. Should a TCAS RA be received before, during, or after an ATC breakout instruction is issued, the pilot should follow the RA, even if it conflicts with the climb/descent portion of the breakout maneuver. If following an RA requires deviating from an ATC clearance, the pilot must advise ATC as soon as practical. While following an RA, it is extremely important that the pilot also comply with the turn portion of the ATC breakout instruction unless the pilot determines safety to be a factor. Adhering to these procedures assures the pilot that acceptable “breakout” separation margins will always be provided, even in the face of a normal procedural or system failure.

## 21. Simultaneous Converging Instrument Approaches

**21.1** ATC may conduct instrument approaches simultaneously to converging runways; i.e., runways having an included angle from 15 to 100 degrees, at airports where a program has been specifically approved to do so.

**21.2** The basic concept requires that dedicated, separate standard instrument approach procedures be developed for each converging runway included. These approaches can be identified by the letter “V” in the title; for example, “ILS V Rwy 17 (CONVERGING)”. Missed approach points must be at least 3 miles apart and missed approach procedures ensure that missed approach protected airspace does not overlap.

**21.3** Other requirements are: radar availability, nonintersecting final approach courses, precision approach capability for each runway and, if runways intersect, controllers must be able to apply visual separation as well as intersecting runway separation criteria. Intersecting runways also require minimums of at least 700 foot ceilings and 2 miles visibility. Straight in approaches and landings must be made.

**21.4** Whenever simultaneous converging approaches are in use, aircraft will be informed by the controller as soon as feasible after initial contact or via ATIS. Additionally, the radar controller will have direct communications capability with the tower controller where separation responsibility has not been delegated to the tower.

## 22. Timed Approaches From a Holding Fix

**22.1** Timed approaches may be conducted when the following conditions are met:

**22.1.1** A control tower is in operation at the airport where the approaches are conducted.

**22.1.2** Direct communications are maintained between the pilot and the center/approach controller until the pilot is instructed to contact the tower.

**22.1.3** If more than one missed approach procedure is available, none requires a course reversal.

**22.1.4** If only one missed approach procedure is available, the following conditions are met.

**22.1.4.1** Course reversal is not required.

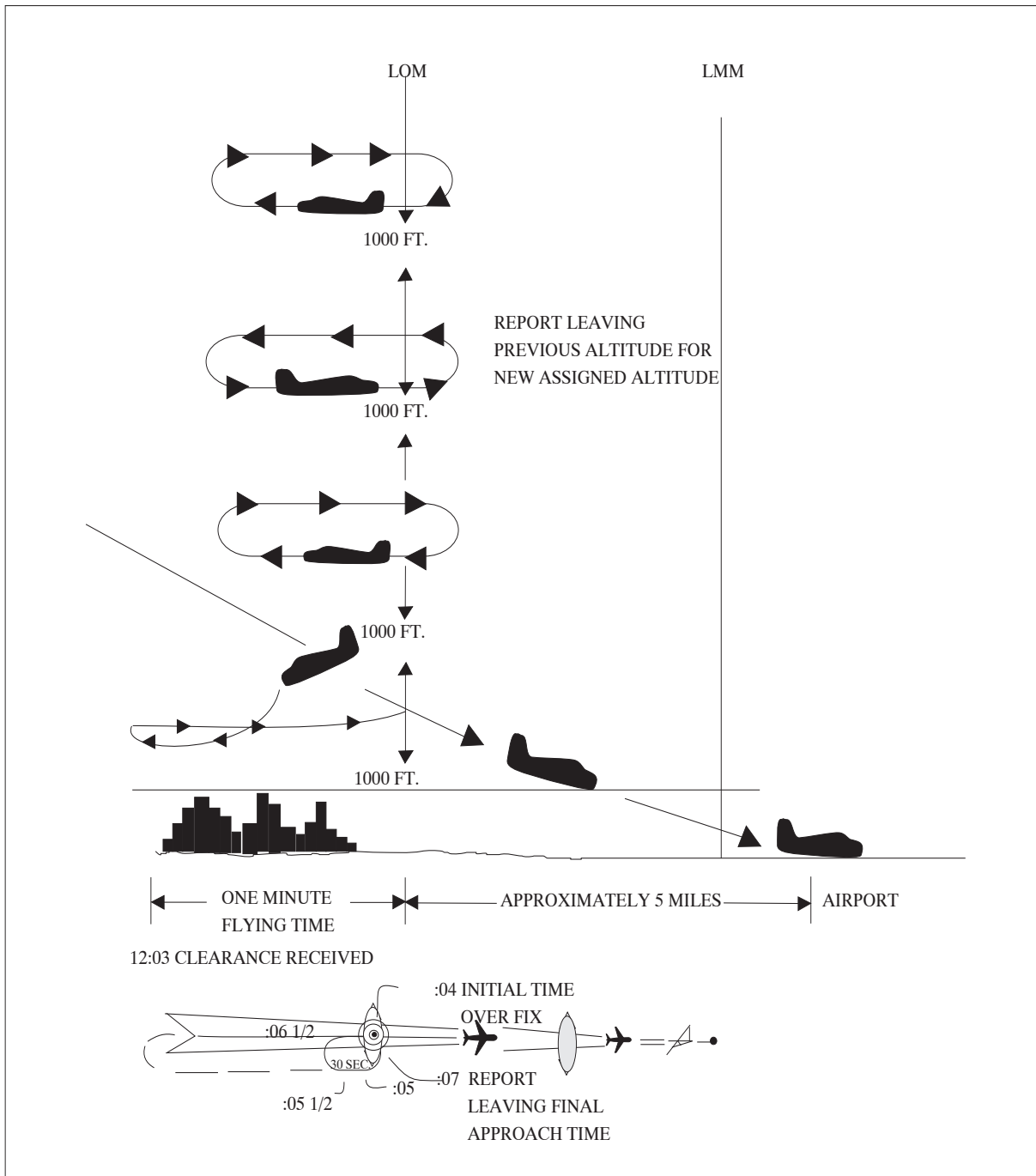
**22.1.4.2** Reported ceiling and visibility are equal to or greater than the highest prescribed circling minimums for the instrument approach procedure.

**22.1.5** When cleared for the approach, pilots must not execute a procedure turn. (See 14 CFR Section 91.175j.)

**22.2** Although the controller will not specifically state that “timed approaches are in use,” the assigning a time to depart the final approach fix inbound (nonprecision approach) or the outer marker or the fix used in lieu of the outer marker inbound (precision approach) is indicative that timed approach procedures are being utilized, or in lieu of holding, the controller may use radar vectors to the final approach course to establish a mileage interval between aircraft that will insure the appropriate time sequence between the final approach fix/outer marker or the fix used in lieu of the outer marker and the airport.

**22.3** Each pilot in an approach sequence will be given advance notice as to the time he/she should leave the holding point on approach to the airport. When a time to leave the holding point has been received, the pilot should adjust his/her flight path to leave the fix as closely as possible to the designated time. (See FIG ENR 1.5-37.)

FIG ENR 1.5-37  
Timed Approaches from a Holding Fix



**EXAMPLE-**

At 12:03 local time, in the example shown, a pilot holding, receives instructions to leave the fix inbound at 12:07. These instructions are received just as the pilot has completed turn at the outbound end of the holding pattern and is proceeding inbound toward the fix. Arriving back over the fix, the pilot notes that the time is 12:04 and that there are 3 minutes to lose in order to leave the fix at the assigned time. Since the time remaining is more than two minutes, the pilot plans to fly a race track pattern rather than a 360 degree turn, which would use up 2 minutes. The turns at the ends of the race track pattern will consume approximately 2 minutes. Three minutes to go, minus 2 minutes required for the turns, leaves 1 minute for level flight. Since two portions of level flight will be required to get back to the fix inbound, the pilot halves the 1 minute remaining

and plans to fly level for 30 seconds outbound before starting the turn back to the fix on final approach. If the winds were negligible at flight altitude, this procedure would bring the pilot inbound across the fix precisely at the specified time of 12:07. However, if expecting headwind on final approach, the pilot should shorten the 30 second outbound course somewhat, knowing that the wind will carry the aircraft away from the fix faster while outbound and decrease the ground speed while returning to the fix. On the other hand, compensating for a tailwind on final approach, the pilot should lengthen the calculated 30 second outbound heading somewhat, knowing that the wind would tend to hold the aircraft closer to the fix while outbound and increase the ground speed while returning to the fix.

### 23. Contact Approach

**23.1** Pilots operating in accordance with an IFR flight plan, provided they are clear of clouds and have at least 1 mile flight visibility and can reasonably expect to continue to the destination airport in those conditions, may request ATC authorization for a “contact approach.”

**23.2** Controllers may authorize a “contact approach” provided:

**23.2.1** The contact approach is specifically requested by the pilot. ATC cannot initiate this approach.

**EXAMPLE–**

*Request contact approach.*

**23.2.2** The reported ground visibility at the destination airport is at least 1 statute mile.

**23.2.3** The contact approach will be made to an airport having a standard or special instrument approach procedure.

**23.2.4** Approved separation is applied between aircraft so cleared and between these aircraft and other IFR or special VFR aircraft.

**EXAMPLE–**

*Cleared contact approach (and if required) at or below (altitude) (routing) if not possible (alternative procedures) and advise.*

**23.3** A contact approach is an approach procedure that may be used by a pilot (with prior authorization from ATC) in lieu of conducting a standard or special instrument approach procedure (IAP) to an airport. It is not intended for use by a pilot on an IFR flight clearance to operate to an airport not having a published and functioning IAP. Nor is it intended for an aircraft to conduct an instrument approach to one airport and then, when “in the clear,” discontinue that approach and proceed to another airport. In the execution of a contact approach, the pilot assumes the responsibility for obstruction clearance. If radar service is being received, it will automatically terminate when the pilot is instructed to change to advisory frequency.

### 24. Use of Enhanced Flight Vision Systems (EFVS) on Instrument Approaches

**24.1 Introduction.** During an instrument approach, an EFVS can enable a pilot to see the approach lights, visual references associated with the runway environment, and other objects or features that might not be visible using natural vision alone. An EFVS uses a head-up display (HUD), or an equivalent display that is a head-up presentation, to combine flight information, flight symbology, navigation guidance, and a real-time image of the external scene to the pilot. Combining the flight information, navigation guidance, and sensor imagery on a HUD (or equivalent display) allows the pilot to continue looking forward along the flightpath throughout the entire approach, landing, and rollout.

An EFVS operation is an operation in which visibility conditions require an EFVS to be used in lieu of natural vision to perform an approach or landing, determine enhanced flight visibility, identify required visual references, or conduct a rollout. There are two types of EFVS operations:

**24.1.1** EFVS operations to touchdown and rollout.

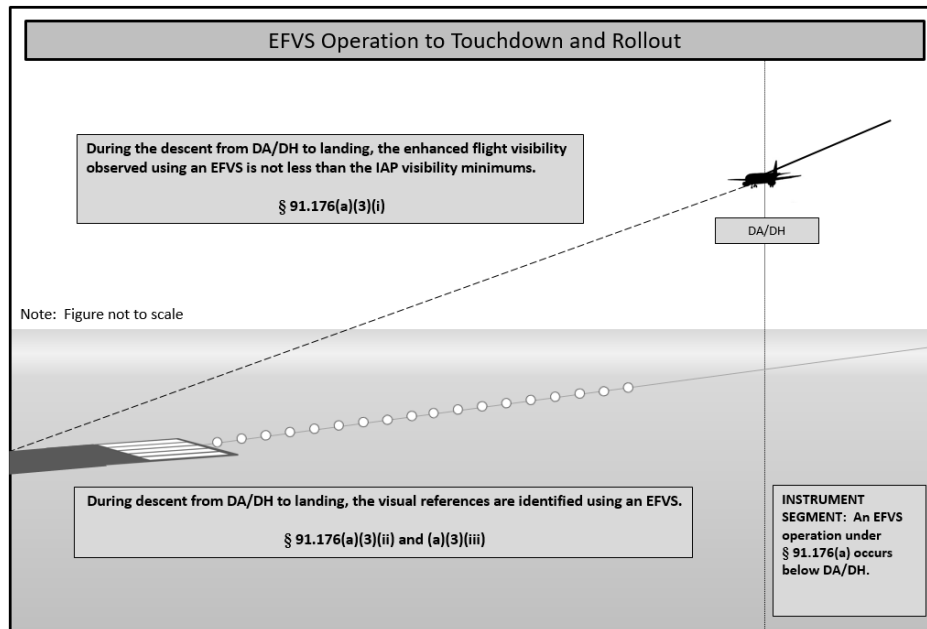
**24.1.2** EFVS operations to 100 feet above the touchdown zone elevation (TDZE).

**24.2 EFVS Operations to Touchdown and Rollout.** An EFVS operation to touchdown and rollout is an operation in which the pilot uses the enhanced vision imagery provided by an EFVS in lieu of natural vision to



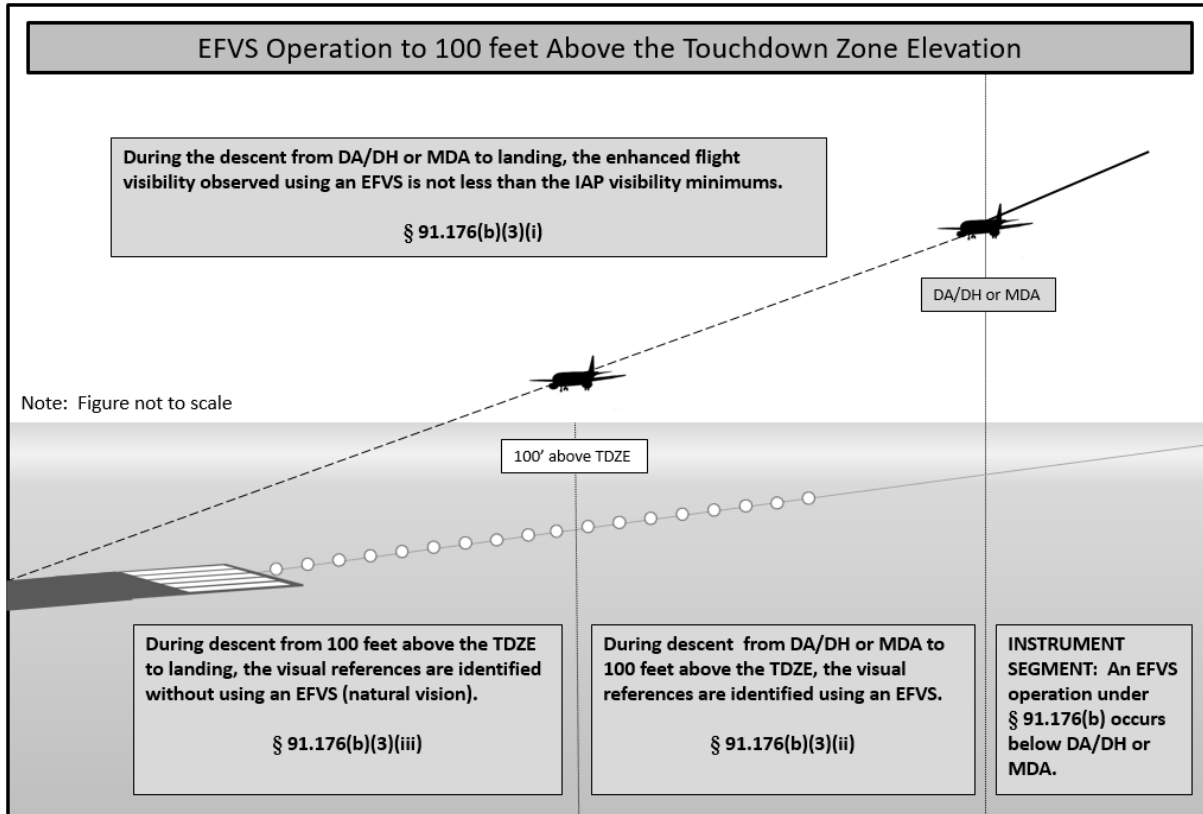
descend below DA or DH to touchdown and rollout. (See FIG ENR 1.5-38.) These operations may be conducted only on Standard Instrument Approach Procedures (SIAP) or special IAPs that have a DA or DH (for example, precision or APV approach). An EFVS operation to touchdown and rollout may not be conducted on an approach that has circling minimums. The regulations for EFVS operations to touchdown and rollout can be found in 14 CFR § 91.176(a).

FIG ENR 1.5-38  
EFVS Operation to Touchdown and Rollout



**24.3 EFVS Operations to 100 Feet Above the TDZE.** An EFVS operation to 100 feet above the TDZE is an operation in which the pilot uses the enhanced vision imagery provided by an EFVS in lieu of natural vision to descend below DA/DH or MDA down to 100 feet above the TDZE. (See FIG ENR 1.5-39.) To continue the approach below 100 feet above the TDZE, a pilot must have sufficient flight visibility to identify the required visual references using natural vision and must continue to use the EFVS to ensure the enhanced flight visibility meets the visibility requirements of the IAP being flown. These operations may be conducted on SIAPs or special IAPs that have a DA/DH or MDA. An EFVS operation to 100 feet above the TDZE may not be conducted on an approach that has circling minimums. The regulations for EFVS operations to 100 feet above the TDZE can be found in 14 CFR § 91.176(b).

FIG ENR 1.5-39  
EFVS Operation to 100 ft Above the TDZE



**24.4 EFVS Equipment Requirements.** An EFVS that is installed on a U.S.–registered aircraft and is used to conduct EFVS operations must conform to an FAA–type design approval (i.e., a type certificate (TC), amended TC, or supplemental type certificate (STC)). A foreign–registered aircraft used to conduct EFVS operations that does not have an FAA–type design approval must be equipped with an EFVS that has been approved by either the State of the Operator or the State of Registry to meet the requirements of ICAO Annex 6. Equipment requirements for an EFVS operation to touchdown and rollout can be found in 14 CFR § 91.176(a)(1), and the equipment requirements for an EFVS operation to 100 feet above the TDZE can be found in 14 CFR § 91.176(b)(1). An operator can determine the eligibility of their aircraft to conduct EFVS operations by referring to the Airplane Flight Manual, Airplane Flight Manual Supplement, Rotorcraft Flight Manual, or Rotorcraft Flight Manual Supplement as applicable.

**24.5 Operating Requirements.** Any operator who conducts EFVS operations to touchdown and rollout (14 CFR § 91.176(a)) must have an OpSpec, MSpec, or LOA that specifically authorizes those operations. Parts 91K, 121, 125, 129, and 135 operators who conduct EFVS operations to 100 feet above the TDZE (14 CFR § 91.176(b)) must have an OpSpec, MSpec, or LOA that specifically authorizes the operation. Part 91 operators (other than 91K operators) are not required to have an LOA to conduct EFVS operations to 100 feet above the TDZE in the United States. However, an optional LOA is available to facilitate operational approval from foreign Civil Aviation Authorities (CAA). To conduct an EFVS operation to touchdown and rollout during an authorized Category II or III operation, the operator must have:

**24.5.1** An OpSpec, MSpec, or LOA authorizing EFVS operations to touchdown and rollout (14 CFR § 91.176(a)); and

**24.5.2** An OpSpec, MSpec, or LOA authorizing Category II or Category III operations.

**24.6 EFVS Operations in Rotorcraft.** Currently, EFVS operations in rotorcraft can only be conducted on IAPs that are flown to a runway. Instrument approach criteria, procedures, and appropriate visual references have not

yet been developed for straight-in landing operations below DA/DH or MDA under IFR to heliports or platforms. An EFVS cannot be used in lieu of natural vision to descend below published minimums on copter approaches to a point in space (PinS) followed by a “proceed visual flight rules (VFR)” visual segment, or on approaches designed to a specific landing site using a “proceed visually” visual segment.

**24.7 EFVS Pilot Requirements.** A pilot who conducts EFVS operations must receive ground and flight training specific to the EFVS operation to be conducted. The training must be obtained from an authorized training provider under a training program approved by the FAA. Additionally, recent flight experience and proficiency or competency check requirements apply to EFVS operations. These requirements are addressed in 14 CFR §§ 61.66, 91.1065, 121.441, Appendix F to Part 121, 125.287, and 135.293.

**24.8 Enhanced Flight Visibility and Visual Reference Requirements.** To descend below DA/DH or MDA during EFVS operations under 14 CFR § 91.176(a) or (b), a pilot must make a determination that the enhanced flight visibility observed by using an EFVS is not less than what is prescribed by the IAP being flown. In addition, the visual references required in 14 CFR § 91.176(a) or (b) must be distinctly visible and identifiable to the pilot using the EFVS. The determination of enhanced flight visibility is a separate action from that of identifying required visual references, and is different from ground-reported visibility. Even though the reported visibility or the visibility observed using natural vision may be less, as long as the EFVS provides the required enhanced flight visibility and a pilot meets all of the other requirements, the pilot can continue descending below DA/DH or MDA using the EFVS. Suitable enhanced flight visibility is necessary to ensure the aircraft is in a position to continue the approach and land. It is important to understand that using an EFVS does not result in obtaining lower minima with respect to the visibility or the DA/DH or MDA specified in the IAP. An EFVS simply provides another means of operating in the visual segment of an IAP. The DA/DH or MDA and the visibility value specified in the IAP to be flown do not change.

**24.9 Flight Planning and Beginning or Continuing an Approach Under IFR.** A Part 121, 125, or 135 operator’s OpSpec or LOA for EFVS operations may authorize an EFVS operational credit dispatching or releasing a flight and for beginning or continuing an instrument approach procedure. When a pilot reaches DA/DH or MDA, the pilot conducts the EFVS operation in accordance with 14 CFR § 91.176(a) or (b) and their authorization to conduct EFVS operations.

**24.10 Missed Approach Considerations.** In order to conduct an EFVS operation, the EFVS must be operable. In the event of a failure of any required component of an EFVS at any point in the approach to touchdown, a missed approach is required. However, this provision does not preclude a pilot’s authority to continue an approach if continuation of an approach is considered by the pilot to be a safer course of action.

**24.11 Light Emitting Diode (LED) Airport Lighting Impact on EFVS Operations.** Incandescent lamps are being replaced with LEDs at some airports in threshold lights, taxiway edge lights, taxiway centerline lights, low intensity runway edge lights, windcone lights, beacons, and some obstruction lighting. Additionally, there are plans to replace incandescent lamps with LEDs in approach lighting systems. Pilots should be aware that LED lights cannot be sensed by infrared-based EFVSs. Further, the FAA does not currently collect or disseminate information about where LED lighting is installed.

**24.12 Other Vision Systems.** Unlike an EFVS that meets the equipment requirements of 14 CFR § 91.176, a Synthetic Vision System (SVS) or Synthetic Vision Guidance System (SVGS) does not provide a real-time sensor image of the outside scene and also does not meet the equipment requirements for EFVS operations. A pilot cannot use a synthetic vision image on a head-up or a head-down display in lieu of natural vision to descend below DA/DH or MDA. An EFVS can, however, be integrated with an SVS, also known as a Combined Vision System (CVS). A CVS can be used to conduct EFVS operations if all of the requirements for an EFVS are satisfied and the SVS image does not interfere with the pilot’s ability to see the external scene, to identify the required visual references, or to see the sensor image.

**24.13 Additional Information.** Operational criteria for EFVS can be found in Advisory Circular (AC) 90–106, Enhanced Flight Vision System Operations, and airworthiness criteria for EFVS can be found in AC 20–167, Airworthiness Approval of Enhanced Vision System, Synthetic Vision System, Combined Vision System, and Enhanced Flight Vision System Equipment.

## 25. Visual Approach

**25.1** A visual approach is conducted on an IFR flight plan and authorizes a pilot to proceed visually and clear of clouds to the airport. The pilot must have either the airport or the preceding identified aircraft in sight. This approach must be authorized and controlled by the appropriate air traffic control facility. Reported weather at the airport must have a ceiling at or above 1,000 feet and visibility 3 miles or greater. ATC may authorize this type of approach when it will be operationally beneficial. Visual approaches are an IFR procedure conducted under Instrument Flight Rules in visual meteorological conditions. Cloud clearance requirements of 14 CFR Section 91.155 are not applicable, unless required by operation specifications. When conducting visual approaches, pilots are encouraged to use other available navigational aids to assist in positive lateral and vertical alignment with the runway.

**25.2 Operating to an Airport Without Weather Reporting Service.** ATC will advise the pilot when weather is not available at the destination airport. ATC may initiate a visual approach provided there is a reasonable assurance that weather at the airport is a ceiling at or above 1,000 feet and visibility 3 miles or greater (e.g., area weather reports, PIREPs, etc.).

**25.3 Operating to an Airport With an Operating Control Tower.** Aircraft may be authorized to conduct a visual approach to one runway while other aircraft are conducting IFR or VFR approaches to another parallel, intersecting, or converging runway. ATC may authorize a visual approach after advising all aircraft involved that other aircraft are conducting operations to the other runway. This may be accomplished through use of the ATIS.

**25.3.1** When operating to parallel runways separated by less than 2,500 feet, ATC will ensure approved separation is provided unless the succeeding aircraft reports sighting the preceding aircraft to the adjacent parallel and visual separation is applied.

**25.3.2** When operating to parallel runways separated by at least 2,500 feet but less than 4,300 feet, ATC will ensure approved separation is provided until the aircraft are issued an approach clearance and one pilot has acknowledged receipt of a visual approach clearance, and the other pilot has acknowledged receipt of a visual or instrument approach clearance, and aircraft are established on a heading or established on a direct course to a fix or cleared on an RNAV/instrument approach procedure which will intercept the extended centerline of the runway at an angle not greater than 30 degrees.

**25.3.3** When operating to parallel runways separated by 4,300 feet or more, ATC will ensure approved separation is provided until one of the aircraft has been issued and the pilot has acknowledged receipt of the visual approach clearance, and each aircraft is assigned a heading, or established on a direct course to a fix, or cleared on an RNAV/instrument approach procedure which will allow the aircraft to intercept the extended centerline of the runway at an angle not greater than 30 degrees.

### **NOTE–**

*The intent of the 30 degree intercept angle is to reduce the potential for overshoots of the final and to preclude side-by-side operations with one or both aircraft in a belly-up configuration during the turn-on.*

**25.4 Clearance for Visual Approach.** At locations with an operating control tower, ATC will issue approach clearances that will include an assigned runway. At locations without an operating control tower or where a part-time tower is closed, ATC will issue a visual approach clearance to the airport only.

**25.5 Separation Responsibilities.** If the pilot has the airport in sight but cannot see the aircraft to be followed, ATC may clear the aircraft for a visual approach; however, ATC retains both separation and wake vortex separation responsibility. When visually following a preceding aircraft, acceptance of the visual approach clearance constitutes acceptance of pilot responsibility for maintaining a safe approach interval and adequate wake turbulence separation.

**25.6** A visual approach is not an IAP and therefore has no missed approach segment. If a go-around is necessary for any reason, aircraft operating at controlled airports will be issued an appropriate clearance or instruction by the tower to enter the traffic pattern for landing or proceed as otherwise instructed. In either case, the pilot is responsible to maintain terrain and obstruction avoidance until reaching an ATC assigned altitude if issued, and

ATC will provide approved separation or visual separation from other IFR aircraft. At uncontrolled airports, aircraft are expected to remain clear of clouds and complete a landing as soon as possible. If a landing cannot be accomplished, the aircraft is expected to remain clear of clouds and contact ATC as soon as possible for further clearance. Separation from other IFR aircraft will be maintained under these circumstances.

**25.7** Visual approaches reduce pilot/controller workload and expedite traffic by shortening flight paths to the airport. It is the pilot's responsibility to advise ATC as soon as possible if a visual approach is not desired.

**25.8** Authorization to conduct a visual approach is an IFR authorization and does not alter IFR flight plan cancellation responsibility. See ENR 1.10, Paragraph 11.2, Canceling IFR Flight Plan.

**25.9** Radar service is automatically terminated, without advising the pilot, when the aircraft is instructed to change to advisory frequency.

## **26. Charted Visual Flight Procedures (CVFPs)**

**26.1** CVFPs are charted visual approaches established for environmental/noise considerations, and/or when necessary for the safety and efficiency of air traffic operations. The approach charts depict prominent landmarks, courses, and recommended altitudes to specific runways. CVFPs are designed to be used primarily for turbojet aircraft.

**26.2** These procedures will be used only at airports with an operating control tower.

**26.3** Most approach charts will depict some NAVAID information which is for supplemental navigational guidance only.

**26.4** Unless indicating a Class B airspace floor, all depicted altitudes are for noise abatement purposes and are recommended only. Pilots are not prohibited from flying other than recommended altitudes if operational requirements dictate.

**26.5** When landmarks used for navigation are not visible at night, the approach will be annotated "PROCEDURE NOT AUTHORIZED AT NIGHT."

**26.6** CVFPs usually begin within 20 flying miles from the airport.

**26.7** Published weather minimums for CVFPs are based on minimum vectoring altitudes rather than the recommended altitudes depicted on charts.

**26.8** CVFPs are not instrument approaches and do not have missed approach segments.

**26.9** ATC will not issue clearances for CVFPs when the weather is less than the published minimum.

**26.10** ATC will clear aircraft for a CVFP after the pilot reports sighting a charted landmark or a preceding aircraft. If instructed to follow a preceding aircraft, pilots are responsible for maintaining a safe approach interval and wake turbulence separation.

**26.11** Pilots should advise ATC if at any point they are unable to continue an approach or lose sight of a preceding aircraft. Missed approaches will be handled as a go-around.

**26.12** When conducting visual approaches, pilots are encouraged to use other available navigational aids to assist in positive lateral and vertical alignment with the assigned runway.

## **27. Missed Approach**

**27.1** When a landing cannot be accomplished, advise ATC and, upon reaching the missed approach point defined on the approach procedure chart, the pilot must comply with the missed approach instructions for the procedure being used or with an alternate missed approach procedure specified by ATC.

**27.2** Obstacle protection for missed approach is predicated on the missed approach being initiated at the decision altitude/decision height (DA/DH) or at the missed approach point and not lower than minimum descent altitude

(MDA). A climb gradient of at least 200 feet per nautical mile is required, (except for Copter approaches, where a climb of at least 400 feet per nautical mile is required), unless a higher climb gradient is published in the notes section of the approach procedure chart. When higher than standard climb gradients are specified, the end point of the non-standard climb will be specified at either an altitude or a fix. Pilots must preplan to ensure that the aircraft can meet the climb gradient (expressed in feet per nautical mile) required by the procedure in the event of a missed approach, and be aware that flying at a higher than anticipated ground speed increases the climb rate requirement (feet per minute). Tables for the conversion of climb gradients (feet per nautical mile) to climb rate (feet per minute), based on ground speed, are included on page D1 of the U.S. Terminal Procedures booklets. Reasonable buffers are provided for normal maneuvers. However, no consideration is given to an abnormally early turn. Therefore, when an early missed approach is executed, pilots should, unless otherwise cleared by ATC, fly the IAP as specified on the approach plate to the missed approach point at or above the MDA or DH before executing a turning maneuver.

**27.3** If visual reference is lost while circling to land from an instrument approach, the missed approach specified for that particular procedure must be followed (unless an alternate missed approach procedure is specified by ATC). To become established on the prescribed missed approach course, the pilot should make an initial climbing turn toward the landing runway and continue the turn until established on the missed approach course. Inasmuch as the circling maneuver may be accomplished in more than one direction, different patterns will be required to become established on the prescribed missed approach course depending on the aircraft position at the time visual reference is lost. Adherence to the procedure will help assure that an aircraft will remain laterally within the circling and missed approach obstruction clearance areas. Refer to paragraph 27.8 concerning vertical obstruction clearance when starting a missed approach at other than the MAP. (See FIG ENR 1.5-40.)

FIG ENR 1.5-40  
Circling and Missed Approach Obstruction Clearance Areas

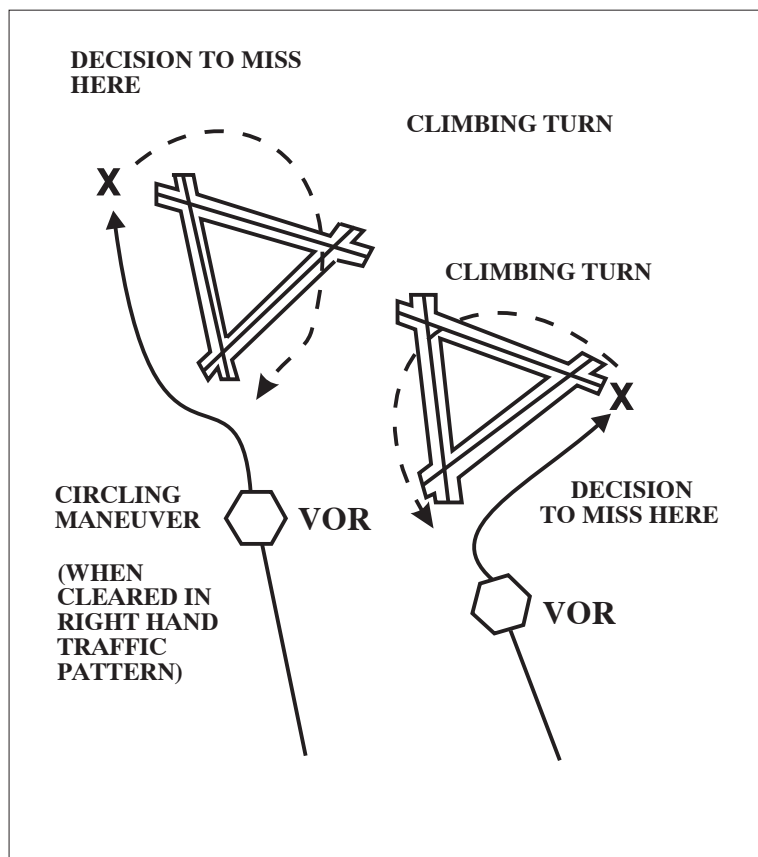


FIG ENR 1.5-41  
Missed Approach

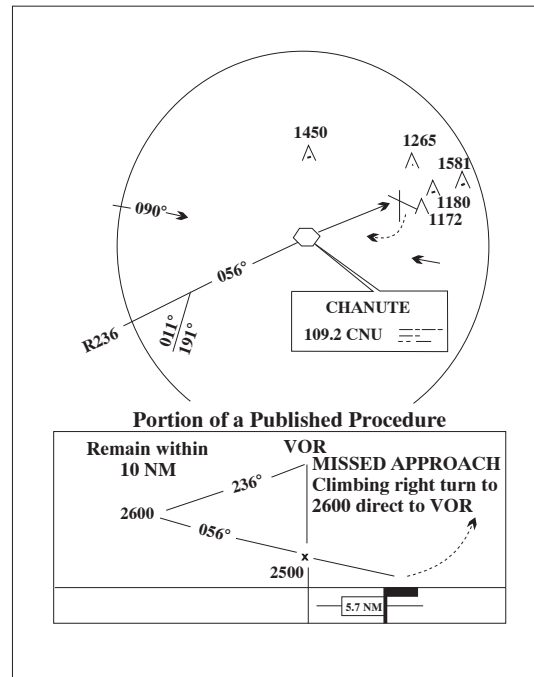
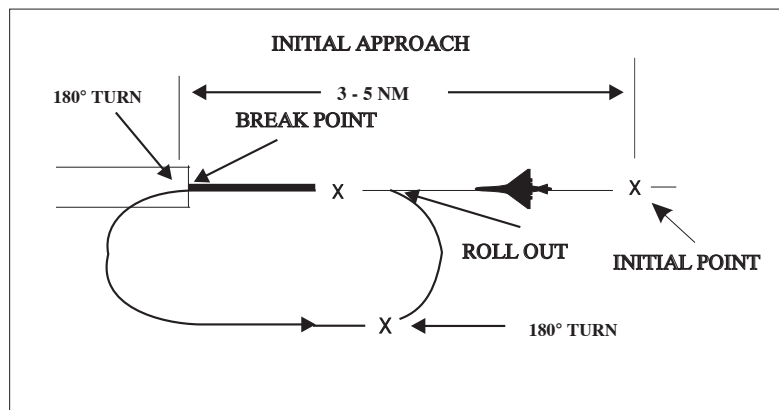


FIG ENR 1.5-42  
Overhead Maneuver



**27.4** At locations where ATC radar service is provided, the pilot should conform to radar vectors when provided by ATC in lieu of the published missed approach procedure.

**27.5** Some locations may have a preplanned alternate missed approach procedure for use in the event the primary NAVAID used for the missed approach procedure is unavailable. To avoid confusion, the alternate missed approach instructions are not published on the chart. However, the alternate missed approach holding pattern will be depicted on the instrument approach chart for pilot situational awareness and to assist ATC by not having to issue detailed holding instructions. The alternate missed approach may be based on NAVAIDs not used in the approach procedure or the primary missed approach. When the alternate missed approach procedure is implemented by NOTAM, it becomes a mandatory part of the procedure. The NOTAM will specify both the textual instructions and any additional equipment requirements necessary to complete the procedure. Air traffic may also issue instructions for the alternate missed approach when necessary, such as when the primary missed approach NAVAID fails during the approach. Pilots may reject an ATC clearance for an alternate missed approach that requires equipment not necessary for the published approach procedure when the alternate missed

approach is issued after beginning the approach. However, when the alternate missed approach is issued prior to beginning the approach the pilot must either accept the entire procedure (including the alternate missed approach), request a different approach procedure, or coordinate with ATC for alternative action to be taken, i.e., proceed to an alternate airport, etc.

**27.6** When the approach has been missed, request a clearance for specific action; i.e., to alternative airport, another approach, etc.

**27.7** Pilots must ensure that they have climbed to a safe altitude prior to proceeding off the published missed approach, especially in nonradar environments. Abandoning the missed approach prior to reaching the published altitude may not provide adequate terrain clearance. Additional climb may be required after reaching the holding pattern before proceeding back to the IAF or to an alternate.

**27.8** A clearance for an instrument approach procedure includes a clearance to fly the published missed approach procedure, unless otherwise instructed by ATC. The published missed approach procedure provides obstacle clearance only when the missed approach is conducted on the missed approach segment from or above the missed approach point, and assumes a climb rate of 200 feet/NM or higher, as published. If the aircraft initiates a missed approach at a point other than the missed approach point (see paragraph 12.2), from below MDA or DA (H), or on a circling approach, obstacle clearance is not necessarily provided by following the published missed approach procedure, nor is separation assured from other air traffic in the vicinity.

In the event a balked (rejected) landing occurs at a position other than the published missed approach point, the pilot should contact ATC as soon as possible to obtain an amended clearance. If unable to contact ATC for any reason, the pilot should attempt to re-intercept a published segment of the missed approach and comply with route and altitude instructions. If unable to contact ATC, and in the pilot's judgment it is no longer appropriate to fly the published missed approach procedure, then consider either maintaining visual conditions if practicable and reattempt a landing, or a circle-climb over the airport. Should a missed approach become necessary when operating to an airport that is not served by an operating control tower, continuous contact with an air traffic facility may not be possible. In this case, the pilot should execute the appropriate go-around/missed approach procedure without delay and contact ATC when able to do so.

Prior to initiating an instrument approach procedure, the pilot should assess the actions to be taken in the event of a balked (rejected) landing beyond the missed approach point or below the MDA or DA (H) considering the anticipated weather conditions and available aircraft performance. 14 CFR 91.175(e) authorizes the pilot to fly an appropriate missed approach procedure that ensures obstruction clearance, but it does not necessarily consider separation from other air traffic. The pilot must consider other factors such as the aircraft's geographical location with respect to the prescribed missed approach point, direction of flight, and/or minimum turning altitudes in the prescribed missed approach procedure. The pilot must also consider aircraft performance, visual climb restrictions, charted obstacles, published obstacle departure procedure, takeoff visual climb requirements as expressed by nonstandard takeoff minima, other traffic expected to be in the vicinity, or other factors not specifically expressed by the approach procedures.

## **28. Overhead Approach Maneuver**

**28.1** Pilots operating in accordance with an IFR flight plan in Visual Meteorological Conditions (VMC) may request ATC authorization for an overhead maneuver. An overhead maneuver is not an instrument approach procedure. Overhead maneuver patterns are developed at airports where aircraft have an operational need to conduct the maneuver. An aircraft conducting an overhead maneuver is considered to be VFR and the IFR flight plan is canceled when the aircraft reaches the initial point on the initial approach portion of the maneuver. (See FIG ENR 1.5–42.) The existence of a standard overhead maneuver pattern does not eliminate the possible requirement for an aircraft to conform to conventional rectangular patterns if an overhead maneuver cannot be approved. Aircraft operating to an airport without a functioning control tower must initiate cancellation of an IFR flight plan prior to executing the overhead maneuver. Cancellation of the IFR flight plan must be accomplished after crossing the landing threshold on the initial portion of the maneuver or after landing. Controllers may authorize an overhead maneuver and issue the following to arriving aircraft:



**28.1.1** Pattern altitude and direction of traffic. This information may be omitted if either is standard.

**PHRASEOLOGY-**

*PATTERN ALTITUDE (altitude). RIGHT TURNS.*

**28.1.2** Request for a report on initial approach.

**PHRASEOLOGY-**

*REPORT INITIAL.*

**28.1.3** “Break” information and a request for the pilot to report. The “Break Point” will be specified if nonstandard. Pilots may be requested to report “break” if required for traffic or other reasons.

**PHRASEOLOGY-**

*BREAK AT (specified point).*

*REPORT BREAK.*

## **29. Departure Procedures**

### **29.1 Pre-Taxi Clearance Procedures**

**29.1.1** Locations where these procedures are in effect are indicated in the Chart Supplement U.S.

**29.1.2** Certain airports have established programs whereby pilots of departing IFR aircraft may elect to receive their IFR clearances before they start taxiing for takeoff. The following provisions are included in such procedures:

**29.1.2.1** Pilot participation is not mandatory.

**29.1.2.2** Participating pilots call clearance delivery/ground control not more than 10 minutes before proposed taxi time.

**29.1.2.3** IFR clearance (or delay information, if clearance cannot be obtained) is issued at the time of this initial call-up.

**29.1.2.4** When the IFR clearance is received on clearance delivery frequency, pilots call ground control when ready to taxi.

**29.1.2.5** Normally, pilots need not inform ground control that they have received IFR clearance on clearance delivery frequency. Certain locations may, however, require that the pilot inform ground control of a portion of the routing or that the IFR clearance has been received.

**29.1.2.6** If a pilot cannot establish contact on clearance delivery frequency or has not received an IFR clearance before ready to taxi, the pilot should contact ground control and inform the controller accordingly.

### **30. Automated Pre-Departure Clearance Procedures**

**30.1** Many airports in the National Airspace System are equipped with the Terminal Data Link System (TDLS) that includes the Pre-Departure Clearance (PDC) and Controller Pilot Data Link Communication-Departure Clearance (CPDLC-DCL) functions. Both the PDC and CPDLC-DCL functions automate the Clearance Delivery operations in the ATCT for participating users. Both functions display IFR clearances from the ARTCC to the ATCT. The Clearance Delivery controller in the ATCT can append local departure information and transmit the clearance via data link to participating airline/service provider computers for PDC. The airline/service provider will then deliver the clearance via the Aircraft Communications Addressing and Reporting System (ACARS) or a similar data link system, or for non-data link equipped aircraft, via a printer located at the departure gate. For CPDLC-DCL, the departure clearance is uplinked from the ATCT via the Future Air Navigation System (FANS) to the aircraft avionics and requires a response from the flight crew. Both PDC and CPDLC-DCL reduce frequency congestion, controller workload, and are intended to mitigate delivery/read back errors.

**30.2** Both services are available only to participating aircraft that have subscribed to the service through an approved service provider.

**30.3** In all situations, the pilot is encouraged to contact clearance delivery if a question or concern exists regarding an automated clearance. Due to technical reasons, the following limitations/differences exist between the two services:

**30.3.1 PDC**

**30.3.1.1** Aircraft filing multiple flight plans are limited to one PDC clearance per departure airport within a 24-hour period. Additional clearances will be delivered verbally.

**30.3.1.2** If the clearance is revised or modified prior to delivery, it will be rejected from PDC and the clearance will need to be delivered verbally.

**30.3.1.3** No acknowledgment of receipt or read back is required for a PDC.

**30.3.2 CPDLC–DCL**

**30.3.2.1** No limitation to the number of clearances received.

**30.3.2.2** Allows delivery of revised flight data, including revised departure clearances.

**30.3.2.3** A response from the flight crew is required.

**30.3.2.4** Requires a logon to the FAA National Single Data Authority – KUSA – utilizing the ATC FANS application.

**30.3.2.5** To be eligible, operators must have received CPDLC/FANS authorization from the responsible civil aviation authority, and file appropriate equipment information in ICAO field 10a and in the ICAO field 18 DAT (Other Data Applications) of the flight plan.

**31. IFR Clearances Off Uncontrolled Airports**

**31.1** Pilots departing on an IFR flight plan should consult the Chart Supplement U.S. to determine the frequency or telephone number to use to contact clearance delivery. On initial contact, pilots should advise that the flight is IFR and state the departure and destination airports.

**31.2** Air traffic facilities providing clearance delivery services via telephone will have their telephone number published in the Chart Supplement U.S. of that airport’s entry. This same section may also contain a telephone number to use for cancellation of an IFR flight plan after landing.

**31.3** Except in Alaska, pilots of MEDEVAC flights may obtain a clearance by calling 1–877–543–4733.

**32. Taxi Clearance**

**32.1** Pilots on IFR flight plans should communicate with the control tower on the appropriate ground control/clearance delivery frequency prior to starting engines to receive engine start time, taxi, and/or clearance information.

**33. Line Up and Wait (LUAW)**

**33.1** Line up and wait is an air traffic control (ATC) procedure designed to position an aircraft onto the runway for an imminent departure. The ATC instruction “LINE UP AND WAIT” is used to instruct a pilot to taxi onto the departure runway and line up and wait.

**EXAMPLE–**

*Tower: “N234AR Runway 24L, line up and wait.”*

**33.2** This ATC instruction is not an authorization to takeoff. In instances where the pilot has been instructed to “line up and wait” and has been advised of a reason/condition (wake turbulence, traffic on an intersecting runway, etc.) or the reason/condition is clearly visible (another aircraft that has landed on or is taking off on the same runway), and the reason/condition is satisfied, the pilot should expect an imminent takeoff clearance, unless advised of a delay. If you are uncertain about any ATC instruction or clearance, contact ATC immediately.

**33.3** If a takeoff clearance is not received within a reasonable amount of time after clearance to line up and wait, ATC should be contacted.

**EXAMPLE–**

*Aircraft: Cessna 234AR holding in position Runway 24L.*

*Aircraft: Cessna 234AR holding in position Runway 24L at Bravo.*

**NOTE–**

*FAA analysis of accidents and incidents involving aircraft holding in position indicate that two minutes or more elapsed between the time the instruction was issued to “line up and wait” and the resulting event (for example, landover or go-around). Pilots should consider the length of time that they have been holding in position whenever they HAVE NOT been advised of any expected delay to determine when it is appropriate to query the controller.*

**REFERENCE–**

*Advisory Circulars 91–73A, Part 91 and Part 135 Single–Pilot Procedures during Taxi Operations, and 120–74A, Parts 91, 121, 125, and 135 Flightcrew Procedures during Taxi Operations.*

**33.4** Situational awareness during line up and wait operations is enhanced by monitoring ATC instructions/clearances issued to other aircraft. Pilots should listen carefully if another aircraft is on frequency that has a similar call sign and pay close attention to communications between ATC and other aircraft. If you are uncertain of an ATC instruction or clearance, query ATC immediately. Care should be taken to not inadvertently execute a clearance/instruction for another aircraft.

**33.5** Pilots should be especially vigilant when conducting “line up and wait” operations at night or during reduced visibility conditions. They should scan the full length of the runway and look for aircraft on final approach or landing roll out when taxiing onto a runway. ATC should be contacted anytime there is a concern about a potential conflict.

**33.6** When two or more runways are active, aircraft may be instructed to “LINE UP AND WAIT” on two or more runways. When multiple runway operations are being conducted, it is important to listen closely for your call sign and runway. Be alert for similar sounding call signs and acknowledge all instructions with your call sign. When you are holding in position and are not sure if the takeoff clearance was for you, ask ATC before you begin takeoff roll. ATC prefers that you confirm a takeoff clearance rather than mistake another aircraft’s clearance for your own.

**33.7** When ATC issues intersection “line up and wait” and takeoff clearances, the intersection designator will be used. If ATC omits the intersection designator, call ATC for clarification.

**EXAMPLE–**

*Aircraft: “Cherokee 234AR, Runway 24L at November 4, line up and wait.”*

**33.8** If landing traffic is a factor during line up and wait operations, ATC will inform the aircraft in position of the closest traffic within 6 flying miles requesting a full–stop, touch–and–go, stop–and–go, or an unrestricted low approach to the same runway. Pilots should take care to note the position of landing traffic. ATC will also advise the landing traffic when an aircraft is authorized to “line up and wait” on the same runway.

**EXAMPLE–**

*Tower: “Cessna 234AR, Runway 24L, line up and wait. Traffic a Boeing 737, six mile final.”*

*Tower: “Delta 1011, continue, traffic a Cessna 210 holding in position Runway 24L.”*

**NOTE–**

*ATC will normally withhold landing clearance to arrival aircraft when another aircraft is in position and holding on the runway.*

**33.9** Never land on a runway that is occupied by another aircraft, even if a landing clearance was issued. Do not hesitate to ask the controller about the traffic on the runway and be prepared to execute a go-around.

**NOTE–**

*Always clarify any misunderstanding or confusion concerning ATC instructions or clearances. ATC should be advised immediately if there is any uncertainty about the ability to comply with any of their instructions.*

## 34. Departure Restrictions, Clearance Void Times, Hold for Release, and Release Times

**34.1** ATC may assign departure restrictions, clearance void times, hold for release, and release times, when necessary, to separate departures from other traffic or to restrict or regulate the departure flow. Departures from an airport without an operating control tower must be issued either a departure release (along with a release time and/or void time if applicable), or a hold for release.

**REFERENCE–**

FAA Order JO 7110.65, Para 4–3–4, *Departure Release, Hold for Release, Release Times, Departure Restrictions, and Clearance Void Times.*

**34.1.1 Clearance Void Times.** A pilot may receive a clearance, when operating from an airport without a control tower, which contains a provision for the clearance to be void if not airborne by a specific time. A pilot who does not depart prior to the clearance void time must advise ATC as soon as possible of his or her intentions. ATC will normally advise the pilot of the time allotted to notify ATC that the aircraft did not depart prior to the clearance void time. This time cannot exceed 30 minutes. Failure of an aircraft to contact ATC within 30 minutes after the clearance void time will result in the aircraft being considered overdue and search and rescue procedures initiated.

**NOTE–**

1. *Other IFR traffic for the airport where the clearance is issued is suspended until the aircraft has contacted ATC or until 30 minutes after the clearance void time or 30 minutes after the clearance release time if no clearance void time is issued.*
2. *If the clearance void time expires, it does not cancel the departure clearance or IFR flight plan. It withdraws the pilot's authority to depart IFR until a new departure release/release time has been issued by ATC and is acknowledged by the pilot.*
3. *Pilots who depart at or after their clearance void time are not afforded IFR separation, and may be in violation of 14 CFR Section 91.173, which requires that pilots receive an appropriate ATC clearance before operating IFR in controlled airspace.*
4. *Pilots who choose to depart VFR after their clearance void time has expired should not depart using the previously assigned IFR transponder code.*

**EXAMPLE–**

*Clearance void if not off by (clearance void time) and, if required, if not off by (clearance void time) advise (facility) not later than (time) of intentions.*

**34.1.2 Hold for Release.** ATC may issue “hold for release” instructions in a clearance to delay an aircraft’s departure for traffic management reasons (i.e., weather, traffic volume, etc.). When ATC states in the clearance, “hold for release,” the pilot may not depart utilizing that IFR clearance until a release time or additional instructions are issued by ATC. In addition, ATC will include departure delay information in conjunction with “hold for release” instructions. The ATC instruction, “hold for release,” applies to the IFR clearance and does not prevent the pilot from departing under VFR. However, prior to takeoff the pilot should cancel the IFR flight plan and operate the transponder/ADS–B on the appropriate VFR code. An IFR clearance may not be available after departure.

**EXAMPLE–**

*(Aircraft identification) cleared to (destination) airport as filed, maintain (altitude), and, if required (additional instructions or information), hold for release, expect (time in hours and/or minutes) departure delay.*

**34.1.3 Release Times.** A “release time” is a departure restriction issued to a pilot by ATC, specifying the earliest time an aircraft may depart. ATC will use “release times” in conjunction with traffic management procedures and/or to separate a departing aircraft from other traffic.

**EXAMPLE–**

*(Aircraft identification) released for departure at (time in hours and/or minutes).*

**34.1.4 Expect Departure Clearance Time (EDCT).** The EDCT is the runway release time assigned to an aircraft included in traffic management programs. Aircraft are expected to depart no earlier than 5 minutes before, and no later than 5 minutes after the EDCT.

**34.2** If practical, pilots departing uncontrolled airports should obtain IFR clearances prior to becoming airborne when two–way communication with the controlling ATC facility is available.

## 35. Departure Control

**35.1** Departure Control is an approach control function responsible for ensuring separation between departures. So as to expedite the handling of departures, Departure Control may suggest a takeoff direction other than that which may normally have been used under VFR handling. Many times it is preferred to offer the pilot a runway that will require the fewest turns after takeoff to place the pilot on course or selected departure route as quickly as possible. At many locations particular attention is paid to the use of preferential runways for local noise abatement programs, and route departures away from congested areas.

**35.2** Departure Control utilizing radar will normally clear aircraft out of the terminal area using vectors, a diverse vector area (DVA), or published DPs.

**35.2.1** When a departure is to be vectored immediately following takeoff using vectors, a DVA, or published DPs that begins with an ATC assigned heading off the ground, the pilot will be advised prior to takeoff of the initial heading to be flown but may not be advised of the purpose of the heading. When ATC assigns an initial heading with the takeoff clearance that will take the aircraft off an assigned procedure (for example, an RNAV SID with a published lateral path to a waypoint and crossing restrictions from the departure end of runway), the controller will assign an altitude to maintain with the initial heading and, if necessary, a speed to maintain.

**35.2.2** At some airports when a departure will fly an RNAV SID that begins at the runway, ATC may advise aircraft of the initial fix/waypoint on the RNAV route. The purpose of the advisory is to remind pilots to verify the correct procedure is programmed in the FMS before takeoff. Pilots must immediately advise ATC if a different RNAV SID is entered in the aircraft's FMC. When this advisory is absent, pilots are still required to fly the assigned SID as published.

**EXAMPLE–**

*Delta 345 RNAV to MPASS, Runway 26L, cleared for takeoff.*

**NOTE–**

1. *The SID transition is not restated as it is contained in the ATC clearance.*
2. *Aircraft cleared via RNAV SIDs designed to begin with a vector to the initial waypoint are assigned a heading before departure.*

**35.2.3** Pilots operating in a radar environment are expected to associate departure headings or an RNAV departure advisory with vectors or the flight path to their planned route or flight. When given a vector taking the aircraft off a previously assigned nonradar route, the pilot will be advised briefly what the vector is to achieve. Thereafter, radar service will be provided until the aircraft has been reestablished “on-course” using an appropriate navigation aid and the pilot has been advised of the aircraft's position or a handoff is made to another radar controller with further surveillance capabilities.

**35.3** Controllers will inform pilots of the departure control frequencies and, if appropriate, the transponder code before takeoff. Pilots must ensure their transponder/ADS–B is adjusted to the “on” or normal operating position as soon as practical and remain on during all operations unless otherwise requested to change to “standby” by ATC. Pilots should not change to the departure control frequency until requested. Controllers may omit the departure control frequency if a DP has or will be assigned and the departure control frequency is published on the DP.

## 36. Abbreviated IFR Departure Clearance (Cleared . . . as Filed) Procedures

**36.1** ATC facilities will issue an abbreviated IFR departure clearance based on the ROUTE of flight filed in the IFR flight plan, provided the filed route can be approved with little or no revision. These abbreviated clearance procedures are based on the following conditions:

**36.1.1** The aircraft is on the ground or it has departed VFR and the pilot is requesting IFR clearance while airborne.

**36.1.2** That a pilot will not accept an abbreviated clearance if the route or destination of a flight plan filed with ATC has been changed by him/her or the company or the operations officer before departure.

**36.1.3** That it is the responsibility of the company or operations office to inform the pilot when they make a change to the filed flight plan.

**36.1.4** That it is the responsibility of the pilot to inform ATC in the initial call–up (for clearance) when the filed flight plan has been either:

**36.1.4.1** Amended.

**36.1.4.2** Canceled and replaced with a new filed flight plan.

**NOTE–**

*The facility issuing a clearance may not have received the revised route or the revised flight plan by the time a pilot requests clearance.*

**36.2** Controllers will issue a detailed clearance when they know that the original filed flight plan has been changed or when the pilot requests a full route clearance.

**36.3** The clearance as issued will include the destination airport filed in the flight plan.

**36.4** ATC procedures now require the controller to state the DP name, the current number and the DP Transition name after the phrase “Cleared to (destination) airport,” and prior to the phrase, “then as filed,” for ALL departure clearances when the DP or DP Transition is to be flown. The procedure applies whether or not the DP is filed in the flight plan.

**36.5** Standard Terminal Arrivals (STARs), when filed in a flight plan, are considered a part of the filed route of flight and will not normally be stated in an initial departure clearance. If the ARTCC’s jurisdictional airspace includes both the departure airport and the fix where a STAR or STAR Transition begins, the STAR name, the current number, and the STAR Transition name MAY be stated in the initial clearance.

**36.6** “Cleared to (destination) airport as filed” does NOT include the en route altitude filed in a flight plan. An en route altitude will be stated in the clearance or the pilot will be advised to expect an assigned/filed altitude within a given time frame or at a certain point after departure. This may be done verbally in the departure instructions or stated in the DP.

**36.7** In a radar and a nonradar environment, the controller will state “Cleared to (destination) airport as filed” or:

**36.7.1** If a DP or DP Transition is to be flown, specify the DP name, the current DP number, the DP Transition name, the assigned altitude/flight level, and any additional instructions (departure control frequency, beacon code assignment, etc.) necessary to clear a departing aircraft via the DP/DP Transition and the route filed.

**EXAMPLE–**

*National Seven Twenty cleared to Miami Airport Intercontinental one departure, Lake Charles transition then as filed, maintain Flight Level two seven zero.*

**36.7.2** When there is no DP or when the pilot cannot accept a DP, specify the assigned altitude/flight level, and any additional instructions necessary to clear a departing aircraft via an appropriate departure routing and the route filed.

**NOTE–**

*A detailed departure route description or a radar vector may be used to achieve the desired departure routing.*

**36.7.3** If necessary to make a minor revision to the filed route, specify the assigned DP/DP Transition (or departure routing), the revision to the filed route, the assigned altitude/flight level, and any additional instructions necessary to clear a departing aircraft.

**EXAMPLE–**

*Jet Star One Four Two Four cleared to Atlanta Airport, South Boston two departure then as filed except change route to read South Boston Victor 20 Greensboro, maintain one seven thousand.*

**36.7.4** Additionally, in a nonradar environment, specify one or more fixes as necessary to identify the initial route of flight.

**EXAMPLE–**

*Cessna Three One Six Zero Foxtrot cleared to Charlotte Airport as filed via Brooke, maintain seven thousand.*

**36.8** To ensure success of the program, pilots should:

**36.8.1** Avoid making changes to a filed flight plan just prior to departure.

**36.8.2** State the following information in the initial call–up to the facility when no change has been made to the filed flight plan: Aircraft call sign, location, type operation (IFR), and the name of the airport (or fix) to which you expect clearance.

**EXAMPLE–**

*“Washington clearance delivery (or ground control if appropriate) American Seventy Six at gate one, IFR Los Angeles.”*

**36.8.3** If the flight plan has been changed, state the change and request a full route clearance.

**EXAMPLE–**

*“Washington clearance delivery, American Seventy Six at gate one. IFR San Francisco. My flight plan route has been amended (or destination changed). Request full route clearance.”*

**36.8.4** Request verification or clarification from ATC if ANY portion of the clearance is not clearly understood.

**36.8.5** When requesting clearance for the IFR portion of a VFR–IFR flight, request such clearance prior to the fix where IFR operation is proposed to commence in sufficient time to avoid delay. Use the following phraseology:

**EXAMPLE–**

*“Los Angeles center, Apache Six One Papa, VFR estimating Paso Robles VOR at three two, one thousand five hundred, request IFR to Bakersfield.”*

**37. Instrument Departure Procedures (DP) – Obstacle Departure Procedures (ODP), Standard Instrument Departures (SID), and Diverse Vector Areas (DVA)**

**37.1** Instrument departure procedures are preplanned instrument flight rule (IFR) procedures which provide obstruction clearance from the terminal area to the appropriate en route structure. There are two types of DPs, Obstacle Departure Procedures (ODP), printed either textually or graphically, and Standard Instrument Departures (SID), always printed graphically. All DPs, either textual or graphic may be designed using either conventional or RNAV criteria. RNAV procedures will have RNAV printed in the title; for example, SHEAD TWO DEPARTURE (RNAV). ODPs provide obstruction clearance via the least onerous route from the terminal area to the appropriate en route structure. ODPs are recommended for obstruction clearance and may be flown without ATC clearance unless an alternate departure procedure (SID or radar vector) has been specifically assigned by ATC. Graphic ODPs will have (OBSTACLE) printed in the procedure title; for example, GEYSR THREE DEPARTURE (OBSTACLE), or, CROWN ONE DEPARTURE (RNAV) (OBSTACLE). Standard Instrument Departures are air traffic control (ATC) procedures printed for pilot/controller use in graphic form to provide obstruction clearance and a transition from the terminal area to the appropriate en route structure. SIDs are primarily designed for system enhancement and to reduce pilot/controller workload. ATC clearance must be received prior to flying a SID. All DPs provide the pilot with a way to depart the airport and transition to the en route structure safely.

**37.2** A Diverse Vector Area (DVA) is an area in which ATC may provide random radar vectors during an uninterrupted climb from the departure runway until above the MVA/MIA, established in accordance with the TERPS criteria for diverse departures. The DVA provides obstacle and terrain avoidance in lieu of taking off from the runway under IFR using an ODP or SID.

**37.3** Pilots operating under 14 CFR Part 91 are strongly encouraged to file and fly a DP at night, during marginal Visual Meteorological Conditions (VMC) and Instrument Meteorological Conditions (IMC), when one is available. The following paragraphs will provide an overview of the DP program, why DPs are developed, what criteria are used, where to find them, how they are to be flown, and finally pilot and ATC responsibilities.

**37.4** Why are DPs necessary? The primary reason is to provide obstacle clearance protection information to pilots. A secondary reason, at busier airports, is to increase efficiency and reduce communications and departure

delays through the use of SIDs. When an instrument approach is initially developed for an airport, the need for DPs is assessed. The procedure designer conducts an obstacle analysis to support departure operations. If an aircraft may turn in any direction from a runway within the limits of the assessment area (see paragraph 37.5.3) and remain clear of obstacles, that runway passes what is called a diverse departure assessment and no ODP will be published. A SID may be published if needed for air traffic control purposes. However, if an obstacle penetrates what is called the 40:1 obstacle identification surface, then the procedure designer chooses whether to:

**37.4.1** Establish a steeper than normal climb gradient; or

**37.4.2** Establish a steeper than normal climb gradient with an alternative that increases takeoff minima to allow the pilot to visually remain clear of the obstacle(s); or

**37.4.3** Design and publish a specific departure route; or

**37.4.4** A combination or all of the above.

**37.5** What criteria is used to provide obstruction clearance during departure?

**37.5.1** Unless specified otherwise, required obstacle clearance for all departures, including diverse, is based on the pilot crossing the departure end of the runway at least 35 feet above the departure end of runway elevation, climbing to 400 feet above the departure end of runway elevation before making the initial turn, and maintaining a minimum climb gradient of 200 feet per nautical mile (FPNM), unless required to level off by a crossing restriction, until the minimum IFR altitude. A greater climb gradient may be specified in the DP to clear obstacles or to achieve an ATC crossing restriction. If an initial turn higher than 400 feet above the departure end of runway elevation is specified in the DP, the turn should be commenced at the higher altitude. If a turn is specified at a fix, the turn must be made at that fix. Fixes may have minimum and/or maximum crossing altitudes that must be adhered to prior to passing the fix. In rare instances, obstacles that exist on the extended runway centerline may make an “early turn” more desirable than proceeding straight ahead. In these cases, the published departure instructions will include the language “turn left(right) as soon as practicable.” These departures will also include a ceiling and visibility minimum of at least 300 and 1. Pilots encountering one of these DPs should preplan the climb out to gain altitude and begin the turn as quickly as possible within the bounds of safe operating practices and operating limitations. This type of departure procedure is being phased out.

**NOTE–**

*“Practical” or “feasible” may exist in some existing departure text instead of “practicable.”*

**37.5.2** ODPs, SIDs, and DVAs assume normal aircraft performance, and that all engines are operating. Development of contingency procedures, required to cover the case of an engine failure or other emergency in flight that may occur after liftoff, is the responsibility of the operator. (More detailed information on this subject is available in Advisory Circular AC 120–91, Airport Obstacle Analysis, and in the “Departure Procedures” section of chapter 2 in the Instrument Procedures Handbook, FAA–H–8083–16.)

**37.5.3** The 40:1 obstacle identification surface (OIS) begins at the departure end of runway (DER) and slopes upward at 152 FPNM until reaching the minimum IFR altitude or entering the en route structure. This assessment area is limited to 25 NM from the airport in nonmountainous areas and 46 NM in designated mountainous areas. Beyond this distance, the pilot is responsible for obstacle clearance if not operating on a published route, if below (having not reached) the MEA or MOCA of a published route, or an ATC assigned altitude. See FIG ENR 1.5–43. (Ref 14 CFR 91.177 for further information on en route altitudes.)

**NOTE–**

*ODPs are normally designed to terminate within these distance limitations, however, some ODPs will contain routes that may exceed 25/46 NM; these routes will insure obstacle protection until reaching the end of the ODP.*

**37.5.4** Obstacles that are located within 1 NM of the DER and penetrate the 40:1 OCS are referred to as “low, close-in obstacles.” The standard required obstacle clearance (ROC) of 48 feet per NM to clear these obstacles would require a climb gradient greater than 200 feet per NM for a very short distance, only until the aircraft was 200 feet above the DER. To eliminate publishing an excessive climb gradient, the obstacle AGL/MSL height and

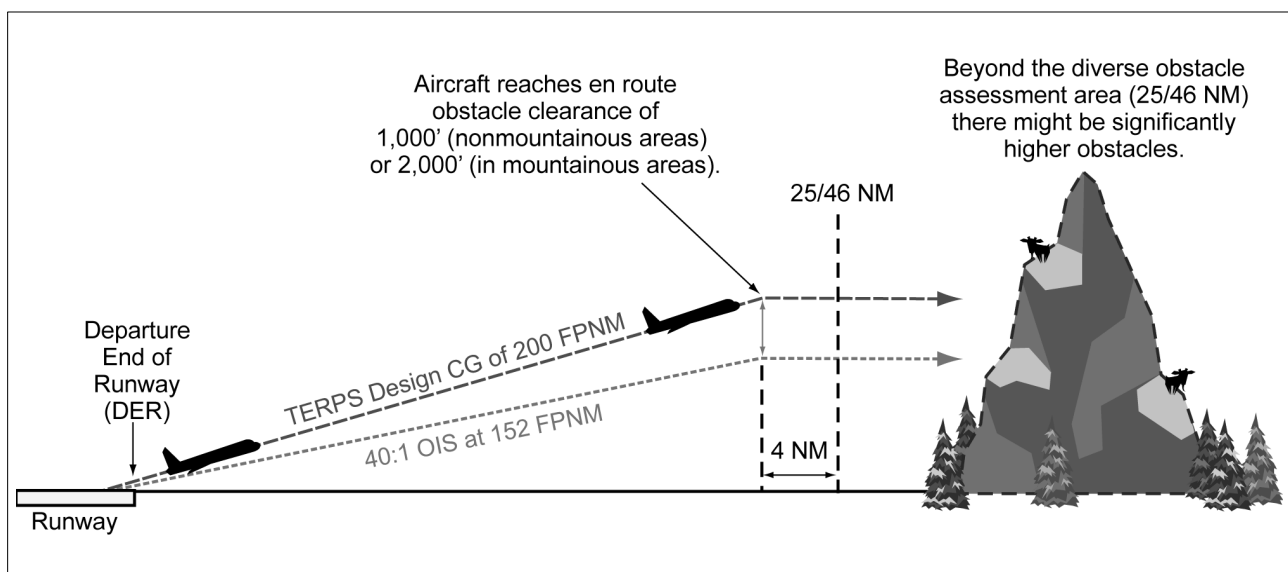


location relative to the DER is noted in the “Take-off Minimums and (OBSTACLE) Departure Procedures” section of a given Terminal Procedures Publication (TPP) booklet.

**37.5.4.1** Pilots must refer to the TPP booklet or the Graphic ODP for information on these obstacles. These obstacle notes will no longer be published on SIDs. Pilots assigned a SID for departure must refer to the airport entry in the TPP to obtain information on these obstacles.

**37.5.4.2** The purpose of noting obstacles in the “Take-off Minimums and (OBSTACLE) Departure Procedures” section of the TPP is to identify the obstacle(s) and alert the pilot to the height and location of the obstacle(s) so they can be avoided. This can be accomplished in a variety of ways; for example, the pilot may be able to see the obstruction and maneuver around the obstacle(s) if necessary; early liftoff/climb performance may allow the aircraft to cross well above the obstacle(s); or if the obstacle(s) cannot be visually acquired during departure, preflight planning should take into account what turns or other maneuvers may be necessary immediately after takeoff to avoid the obstruction(s).

FIG ENR 1.5–43  
Diverse Departure Obstacle Assessment to 25/46 NM



**EXAMPLE–**

**TAKEOFF OBSTACLE NOTES:** Rwy 14, trees 2011' from DER, 29' left of centerline, 100' AGL/3829' MSL. Rwy 32, trees 1009' from DER, 697' left of centerline, 100' AGL/3839' MSL. Tower 4448' from DER, 1036' left of centerline, 165' AGL/3886' MSL.

**NOTE–**

Compliance with 14 CFR Part 121 or 135 one-engine-inoperative (OEI) departure performance requirements, or similar ICAO/State rules, cannot be assured by the sole use of “low, close-in” obstacle data as published in the TPP. Operators should refer to precise data sources (for example, GIS database, etc.) specifically intended for OEI departure planning for those operations.

**37.5.5** Climb gradients greater than 200 FPNM are specified when required to support procedure design constraints, obstacle clearance, and/or airspace restrictions. Compliance with a climb gradient for these purposes is mandatory when the procedure is part of the ATC clearance, unless increased takeoff minimums are provided and weather conditions allow compliance with these minimums.

**NOTE–**

Climb gradients for ATC purposes are being phased out on SIDs.

**EXAMPLE–**

“Cross ALPHA intersection at or below 4000; maintain 6000.” The pilot climbs at least 200 FPNM to 6000. If 4000 is reached before ALPHA, the pilot levels off at 4000 until passing ALPHA; then immediately resumes at least 200 FPNM climb.

**EXAMPLE–**

*“TAKEOFF MINIMUMS: RWY 27, Standard with a minimum climb of 280’ per NM to 2500.” A climb of at least 280 FPNM is required to 2500 and is mandatory when the departure procedure is included in the ATC clearance.*

**NOTE–**

*Some SIDs still retain labeled “ATC” climb gradients published or have climb gradients that are established to meet a published altitude restriction that is not required for obstacle clearance or procedure design criteria. These procedures will be revised in the course of the normal procedure amendment process.*

**37.5.6** Climb gradients may be specified only to an altitude/fix, above which the normal gradient applies.

An ATC–required altitude restriction published at a fix, will not have an associated climb gradient published with that restriction. Pilots are expected to determine if crossing altitudes can be met, based on the performance capability of the aircraft they are operating.

**EXAMPLE–**

*“Minimum climb 340 FPNM to ALPHA.” The pilot climbs at least 340 FPNM to ALPHA, then at least 200 FPNM to MIA.*

**37.5.7** A Visual Climb Over Airport (VCOA) procedure is a departure option for an IFR aircraft, operating in visual meteorological conditions equal to or greater than the specified visibility and ceiling, to visually conduct climbing turns over the airport to the published “at or above” altitude. At this point, the pilot may proceed in instrument meteorological conditions to the first en route fix using a diverse departure, or to proceed via a published routing to a fix from where the aircraft may join the IFR en route structure, while maintaining a climb gradient of at least 200 feet per nautical mile. VCOA procedures are developed to avoid obstacles greater than 3 statute miles from the departure end of the runway as an alternative to complying with climb gradients greater than 200 feet per nautical mile. Pilots are responsible to advise ATC as early as possible of the intent to fly the VCOA option prior to departure. Pilots are expected to remain within the distance prescribed by the published visibility minimums during the climb over the airport until reaching the “at or above” altitude for the VCOA procedure. If no additional routing is published, then the pilot may proceed in accordance with their IFR clearance. If additional routing is published after the “at–or–above” altitude, the pilot must comply with the route to a fix that may include a climb–in–holding pattern to reach the MEA/MIA for the en route portion of their IFR flight. These textual procedures are published in the Take–Off Minimums and (Obstacle) Departure Procedures section of the Terminal Procedures Publications and/or appear as an option on a Graphic ODP.

**EXAMPLE–**

*TAKEOFF MINIMUMS: Rwy 32, standard with minimum climb of 410’ per NM to 3000’ or 1100–3 for VCOA.*

*VCOA: Rwy 32, obtain ATC approval for VCOA when requesting IFR clearance. Climb in visual conditions to cross Broken Bow Muni/Keith Glaze Field at or above 3500’ before proceeding on course.*

**37.6** Who is responsible for obstacle clearance? DPs are designed so that adherence to the procedure by the pilot will ensure obstacle protection. Additionally:

**37.6.1** Obstacle clearance responsibility also rests with the pilot when he/she chooses to climb in visual conditions in lieu of flying a DP and/or depart under increased takeoff minima rather than fly the climb gradient. Standard takeoff minima are one statute mile for aircraft having two engines or less and one–half statute mile for aircraft having more than two engines. Specified ceiling and visibility minima will allow visual avoidance of obstacles during the initial climb with the standard climb gradient. When departing using the VCOA, obstacle avoidance is not guaranteed if the pilot maneuvers farther from the airport than the published visibility minimum for the VCOA prior to reaching the published VCOA altitude. DPs may also contain what are called Low Close in Obstacles. These obstacles are less than 200 feet above the departure end of runway elevation and within one NM of the runway end and do not require increased takeoff minimums. These obstacles are identified on the SID chart or in the Take–off Minimums and (Obstacle) Departure Procedures section of the U. S. Terminal Procedure booklet. These obstacles are especially critical to aircraft that do not lift off until close to the departure end of the runway or which climb at the minimum rate. Pilots should also consider drift following lift–off to ensure sufficient clearance from these obstacles. That segment of the procedure that requires the pilot to see and avoid obstacles ends when the aircraft crosses the specified point at the required altitude. In all cases continued obstacle clearance is based on having climbed a minimum of 200 feet per nautical mile to the specified point and then

continuing to climb at least 200 foot per nautical mile during the departure until reaching the minimum en route altitude unless specified otherwise.

**37.6.2** ATC may vector the aircraft beginning with an ATC–assigned heading issued with the initial or takeoff clearance followed by subsequent vectors, if required, until reaching the minimum vectoring altitude by using a published Diverse Vector Area (DVA).

**37.6.3** The DVA may be established below the Minimum Vectoring Altitude (MVA) or Minimum IFR Altitude (MIA) in a radar environment at the request of Air Traffic. This type of DP meets the TERPS criteria for diverse departures, obstacles, and terrain avoidance in which vectors below the MVA/MIA may be issued to departing aircraft. The DVA has been assessed for departures which do not follow a specific ground track, but will remain within the specified area. Use of a DVA is valid only when aircraft are permitted to climb uninterrupted from the departure runway to the MVA/MIA (or higher). ATC will not assign an altitude below the MVA/MIA within a DVA. At locations that have a DVA, ATC is not permitted to utilize a SID and DVA concurrently.

**37.6.3.1** The existence of a DVA will be noted in the Takeoff Minimums and Obstacle Departure Procedure section of the U.S. Terminal Procedures Publication (TPP). The Takeoff Departure procedure will be listed first, followed by any applicable DVA.

**EXAMPLE–**

**DIVERSE VECTOR AREA (RADAR VECTORS) AMDT 1 14289 (FAA)**

**Rwy 6R**, headings as assigned by ATC; requires minimum climb of 290' per NM to 400.  
**Rwys 6L, 7L, 7R, 24R, 25R**, headings as assigned by ATC.

**37.6.3.2** Pilots should be aware that a published climb gradient greater than the standard 200 FPNM can exist within a DVA. Pilots should note that the DVA has been assessed for departures which do not follow a specific ground track.

**37.6.3.3** ATC may also vector an aircraft off a previously assigned DP. If the aircraft is airborne and established on a SID or ODP and subsequently vectored off, ATC is responsible for terrain and obstruction clearance. In all cases, the minimum 200 FPNM climb gradient is assumed.

**NOTE–**

*As is always the case, when used by the controller during departure, the term “radar contact” should not be interpreted as relieving pilots of their responsibility to maintain appropriate terrain and obstruction clearance, which may include flying the obstacle DP.*

**37.6.4** Pilots must preplan to determine if the aircraft can meet the climb gradient (expressed in feet per nautical mile) required by the departure procedure or DVA, and be aware that flying at a higher than anticipated ground speed increases the climb rate requirement in feet per minute. Higher than standard climb gradients are specified by a note on the departure procedure chart for graphic DPs, or in the Take–Off Minimums and (Obstacle) Departure Procedures section of the U.S. Terminal Procedures booklet for textual ODPs. The required climb gradient, or higher, must be maintained to the specified altitude or fix, then the standard climb gradient of 200 ft/NM can be resumed. A table for the conversion of climb gradient (feet per nautical mile) to climb rate (feet per minute), at a given ground speed, is included on the inside of the back cover of the U.S. Terminal Procedures booklets.

**37.7** Where are DPs located? DPs and DVAs will be listed by airport in the IFR Takeoff Minimums and (Obstacle) Departure Procedures Section, Section L, of the Terminal Procedures Publications (TPP). If the DP is textual, it will be described in TPP Section L. SIDs and complex ODPs will be published graphically and named. The name will be listed by airport name and runway in Section L. Graphic ODPs will also have the term “(OBSTACLE)” printed in the charted procedure title, differentiating them from SIDs.

**37.7.1** An ODP that has been developed solely for obstacle avoidance will be indicated with the symbol “T” on appropriate Instrument Approach Procedure (IAP) charts and DP charts for that airport. The “T” symbol will continue to refer users to TPP Section C. In the case of a graphic ODP, the TPP Section C will only contain the name of the ODP. Since there may be both a textual and a graphic DP, Section C should still be checked for additional information. The nonstandard minimums and minimum climb gradients found in TPP Section C also

apply to charted DPs and radar vector departures unless different minimums are specified on the charted DP. Takeoff minimums and departure procedures apply to all runways unless otherwise specified. New graphic DPs will have all the information printed on the graphic depiction. As a general rule, ATC will only assign an ODP from a nontowered airport when compliance with the ODP is necessary for aircraft to aircraft separation. Pilots may use the ODP to help ensure separation from terrain and obstacles.

### **37.8 Responsibilities**

**37.8.1** Each pilot, prior to departing an airport on an IFR flight should:

**37.8.1.1** Consider the type of terrain and other obstacles on or in the vicinity of the departure airport;

**37.8.1.2** Determine whether an ODP is available;

**37.8.1.3** Determine if obstacle avoidance can be maintained visually or if the ODP should be flown; and

**37.8.1.4** Consider the effect of degraded climb performance and the actions to take in the event of an engine loss during the departure. Pilots should notify ATC as soon as possible of reduced climb capability in that circumstance.

**NOTE–**

*Guidance concerning contingency procedures that address an engine failure on takeoff after  $V_1$  speed on a large or turbine–powered transport category airplane may be found in AC 120–91, Airport Obstacle Analysis.*

**37.8.1.5** Determine if a DVA is published and whether the aircraft is capable of meeting the published climb gradient. Advise ATC when requesting the IFR clearance, or as soon as possible, if unable to meet the DVA climb gradient.

**37.8.1.6** Check for Takeoff Obstacle Notes published in the TPP for the takeoff runway.

**37.8.2** Pilots should not exceed a published speed restriction associated with a SID waypoint until passing that waypoint.

**37.8.3** After an aircraft is established on a SID and subsequently vectored or cleared to deviate off of the SID or SID transition, pilots must consider the SID canceled, unless the controller adds “expect to resume SID;” pilots should then be prepared to rejoin the SID at a subsequent fix or procedure leg. If the SID contains published altitude and/or speed restrictions, those restrictions are canceled and pilots will receive an altitude to maintain and, if necessary, a speed. ATC may also interrupt the vertical navigation of a SID and provide alternate altitude instructions while the aircraft remains established on the published lateral path. Aircraft may be vectored off of an ODP, or issued an altitude lower than a published altitude on an ODP, at which time the ODP is canceled. In these cases, ATC assumes responsibility for terrain and obstacle clearance. In all cases, the minimum 200 FPNM climb gradient is assumed.

**37.8.4** Aircraft instructed to resume a SID procedure such as a DP or SID which contains speed and/or altitude restrictions, must be:

**37.8.4.1** Issued/reissued all applicable restrictions, or

**37.8.4.2** Advised to “Climb via SID” or resume published speed.

**EXAMPLE–**

*“Resume the Solar One departure, Climb via SID.”*

*“Proceed direct CIROS, resume the Solar One departure, Climb via SID.”*

**37.8.5** A clearance for a SID which does not contain published crossing restrictions, and/or is a SID with a Radar Vector segment or a Radar Vector SID, will be issued using the phraseology “Maintain (*altitude*).”

**37.8.6** A clearance for a SID which contains published altitude restrictions may be issued using the phraseology “climb via.” Climb via is an abbreviated clearance that requires compliance with the procedure lateral path, associated speed and altitude restrictions along the cleared route or procedure. Clearance to “climb via” authorizes the pilot to:

**37.8.6.1** When used in the IFR departure clearance, in a PDC, DCL or when cleared to a waypoint depicted on a SID, to join the procedure after departure or to resume the procedure.

**37.8.6.2** When vertical navigation is interrupted and an altitude is assigned to maintain which is not contained on the published procedure, to climb from that previously-assigned altitude at pilot's discretion to the altitude depicted for the next waypoint.

**37.8.6.3** Once established on the depicted departure, to navigate laterally and climb to meet all published or assigned altitude and speed restrictions.

**NOTE–**

**1.** When otherwise cleared along a route or procedure that contains published speed restrictions, the pilot must comply with those speed restrictions independent of a climb via clearance.

**2.** ATC anticipates pilots will begin adjusting speed the minimum distance necessary prior to a published speed restriction so as to cross the waypoint/fix at the published speed. Once at the published speed ATC expects pilots will maintain the published speed until additional adjustment is required to comply with further published or ATC assigned speed restrictions or as required to ensure compliance with 14 CFR Section 91.117.

**3.** If ATC interrupts lateral/vertical navigation while an aircraft is flying a SID, ATC must ensure obstacle clearance. When issuing a “climb via” clearance to join or resume a procedure ATC must ensure obstacle clearance until the aircraft is established on the lateral and vertical path of the SID.

**4.** ATC will assign an altitude to cross if no altitude is depicted at a waypoint/fix or when otherwise necessary/ required, for an aircraft on a direct route to a waypoint/fix where the SID will be joined or resumed.

**5.** SIDs will have a “top altitude;” the “top altitude” is the charted “maintain” altitude contained in the procedure description or assigned by ATC.

**EXAMPLE–**

**1. Lateral route clearance:**

“Cleared Loop Six departure.”

**NOTE–**

The aircraft must comply with the SID lateral path, and any published speed restrictions.

**2. Routing with assigned altitude:**

“Cleared Loop Six departure, climb and maintain four thousand.”

**NOTE–**

The aircraft must comply with the SID lateral path, and any published speed restriction while climbing unrestricted to four thousand.

**3.** (A pilot filed a flight plan to the Johnston Airport using the Scott One departure, Jonez transition, then Q-145. The pilot filed for FL350. The Scott One includes altitude restrictions, a top altitude and instructions to expect the filed altitude ten minutes after departure). Before departure ATC uses PDC, DCL or clearance delivery to issue the clearance:

“Cleared to Johnston Airport, Scott One departure, Jonez transition, Q-OneForty-five. Climb via SID.”

**NOTE–**

In Example 3, the aircraft must comply with the Scott One departure lateral path and any published speed and altitude restrictions while climbing to the SID top altitude.

**4.** (Using the Example 3 flight plan, ATC determines the top altitude must be changed to FL180). The clearance will read:

“Cleared to Johnston Airport, Scott One departure, Jonez transition, Q-One Forty-five, Climb via SID except maintain flight level one eight zero.”

**NOTE–**

In Example 4, the aircraft must comply with the Scott One departure lateral path and any published speed and altitude restrictions while climbing to FL180. The aircraft must stop climb at FL180 until issued further clearance by ATC.

**5.** (An aircraft was issued the Suzan Two departure, “climb via SID” in the IFR departure clearance. After departure ATC must change a waypoint crossing restriction). The clearance will be:

“Climb via SID except cross Mkala at or above seven thousand.”

**NOTE–**

In Example 5, the aircraft will comply with the Suzan Two departure lateral path and any published speed and altitude restrictions and climb so as to cross Mkala at or above 7,000; remainder of the departure must be flown as published.

6. (An aircraft was issued the Teddd One departure, “climb via SID” in the IFR departure clearance. An interim altitude of 10,000 was issued instead of the published top altitude of FL 230). After departure ATC is able to issue the published top altitude. The clearance will be:

“Climb via SID.”

**NOTE–**

In Example 6, the aircraft will track laterally and vertically on the Teddd One departure and initially climb to 10,000; Once re-issued the “climb via” clearance the interim altitude is canceled aircraft will continue climb to FL230 while complying with published restrictions.

7. (An aircraft was issued the Bbear Two departure, “climb via SID” in the IFR departure clearance. An interim altitude of 16,000 was issued instead of the published top altitude of FL 190). After departure, ATC is able to issue a top altitude of FL300 and still requires compliance with the published SID restrictions. The clearance will be:

“Climb via SID except maintain flight level three zero zero.”

**NOTE–**

In Example 7, the aircraft will track laterally and vertically on the Bbear Two departure and initially climb to 16,000; Once re-issued the “climb via” clearance the interim altitude is canceled and the aircraft will continue climb to FL300 while complying with published restrictions.

8. (An aircraft was issued the Bizze Two departure, “climb via SID.” After departure, ATC vectors the aircraft off of the SID, and then issues a direct routing to rejoin the SID at Rockr waypoint which does not have a published altitude restriction. ATC wants the aircraft to cross at or above 10,000). The clearance will read:

“Proceed direct Rockr, cross Rockr at or above one-zero thousand, climb via the Bizze Two departure.”

**NOTE–**

In Example 8, the aircraft will join the Bizze Two SID at Rockr at or above 10,000 and then comply with the published lateral path and any published speed or altitude restrictions while climbing to the SID top altitude.

9. (An aircraft was issued the Suzan Two departure, “climb via SID” in the IFR departure clearance. After departure ATC vectors the aircraft off of the SID, and then clears the aircraft to rejoin the SID at Dvine waypoint, which has a published crossing restriction). The clearance will read:

“Proceed direct Dvine, Climb via the Suzan Two departure.”

**NOTE–**

In Example 9, the aircraft will join the Suzan Two departure at Dvine, at the published altitude, and then comply with the published lateral path and any published speed or altitude restrictions.

**37.8.7** Pilots cleared for vertical navigation using the phraseology “climb via” must inform ATC, upon initial contact, of the altitude leaving and any assigned restrictions not published on the procedure.

**EXAMPLE–**

1. (Cactus 711 is cleared to climb via the Laura Two departure. The Laura Two has a top altitude of FL190):  
“Cactus Seven Eleven leaving two thousand, climbing via the Laura Two departure.”

2. (Cactus 711 is cleared to climb via the Laura Two departure, but ATC changed the top altitude to 16,000):  
“Cactus Seven Eleven leaving two thousand for one-six thousand, climbing via the Laura Two departure.”

**37.8.8** If prior to or after takeoff an altitude restriction is issued by ATC, all previously issued “ATC” altitude restrictions are canceled including those published on a SID. Pilots must still comply with all speed restrictions and lateral path requirements published on the SID unless canceled by ATC.

**EXAMPLE–**

Prior to takeoff or after departure ATC issues an altitude change clearance to an aircraft cleared to climb via a SID but ATC no longer requires compliance with published altitude restrictions:

“Climb and maintain flight level two four zero.”

**NOTE–**

The published SID altitude restrictions are canceled; The aircraft should comply with the SID lateral path and begin an unrestricted climb to FL240. Compliance with published speed restrictions is still required unless specifically deleted by ATC.

**37.8.9** Altitude restrictions published on an ODP are necessary for obstacle clearance and/or design constraints. Crossing altitudes and speed restrictions on ODPs cannot be canceled or amended by ATC.

### **37.9 PBN Departure Procedures**

**37.9.1** All public PBN SIDs and graphic ODPs are normally designed using RNAV 1, RNP 1, or A-RNP NavSpecs. These procedures generally start with an initial track or heading leg near the departure end of runway (DER). In addition, these procedures require system performance currently met by GPS or DME/DME/IRU PBN systems that satisfy the criteria discussed in the latest AC 90-100, U.S. Terminal and En Route Area Navigation (RNAV) Operations. RNAV 1 and RNP 1 procedures must maintain a total system error of not more than 1 NM for 95 percent of the total flight time. Minimum values for A-RNP procedures will be charted in the PBN box (for example, 1.00 or 0.30).

**37.9.2** In the U.S., a specific procedure's PBN requirements will be prominently displayed in separate, standardized notes boxes. For procedures with PBN elements, the "PBN box" will contain the procedure's NavSpec(s); and, if required: specific sensors or infrastructure needed for the navigation solution, any additional or advanced functional requirements, the minimum RNP value, and any amplifying remarks. Items listed in this PBN box are REQUIRED for the procedure's PBN elements.





## ENR 1.6 ATS Surveillance Services and Procedures

### 1. General

**1.1** The FAA maintains a Keyhole Markup Language (KML) file with information on estimated ATS surveillance coverage on the following website: <https://www.faa.gov/nextgen/equipadsb/research/airspace>.

**1.2** The full URL to download the file is located at: <https://www.faa.gov/nextgen/equipadsb/research/airspace/media/2020ADS-BAirspaceMap.kmz>. The file contains selectable data on the Continental United States (CONUS), Alaska, Hawaii, Puerto Rico and Guam.

**1.3** Geospatial software (such as Google Earth) can be used to open the KML file and view graphical portrayals of ADS-B rule airspace and estimated ADS-B and secondary surveillance radar (SSR) surveillance coverage at selectable altitudes of 500 feet; 1,500 feet; 3,000 feet; 5,000 feet; and 10,000 feet AGL.

**1.4** Additionally, for Alaska, selectable altitudes of 20,000 feet and 33,000 feet MSL are available.

### 2. Secondary Surveillance Radar (SSR)

**2.1** The following graphics are static portrayals of SSR coverage at various locations and altitudes. See ENR 1.6 paragraph 1.1 above for details on an interactive version of the portrayals below.

*FIG ENR 1.6-1*  
CONUS with SSR Coverage at 1,500' AGL

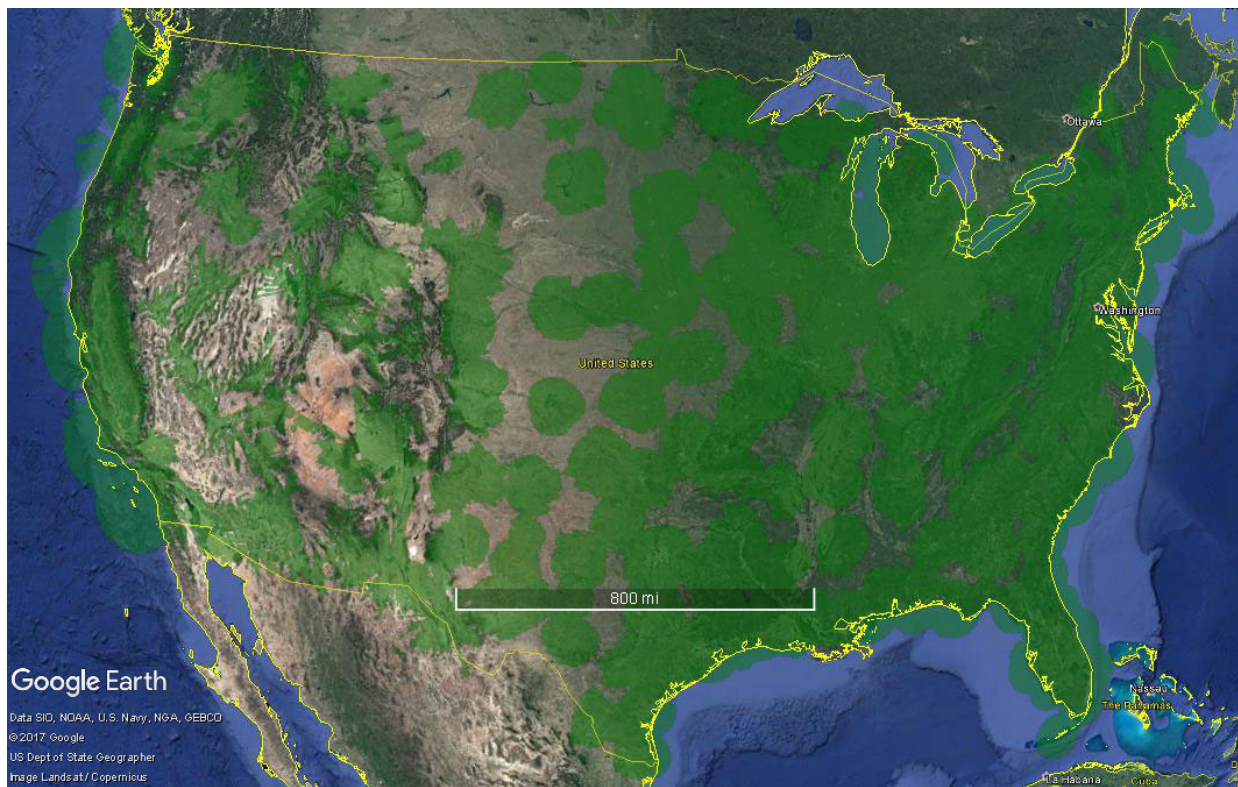


FIG ENR 1.6-2  
CONUS with SSR Coverage at 5,000' AGL



FIG ENR 1.6-3  
Hawaii, Puerto Rico, and Guam with SSR Coverage at 1,500' AGL

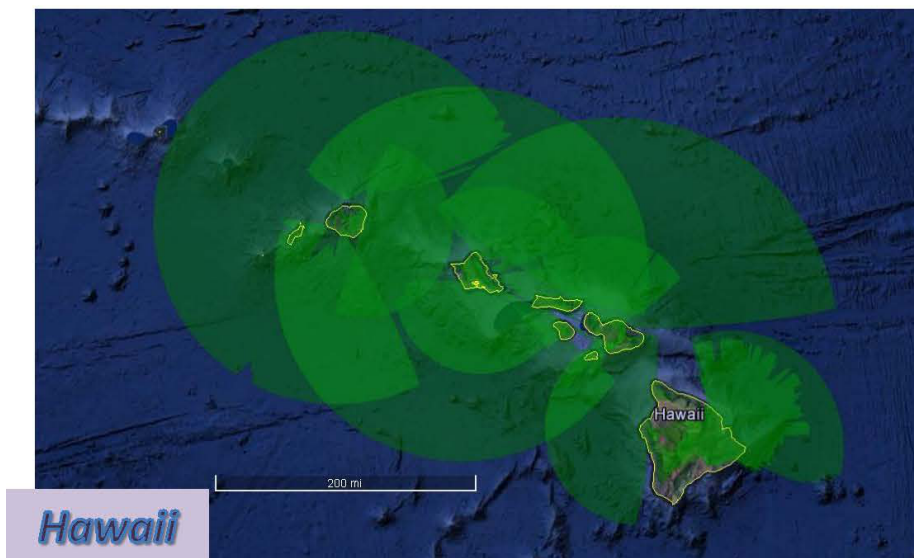
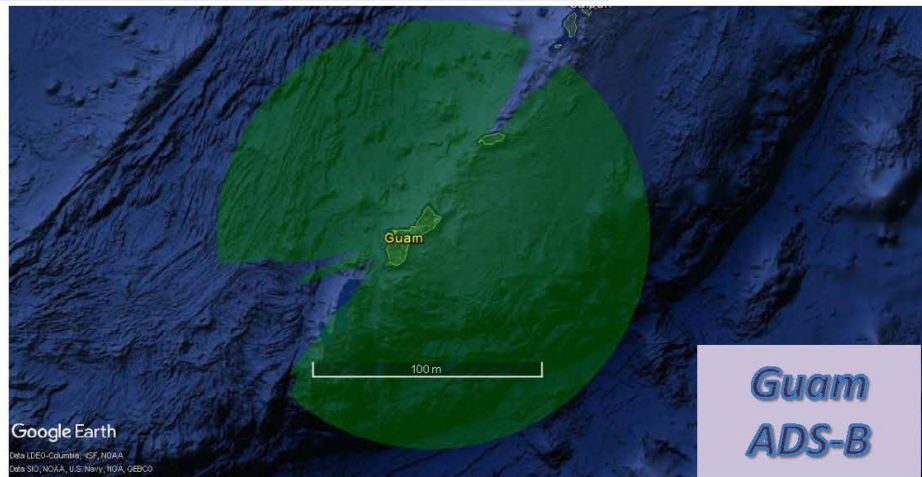
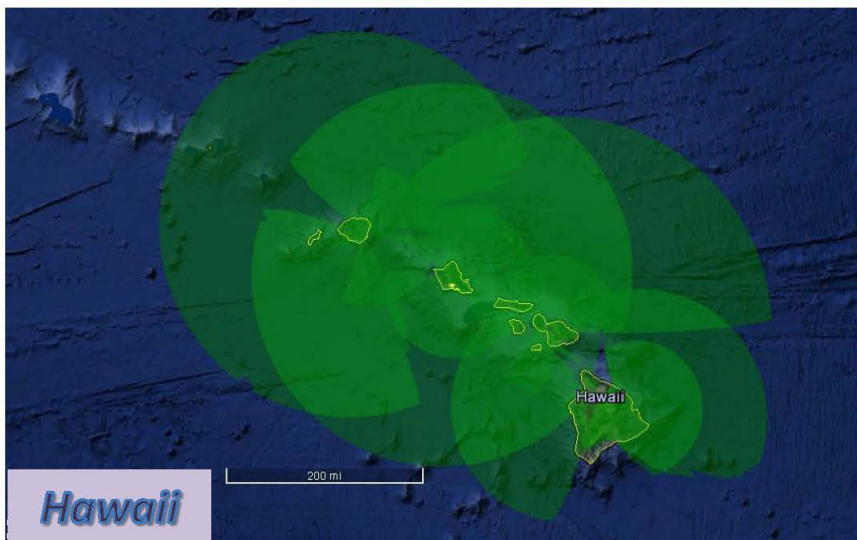
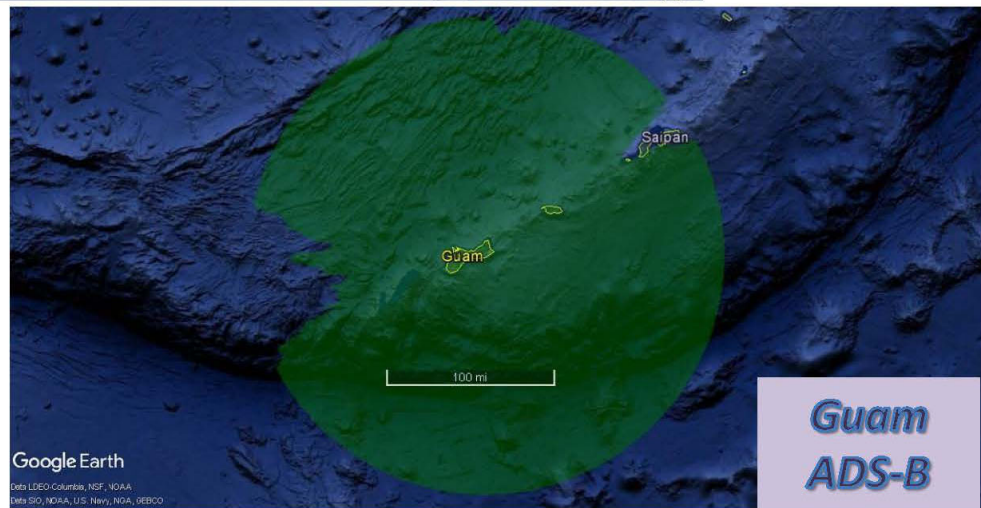


FIG ENR 1.6-4  
Hawaii, Puerto Rico, and Guam with SSR Coverage at 5,000' AGL



**FIG ENR 1.6-5**  
**Alaska with SSR Coverage at 1,500' AGL**



**FIG ENR 1.6-6**  
**Alaska with SSR Coverage at 5,000' AGL**

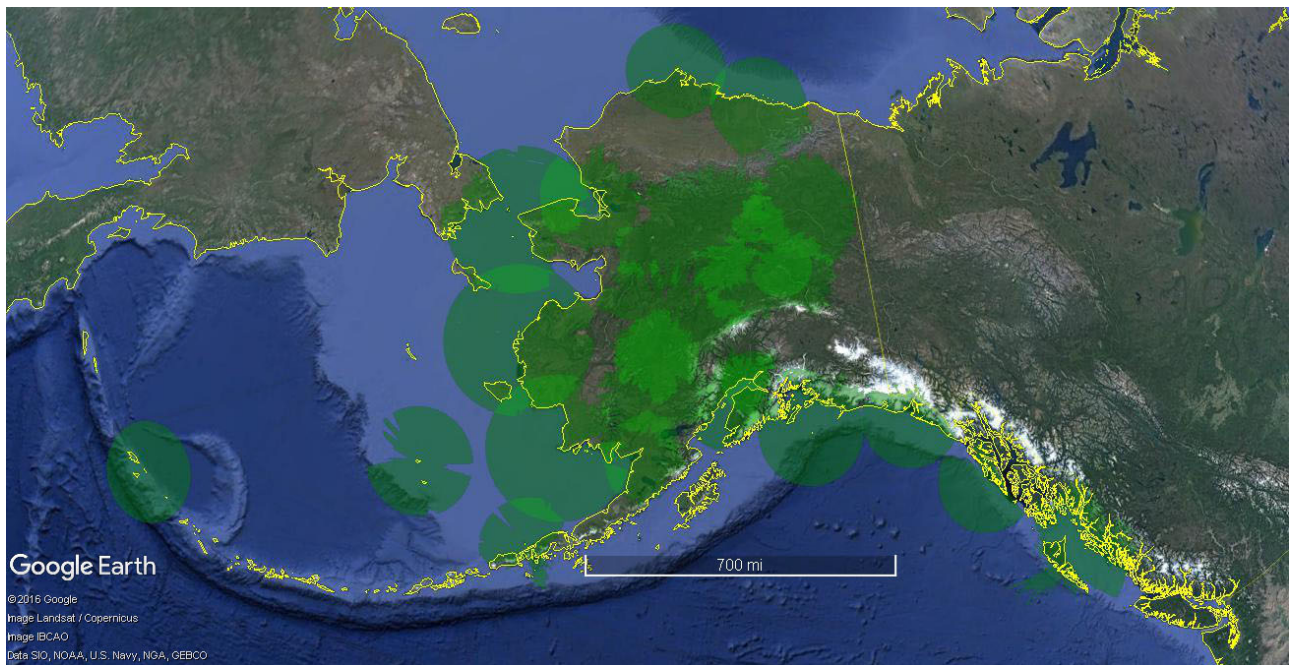
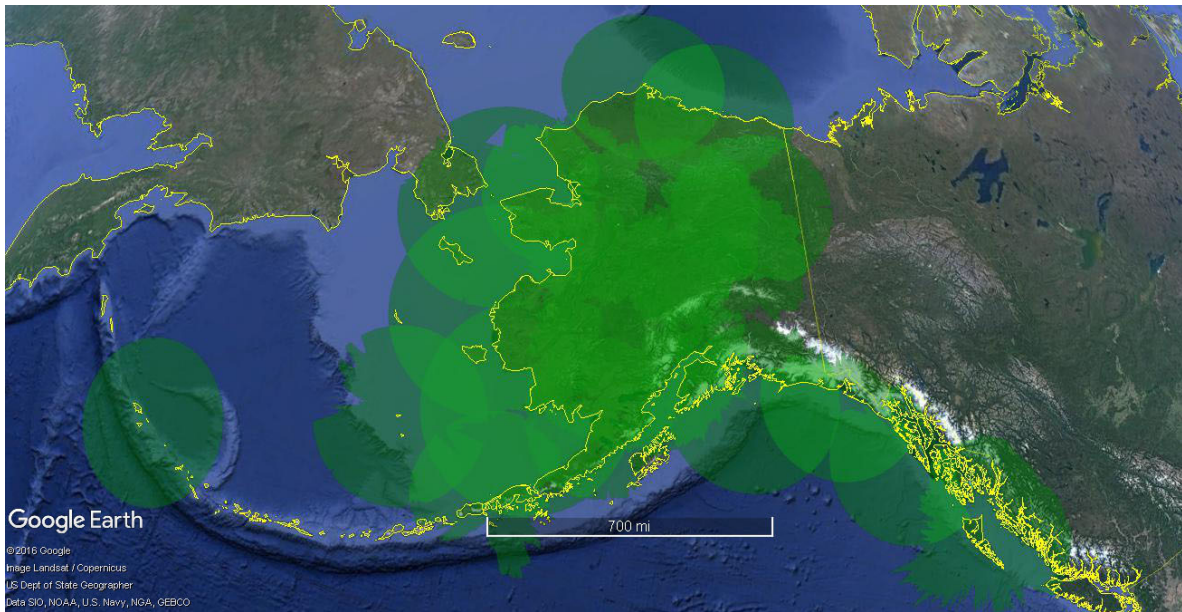


FIG ENR 1.6-7  
Alaska with SSR Coverage at 20,000' MSL



### 3. Automatic Dependent Surveillance — Broadcast (ADS-B)

3.1 The following graphics are static portrayals of SSR coverage at various locations and altitudes. See ENR 1.6 paragraph 1.1 for details on an interactive version of the portrayals below.

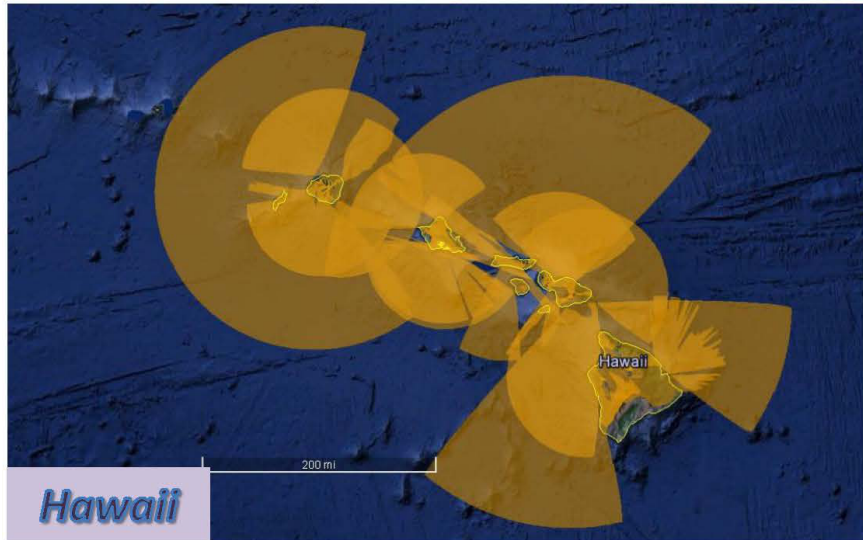
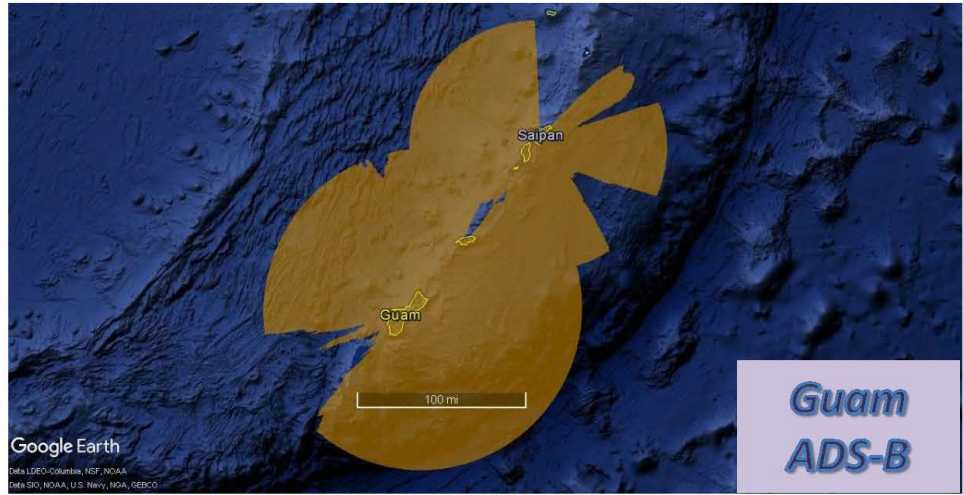
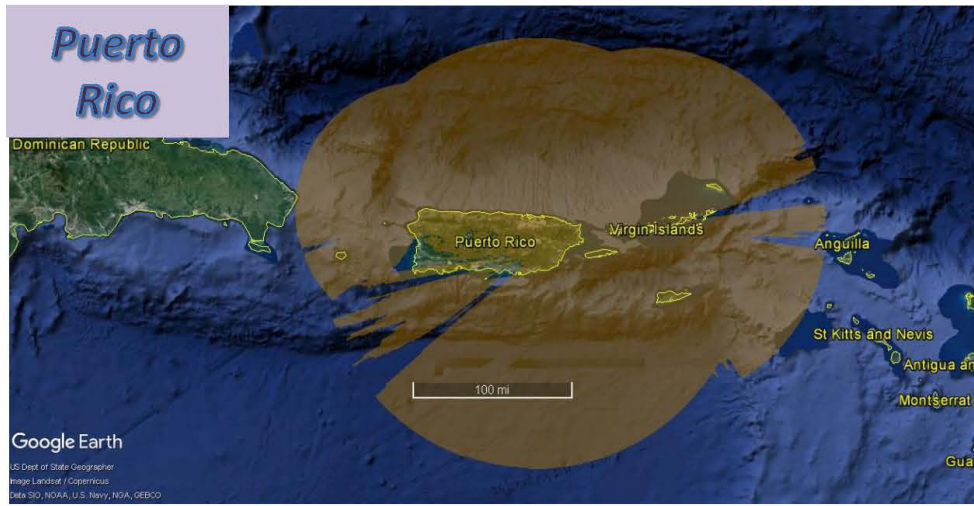
FIG ENR 1.6-8  
CONUS with ADS-B Coverage at 1,500' AGL



**FIG ENR 1.6-9**  
**CONUS with ADS-B Coverage at 5,000' AGL**

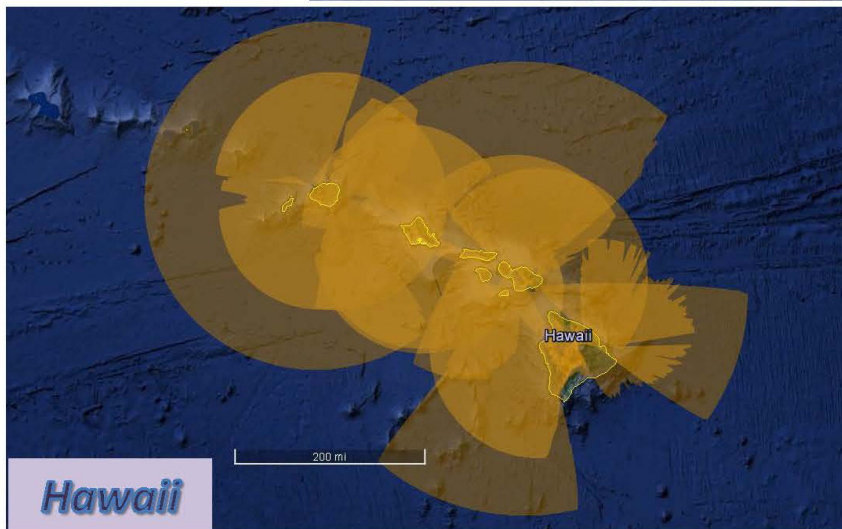
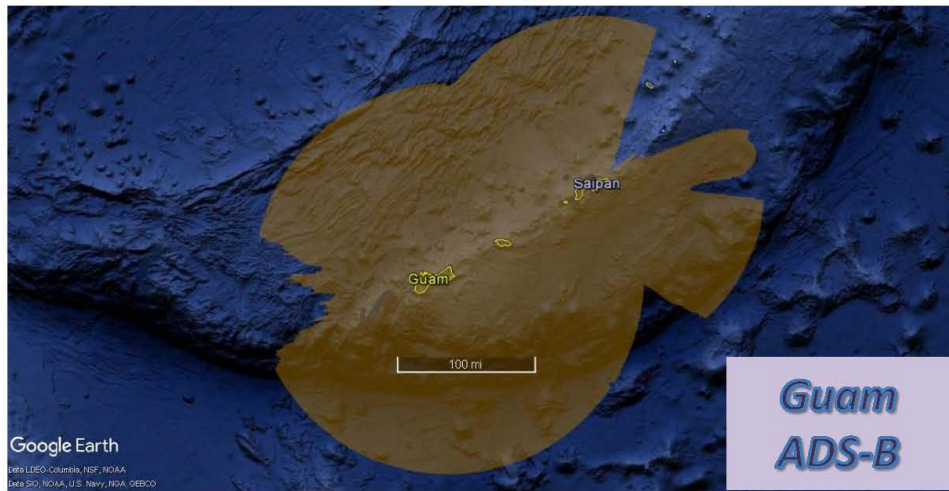
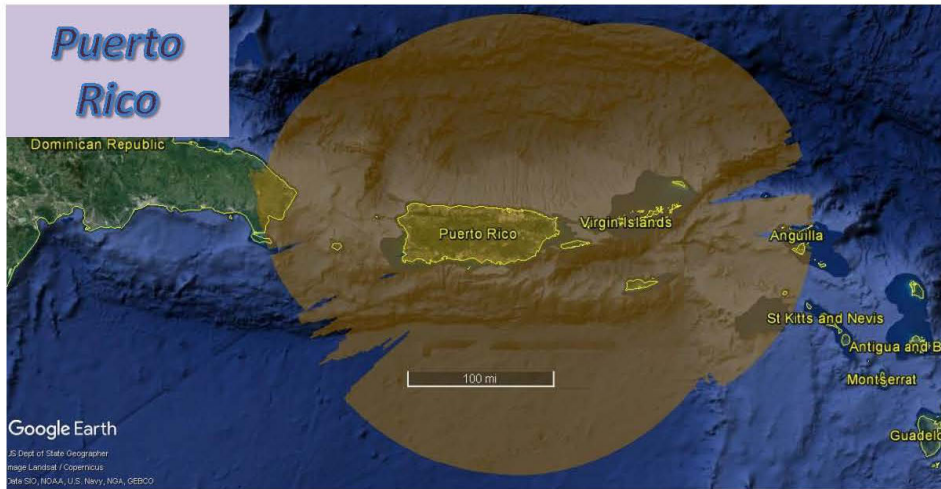


FIG ENR 1.6-10  
Hawaii, Puerto Rico, and Guam with ADS-B Coverage at 1,500' AGL

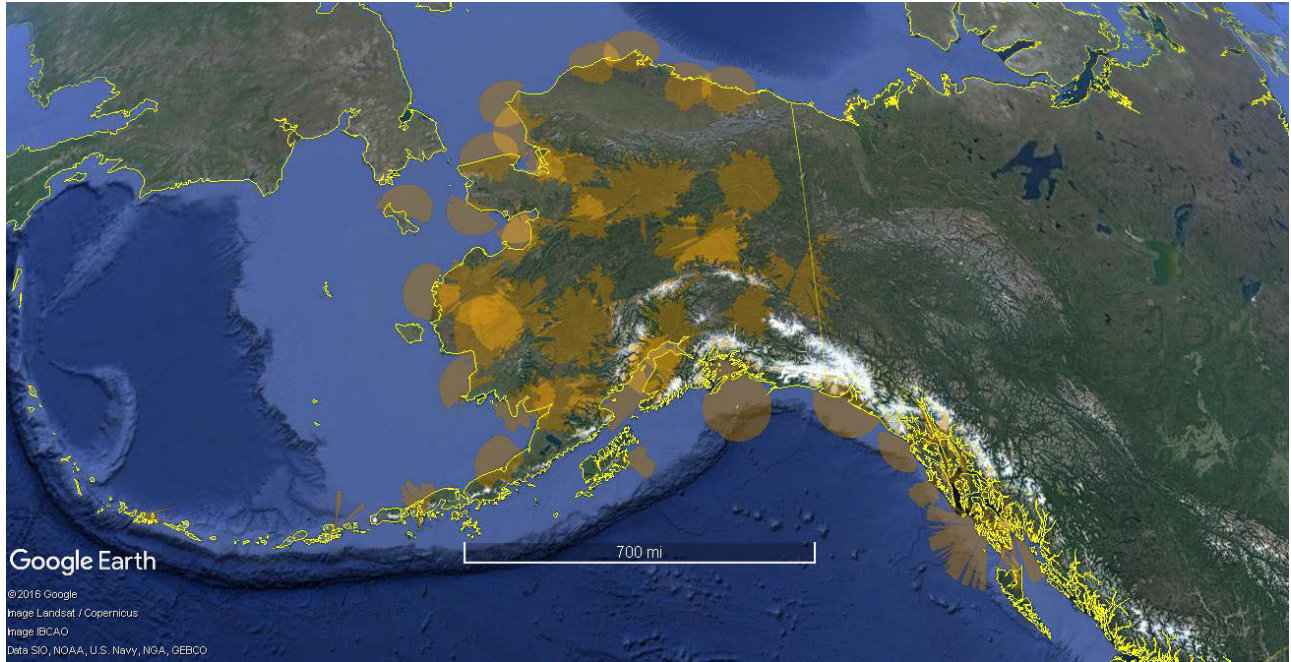




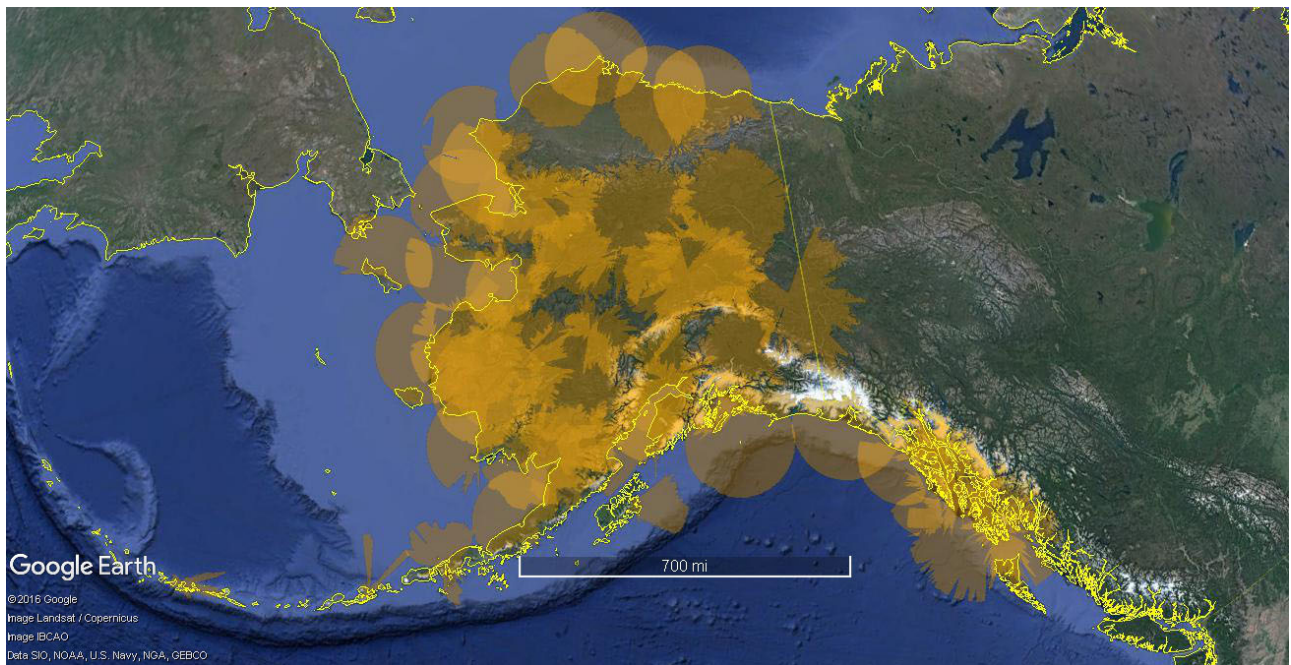
**FIG ENR 1.6-II**  
**Hawaii, Puerto Rico, and Guam with ADS-B Coverage at 5,000' AGL**



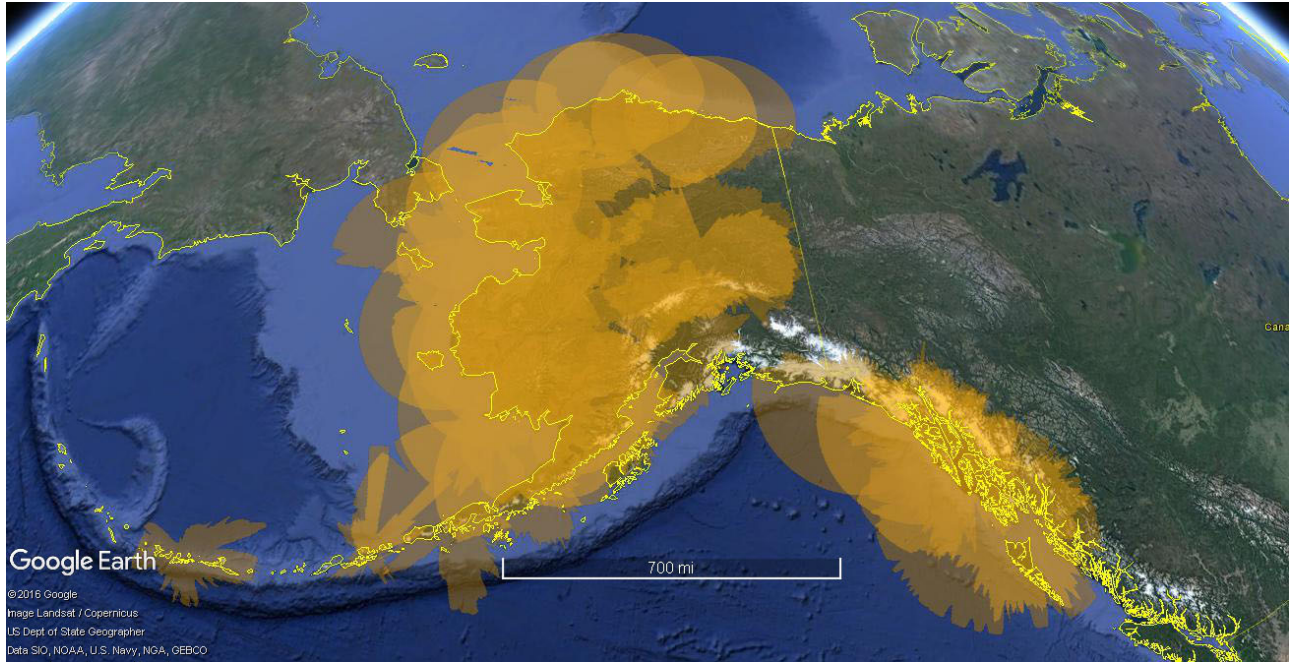
**FIG ENR 1.6-12**  
**Alaska with ADS-B Coverage at 1,500' AGL**



**FIG ENR 1.6-13**  
**Alaska with ADS-B Coverage at 5,000' AGL**



**FIG ENR 1.6-14**  
**Alaska with ADS-B Coverage at 20,000' MSL**





## ENR 1.7 Barometric Altimeter Errors and Setting Procedures

### 1. General

1.1 Aircraft altimeters are subject to the following errors and weather factors:

1.1.1 Instrument error.

1.1.2 Position error from aircraft static pressure systems.

1.1.3 Nonstandard atmospheric pressure.

1.1.4 Nonstandard temperatures.

1.2 The standard altimeter 29.92 inches Mercury (“Hg.) setting at the higher altitudes eliminates station barometer errors, some altimeter instrument errors, and errors caused by altimeter settings derived from different geographical sources.

### 2. Barometric Pressure Altimeter Errors

2.1 High Barometric Pressure: Cold, dry air masses may produce barometric pressures in excess of 31.00 “Hg. Many aircraft altimeters cannot be adjusted above 31.00 “Hg. When an aircraft’s altimeter cannot be set to a pressure setting above 31.00 “Hg, the aircraft’s true altitude will be higher than the indicated altitude on the barometric altimeter.

2.2 Low Barometric Pressure: An abnormal low–pressure condition exists when the barometric pressure is less than 28.00 “Hg. Flight operations are not recommended when an aircraft’s altimeter is unable to be set below 28.00 “Hg. In this situation, the aircraft’s true altitude is lower than the indicated altitude. This situation may be exacerbated when operating in extremely cold temperatures, which may result in the aircraft’s true altitude being significantly lower than the indicated altitude.

**NOTE–**

*EXTREME CAUTION SHOULD BE EXERCISED WHEN FLYING IN PROXIMITY TO OBSTRUCTIONS OR TERRAIN IN LOW PRESSURES AND/OR LOW TEMPERATURES.*

### 3. Altimeter Setting Procedures

3.1 Manufacturing and installation specifications, along with 14 CFR Part 43, Appendix E requirement for periodic tests and inspections, helps reduce mechanical, elastic, temperature, and installation errors. (See Instrument Flying Handbook.) Scale error may be observed while performing a ground altimeter check using the following procedure:

3.1.1 Set the current reported airfield altimeter setting on the altimeter setting scale.

3.1.2 Read the altitude on the altimeter. The altitude should read the known field elevation if you are located on the same reference level used to establish the altimeter setting.

3.1.3 If the difference from the known field elevation and the altitude read from the altimeter is plus or minus 75 feet or greater, the accuracy of the altimeter is questionable and the problem should be referred to an appropriately rated repair station for evaluation and possible correction.

3.2 It is important to set the current altimeter settings for the area of operation when flying at an enroute altitude that does not require a standard altimeter setting of 29.92 “Hg. If the altimeter is not set to the current altimeter setting when flying from an area of high pressure into an area of low pressure, the aircraft will be closer to the surface than the altimeter indicates. An inch Hg error in the altimeter setting equals 1,000 feet of altitude. For

example, setting 29.90 “Hg. instead of 30.90 “Hg. To quote an old saying: “GOING FROM A HIGH TO A LOW, LOOK OUT BELOW.”

**3.3** The aircraft cruising altitude or flight level is maintained by referencing the barometric altimeter. Procedures for setting altimeters during high and low barometric pressure events must be set using the following procedures:

**3.3.1** Below 18,000 feet mean sea level (MSL).

**3.3.1.1** Barometric pressure is 31.00 “Hg. or less.

a) Set the altimeter to a current reported altimeter setting from a station along the route and within 100 NM of the aircraft, or;

b) If there is no station within this area, use the current reported altimeter setting of the nearest available station, or;

**NOTE-**

*Air traffic controllers will furnish this information at least once when en route or on an instrument flight plan within their controlled airspace:*

c) If the aircraft is not equipped with a radio, set the altimeter to the elevation of the departure airport or use an available appropriate altimeter setting prior to departure.

**3.3.1.2** When the barometric pressure exceeds 31.00 “Hg., a NOTAM will be published to define the affected geographic area. The NOTAM will also institute the following procedures:

a) All aircraft: All aircraft will set 31.00 “Hg. for en route operations below 18,000 feet MSL. Maintain this setting until out of the affected area or until reaching the beginning of the final approach segment on an instrument approach. Set the current altimeter setting (above 31.00 “Hg.) approaching the final segment, if possible. If no current altimeter setting is available, or if a setting above 31.00 “Hg. cannot be made on the aircraft’s altimeter, leave 31.00 “Hg. set in the altimeter and continue the approach.

b) Set 31.00 “Hg. in the altimeter prior to reaching the lowest of any mandatory/ crossing altitudes or 1,500 feet above ground level (AGL) when on a departure or missed approach.

**NOTE-**

*Air traffic control will issue actual altimeter settings and advise pilots to set 31.00 “Hg. in their altimeters for en route operations below 18,000 feet MSL in affected areas.*

c) No additional restrictions apply for aircraft operating into an airport that are able to set and measure altimeter settings above 31.00 “Hg.

d) Flight operations are restricted to VFR weather conditions to and from an airport that is unable to accurately measure barometric pressures above 31.00 “Hg. These airports will report the barometric pressure as “missing” or “in excess of 31.00 “Hg.”.

e) VFR aircraft: VFR operating aircraft have no additional restrictions. Pilots must use caution when flight planning and operating in these conditions.

f) IFR aircraft: IFR aircraft unable to set an altimeter setting above 31.00 “Hg. should apply the following:

1) The suitability of departure alternate airports, destination airports, and destination alternate airports will be determined by increasing the published ceiling and visibility requirements when unable to set the aircraft altimeter above 31.00 “Hg. Any reported or forecast altimeter setting over 31.00 “Hg. will be rounded up to the next tenth to calculate the required increases. The ceiling will be increased by 100 feet and the visibility by 1/4 statute mile for each 1/10 “Hg. over 31.00 “Hg. Use these adjusted values in accordance with operating regulations and operations specifications.

**EXAMPLE-**

*Destination airport altimeter is 31.21 “Hg. The planned approach is an instrument landing system (ILS) with a decision altitude (DA) 200 feet and visibility 1/2 mile (200-1/2). Subtract 31.00 “Hg. from 31.21 “Hg. to get .21 “Hg. .21 “Hg. rounds up to .30 “Hg. Calculate the increased requirement: 100 feet per 1/10 equates to a 300 feet increase for .30 “Hg. 1/4 statute*

mile per 1/10 equates to a 3/4 statute mile increase for .30 “Hg. The destination weather requirement is determined by adding the 300–3/4 increase to 200–1/2. The destination weather requirement is now 500–1 1/4.

2) 31.00 “Hg. will remain set during the complete instrument approach. The aircraft has arrived at the DA or minimum descent altitude (MDA) when the published DA or MDA is displayed on the barometric altimeter.

**NOTE–**

The aircraft will be approximately 300 feet higher than the indicated barometric altitude using this method.

3) These restrictions do not apply to authorized Category II/III ILS operations and certificate holders using approved atmospheric pressure at aerodrome elevation (QFE) altimetry systems.

g) The FAA Flight Procedures & Airspace Group, Flight Technologies and Procedures Division may authorize temporary waivers to permit emergency resupply or emergency medical service operation.

**3.3.2** At or above 18,000 feet MSL. All operators will set 29.92 “Hg. (standard setting) in the barometric altimeter. The lowest usable flight level is determined by the atmospheric pressure in the area of operation as shown in TBL ENR 1.7–1. Air Traffic Control (ATC) will assign this flight level.

**TBL ENR 1.7-1  
Lowest Usable Flight Level**

<b>Altimeter Setting</b> (Current Reported)	<b>Lowest Usable Flight</b> Level
29.92 or higher	180
29.91 to 28.92	190
28.91 to 27.92	200

**3.3.3** When the minimum altitude per 14 CFR Section 91.159 and 14 CFR Section 91.177 is above 18,000 feet MSL, the lowest usable flight level must be the flight level equivalent of the minimum altitude plus the number of feet specified in TBL ENR 1.7–2. ATC will accomplish this calculation.

**TBL ENR 1.7-2  
Lowest Flight Level Correction Factor**

<b>Altimeter Setting</b>	<b>Correction Factor</b>
29.92 or higher	None
29.91 to 29.42	500 feet
29.41 to 28.92	1000 feet
28.91 to 28.42	1500 feet
28.41 to 27.92	2000 feet
27.91 to 27.42	2500 feet

**EXAMPLE–**

The minimum safe altitude of a route is 19,000 feet MSL and the altimeter setting is reported between 29.92 and 29.43 “Hg, the lowest usable flight level will be 195, which is the flight level equivalent of 19,500 feet MSL (minimum altitude (TBL ENR 1.7–1) plus 500 feet).

**3.3.4** Aircraft operating in an offshore CONTROL AREA should use altimeter–setting procedures as described above, unless directed otherwise by ATC.

**NOTE–**

Aircraft exiting the oceanic CTA/FIR destined for the U.S. or transitioning through U.S. offshore control areas should use the current reported altimeter of a station nearest to the route being flown. When entering an oceanic CTA/FIR from U.S. offshore control areas, pilots should change to the standard altimeter setting 29.92 “Hg.





## ENR 1.8 Cold Temperature Barometric Altimeter Errors, Setting Procedures, and Cold Temperature Airports (CTA)

### 1. Effect of Cold Temperature on Barometric Altimeters

**1.1** Temperature has an effect on the accuracy of barometric altimeters, indicated altitude, and true altitude. The standard temperature at sea level is 15 degrees Celsius (59 degrees Fahrenheit). The temperature gradient from sea level is minus 2 degrees Celsius (3.6 degrees Fahrenheit) per 1,000 feet. For example, at 5000 feet above sea level, the ambient temperature on a standard day would be 5 degrees Celsius. When the ambient (at altitude) temperature is colder than standard, the aircraft's true altitude is lower than the indicated barometric altitude. When the ambient temperature is warmer than the standard day, the aircraft's true altitude is higher than the indicated barometric altitude.

**1.2** TBL ENR 1.8-1 indicates how much error may exist when operating in non-standard cold temperatures. To use the table, find the reported temperature in the left column, read across the top row to locate the height above the airport (subtract airport elevation from the flight altitude). Find the intersection of the temperature row and height above the airport column. This number represents how far the aircraft may be below the indicated altitude due to possible cold temperature induced error.

*TBL ENR 1.8-1*  
**ICAO Cold Temperature Error Table**

HEIGHT ABOVE AIRPORT IN FEET

		200	300	400	500	600	700	800	900	1000	1500	2000	3000	4000	5000
REPORTED TEMP °C	+10	10	10	10	10	20	20	20	20	20	30	40	60	80	90
	0	20	20	30	30	40	40	50	50	60	90	120	170	230	280
	-10	20	30	40	50	60	70	80	90	100	150	200	290	390	490
	-20	30	50	60	70	90	100	120	130	140	210	280	420	570	710
	-30	40	60	80	100	120	140	150	170	190	280	380	570	760	950
	-40	50	80	100	120	150	170	190	220	240	360	480	720	970	1210
	-50	60	90	120	150	180	210	240	270	300	450	590	890	1190	1500

### 2. Pre-Flight Planning for Cold Temperature Altimeter Errors

Flight planning into a CTA may be accomplished prior to flight. Use the predicted coldest temperature for plus or minus 1 hour of the estimated time of arrival and compare against the CTA published temperature. If the predicted temperature is at or below CTA temperature, calculate an altitude correction using TBL ENR 1.8-1. This correction may be used at the CTA if the actual arrival temperature is the same as the temperature used to calculate the altitude correction during preflight planning.

### 3. Effects of Cold Temperature on Baro-vertical Navigation (VNAV) Vertical Guidance

Non-standard temperatures can result in a change to effective vertical paths and actual descent rates when using aircraft baro-VNAV equipment for vertical guidance on final approach segments. A lower than standard temperature will result in a shallower descent angle and reduced descent rate. Conversely, a higher than standard temperature will result in a steeper angle and increased descent rate. Pilots should consider potential consequences of these effects on approach minima, power settings, sight picture, visual cues, etc., especially for high-altitude or terrain-challenged locations and during low-visibility conditions.

**REFERENCE-**

*AIM Paragraph 5-4-5. Instrument Approach Procedure (IAP) Charts*

**3.1** Uncompensated Baro-VNAV note on 14 CFR Part 97 IAPs. The area navigation (RNAV) global positioning system (GPS) and RNAV required navigation performance (RNP) notes, “For uncompensated Baro-VNAV systems, lateral navigation (LNAV)/VNAV NA below  $-XX^{\circ}\text{C}$  ( $-XX^{\circ}\text{F}$ ) or above  $XX^{\circ}\text{C}$  ( $XXX^{\circ}\text{F}$ )” and “For uncompensated Baro-VNAV systems, procedure NA below  $-XX^{\circ}\text{C}$  ( $-XX^{\circ}\text{F}$ ) or above  $XX^{\circ}\text{C}$  ( $XXX^{\circ}\text{F}$ )” apply to baro-VNAV equipped aircraft. These temperatures and how they are used are independent of the temperature and procedures applied for a Cold Temperature Airport.

**3.1.1** The uncompensated baro-VNAV chart note and temperature range on an RNAV (GPS) approach is applicable to the LNAV/VNAV line of minima. Baro-VNAV equipped aircraft without a temperature compensating system may not use the RNAV (GPS) approach LNAV/VNAV line of minima when the actual temperature is above or below the charted temperature range.

**3.1.2** The uncompensated baro-VNAV chart note and temperature range on an RNAV (RNP) approach applies to the entire procedure. For aircraft without a baro-VNAV and temperature compensating system, the RNAV (RNP) approach is not authorized when the actual temperature is above or below the charted uncompensated baro-VNAV temperature range.

**3.2** Baro-VNAV temperature range versus CTA temperature: The baro-VNAV and CTA temperatures are independent and do not follow the same correction or reporting procedures. However, there are times when both procedures, each according to its associated temperature, should be accomplished on the approach.

**3.3** Operating and ATC reporting procedures.

**3.3.1** Do not use the CTA operating or reporting procedure found in this section, 4.1 thru 5.5, when complying with the baro-VNAV temperature note on an RNAV (GPS) approach. Correction is not required nor expected to be applied to procedure altitudes or VNAV paths outside of the final approach segment.

**3.3.2** Operators must advise ATC when making temperature corrections on RNP authorization required (AR) approaches while adhering to baro-VNAV temperature note.


**3.3.3** Reporting altitude corrections is required when complying with CTAs in conjunction with the baro-VNAV temperature note. The CTA altitude corrections will be reported in this situation. No altitude correction reporting is required in the final segment.

**NOTE-**

*When executing an approach with vertical guidance at a CTA (i.e., ILS, localizer performance with vertical guidance (LPV), LNAV/VNAV), pilots are reminded to intersect the glideslope/glidepath at the corrected intermediate altitude (if applicable) and follow the published glideslope/glidepath to the corrected minima. The ILS glideslope and WAAS generated glidepath are unaffected by cold temperatures and provide vertical guidance to the corrected DA. Begin descent on the ILS glideslope or WAAS generated glidepath when directed by aircraft instrumentation. Temperature affects the precise final approach fix (PFAF) true altitude where a baro-VNAV generated glidepath begins. The PFAF altitude must be corrected when below the CTA temperature restriction for the intermediate segment or outside of the baro-VNAV temperature restriction when using the LNAV/VNAV line of minima to the corrected DA.*

## **4. Cold Temperature Airports (CTA)**

**4.1** General: The FAA has determined that operating in cold temperatures has placed some 14 CFR Part 97 instrument approach procedures in the United States National Airspace System at risk for loss of required obstacle clearance (ROC). An airport that is determined to be at risk will have an ICON and temperature published on the instrument approach procedure (IAP) in the terminal procedures publication (TPP).

**4.2** CTA identification in TPP: A CTA is identified by a “snowflake” icon () and temperature limit, in Celsius, on U.S. Government approach charts.

**4.3** A current list of CTAs is located at: [https://www.faa.gov/air\\_traffic/flight\\_info/aeronav/digital\\_products/dtpp/search/](https://www.faa.gov/air_traffic/flight_info/aeronav/digital_products/dtpp/search/). Airports are listed by ICAO code, Airport Name, Temperature in Celsius, and affected segment(s).

**4.4 Airport Criteria.** The CTA risk analysis is performed on airports that have at least one runway of 2500 ft. Pilots operating into an airport with a runway length less than 2500 ft. may make a cold temperature altitude correction in cold temperature conditions, if desired. Comply with operating and reporting procedures for CTAs.

**4.5 ATC Reporting Requirements.** Pilots must advise ATC with the corrected altitude when applying an altitude correction on any approach segment with the exception of the final segment.

**4.6 Methods to apply correction:** The FAA recommends operators/pilots use either the All Segments Method or the Individual Segments Method when making corrections at CTAs.

## **5. Cold Temperature Airport Procedures**

**5.1 PILOTS MUST NOT MAKE AN ALTIMETER CHANGE** to accomplish an altitude correction. Pilots must ensure that the altimeter is set to the current altimeter setting provided by ATC in accordance with 14 CFR §91.121.

**5.2 Actions on when and where to make corrections:** Pilots will make an altitude correction to the published, “at”, “at or above”, and “at or below” altitudes on all designated segment(s) to all runways for all published instrument approach procedures when the reported airport temperature is at or below the published CTA temperature on the approach plate. A pilot may request an altitude correction (if desired) on any approach at any United States airport when extreme cold temperature is encountered. Pilots making a correction must comply with ATC reporting requirements.

**5.3 Correctable altitudes:** ATC does not apply a cold temperature correction to their Minimum Vectoring Altitude (MVA) or Minimum IFR Altitude (MIA) charts. Pilots must request approval from ATC to apply a cold temperature correction to any ATC assigned altitude. Pilots must not correct altitudes published on Standard Instrument Departures (SIDs), Obstacle Departure Procedures (ODPs), and Standard Terminal Arrivals (STARs).

**5.4 Use of corrected MDA/DA:** Pilots will use the corrected MDA or DA as the minimum altitude for an approach. Pilots must meet the requirements in 14 CFR Part 91.175 in order to operate below the corrected MDA or DA. Pilots must see and avoid obstacles when descending below the minimum altitude on the approach.

### **NOTE-**

*The corrected DA or MDA does not affect the visibility minima published for the approach. With the application of a cold temperature correction to the DA or MDA, the airplane should be in a position on the glideslope/glidepath or at the published missed approach point to identify the runway environment.*

**5.5 Acceptable use of table for manual CTA altitude correction** (see TBL ENR 1.8-1): Pilots may calculate a correction with a visual interpolation of the chart when using reported temperature and height above airport. This calculated altitude correction may then be rounded to the nearest whole hundred or rounded up. For example, a correction of 130 ft from the chart may be rounded to 100 ft or 200 ft. A correction of 280 ft will be rounded up to 300 ft. This rounded correction will be added to the appropriate altitudes for the “Individual” or “All” segment method. The correction calculated from the table for the MDA or DA may be used as is or rounded up, but never rounded down. This number will be added to the MDA, DA, and all step-down fix altitudes inside of the FAF/PFAF.


**5.5.1** No extrapolation above the 5000 ft column is required. Pilots may use the 5000 ft “height above airport in feet” column for calculating corrections when the calculated altitude is greater than 5000 ft above reporting station elevation. Pilots must add the correction(s) from the table to the affected segment altitude(s) and fly at the new corrected altitude. Do not round down when using the 5000 ft column for calculated height above airport values greater than 5000 ft. Pilots may extrapolate above the 5000 ft column to apply a correction if desired.

**5.5.2** These techniques have been adopted to minimize pilot distraction by limiting the number of entries into the table when making corrections. Although not all altitudes on the approach will be corrected back to standard day values, a safe distance above the terrain/obstacle will be maintained on the corrected approach segment(s). Pilots may calculate a correction for each fix based on the fix altitude if desired.

**NOTE-**

*Pilots may use Real Time Mesoscale Analysis (RTMA): Alternate Report of Surface Temperature, for computing altitude corrections, when airport temperatures are not available via normal reporting.*

**5.6** How to apply Cold Temperature Altitude Corrections on an Approach.

**5.6.1** All Segments Method: Pilots may correct all segment altitudes from the IAF altitude to the MA final holding altitude. Pilots familiar with the information in this section and the procedures for accomplishing the all segments method, only need to use the published “snowflake” icon,  /CTA temperature limit on the approach chart for making corrections. Pilots are not required to reference the CTA list. The altitude correction is calculated as follows:

**5.6.1.1** Manual correction: Pilots will make a manual correction when the aircraft is not equipped with a temperature compensating system or when a compensating system is not used to make the correction. Use TBL ENR 1.8-1, ICAO Cold Temperature Error Table to calculate the correction needed for the approach segment(s).

a) Correct all altitudes from the FAF/PFAF up to and including the IAF altitude: Calculate the correction by taking the FAF/PFAF altitude and subtracting the airport elevation. Use this number to enter the height above airport column in TBL ENR 1.8-1 until reaching the reported temperature from the “Reported Temperature” row. Round this number as applicable and then add to all altitudes from the FAF altitude through the IAF altitude.

b) Correct all altitudes in the final segment: Calculate the correction by taking the MDA or DA for the approach being flown and subtract the airport elevation. Use this number to enter the height above airport column in TBL ENR 1.8-1 until reaching the reported temperature from the “Reported Temperature” row. Use this number or round up to next nearest 100 ft. Add this number to MDA or DA, and any step-down fix altitudes in the final segment.

c) Correct final holding altitude in the MA Segment: Calculate the correction by taking the MA holding altitude and subtract the airport elevation. Use this number to enter the height above airport column in TBL ENR 1.8-1 until reaching the reported temperature from the “Reported Temperature” row. Round this number as applicable and then add to the final MA altitude only.

**5.6.1.2** Aircraft with temperature compensating systems: If flying an aircraft equipped with a system capable of temperature compensation, follow the instructions for applying temperature compensation provided in the airplane flight manual (AFM), AFM supplement, or system operating manual. Ensure that temperature compensation system is on and active prior to the IAF and remains active throughout the entire approach and missed approach.

a) Pilots that have a system that is able to calculate a temperature-corrected DA or MDA may use the system for this purpose.

b) Pilots that have a system unable to calculate a temperature corrected DA or MDA will manually calculate an altitude correction for the MDA or DA.

**NOTE-**

*Some systems apply temperature compensation only to those altitudes associated with an instrument approach procedure loaded into the active flight plan, while other systems apply temperature compensation to all procedure altitudes or user entered altitudes in the active flight plan, including altitudes associated with a Standard Terminal Arrival (STAR). For those systems that apply temperature compensation to all altitudes in the active flight plan, delay activating temperature compensation until the aircraft has passed the last altitude constraint associated with the active STAR.*

**5.6.2** Individual Segment(s) Method: Pilots are allowed to correct only the marked segment(s) indicated in the CTA list ([https://www.faa.gov/air\\_traffic/flight\\_info/aeronav/digital\\_products/dtpp/search/](https://www.faa.gov/air_traffic/flight_info/aeronav/digital_products/dtpp/search/)). Pilots using the Individual Segment(s) Method will reference the CTA list to determine which segment(s) need a correction. (See FIG ENR 1.8-1.)

FIG ENR 1.8–1  
Example Cold Temperature Restricted Airport List – Required Segments

Identifier	Airport name	Temperature	Initial	Intermediate	Final	Missed
<b>Montana</b>						
KBTM	Bert Mooney	–25C	X	X	X	
KBZN	Bozeman Yellowstone Intl	–31C		X		
KEKS	Ennis Big Sky	–25C			X	
KGPI	Glacier Park Intl	–15C		X		
KHLN	Helena Rgnl	–17C	X	X	X	

**5.6.2.1** Manual Correction: Pilots will make a manual correction when the aircraft is not equipped with a temperature compensating system or when a compensating system is not used to make the correction. Use TBL ENR 1.8–1, ICAO Cold Temperature Error Table, to calculate the correction needed for the approach segment(s).

**a) Initial Segment:** All altitudes from the intermediate fix (IF) altitude up to and including the IAF altitude. The correction may be accomplished by using the IF altitude or by using the All Segments Method (a) Manual correction (1). To correct the initial segment by using the IF altitude, subtract the airport elevation from the IF altitude. Use this number to enter the height above airport column in TBL ENR 1.8–1 until reaching the reported temperature from the “Reported Temperature” row. Round this number as applicable and then add to the IF, IAF, and any step-down fix altitudes.

**b) Intermediate Segment:** All altitudes from the FAF/PFAF up to but not including the IF altitude. Calculate the correction by taking FAF/PFAF altitude and subtracting the airport elevation. Use this number to enter the height above airport column in TBL ENR 1.8–1 until reaching the reported temperature from the “Reported Temperature” row. Round this number as applicable and then add to FAF altitude and all step-down fix altitudes within the intermediate segment (inside of the waypoint labeled “IF”).

**c) Final segment:** Calculate the correction by taking the MDA or DA for the approach flown and subtract the airport elevation. Use this number to enter the height above airport column in TBL ENR 1.8–1 until reaching the reported temperature from the “Reported Temperature” row. Use this number or round up to next nearest 100 ft. Add this number to MDA or DA and any applicable step-down fix altitudes in the final segment.

**d) Missed Approach Segment:** Calculate the correction by taking the final MA holding altitude and subtract the airport elevation. Use this number to enter the height above airport column in TBL ENR 1.8–1 until reaching the reported temperature from the “Reported Temperature” row. Round this number as applicable and then add to the final MA altitude only.

**5.6.2.2** Aircraft with temperature compensating system: If flying an aircraft equipped with a system capable of temperature compensation, follow the instructions for applying temperature compensation provided in the AFM, AFM supplement, or system operating manual. Ensure the temperature compensation system is on and active prior to the segment(s) being corrected. Manually calculate an altimetry correction for the MDA or DA. Determine an altimetry correction from the ICAO table based on the reported airport temperature and the height difference between the MDA or DA, as applicable, and the airport elevation, or use the compensating system to calculate a temperature corrected altitude for the published MDA or DA if able.

**5.7** Communication: Pilots must request approval from ATC whenever applying a cold temperature altitude correction. Pilots do not need to inform ATC of the final approach segment correction (i.e., new MDA or DA). This request should be made on initial radio contact with the ATC facility issuing the approach clearance. ATC requires this information in order to ensure appropriate vertical separation between known traffic. Pilots should query ATC when vectored altitudes to a segment are lower than the requested corrected altitude. Pilots are encouraged to self-announce corrected altitude when flying into a non-towered airfield.

**5.7.1** The following are examples of appropriate pilot-to-ATC communication when applying cold-temperature altitude corrections:

**5.7.1.1** On initial check-in with ATC providing approach clearance: Missoula, MT (example below).

- a) Vectors to final approach course: Outside of IAFs: “Request 9700 ft. for cold temperature operations.”
- b) Vectors to final approach course: Inside of ODIRE: “Request 7300 ft. for cold temperature operations.”
- c) Missed Approach segment: “Require final holding altitude, 12500 ft. on missed approach for cold temperature operations.”

**5.7.1.2** Pilots cleared by ATC for an instrument approach procedure; “Cleared the RNAV (GPS) Y RWY 12 approach (from any IAF)”. Missoula, MT (example below).

- a) IAF: “Request 9700 ft. for cold temperature operations at LANNY, CHARL, or ODIRE.”

## **6. Example for Calculating Altitude Corrections on CTAs**

All 14 CFR Part 97 IAPs must be corrected at an airport. The following example provides the steps for correcting the different segments of an approach and will be applied to all 14 CFR Part 97 IAPs.

**6.1** Missoula Intl (KMSO). Reported Temperature  $-12^{\circ}\text{C}$ : RNAV (GPS) Y RWY 12.

**6.1.1** All Segments Method: All segments corrected from IAF through MA holding altitude.

**6.1.1.1** Manual calculation:

- a) Cold Temperature Airport Temperature Limit:  $-12^{\circ}\text{C}$ .
- b) Altitude at the Final Approach Fix (FAF) (SUPPY) = 6200 ft.
- c) Airport elevation = 3206 ft.
- d) Difference:  $6200 \text{ ft.} - 3206 \text{ ft.} = 2994 \text{ ft.}$
- e) Use TBL ENR 1.8–1, ICAO Cold Temperature Error Table, height above airport of 2994 ft. and  $-12^{\circ}\text{C}$ . Visual interpolation is approximately 300 ft. Actual interpolation is 300 ft.
- f) Add 300 ft. to the FAF and all procedure altitudes outside of the FAF up to and including IAF altitude(s):
  - 1) LANNY (IAF), CHARL (IAF), and ODIRE (IAF Holding-in-Lieu):  $9400 + 300 = 9700 \text{ ft.}$
  - 2) CALIP (stepdown fix):  $7000 + 300 = 7300 \text{ ft.}$
  - 3) SUPPY (FAF):  $6200 + 300 = 6500 \text{ ft.}$
- g) Correct altitudes within the final segment altitude based on the minima used. LNAV MDA = 4520 ft.
- h) Difference:  $4520 \text{ ft.} - 3206 \text{ ft.} = 1314 \text{ ft.}$
- i) TBL ENR 1.8–1: 1314 ft. at  $-12^{\circ}\text{C}$  is approximately 150 ft. Use 150 ft. or round up to 200 ft.
- j) Add corrections to altitudes up to but not including the FAF:
  - 1) BEGPE (stepdown fix):  $4840 + 150 = 4990 \text{ ft.}$
  - 2) LNAV MDA:  $4520 + 150 = 4670 \text{ ft.}$
- k) Correct JENKI/Missed Approach Holding Altitude: MA altitude is 12000 ft.
  - 1) JENKI:  $12000 - 3206 = 8794 \text{ ft.}$
- l) TBL ENR 1.8–1: 8794 ft. at  $-12^{\circ}\text{C}$ . Enter table at  $-12^{\circ}\text{C}$  and intersect the 5000 ft. height above airport column. The approximate value is 500 ft.
- m) Add correction to holding fix final altitude:
  - 1) JENKI:  $12000 + 500 = 12500 \text{ ft.}$

**6.1.1.2** Temperature Compensating System: Operators using a temperature compensating RNAV system to make altitude corrections will be set to the current airport temperature ( $-12^{\circ}\text{C}$ ) and activated prior to passing the IAF. A manual calculation of the cold temperature altitude correction is required for the MDA/DA.

**6.1.2 Individual Segments Method:** Missoula requires correction in the intermediate and final segments. However, in this example, the missed approach is also shown.

**6.1.2.1 Manual Calculation:** Use the appropriate steps in the All Segments Method above to apply a correction to the required segment.

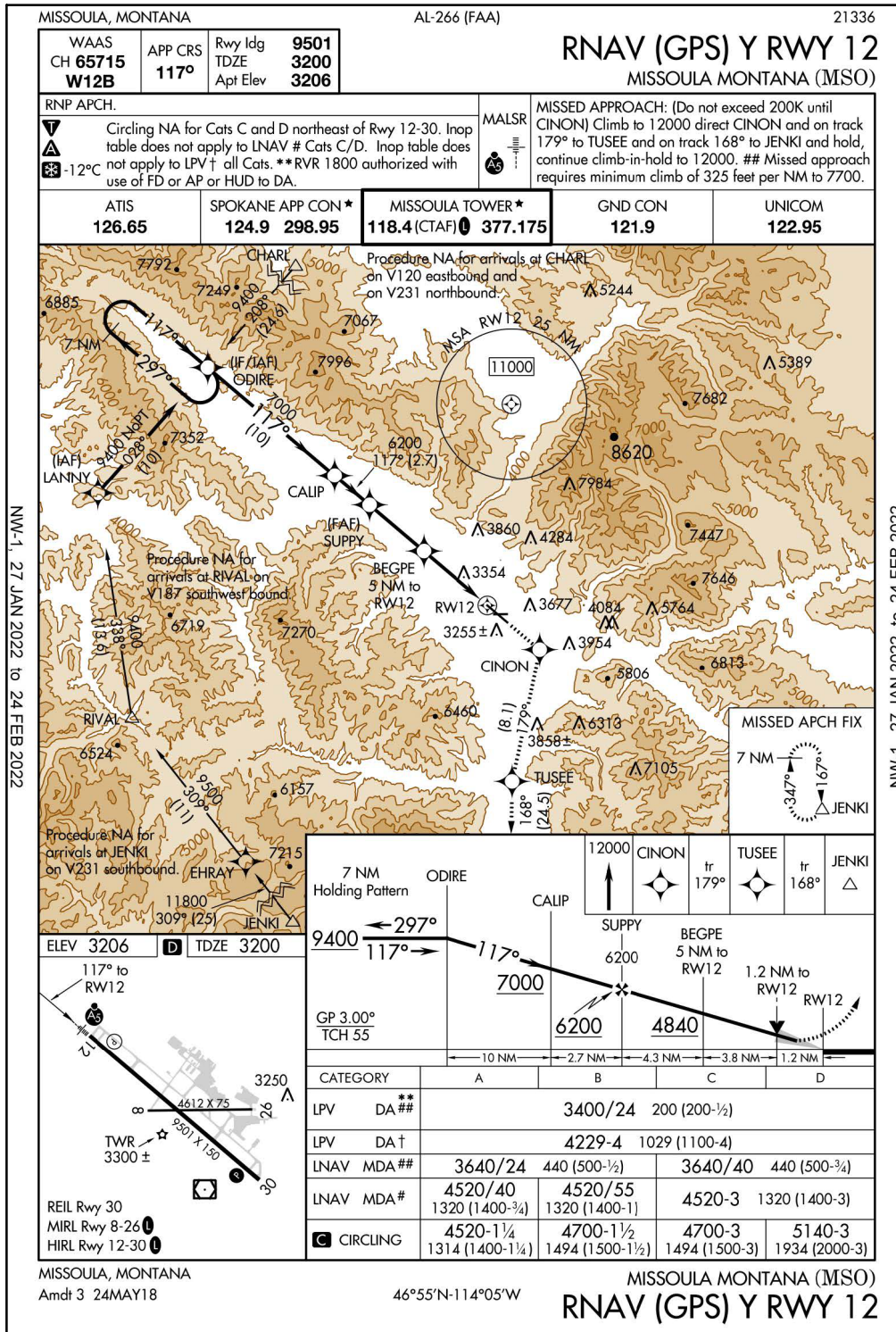
a) Intermediate. Use steps 6.1.1.1 a) thru e). Do not correct the IAF or IF when using individual segments method.

b) Final. Use steps 6.1.1.1 f) thru i).

c) Missed Approach. Use steps 6.1.1.1 j) thru l).

**6.1.2.2 Temperature Compensating System:** Operators using a temperature compensating RNAV system to make altitude corrections will be set to the current airport temperature ( $-12^{\circ}\text{C}$ ) and activated at a point needed to correct the altitude for the segment. A manual calculation of the cold temperature altitude correction is required for the MDA/DA.

FIG ENR 1.8-2  
Missoula Intl RNAV (GPS) Y RWY 12





## **ENR 1.9 [RESERVED]**



## ENR 1.10 Flight Planning (Restriction, Limitation or Advisory Information)

### 1. Preflight Preparation

**1.1** Prior to every flight, pilots should gather all information vital to the nature of the flight, assess whether the flight would be safe, and then file a flight plan. Pilots can receive a regulatory compliant briefing without contacting Flight Service. Pilots are encouraged to use automated resources and review Advisory Circular AC 91-92, Pilot's Guide to a Preflight Briefing, for more information. Pilots who prefer to contact Flight Service are encouraged to conduct a self-brief prior to calling. Conducting a self-brief before contacting Flight Service provides familiarity of meteorological and aeronautical conditions applicable to the route of flight and promotes a better understanding of weather information. Pilots may access Flight Service through [www.1800wxbrief.com](http://www.1800wxbrief.com) or by calling 1-800-WX-BRIEF. Flight planning applications are also available for conducting a self-briefing and filing flight plans.

**NOTE-**

*Alaska only: Pilots filing flight plans via "fast file" who desire to have their briefing recorded, should include a statement at the end of the recording as to the source of their weather briefing.*

**1.2** The information required by the FAA to process flight plans is obtained from FAA Form 7233-4, International Flight Plan. Only DOD users, and civilians who file stereo route flight plans, may use FAA Form 7233-1, Flight Plan.

**NOTE-**

*FAA and DOD Flight Plan Forms are equivalent. Where the FAA specifies Form 7233-1, Domestic Flight Plan, and FAA Form 7233-4, International Flight Plan, the DOD may substitute their Form DD 175, Military Flight Plan and Form DD-1801, DOD International Flight Plan as necessary. NAS automation systems process and convert data in the same manner, although for computer acceptance, input fields may be adjusted to follow FAA format.*

**1.3** FSSs are required to advise of pertinent NOTAMs if a *standard* briefing is requested, but if they are overlooked, do not hesitate to remind the specialist that you have not received NOTAM information. Additionally, FSS briefers do not provide FDC NOTAM information for special instrument approach procedures unless specifically asked. Pilots authorized by the FAA to use special instrument approach procedures must specifically request FDC NOTAM information for these procedures. Pilots who receive the information electronically will receive NOTAMs for special IAPs automatically.

**NOTE-**

*Domestic Notices and International Notices are not provided during a briefing unless specifically requested by the pilot since the FSS specialist has no way of knowing whether the pilot has already checked the Federal NOTAM System (FNS) NOTAM Search External links or Air Traffic Plans and Publications website prior to calling. Airway NOTAMs, procedural NOTAMs, and NOTAMs that are general in nature and not tied to a specific airport/facility (for example, flight advisories and restrictions, open duration special security instructions, and special flight rules areas) are briefed solely by pilot request. Remember to ask for these notices if you have not already reviewed this information, and to request all pertinent NOTAMs specific to your flight.*

**1.4** Pilots are urged to use only the latest issue of aeronautical charts in planning and conducting flight operations. Aeronautical charts are revised and reissued on a periodic basis to ensure that depicted data are current and reliable. In the conterminous U.S., sectional charts are updated each 6 months, IFR en route charts each 56 days, and amendments to civil IFR approach charts are accomplished on a 56-day cycle with a change notice volume issued on the 28-day mid-cycle. Charts that have been superseded by those of a more recent date may contain obsolete or incomplete flight information.

**REFERENCE-**

*AIP, GEN 3.2, contains a description of aeronautical charts.*

**1.5** When requesting a preflight briefing, identify yourself as a pilot and provide the following:

**1.5.1** Type of flight planned; e.g., VFR or IFR.

**1.5.2** Aircraft number or pilot's name.

**1.5.3** Aircraft type.

**1.5.4** Departure airport.

**1.5.5** Route of flight.

**1.5.6** Destination.

**1.5.7** Flight altitude(s).

**1.5.8** ETD and ETE.

**1.6** Prior to conducting a briefing, briefers are required to have the background information listed above so that they may tailor the briefing to the needs of the proposed flight. The objective is to communicate a “picture” of meteorological and aeronautical information necessary for the conduct of a safe and efficient flight. Briefers use all available weather and aeronautical information to summarize data applicable to the proposed flight. Pilots who have briefed themselves before calling Flight Service should advise the briefer what information has been obtained from other sources.

**REFERENCE-**

*See AIP, GEN 3.5 for meteorological services.*

**1.7** The Federal Aviation Administration has designated High Density Traffic Airports (HDTA) and has prescribed air traffic rules and requirements for operating aircraft (excluding helicopter operations) to and from these airports.

**REFERENCE-**

*AIP, GEN 3.3, Paragraph 9.7, Airport Reservations Operations and Procedures.*

**1.8** In addition to the filing of a flight plan, if the flight will traverse or land in one or more foreign countries, it is particularly important that pilots leave a complete itinerary with someone directly concerned and keep that person advised of the flight's progress. If serious doubt arises as to the safety of the flight, that person should first contact the FSS.

**1.9** Pilots operating under the provisions of 14 CFR Part 135 without an FAA assigned 3-letter designator, must prefix the normal registration (N) number with the letter “T” on flight plan filing.

**EXAMPLE-**

*TN 1234B.*

## **1.10 Cold Temperature Operations**

**1.10.1** Pilots should begin planning for cold temperature operations during the preflight planning phase. Cold temperatures produce barometric altimetry errors, which affect instrument flight procedures. There are currently two temperature limitations that may be published in the notes box of the middle briefing strip on an instrument approach procedure (IAP). The two published temperature limitations are:

**1.10.1.1** A temperature range limitation associated with the use of baro-VNAV that may be published on a United States PBN IAP titled RNAV (GPS) or RNAV (RNP); and/or

**1.10.1.2** A Cold Temperature Airport (CTA) limitation designated by a snowflake ICON and temperature in Celsius (C) that is published on every IAP for the airfield.

**1.10.2** Pilots should request the lowest forecast temperature +/- 1 hour for arrival and departure operations. If the temperature is forecast to be outside of the baro-VNAV or at or below the CTA temperature limitation, consider the following:

**1.10.2.1** When using baro-VNAV with an aircraft that does not have an automated temperature compensating function, pilots should plan to use the appropriate minima and/or IAP.

**1.10.2.2** The RNAV (RNP) procedure may not be accomplished without an approved automated temperature compensating function if the temperature is outside of the baro-VNAV temperature range limitation.

**1.10.3** If the temperature is forecast to be at or below the published CTA temperature, pilots should calculate a correction for the appropriate segment/s or a correction for all the segments if using the “All Segments Method.”

Pilots should review the operating procedures for the aircraft’s temperature compensating system when planning to use the system for any cold temperature corrections. Any planned altitude correction for the intermediate and/or missed approach holding segments must be coordinated with ATC. Pilots do not have to advise ATC of a correction in the final segment.

**NOTE-**

*The charted baro-VNAV temperature range limitation does not apply to pilots operating aircraft with an airworthiness approval to conduct an RNAV (GPS) approach to LNAV/VNAV minimums with the use of SBAS vertical guidance.*

**REFERENCE-**

*AIP, ENR 1.8, Cold Temperature Barometric Altimeter Errors, Setting Procedures and Cold Temperature Airports (CTA).*

## **2. Follow IFR Procedures Even When Operating VFR**

**2.1** To maintain IFR proficiency, pilots are urged to practice IFR procedures whenever possible, even when operating VFR. Some suggested practices include:

**2.1.1** Obtain a complete preflight briefing and check NOTAMs. Prior to every flight, pilots should gather all information vital to the nature of the flight. Pilots can receive a regulatory compliant briefing without contacting Flight Service. Pilots are encouraged to use automated resources and review AC 91-92, Pilot’s Guide to a Preflight Briefing, for more information. NOTAMs are available online from the Federal NOTAM System (FNS) NOTAM Search website (<https://notams.aim.faa.gov/notamSearch/>), private vendors, or on request from Flight Service.

**2.1.2** File a flight plan. This is an excellent low cost insurance policy. The cost is the time it takes to fill it out. The insurance includes the knowledge that someone will be looking for you if you become overdue at your destination. Pilots can file flight plans either by using a website or by calling Flight Service. Flight planning applications are also available to file, activate, and close VFR flight plans.

**2.1.3** Use current charts.

**2.1.4** Use the navigation aids. Practice maintaining a good course by keeping the needle centered.

**2.1.5** Maintain a constant altitude appropriate for direction of flight.

**2.1.6** Estimate en route position times.

**2.1.7** Make accurate and frequent position reports to the FSSs along your route of flight.

**2.2** Simulated IFR flight is recommended (under the hood); however, pilots are cautioned to review and adhere to the requirements specified in 14 CFR Section 91.109 before and during such flight.

**2.3** When flying VFR at night, in addition to the altitude appropriate for the direction of flight, pilots should maintain an altitude which is at or above the minimum en route altitude as shown on charts. This is especially true in mountainous terrain, where there is usually very little ground reference. Do not depend on your eyes alone to avoid rising unlighted terrain, or even lighted obstructions such as TV towers.

## **3. Notice to Air Missions (NOTAM) System**

**3.1** The NOTAM System provides pilots with time critical aeronautical information that is temporary, or information to be published on aeronautical charts at a later date, or information from another operational publication. The NOTAM is cancelled when the information in the NOTAM is published on the chart or when the temporary condition is returned to normal status. NOTAMs may be disseminated up to 7 days before the start of activity. Pilots can access NOTAM information online via NOTAM Search at: <https://notams.aim.faa.gov/notamSearch/> or from an FSS.

**3.1.1** 14 CFR § 91.103, Preflight Action directs pilots to become familiar with all available information concerning a planned flight prior to departure, including NOTAMs. Pilots may change their flight plan based on available information. Current NOTAM information may affect:

**3.1.1.1** Aerodromes.

**3.1.1.2** Runways, taxiways, and ramp restrictions.

**3.1.1.3** Obstructions.

**3.1.1.4** Communications.

**3.1.1.5** Airspace.

**3.1.1.6** Status of navigational aids or radar service availability.

**3.1.1.7** Other information essential to planned en route, terminal, or landing operations.

**3.1.2** Pilots should also review NOTAMs for the ARTCC area (for example, Washington Center (ZDC), Cleveland Center (ZOB), etc.) in which the flight will be operating. You can find the 3 letter code for each ARTCC on the FAA’s NOTAM web page. These NOTAMs may affect the planned flight. Some of the operations include Central Altitude Reservation Function (CARF), Special Use Airspace (SUA), Temporary Flight Restrictions (TFR), Global Positioning System (GPS), Flight Data Center (FDC) changes to routes, wind turbine, and Unmanned Aircraft System (UAS).

**NOTE–**

*NOTAM information is transmitted using ICAO contractions to reduce transmission time. See TBL ENR 1.10–2 for a listing of the most commonly used contractions, or go online to the following URL: <https://www.notams.faa.gov/downloads/contractions.pdf>. For a complete listing of approved NOTAM Contractions, see FAA JO Order 7340.2, Contractions.*

**3.1.3** Pilots should also contact ATC or FSS while en route to obtain updated airfield information for their destination. This is particularly important when flying to the airports without an operating control tower. Pilots should also ensure NOTAMs are updated for locations without an operating control tower. Snow removal, fire and rescue activities, construction, and wildlife encroachment, could provide hazards to pilots. This information may not be available to pilots prior to arrival/departure.

**3.1.4** Pilots should check NOTAMs to ensure NAVAIDs required for the flight are in service. A NOTAM is published when a NAVAID is out of service or Unserviceable (U/S). A NOTAM is the primary method of alerting pilots to its unavailability. Although a NAVAID is deemed U/S and planned for removal from service, it may be a long time before that NAVAID is officially decommissioned and removed from charts. It is recommended that pilots using VFR charts should regularly consult the Chart Update Bulletin. This bulletin identifies any updates to the chart that have not yet been accounted for.

**3.2** The FAA issues information on the status of GPS through the NOTAM system. Operators may find information on GPS satellite outages, GPS testing, and GPS anomalies by specifically searching for GPS NOTAMS prior to flight.

**3.2.1** The NOTAM system uses the terms UNRELIABLE (UNREL), MAY NOT BE AVAILABLE (AVBL), and NOT AVAILABLE (AVBL) when describing the status of GPS. UNREL indicates the expected level of service of the GPS and/or WAAS may not be available. Pilots must then determine the adequacy of the signal for desired use. Aircraft should have additional navigation equipment for their intended route.

**NOTE–**

*Unless associated with a known testing NOTAM, pilots should report GPS anomalies, including degraded operation and/or loss of service, as soon as possible via radio or telephone, and via the GPS Anomaly Reporting Form. (See ENR 4.1–22.)*

**3.2.2** GPS operations may also be NOTAMed for testing. This is indicated in the NOTAM language with the name of the test in parenthesis. When GPS testing NOTAMS are published and testing is actually occurring, ATC will advise pilots requesting or cleared for a GPS or RNAV (GPS) approach that GPS may not be available and request intentions. TBL ENR 1.10–1 lists an example of a GPS testing NOTAM.

**3.3** NOTAM information is classified as Domestic NOTAMs (NOTAM D), Flight Data Center (FDC) NOTAMs, International NOTAMs, or Military NOTAMs.

**3.3.1 NOTAM (D)** information is disseminated for all navigational facilities that are part of the National Airspace System (NAS), all public use aerodromes, seaplane bases, and heliports listed in the Chart Supplement U.S. NOTAM (D) information includes taxiway closures, personnel and equipment near or crossing runways, and airport lighting aids that do not affect instrument approach criteria (i.e., VGSI). All NOTAM Ds must have one of the keywords listed in TBL ENR 1.10–1, as the first part of the text after the location identifier. These keywords categorize NOTAM Ds by subject, for example, APRON (ramp), RWY (runway), SVC (Services), etc. There are several types of NOTAM Ds:

**3.3.1.1** Aerodrome activity and conditions, to include field conditions.

**3.3.1.2** Airspace to include CARF, SUA, and general airspace activity like UAS or pyrotechnics.

**3.3.1.3** Visual and radio navigational aids.

**3.3.1.4** Communication and services.

**3.3.1.5** Pointer NOTAMs. NOTAMs issued to point to additional aeronautical information. When pointing to another NOTAM, the keyword in the pointer NOTAM must match the keyword in the original NOTAM. Pointer NOTAMs should be issued for, but are not limited to, TFRs, Airshows, Temporary SUA, major NAS system interruptions, etc.

**3.3.1.6 NOTAM Ds that crossover into International NOTAMs.** These NOTAMs contain the same data as NOTAM Ds, only they are referenced differently. They are categorized, stored, and issued with a series letter preceding them and are distributed via Service A to countries requesting NOTAMs for that airport. The FAA currently uses the Series A (and may use Series K) for this type of NOTAM.

**3.3.2** FDC NOTAMs are issued when it is necessary to disseminate regulatory information. FDC NOTAMs include:

**3.3.2.1** Amendments to published IAPs and other current aeronautical charts.

**3.3.2.2** Temporary Flight Restrictions (TFRs) restrict entrance to a certain airspace at a certain time, however, some TFRs provide relief if ATC permission is given to enter the area when requested. Online preflight resources for TFRs provide graphics and plain language interpretations.

**3.3.2.3** High barometric pressure warning.

**3.3.2.4** Laser light activity.

**3.3.2.5** ADS–B, TIS–B, and FIS–B service availability.

**3.3.2.6** Satellite–based systems such as WAAS or GPS.

**3.3.2.7** Special Notices.

### **3.3.3 International NOTAMs.**

**3.3.3.1** International NOTAMs are published in ICAO format per Annex 15 and distributed to multiple countries. International NOTAMs issued by the U.S. NOTAM Office use Series A followed by 4 sequential numbers, a slant “/” and a 2–digit number representing the year the NOTAM was issued. International NOTAMs basically duplicate data found in a U.S. Domestic NOTAM.

**3.3.3.2** Not every topic of a U.S. Domestic NOTAM is issued as an International NOTAM by the U.S. The U.S. International NOTAM will be linked to the appropriate U.S. Domestic NOTAM when possible.

**3.3.3.3** International NOTAMs received by the FAA from other countries are stored in the U.S. NOTAM System.

**3.3.3.4** The International NOTAM format includes a “Q” Line that can be easily read/parsed by a computer and allows the NOTAM to be displayed digitally.

- a) Field A: ICAO location identifier or FIR affected by the NOTAM.

- b) Field B: Start of Validity.
- c) Field C: End of Validity (both in [Year][Month][Day][Hour][Minute] format).
- d) Field D: (when present) Schedule.
- e) Field E: Full NOTAM description.
- f) Field F: (when present) Lowest altitude, or “SFC.”
- g) Field G: (when present) Highest altitude, or “UNL.”

**3.3.3.5** For more on International format, please see Annex 15.

**3.3.4 Military NOTAMs.** NOTAMs originated by the U.S. Air Force, Army, Marine, or Navy, and pertaining to military or joint-use navigational aids/airports that are part of the NAS. Military NOTAMs are published in the International NOTAM format and should be reviewed by users of a military or joint-use facility.

**3.4 Security NOTAMS.** U.S. Domestic Security NOTAMS are FDC NOTAMS that inform pilots of curtail U.S. security activities or requirements, such as Special Security Instructions for aircraft operations to, from, within, or transitioning U.S. territorial airspace. These NOTAMS are found on the Federal NOTAM System (FNS) NOTAM Search website under the location designator KZZZ.

**3.4.1 United States International Flight Prohibitions, Potential Hostile Situations, and Foreign Notices** are issued by the FAA and are found on the Federal NOTAM System (FNS) NOTAM Search website under the location designator KICZ.

*TBL ENR 1.10-1*  
**NOTAM Keywords**

<b>Keyword</b>	<b>Definition</b>
<b>RWY</b> ..... <i>Example</i>	<b>Runway</b> !BNA BNA RWY 18/36 CLSD YYMMDDHHMM-YYMMDDHHMM
<b>TWY</b> ..... <i>Example</i>	<b>Taxiway</b> !BTV BTV TWY C EDGE LGT OBSC YYMMDDHHMM-YYMMDDHHMM
<b>APRON</b> ..... <i>Example</i>	<b>Apron/Ramp</b> !BNA BNA APRON NORTH APN E 100FT CLSD YYMMDDHHMM-YYMMDDHHMM
<b>AD</b> ..... <i>Example</i>	<b>Aerodrome</b> !BET BET AD AP ELK NEAR MOVEMENT AREAS YYMMDDHHMM-YYMMDDHHMM
<b>OBST</b> ..... <i>Example</i>	<b>Obstruction</b> !SJT SJT OBST MOORED BALLOON WI AN AREA DEFINED AS 1NM RADIUS OF SJT 2430FT (510FT AGL) FLAGGED YYMMDDHHMM-YYMMDDHHMM
<b>NAV</b> ..... <i>Example</i>	<b>Navigation Aids</b> !SHV SHV NAV ILS RWY 32 110.3 COMMISSIONED YYMMDDHHMM-PERM
<b>COM</b> ..... <i>Example</i>	<b>Communications</b> !INW INW COM REMOTE COM OUTLET 122.6 U/S YYMMDDHHMM-YYMMDDHHMM EST (Note* EST will auto cancel)
<b>SVC</b> ..... <i>Example</i>	<b>Services</b> !ROA ROA SVC TWR COMMISSIONED YYMMDDHHMM-PERM
<b>AIRSPACE</b> .. <i>Example</i>	<b>Airspace</b> !MHV MHV AIRSPACE AEROBATIC ACFT WI AN AREA DEFINED AS 4.3NM RADIUS OF MHV 5500FT-10500FT AVOIDANCE ADZ CTC JOSHUA APP DLY YYMMDDHHMM-YYMMDDHHMM
<b>ODP</b> ..... <i>Example</i>	<b>Obstacle Departure Procedure</b> !FDC 2/9700 DIK ODP DICKINSON - THEODORE ROOSEVELT RGNL, DICKINSON, ND. TAKEOFF MINIMUMS AND (OBSTACLE) DEPARTURE PROCEDURES AMDT 1... DEPARTURE PROCEDURE: RWY 25, CLIMB HEADING 250 TO 3500 BEFORE TURNING LEFT. ALL OTHER DATA REMAINS AS PUBLISHED. THIS IS TAKEOFF MINIMUMS AND (OBSTACLE) DEPARTURE PROCEDURES, AMDT 1A. YYMMDDHHMM-PERM
<b>SID</b> ..... <i>Example</i>	<b>Standard Instrument Departure</b> !FDC x/xxxx DFW SID DALLAS/FORT WORTH INTL, DALLAS, TX. PODDE THREE DEPARTURE... CHANGE NOTES TO READ: RWYS 17C/R, 18L/R: DO NOT EXCEED 240KT UNTIL LARRN. RWYS 35L/C, 36L/R: DO NOT EXCEED 240KT UNTIL KMART YYMMDDHHMM-YYMMDDHHMM



<b>Keyword</b>	<b>Definition</b>
<b>STAR</b> . . . . . <i>Example</i>	<b>Standard Terminal Arrival</b> !FDC x/xxxx DCA STAR RONALD REAGAN WASHINGTON NATIONAL, WASHINGTON, DC. WZRRD TWO ARRIVAL... SHAAR TRANSITION: ROUTE FROM DRUZZ INT TO WZRRD INT NOT AUTHORIZED. AFTER DRUZZ INT EXPECT RADAR VECTORS TO AML VORTAC YYMMDDHHMM-YYM-MDDHHMM
<b>CHART</b> . . . . . <i>Example</i>	<b>Chart</b> !FDC 2/9997 DAL IAP DALLAS LOVE FIELD, DALLAS, TX. ILS OR LOC RWY 31R, AMDT 5... CHART NOTE: SIMULTANEOUS APPROACH AUTHORIZED WITH RWY 31L. MISSED APPROACH: CLIMB TO 1000 THEN CLIMBING RIGHT TURN TO 5000 ON HEADING 330 AND CVE R-046 TO FINGR INT/ CVE 36.4 DME AND HOLD. CHART LOC RWY 31L. THIS IS ILS OR LOC RWY 31R, AMDT 5A. YYM-MDDHHMM-PERM
<b>DATA</b> . . . . . <i>Example</i>	<b>Data</b> !FDC 2/9700 DIK ODP DICKINSON - THEODORE ROOSEVELT RGNL, DICKINSON, ND. TAKEOFF MINIMUMS AND (OBSTACLE) DEPARTURE PROCEDURES AMDT 1... DEPARTURE PROCEDURE: RWY 25, CLIMB HEADING 250 TO 3500 BEFORE TURNING LEFT. ALL OTHER DATA REMAINS AS PUBLISHED. THIS IS TAKEOFF MINIMUMS AND (OBSTACLE) DEPARTURE PROCEDURES, AMDT 1A. YYMMDDHHMM-PERM
<b>IAP</b> . . . . . <i>Example</i>	<b>Instrument Approach Procedure</b> !FDC 2/9997 DAL IAP DALLAS LOVE FIELD, DALLAS, TX. ILS OR LOC RWY 31R, AMDT 5... CHART NOTE: SIMULTANEOUS APPROACH AUTHORIZED WITH RWY 31L. MISSED APPROACH: CLIMB TO 1000 THEN CLIMBING RIGHT TURN TO 5000 ON HEADING 330 AND CVE R-046 TO FINGR INT/ CVE 36.4 DME AND HOLD. CHART LOC RWY 31L. THIS IS ILS OR LOC RWY 31R, AMDT 5A. YYM-MDDHHMM-PERM
<b>VFP</b> . . . . . <i>Example</i>	<b>Visual Flight Procedures</b> !FDC X/XXXX JFK VFP JOHN F KENNEDY INTL, NEW YORK, NY. PARKWAY VISUAL RWY 13L/R, ORIG... WEATHER MINIMUMS 3000 FOOT CEILING AND 3 MILES VISIBILITY. YYMMDDHHMM-YYMMDDHHMM
<b>ROUTE</b> . . . . . <i>Example</i>	<b>Route</b> !FDC x/xxxx ZFW ROUTE ZFW ZKC. V140 SAYRE (SYO) VORTAC, OK TO TULSA (TUL) VORTAC, OK MEA 4300. YYMMDDHHMM-YYMMDDHHMM EST
<b>SPECIAL</b> . . . . . <i>Example</i>	<b>Special</b> !FDC x/xxxx JNU SPECIAL JUNEAU INTERNATIONAL, JUNEAU, AK. LDA-2 RWY 8 AMDT 9 PROCEDURE TURN NA. YYMMDDHHMM-YYMMDDHHMM
<b>SECURITY</b> . . . . . <i>Example</i>	<b>Security</b> !FDC x/xxxx FDC ...SPECIAL NOTICE... THIS IS A RESTATEMENT OF A PREVIOUSLY ISSUED ADVISORY NOTICE. IN THE INTEREST OF NATIONAL SECURITY AND TO THE EXTENT PRACTICABLE, PILOTS ARE STRONGLY ADVISED TO AVOID THE AIRSPACE ABOVE, OR IN PROXIMITY TO SUCH SITES AS POWER PLANTS (NUCLEAR, HYDRO-ELECTRIC, OR COAL), DAMS, REFINERIES, INDUSTRIAL COMPLEXES, MILITARY FACILITIES AND OTHER SIMILAR FACILITIES. PILOTS SHOULD NOT CIRCLE AS TO LOITER IN THE VICINITY OVER THESE TYPES OF FACILITIES.
<b>GPS TESTING</b> . . . . . <i>Example</i>	<b>Global Positioning System Testing</b> !GPS 01/028 ZAB NAV GPS (YPG_AZ GPS 21-06)(INCLUDING WAAS, GBAS, AND ADS-B) MAYNOT BE AVBL WI A276NM RADIUS CENTERED AT 332347N1142221W (BLH108023) FL400-UNL, 232NM RADIUS AT FL250, 164NM RADIUS AT 100000FT 160NM RADIUS AT 4000FT AGL 126NM RADIUS AT 50FT AGL DLY 1830-2230 2101281830-2101292230
<b>PRN (GPS)</b> . . . . . <i>Example</i>	Pseudo-random noise code used differentiate GPS satellites. This code allows any receiver to identify exactly which satellite(s) it is receiving. !GPS GPS NAV PRN 16 U/S 2109231600-2109242300EST

TBL ENR 1.10-2  
Contractions Commonly Found in NOTAMs

<b>A</b>	
ABN .....	Aerodrome Beacon
ACFT .....	Aircraft
ACT .....	Active
ADJ .....	Adjacent
AGL .....	Above Ground Level
ALS .....	Approach Light System
AP .....	Airport
APN .....	Apron
APP .....	Approach control office <i>or</i> approach control <i>or</i> approach control service
ARST .....	Arresting ( <i>specify (part of) aircraft arresting equipment</i> )
ASDA .....	Accelerate Stop Distance Available
ASPH .....	Asphalt
AUTH .....	Authorized <i>or</i> authorization
AVBL .....	Available <i>or</i> availability
AVGAS .....	Aviation gasoline
AWOS .....	Automatic Weather Observing System
AZM .....	Azimuth
<b>B</b>	
BA .....	Braking action
BCN .....	Beacon ( <i>aeronautical ground light</i> )
BCST .....	Broadcast
BDRY .....	Boundary
BLDG .....	Building
BLW .....	Below
BTN .....	Between
<b>C</b>	
C .....	Center ( <i>preceded by runway designator number to identify a parallel runway</i> )
CD .....	Clearance delivery
CIV .....	Civil
CL .....	Centerline
CLSD .....	Close <i>or</i> closed <i>or</i> closing
COM .....	Communication
CONC .....	Concrete
COND .....	Condition
CONS .....	Continuous
CONST .....	Construction <i>or</i> constructed
CPDLC .....	Controller Pilot Data Link Communications
CTC .....	Contact
CUST .....	Customs
<b>D</b>	
DA .....	Decision altitude
DEG .....	Degrees
DEP .....	Depart <i>or</i> Departure
DER .....	Departure end of the runway
DH .....	Decision Height
DIST .....	Distance
DLY .....	Daily
DP .....	Dew Point Temperature
DPT .....	Depth
DTHR .....	Displaced Runway Threshold

<b>E</b>	
E .....	East <i>or</i> eastern longitude
EB .....	Eastbound
EMERG .....	Emergency
ENE .....	East-northeast
EQPT .....	Equipment
ESE .....	East-southeast
EST .....	Estimate <i>or</i> estimated <i>or</i> estimation ( <i>message type designator</i> )
EXC .....	Except
<b>F</b>	
FL .....	Flight level
FREQ .....	Frequency
FRI .....	Friday
FSS .....	Flight Service Station
FST .....	First
FT .....	Feet ( <i>dimensional unit</i> )
<b>G</b>	
G .....	Green
GA .....	General aviation
GLD .....	Glider
GND .....	Ground
GP .....	Glide Path
GRVL .....	Gravel
<b>H</b>	
HEL .....	Helicopter
HGT .....	Height <i>or</i> height above
HLDG .....	Holding
HLP .....	Heliport
HVY .....	Heavy
<b>I</b>	
IFR .....	Instrument Flight Rules
ILS .....	Instrument Landing System
IM .....	Inner Marker
INOP .....	Inoperative
INT .....	Intersection
<b>K</b>	
KT .....	Knots
<b>L</b>	
L .....	Left ( <i>preceded by runway designator number to identify a parallel runway</i> )
LAT .....	Latitude
LDA .....	Landing Distance Available
LDG .....	Landing
LEN .....	Length
LGT .....	Light <i>or</i> lighting
LGTD .....	Lighted
LOC .....	Localizer
LONG .....	Longitude
<b>M</b>	
MAINT .....	Maintenance
MBST .....	Microburst
MIL .....	Military

MIN .....	Minutes
MNT .....	Monitor <i>or</i> monitoring <i>or</i> monitored
MON .....	Monday
MOV .....	Move <i>or</i> moving <i>or</i> movement
<b>N</b>	
N .....	North
NAVAID .....	Navigational aid
NB .....	Northbound
NDB .....	Nondirectional Radio Beacon
NE .....	Northeast
NEB .....	Northeast bound
NM .....	Nautical Mile/s
NNE .....	North-northeast
NNW .....	North-northwest
NOV .....	November
NW .....	Northwest
NWB .....	Northwest bound
<b>O</b>	
OBSC .....	Obscure <i>or</i> obscured <i>or</i> obscuring
OBST .....	Obstacle
OPN .....	Open <i>or</i> opening <i>or</i> opened
OPS .....	Operations
<b>P</b>	
PAPI .....	Precision Approach Path Indicator
PARL .....	Parallel
PAX .....	Passenger/s
PCL .....	Pilot Controlled Lighting
PCT .....	Percent
PERM .....	Permanent
PJE .....	Parachute Jumping Activities
PLA .....	Practice Low Approach
PPR .....	Prior Permission Required
PRN .....	Pseudo-random Navigation
PT .....	Procedure Turn
<b>R</b>	
R .....	Red
R .....	Right ( <i>preceded by runway designator number to identify a parallel runway</i> )
RAI .....	Runway Alignment Indicator
RCL .....	Runway Centerline
RCLL .....	Runway Centerline Light
REDL .....	Receive/Receiver
RLLS .....	Runway Lead-in Light System
RMK .....	Remark
RTS .....	Return to Service
RTZL .....	Runway Touchdown Zone Light(s)
RVR .....	Runway Visual Range
RWY .....	Runway
<b>S</b>	
S .....	South <i>or</i> southern latitude
SA .....	Sand

SAT .....	Saturday
SB .....	Southbound
SE .....	Southeast
SEC .....	Seconds
SFC .....	Surface
SN .....	Snow
SR .....	Sunrise
SS .....	Sunset
SSR .....	Secondary surveillance radar
SSW .....	South-southwest
STD .....	Standard
SUN .....	Sunday
SW .....	Southwest
SWB .....	Southwest bound
<b>T</b>	
TAR .....	Terminal area surveillance radar
TAX .....	Taxing <i>or</i> taxiing
TDZ .....	Touchdown Zone
TEMPO .....	Temporary <i>or</i> temporarily
TFC .....	Traffic
THR .....	Threshold
THU .....	Thursday
TKOF .....	Takeoff
TODA .....	Take-off Distance Available
TORA .....	Take-off Run Available
TRG .....	Training
TUE .....	Tuesday
TWR .....	Aerodrome Control Tower
TWY .....	Taxiway
TX .....	Taxilane
<b>U</b>	
U/S .....	Unserviceable
UAS .....	Unmanned Aircraft System
UNL .....	Unlimited
UNREL .....	Unreliable
<b>V</b>	
VIS .....	Visibility
VOR .....	VHF Omni-Directional Radio Range
VORTAC .....	VOR and TACAN (collocated)
VOT .....	VOR Test Facility
<b>W</b>	
W .....	West <i>or</i> western longitude
WB .....	Westbound
WDI .....	Wind Direction Indicator
WED .....	Wednesday
WI .....	Within
WID .....	Width <i>or</i> wide
WIP .....	Work in progress
WNW .....	West-northwest
WS .....	Wind shear
WSW .....	West-southwest

## 4. Operational Information System (OIS)

**4.1** The FAA’s Air Traffic Control System Command Center (ATCSCC) maintains a website with near real–time National Airspace System (NAS) status information. NAS operators are encouraged to access the website at [www.fly.faa.gov](http://www.fly.faa.gov) prior to filing their flight plan.

**4.1.1** The website consolidates information from advisories. An advisory is a message that is disseminated electronically by the ATCSCC that contains information pertinent to the NAS.

**4.1.1.1** Advisories are normally issued for the following items:

- a) Ground Stops.
- b) Ground Delay Programs.
- c) Route Information.
- d) Plan of Operations.
- e) Facility Outages and Scheduled Facility Outages.
- f) Volcanic Ash Activity Bulletins.
- g) Special Traffic Management Programs.

**4.1.1.2** This list is not all–inclusive. Any time there is information that may be beneficial to a large number of people, an advisory may be sent. Additionally, there may be times when an advisory is not sent due to workload or the short length of time of the activity.

**4.1.1.3** Route information is available on the website and in specific advisories. Some route information, subject to the 56–day publishing cycle, is located on the “OIS” under “Products,” Route Management Tool (RMT), and “What’s New” Playbook. The RMT and Playbook contain routings for use by Air Traffic and NAS operators when they are coordinated “real–time” and are then published in an ATCSCC advisory.

**4.1.1.4** Route advisories are identified by the word “Route” in the header; the associated action is required (RQD), recommended (RMD), planned (PLN), or for your information (FYI). Operators are expected to file flight plans consistent with the Route RQD advisories.

**4.1.1.5** Electronic System Impact Reports are on the intranet at <http://www.atcsc.faa.gov/ois/> under “System Impact Reports.” This page lists scheduled outages/events/projects that significantly impact the NAS; for example, runway closures, air shows, and construction projects. Information includes anticipated delays and traffic management initiatives (TMI) that may be implemented.

## 5. Flight Plan – VFR Flights

*(See Appendix 2, FAA Form 7233–4 – International Flight Plan)*

**5.1** The requirements for the filing and activation of VFR flight plans can vary depending in which airspace the flight is operating. Pilots are responsible for activating flight plans with a Flight Service Station. Control tower personnel do not automatically activate VFR flight plans.

**5.1.1** Within the continental U.S., a VFR flight plan is not normally required.

**5.1.2** VFR flights (except for DOD and law enforcement flights) into an Air Defense Identification Zone (ADIZ) are required to file DVFR flight plans.

**NOTE–**

*Detailed ADIZ procedures are found in Section 6, National Security and Interception Procedures, of this chapter. (See 14 CFR Part 99).*

**5.1.3** Flights within the Washington, DC Special Flight Rules Area have additional requirements that must be met. Visit <http://www.faa.safety.gov> for the required Special Awareness Training that must be completed before flight within this area.

**5.1.4** VFR flight to an international destination requires a filed and activated flight plan.

**NOTE-**

*ICAO flight plan guidance is published in ICAO Document 4444 PANS-ATM Appendix 2.*

**5.2** It is strongly recommended that a VFR flight plan be filed with a Flight Service Station or equivalent flight plan filing service. When filing, pilots must use FAA Form 7233-4, International Flight Plan or DD Form 1801. Only DOD users, and civilians who file stereo route flight plans, may use FAA Form 7233-1, Flight Plan. Pilots may take advantage of advances in technology by filing their flight plans using any available electronic means. Activating the flight plan will ensure that you receive VFR Search and Rescue services.

**5.3** When a stopover flight is anticipated, it is recommended that a separate flight plan be filed for each leg of the flight.

**5.4** Pilots are encouraged to activate their VFR flight plans with Flight Service by the most expeditious means possible. This may be via radio or other electronic means. VFR flight plan proposals are normally retained for two hours following the proposed time of departure.

**5.5** Pilots may also activate a VFR flight plan by using an assumed departure time. This assumed departure time will cause the flight plan to become active at the designated time. This may negate the need for communication with a flight service station or flight plan filing service upon departure. It is the pilot's responsibility to revise his actual departure time, time en route, or ETA with flight service.

**NOTE-**

*Pilots are strongly advised to remain mindful when using an assumed departure time. If not updated, search and rescue activities will be based on the assumed departure time.*

**5.6** U.S. air traffic control towers do not routinely activate VFR flight plans. Foreign pilots especially must be mindful of the need to communicate directly with a flight service station, or use an assumed departure time procedure clearly communicated with the flight plan filing service.

**5.7** Although position reports are not required for VFR flight plans, periodic reports to FSSs along the route are good practice. Such contacts permit significant information to be passed to the transiting aircraft and also serve to check the progress of the flight should it be necessary for any reason to locate the aircraft.

**5.8** Pilots flying VFR should fly an appropriate cruising altitude for their direction of flight.

**5.9** When filing a VFR Flight plan, indicate the appropriate aircraft equipment capability as prescribed for an IFR flight plan.

**5.10** ATC radar history data can be useful in finding a downed or missing aircraft; therefore, surveillance equipment should be listed in Item 18. Pilots using commercial GPS tracking services are encouraged to note the specific service in Item 19 N/ (survival equip remarks) of FAA Form 7233-4 or DD Form 1801.

## **6. Flight Plan – IFR Flights**

*(See Appendix 2, FAA Form 7233-4 – International Flight Plan)*

### **6.1 General**

**6.1.1** Use of FAA Form 7233-4 or DD Form 1801 is mandatory for:

**6.1.1.1** Assignment of RNAV SIDs and STARs or other PBN routing,

**6.1.1.2** All IFR flights that will depart U.S. domestic airspace, and

**6.1.1.3** Domestic IFR flights except military/DOD and civilians who file stereo route flight plans.

**6.1.1.4** All military/DOD IFR flights that will depart U.S. controlled airspace.

**6.1.2** Military/DOD flights using FAA Form 7233-1 or DD Form 175, may not be eligible for assignment of RNAV SIDs or STARs. Military flights desiring assignment of these procedures should file using FAA Form 7233-4 or DD 1801, as described in this section.

**6.1.3** When filing an IFR flight plan using FAA Form 7233–4 or DD Form 1801, it is recommended that filers include all operable navigation, communication, and surveillance equipment capabilities by adding appropriate equipment qualifiers as shown in Appendix 2, FAA Form 7233–4, International Flight Plan.

**6.1.4** ATC issues clearances based on aircraft capabilities filed in Items 10 and 18 of FAA Form 7233–4. Operators should file all capabilities for which the aircraft and crew is certified, capable, and authorized. PBN/capability must be filed in Item 18, Other Information. When filing a capability, ATC expects filers to use that capability for example; answer a SATVOICE call from ATC if code M1 or M3 is filed in Item 10.

**6.1.5** Prior to departure from within, or prior to entering controlled airspace, a pilot must submit a complete flight plan and receive an air traffic clearance, if weather conditions are below VFR minimums. IFR flight plans may be submitted to an FSS or flight plan filing service.

**6.1.6** Pilots should file IFR flight plans at least 30 minutes prior to estimated time of departure to preclude possible delay in receiving a departure clearance from ATC.

**6.1.7** In order to provide FAA traffic management units strategic route planning capabilities, nonscheduled operators conducting IFR operations above FL 230 are requested to voluntarily file IFR flight plans at least 4 hours prior to estimated time of departure (ETD).

**6.1.8** To minimize your delay in entering Class B, Class C, Class D, and Class E surface areas at destination when IFR weather conditions exist or are forecast at that airport, an IFR flight plan should be filed before departure. Otherwise, a 30 minute delay is not unusual in receiving an ATC clearance because of time spent in processing flight plan data.

**6.1.9** Traffic saturation frequently prevents control personnel from accepting flight plans by radio. In such cases, the pilot is advised to contact a flight plan filing service for the purpose of filing the flight plan.

**6.1.10** When requesting an IFR clearance, it is highly recommended that the departure airport be identified by stating the city name and state and/or the airport location identifier in order to clarify to ATC the exact location of the intended airport of departure.

**6.1.11** Multiple versions of flight plans for the same flight may lead to unsafe conditions and errors within the air traffic system. Pilots must not file more than one flight plan for the same flight without ensuring that the previous flight plan has been successfully removed.

**6.1.12** When a pilot is aware that the possibility for multiple flight plans on the same aircraft may exist, ensuring receipt of a full route clearance will help mitigate chances of error.

## **6.2 Airways and Jet Routes Depiction on Flight Plan**

**6.2.1** It is vitally important that the route of flight be accurately and completely described in the flight plan. To simplify definition of the proposed route, and to facilitate ATC, pilots are requested to file via airways or jet routes established for use at the altitude or flight level planned.

**6.2.2** If flight is to be conducted via designated airways or jet routes, describe the route by indicating the type and number designators of the airway(s) or jet route(s) requested. If more than one airway or jet route is to be used, clearly indicate points of transition. If the transition is made at an unnamed intersection, show the next succeeding NAVAID or named intersection on the intended route and the complete route from that point. Reporting points may be identified by using authorized name/code as depicted on appropriate aeronautical charts. The following two examples illustrate the need to specify the transition point when two routes share more than one transition fix.

### **EXAMPLE–**

**1.** *ALB J37 BUMPY J14 BHM Spelled out: from Albany, New York, via Jet Route 37 transitioning to Jet Route 14 at BUMPY intersection, thence via Jet Route 14 to Birmingham, Alabama.*

**2.** *ALB J37 ENO J14 BHM Spelled out: from Albany, New York, via Jet Route 37 transitioning to Jet Route 14 at Smyrna VORTAC (ENO) thence via Jet Route 14 to Birmingham, Alabama.*

**6.2.3** The route of flight may also be described by naming the reporting points or NAVAIDs over which the flight will pass, provided the points named are established for use at the altitude or flight level planned.

**EXAMPLE–**

*BWI V44 SWANN V433 DQO Spelled out: from Baltimore–Washington International, via Victor 44 to Swann intersection, transitioning to Victor 433 at Swann, thence via Victor 433 to Dupont.*

**6.2.4** When the route of flight is defined by named reporting points, whether alone or in combination with airways or jet routes, and the navigational aids (VOR, VORTAC, TACAN, NDB) to be used for the flight are a combination of different types of aids, enough information should be included to clearly indicate the route requested.

**EXAMPLE–**

*LAX J5 LKV J3 GEG YXC FL 330 J500 VLR J515 YWG Spelled out: from Los Angeles International via Jet Route 5 Lakeview, Jet Route 3 Spokane, direct Cranbrook, British Columbia VOR/DME, Flight Level 330 Jet Route 500 to Langruth, Manitoba VORTAC, Jet Route 515 to Winnipeg, Manitoba.*

**6.2.5** When filing IFR, it is to the pilot's advantage to file a preferred route.

**REFERENCE–**

*Preferred IFR Routes are described and tabulated in the Chart Supplement U.S. Additionally available at U.S. [http://www.fly.faa.gov/Products/Coded\\_Departure\\_Routes/NFDC\\_PREFERRED\\_Routes\\_Database/nfdc\\_preferred\\_routes\\_database.html](http://www.fly.faa.gov/Products/Coded_Departure_Routes/NFDC_PREFERRED_Routes_Database/nfdc_preferred_routes_database.html).*

**6.2.6** ATC may issue a SID or a STAR, as appropriate.

**REFERENCE–**

*AIP, ENR 1.5, Para 3, Standard Terminal Arrival (STAR) Procedures.  
AIP, ENR 1.5, Para 37, Instrument Departure Procedures (DP) – Obstacle Departure Procedures (ODP), Standard Instrument Departures (SID), and Diverse Vector Areas (DVA).*

**NOTE–**

*Pilots not desiring an RNAV SID or RNAV STAR should enter in Item #18, PBN code: NAV/RNV A0 and/or D0.*

## **6.3 Direct Flights**

**6.3.1** All or any portions of the route which will not be flown on the radials or courses of established airways or routes, such as direct route flights, must be defined by indicating the radio fixes over which the flight will pass. Fixes selected to define the route must be those over which the position of the aircraft can be accurately determined. Such fixes automatically become compulsory reporting points for the flight, unless advised otherwise by ATC. Only those navigational aids established for use in a particular structure; i.e., in the low or high structures, may be used to define the en route phase of a direct flight within that altitude structure.

**6.3.2** The azimuth feature of VOR aids and the azimuth and distance (DME) features of VORTAC and TACAN aids are assigned certain frequency protected areas of airspace which are intended for application to established airway and route use, and to provide guidance for planning flights outside of established airways or routes. These areas of airspace are expressed in terms of cylindrical service volumes of specified dimensions called “class limits” or “categories.”

**REFERENCE–**

*AIP, GEN 3.4, Para 3.1.4, NAVAID Service Volumes.*

**6.3.3** An operational service volume has been established for each class in which adequate signal coverage and frequency protection can be assured. To facilitate use of VOR, VORTAC, or TACAN aids, consistent with their operational service volume limits, pilot use of such aids for defining a direct route of flight in controlled airspace should not exceed the following:

**6.3.3.1** Operations above FL 450 – Use aids not more than 200 NM apart. These aids are depicted on en route high altitude charts.

**6.3.3.2** Operation off established routes from 18,000 feet MSL to FL 450 – Use aids not more than 260 NM apart. These aids are depicted on en route high altitude charts.

**6.3.3.3** Operation off established airways below 18,000 feet MSL – Use aids not more than 80 NM apart. These aids are depicted on en route low altitude charts.

**6.3.3.4** Operation off established airways between 14,500 feet MSL and 17,999 feet MSL in the conterminous U.S. – (H) facilities not more than 200 NM apart may be used.

**6.3.4** Increasing use of self-contained airborne navigational systems which do not rely on the VOR/VORTAC/TACAN system has resulted in pilot requests for direct routes which exceed NAVAID service volume limits.

**6.3.5** At times, ATC will initiate a direct route in a surveillance environment which exceeds NAVAID service volume limits. Pilots must adhere to the altitude specified in the clearance.

**6.3.6** Appropriate airway or jet route numbers may also be included to describe portions of the route to be flown.

**EXAMPLE-**

*MDW V262 BDF V10 BRL STJ SLN GCK Spelled out: from Chicago Midway Airport via Victor 262 to Bradford, Victor 10 to Burlington, Iowa, direct St. Joseph, Missouri, direct Salina, Kansas, direct Garden City, Kansas.*

**NOTE-**

*When route of flight is described by radio fixes, the pilot will be expected to fly a direct course between the points named.*

**6.3.7** Pilots are reminded that they are responsible for adhering to obstruction clearance requirements on those segments of direct routes that are outside of controlled airspace and ATC surveillance capability. The MEAs and other altitudes shown on IFR en route charts pertain to those route segments within controlled airspace, and those altitudes may not meet obstruction clearance criteria when operating off those routes.

**NOTE-**

*Refer to 14 CFR 91.177 for pilot responsibility when flying random point to point routes.*

**6.4 Area Navigation (RNAV)/Global Navigation Satellite System (GNSS)**

**6.4.1** When not being radar monitored, GNSS-equipped RNAV aircraft on random RNAV routes must be cleared via or reported to be established on a point-to-point route.

**6.4.1.1** The points must be published NAVAIDs, waypoints, fixes or airports recallable from the aircraft's navigation database. The points must be displayed on controller video maps or depicted on the controller chart displayed at the control position. When applying non-radar separation the maximum distance between points must not exceed 500 miles.

**6.4.1.2** ATC will protect 4 miles either side of the route centerline.

**6.4.1.3** Assigned altitudes must be at or above the highest MIA along the projected route segment being flown, including the protected airspace of that route segment.

**6.4.2** Pilots of aircraft equipped with approved area navigational equipment may file for RNAV routes throughout the National Airspace System in accordance with the following procedures:

**6.4.2.1** File airport-to-airport flight plans.

**6.4.2.2** File the appropriate indication of RNAV and/or RNP capability in the flight plan.

**6.4.2.3** Plan the random route portion of the flight plan to begin and end over appropriate arrival and departure transition fixes or appropriate navigation aids for the altitude stratum within which the flight will be conducted. The use of normal preferred departure and arrival routes (DP/STAR), where established, is recommended.

**6.4.2.4** File route structure transitions to and from the random route portion of the flight.

**6.4.2.5** Define the random route by waypoints. File route description waypoints by using degree distance fixes based on navigational aids which are appropriate for the altitude stratum.

**6.4.2.6** File a minimum of one route description waypoint for each ARTCC through whose area the random route will be flown. These waypoints must be located within 200 NM of the preceding center's boundary.

**6.4.2.7** File an additional route description waypoint for each turn point in the route.

**6.4.2.8** Plan additional route description waypoints as required to ensure accurate navigation via the filed route of flight. Navigation is the pilot's responsibility unless ATC assistance is requested.



**6.4.2.9** Plan the route of flight so as to avoid prohibited and restricted airspace by 3 NM unless permission has been obtained to operate in that airspace and the appropriate ATC facilities are advised.

**NOTE–**

*To be approved for use in the National Airspace System, RNAV equipment must meet system availability, accuracy, and airworthiness standards. For additional information and guidance on RNAV equipment requirements see Advisory Circular (AC) 20–138, Airworthiness Approval of Positioning and Navigation Systems, and AC 90–100, U.S. Terminal and En Route Area Navigation (RNAV) Operations.*

**6.4.3** Pilots of aircraft equipped with latitude/ longitude coordinate navigation capability, independent of VOR/TACAN references, may file for random RNAV using the following procedures:

**6.4.3.1** File airport–to–airport flight plans prior to departure.

**6.4.3.2** File the appropriate RNAV capability certification suffix in the flight plan.

**6.4.3.3** Plan the random route portion of the flight to begin and end over published departure/arrival transition fixes or appropriate navigation aids for airports without published transition procedures. The use of preferred departure and arrival routes, such as DP and STAR where established, is recommended.

**6.4.3.4** Plan the route of flight so as to avoid prohibited and restricted airspace by 3 NM unless permission has been obtained to operate in that airspace and the appropriate ATC facility is advised.

**6.4.3.5** Define the route of flight after the departure fix, including each intermediate fix (turnpoint) and the arrival fix for the destination airport in terms of latitude/longitude coordinates plotted to the nearest minute or in terms of Navigation Reference System (NRS) waypoints. For latitude/ longitude filing the arrival fix must be identified by both the latitude/longitude coordinates and a fix identifier.

**EXAMPLE–**

*MIA<sup>1</sup> SRQ<sup>2</sup> 3407/10615<sup>3</sup> 3407/11546 TNP<sup>4</sup> LAX<sup>5</sup>*

<sup>1</sup> *Departure airport.*

<sup>2</sup> *Departure fix.*

<sup>3</sup> *Intermediate fix (turning point).*

<sup>4</sup> *Arrival fix.*

<sup>5</sup> *Destination airport.*

*or*

*ORD<sup>1</sup> IOW<sup>2</sup> KP49G<sup>3</sup> KD34U<sup>4</sup> KL16O<sup>5</sup> OAL<sup>6</sup> MOD2<sup>7</sup> SFO<sup>8</sup>*

<sup>1</sup> *Departure airport.*

<sup>2</sup> *Transition fix.*

<sup>3</sup> *Minneapolis ARTCC waypoint.*

<sup>4</sup> *Denver ARTCC Waypoint.*

<sup>5</sup> *Los Angeles ARTCC waypoint.*

<sup>6</sup> *Transition fix.*

<sup>7</sup> *Arrival.*

<sup>8</sup> *Destination airport.*

**6.4.3.6** Record latitude/longitude coordinates by two or four figures describing latitude in degrees followed by a N or S, followed by 3 or 5 digits longitude followed by an E or W. Separate latitude and longitude with a solidus “/”. Use leading zeros if necessary.

**6.4.3.7** File at FL 390 or above for the random RNAV portion of the flight.

**6.4.3.8** Fly all routes/route segments on Great Circle tracks.

**6.4.3.9** Make any inflight requests for random RNAV clearances or route amendments to an en route ATC facility.

## 7. Flight Plan – Defense VFR (DVFR) Flights

VFR flights (except for DOD and law enforcement flights) into an ADIZ are required to file DVFR flight plans for security purposes. Detailed ADIZ procedures are found in section ENR 1.12, National Security and Interception Procedures.

### REFERENCE-

14 CFR Part 99, Security Control of Air Traffic.

**7.1** DVFR flight plans must be filed using FAA Form 7233-4 or DD Form 1801.

**7.2** Enter the letter “D” in Item 8b of FAA Form 7233-4 or DD Form 1801.

**7.3** DVFR flights where pilots decline search and rescue coverage must clearly indicate “NORIV” in Item 18 following the indicator “RMK/”. This flight plan must still be activated in order to properly notify NORAD, however no flight plan cancellation will be expected.

### EXAMPLE-

RMK/NORIV

## 8. Single Flights Conducted With Both VFR and IFR Flight Plans

**8.1** Flight plans which combine VFR operation on an active VFR flight plan for one portion of a flight, and IFR for another portion, sometimes known as a composite flight plan, cannot be accepted or processed by current en route automation systems.

**8.2** Pilots are free to operate VFR in VFR conditions prior to accepting an IFR clearance from the appropriate control facility, or may cancel an IFR clearance and proceed VFR as desired. However, if a pilot desires to be on an active VFR flight plan, with search and rescue provisions, for the portion of flight not conducted under an IFR clearance, a separate VFR flight plan must be filed, activated, and closed.

**8.3** If a pilot desires to be on an active VFR flight plan prior to or following the IFR portion of the flight, that flight plan must be filed and processed as a distinct and separate flight plan. The VFR flight plan must be opened and closed with either a Flight Service Station or other service provider having the capability to open and close VFR flight plans. Air Traffic Control does not have the ability to determine if an aircraft is operating on an active VFR flight plan and cannot process the activation or cancellation of a VFR flight plan.

**8.4** Pilots may propose to commence the IFR portion of flight at a defined airborne point. This airborne point, or fix, is entered as the departure point in Item 13 of FAA Form 7233-4 or DD Form 1801.

**8.5** Pilots may indicate in the IFR flight plan the intention to terminate the IFR portion of flight at any defined airborne point. The airborne point, or fix, is entered as the destination point in Item 16 of FAA Form 7233-4 or DD Form 1801.

**8.6** Prior to beginning the IFR portion of flight, a pilot must receive an IFR clearance from the appropriate control facility.

**8.7** If the pilot does not desire further clearance after reaching the clearance limit, he or she must advise ATC to cancel the IFR clearance.

## 9. Change in Proposed Departure Time

**9.1** To prevent computer saturation in the en route environment, parameters have been established to delete proposed departure flight plans which have not been activated. Most centers have this parameter set so as to delete these flight plans a minimum of 2 hours after the proposed departure time or Expect Departure Clearance Time (EDCT). To ensure that a flight plan remains active, pilots whose actual departure time will be delayed 2 hours or more beyond their filed departure time, are requested to notify ATC of their new proposed departure time.

**9.2** Due to traffic saturation, ATC personnel frequently will be unable to accept these revisions via radio. It is recommended that you forward these revisions to a flight plan service provider or FSS.

## 10. Other Changes

**10.1** In addition to altitude/flight level, destination, and/or route changes, increasing or decreasing the speed of an aircraft constitutes a change in a flight plan. Therefore, at any time the average true airspeed at cruising altitude between reporting points varies or is expected to vary from that given in the flight plan by plus or minus 5 percent, or 10 knots, whichever is greater, air traffic control should be advised.

## 11. Canceling Flight Plans

### 11.1 Closing VFR and DVFR Flight Plans

**11.1.1** A pilot is responsible for ensuring that his/her VFR or DVFR flight plan is canceled. You should close your flight plan with the nearest FSS, or if one is not available, you may request any ATC facility to relay your cancellation to the FSS. Control towers do not automatically close VFR or DVFR flight plans as they may not be aware that a particular VFR aircraft is on a flight plan. If you fail to report or cancel your flight plan within  $\frac{1}{2}$  hour after your ETA, search and rescue procedures are started.

### 11.2 Canceling IFR Flight Plan

**11.2.1** 14 CFR Section 91.153 includes the statement “When a flight plan has been activated, the pilot in command, upon canceling or completing the flight under the flight plan, must notify an FAA Flight Service Station or ATC facility.”

**11.2.2** An IFR flight plan may be canceled at any time the flight is operating in VFR conditions outside Class A airspace by the pilot stating “CANCEL MY IFR FLIGHT PLAN” to the controller or air/ground station with which he/she is communicating. Immediately after canceling an IFR flight plan, a pilot should take necessary action to change to the appropriate air/ground frequency, VFR radar beacon code, and VFR altitude or flight level.

**11.2.3** ATC separation and information services will be discontinued, including radar services (where applicable). Consequently, if the canceling flight desires VFR radar advisory service, the pilot must specifically request it.

#### **NOTE–**

*Pilots must be aware that other procedures may be applicable to a flight that cancels an IFR flight plan within an area where a special program, such as a designated terminal radar service area, Class C airspace or Class B airspace, has been established.*

**11.2.4** If a DVFR flight plan requirement exists, the pilot is responsible for filing this flight plan to replace the canceled IFR flight plan. If a subsequent IFR operation becomes necessary, a new IFR flight plan must be filed and an ATC clearance obtained before operating in IFR conditions.

**11.2.5** If operating on an IFR flight plan to an airport with a functioning control tower, the flight plan is automatically closed upon landing.

**11.2.6** If operating on an IFR flight plan to an airport where there is no functioning control tower, the pilot must initiate cancellation of the IFR flight plan. This can be done after landing if there is a functioning FSS or other means of direct communications with ATC. In the event there is no FSS and air/ground communications with ATC is not possible below a certain altitude, the pilot would, weather conditions permitting, cancel his/her IFR flight plan while still airborne and able to communicate with ATC by radio. This will not only save the time and expense of canceling the flight plan by telephone but will quickly release the airspace for use by other aircraft.

### 11.3 RNAV and RNP Operations

**11.3.1** During the pre-flight planning phase the availability of the navigation infrastructure required for the intended operation, including any non-RNAV contingencies must be confirmed for the period of intended operation. Availability of the onboard navigation equipment necessary for the route to be flown must be confirmed. Pilots are reminded that on composite VFR to IFR flight plan, or on an IFR clearance, while flying unpublished departures via RNAV into uncontrolled airspace, the PIC is responsible for terrain and obstruction clearance until reaching the MEA/MIA/MVA/OROCA.

**NOTE–**

*OROCA is a published altitude which provides 1,000 feet of terrain and obstruction clearance in the US (2,000 feet of clearance in designated mountainous areas). These altitudes are not assessed for NAVAID signal coverage, air traffic control surveillance, or communications coverage, and are published for general situational awareness, flight planning and in-flight contingency use.*

**11.3.2** If a pilot determines a specified RNP level cannot be achieved, revise the route or delay the operation until appropriate RNP level can be ensured.

**11.3.3** The onboard navigation database must be current and appropriate for the region of intended operation and must include the navigation aids, waypoints, and coded terminal airspace procedures for the departure, arrival and alternate airfields.

**11.3.4** During system initialization, pilots of aircraft equipped with a Flight Management System or other RNAV–certified system, must confirm that the navigation database is current, and verify that the aircraft position has been entered correctly. Flight crews should crosscheck the cleared flight plan against charts or other applicable resources, as well as the navigation system textual display and the aircraft map display. This process includes confirmation of the waypoints sequence, reasonableness of track angles and distances, any altitude or speed constraints, and identification of fly–by or fly–over waypoints. A procedure must not be used if validity of the navigation database is in doubt.

**11.3.5** Prior to commencing takeoff, the flight crew must verify that the RNAV system is operating correctly and the correct airport and runway data have been loaded.

**11.3.6** During the pre–flight planning phase RAIM prediction must be performed if TSO–C129() equipment is used to solely satisfy the RNAV and RNP requirement. GPS RAIM availability must be confirmed for the intended route of flight (route and time) using current GPS satellite information. In the event of a predicted, continuous loss of RAIM of more than five (5) minutes for any part of the intended flight, the flight should be delayed, canceled, or re–routed where RAIM requirements can be met. Operators may satisfy the predictive RAIM requirement through any one of the following methods:

**11.3.6.1** Operators may monitor the status of each satellite in its plane/slot position, by accounting for the latest GPS constellation status (e.g., NOTAMs or NANUs), and compute RAIM availability using model–specific RAIM prediction software;

**11.3.6.2** Operators may use the Service Availability Prediction Tool (SAPT) on the FAA en route and terminal RAIM prediction website;

**11.3.6.3** Operators may contact a Flight Service Station to obtain non–precision approach RAIM;

**11.3.6.4** Operators may use a third party interface, incorporating FAA/VOLPE RAIM prediction data without altering performance values, to predict RAIM outages for the aircraft’s predicted flight path and times;

**11.3.6.5** Operators may use the receiver’s installed RAIM prediction capability (for TSO–C129a/Class A1/B1/C1 equipment) to provide non–precision approach RAIM, accounting for the latest GPS constellation status (e.g., NOTAMs or NANUs). Receiver non–precision approach RAIM should be checked at airports spaced at intervals not to exceed 60 NM along the RNAV 1 procedure’s flight track. “Terminal” or “Approach” RAIM must be available at the ETA over each airport checked; or

**11.3.6.6** Operators not using model–specific software or FAA/VOLPE RAIM data will need FAA operational approval.

**NOTE–**

*If TSO–C145/C146 equipment is used to satisfy the RNAV and RNP requirement, the pilot/operator need not perform the prediction if WAAS coverage is confirmed to be available along the entire route of flight. Outside the U.S. or in areas where WAAS coverage is not available, operators using TSO–C145/C146 receivers are required to check GPS RAIM availability.*

## **12. IFR Operations To High Altitude Destinations**

**12.1** Pilots planning IFR flights to airports located in mountainous terrain are cautioned to consider the necessity for an alternate airport even when the forecast weather conditions would technically relieve them from the requirement to file one.

**12.2** The FAA has identified three possible situations where the failure to plan for an alternate airport when flying IFR to such destination airport could result in a critical situation if the weather is less than forecast and sufficient fuel is not available to proceed to a suitable airport.

**12.2.1** An IFR flight to an airport where the Minimum Descent Altitudes (MDAs) or landing visibility minimums for *all instrument approaches* are higher than the forecast weather minimums specified in 14 CFR Section 91.167(b). For example, there are 3 high altitude airports in the U.S. with approved instrument approach procedures where all of the MDAs are greater than 2,000 feet and/or the landing visibility minimums are greater than 3 miles (Bishop, California; South Lake Tahoe, California; and Aspen-Pitkin Co/Sardy Field, Colorado). In the case of these airports, it is possible for a pilot to elect, on the basis of forecasts, not to carry sufficient fuel to get to an alternate when the ceiling and/or visibility is actually lower than that necessary to complete the approach.

**12.2.2** A small number of other airports in mountainous terrain have MDAs which are slightly (100 to 300 feet) below 2,000 feet AGL. In situations where there is an option as to whether to plan for an alternate, pilots should bear in mind that just a slight worsening of the weather conditions from those forecast could place the airport below the published IFR landing minimums.

**12.2.3** An IFR flight to an airport which requires special equipment; i.e., DME, glide slope, etc., in order to make the available approaches to the lowest minimums. Pilots should be aware that all other minimums on the approach charts may require weather conditions better than those specified in 14 CFR Section 91.167(b). An inflight equipment malfunction could result in the inability to comply with the published approach procedures or, again, in the position of having the airport below the published IFR landing minimums for all remaining instrument approach alternatives.



## ENR 1.11 Addressing of Flight Plans for Domestic or International Flight Planning

### 1. General Information

**1.1** In order to safely and efficiently exercise their responsibilities, controllers must receive the most current and accurate flight plan information available. For departing aircraft, this information is normally received in the form of an ICAO Filed Flight Plan (FPL). For aircraft inbound from an adjacent facility, flight plan information may also be received in the form of an FPL, however, if available, the most current information is received via inter-facility automated interface in the form of a Current Flight Plan (CPL). Although the FPL and CPL are similar, they differ in that the FPL contains the requested route/altitude, while the CPL contains the route/altitude actually assigned to the aircraft.

**1.2** Within domestic U.S. (contiguous 48 states) airspace, only the first en route facility needs to receive flight plan data, whether from the filer or an adjacent facility. This is due to the fact that U.S. en route computer systems automatically forward current flight plan data and revisions from facility to facility. The inappropriate addressing of an FPL by the filer may create processing and/or controller workload issues, resulting in delays.

**1.3** Please refer to guidance in the scenarios below to ensure that FPLs are addressed correctly.

### 2. Addressing Guidance

**NOTE-**

*In this section, U.S. Domestic Airspace includes the 48 contiguous states and Puerto Rico.*

Please use the following criteria when selecting addresses for transmission of the ICAO FPL to U.S. Air Traffic Control (ATC):

**2.1** Address the FPL to the departure ARTCC only. Do not address subsequent U.S. domestic facilities.

**NOTE-**

*If a flight leaves U.S. domestic airspace and later re-enters U.S. domestic airspace, the return portion of the flight should be addressed per guidance in Scenarios 2.3 or 2.4 below, as applicable.*

#### **2.2 U.S. Domestic to International Destinations**

- Address the FPL to the departure ARTCC.
- Do not address subsequent U.S. domestic facilities.
- Address the FPL to New York, Oakland, and/or Anchorage Oceanic, as appropriate.
- Address any non-U.S. FIRs in accordance with ICAO Doc 4444, Procedures for Air Navigation Services — Air Traffic Management, and other published procedures.

#### **2.3 From Canada to or through U.S. Domestic Airspace**

- Address non-U.S. FIRs in accordance with ICAO Doc 4444 and other published procedures.
- Do not address the FPL to any U.S. domestic ARTCC.
- Address the FPL to New York, Oakland and/or Anchorage Oceanic, as appropriate.
- Address any non-U.S. FIRs in accordance with ICAO Doc 4444 and other published procedures.

#### **2.4 International (non-Canada) to or through U.S. Domestic Airspace**

- Address FPLs to non-U.S. FIRs in accordance with ICAO Doc 4444 and other published procedures.
- Address the FPL to the first domestic U.S. ARTCC.
- Do not address subsequent U.S. domestic facilities.
- Address the FPL to New York, Oakland and/or Anchorage Oceanic, as appropriate
- Address any non-U.S. FIRs in accordance with ICAO Doc 4444 and other published procedures.

### **3. Addresses to the Air Route Traffic Control Centers and to Flight Data**

**NOTE-**

*Messages addressed using an ARTCC flight data address (i.e., ZRZX) are not processed by the computer. Response and/or interpretation of these messages are dependent on flight data personnel action. Note: ZTZX (ATC Tower) is not used in the United States.*

#### **3.1 ARTCC NADIN/AFTN Addresses**

The addressing convention used for U.S. domestic FIR/ARTCCs is as follows:

**3.1.1** KZxxZRZX addresses the message only to the facility Flight Data Unit via Aeronautical Information System Replacement (AISR).

**EXAMPLE-**  
KZLCZRZX

**3.1.2** KZxxZQZX addresses the message to both Flight Data and the En Route Computer.

**EXAMPLE-**  
KZLCZQZX

**NOTE-**

*New York ARTCC and Oakland ARTCC require additional addresses for flights entering the Oceanic FIR. For international flight plan addressing, see ENR 7, Oceanic Operations, ENR 7.1 General Procedures, 2. Flight Plan Filing Requirements.*



## ENR 1.12 National Security and Interception Procedures

### 1. National Security

**1.1** National security in the control of air traffic is governed by 14 Code of Federal Regulations (CFR) Part 99, *Security Control of Air Traffic*.

#### 1.2 National Security Requirements

**1.2.1** Pursuant to 14 CFR 99.7, Special Security Instructions, each person operating an aircraft in an Air Defense Identification Zone (ADIZ) or Defense Area must, in addition to the applicable rules of Part 99, comply with special security instructions issued by the FAA Administrator in the interest of national security, pursuant to agreement between the FAA and the Department of Defense (DOD), or between the FAA and a U.S. Federal security or intelligence agency.

**1.2.2** In addition to the requirements prescribed in this section, national security requirements for aircraft operations to or from, within, or transiting U.S. territorial airspace are in effect pursuant to 14 CFR 99.7; 49 United States Code (USC) 40103, Sovereignty and Use of Airspace; and 49 USC 41703, Navigation of Foreign Civil Aircraft. Aircraft operations to or from, within, or transiting U.S. territorial airspace must also comply with all other applicable regulations published in 14 CFR.

**1.2.3** Due to increased security measures in place at many areas and in accordance with 14 CFR 91.103, *Preflight Action*, prior to departure, pilots must become familiar with all available information concerning that flight. Pilots are responsible to comply with 14 CFR 91.137 (Temporary flight restrictions in the vicinity of disaster/hazard areas), 91.138 (Temporary flight restrictions in national disaster areas in the State of Hawaii), 91.141 (Flight restrictions in the proximity of the Presidential and other parties), and 91.143 (Flight limitation in the proximity of space flight operations) when conducting flight in an area where a temporary flight restrictions area is in effect, and should check appropriate NOTAMs during flight planning. In addition, NOTAMs may be issued for National Security Areas (NSA) that temporarily prohibit flight operations under the provisions of 14 CFR 99.7.

#### REFERENCE-

AIP ENR 5.1, Paragraph 2.1, *National Security Areas*.  
AIP ENR 5.1, Paragraph 2.2, *Temporary Flight Restrictions*.

**1.2.4** Noncompliance with the national security requirements for aircraft operations contained in this section may result in denial of flight entry into U.S. territorial airspace or ground stop of the flight at a U.S. airport.

**1.2.5** Pilots of aircraft that do not adhere to the procedures in the national security requirements for aircraft operations contained in this section may be intercepted, and/or detained and interviewed by federal, state, or local law enforcement or other government personnel.

### 1.3 Definitions

**1.3.1** *Air Defense Identification Zone (ADIZ)* means an area of airspace over land or water, in which the ready identification, location, and control of all aircraft (except Department of Defense and law enforcement aircraft) is required in the interest of national security.

**1.3.2** *Defense Area* means any airspace of the contiguous U.S. that is not an ADIZ in which the control of aircraft is required for reasons of national security.

**1.3.3** *U.S. territorial airspace*, for the purposes of this section, means the airspace over the U.S., its territories, and possessions, and the airspace over the territorial sea of the U.S., which extends 12 nautical miles from the baselines of the U.S., determined in accordance with international law.

**1.3.4** *To U.S. territorial airspace* means any flight that enters U.S. territorial airspace after departure from a location outside of the U.S., its territories or possessions, for landing at a destination in the U.S., its territories or possessions.

**1.3.5** *From U.S. territorial airspace* means any flight that exits U.S. territorial airspace after departure from a location in the U.S., its territories or possessions, and lands at a destination outside the U.S., its territories or possessions.

**1.3.6** *Within U.S. territorial airspace* means any flight departing from a location inside of the U.S., its territories or possessions, which operates en route to a location inside the U.S., its territories or possessions.

**1.3.7** *Transit or transiting U.S. territorial airspace* means any flight departing from a location outside of the U.S., its territories or possessions, which operates in U.S. territorial airspace en route to a location outside the U.S., its territories or possessions without landing at a destination in the U.S., its territories or possessions.

**1.3.8** *Aeronautical facility*, for the purposes of this section, means a communications facility where flight plans or position reports are normally filed during flight operations.

#### **1.4 ADIZ Requirements**

**1.4.1** To facilitate early identification of all aircraft in the vicinity of U.S. airspace boundaries, Air Defense Identification Zones (ADIZ) have been established. All aircraft must meet certain requirements to facilitate early identification when operating into, within, and across an ADIZ, as described in 14 CFR 99. (See FIG ENR 1.12-1.)

**1.4.2** Requirements for aircraft operations are as follows:

**1.4.2.1 Transponder Requirements.** Unless otherwise authorized by ATC, each aircraft conducting operations into, within, or across the contiguous U.S. ADIZ must be equipped with an operable radar beacon transponder. The transponder must be turned on and squawking a discrete beacon code assigned by ATC or issued by FSS and displaying the aircraft altitude. Use of beacon code 1200 is not authorized. Use of the Universal Access Transceiver (UAT) anonymity mode is not authorized.

a) For air defense purposes, aircraft equipped with an operable 1090es (DO-260b) ADS-B system operating outbound across the contiguous U.S. ADIZ may also be identified by the ICAO aircraft address (otherwise known as the aircraft Mode S code). Therefore, use of a privacy ICAO aircraft address by outbound aircraft is not authorized.

b) Pilots of outbound VFR aircraft must squawk a discrete beacon code assigned by ATC or issued by FSS.

c) Nothing in this section changes the ADS-B OUT requirements of 14 CFR 91.225.

#### **REFERENCE-**

14 CFR 99.13, *Transponder-On Requirements.*

14 CFR 91.225, *Automatic Dependent Surveillance-Broadcast (ADS-B) Out equipment and use.*

**1.4.2.2 Two-way Radio.** In accordance with 14 CFR 99.9, *Radio Requirements*, any person operating in an ADIZ must maintain two-way radio communication with an appropriate aeronautical facility. For two-way radio communications failure, follow instructions contained in 14 CFR 99.9.

**1.4.2.3 Flight Plan.** In accordance with 14 CFR 99.11, *Flight Plan Requirements*, and 14 CFR 99.9, except as specified in subparagraph 1.4.5, no person may operate an aircraft into, within, or from a departure point within an ADIZ, unless the person files, activates, and closes a flight plan with an appropriate aeronautical facility, or is otherwise authorized by air traffic control as follows:

a) Pilots must file an Instrument Flight Rules (IFR) flight plan or file a Defense Visual Flight Rules (DVFR) flight plan containing the time and point of ADIZ penetration;

b) The pilot must activate the DVFR flight plan with U.S. Flight Service and set the aircraft transponder to the assigned discrete beacon code prior to entering the ADIZ;

c) The IFR or DVFR aircraft must depart within 5 minutes of the estimated departure time contained in the flight plan, except for (d) below;

d) If the airport of departure within the Alaskan ADIZ has no facility for filing a flight plan, the flight plan must be filed immediately after takeoff or when within range of an appropriate aeronautical facility;

e) State aircraft (U.S. or foreign) planning to operate through an ADIZ should enter ICAO Code M in Item 8 of the flight plan to assist in identification of the aircraft as a state aircraft.

### **1.4.3 Position Reporting Before Penetration of ADIZ.**

In accordance with 14 CFR 99.15, *Position Reports*, before entering the ADIZ, the pilot must report to an appropriate aeronautical facility as follows:

**1.4.3.1 IFR flights in controlled airspace.** The pilot must maintain a continuous watch on the appropriate frequency and report the time and altitude of passing each designated reporting point or those reporting points specified or requested by ATC, except that while the aircraft is under radar control, only the passing of those reporting points specifically requested by ATC need be reported. (See 14 CFR 91.183(a), IFR Communications.)

#### **1.4.3.2 DVFR flights and IFR flights in uncontrolled airspace:**

a) The time, position, and altitude at which the aircraft passed the last reporting point before penetration and the estimated time of arrival over the next appropriate reporting point along the flight route;

b) If there is no appropriate reporting point along the flight route, the pilot reports at least 15 minutes before penetration: the estimated time, position, and altitude at which the pilot will penetrate; or

c) If the departure airport is within an ADIZ or so close to the ADIZ boundary that it prevents the pilot from complying with (a) or (b) above, the pilot must report immediately after departure: the time of departure, the altitude, and the estimated time of arrival over the first reporting point along the flight route.

**1.4.3.3 Foreign civil aircraft.** If the pilot of a foreign civil aircraft that intends to enter the U.S. through an ADIZ cannot comply with the reporting requirements in subparagraphs 1.4.3.1 or 1.4.3.2 above, as applicable, the pilot must report the position of the aircraft to the appropriate aeronautical facility not less than 1 hour and not more than 2 hours average direct cruising distance from the U.S.

**1.4.4 Land-Based ADIZ.** Land-Based ADIZ are activated and deactivated over U.S. metropolitan areas as needed, with dimensions, activation dates and other relevant information disseminated via NOTAM. Pilots unable to comply with all NOTAM requirements must remain clear of Land-Based ADIZ. Pilots entering a Land-Based ADIZ without authorization or who fail to follow all requirements risk interception by military fighter aircraft.

### **1.4.5 Exceptions to ADIZ requirements.**

**1.4.5.1** Except for the national security requirements in paragraph 1.2, transponder requirements in subparagraph 1.4.2.1, and position reporting in subparagraph 1.4.3, the ADIZ requirements in 14 CFR Part 99 described in this section do not apply to the following aircraft operations pursuant to Section 99.1(b), Applicability:

a) Within the 48 contiguous States or within the State of Alaska, on a flight which remains within 10 NM of the point of departure;

b) Operating at true airspeed of less than 180 knots in the Hawaii ADIZ or over any island, or within 12 NM of the coastline of any island, in the Hawaii ADIZ;

c) Operating at true airspeed of less than 180 knots in the Alaska ADIZ while the pilot maintains a continuous listening watch on the appropriate frequency; or

d) Operating at true airspeed of less than 180 knots in the Guam ADIZ.

**1.4.5.2** An FAA air route traffic control center (ARTCC) may exempt certain aircraft operations on a local basis in concurrence with the DOD or pursuant to an agreement with a U.S. Federal security or intelligence agency. (See 14 CFR 99.1 for additional information.)

**1.4.6** A VFR flight plan filed inflight makes an aircraft subject to interception for positive identification when entering an ADIZ. Pilots are therefore urged to file the required DVFR flight plan either in person or by telephone prior to departure when able.

## **1.5 Civil Aircraft Operations To or From U.S. Territorial Airspace**

**1.5.1** Civil aircraft, except as described in subparagraph 1.5.2 below, are authorized to operate to or from U.S. territorial airspace if in compliance with all of the following conditions:

**1.5.1.1** File and are on an active flight plan (IFR, VFR, or DVFR);

**1.5.1.2** Are equipped with an operational transponder with altitude reporting capability, and continuously squawk an ATC assigned transponder code;

**1.5.1.3** Maintain two–way radio communications with ATC;

**1.5.1.4** Comply with all other applicable ADIZ requirements described in paragraph 1.4 and any other national security requirements in paragraph 1.2;

**1.5.1.5** Comply with all applicable U.S. Customs and Border Protection (CBP) requirements, including Advance Passenger Information System (APIS) requirements (see subparagraph 1.5.3 below for CBP APIS information), in accordance with 19 CFR Part 122, Air Commerce Regulations; and

**1.5.1.6** Are in receipt of, and are operating in accordance with, an FAA routing authorization if the aircraft is registered in a U.S. State Department–designated special interest country or is operating with the ICAO three letter designator (3LD) of a company in a country listed as a U.S. State Department–designated special interest country, unless the operator holds valid FAA Part 129 operations specifications. VFR and DVFR flight operations are prohibited for any aircraft requiring an FAA routing authorization. (See paragraph 1.11 for FAA routing authorization information).

**1.5.2** Civil aircraft registered in the U.S., Canada, or Mexico with a maximum certificated takeoff gross weight of 100,309 pounds (45,500 kgs) or less that are operating without an operational transponder, and/or the ability to maintain two–way radio communications with ATC, are authorized to operate to or from U.S. territorial airspace over Alaska if in compliance with all of the following conditions:

**1.5.2.1** Depart and land at an airport within the U.S. or Canada;

**1.5.2.2** Enter or exit U.S. territorial airspace over Alaska north of the fifty–fourth parallel;

**1.5.2.3** File and are on an active flight plan;

**1.5.2.4** Comply with all other applicable ADIZ requirements described in paragraph 1.4 and any other national security requirements in paragraph 1.2;

**1.5.2.5** Squawk 1200 if VFR and equipped with a transponder; and

**1.5.2.6** Comply with all applicable U.S. CBP requirements, including APIS requirements (see paragraph 1.5.3 below for CBP APIS information), in accordance with 19 CFR Part 122, Air Commerce Regulations.

**1.5.3 CBP APIS Information.** Information about U.S. CBP APIS requirements is available at <http://www.cbp.gov>.

## **1.6 Civil Aircraft Operations Within U.S. Territorial Airspace**

**1.6.1** Civil aircraft with a maximum certificated takeoff gross weight less than or equal to 100,309 pounds (45,500 kgs) are authorized to operate within U.S. territorial airspace in accordance with all applicable regulations and VFR in airport traffic pattern areas of U.S. airports near the U.S. border, except for those described in subparagraph 1.6.2 below.

**1.6.2** Civil aircraft with a maximum certificated takeoff gross weight less than or equal to 100,309 pounds (45,500 kgs) and registered in a U.S. State Department–designated special interest country or operating with the ICAO 3LD of a company in a country listed as a U.S. State Department–designated special interest country, unless the operator holds valid FAA Part 129 operations specifications, must operate within U.S. territorial airspace in accordance with the same requirements as civil aircraft with a maximum certificated takeoff gross weight greater than 100,309 pounds (45,500 kgs), as described in subparagraph 1.6.3 below.

**1.6.3** Civil aircraft with a maximum certificated takeoff gross weight greater than 100,309 pounds (45,500 kgs) are authorized to operate within U.S. territorial airspace if in compliance with all of the following conditions:

**1.6.3.1** File and are on an active flight plan (IFR or VFR);

**1.6.3.2** Equipped with an operational transponder with altitude reporting capability, and continuously squawk an ATC assigned transponder code;

**1.6.3.3** Equipped with an operational ADS-B Out when operating in airspace specified in 14 CFR 91.225;

**1.6.3.4** Maintain two-way radio communications with ATC;

**1.6.3.5** Aircraft not registered in the U.S. must operate under an approved Transportation Security Administration (TSA) aviation security program (see paragraph 1.10 for TSA aviation security program information) or in accordance with an FAA/TSA airspace waiver (see paragraph 1.9 for FAA/TSA airspace waiver information), except as authorized in 1.6.3.7 below;

**1.6.3.6** Are in receipt of, and are operating in accordance with an FAA routing authorization and an FAA/TSA airspace waiver if the aircraft is registered in a U.S. State Department-designated special interest country or is operating with the ICAO 3LD of a company in a country listed as a U.S. State Department-designated special interest country, unless the operator holds valid FAA Part 129 operations specifications. VFR and DVFR flight operations are prohibited for any aircraft requiring an FAA routing authorization. (See paragraph 1.11 for FAA routing authorization information.); and

**1.6.3.7** Aircraft not registered in the U.S., when conducting post-maintenance, manufacturer, production, or acceptance flight test operations, are exempt from the requirements in 1.6.3.5 above if all of the following requirements are met:

- a) A U.S. company must have operational control of the aircraft;
- b) An FAA-certificated pilot must serve as pilot in command;
- c) Only crewmembers are permitted onboard the aircraft; and
- d) "Maintenance Flight" is included in the remarks section of the flight plan.

## **1.7 Civil Aircraft Operations Transiting U.S. Territorial Airspace**

**1.7.1** Civil aircraft (except those operating in accordance with subparagraphs 1.7.2, 1.7.3, 1.7.4, or 1.7.5) are authorized to transit U.S. territorial airspace if in compliance with all of the following conditions:

**1.7.1.1** File and are on an active flight plan (IFR, VFR, or DVFR);

**1.7.1.2** Equipped with an operational transponder with altitude reporting capability and continuously squawk an ATC assigned transponder code;

**1.7.1.3** Equipped with an operational ADS-B Out when operating in airspace specified in 14 CFR 91.225;

**1.7.1.4** Maintain two-way radio communications with ATC;

**1.7.1.5** Comply with all other applicable ADIZ requirements described in paragraph 1.4 and any other national security requirements in paragraph 1.2;

**1.7.1.6** Are operating under an approved TSA aviation security program (see paragraph 1.10 for TSA aviation security program information) or are operating with and in accordance with an FAA/TSA airspace waiver (see paragraph 1.9 for FAA/TSA airspace waiver information), if:

- a) The aircraft is not registered in the U.S.; or
- b) The aircraft is registered in the U.S. and its maximum takeoff gross weight is greater than 100,309 pounds (45,500 kgs);

**1.7.1.7** Are in receipt of, and are operating in accordance with, an FAA routing authorization if the aircraft is registered in a U.S. State Department-designated special interest country or is operating with the ICAO 3LD of

a company in a country listed as a U.S. State Department–designated special interest country, unless the operator holds valid FAA Part 129 operations specifications. VFR and DVFR flight operations are prohibited for any aircraft requiring an FAA routing authorization. (See paragraph 1.11 for FAA routing authorization information.)

**1.7.2** Civil aircraft registered in Canada or Mexico, and engaged in operations for the purposes of air ambulance, firefighting, law enforcement, search and rescue, or emergency evacuation are authorized to transit U.S. territorial airspace within 50 NM of their respective borders with the U.S., with or without an active flight plan, provided they have received and continuously transmit an ATC–assigned transponder code.

**1.7.3** Civil aircraft registered in Canada, Mexico, Bahamas, Bermuda, Cayman Islands, or the British Virgin Islands with a maximum certificated takeoff gross weight of 100,309 pounds (45,500 kgs) or less are authorized to transit U.S. territorial airspace if in compliance with all of the following conditions:

**1.7.3.1** File and are on an active flight plan (IFR, VFR, or DVFR) that enters U.S. territorial airspace directly from any of the countries listed in this subparagraph 1.7.3. Flights that include a stop in a non–listed country prior to entering U.S. territorial airspace must comply with the requirements prescribed by subparagraph 1.7.1 above, including operating under an approved TSA aviation security program (see paragraph 1.10 for TSA aviation program information) or operating with, and in accordance with, an FAA/TSA airspace waiver (see paragraph 1.9 for FAA/TSA airspace waiver information);

**1.7.3.2** Equipped with an operational transponder with altitude reporting capability and continuously squawk an ATC assigned transponder code;

**1.7.3.3** Equipped with an operational ADS–B Out when operating in airspace specified in 14 CFR 91.225;

**1.7.3.4** Maintain two–way radio communications with ATC; and

**1.7.3.5** Comply with all other applicable ADIZ requirements described in paragraph 1.4 and any other national security requirements in paragraph 1.2.

**1.7.4** Civil aircraft registered in Canada, Mexico, Bahamas, Bermuda, Cayman Islands, or the British Virgin Islands with a maximum certificated takeoff gross weight greater than 100,309 pounds (45,500 kgs) must comply with the requirements in subparagraph 1.7.1, including operating under an approved TSA aviation security program (see paragraph 1.10 for TSA aviation program information) or operating with, and in accordance with, an FAA/TSA airspace waiver (see paragraph 1.9 for FAA/TSA airspace waiver information).

**1.7.5** Civil aircraft registered in the U.S., Canada, or Mexico with a maximum certificated takeoff gross weight of 100,309 pounds (45,500 kgs) or less that are operating without an operational transponder and/or the ability to maintain two–way radio communications with ATC, are authorized to transit U.S. territorial airspace over Alaska if in compliance with all of the following conditions:

**1.7.5.1** Enter and exit U.S. territorial airspace over Alaska north of the fifty–fourth parallel;

**1.7.5.2** File and are on an active flight plan;

**1.7.5.3** Squawk 1200 if VFR and equipped with a transponder; and

**1.7.5.4** Comply with all other applicable ADIZ requirements described in paragraph 1.4 and any other national security requirements in paragraph 1.2.

## **1.8 Foreign State Aircraft Operations**

**1.8.1** Foreign state aircraft are authorized to operate in U.S. territorial airspace if in compliance with all of the following conditions:

**1.8.1.1** File and are on an active IFR flight plan;

**1.8.1.2** Equipped with an operational transponder with altitude reporting capability and continuously squawk an ATC assigned transponder code;

**1.8.1.3** Equipped with an operational ADS–B Out when operating in airspace specified in 14 CFR 91.225;

**1.8.1.4** Maintain two-way radio communications with ATC;

**1.8.1.5** Comply with all other applicable ADIZ requirements described in paragraph 1.4 and any other national security requirements in paragraph 1.2.

**1.8.2 Diplomatic Clearances.** Foreign state aircraft may operate to or from, within, or in transit of U.S. territorial airspace only when authorized by the U.S. State Department by means of a diplomatic clearance, except as described in subparagraph 1.8.9 below.

**1.8.2.1** Information about diplomatic clearances is available on the U.S. State Department website at <https://www.state.gov/diplomatic-aircraft-clearance-procedures-for-foreign-state-aircraft-to-operate-in-united-states-national-airspace/>.

**1.8.2.2** A diplomatic clearance may be initiated by contacting the U.S. State Department via email at [DCAS@state.gov](mailto:DCAS@state.gov) or via phone at (202) 453-8390.

**NOTE-**

*A diplomatic clearance is not required for foreign state aircraft operations that transit U.S. controlled oceanic airspace but do not enter U.S. territorial airspace. (See subparagraph 1.8.4 for flight plan information.)*

**1.8.3** An FAA routing authorization for state aircraft operations of special interest countries listed in subparagraph 1.11.2 is required before the U.S. State Department will issue a diplomatic clearance for such operations. (See paragraph 1.11 for FAA routing authorizations information).

**1.8.4** Foreign state aircraft operating with a diplomatic clearance must navigate U.S. territorial airspace on an active IFR flight plan, unless specifically approved for VFR flight operations by the U.S. State Department in the diplomatic clearance.

**NOTE-**

*Foreign state aircraft operations to or from, within, or transiting U.S. territorial airspace; or transiting any U.S. controlled oceanic airspace, should enter ICAO code M in Item 8 of the flight plan to assist in identification of the aircraft as a state aircraft.*

**1.8.5** A foreign aircraft that operates to or from, within, or in transit of U.S. territorial airspace while conducting a state aircraft operation is not authorized to change its status as a state aircraft during any portion of the approved, diplomatically cleared itinerary.

**1.8.6** A foreign aircraft described in subparagraph 1.8.5 above may operate from or within U.S. territorial airspace as a civil aircraft operation, once it has completed its approved, diplomatically cleared itinerary, if the aircraft operator is:

**1.8.6.1** A foreign air carrier that holds valid FAA Part 129 operations specifications; and

**1.8.6.2** Is in compliance with all other requirements applied to foreign civil aircraft operations from or within U.S. territorial airspace. (See paragraphs 1.5 and 1.6.)

**1.8.7** Foreign state aircraft operations are not authorized to or from Ronald Reagan Washington National Airport (KDCA).

**1.8.8** Foreign state aircraft operating with a U.S. Department of State issued Diplomatic Clearance Number in the performance of official missions are authorized to deviate from the Automatic Dependent Surveillance-Broadcast (ADS-B) Out requirements contained in 14 CFR §§ 91.225 and 91.227. All foreign state aircraft and/or operators associated with Department of Defense missions should contact their respective offices for further information on handling. Foreign state aircraft not associated with Department of Defense should coordinate with Department of State through the normal diplomatic clearance process.

**1.8.9 Diplomatic Clearance Exceptions.** State aircraft operations on behalf of the governments of Canada and Mexico conducted for the purposes of air ambulance, firefighting, law enforcement, search and rescue, or emergency evacuation are authorized to transit U.S. territorial airspace within 50 NM of their respective borders with the U.S., with or without an active flight plan, provided they have received and continuously transmit an ATC assigned transponder code. State aircraft operations on behalf of the governments of Canada and Mexico

conducted under this subparagraph 1.8.9 are not required to obtain a diplomatic clearance from the U.S. State Department.

### **1.9 FAA/TSA Airspace Waivers**

**1.9.1** Operators may submit requests for FAA/TSA airspace waivers at <https://waivers.faa.gov> by selecting “international” as the waiver type.

**1.9.2** Information regarding FAA/TSA airspace waivers can be found at: <http://www.tsa.gov/for-industry/general-aviation> or can be obtained by contacting TSA at (571) 227–2071.

**1.9.3** All existing FAA/TSA waivers issued under previous FDC NOTAMS remain valid until the expiration date specified in the waiver, unless sooner superseded or rescinded.

### **1.10 TSA Aviation Security Programs**

**1.10.1** Applicants for U.S. air operator certificates will be provided contact information for TSA aviation security programs by the U.S. Department of Transportation during the certification process.

**1.10.2** For information about applicable TSA security programs:

**1.10.2.1** U.S. air carriers and commercial operators must contact their TSA Principal Security Specialist (PSS); and

**1.10.2.2** Foreign air carriers must contact their International Industry Representative (IIR).

### **1.11 FAA Flight Routing Authorizations**

**1.11.1** Information about FAA routing authorizations for U.S. State Department–designated special interest country flight operations to or from, within, or transiting U.S. territorial airspace is available by country at:

**1.11.1.1** FAA website: [http://www.faa.gov/air\\_traffic/publications/us\\_restrictions/](http://www.faa.gov/air_traffic/publications/us_restrictions/); or

**1.11.1.2** Phone by contacting the FAA System Operations Support Center (SOSC) at (202) 267–8115.

**1.11.2 Special Interest Countries.** The U.S. State Department–designated special interest countries are Cuba, Iran, The Democratic People’s Republic of Korea (North Korea), The People’s Republic of China, The Russian Federation, Sudan, and Syria.

#### **NOTE–**

*FAA flight routing authorizations are not required for aircraft registered in Hong Kong, Taiwan, or Macau.*

**1.11.3** Aircraft operating with the ICAO 3LD assigned to a company or entity from a country listed as a State Department–designated special interest country and holding valid FAA Part 129 operations specifications do not require FAA flight routing authorization.

**1.11.4** FAA routing authorizations will only be granted for IFR operations. VFR and DVFR flight operations are prohibited for any aircraft requiring an FAA routing authorization.

### **1.12 Emergency Security Control of Air Traffic (ESCAT)**

**1.12.1** During defense emergency or air defense emergency conditions, additional special security instructions may be issued in accordance with 32 CFR Part 245, Plan for the Emergency Security Control of Air Traffic (ESCAT).

**1.12.2** Under the provisions of 32 CFR Part 245, the military will direct the action to be taken in regard to landing, grounding, diversion, or dispersal of aircraft in the defense of the U.S. during emergency conditions.

**1.12.3** At the time a portion or all of ESCAT is implemented, ATC facilities will broadcast appropriate instructions received from the Air Traffic Control System Command Center (ATCSCC) over available ATC frequencies. Depending on instructions received from the ATCSCC, VFR flights may be directed to land at the nearest available airport, and IFR flights will be expected to proceed as directed by ATC.

**1.12.4** Pilots on the ground may be required to file a flight plan and obtain an approval (through FAA) prior to conducting flight operation.



## **2. Interception Procedures**

### **2.1 General**

**2.1.1** In conjunction with the FAA, Air Defense Sectors monitor air traffic and could order an intercept in the interest of national security or defense. Intercepts during peacetime operations are vastly different from those conducted under increased states of readiness. The interceptors may be fighters or rotary wing aircraft. The reasons for aircraft intercept include, but are not limited to:

**2.1.1.1** Identify an aircraft.

**2.1.1.2** Track an aircraft.

**2.1.1.3** Inspect an aircraft.

**2.1.1.4** Divert an aircraft.

**2.1.1.5** Establish communications with an aircraft.

**2.1.2** All aircraft operating in US national airspace are highly encouraged to maintain a listening watch on VHF/UHF guard frequencies (121.5 or 243.0 MHz). If subjected to a military intercept, it is incumbent on civilian aviators to understand their responsibilities and to comply with ICAO standard signals relayed from the intercepting aircraft. Specifically, aviators are expected to contact air traffic control without delay (if able) on the local operating frequency or on VHF/UHF guard. Noncompliance may result in the use of force.

**2.1.3** When specific information is required (i.e., markings, serial numbers, etc.) the interceptor pilot(s) will respond only if, in their judgment, the request can be conducted in a safe manner. Intercept procedures are described in some detail in the paragraphs below. In all situations, the interceptor pilot will consider safety of flight for all concerned throughout the intercept procedure. The interceptor pilot(s) will use caution to avoid startling the intercepted crew or passengers and understand that maneuvers considered normal for interceptor aircraft may be considered hazardous to other aircraft.

### **2.2 Fighter Intercept Phases (See FIG ENR 1.12-2)**

#### **2.2.1 Approach Phase**

**2.2.1.1** As standard procedure, intercepted aircraft are approached from behind. Typically, interceptor aircraft will be employed in pairs; however, it is not uncommon for a single aircraft to perform the intercept operation. Safe separation between interceptors and intercepted aircraft is the responsibility of the intercepting aircraft and will be maintained at all times.

#### **2.2.2 Identification Phase**

**2.2.2.1** Interceptor aircraft will initiate a controlled closure toward the aircraft of interest, holding at a distance no closer than deemed necessary to establish positive identification and to gather the necessary information. The interceptor may also fly past the intercepted aircraft while gathering data at a distance considered safe based on aircraft performance characteristics.

#### **2.2.3 Post Intercept Phase**

**2.2.3.1** An interceptor may attempt to establish communications via standard ICAO signals. In time-critical situations where the interceptor is seeking an immediate response from the intercepted aircraft or if the intercepted aircraft remains non-compliant to instruction, the interceptor pilot may initiate a divert maneuver. In this maneuver, the interceptor flies across the intercepted aircraft's flight path (minimum 500 feet separation and commencing from slightly below the intercepted aircraft altitude) in the general direction the intercepted aircraft is expected to turn. The interceptor will rock its wings (daytime) or flash external lights/select afterburners (night) while crossing the intercepted aircraft's flight path. The interceptor will roll out in the direction the intercepted aircraft is expected to turn before returning to verify the aircraft of interest is complying. The intercepted aircraft is expected to execute an immediate turn to the direction of the intercepting aircraft. If the aircraft of interest does not comply, the interceptor may conduct a second climbing turn across the intercepted

aircraft's flight path (minimum 500 feet separation and commencing from slightly below the intercepted aircraft altitude) while expending flares as a warning signal to the intercepted aircraft to comply immediately and to turn in the direction indicated and to leave the area. The interceptor is responsible to maintain safe separation during these and all intercept maneuvers. Flight safety is paramount.

**NOTE-**

1. *NORAD interceptors will take every precaution to preclude the possibility of the intercepted aircraft experiencing jet wash/wake turbulence; however, there is a potential that this condition could be encountered.*
2. *During night/IMC, the intercept will be from below flight path.*

FIG ENR 1.12-1  
Air Defense Identification Zone Boundaries  
Designated Mountainous Areas

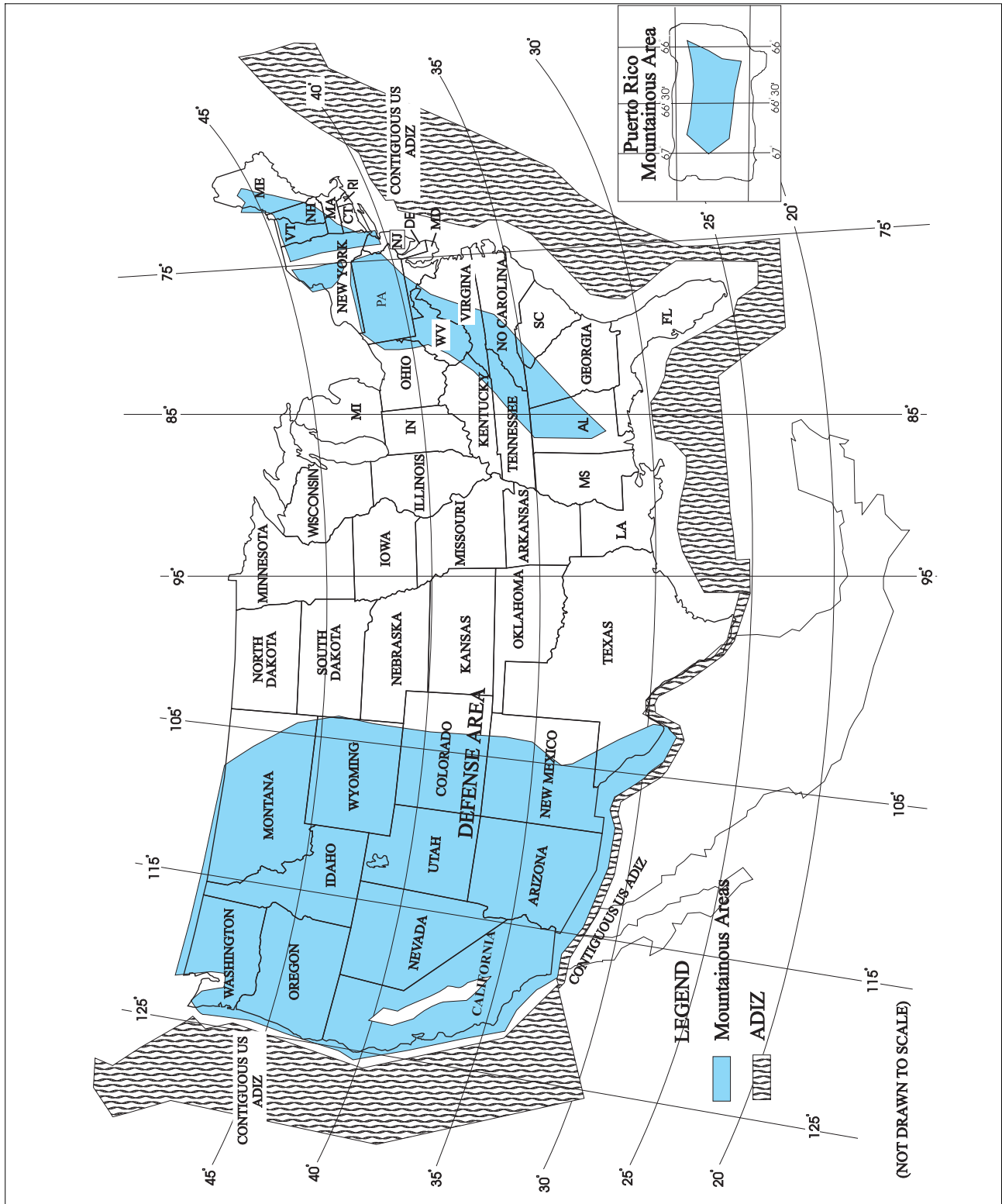
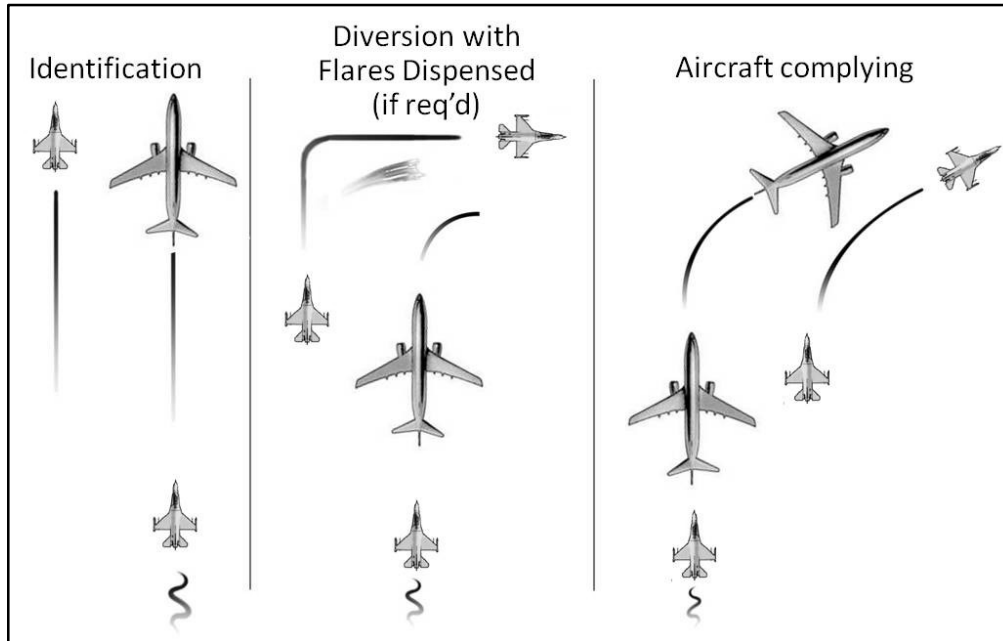


FIG ENR 1.12-2  
Intercept Procedures



## 2.3 Helicopter Intercept Phases (See FIG ENR 1.12-3)

### 2.3.1 Approach Phase

**2.3.1.1** Aircraft intercepted by helicopter may be approached from any direction, although the helicopter should close for identification and signaling from behind. Generally, the helicopter will approach off the left side of the intercepted aircraft. Safe separation between the helicopter and the unidentified aircraft will be maintained at all times.

### 2.3.2 Identification Phase

**2.3.2.1** The helicopter will initiate a controlled closure toward the aircraft of interest, holding at a distance no closer than deemed necessary to establish positive identification and gather the necessary information. The intercepted pilot should expect the interceptor helicopter to take a position off his left wing slightly forward of abeam.

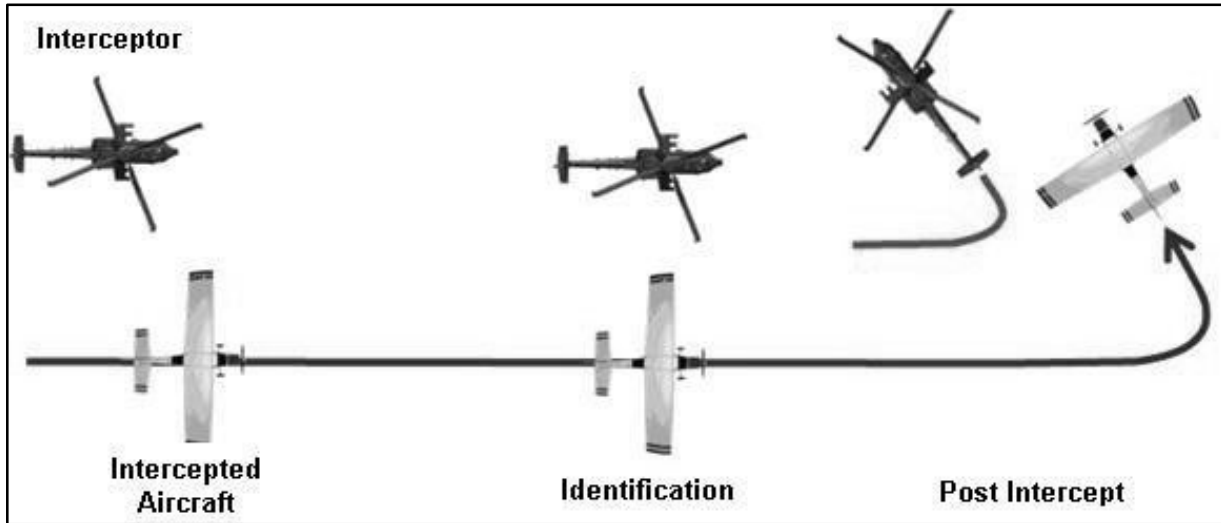
### 2.3.3 Post Intercept Phase

**2.3.3.1** Visual signaling devices may be used in an attempt to communicate with the intercepted aircraft. Visual signaling devices may include, but are not limited to, LED scrolling signboards or blue flashing lights. If compliance is not obtained through the use of radios or signaling devices, standard ICAO intercept signals (TBL ENR 1.12-1) may be employed. In order to maintain safe aircraft separation, it is incumbent upon the pilot of the intercepted aircraft not to fall into a trail position (directly behind the helicopter) if instructed to follow the helicopter. This is because the helicopter pilot may lose visual contact with the intercepted aircraft.

**NOTE-**

*Intercepted aircraft must not follow directly behind the helicopter thereby allowing the helicopter pilot to maintain visual contact with the intercepted aircraft and ensuring safe separation is maintained.*

FIG ENR 1.12-3  
Helicopter Intercept Procedures



### 2.3.4 Summary of Intercepted Aircraft Actions

#### 2.3.4.1 An intercepted aircraft must, without delay:

- a) Adhere to instructions relayed through the use of visual devices, visual signals, and radio communications from the intercepting aircraft.
- b) Attempt to establish radio communications with the intercepting aircraft or with the appropriate air traffic control facility by making a general call on guard frequencies (121.5 or 243.0 MHz), giving the identity, position, and nature of the flight.
- c) If transponder equipped, select Mode 3/A Code 7700 unless otherwise instructed by air traffic control.

**NOTE-**

*If instruction received from any agency conflicts with that given by the intercepting aircraft through visual or radio communications, the intercepted aircraft must seek immediate clarification.*

- d) Continue to comply with interceptor aircraft signals and instructions until positively released.

### 2.4 Interception Signals (See TBL ENR 1.12-1 and TBL ENR 1.12-2)

### 2.5 Visual Warning System (VWS)

**2.5.1** The VWS signal consists of highly-focused red and green colored laser lights designed to illuminate in an alternating red and green signal pattern. These lasers may be directed at specific aircraft suspected of making unauthorized entry into the Washington, DC Special Flight Rules Area (DC SFRA) proceeding on a heading or flight path that may be interpreted as a threat or that operate contrary to the operating rules for the DC SFRA. The beam is neither hazardous to the eyes of pilots/aircrew or passengers, regardless of altitude or distance from the source nor will the beam affect aircraft systems.

**2.5.1.1** If you are communicating with ATC, and this signal is directed at your aircraft, you are required to contact ATC and advise that you are being illuminated by a visual warning system.

**2.5.1.2** If this signal is directed at you, and you are not communicating with ATC, you are advised to turn to the most direct heading away from the center of the DC SFRA as soon as possible. Immediately contact ATC on an appropriate frequency, VHF Guard 121.5 or UHF Guard 243.0, and provide your aircraft identification, position, and nature of the flight. Failure to follow these procedures may result in interception by military aircraft. Further noncompliance with interceptor aircraft or ATC may result in the use of force.

**2.5.1.3** Pilots planning to operate aircraft in or near the DC SFRA are to familiarize themselves with aircraft intercept procedures. This information applies to all aircraft operating within the DC SFRA including DOD, Law

Enforcement, and aircraft engaged in aeromedical operations and does not change procedures established for reporting unauthorized laser illumination as published in FAA Advisory Circulars and Notices.

REFERENCE-  
CFR 91.161

2.5.1.4 More details including a video demonstration of the VWS are available from the following FAA website: [www.faa.gov/VisualWarningSystem/VisualWarning.htm](http://www.faa.gov/VisualWarningSystem/VisualWarning.htm).

*TBL ENR 1.12-1*  
**Intercepting Signals**

<b>INTERCEPTING SIGNALS</b>				
<b>Signals initiated by intercepting aircraft and responses by intercepted aircraft</b>				
<b>(as set forth in ICAO Annex 2-Appendix 1, 2.1)</b>				
<b>Series</b>	<b>INTERCEPTING Aircraft Signals</b>	<b>Meaning</b>	<b>INTERCEPTED Aircraft Responds</b>	<b>Meaning</b>
1	<p>DAY-Rocking wings from a position slightly above and ahead of, and normally to the left of, the intercepted aircraft and, after acknowledgement, a slow level turn, normally to the left, on to the desired heading.</p> <p>NIGHT-Same and, in addition, flashing navigational lights at irregular intervals.</p> <p><i>NOTE 1-Meteorological conditions or terrain may require the intercepting aircraft to take up a position slightly above and ahead of, and to the right of, the intercepted aircraft and to make the subsequent turn to the right.</i></p> <p><i>NOTE 2-If the intercepted aircraft is not able to keep pace with the intercepting aircraft, the latter is expected to fly a series of race-track patterns and to rock its wings each time it passes the intercepted aircraft.</i></p>	<p>You have been intercepted. Follow me.</p>	<p>AEROPLANES: DAY-Rocking wings and following.</p> <p>NIGHT-Same and, in addition, flashing navigational lights at irregular intervals.</p> <p>HELICOPTERS: DAY or NIGHT-Rocking aircraft, flashing navigational lights at irregular intervals and following.</p>	<p>Understood, will comply.</p>
2	<p>DAY or NIGHT-An abrupt break-away maneuver from the intercepted aircraft consisting of a climbing turn of 90 degrees or more without crossing the line of flight of the intercepted aircraft.</p>	<p>You may proceed.</p>	<p>AEROPLANES: DAY or NIGHT-Rocking wings.</p> <p>HELICOPTERS: DAY or NIGHT-Rocking aircraft.</p>	<p>Understood, will comply.</p>
3	<p>DAY-Circling aerodrome, lowering landing gear and overflying runway in direction of landing or, if the intercepted aircraft is a helicopter, overflying the helicopter landing area.</p> <p>NIGHT-Same and, in addition, showing steady landing lights.</p>	<p>Land at this aerodrome.</p>	<p>AEROPLANES: DAY-Lowering landing gear, following the intercepting aircraft and, if after overflying the runway landing is considered safe, proceeding to land.</p> <p>NIGHT-Same and, in addition, showing steady landing lights (if carried).</p> <p>HELICOPTERS: DAY or NIGHT-Following the intercepting aircraft and proceeding to land, showing a steady landing light (if carried).</p>	<p>Understood, will comply.</p>

**TBL ENR 1.12-2  
Intercepting Signals**

<b>INTERCEPTING SIGNALS</b>				
<b>Signals and Responses During Aircraft Intercept</b>				
<b>Signals initiated by intercepted aircraft and responses by intercepting aircraft</b>				
<b>(as set forth in ICAO Annex 2-Appendix 1, 2.2)</b>				
Series	INTERCEPTED Aircraft Signals	Meaning	INTERCEPTING Aircraft Responds	Meaning
4	<p><b>AEROPLANES:</b> DAY-Raising landing gear while passing over landing runway at a height exceeding 300m (1,000 ft) but not exceeding 600m (2,000 ft) above the aerodrome level, and continuing to circle the aerodrome.</p> <p>NIGHT-Flashing landing lights while passing over landing runway at a height exceeding 300m (1,000 ft) but not exceeding 600m (2,000 ft) above the aerodrome level, and continuing to circle the aerodrome. If unable to flash landing lights, flash any other lights available.</p>	Aerodrome you have designated is inadequate.	<p>DAY or NIGHT-If it is desired that the intercepted aircraft follow the intercepting aircraft to an alternate aerodrome, the intercepting aircraft raises its landing gear and uses the Series 1 signals prescribed for intercepting aircraft.</p> <p>If it is decided to release the intercepted aircraft, the intercepting aircraft uses the Series 2 signals prescribed for intercepting aircraft.</p>	<p>Understood, follow me.</p> <p>Understood, you may proceed.</p>
5	<p><b>AEROPLANES:</b> DAY or NIGHT-Regular switching on and off of all available lights but in such a manner as to be distinct from flashing lights.</p>	Cannot comply.	DAY or NIGHT-Use Series 2 signals prescribed for intercepting aircraft.	Understood.
6	<p><b>AEROPLANES:</b> DAY or NIGHT-Irregular flashing of all available lights.</p> <p><b>HELICOPTERS:</b> DAY or NIGHT-Irregular flashing of all available lights.</p>	In distress.	DAY or NIGHT-Use Series 2 signals prescribed for intercepting aircraft.	Understood.





## ENR 1.13 [RESERVED]



## **ENR 1.14 [RESERVED]**



## ENR 1.15 Medical Facts for Pilots

### 1. Fitness for Flight

#### 1.1 Medical Certification

**1.1.1** All pilots except those flying gliders and free air balloons must possess valid medical certificates in order to exercise the privileges of their airman certificates. The periodic medical examinations required for medical certification are conducted by designated Aviation Medical Examiners, who are physicians with a special interest in aviation safety and training in aviation medicine.

**1.1.2** The standards for medical certification are contained the Federal Aviation Regulations (14 CFR Part 67). Pilots who have a history of certain medical conditions described in these standards are mandatorily disqualified from flying. These medical conditions include a personality disorder manifested by overt acts, a psychosis, alcoholism, drug dependence, epilepsy, an unexplained disturbance of consciousness, myocardial infarction, angina pectoris, and diabetes requiring medication for its control. Other medical conditions may be temporarily disqualifying, such as acute infections, anemia, and peptic ulcer. Pilots who do not meet medical standards may still be qualified under special issuance provisions or the exemption process. This may require that either additional medical information be provided or practical flight tests be conducted.

**1.1.3** Student pilots should visit an aviation medical examiner as soon as possible in their flight training in order to avoid unnecessary training expenses should they not meet the medical standards. For the same reason, the student pilot who plans to enter commercial aviation should apply for the highest class of medical certificate that might be necessary in the pilot's career.

#### **CAUTION-**

*The Federal Aviation Regulations prohibit a pilot who possesses a current medical certificate from performing crewmember duties while the pilot has a known medical condition or increase of a known medical condition that would make the pilot unable to meet the standards for the medical certificate.*

#### 1.2 Illness

**1.2.1** Even a minor illness suffered in day-to-day living can seriously degrade performance of many piloting tasks vital to safe flight. Illness can produce fever and distracting symptoms that can impair judgment, memory, alertness, and the ability to make calculations. Although symptoms from an illness may be under adequate control with a medication, the medication itself may decrease pilot performance.

**1.2.2** The safest rule is not to fly while suffering from any illness. If this rule is considered too stringent for a particular illness, the pilot should contact an aviation medical examiner for advice.

#### 1.3 Medication

**1.3.1** Pilot performance can be seriously degraded by both prescribed and over-the-counter medications, as well as by the medical conditions for which they are taken. Many medications, such as tranquilizers, sedatives, strong pain relievers, and cough-suppressant preparations, have primary effects that may impair judgment, memory, alertness, coordination, vision, and the ability to make calculations. Others, such as antihistamines, blood pressure drugs, muscle relaxants, and agents to control diarrhea and motion sickness, have side effects that may impair the same critical functions. Any medication that depresses the nervous system, such as a sedative, tranquilizer, or antihistamine, can make a pilot much susceptible to hypoxia (see below).

**1.3.2** The Federal Aviation Regulations prohibit pilots from performing crewmember duties while using any medication that affects the faculties in any way contrary to safety. The safest rule is not to fly as a crewmember while taking any medication, unless approved to do so by the FAA.

#### 1.4 Alcohol

**1.4.1** Extensive research has provided a number of facts about the hazards of alcohol consumption and flying. As little as one ounce of liquor, one bottle of beer, or four ounces of wine can impair flying skills, with the alcohol

consumed in these drinks being detectable in the breath and blood at least three hours. Even after the body completely destroys a moderate amount of alcohol, a pilot can still be severely impaired for many hours by hangover. There is simply no way of increasing the destruction of alcohol or alleviating a hangover. Alcohol also renders a pilot much more susceptible to disorientation and hypoxia (see below).

**1.4.2** A consistently high alcohol–related, fatal aircraft accident rate serves to emphasize that alcohol and flying are a potentially lethal combination. The Federal Aviation Regulations prohibit pilots from performing crewmember duties within eight hours after drinking any alcoholic beverage or while under the influence of alcohol. However, due to the slow destruction of alcohol, a pilot may still be under the influence eight hours after drinking a moderate amount of alcohol. Therefore, an excellent rule is to allow at least 12 to 24 hours between “bottle and throttle” depending on the amount of alcoholic beverage consumed.

## **1.5 Fatigue**

**1.5.1** Fatigue continues to be one of the most treacherous hazards to flight safety, as it may not be apparent to a pilot until serious errors are made. Fatigue is best described as either acute (short–term) or chronic (long–term).

**1.5.2** A normal occurrence of everyday living, acute fatigue is the tiredness felt after long periods of physical and mental strain, including strenuous muscular effort, immobility, heavy mental workload, strong emotional pressure, monotony, and lack of sleep. Consequently, coordination and alertness, so vital to safe pilot performance, can be reduced. Acute fatigue is prevented by adequate rest and sleep, as well as regular exercise and proper nutrition.

**1.5.3** Chronic fatigue occurs when there is not enough time for full recovery between episodes of acute fatigue. Performance continues to fall off, and judgment becomes impaired so that unwarranted risks may be taken. Recovery from chronic fatigue requires a prolonged period of rest.

**1.5.4** OBSTRUCTIVE SLEEP APNEA (OSA). OSA is now recognized as an important preventable factor identified in transportation accidents. OSA interrupts the normal restorative sleep necessary for normal functioning and is associated with chronic illnesses such as hypertension, heart attack, stroke, obesity, and diabetes. Symptoms include snoring, excessive daytime sleepiness, intermittent prolonged breathing pauses while sleeping, memory impairment and lack of concentration. There are many available treatments which can reverse the day time symptoms and reduce the chance of an accident. OSA can be easily treated. Most treatments are acceptable for medical certification upon demonstrating effective treatment. If you have any symptoms described above, or neck size over 17 inches in men or 16 inches in women, or a body mass index greater than 30 you should be evaluated for sleep apnea by a sleep medicine specialist.

([https://www.cdc.gov/healthyweight/assessing/bmi/adult\\_bmi/english\\_bmi\\_calculator/bmi\\_calculator.html](https://www.cdc.gov/healthyweight/assessing/bmi/adult_bmi/english_bmi_calculator/bmi_calculator.html))  
With treatment you can avoid or delay the onset of these chronic illnesses and prolong a quality life.

## **1.6 Stress**

**1.6.1** Stress from the pressures of everyday living can impair pilot performance, often in very subtle ways. Difficulties, particularly at work, can occupy thought processes enough to markedly decrease alertness. Distraction can so interfere with judgment that unwarranted risks are taken, such as flying into deteriorating weather conditions to keep on schedule. Stress and fatigue (see above) can be an extremely hazardous combination.

**1.6.2** Most pilots do leave stress “on the ground.” Therefore when more than usual difficulties are being experienced, a pilot should consider delaying flight until these difficulties are satisfactorily resolved.

## **1.7 Emotion**

**1.7.1** Certain emotionally upsetting events, including a serious argument, death of a family member, separation or divorce, loss of job, and financial catastrophe, can render a pilot unable to fly an aircraft safely. The emotions of anger, depression, and anxiety from such events not only decrease alertness but also may lead to taking risks that border on self–destruction. Any pilot who experiences an emotionally upsetting event should not fly until satisfactorily recovered from it.

## 1.8 Personal Checklist

**1.8.1** Aircraft accident statistics show that pilots should be conducting preflight checklists on themselves as well as their aircraft, for pilot impairment contributes to many more accidents than failure of aircraft systems. A personal checklist that can be easily committed to memory, which includes all of the categories of pilot impairment discussed in this section, is distributed by the FAA in form of a wallet-sized card.

**1.9 PERSONAL CHECKLIST.** *I'm physically and mentally safe to fly; not being impaired by:*

**I**llness

**M**edication

**S**tress

**A**lcohol

**F**atigue

**E**motion

## 2. Effects of Altitude

### 2.1 Hypoxia

**2.1.1** Hypoxia is a state of oxygen deficiency in the body sufficient to impair functions of the brain and other organs. Hypoxia from exposure to altitude is due only to the reduced barometric pressures encountered at altitude, for the concentration of oxygen in the atmosphere remains about 21 percent from the ground out to space.

**2.1.2** Although a deterioration in night vision occurs at a cabin pressure altitude as low as 5,000 feet, other significant effects of altitude hypoxia usually do not occur in the normal healthy pilot below 12,000 feet. From 12,000 to 15,000 feet of altitude, judgment, memory, alertness, coordination and ability to make calculations are impaired. Headache, drowsiness, dizziness and either a sense of well-being (euphoria) or belligerence occur. The effects appear following increasingly shorter periods of exposure to increasing altitude. In fact, pilot performance can seriously deteriorate within 15 minutes at 15,000 feet.

**2.1.3** At cabin pressure altitudes above 15,000 feet, the periphery of the visual field grays out to a point where only central vision remains (tunnel vision). A blue coloration (cyanosis) of the fingernails and lips develops. The ability to take corrective and protective action is lost in 20 to 30 minutes at 18,000 feet and 5 to 12 minutes at 20,000 feet, followed soon thereafter by unconsciousness.

**2.1.4** The altitude at which significant effects of hypoxia occur can be lowered by a number of factors. Carbon monoxide inhaled in smoking or from exhaust fumes (see below), lowered hemoglobin (anemia), and certain medications can reduce the oxygen-carrying capacity of the blood to the degree that the amount of oxygen provided to body tissues will already be equivalent to the oxygen provided to the tissues when exposed to cabin pressure altitude of several thousand feet. Small amounts of alcohol and low doses of certain drugs, such as antihistamines, tranquilizers, sedatives, and analgesics can, through their depressant actions, render the brain much more susceptible to hypoxia. Extreme heat and cold, fever, and anxiety increase the body's demand for oxygen, and hence its susceptibility to hypoxia.

**2.1.5** The effects of hypoxia are usually quite difficult to recognize, especially when they occur gradually. Since symptoms of hypoxia do not vary in an individual, the ability to recognize hypoxia can be greatly improved by experiencing and witnessing the effects of hypoxia during an altitude chamber “flight.” The FAA provides this opportunity through aviation physiology training, which is conducted at the FAA Civil Aeromedical Institute and at many military facilities across the U.S. To attend the Physiological Training Program at the Civil Aeromedical Institute, Mike Monroney Aeronautical Center, Oklahoma City, OK, contact by telephone (405) 954-6212, or by writing Aerospace Medical Education Division, AAM-400, CAMI, Mike Monroney Aeronautical Center, P.O. Box 25082, Oklahoma City, OK 73125.

**NOTE-**

*To attend the physiological training program at one of the military installations having the training capability, an application form and a fee must be submitted. Full particulars about location, fees, scheduling procedures, course content, individual requirements, etc., are contained in the physiological training application, Form Number AC-3150-7, which is obtained by contacting the Accident Prevention Specialist or the Office Forms Manager in the nearest FAA office.*

**2.1.6** Hypoxia is prevented by heeding factors that reduce tolerance to altitude, by enriching the inspired air with oxygen from an appropriate oxygen system and by maintaining a comfortable, safe cabin pressure altitude. For optimum protection, pilots are encouraged to use supplemental oxygen above 10,000 feet during the day, and above 5,000 feet at night. The Federal Aviation Regulations require that the minimum flight crew be provided with and use supplemental oxygen after 30 minutes of exposure to cabin pressure altitudes between 12,500 and 14,000 feet, and immediately on exposure to cabin pressure altitudes above 14,000. Every occupant of the aircraft must be provided with supplemental oxygen at cabin pressure altitudes above 15,000 feet.

**2.2 Ear Block**

**2.2.1** As the aircraft cabin pressure decreases during ascent, the expanding air in the middle ear pushes the eustachian tube open and, by escaping down it to the nasal passages, equalizes in pressure with the cabin pressure. But during descent, the pilot must periodically open the eustachian tube to equalize pressure. This can be accomplished by swallowing, yawning, tensing muscles in the throat or, if these do not work, by the combination of closing the mouth, pinching the nose closed and attempting to blow through the nostrils (Valsalva maneuver).

**2.2.2** Either an upper respiratory infection, such as a cold or sore throat, or a nasal allergic condition can produce enough congestion around the eustachian tube to make equalization difficult. Consequently, the difference in pressure between the middle ear and aircraft cabin can build up to a level that will hold the eustachian tube closed, making equalization difficult if not impossible. This problem is commonly referred to as an “ear block.”

**2.2.3** An ear block produces severe ear pain and loss of hearing that can last from several hours to several days. Rupture of the ear drum can occur in flight or after landing. Fluid can accumulate in the middle ear and become infected.

**2.2.4** An ear block is prevented by not flying with an upper respiratory infection or nasal allergic condition. Adequate protection is usually not provided by decongestant sprays or drops to reduce congestion around the eustachian tubes. Oral decongestants have side effects that can significantly impair pilot performance.

**2.2.5** If an ear block does not clear shortly after landing, a physician should be consulted.

**2.3 Sinus Block**

**2.3.1** During ascent and descent, air pressure in the sinuses equalizes with the aircraft cabin pressure through small openings that connect the sinuses to the nasal passages. Either an upper respiratory infection, such as a cold or sinusitis, or a nasal allergic condition can produce enough congestion around an opening to slow equalization and, as the difference in pressure between the sinus and cabin mounts, eventually plug the opening. This “sinus block” occurs most frequently during descent.

**2.3.2** A sinus block can occur in the frontal sinuses, located above each eyebrow, or in the maxillary sinuses, located in each upper cheek. It will usually produce excruciating pain over the sinus area. A maxillary sinus block can also make the upper teeth ache. Bloody mucus may discharge from the nasal passages.



**2.3.3** A sinus block is prevented by not flying with an upper respiratory infection or nasal allergic condition. Adequate protection is usually not provided by decongestant sprays or drops to reduce congestion around the sinus openings. Oral decongestants have side effects that can impair pilot performance.

**2.3.4** If a sinus block does not clear shortly after landing, a physician should be consulted.

## **2.4 Decompression Sickness After Scuba Diving**

**2.4.1** A pilot or passenger who intends to fly after scuba diving should allow the body sufficient time to rid itself of excess nitrogen absorbed during diving. If not, altitude decompression sickness due to evolved nitrogen gas can occur during exposure to reduced barometric pressure (i.e., low cabin pressure) associated with increased altitude and may lead to a serious inflight emergency.

**2.4.2** The recommended wait time before going to flight altitudes up to 8,000 feet is at least 12 hours after diving that did not require a controlled ascent (i.e., non-decompression stop diving), and at least 24 hours after diving that required a controlled ascent (i.e., decompression stop diving). The recommended wait time before going to flight altitudes above 8,000 feet is at least 24 hours after any SCUBA dive. These altitudes are actual flight altitudes above mean sea level (AMSL) and not pressurized cabin altitudes. This takes into consideration the risk of aircraft decompression during flight.

## **3. Hyperventilation in Flight**

**3.1** Hyperventilation, or an abnormal increase in the volume of air breathed in and out of the lungs, can occur subconsciously when a stressed situation is encountered in flight. As hyperventilation “blows off” excessive carbon dioxide from the body, a pilot can experience symptoms of lightheadedness, suffocation, drowsiness, tingling in the extremities, and coolness – and react to them with even greater hyperventilation. Incapacitation can eventually result from incoordination, disorientation, and painful muscle spasms. Finally, unconsciousness can occur.

**3.2** The symptoms of hyperventilation subside within a few minutes after the rate and depth of breathing are consciously brought back under control. The buildup of carbon dioxide in the body can be hastened by controlled breathing in and out of a paper bag held over the nose and mouth.

**3.3** Early symptoms of hyperventilation and hypoxia are similar. Moreover, hyperventilation and hypoxia can occur at the same time. Therefore, if a pilot is using an oxygen system when symptoms are experienced, the oxygen regulator should immediately be set to deliver 100 percent oxygen, and then the system checked to assure that it has been functioning effectively before giving attention to rate and depth of breathing.

## **4. Carbon Monoxide Poisoning in Flight**

**4.1** Carbon monoxide is a colorless, odorless, and tasteless gas contained in exhaust fumes. When breathed even in minute quantities over a period of time, it can significantly reduce the ability of the blood to carry oxygen. Consequently, effects of hypoxia occur (see subparagraph 2.1).

**4.2** Most heaters in light aircraft work by air flowing over the manifold. Use of these heaters while exhaust fumes are escaping through manifold cracks and seals is responsible every year for several nonfatal and fatal aircraft accidents from carbon monoxide poisoning.

**4.3** A pilot who detects the odor of exhaust or experiences symptoms of headache, drowsiness, or dizziness while using the heater should suspect carbon monoxide poisoning, and immediately shut off the heater and open air vents. If symptoms are severe, or continue after landing, medical treatment should be sought.

## **5. Illusions in Flight**

**5.1 Introduction.** Many different illusions can be experienced in flight. Some can lead to spatial disorientation. Others can lead to landing errors. Illusions rank among the most common factors cited as contributing to fatal aircraft accidents.

## 5.2 Illusions Leading to Spatial Disorientation

**5.2.1** Various complex motions and forces and certain visual scenes encountered in flight can create illusions of motion and position. Spatial disorientation from these illusions can be prevented only by visual reference to reliable, fixed points on the ground or to flight instruments.

**5.2.2 The Leans.** An abrupt correction of a banked attitude, which has been entered too slowly to stimulate the motion sensing system in the inner ear, can create the illusion of banking in the opposite direction. The disoriented pilot will roll the aircraft back into its original dangerous attitude or, if level flight is maintained, will feel compelled to lean in the perceived vertical plane until this illusion subsides.

**5.2.3 Coriolis Illusion.** An abrupt head movement in a prolonged constant–rate turn that has ceased stimulating the motion sensing system can create the illusion of rotation or movement in an entirely different axis. The disoriented pilot will maneuver the aircraft into a dangerous attitude in an attempt to stop rotation. This most overwhelming of all illusions in flight may be prevented by not making sudden, extreme head movements, particularly while making prolonged constant–rate turns under IFR conditions.

**5.2.4 Graveyard Spin.** A proper recovery from a spin that has ceased stimulating the motion sensing system can create the illusion of spinning in the opposite direction. The disoriented pilot will return the aircraft to its original spin.

**5.2.5 Graveyard Spiral.** An observed loss of altitude during a coordinated constant–rate turn that has ceased stimulating the motion sensing system can create the illusion of being in a descent with the wings level. The disoriented pilot will pull back on the controls, tightening the spiral and increasing the loss of altitude.

**5.2.6 Somatogravic Illusion.** A rapid acceleration during takeoff can create the illusion of being in a nose–up attitude. The disoriented pilot will push the aircraft into a nose–low, or dive attitude. A rapid deceleration by a quick reduction of the throttles can have the opposite effect, with the disoriented pilot pulling the aircraft into a nose–up, or stall attitude.

**5.2.7 Inversion Illusion.** An abrupt change from climb to straight and level flight can create the illusion of tumbling backwards. The disoriented pilot will push the aircraft abruptly into a nose–low attitude, possibly intensifying this illusion.

**5.2.8 Elevator Illusion.** An abrupt upward vertical acceleration, usually by an updraft, can create the illusion of being in a climb. The disoriented pilot will push the aircraft into a nose–low attitude. An abrupt downward vertical acceleration, usually by a downdraft, has the opposite effect, with the disoriented pilot pulling the aircraft into a nose–up attitude.

**5.2.9 False Horizon.** Sloping cloud formations, an obscured horizon, a dark scene spread with ground lights and stars, and certain geometric patterns of ground lights can create illusions of not being aligned correctly with the actual horizon. The disoriented pilot will place the aircraft in a dangerous attitude.

**5.2.10 Autokinesis.** In the dark, a static light will appear to move about when stared at for many seconds. The disoriented pilot will lose control of the aircraft in attempting to align it with the light.

## 5.3 Illusions Leading to Landing Errors

**5.3.1** Various surface features and atmospheric conditions encountered in landing can create illusions of incorrect height above and distance from the runway threshold. Landing errors from these illusions can be prevented by anticipating them during approaches, aerial visual inspection of unfamiliar airports before landing, using electronic glide slope or VASI systems when available, and maintaining optimum proficiency in landing procedures.

**5.3.2 Runway Width Illusion.** A narrower–than–usual runway can create the illusion that the aircraft is at a higher altitude than it actually is. The pilot who does not recognize this illusion will fly a lower approach, with the risk of striking objects along the approach path or landing short. A wider–than–usual runway can have the opposite effect, with the risk of leveling out high and landing hard or overshooting the runway.

**5.3.3 Runway and Terrain Slopes Illusion.** An upsloping runway, upsloping terrain, or both, can create the illusion that the aircraft is at a higher altitude than it actually is. The pilot who does not recognize this illusion will fly a lower approach. A downsloping runway, downsloping approach terrain, or both, can have the opposite effect.

**5.3.4 Featureless Terrain Illusion.** An absence of ground features, as when landing over water, darkened areas, and terrain made featureless by snow, can create the illusion that the aircraft is at a higher altitude than it actually is. The pilot who does not recognize this illusion will fly a lower approach.

**5.3.5 Atmospheric Illusions.** Rain on the windscreen can create the illusion of greater height, and atmospheric haze can create the illusion of being at greater distance from the runway. The pilot who does not recognize these illusions will fly a lower approach. Penetration of fog can create the illusion of pitching up. The pilot who does not recognize this illusion will steepen the approach, often quite abruptly.

**5.3.6 Ground Lighting Illusions.** Lights along a straight path, such as a road, and even lights on moving trains can be mistaken for runway and approach lights. Bright runway and approach lighting systems, especially where few lights illuminate the surrounding terrain, may create the illusion of less distance to the runway. The pilot who does not recognize this illusion will fly a higher approach. Conversely, the pilot overflying terrain which has few lights to provide height cues may make lower than normal approach.

## 6. Vision in Flight

**6.1 Introduction.** Of the body senses, vision is the most important for safe flight. Major factors that determine how effectively vision can be used are the level of illumination and the technique of scanning the sky for other aircraft.

### 6.2 Vision Under Dim and Bright Illumination

**6.2.1** Under conditions of dim illumination, small print and colors on aeronautical charts and aircraft instruments become unreadable unless adequate cockpit lighting is available. Moreover, another aircraft must be much closer to be seen unless its navigation lights are on.

**6.2.2** In darkness, vision becomes more sensitive to light, a process called dark adaptation. Although exposure to total darkness for at least 30 minutes is required for complete dark adaptation, the pilot can achieve a moderate degree of dark adaptation within 20 minutes under dim red cockpit lighting. Since red light severely distorts colors, especially on aeronautical charts, and can cause serious difficulty in focusing the eyes on objects inside the aircraft, its use is advisable only where optimum outside night vision capability is necessary. Even so, white cockpit lighting must be available when needed for map and instrument reading, especially under IFR conditions. Dark adaptation is impaired by exposure to cabin pressure altitude above 5,000 feet, carbon monoxide inhaled in smoking and from exhaust fumes, deficiency of Vitamin A in the diet, and by prolonged exposure to bright sunlight. Since any degree of dark adaptation is lost within a few seconds of viewing a bright light, the pilot should close one eye when using a light to preserve some degree of night vision.

**6.2.3** Excessive illumination, especially from light reflected off the canopy, surfaces inside the aircraft, clouds, water, snow, and desert terrain, can produce glare, with uncomfortable squinting, watering of the eyes, and even temporary blindness. Sunglasses for protection from glare should absorb at least 85 percent of visible light (15 percent transmittance) and all colors equally (neutral transmittance), with negligible image distortion from refractive and prismatic errors.

### 6.3 Scanning for Other Aircraft

**6.3.1** Scanning the sky for other aircraft is a key factor in collision avoidance. It should be used continuously by the pilot and copilot (or right seat passenger) to cover all areas of the sky visible from the cockpit. Although pilots must meet specific visual acuity requirements, the ability to read an eye chart does not ensure that one will be able to efficiently spot other aircraft. Pilots must develop an effective scanning technique which maximizes one's visual capabilities. The probability of spotting a potential collision threat obviously increases with the time spent looking outside the cockpit. Thus, one must use timesharing techniques to efficiently scan the surrounding airspace while monitoring instruments as well.

**6.3.2** While the eyes can observe an approximate 200 degree arc of the horizon at one glance, only a very small center area called the fovea, in the rear of the eye, has the ability to send clear, sharply focused messages to the brain. All other visual information that is not processed directly through the fovea will be of less detail. An aircraft at a distance of 7 miles which appears in sharp focus within the foveal center of vision would have to be as close as 7/10 of a mile in order to be recognized if it were outside of foveal vision. Because the eyes can focus only on this narrow viewing area, effective scanning is accomplished with a series of short, regularly spaced eye movements that bring successive areas of the sky into the central visual field. Each movement should not exceed 10 degrees, and each area should be observed for at least one second to enable detection. Although horizontal back-and-forth eye movements seem preferred by most pilots, each pilot should develop a scanning pattern that is most comfortable and then adhere to it to assure optimum scanning.

**6.3.3** Studies show that the time a pilot spends on visual tasks inside the cabin should represent no more than  $\frac{1}{4}$  to  $\frac{1}{3}$  of the scan time outside, or no more than 4 to 5 seconds on the instrument panel for every 16 seconds outside. Since the brain is already trained to process sight information that is presented from left to right, one may find it easier to start scanning over the left shoulder and proceed across the windshield to the right.

**6.3.4** Pilots should realize that their eyes may require several seconds to refocus when switching views between items in the cockpit and distant objects. The eyes will also tire more quickly when forced to adjust to distances immediately after close-up focus, as required for scanning the instrument panel. Eye fatigue can be reduced by looking from the instrument panel to the left wing past the wing tip to the center of the first scan quadrant when beginning the exterior scan. After having scanned from left to right, allow the eyes to return to the cabin along the right wing from its tip inward. Once back inside, one should automatically commence the panel scan.

**6.3.5** Effective scanning also helps avoid “empty-field myopia.” This condition usually occurs when flying above the clouds or in a haze layer that provides nothing specific to focus on outside the aircraft. This causes the eyes to relax and seek a comfortable focal distance which may range from 10 to 30 feet. For the pilot, this means looking without seeing, which is dangerous.

## **7. Judgment Aspects of Collision Avoidance**

**7.1 Introduction.** The most important aspects of vision and the techniques to scan for other aircraft are described in paragraph 6. above. Pilots should also be familiar with the following information to reduce the possibility of mid-air collisions.

**7.2 Determining Relative Altitude.** Use the horizon as a reference point. If the other aircraft is above the horizon, it is probably on a higher flight path. If the aircraft appears to be below the horizon, it is probably flying at a lower altitude.

**7.3 Taking Appropriate Action.** Pilots should be familiar with right-of-way rules so immediate evasive action can be taken if an aircraft is on an obvious collision course. Preferably, such actions will be in compliance with applicable Federal Aviation Regulations.

**7.4 Consider Multiple Threats.** The decision to climb, descend, or turn is a matter of personal judgment, but one should anticipate that the other pilot may also be making a quick maneuver. Watch the other aircraft during the maneuver and immediately begin your scanning again since there may be other aircraft in the area.

**7.5 Target Acquisition.** Anticipate the target in the location and ranges you are searching. Locate a sizable, distant object (e.g., a cloud formation, mountain peak, prominent landmark, building or pier) that is within range of the anticipated target, and focus your eyes on it as you begin each scan pattern.

**7.6 Collision Course Targets.** Any aircraft that appears to have no relative motion and stays in one scan quadrant is likely to be on a collision course. Also, if a target shows no lateral or vertical motion, but increases in size, TAKE EVASIVE ACTION.

### **7.7 Recognize High Hazard Areas**

**7.7.1** Airways, and especially VORs, and Class B, C, D, and E surface areas are places where aircraft tend to cluster.

**7.7.2** Remember, most collisions occur during days when the weather is good. Being in a “radar environment” still requires vigilance to avoid collisions.

**7.8 Cockpit Management.** Studying maps, checklists, and manuals before flight, with various other proper preflight planning (e.g., noting necessary radio frequencies), and organizing cockpit materials can reduce the amount of time required to look at these items during flight permitting more scan time.

**7.9 Windshield Conditions.** Dirty or bug-smeared windshields can greatly reduce the ability of pilots to see other aircraft. Keep a clean windshield.

**7.10 Visibility Conditions.** Smoke, haze, dust, rain, and flying towards the sun can also greatly reduce the ability to detect targets.

### **7.11 Visual Obstruction in the Cockpit**

**7.11.1** Pilots need to move their heads to see around blind spots caused by fixed aircraft structures, such as door posts, wings, etc. It will be necessary at times to maneuver the aircraft (e.g., lift a wing) to facilitate seeing around this structure.

**7.11.2** Pilots must insure that curtains and other cockpit objects (e.g., maps on glare shield) are removed and stowed during flight.

### **7.12 Lights On**

**7.12.1** Day or night, use of exterior lights can greatly increase the conspicuity of any aircraft.

**7.12.2** Keep interior lights low at night.

**7.13 ATC Support.** ATC facilities often provide radar traffic advisories on a workload-permitting basis. Flight through Class C Airspace requires communication with ATC. Use this support whenever possible or when required.



## ENR 1.16 Safety, Hazard, and Accident Reports

### 1. Aviation Safety Reporting Program

**1.1** The FAA has established a voluntary program designed to stimulate the free and unrestricted flow of information concerning deficiencies and discrepancies in the aviation system. This is a positive program intended to ensure the safest possible system by identifying and correcting unsafe conditions before they lead to accidents. The primary objective of the program is to obtain information to evaluate and enhance the safety and efficiency of the present system.

**1.2** This cooperative safety reporting program invites pilots, controllers, flight attendants, maintenance personnel and other users of the airspace system, or any other person, to file written reports of actual or potential discrepancies and deficiencies involving the safety of aviation operations. The operations covered by the program include departure, en route, approach, and landing operations and procedures, air traffic control procedures and equipment, crew and air traffic control communications, aircraft cabin operations, aircraft movement on the airport, near midair collisions, aircraft maintenance and record keeping, and airport conditions or services.

**1.3** The report should give the date, time, location, persons and aircraft involved (if applicable), nature of the event, and all pertinent details.

**1.4** To ensure receipt of this information, the program provides for the waiver of certain disciplinary actions against persons, including pilots and air traffic controllers, who file timely written reports concerning potentially unsafe incidents. To be considered timely, reports must be delivered or postmarked within 10 days of the incident unless that period is extended for good cause. Reports should be submitted on National Aeronautics and Space Administration (NASA) ARC Forms 277, which are available free of charge, postage prepaid, at FAA Flight Standards District Offices and Flight Service Stations, and from NASA, ASRS, P.O. Box 189, Moffet Field, CA 94035.

**1.5** The FAA utilizes NASA to act as an independent third party to receive and analyze reports submitted under the program. This program is described in Advisory Circular 00-46.

### 2. Aircraft Accident and Incident Reporting

#### 2.1 Occurrences Requiring Notification

**2.1.1** The operator of an aircraft must immediately, and by the most expeditious means available, notify the nearest National Transportation Safety Board (NTSB) Field Office when:

**2.1.1.1** An aircraft accident or any of the following listed incidents occur:

- a) Flight control system malfunction or failure.
- b) Inability of any required flight crewmember to perform normal flight duties as a result of injury or illness.
- c) Failure of structural components of a turbine engine excluding compressor and turbine blades and vanes.
- d) Inflight fire.
- e) Aircraft collide in flight.
- f) Damage to property, other than the aircraft, estimated to exceed \$25,000 for repair (including materials and labor) or fair market value in the event of total loss, whichever is less.
- g) For large multi-engine aircraft (more than 12,500 pounds maximum certificated takeoff weight):
  - 1) Inflight failure of electrical systems which requires the sustained use of an emergency bus powered by a back-up source such as a battery, auxiliary power unit, or air-driven generator to retain flight control or essential instruments.

2) Inflight failure of hydraulic systems that results in sustained reliance on the sole remaining hydraulic or mechanical system for movement of flight control surfaces.

3) Sustained loss of the power or thrust produced by two or more engines.

4) An evacuation of aircraft in which an emergency egress system is utilized.

2.1.1.2 An aircraft is overdue and is believed to have been involved in an accident.

## 2.2 Manner of Notification

2.2.1 The most expeditious method of notification to the NTSB by the operator will be determined by the circumstances existing at the time. The NTSB has advised that any of the following would be considered examples of the type of notification that would be acceptable:

2.2.1.1 Direct telephone notification.

2.2.1.2 Telegraphic notification.

2.2.1.3 Notification to the FAA who would in turn notify the NTSB by direct communication; i.e., dispatch or telephone.

## 2.3 Items to be Reported

2.3.1 The notification required above must contain the following information, if available:

2.3.1.1 Type, nationality, and registration marks of the aircraft.

2.3.1.2 Name of owner and operator of the aircraft.

2.3.1.3 Name of the pilot-in-command.

2.3.1.4 Date and time of the accident.

2.3.1.5 Last point of departure and point of intended landing of the aircraft.

2.3.1.6 Position of the aircraft with reference to some easily defined geographical point.

2.3.1.7 Number of persons aboard, number killed, and number seriously injured.

2.3.1.8 Nature of the accident or incident, the weather, and the extent of damage to the aircraft, so far as is known.

2.3.1.9 A description of any explosives, radioactive materials, or other dangerous articles carried.

## 2.4 Follow-up Reports

2.4.1 The operator must file a report on NTSB Form 6120.1 or 6120.2, available from the NTSB Field Offices, or the NTSB, Washington, D.C. 20594:

2.4.1.1 Within ten days after an accident.

2.4.1.2 When, after seven days, an overdue aircraft is still missing.

2.4.1.3 A report on an incident for which notification is required as described in paragraph 2.1 must be filed only as requested by an authorized representative of the NTSB.

2.4.2 Each crewmember, if physically able at the time the report is submitted, must attach a statement setting forth the facts, conditions and circumstances relating to the accident or occurrence as they appeared. If the crewmember is incapacitated, the statement must be submitted as soon as physically possible.

## 2.5 Where to File the Reports

2.5.1 The operator of an aircraft must file with the field office of the NTSB nearest the accident or incident any report required by this section.

2.5.2 The NTSB field offices are listed under U.S. Government in the telephone directories in the following cities: Anchorage, Alaska; Atlanta, Georgia; Chicago, Illinois; Denver, Colorado; Fort Worth, Texas; Los Angeles, California; Miami, Florida; Parsippany, New Jersey; and Seattle, Washington.



### 3. Near Midair Collision Reporting

**3.1 Purpose and Data Uses.** The primary purpose of the Near Midair Collision (NMAC) Reporting Program is to provide information for use in enhancing the safety and efficiency of the National Airspace System. Data obtained from NMAC reports are used by the FAA to improve the quality of FAA services to users and to develop programs, policies, and procedures aimed at the reduction of NMAC occurrences. All NMAC reports are thoroughly investigated by Flight Standards Facilities in coordination with Air Traffic Facilities. Data from these investigations are transmitted to FAA Headquarters in Washington, D.C., where they are compiled and analyzed, and where safety programs and recommendations are developed.

**3.2 Definition.** A near midair collision is defined as an incident associated with the operation of an aircraft in which a possibility of collision occurs as a result of proximity of less than 500 feet to another aircraft, or a report is received from a pilot or a flight crewmember stating that a collision hazard existed between two or more aircraft.

**3.3 Reporting Responsibility.** It is the responsibility of the pilot and/or flight crew to determine whether a near midair collision did actually occur and, if so, to initiate a NMAC report. Be specific, as ATC will not interpret a casual remark to mean that a NMAC is being reported. The pilot should state “I wish to report a near midair collision.”

**3.4 Where to File Reports.** Pilots and/or flight crewmembers involved in NMAC occurrences are urged to report each incident immediately:

**3.4.1** By radio or telephone to the nearest FAA ATC facility or FSS.

**3.4.2** In writing, in lieu of the above, to the nearest Flight Standards District Office (FSDO).

#### 3.5 Items to be Reported

**3.5.1** Date and time (UTC) of incident.

**3.5.2** Location of incident and altitude.

**3.5.3** Identification and type of reporting aircraft, aircrew destination, name and home base of pilot.

**3.5.4** Identification and type of other aircraft, aircrew destination, name and home base of pilot.

**3.5.5** Type of flight plans; station altimeter setting used.

**3.5.6** Detailed weather conditions at altitude or flight level.

**3.5.7** Approximate courses of both aircraft: indicate if one or both aircraft were climbing or descending.

**3.5.8** Reported separation in distance at first sighting, proximity at closest point horizontally and vertically, length of time in sight prior to evasive action.

**3.5.9** Degree of evasive action taken, if any (from both aircraft, if possible).

**3.5.10** Injuries, if any.

**3.6 Investigation.** The FSDO in whose area the incident occurred is responsible for the investigation and reporting of NMACs.

**3.7** Existing radar, communication, and weather data will be examined in the conduct of the investigation. When possible, all cockpit crew members will be interviewed regarding factors involving the NMAC incident. Air traffic controllers will be interviewed in cases where one or more of the involved aircraft was provided ATC service. Both flight and ATC procedures will be evaluated. When the investigation reveals a violation of an FAA regulation, enforcement action will be pursued.

### 4. Unidentified Flying Object (UFO) Reports

**4.1** Persons wanting to report UFO/unexplained phenomena activity should contact a UFO/unexplained phenomena reporting data collection center, such as the National UFO Reporting Center, etc.

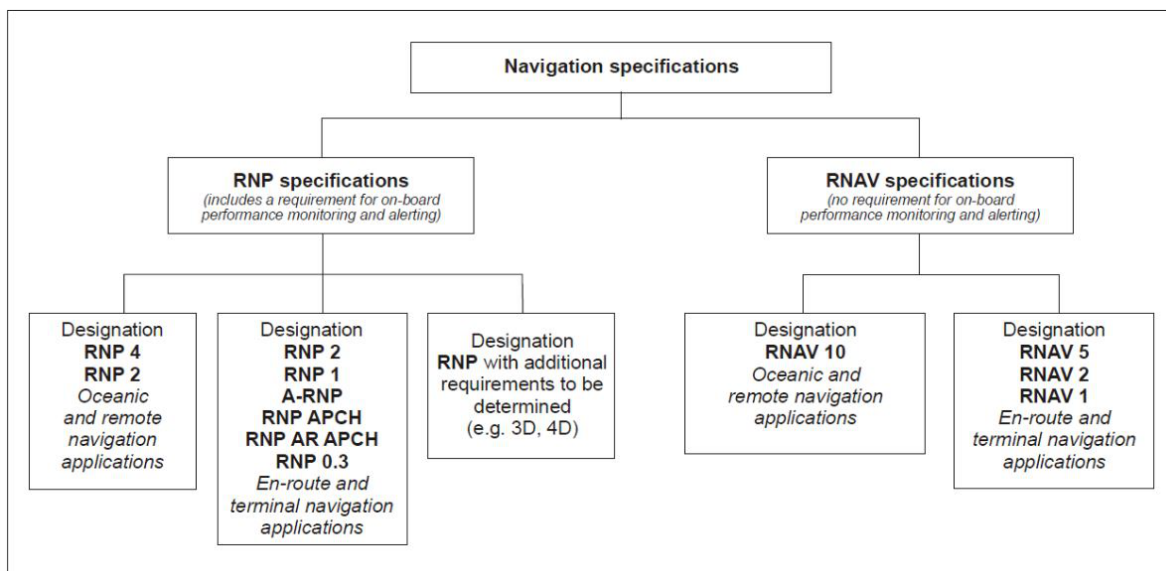


# ENR 1.17 Performance-Based Navigation (PBN) and Area Navigation (RNAV)

## 1. General

**1.1 Introduction to PBN.** As air travel has evolved, methods of navigation have improved to give operators more flexibility. PBN exists under the umbrella of area navigation (RNAV). The term RNAV in this context, as in procedure titles, just means “area navigation,” regardless of the equipment capability of the aircraft. (See FIG ENR 1.17-1.) Many operators have upgraded their systems to obtain the benefits of PBN. Within PBN there are two main categories of navigation methods or specifications: area navigation (RNAV) and required navigation performance (RNP). In this context, the term RNAV *x* means a specific navigation specification with a specified lateral accuracy value. For an aircraft to meet the requirements of PBN, a specified RNAV or RNP accuracy must be met 95 percent of the flight time. RNP is a PBN system that includes onboard performance monitoring and alerting capability (for example, Receiver Autonomous Integrity Monitoring (RAIM)). PBN also introduces the concept of navigation specifications (NavSpecs) which are a set of aircraft and aircrew requirements needed to support a navigation application within a defined airspace concept. For both RNP and RNAV NavSpecs, the numerical designation refers to the lateral navigation accuracy in nautical miles which is expected to be achieved at least 95 percent of the flight time by the population of aircraft operating within the airspace, route, or procedure. This information is detailed in International Civil Aviation Organization’s (ICAO) Doc 9613, Performance-based Navigation (PBN) Manual and the latest FAA AC 90-105, Approval Guidance for RNP Operations and Barometric Vertical Navigation in the U.S. National Airspace System and in Remote and Oceanic Airspace.

FIG ENR 1.17-1  
Navigation Specifications



## 1.2 Area Navigation (RNAV)

**1.2.1 General.** RNAV is a method of navigation that permits aircraft operation on any desired flight path within the coverage of ground- or space-based navigation aids or within the limits of the capability of self-contained aids, or a combination of these. In the future, there will be an increased dependence on the use of RNAV in lieu of routes defined by ground-based navigation aids. RNAV routes and terminal procedures, including departure procedures (DPs) and standard terminal arrivals (STAR), are designed with RNAV systems in mind. There are several potential advantages of RNAV routes and procedures:

**1.2.1.1** Time and fuel savings;

**1.2.1.2** Reduced dependence on radar vectoring, altitude, and speed assignments allowing a reduction in required ATC radio transmissions; and

**1.2.1.3** More efficient use of airspace.

In addition to information found in this manual, guidance for domestic RNAV DPs, STARs, and routes may also be found in Advisory Circular 90-100, U.S. Terminal and En Route Area Navigation (RNAV) Operations.

**1.2.2 RNAV Operations.** RNAV procedures, such as DPs and STARs, demand strict pilot awareness and maintenance of the procedure centerline. Pilots should possess a working knowledge of their aircraft navigation system to ensure RNAV procedures are flown in an appropriate manner. In addition, pilots should have an understanding of the various waypoint and leg types used in RNAV procedures; these are discussed in more detail below.

**1.2.2.1 Waypoints.** A waypoint is a predetermined geographical position that is defined in terms of latitude/longitude coordinates. Waypoints may be a simple named point in space or associated with existing navaids, intersections, or fixes. A waypoint is most often used to indicate a change in direction, speed, or altitude along the desired path. RNAV procedures make use of both fly-over and fly-by waypoints.

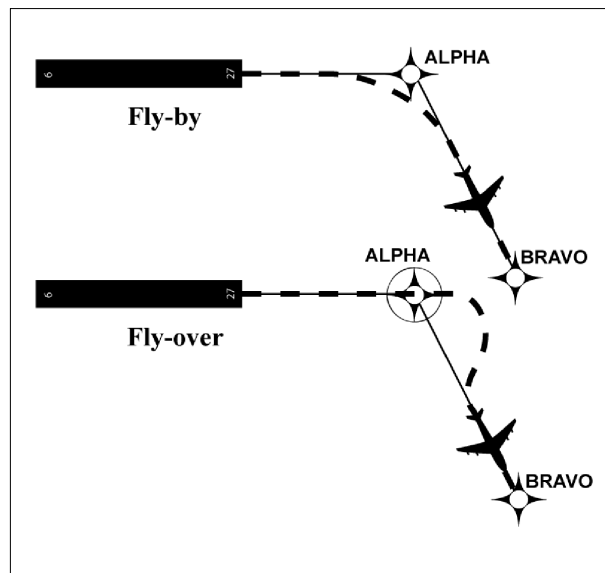
**a) Fly-by waypoints.** Fly-by waypoints are used when an aircraft should begin a turn to the next course prior to reaching the waypoint separating the two route segments. This is known as turn anticipation.

**b) Fly-over waypoints.** Fly-over waypoints are used when the aircraft must fly over the point prior to starting a turn.

**NOTE-**

FIG ENR 1.17-2 illustrates several differences between a fly-by and a fly-over waypoint.

FIG ENR 1.17-2  
Fly-by and Fly-over Waypoints



**1.2.2.2 RNAV Leg Types.** A leg type describes the desired path proceeding, following, or between waypoints on an RNAV procedure. Leg types are identified by a two-letter code that describes the path (e.g., heading, course, track, etc.) and the termination point (e.g., the path terminates at an altitude, distance, fix, etc.). Leg types used for procedure design are included in the aircraft navigation database, but not normally provided on the procedure chart. The narrative depiction of the RNAV chart describes how a procedure is flown. The “path and terminator concept” defines that every leg of a procedure has a termination point and some kind of path into that termination point. Some of the available leg types are described below.

a) **Track to Fix.** A Track to Fix (TF) leg is intercepted and acquired as the flight track to the following waypoint. Track to a Fix legs are sometimes called point-to-point legs for this reason. *Narrative:* “direct ALPHA, then on course to BRAVO WP.” See FIG ENR 1.17-3.

b) **Direct to Fix.** A Direct to Fix (DF) leg is a path described by an aircraft’s track from an initial area direct to the next waypoint. *Narrative:* “turn right direct BRAVO WP.” See FIG ENR 1.17-4.

FIG ENR 1.17-3  
Track to Fix Leg Type

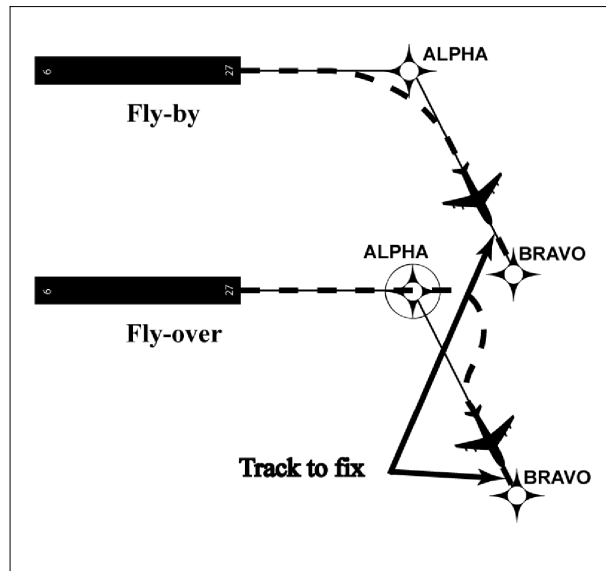
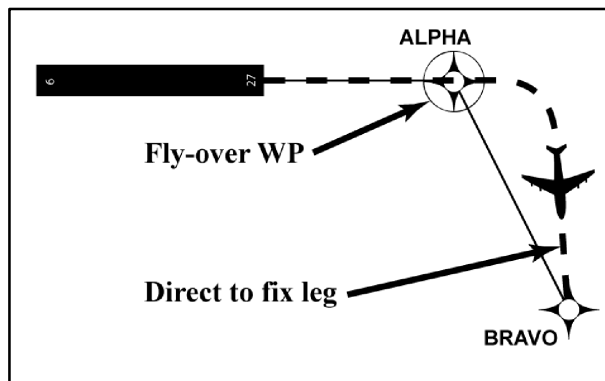
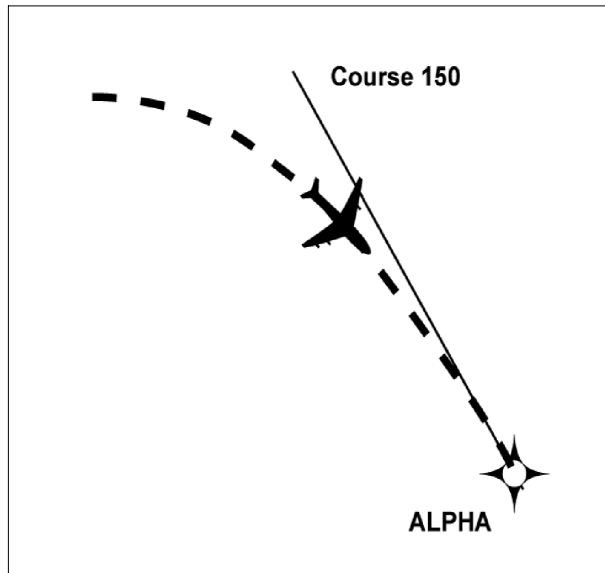


FIG ENR 1.17-4  
Direct to Fix Leg Type



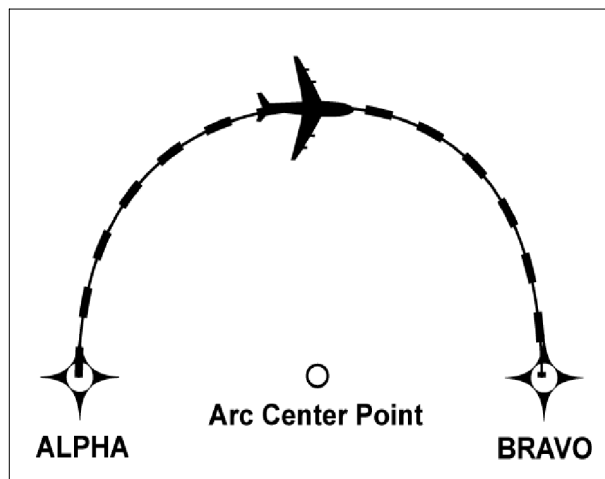
c) **Course to Fix.** A Course to Fix (CF) leg is a path that terminates at a fix with a specified course at that fix. *Narrative:* “on course 150 to ALPHA WP.” See FIG ENR 1.17-5.

FIG ENR 1.17-5  
Course to Fix Leg Type



d) **Radius to Fix.** A Radius to Fix (RF) leg is defined as a constant radius circular path around a defined turn center that terminates at a fix. See FIG ENR 1.17-6.

FIG ENR 1.17-6  
Radius to Fix Leg Type



e) **Heading.** A Heading leg may be defined as, but not limited to, a Heading to Altitude (VA), Heading to DME range (VD), and Heading to Manual Termination, i.e., Vector (VM). *Narrative:* “climb heading 350 to 1500”, “heading 265, at 9 DME west of PXR VORTAC, right turn heading 360”, “fly heading 090, expect radar vectors to DRYHT INT.”

**1.2.2.3 Navigation Issues.** Pilots should be aware of their navigation system inputs, alerts, and annunciations in order to make better-informed decisions. In addition, the availability and suitability of particular sensors/systems should be considered.

a) **GPS/WAAS.** Operators using TSO-C129(), TSO-C196(), TSO-C145() or TSO-C146() systems should ensure departure and arrival airports are entered to ensure proper RAIM availability and CDI sensitivity.

b) **DME/DME.** Operators should be aware that DME/DME position updating is dependent on navigation system logic and DME facility proximity, availability, geometry, and signal masking.

c) **VOR/DME.** Unique VOR characteristics may result in less accurate values from VOR/DME position updating than from GPS or DME/DME position updating.

d) **Inertial Navigation.** Inertial reference units and inertial navigation systems are often coupled with other types of navigation inputs, e.g., DME/DME or GPS, to improve overall navigation system performance.

**NOTE-**

*Specific inertial position updating requirements may apply.*

**1.2.2.4 Flight Management System (FMS).** An FMS is an integrated suite of sensors, receivers, and computers, coupled with a navigation database. These systems generally provide performance and RNAV guidance to displays and automatic flight control systems.

**1.2.2.5** Inputs can be accepted from multiple sources such as GPS, DME, VOR, LOC and IRU. These inputs may be applied to a navigation solution one at a time or in combination. Some FMSs provide for the detection and isolation of faulty navigation information.

**1.2.2.6** When appropriate navigation signals are available, FMSs will normally rely on GPS and/or DME/DME (that is, the use of distance information from two or more DME stations) for position updates. Other inputs may also be incorporated based on FMS system architecture and navigation source geometry.

**NOTE-**

*DME/DME inputs coupled with one or more IRU(s) are often abbreviated as DME/DME/IRU or D/D/I.*

**1.2.2.7 RNAV Navigation Specifications (Nav Specs)**

NavSpecs are a set of aircraft and aircrew requirements needed to support a navigation application within a defined airspace concept. For both RNP and RNAV designations, the numerical designation refers to the lateral navigation accuracy in nautical miles which is expected to be achieved at least 95 percent of the flight time by the population of aircraft operating within the airspace, route, or procedure. (See FIG ENR 1.17-1.)

a) **RNAV 1.** Typically RNAV 1 is used for DPs and STARs and appears on the charts. Aircraft must maintain a total system error of not more than 1 NM for 95 percent of the total flight time.

b) **RNAV 2.** Typically RNAV 2 is used for en route operations unless otherwise specified. T-routes and Q-routes are examples of this Nav Spec. Aircraft must maintain a total system error of not more than 2 NM for 95 percent of the total flight time.

c) **RNAV 10.** Typically RNAV 10 is used in oceanic operations. See paragraph ENR 7.4 for specifics and explanation of the relationship between RNP 10 and RNAV 10 terminology.

## **2. Required Navigation Performance (RNP)**

**2.1 General.** While both RNAV navigation specifications (NavSpecs) and RNP NavSpecs contain specific performance requirements, RNP is RNAV with the added requirement for onboard performance monitoring and alerting (OBPMA). RNP is also a statement of navigation performance necessary for operation within a defined airspace. A critical component of RNP is the ability of the aircraft navigation system to monitor its achieved navigation performance, and to identify for the pilot whether the operational requirement is, or is not, being met during an operation. OBPMA capability therefore allows a lessened reliance on air traffic control intervention and/or procedural separation to achieve the overall safety of the operation. RNP capability of the aircraft is a major component in determining the separation criteria to ensure that the overall containment of the operation is met. The RNP capability of an aircraft will vary depending upon the aircraft equipment and the navigation infrastructure. For example, an aircraft may be eligible for RNP 1, but may not be capable of RNP 1 operations due to limited NAVAID coverage or avionics failure. The Aircraft Flight Manual (AFM) or avionics documents for your aircraft should specifically state the aircraft's RNP eligibilities. Contact the manufacturer of the avionics or the aircraft if this information is missing or incomplete. NavSpecs should be considered different from one another, not "better" or "worse" based on the described lateral navigation accuracy. It is this concept that requires each NavSpec eligibility to be listed separately in the avionics documents or AFM. For example, RNP 1 is

different from RNAV 1, and an RNP 1 eligibility does NOT mean automatic RNP 2 or RNAV 1 eligibility. As a safeguard, the FAA requires that aircraft navigation databases hold only those procedures that the aircraft maintains eligibility for. If you look for a specific instrument procedure in your aircraft's navigation database and cannot find it, it's likely that procedure contains PBN elements your aircraft is ineligible for or cannot compute and fly. Further, optional capabilities such as Radius-to-fix (RF) turns or scalability should be described in the AFM or avionics documents. Use the capabilities of your avionics suite to verify the appropriate waypoint and track data after loading the procedure from your database.

## 2.2 PBN Operations

**2.2.1 Lateral Accuracy Values.** Lateral Accuracy values are applicable to a selected airspace, route, or procedure. The lateral accuracy value is a value typically expressed as a distance in nautical miles from the intended centerline of a procedure, route, or path. RNP applications also account for potential errors at some multiple of lateral accuracy value (for example, twice the RNP lateral accuracy values).

**2.2.1.1 RNP NavSpecs.** U.S. standard NavSpecs supporting typical RNP airspace uses are as specified below. Other NavSpecs may include different lateral accuracy values as identified by ICAO or other states. (See FIG ENR 1.17-1.)

**a) RNP Approach (RNP APCH).** In the U.S., RNP APCH procedures are titled RNAV (GPS) and offer several lines of minima to accommodate varying levels of aircraft equipment: either lateral navigation (LNAV), LNAV/vertical navigation (LNAV/VNAV), Localizer Performance with Vertical Guidance (LPV), and Localizer Performance (LP). GPS with or without Space-Based Augmentation System (SBAS) (for example, WAAS) can provide the lateral information to support LNAV minima. LNAV/VNAV incorporates LNAV lateral with vertical path guidance for systems and operators capable of either barometric or SBAS vertical. Pilots are required to use SBAS to fly to the LPV or LP minima. RF turn capability is optional in RNP APCH eligibility. This means that your aircraft may be eligible for RNP APCH operations, but you may not fly an RF turn unless RF turns are also specifically listed as a feature of your avionics suite. GBAS Landing System (GLS) procedures are also constructed using RNP APCH NavSpecs and provide precision approach capability. RNP APCH has a lateral accuracy value of 1 in the terminal and missed approach segments and essentially scales to RNP 0.3 (or 40 meters with SBAS) in the final approach. (See AIP ENR 1.5 Paragraph 9. RNP AR Instrument Approach Procedures.)

**b) RNP Authorization Required Approach (RNP AR APCH).** In the U.S., RNP AR APCH procedures are titled RNAV (RNP). These approaches have stringent equipment and pilot training standards and require special FAA authorization to fly. Scalability and RF turn capabilities are mandatory in RNP AR APCH eligibility. RNP AR APCH vertical navigation performance is based upon barometric VNAV or SBAS. RNP AR is intended to provide specific benefits at specific locations. It is not intended for every operator or aircraft. RNP AR capability requires specific aircraft performance, design, operational processes, training, and specific procedure design criteria to achieve the required target level of safety. RNP AR APCH has lateral accuracy values that can range below 1 in the terminal and missed approach segments and essentially scale to RNP 0.3 or lower in the final approach. Before conducting these procedures, operators should refer to the latest AC 90-101, Approval Guidance for RNP Procedures with AR. (See AIP ENR 1.5 Paragraph 9.)

**c) RNP Authorization Required Departure (RNP AR DP).** Similar to RNP AR approaches, RNP AR departure procedures have stringent equipment and pilot training standards and require special FAA authorization to fly. Scalability and RF turn capabilities is mandatory in RNP AR DP eligibility. RNP AR DP is intended to provide specific benefits at specific locations. It is not intended for every operator or aircraft. RNP AR DP capability requires specific aircraft performance, design, operational processes, training, and specific procedure design criteria to achieve the required target level of safety. RNP AR DP has lateral accuracy values that can scale to no lower than RNP 0.3 in the initial departure flight path. Before conducting these procedures, operators should refer to the latest AC 90-101, Approval Guidance for RNP Procedures with AR. (See AIP ENR 1.5 Paragraph 9.)

**d) Advanced RNP (A-RNP).** Advanced RNP is a NavSpec with a minimum set of mandatory functions enabled in the aircraft's avionics suite. In the U.S., these minimum functions include capability to calculate and



perform RF turns, scalable RNP, and parallel offset flight path generation. Higher continuity (such as dual systems) may be required for certain oceanic and remote continental airspace. Other “advanced” options for use in the en route environment (such as fixed radius transitions and Time of Arrival Control) are optional in the U.S. Typically, an aircraft eligible for A-RNP will also be eligible for operations comprising: RNP APCH, RNP/RNAV 1, RNP/RNAV 2, RNP 4, and RNP/RNAV 10. A-RNP allows for scalable RNP lateral navigation values (either 1.0 or 0.3) in the terminal environment. Use of these reduced lateral accuracies will normally require use of the aircraft’s autopilot and/or flight director. See the latest AC 90-105 for more information on A-RNP, including NavSpec bundling options, eligibility determinations, and operations approvals.

**NOTE-**

*A-RNP eligible aircraft are NOT automatically eligible for RNP AR APCH or RNP AR DP operations, as RNP AR eligibility requires a separate determination process and special FAA authorization.*

**e) RNP 1.** RNP 1 requires a lateral accuracy value of 1 for arrival and departure in the terminal area, and the initial and intermediate approach phase when used on conventional procedures with PBN segments (for example, an ILS with a PBN feeder, IAF, or missed approach). RF turn capability is optional in RNP 1 eligibility. This means that your aircraft may be eligible for RNP 1 operations, but you may not fly an RF turn unless RF turns are also specifically listed as a feature of your avionics suite.

**f) RNP 2.** RNP 2 will apply to both domestic and oceanic/remote operations with a lateral accuracy value of 2.

**g) RNP 4.** RNP 4 will apply to oceanic and remote operations only with a lateral accuracy value of 4. RNP 4 eligibility will automatically confer RNP 10 eligibility.

**h) RNP 10.** The RNP 10 NavSpec applies to certain oceanic and remote operations with a lateral accuracy of 10. In such airspace, the RNAV 10 NavSpec will be applied, so any aircraft eligible for RNP 10 will be deemed eligible for RNAV 10 operations. Further, any aircraft eligible for RNP 4 operations is automatically qualified for RNP 10/ RNAV 10 operations. (See also the latest AC 91-70, Oceanic and Remote Continental Airspace Operations, for more information on oceanic RNP/RNAV operations.)

**i) RNP 0.3.** The RNP 0.3 NavSpec requires a lateral accuracy value of 0.3 for all authorized phases of flight. RNP 0.3 is not authorized for oceanic, remote, or the final approach segment. Use of RNP 0.3 by slow-flying fixed-wing aircraft is under consideration, but the RNP 0.3 NavSpec initially will apply only to rotorcraft operations. RF turn capability is optional in RNP 0.3 eligibility. This means that your aircraft may be eligible for RNP 0.3 operations, but you may not fly an RF turn unless RF turns are also specifically listed as a feature of your avionics suite.

**NOTE-**

*On terminal procedures or en route charts, do not confuse a charted RNP value of 0.30, or any standard final approach course segment width of 0.30, with the NavSpec title “RNP 0.3.” Charted RNP values of 0.30 or below should contain two decimal places (for example, RNP 0.15, or 0.10, or 0.30) whereas the NavSpec title will only state “RNP 0.3.”*

**2.2.1.2 Application of Standard Lateral Accuracy Values.** U.S. standard lateral accuracy values typically used for various routes and procedures supporting RNAV operations may be based on use of a specific navigational system or sensor such as GPS, or on multi-sensor RNAV systems having suitable performance.

**2.2.1.3 Depiction of PBN Requirements.** In the U.S., PBN requirements like Lateral Accuracy Values or NavSpecs applicable to a procedure will be depicted on affected charts and procedures. In the U.S., a specific procedure’s Performance-Based Navigation (PBN) requirements will be prominently displayed in separate, standardized notes boxes. For procedures with PBN elements, the “PBN box” will contain the procedure’s NavSpec(s); and, if required: specific sensors or infrastructure needed for the navigation solution, any additional or advanced functional requirements, the minimum RNP value, and any amplifying remarks. Items listed in this PBN box are REQUIRED to fly the procedure’s PBN elements. For example, an ILS with an RNAV missed approach would require a specific capability to fly the missed approach portion of the procedure. That required capability will be listed in the PBN box. The separate Equipment Requirements box will list ground-based equipment and/or airport specific requirements. On procedures with both PBN elements and ground-based equipment requirements, the PBN requirements box will be listed first. (See FIG ENR 1.5-17.)

**2.3 Other RNP Applications Outside the U.S.** The FAA and ICAO member states have led initiatives in implementing the RNP concept to oceanic operations. For example, RNP-10 routes have been established in the northern Pacific (NOPAC) which has increased capacity and efficiency by reducing the distance between tracks to 50 NM. (See AIP Section ENR 7.4.)

**2.4 Aircraft and Airborne Equipment Eligibility for RNP Operations.** Aircraft eligible for RNP operations will have an appropriate entry including special conditions and limitations in its AFM, avionics manual, or a supplement. Operators of aircraft not having specific RNP eligibility statements in the AFM or avionics documents may be issued operational approval including special conditions and limitations for specific RNP eligibilities.

**NOTE-**

Some airborne systems use Estimated Position Uncertainty (EPU) as a measure of the current estimated navigational performance. EPU may also be referred to as Actual Navigation Performance (ANP) or Estimated Position Error (EPE).

*TBL ENR 1.17-1*  
**U.S. Standard RNP Levels**

RNP Level	Typical Application	Primary Route Width (NM) – Centerline to Boundary
0.1 to 1.0	RNP AR Approach Segments	0.1 to 1.0
0.3 to 1.0	RNP Approach Segments	0.3 to 1.0
1	Terminal and En Route	1.0
2	En Route	2.0
4	Oceanic/remote areas where performance-based horizontal separation is applied.	4.0
10	Oceanic/remote areas where performance-based horizontal separation is applied.	10.0

**3. Use of Suitable Area Navigation (RNAV) Systems on Conventional Procedures and Routes**

**3.1 Discussion.** This paragraph sets forth policy, while providing operational and airworthiness guidance regarding the suitability and use of RNAV systems when operating on, or transitioning to, conventional, non-RNAV routes and procedures within the U.S. National Airspace System (NAS):

**3.1.1** Use of a suitable RNAV system as a Substitute Means of Navigation when a Very-High Frequency (VHF) Omni-directional Range (VOR), Distance Measuring Equipment (DME), Tactical Air Navigation (TACAN), VOR/TACAN (VORTAC), VOR/DME, Non-directional Beacon (NDB), or compass locator facility including locator outer marker and locator middle marker is out-of-service (that is, the navigation aid (NAVAID) information is not available); an aircraft is not equipped with an Automatic Direction Finder (ADF) or DME; or the installed ADF or DME on an aircraft is not operational. For example, if equipped with a suitable RNAV system, a pilot may hold over an out-of-service NDB.

**3.1.2** Use of a suitable RNAV system as an Alternate Means of Navigation when a VOR, DME, VORTAC, VOR/DME, TACAN, NDB, or compass locator facility including locator outer marker and locator middle marker is operational and the respective aircraft is equipped with operational navigation equipment that is compatible with conventional nav aids. For example, if equipped with a suitable RNAV system, a pilot may fly a procedure or route based on operational VOR using that RNAV system without monitoring the VOR.

**NOTE-**

**1.** Additional information and associated requirements are available in Advisory Circular 90-108 titled “Use of Suitable RNAV Systems on Conventional Routes and Procedures.”

2. *Good planning and knowledge of your RNAV system are critical for safe and successful operations.*
3. *Pilots planning to use their RNAV system as a substitute means of navigation guidance in lieu of an out-of-service NAVAID may need to advise ATC of this intent and capability.*
4. *The navigation database should be current for the duration of the flight. If the AIRAC cycle will change during flight, operators and pilots should establish procedures to ensure the accuracy of navigation data, including suitability of navigation facilities used to define the routes and procedures for flight. To facilitate validating database currency, the FAA has developed procedures for publishing the amendment date that instrument approach procedures were last revised. The amendment date follows the amendment number; for example, Amdt 4 14Jan10. Currency of graphic departure procedures and STARs may be ascertained by the numerical designation in the procedure title. If an amended chart is published for the procedure, or the procedure amendment date shown on the chart is on or after the expiration date of the database, the operator must not use the database to conduct the operation.*

**3.2 Types of RNAV Systems that Qualify as a Suitable RNAV System.** When installed in accordance with appropriate airworthiness installation requirements and operated in accordance with applicable operational guidance (e.g., aircraft flight manual and Advisory Circular material), the following systems qualify as a suitable RNAV system:

**3.2.1** An RNAV system with TSO-C129/ -C145/-C146 equipment, installed in accordance with AC 20-138, Airworthiness Approval of Global Positioning System (GPS) Navigation Equipment for Use as a VFR and IFR Supplemental Navigation System, and authorized for instrument flight rules (IFR) en route and terminal operations (including those systems previously qualified for “GPS in lieu of ADF or DME” operations), or

**3.2.2** An RNAV system with DME/DME/IRU inputs that is compliant with the equipment provisions of AC 90-100A, U.S. Terminal and En Route Area Navigation (RNAV) Operations, for RNAV routes. A table of compliant equipment is available at the following website:

[https://www.faa.gov/about/office\\_org/headquarters\\_offices/avs/offices/afx/afs/afs400/afs410/media/AC90-100compliance.pdf](https://www.faa.gov/about/office_org/headquarters_offices/avs/offices/afx/afs/afs400/afs410/media/AC90-100compliance.pdf)

**NOTE-**

*Approved RNAV systems using DME/DME/IRU, without GPS/WAAS position input, may only be used as a substitute means of navigation when specifically authorized by a Notice to Air Missions (NOTAM) or other FAA guidance for a specific procedure. The NOTAM or other FAA guidance authorizing the use of DME/DME/IRU systems will also identify any required DME facilities based on an FAA assessment of the DME navigation infrastructure.*

**3.3 Uses of Suitable RNAV Systems.** Subject to the operating requirements, operators may use a suitable RNAV system in the following ways:

**3.3.1** Determine aircraft position relative to, or distance from a VOR (see NOTE 6 below), TACAN, NDB, compass locator, DME fix; or a named fix defined by a VOR radial, TACAN course, NDB bearing, or compass locator bearing intersecting a VOR or localizer course.

**3.3.2** Navigate to or from a VOR, TACAN, NDB, or compass locator.

**3.3.3** Hold over a VOR, TACAN, NDB, compass locator, or DME fix.

**3.3.4** Fly an arc based upon DME.

**NOTE-**

**1.** *The allowances described in this section apply even when a facility is identified as required on a procedure (for example, “Note ADF required”).*

**2.** *These operations do not include lateral navigation on localizer-based courses (including localizer back-course guidance) without reference to raw localizer data.*

**3.** *Unless otherwise specified, a suitable RNAV system cannot be used for navigation on procedures that are identified as not authorized (“NA”) without exception by a NOTAM. For example, an operator may not use a RNAV system to navigate on a procedure affected by an expired or unsatisfactory flight inspection, or a procedure that is based upon a recently decommissioned NAVAID.*

**4.** *Pilots may not substitute for the NAVAID (for example, a VOR or NDB) providing lateral guidance for the final approach segment. This restriction does not refer to instrument approach procedures with “or GPS” in the title when using GPS or*

WAAS. These allowances do not apply to procedures that are identified as not authorized (NA) without exception by a NOTAM, as other conditions may still exist and result in a procedure not being available. For example, these allowances do not apply to a procedure associated with an expired or unsatisfactory flight inspection, or is based upon a recently decommissioned NAVAID.

5. Use of a suitable RNAV system as a means to navigate on the final approach segment of an instrument approach procedure based on a VOR, TACAN or NDB signal, is allowable. The underlying NAVAID must be operational and the NAVAID monitored for final segment course alignment.

6. For the purpose of paragraph 3.3.1, “VOR” includes VOR, VOR/DME, and VORTAC facilities and “compass locator” includes locator outer marker and locator middle marker.

**3.4 Alternate Airport Considerations.** For the purposes of flight planning, any required alternate airport must have an available instrument approach procedure that does not require the use of GPS. This restriction includes conducting a conventional approach at the alternate airport using a substitute means of navigation that is based upon the use of GPS. For example, these restrictions would apply when planning to use GPS equipment as a substitute means of navigation for an out-of-service VOR that supports an ILS missed approach procedure at an alternate airport. In this case, some other approach not reliant upon the use of GPS must be available. This restriction does not apply to RNAV systems using TSO-C145/-C146 WAAS equipment. For further WAAS guidance see ENR 4.1 paragraph 17.

**3.4.1** For flight planning purposes, TSO-C129() and TSO-C196() equipped users (GPS users) whose navigation systems have fault detection and exclusion (FDE) capability, who perform a preflight RAIM prediction at the airport where the RNAV (GPS) approach will be flown, and have proper knowledge and any required training and/or approval to conduct a GPS-based IAP, may file based on a GPS-based IAP at either the destination or the alternate airport, but not at both locations. At the alternate airport, pilots may plan for applicable alternate airport weather minimums using:

**3.4.1.1** Lateral navigation (LNAV) or circling minimum descent altitude (MDA);

**3.4.1.2** LNAV/vertical navigation (LNAV/VNAV) DA, if equipped with and using approved barometric vertical navigation (baro-VNAV) equipment;

**3.4.1.3** RNP 0.3 DA on an RNAV (RNP) IAP, if they are specifically authorized users using approved baro-VNAV equipment and the pilot has verified required navigation performance (RNP) availability through an approved prediction program.

**3.4.2** If the above conditions cannot be met, any required alternate airport must have an approved instrument approach procedure other than GPS that is anticipated to be operational and available at the estimated time of arrival, and which the aircraft is equipped to fly.

**3.4.3** This restriction does not apply to TSO-C145() and TSO-C146() equipped users (WAAS users). For further WAAS guidance see ENR 4.1 paragraph 17.

### **3.5 General Operational Requirements**

**3.5.1** Pilots must comply with the guidelines contained in their AFM, AFM supplement, operating manual, or pilot’s guide when operating their aircraft navigation system.

**3.5.2** Pilots may not use their RNAV system as a substitute or alternate means of navigation guidance if their aircraft has an AFM or AFM supplement with a limitation to monitor the underlying navigation aids for the associated operation.

**3.5.3** Pilots of aircraft with an AFM limitation that requires the aircraft to have other equipment appropriate to the route to be flown may only use their RNAV equipment as a substitute means of navigation in the contiguous U.S. In addition, pilots of these aircraft may not use their RNAV equipment as a substitute for inoperable or not-installed equipment.

**3.5.4** Pilots must ensure their onboard navigation data is current, appropriate for the region of intended operation, and includes the navigation aids, waypoints, and relevant coded terminal airspace procedures for the departure, arrival, and alternate airfields.

**NOTE-**

*The navigation database should be current for the duration of the flight. If the AIRAC cycle will change during flight, operators and pilots should establish procedures to ensure the accuracy of navigation data, including suitability of navigation facilities used to define the routes and procedures for flight. To facilitate validating database currency, the FAA has developed procedures for publishing the amendment date that instrument approach procedures were last revised. The amendment date follows the amendment number; for example, Amdt 4 14Jan10. Currency of graphic departure procedures and STARs may be ascertained by the numerical designation in the procedure title. If an amended chart is published for the procedure, or the procedure amendment date shown on the chart is on or after the expiration date of the database, the operator must not use the database to conduct the operation.*

**3.5.5** Pilots must extract procedures, waypoints, navaids, or fixes by name from the onboard navigation database and comply with the charted procedure or route.

**3.5.6** For the purposes described in this paragraph, pilots may not manually enter published procedure or route waypoints via latitude/longitude, place/bearing, or place/bearing/distance into the aircraft system.

**3.6 Operational Requirements for Departure and Arrival Procedures**

**3.6.1** Pilots of aircraft with standalone GPS receivers must ensure that CDI scaling (full-scale deflection) is either 1.0 NM or 0.3 NM.

**3.6.2** In order to use a substitute means of navigation guidance on departure procedures, pilots of aircraft with RNAV systems using DME/DME/IRU, without GPS input, must ensure their aircraft navigation system position is confirmed, within 1,000 feet, at the start point of take-off roll. The use of an automatic or manual runway update is an acceptable means of compliance with this requirement. A navigation map may also be used to confirm aircraft position, if pilot procedures and display resolution allow for compliance with the 1,000-foot tolerance requirement.

**3.7 Operational Requirements for Instrument Approach Procedures**

**3.7.1** When the use of RNAV equipment using GPS input is planned as a substitute means of navigation guidance for part of an instrument approach procedure at a destination airport, any required alternate airport must have an available instrument approach procedure that does not require the use of GPS. This restriction includes conducting a conventional approach at the alternate airport using a substitute means of navigation guidance based upon the use of GPS. This restriction does not apply to RNAV systems using WAAS as an input.

**3.7.2** Pilots of aircraft with standalone GPS receivers must ensure that CDI sensitivity is 1 NM.

**NOTE-**

*If using GPS distance as an alternate or substitute means of navigation guidance for DME distance on an instrument approach procedure, pilots must select a named waypoint from the onboard navigation database that is associated with the subject DME facility. Pilots should not rely on information from an RNAV instrument approach procedure, as distances on RNAV approaches may not match the distance to the facility.*

**3.8 Operational Requirements for Specific Inputs to RNAV Systems:**

**3.8.1 GPS**

**3.8.1.1** RNAV systems using GPS input may be used as an alternate means of navigation guidance without restriction if appropriate RAIM is available.

**3.8.1.2** Operators of aircraft with RNAV systems that use GPS input but do not automatically alert the pilot of a loss of GPS, must develop procedures to verify correct GPS operation.

**3.8.1.3** RNAV systems using GPS input may be used as a substitute means of navigation guidance provided RAIM availability for the operation is confirmed. During flight planning, the operator should confirm the availability of RAIM with the latest GPS NOTAMS. If no GPS satellites are scheduled to be out-of-service, then the aircraft can depart without further action. However, if any GPS satellites are scheduled to be out-of-service, then the operator must confirm the availability of GPS integrity (RAIM) for the intended operation. In the event of a predicted, continuous loss of RAIM of more than five (5) minutes for any part of the route or procedure, the operator should delay, cancel, or re-route the flight as appropriate. Use of GPS as a substitute is not authorized when the RAIM capability of the GPS equipment is lost.

**NOTE–**

*The FAA is developing a RAIM prediction service for general use. Until this capability is operational, a RAIM prediction does not need to be done for a departure or arrival procedure with an associated “RADAR REQUIRED” note charted or for routes where the operator expects to be in radar coverage. Operators may check RAIM availability for departure or arrival procedures at any given airport by checking approach RAIM for that location. This information is available upon request from a U.S. Flight Service Station, but is no longer available through DUATS.*

**3.8.2 WAAS**

**3.8.2.1** RNAV systems using WAAS input may be used as an alternate means of navigation guidance without restriction.

**3.8.2.2** RNAV systems using WAAS input may be used as a substitute means of navigation guidance provided WAAS availability for the operation is confirmed. Operators must check WAAS NOTAMS.

**3.8.3 DME/DME/IRU**

**3.8.3.1** RNAV systems using DME/DME/IRU, without GPS input, may be used as an alternate means of navigation guidance whenever valid DME/DME position updating is available.

**4. Recognizing, Mitigating and Adapting to GPS Interference (Jamming and Spoofing)**

**4.1** The low–strength data transmission signals from GPS satellites are vulnerable to various anomalies that can significantly reduce the reliability of the navigation signal. Because of the many uses of GPS in aviation (e.g., navigation, ADS–B, terrain awareness/warning systems), operators of aircraft using GPS need to be aware of these vulnerabilities, and be able to recognize and adjust to degraded signals. Aircraft should have additional navigation equipment for their intended route.

**4.2** GPS signals are vulnerable to intentional and unintentional inference from a wide variety of sources, including radars, microwave links, ionosphere effects, solar activity, multi–path error, satellite communications, GPS repeaters, and even some systems onboard the aircraft. In general, these types of unintentional interference are localized and intermittent. Of greater and growing concern is the intentional and unauthorized interference of GPS signals by persons using “jammers” or “spoofers” to disrupt air navigation by interfering with the reception of valid satellite signals.

**NOTE–**

*The U.S. government regularly conducts GPS tests, training activities, and exercises that interfere with GPS signals. These events are geographically limited, coordinated, scheduled, and advertised via GPS and/or WAAS NOTAMS. Operators of GPS aircraft should always check for GPS and/or WAAS NOTAMS for their route of flight.*

**4.3** GPS is a critical component of essential communication, navigation, and surveillance (CNS) in the NAS; and flight safety/control systems. Additionally, some satellite communications avionics use GPS signals for operations in oceanic and remote airspaces. It is the sole aircraft position–reporting source for Automatic Dependent Surveillance – Broadcast (ADS–B). Some business aircraft are using GPS as a reference source for aircraft flight control and stability systems. GPS is also a necessary component of the Aircraft Terrain Awareness and Warning System (TAWS) – an aircraft safety system that alerts pilots of upcoming terrain. There are examples of false “terrain–pull up” warnings during GPS anomalies.

**4.4** When flying IFR, pilots should have additional navigation equipment for their intended route to crosscheck their position. Routine checks of position against VOR or DME information, for example, could help detect a compromised GPS signal. Pilots transitioning to VOR navigation in response to GPS anomalies should refer to the Chart Supplement U.S. to identify airports with available conventional approaches associated with the VOR Minimum Operational Network (MON) program. (Reference Aeronautical Information Manual (AIM) 1–1–3(f)).

**4.5** When flying GPS approaches, particularly in IMC, pilots should have a backup plan in the event of GPS anomalies. Although the appropriate response will vary with the situation, in general pilots should:

**4.5.1** Maintain control of the aircraft.

**4.5.2** Use the last reliable navigation information as the basis for initial heading, and climb above terrain.

**4.5.3** Change to an another source of navigation, if available (i.e., VOR, DME, radar vectors), and

**4.5.4** Contact ATC as soon as practical.

**4.6** Pilots should promptly notify ATC if they experience GPS anomalies. Pilots should not normally inform ATC of GPS interference or outages when flying through a known NOTAMed testing area, unless they require ATC assistance. (See Aeronautical Information Manual (AIM) 1-1-13)





## **ENR 2. Air Traffic Services Airspace**

See GEN 3.3 and ENR 1.4.



## ENR 3. ATS ROUTES

### ENR 3.1 Lower ATS Routes

See also ENR 1.10, ENR 1.17, ENR 3.3, ENR 3.5, and Appendix 1.

#### 1. Low Altitude ATS Route Structure

**1.1** The U.S. does not use the term “Lower ATS Routes.” The published low altitude route structure in the U.S. consists of VOR Federal airways, L/MF Federal airways and low altitude RNAV routes (T-routes). The low altitude route structure is for use from 1,200 feet above the surface (or in some instances higher) up to but not including 18,000 feet MSL.

**1.1.1** Route designators and significant points defining the routes are listed in FAA Order JO 7400.11, Airspace Designations and Reporting Points.

**1.1.2** Applicable route tracks, radials, distances between points, changeover points, cruising altitudes for direction of flight, upper and lower limits, minimum flight altitudes and ARTCC boundaries are published on the IFR Enroute Low Altitude – U.S. chart series.

**1.1.3** The low altitude routes are designated as Class E airspace.



## ENR 3.2 Upper ATS Routes

See also ENR 1.10, ENR 1.17, ENR 3.3, ENR 3.5, and Appendix 1.

### 1. High Altitude ATS Route Structure

**1.1** The U.S. does not use the term “Upper ATS Routes.” The published high altitude route structure in the U.S. consists of jet routes and high altitude RNAV routes (Q-routes). The high altitude route structure is for use at and above 18,000 feet MSL.

**1.1.1** Jet route and Q-route designators and significant points defining the routes are listed in FAA Order JO 7400.11, Airspace Designations and Reporting Points.

**1.1.2** Applicable route tracks, radials, distances between points, changeover points, cruising altitudes for direction of flight, upper and lower limits, minimum flight altitudes and ARTCC boundaries are published on the IFR En Route High Altitude – U.S. chart series.

**1.1.3** The high altitude route structure is contained within Class A airspace.



## ENR 3.3 Area Navigation (RNAV) Routes

### 1. Area Navigation (RNAV) Routes

**1.1** Published RNAV routes, including Q-routes, T-routes, and Y-routes, can be flight planned for use by aircraft with RNAV capability, subject to any limitations or requirements noted on en route charts, in applicable Advisory Circulars, NOTAMs, etc. RNAV routes are normally depicted in blue on aeronautical charts and are identified by the letter “Q,” “T,” or “Y” followed by the airway number (for example, Q13, T205, and Y280). Published RNAV routes are RNAV 2 except when specifically charted as RNAV 1. Unless otherwise specified, these routes require system performance currently met by GPS, GPS/WAAS, or DME/DME/IRU RNAV systems that satisfy the criteria discussed in AC 90-100A, U.S. Terminal and En Route Area Navigation (RNAV) Operations.

**1.1.1** Q-routes are available for use by RNAV equipped aircraft between 18,000 feet MSL and FL 450 inclusive. Q-routes are depicted on En Route High Altitude Charts.

**NOTE-**

*Aircraft in Alaska may only operate on GNSS Q-routes with GPS (TSO-C129 (as revised) or TSO-C196 (as revised)) equipment while the aircraft remains in Air Traffic Control (ATC) radar surveillance or with GPS/WAAS which does not require ATC radar surveillance.*

**1.1.2** T-routes are available for use by GPS or GPS/WAAS equipped aircraft from 1,200 feet above the surface (or in some instances higher) up to but not including 18,000 feet MSL. T-routes are depicted on En Route Low Altitude Charts.

**NOTE-**

*Aircraft in Alaska may only operate on GNSS T-routes with GPS/WAAS (TSO-C145 (as revised) or TSO-C146 (as revised)) equipment.*

**1.2** Unpublished RNAV routes are direct routes, based on area navigation capability, between waypoints defined in terms of latitude/longitude coordinates, degree-distance fixes, or offsets from established routes/airways at a specified distance and direction. Radar monitoring by ATC is required on all unpublished RNAV routes, except for GNSS-equipped aircraft cleared via filed published waypoints recallable from the aircraft’s navigation database.

**1.3** Y-routes generally run in U.S. offshore airspace, however operators can find some Y-routes over southern Florida. Pilots must use GPS for navigation and meet RNAV 2 performance requirements for all flights on Y-routes. Operators can find additional Y-route requirements in ENR 7.10.





## ENR 3.4 [RESERVED]



## ENR 3.5 Other Routes

### 1. Airways and Route Systems

**1.1** Three fixed route systems are established for air navigation purposes. They are the Federal airway system (consisting of VOR and L/MF routes), the jet route system, and the RNAV route system. To the extent possible, these route systems are aligned in an overlying manner to facilitate transition between each.

### 2. VOR and L/MF System

**2.1** The VOR and L/MF (nondirectional radio beacons) Airway System consists of airways designated from 1,200 feet above the surface (or in some instances higher) up to but not including 18,000 feet MSL. These airways are depicted on IFR Enroute Low Altitude Charts.

**NOTE-**

*The altitude limits of a victor airway should not be exceeded except to effect transition within or between route structures.*

**2.2** Except in Alaska, the VOR airways are: predicated solely on VOR or VORTAC navigation aids; depicted in black on aeronautical charts; and identified by a “V” (Victor) followed by the airway number (for example, V12).

**NOTE-**

*Segments of VOR airways in Alaska are based on L/MF navigation aids and charted in brown instead of black on en route charts.*

**2.3** A segment of an airway which is common to two or more routes carries the numbers of all the airways which coincide for that segment. When such is the case, pilots filing a flight plan need to indicate only that airway number for the route filed.

**NOTE-**

*A pilot who intends to make an airway flight, using VOR facilities, will simply specify the appropriate “victor” airway(s) in the flight plan. For example, if a flight is to be made from Chicago to New Orleans at 8,000 feet, using omniranges only, the route may be indicated as “departing from Chicago–Midway, cruising 8,000 feet via Victor 9 to Moisant International.” If flight is to be conducted in part by means of L/MF navigation aids and in part on omniranges, specifications of the appropriate airways in the flight plan will indicate which types of facilities will be used along the described routes, and, for IFR flight, permit ATC to issue a traffic clearance accordingly. A route may also be described by specifying the station over which the flight will pass but in this case since many VORs and L/MF aids have the same name, the pilot must be careful to indicate which aid will be used at a particular location. This will be indicated in the route of flight portion of the flight plan by specifying the type of facility to be used after the location name in the following manner: Newark L/MF, Allentown VOR.*

**2.4** With respect to position reporting, reporting points are designed for VOR Airway Systems. Flights using Victor airways will report over these points unless advised otherwise by ATC.

**2.5** The L/MF airways (colored airways) are predicated solely on L/MF navigation aids and are depicted in brown on aeronautical charts and are identified by color name and number; e.g., Amber One. Green and Red airways are plotted east and west. Amber and Blue airways are plotted north and south.

**CAUTION-**

*Use of adjacently located LF/VHF airways and routes – many locations just outside the contiguous 48 states have two separate airway structures. One structure is made up from VORs and the other from L/MF NAVAIDs (nondirectional radio beacons). In some instances, the different routes appear to overlie each other. The NAVAIDs are sometimes depicted so close to each other that they will have the appearance of being collocated, or nearly so. Substituting a VOR radial for a nondirectional radio beacon bearing could, in many circumstances, cause an excessive “off course” navigational error. Strict adherence to the color coding of the route structure and NAVAID in use should be maintained. Chart procedures provide an excellent means of route differentiation through the use of color which is defined and explained in the legend.*

**2.6** The use of TSO–C145 (as revised) or TSO–C146 (as revised) GPS/WAAS navigation systems is allowed in Alaska as the only means of navigation on published air traffic service (ATS) routes, including those Victor,

T–Routes, and colored airway segments designated with a second minimum en route altitude (MEA) depicted in blue and followed by the letter G at those lower altitudes. The altitudes so depicted are below the minimum reception altitude (MRA) of the land–based navigation facility defining the route segment, and guarantee standard en route obstacle clearance and two–way communications. Air carrier operators requiring operations specifications are authorized to conduct operations on those routes in accordance with FAA operations specifications.

### **3. Jet Route System**

**3.1** The jet route system consists of jet routes established from 18,000 feet MSL to FL 450 inclusive.

**3.2** These routes are depicted on En Route High Altitude Charts. Jet routes are depicted in black on aeronautical charts and are identified by a “J” (Jet) followed by the airway number; e.g., J12. Jet routes, as VOR airways, are predicated solely on VOR or VORTAC navigation facilities (except in Alaska).

**NOTE–**

*Segments of jet routes in Alaska are based on L/MF navigation aids and are charted in brown color instead of black on en route charts.*

**3.3** With respect to position reporting, reporting points are designated for Jet Route Systems. Flights using jet routes will report over these points unless otherwise advised by ATC.

### **4. Radar Vectors**

**4.1** Controllers may vector aircraft within CONTROLLED AIRSPACE for separation purposes, noise abatement considerations, when an operational advantage will be realized by the pilot or the controller, or when requested by the pilot. Vectors outside of CONTROLLED AIRSPACE will be provided only on pilot request. Pilots will be advised as to what the vector is to achieve when the vector is controller initiated and will take the aircraft off a previously assigned nonradar route. To the extent possible, aircraft operating on RNAV routes will be allowed to remain on their own navigation.

### **5. Changeover Points (COPs)**

**5.1** COPs are prescribed for Federal airways, jet routes, area navigation routes, or other direct routes for which an minimum en route altitude (MEA) is designated under 14 CFR Part 95. The COP is a point along the route or airway segment between two adjacent navigation facilities or waypoints where changeover navigation guidance should occur. At this point, the pilot should change navigation receiver frequency from the station behind the aircraft to the station ahead.

**5.2** The COP is normally located midway between the navigation facilities for straight route segments, or at the intersection of radials or courses forming a dogleg in the case of dogleg route segments. When the COP is NOT located at the midway point, aeronautical charts will depict the COP location and give the mileage to the radio aids.

**5.3** COPs are established for the purpose of preventing loss of navigation guidance, to prevent frequency interference from other facilities, and to prevent use of different facilities by different aircraft in the same airspace. Pilots are urged to observe COPs to the fullest extent.

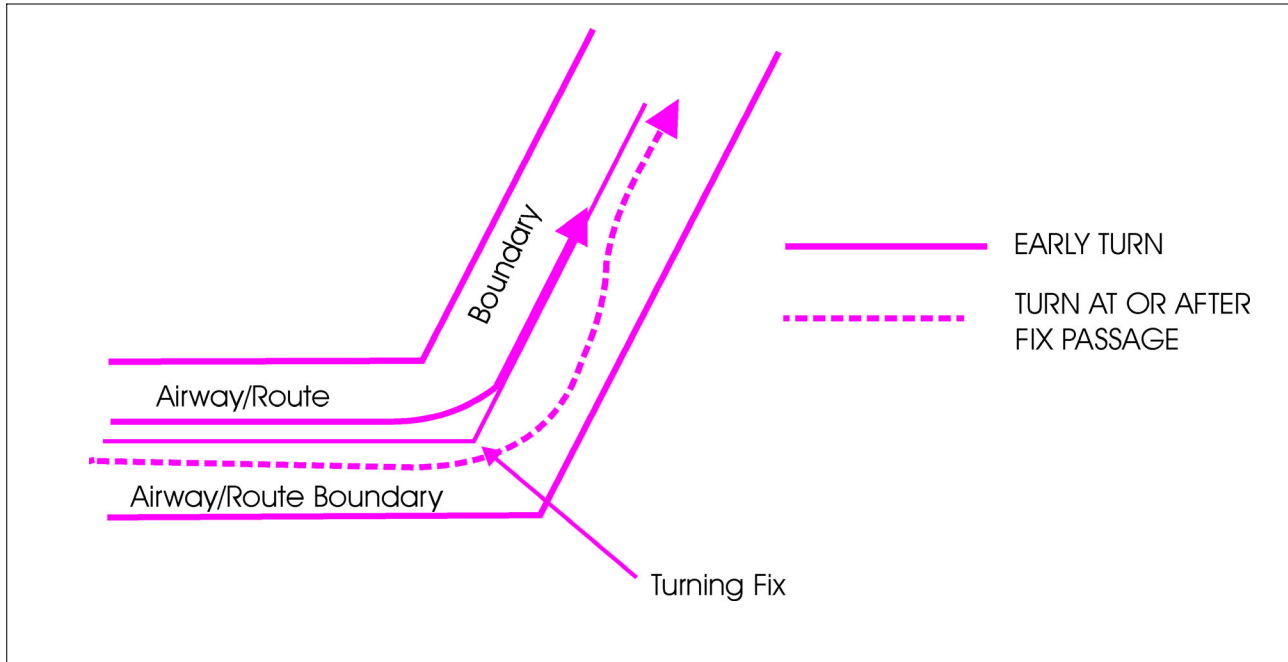
### **6. Airway or Route Course Changes**

**6.1** Pilots of aircraft are required to adhere to airways/routes being flown. Special attention must be given to this requirement during course changes. Each course change consists of variables that make the technique applicable in each case a matter only the pilot can resolve. Some variables which must be considered are turn radius, wind effect, airspeed, degree of turn, and cockpit instrumentation. An early turn, as illustrated in FIG ENR 3.5–1, is one method of adhering to airways/routes. The use of any available cockpit instrumentation, such as distance measuring equipment, may be used by the pilot to lead the turn when making course changes. This is consistent

with the intent of 14 CFR Section 91.181 which requires pilots to operate along the centerline of an airway and along the direct course between navigational aids or fixes.

**6.2** Turns which begin at or after fix passage may exceed airway/route boundaries. FIG ENR 3.5-1 contains an example flight track depicting this, together with an example of an early turn.

FIG ENR 3.5-1  
Adhering to Airways or Routes



**6.3** Without such actions, as leading a turn, aircraft operating in excess of 290 knots true airspeed (TAS) can exceed the normal airway/route boundaries depending on the amount of course change required, wind direction and velocity, the character of the turn fix, (DME, overhead navigation aid, or intersection), and the pilot's technique in making a course change. For example, a flight operating at 17,000 feet MSL with a TAS of 400 knots, a 25 degree bank, and a course change of more than 40 degrees would exceed the width of the airway/route; i.e., 4 nautical miles each side of centerline. However, in the airspace below 18,000 feet MSL, operations in excess of 290 knots TAS are not prevalent and the provision of additional IFR separation in all course change situations for the occasional aircraft making a turn in excess of 290 knots TAS creates an unacceptable waste of airspace and imposes a penalty upon the preponderance of traffic which operates at low speeds. Consequently, the FAA expects pilots to lead turns and take other actions they consider necessary during the course changes to adhere as closely as possible to the airways or route being flown.

## 7. Minimum Turning Altitude (MTA)

**7.1** Due to increased airspeeds at 10,000 ft MSL or above, the published minimum enroute altitude (MEA) may not be sufficient for obstacle clearance when a turn is required over a fix, NAVAID, or waypoint. In these instances, an expanded area in the vicinity of the turn point is examined to determine whether the published MEA is sufficient for obstacle clearance. In some locations (normally mountainous), terrain/obstacles in the expanded search area may necessitate a higher minimum altitude while conducting the turning maneuver. Turning fixes requiring a higher minimum turning altitude (MTA) will be denoted on government charts by the minimum crossing altitude (MCA) icon ("x" flag) and an accompanying note describing the MTA restriction. An MTA restriction will normally consist of the air traffic service (ATS) route leading to the turn point, the ATS route leading from the turn point, and the required altitude; e.g., MTA V330 E TO V520 W 16000. When an MTA is applicable for the intended route of flight, pilots must ensure they are at or above the charted MTA not later than

the turn point and maintain at or above the MTA until joining the centerline of the ATS route following the turn point. Once established on the centerline following the turning fix, the MEA/MOCA determines the minimum altitude available for assignment. An MTA may also preclude the use of a specific altitude or a range of altitudes during a turn. For example, the MTA may restrict the use of 10,000 through 11,000 ft MSL. In this case, any altitude greater than 11,000 ft MSL is unrestricted, as are altitudes less than 10,000 ft MSL provided MEA/MOCA requirements are satisfied.

## ENR 4. NAVIGATION AIDS/SYSTEMS

### ENR 4.1 Navigation Aids – En Route

#### 1. Nondirectional Radio Beacon (NDB)

**1.1** A low or medium frequency radio beacon transmits nondirectional signals whereby the pilot of an aircraft properly equipped can determine bearings and “home” on the station. These facilities normally operate in a frequency band of 190 to 535 kilohertz (kHz), according to ICAO Annex 10 the frequency range for NDBs is between 190 and 1750 kHz, and transmit a continuous carrier with either 400 or 1020 hertz (Hz) modulation. All radio beacons except the compass locators transmit a continuous three-letter identification in code except during voice transmissions.

**1.2** When a radio beacon is used in conjunction with the Instrument Landing System markers, it is called a Compass Locator.

**1.3** Voice transmissions are made on radio beacons unless the letter “W” (without voice) is included in the class designator (HW).

**1.4** Radio beacons are subject to disturbances that may result in erroneous bearing information. Such disturbances result from such factors as lightning, precipitation, static, etc. At night radio beacons are vulnerable to interference from distant stations. Nearly all disturbances which affect the aircraft’s Automatic Direction Finder (ADF) bearing also affect the facility’s identification. Noisy identification usually occurs when the ADF needle is erratic; voice, music, or erroneous identification will usually be heard when a steady false bearing is being displayed. Since ADF receivers do not have a “FLAG” to warn the pilot when erroneous bearing information is being displayed, the pilot should continuously monitor the NDB’s identification.

#### 2. VHF Omni-directional Range (VOR)

**2.1** VORs operate within the 108.0 – 117.95 MHz frequency band and have a power output necessary to provide coverage within their assigned operational service volume. They are subject to line-of-sight restrictions, and range varies proportionally to the altitude of the receiving equipment.

**NOTE–**

*Normal service ranges for the various classes of VORs are given in GEN 3.4, TBL GEN 3.4-1, VOR/DME/TACAN Standard Service Volumes.*

**2.2** Most VORs are equipped for voice transmission on the VOR frequency. VORs without voice capability are indicated by the letter “W” (without voice) included in the class designator (VORW).

**2.3** The effectiveness of the VOR depends upon proper use and adjustment of both ground and airborne equipment.

**2.3.1 Accuracy.** The accuracy of course alignment of the VOR is excellent, being generally plus or minus 1 degree.

**2.3.2 Roughness.** On some VORs, minor course roughness may be observed, evidenced by course needle or brief flag alarm activity (some receivers are more subject to these irregularities than others). At a few stations, usually in mountainous terrain, the pilot may occasionally observe a brief course needle oscillation, similar to the indication of “approaching station.” Pilots flying over unfamiliar routes are cautioned to be on the alert of these vagaries, and, in particular, to use the “to-from” indicator to determine positive station passage.

**2.3.2.1** Certain propeller RPM settings or helicopter rotor speeds can cause the VOR Course Deviation Indicator (CDI) to fluctuate as much as plus or minus six degrees. Slight changes to the RPM setting will normally smooth out this roughness. Pilots are urged to check for this modulation phenomenon prior to reporting a VOR station or aircraft equipment for unsatisfactory operation.

**2.4** The only positive method of identifying a VOR is by its Morse Code identification or by the recorded automatic voice identification which is always indicated by use of the word “VOR” following the range’s name. Reliance on determining the identification of an omnirange should never be placed on listening to voice transmissions by the FSS (or approach control facility) involved. Many FSS remotely operate several omniranges which have different names from each other and, in some cases, none have the name of the “parent” FSS. During periods of maintenance the facility may radiate a T-E-S-T code (— ● ●●● —) or the code may be removed. Some VOR equipment decodes the identifier and displays it to the pilot for verification to charts, while other equipment simply displays the expected identifier from a database to aid in verification to the audio tones. You should be familiar with your equipment and use it appropriately. If your equipment automatically decodes the identifier, it is not necessary to listen to the audio identification.

**2.5** Voice identification has been added to numerous VORs. The transmission consists of a voice announcement; i.e., “AIRVILLE VOR,” alternating with the usual Morse Code identification.

**2.6 The VOR Minimum Operational Network (MON).** As flight procedures and route structure based on VORs are gradually being replaced with Performance-Based Navigation (PBN) procedures, the FAA is removing selected VORs from service. PBN procedures are primarily enabled by GPS and its augmentation systems, collectively referred to as Global Navigation Satellite System (GNSS). Aircraft that carry DME/DME equipment can also use RNAV which provides a backup to continue flying PBN during a GNSS disruption. For those aircraft that do not carry DME/DME, the FAA is retaining a limited network of VORs, called the VOR MON, to provide a basic conventional navigation service for operators to use if GNSS becomes unavailable. During a GNSS disruption, the MON will enable aircraft to navigate through the affected area or to a safe landing at a MON airport without reliance on GNSS. Navigation using the MON will not be as efficient as the new PBN route structure, but use of the MON will provide nearly continuous VOR signal coverage at 5,000 feet AGL across the NAS, outside of the Western U.S. Mountainous Area (WUSMA).

**NOTE—**

*There is no plan to change the NAVAID and route structure in the WUSMA.*

The VOR MON has been retained principally for IFR aircraft that are not equipped with DME/DME avionics. However, VFR aircraft may use the MON as desired. Aircraft equipped with DME/DME navigation systems would, in most cases, use DME/DME to continue flight using RNAV to their destination. However, these aircraft may, of course, use the MON.

**2.6.1 Distance to a MON airport.** The VOR MON will ensure that regardless of an aircraft’s position in the contiguous United States (CONUS), a MON airport (equipped with legacy ILS or VOR approaches) will be within 100 nautical miles. These airports are referred to as “MON airports” and will have an ILS approach or a VOR approach if an ILS is not available. VORs to support these approaches will be retained in the VOR MON. MON airports are charted on low-altitude en route charts and are contained in the Chart Supplement U.S. and other appropriate publications.

**NOTE—**

*Any suitable airport can be used to land in the event of a VOR outage. For example, an airport with a DME-required ILS approach may be available and could be used by aircraft that are equipped with DME. The intent of the MON airport is to provide an approach that can be used by aircraft without ADF or DME when radar may not be available.*

**2.6.2 Navigating to an airport.** The VOR MON will retain sufficient VORs to ensure that pilots will have nearly continuous signal reception of a VOR when flying at 5,000 feet AGL. The service volume of VORs will be increased to provide service at 5,000 feet above the VOR. If the pilot encounters a GPS outage, the pilot will be able to proceed via VOR-to-VOR navigation at 5,000 feet above the VOR, either through the GPS outage area or to a safe landing at a MON airport or another suitable airport, as appropriate. Nearly all VORs inside of the WUSMA and outside the CONUS are being retained. In these areas, pilots use the existing (Victor and Jet) route structure and VORs to proceed through a GPS outage or to a landing.

**2.6.3 Using the VOR MON.**



**2.6.3.1** In the case of a planned GPS outage (for example, one that is in a published NOTAM), pilots may plan to fly through the outage using the MON as appropriate and as cleared by ATC. Similarly, aircraft not equipped with GPS may plan to fly and land using the MON, as appropriate and as cleared by ATC.

**NOTE-**

1. In many cases, flying using the MON may involve a more circuitous route than flying GPS-enabled RNAV.
2. Aircraft not equipped with GPS may be limited to a visual approach at the planned destination.

**2.6.3.2** In the case of an unscheduled GPS outage, pilots and ATC will need to coordinate the best outcome for all aircraft. It is possible that a GPS outage could be disruptive, causing high workload and demand for ATC service. Generally, the VOR MON concept will enable pilots to navigate through the GPS outage or land at a MON airport or at another airport that may have an appropriate approach or may be in visual conditions.

a) The VOR MON is a reversionary service provided by the FAA for use by aircraft that are unable to continue RNAV during a GPS disruption. The FAA has not mandated that preflight or inflight planning include provisions for GPS- or WAAS-equipped aircraft to carry sufficient fuel to proceed to a MON airport in case of an unforeseen GPS outage. Specifically, flying to a MON airport as a filed alternate will not be explicitly required. Of course, consideration for the possibility of a GPS outage is prudent during flight planning as is maintaining proficiency with VOR navigation.

b) Also, in case of a GPS outage, pilots may coordinate with ATC and elect to continue through the outage or land. The VOR MON is designed to ensure that an aircraft is within 100 NM of an airport, but pilots may decide to proceed to any appropriate airport where a landing can be made, as coordinated with ATC. WAAS users flying under Part 91 are not required to carry VOR avionics. These users do not have the ability or requirement to use the VOR MON. Prudent flight planning, by these WAAS-only aircraft, should consider the possibility of a GPS outage.

**NOTE-**

*The FAA recognizes that non-GPS-based approaches will be reduced when VORs are eliminated, and that most airports with an instrument approach may only have GPS- or WAAS-based approaches. Pilots flying GPS- or WAAS-equipped aircraft that also have VOR/ILS avionics should be diligent to maintain proficiency in VOR and ILS approaches in the event of a GPS outage.*

### **3. VOR Receiver Check**

**3.1** Periodic VOR receiver calibration is most important. If a receiver's Automatic Gain Control or modulation circuit deteriorates, it is possible for it to display acceptable accuracy and sensitivity close into the VOR or VOT and display out-of-tolerance readings when located at greater distances where weaker signal areas exist. The likelihood of this deterioration varies between receivers, and is generally considered a function of time. The best assurance of having an accurate receiver is periodic calibration. Yearly intervals are recommended at which time an authorized repair facility should recalibrate the receiver to the manufacturer's specifications.

**3.2** 14 CFR Section 91.171 provides for certain VOR equipment accuracy checks prior to flight under IFR. To comply with this requirement and to ensure satisfactory operation of the airborne system, the FAA has provided pilots with the following means of checking VOR receiver accuracy:

**3.2.1** FAA VOR test facility (VOT) or a radiated test signal from an appropriately rated radio repair station.

**3.2.2** Certified airborne checkpoints and airways.

**3.2.3** Certified check points on the airport surface.

**3.2.4** If an airborne checkpoint is not available, select an established VOR airway. Select a prominent ground point, preferably more than 20 NM from the VOR ground facility and maneuver the aircraft directly over the point at reasonably low altitude above terrain and obstructions.

**3.3** The FAA VOT transmits a test signal which provides a convenient means to determine the operational status and accuracy of a VOR receiver while on the ground where a VOT is located. The airborne use of VOT is

permitted; however, its use is strictly limited to those areas/altitudes specifically authorized in the Chart Supplement U.S. or appropriate supplement. To use the VOT service, tune in the VOT frequency on your VOR receiver. With the CDI centered, the omni-bearing selector should read 0° with the to/from indicator showing “from,” or the omni-bearing selector should read 180° with the to/from indicator showing “to.” Should the VOR receiver operate a Radio Magnetic Indicator (RMI), it will indicate 180° on any OBS setting. Two means of identification are used. One is a series of dots, and the other is a continuous tone. Information concerning an individual test signal can be obtained from the local FSS.

**3.4** A radiated VOR test signal from an appropriately rated radio repair station serves the same purpose as an FAA VOR signal and the check is made in much the same manner as a VOT with the following differences:

**3.4.1** The frequency normally approved by the FCC is 108.0 MHz.

**3.4.2** Repair stations are not permitted to radiate the VOR test signal continuously, consequently the owner/operator must make arrangements with the repair station to have the test signal transmitted. This service is not provided by all radio repair stations. The aircraft owner or operator must determine which repair station in the local area provides this service. A representative of the repair station must make an entry into the aircraft logbook or other permanent record certifying to the radial accuracy and the date of transmission. The owner/operator or representative of the repair station may accomplish the necessary checks in the aircraft and make a logbook entry stating the results. It is necessary to verify which test radial is being transmitted and whether you should get a “to” or “from” indication.

**3.5** Airborne and ground check points consist of certified radials that should be received at specific points on the airport surface, or over specific landmarks while airborne in the immediate vicinity of the airport.

**3.5.1** Should an error in excess of plus or minus 4 degrees be indicated through use of a ground check, or plus or minus 6 degrees using the airborne check, IFR flight must not be attempted without first correcting the source of the error.

**CAUTION-**

*No correction other than the “correction card” figures supplied by the manufacturer should be applied in making these VOR receiver checks.*

**3.5.2** Locations of airborne check points, ground check points and VOTs are published in the Chart Supplement U.S.

**3.5.3** If a dual system VOR (units independent of each other except for the antenna) is installed in the aircraft, one system may be checked against the other. Turn both systems to the same VOR ground facility and note the indicated bearing to that station. The maximum permissible variations between the two indicated bearings is 4 degrees.

## **4. Distance Measuring Equipment (DME)**

**4.1** In the operation of DME, paired pulses at a specific spacing are sent out from the aircraft (this is the interrogation) and are received at the ground station. The ground station (transponder) then transmits paired pulses back to the aircraft at the same pulse spacing but on a different frequency. The time required for the round trip of this signal exchange is measured in the airborne DME unit and is translated into distance (nautical miles (NM)) from the aircraft to the ground station.

**4.2** Operating on the line-of-sight principle, DME furnishes distance information with a very high degree of accuracy. Reliable signals may be received at distances up to 199 NM at line-of-sight altitude with an accuracy of better than 1/2 mile or 3% of the distance, whichever is greater. Distance information received from DME equipment is SLANT RANGE distance and not actual horizontal distance.

**4.3** Operating frequency range of a DME according to ICAO Annex 10 is from 960 MHz to 1215 MHz. Aircraft equipped with TACAN equipment will receive distance information from a VORTAC automatically, while aircraft equipped with VOR must have a separate DME airborne unit.

**4.4** VOR/DME, VORTAC, ILS/DME, and LOC/DME navigation facilities established by the FAA provide course and distance information from collocated components under a frequency pairing plan. Aircraft receiving equipment which provides for automatic DME selection assures reception of azimuth and distance information from a common source whenever designated VOR/DME, VORTAC, ILS/DME, and LOC/DME are selected.

**4.5** Due to the limited number of available frequencies, assignment of paired frequencies is required for certain military noncollocated VOR and TACAN facilities which serve the same area but which may be separated by distances up to a few miles.

**4.6** VOR/DME, VORTAC, ILS/DME, and LOC/DME facilities are identified by synchronized identifications which are transmitted on a time share basis. The VOR or localizer portion of the facility is identified by a coded tone modulated at 1020 Hz or by a combination of code and voice. The TACAN or DME is identified by a coded tone modulated at 1350 Hz. The DME or TACAN coded identification is transmitted one time for each three or four times that the VOR or localizer coded identification is transmitted. When either the VOR or the DME is inoperative, it is important to recognize which identifier is retained for the operative facility. A signal coded identification with a repetition interval of approximately 30 seconds indicates that the DME is operative.

**4.7** Aircraft equipment which provides for automatic DME selection assures reception of azimuth and distance information from a common source whenever designated VOR/DME, VORTAC, and ILS/DME navigation facilities are selected. Pilots are cautioned to disregard any distance displays from automatically selected DME equipment when VOR or ILS facilities, which do not have the DME feature installed, are being used for position determination.

## **5. Tactical Air Navigation (TACAN)**

**5.1** For reasons peculiar to military or naval operations (unusual siting conditions, the pitching and rolling of a naval vessel, etc.) the civil VOR/DME system of air navigation was considered unsuitable for military or naval use. A new navigational system, Tactical Air Navigation (TACAN), was therefore developed by the military and naval forces to more readily lend itself to military and naval requirements. As a result, the FAA has integrated TACAN facilities with the civil VOR/DME program. Although the theoretical, or technical principles of operation of TACAN equipment are quite different from those of VOR/DME facilities, the end result, as far as the navigating pilot is concerned, is the same. These integrated facilities are called VORTACs.

**5.2** TACAN ground equipment consists of either a fixed or mobile transmitting unit. The airborne unit in conjunction with the ground unit reduces the transmitted signal to a visual presentation of both azimuth and distance information. TACAN is a pulse system and operates in the UHF band of frequencies. Its use requires TACAN airborne equipment and does not operate through conventional VOR equipment.

**5.3** A VORTAC is a facility consisting of two components, VOR and TACAN, which provides three individual services: VOR azimuth, TACAN azimuth, and TACAN distance (DME) at one site. Although consisting of more than one component, incorporating more than one operating frequency, and using more than one antenna system, a VORTAC is considered to be a unified navigational aid. Both components of a VORTAC are envisioned as operating simultaneously and providing the three services at all times.

**5.4** Transmitted signals of VOR and TACAN are each identified by three-letter code transmission and are interlocked so that pilots using VOR azimuth and TACAN distance can be assured that both signals being received are definitely from the same ground station. The frequency channels of the VOR and the TACAN at each VORTAC facility are “paired” in accordance with a national plan to simplify airborne operation.

## **6. Instrument Landing System (ILS)**

### **6.1 General**

**6.1.1** The ILS is designed to provide an approach path for exact alignment and descent of an aircraft on final approach to a runway.

**6.1.2** The basic components of an ILS are the localizer, glide slope, and Outer Marker (OM) and, when installed for use with Category II or Category III instrument approach procedures, an Inner Marker (IM).

**6.1.3** The system may be divided functionally into three parts:

**6.1.3.1 Guidance information:** localizer, glide slope.

**6.1.3.2 Range information:** marker beacon, DME.

**6.1.3.3 Visual information:** approach lights, touchdown and centerline lights, runway lights.

**6.1.4** The following means may be used to substitute for the OM:

**6.1.4.1** Compass locator; or

**6.1.4.2** Precision Approach Radar (PAR); or

**6.1.4.3** Airport Surveillance Radar (ASR); or

**6.1.4.4** Distance Measuring Equipment (DME), Very High Frequency Omni-directional Range (VOR), or Nondirectional beacon fixes authorized in the Standard Instrument Approach Procedure; or

**6.1.4.5** A suitable RNAV system with Global Positioning System (GPS), capable of fix identification on a Standard Instrument Approach Procedure.

**6.1.5** Where a complete ILS system is installed on each end of a runway (i.e., the approach end of runway 4 and the approach end of runway 22), the ILS systems are not in service simultaneously.

## **6.2 Localizer**

**6.2.1** The localizer transmitter, operates on one of 40 ILS channels within the frequency range of 108.10 MHz to 111.95 MHz. Signals provide the pilot with course guidance to the runway centerline.

**6.2.2** The approach course of the localizer is called the front course and is used with other functional parts; e.g., glide slope, marker beacons, etc. The localizer signal is transmitted at the far end of the runway. It is adjusted for a course width (full scale fly-left to a full scale fly-right) of 700 feet at the runway threshold.

**6.2.3** The course line along the extended centerline of a runway, in the opposite direction to the front course, is called the back course.

### **CAUTION–**

*Unless your aircraft's ILS equipment includes reverse sensing capability, when flying inbound on the back course it is necessary to steer the aircraft in the direction opposite of the needle deflection on the airborne equipment when making corrections from off-course to on-course. This "flying away from the needle" is also required when flying outbound on the front course of the localizer. Do not use back course signals for approach unless a back course approach procedure is published for that particular runway and the approach is authorized by ATC.*

**6.2.4** Identification is in Morse Code and consists of a three-letter identifier preceded by the letter I (●●) transmitted on the localizer frequency.

### **EXAMPLE–**

*I–DIA*

**6.2.5** The localizer provides course guidance throughout the descent path to the runway threshold from a distance of 18 NM from the antenna between an altitude of 1,000 feet above the highest terrain along the course line and 4,500 feet above the elevation of the antenna site. Proper off-course indications are provided throughout the following angular areas of the operational service volume:

**6.2.5.1** To 10° either side of the course along a radius of 18 NM from the antenna.

**6.2.5.2** From 10° to 35° either side of the course along a radius of 10 NM. (See FIG ENR 4.1–1.)

**6.2.6** Unreliable signals may be received outside of these areas. ATC may clear aircraft on procedures beyond the service volume when the controller initiates the action or when the pilot requests, and radar monitoring is provided.

**6.2.7** The areas described in paragraph 6.2.5 and depicted in FIG ENR 4.1–1 represent a Standard Service Volume (SSV) localizer. All charted procedures with localizer coverage beyond the 18 NM SSV have been

through the approval process for Expanded Service Volume (ESV), and have been validated by flight inspection. (See FIG ENR 4.1-2.)

FIG ENR 4.1-1  
Limits of Localizer Coverage

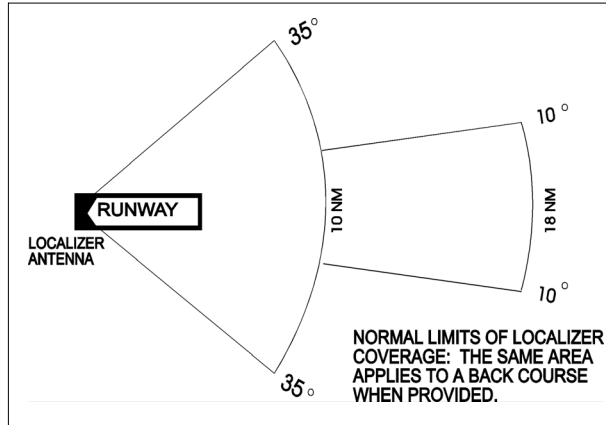


FIG ENR 4.1-2  
ILS Expanded Service Volume

CHICAGO, ILLINOIS		AL-166 (FAA)		21112	
LOC/DME I-IAC <b>110.5</b> Chan 42	APP CRS <b>273°</b>	Rwy ldg TDZE Apt Elev	<b>7782</b> <b>654</b> <b>680</b>	<b>ILS RWY 27L (SA CAT I)</b> CHICAGO O'HARE INTL (ORD)	
From VOGLR: RNAV 1-GPS required. Aircraft not GPS equipped - RADAR required for procedure entry. DME or RADAR required.				ALSIF-2 	MISSED APPROACH: Climb to 1200 then climb to 4000 on heading 265° and on CGT VORTAC R-307 to WASCO/CGT 45.8 DME/RADAR and hold.
Simultaneous approach authorized. Requires specific OPSPEC, MSPEC, or LOA approval and use of HUD to DH. For inop ALS, increase S-LOC 27L Cat C/D visibility to 1 3/8 SM.					
D-ATIS <b>135.4</b>	CHICAGO APP CON <b>119.0 292.125</b>	O'HARE TOWERS <b>128.15 348.0</b> (Rwy 9L/27R) <b>133.0 348.0</b> (10R/28L) <b>120.75 121.15 126.9 132.7 348.0</b> (CENTER)		GND CON (TWR NORTH) <b>124.125</b> (TWR SOUTH) <b>118.05</b> (ALL TWRS) <b>226.675</b>	(TWR CENTER) <b>121.75</b> (OBND) (IBND) <b>121.9</b>
				CLNC DEL <b>121.6</b>	CPDLC
<p><b>Example:</b> The ORD ILS 27L contains the fix NRMAH (093 degrees at 26.2 DME). Since NRMAH is published on the charted procedure, the LOC (I-IAC) signal has been certified by FAA flight inspection beyond the standard 18NM service volume out to 26.2 DME.</p>					

### 6.3 Localizer–Type Directional Aid

**6.3.1** The localizer–type directional aid (LDA) is of comparable use and accuracy to a localizer but is not part of a complete ILS. The LDA course usually provides a more precise approach course than the similar Simplified Directional Facility (SDF) installation, which may have a course width of 6 degrees or 12 degrees.

**6.3.2** The LDA is not aligned with the runway. Straight–in minimums may be published where alignment does not exceed 30 degrees between the course and runway. Circling minimums only are published where this alignment exceeds 30 degrees.

**6.3.3** A very limited number of LDA approaches also incorporate a glideslope. These are annotated in the plan view of the instrument approach chart with a note, “LDA/Glideslope.” These procedures fall under a newly defined category of approaches called Approach with Vertical Guidance (APV) described in ENR 1.5, Paragraph 12., Instrument Approach Procedure Charts, subparagraph 12.1.7.2, Approach with Vertical Guidance (APV). LDA minima for with and without glideslope is provided and annotated on the minima lines of the approach chart as S–LDA/GS and S–LDA. Because the final approach course is not aligned with the runway centerline, additional maneuvering will be required compared to an ILS approach.

### 6.4 Glide Slope/Glide Path

**6.4.1** The UHF glide slope transmitter, operating on one of the 40 ILS channels within the frequency range 329.15 MHz, to 335.00 MHz radiates its signals in the direction of the localizer front course.

#### **CAUTION–**

*False glide slope signals may exist in the area of the localizer back course approach which can cause the glide slope flag alarm to disappear and present unreliable glide slope information. Disregard all glide slope signal indications when making a localizer back course approach unless a glide slope is specified on the approach and landing chart.*

**6.4.2** The glide slope transmitter is located between 750 and 1,250 feet from the approach end of the runway (down the runway) and offset 250–600 feet from the runway centerline. It transmits a glide path beam 1.4 degrees wide (vertically).

#### **NOTE–**

*The term “glide path” means that portion of the glide slope that intersects the localizer.*

**6.4.3** The glide path projection angle is normally adjusted to 3 degrees above horizontal so that it intersects the middle marker at about 200 feet and the outer marker at about 1,400 feet above the runway elevation. The glide slope is normally usable to the distance of 10 NM. However, at some locations, the glide slope has been certified for an extended service volume which exceeds 10 NM.

**6.4.4** Pilots must be alert when approaching glidepath interception. False courses and reverse sensing will occur at angles considerably greater than the published path.

**6.4.5** Make every effort to remain on the indicated glide path. Exercise caution: avoid flying below the glide path to assure obstacle/terrain clearance is maintained.

#### **REFERENCE–**

*14 CFR Section 91.129(e).*

**6.4.6** A glide slope facility provides descent information for navigation down to the lowest authorized decision height (DH) specified in the approved ILS approach procedure. The glidepath may not be suitable for navigation below the lowest authorized DH and any reference to glidepath indications below that height must be supplemented by visual reference to the runway environment. Glide slopes with no published DH are usable to runway threshold.

**6.4.7** The published glide slope threshold crossing height (TCH) DOES NOT represent the height of the actual glide slope on course indication above the runway threshold. It is used as a reference for planning purposes which represents the height above the runway threshold that an aircraft’s glide slope antenna should be, if that aircraft remains on a trajectory formed by the four–mile–to–middle marker glidepath segment.

**6.4.8** Pilots must be aware of the vertical height between the aircraft’s glide slope antenna and the main gear in the landing configuration and, at the DH, plan to adjust the descent angle accordingly if the published TCH

indicates the wheel crossing height over the runway threshold may be satisfactory. Tests indicate a comfortable wheel crossing height is approximately 20 to 30 feet, depending on the type of aircraft.

**NOTE-**

*The TCH for a runway is established based on several factors including the largest aircraft category that normally uses the runway, how airport layout affects the glide slope antenna placement, and terrain. A higher than optimum TCH, with the same glide path angle, may cause the aircraft to touch down further from the threshold if the trajectory of the approach is maintained until the flare. Pilots should consider the effect of a high TCH on the runway available for stopping the aircraft.*

**6.5 Distance Measuring Equipment (DME)**

**6.5.1** When installed with an ILS and specified in the approach procedure, DME may be used:

**6.5.1.1** In lieu of the outer marker.

**6.5.1.2** As a back course final approach fix.

**6.5.1.3** To establish other fixes on the localizer course.

**6.5.2** In some cases, DME from a separate facility may be used within Terminal Instrument Procedures (TERPS) limitations:

**6.5.2.1** To provide ARC initial approach segments.

**6.5.2.2** As a final approach fix for back course approaches.

**6.5.2.3** As a substitute for the outer marker.

**6.6 Marker Beacon**

**6.6.1** ILS marker beacons have a rated power output of 3 watts or less and an antenna array designed to produce an elliptical pattern with dimensions, at 1,000 feet above the antenna, of approximately 2,400 feet in width and 4,200 feet in length. Airborne marker beacon receivers with a selective sensitivity feature should always be operated in the “low” sensitivity position for proper reception of ILS marker beacons.

**6.6.2** ILS systems may have an associated OM. An MM is no longer required. Locations with a Category II ILS also have an Inner Marker (IM). Due to advances in both ground navigation equipment and airborne avionics, as well as the numerous means that may be used as a substitute for a marker beacon, the current requirements for the use of marker beacons are:

**6.6.2.1** An OM or suitable substitute identifies the Final Approach Fix (FAF) for nonprecision approach (NPA) operations (for example, localizer only); and

**6.6.2.2** The MM indicates a position approximately 3,500 feet from the landing threshold. This is also the position where an aircraft on the glide path will be at an altitude of approximately 200 feet above the elevation of the touchdown zone. A MM is no longer operationally required. There are some MMs still in use, but there are no MMs being installed at new ILS sites by the FAA; and

**6.6.2.3** An IM, where installed, indicates the point at which an aircraft is at decision height on the glide path during a Category II ILS approach. An IM is only required for CAT II operations that do not have a published radio altitude (RA) minimum.

**6.6.3** A back course marker, normally indicates the ILS back course final approach fix where approach descent is commenced.

**TBL ENR 4.1-1  
Marker Passage Indications**

Marker	Code	Light
OM	— — —	BLUE
MM	● — ● —	AMBER
IM	● ● ● ●	WHITE
BC	● ● ● ●	WHITE

## 7. Compass Locator

**7.1** Compass locator transmitters are often situated at the middle and outer marker sites. The transmitters have a power of less than 25 watts, a range of at least 15 miles, and operate between 190 and 535 kHz. At some locations, higher-powered radio beacons, up to 400 watts, are used as outer marker compass locators.

**7.2** Compass locators transmit two-letter identification groups. The outer locator transmits the first two letters of the localizer identification group, and the middle locator transmits the last two letters of the localizer identification group.

## 8. ILS Frequency

**8.1** The frequency pairs in TBL ENR 4.1–2 are allocated for ILS.

*TBL ENR 4.1–2*  
**Frequency Pairs Allocated for ILS**

Localizer MHz	Glide Slope	Localizer MHz	Glide Slope
108.10	334.70	110.1	334.40
108.15	334.55	110.15	334.25
108.3	334.10	110.3	335.00
108.35	333.95	110.35	334.85
108.5	329.90	110.5	329.60
108.55	329.75	110.55	329.45
108.7	330.50	110.70	330.20
108.75	330.35	110.75	330.05
108.9	329.30	110.90	330.80
108.95	329.15	110.95	330.65
109.1	331.40	111.10	331.70
109.15	331.25	111.15	331.55
109.3	332.00	111.30	332.30
109.35	331.85	111.35	332.15
109.50	332.60	111.50	332.9
109.55	332.45	111.55	332.75
109.70	333.20	111.70	333.5
109.75	333.05	111.75	333.35
109.90	333.80	111.90	331.1
109.95	333.65	111.95	330.95

## 9. ILS Minimums

**9.1** The lowest authorized ILS minimums, with all required ground and airborne systems components operative, are:

**9.1.1 Category I.** Decision Height (DH) 200 feet and Runway Visual Range (RVR) 2,400 feet (with touchdown zone and centerline lighting, RVR 1,800 feet), or (with Autopilot or FD or HUD, RVR 1,800 feet);

**9.1.2 Special Authorization Category I.** DH 150 feet and Runway Visual Range (RVR) 1,400 feet, HUD to DH;

**9.1.3 Category II.** DH 100 feet and RVR 1,200 feet (with autoland or HUD to touchdown and noted on authorization, RVR 1,000 feet);

**9.1.4 Special Authorization Category II with Reduced Lighting.** DH 100 feet and RVR 1,200 feet with autoland or HUD to touchdown and noted on authorization, (touchdown zone, centerline lighting and ALSF–2 are not required);

**9.1.5 Category IIIa.** No DH or DH below 100 feet and RVR not less than 700 feet;



**9.1.6 Category IIIb.** No DH or DH below 50 feet and RVR less than 700 feet but not less than 150 feet; and

**9.1.7 Category IIIc.** No DH and no RVR limitation.

**NOTE-**

*Special authorization and equipment are required for Category II and III.*

## **10. Inoperative ILS Components**

**10.1 Inoperative Localizer.** When the localizer fails, an ILS approach is not authorized.

**10.2 Inoperative Glide Slope.** When the glide slope fails, the ILS reverts to a nonprecision localizer approach.

**REFERENCE-**

*See the Inoperative Component Table in the U.S. Government Terminal Procedures Publication (TPP) for adjustments to minimums due to inoperative airborne or ground system equipment.*

## **11. ILS Course and Glideslope Distortion**

**11.1** All pilots should be aware that ILS installations are subject to signal interference by surface vehicles and aircraft (either on the ground or airborne). ILS CRITICAL AREAS are established near each localizer and glide slope antenna. Pilots should be aware of the level of critical area protection they can expect in various weather conditions and understand that signal disturbances may occur as a result of normal airport operations irrespective of the official weather observation.

**11.2** ATC is not always required to issue control instructions to avoid interfering operations within ILS critical areas at controlled airports during the hours the Airport Traffic Control Tower (ATCT) is in operation. ATC responsibilities vary depending on the official weather observation and are described as follows:

**11.2.1 Weather Conditions.** Official weather observation indicates a ceiling of 800 feet or higher and visibility 2 miles or greater, no localizer or glideslope critical area protection is provided by ATC unless specifically requested by the flight crew.

**11.2.2 Weather Conditions.** Official weather observation indicates a ceiling of less than 800 feet or visibility less than 2 miles.

**11.2.2.1 Holding.** Aircraft holding below 5,000 feet between the outer marker and the airport may cause localizer signal variations for aircraft conducting the ILS approach. Accordingly, such holding will not be authorized by ATC.

**11.2.2.2 Localizer Critical Area.** When an arriving aircraft is inside the outer marker (OM) or the fix used in lieu of the OM, vehicles and aircraft will not be authorized in or over the precision approach critical area except:

a) A preceding arriving aircraft on the same or another runway may pass over or through the localizer critical area, and;

b) A preceding departing aircraft or missed approach on the same or another runway may pass through or over the localizer critical area.

**11.2.2.3 Glide Slope Critical Area.** ATC will not authorize vehicles or aircraft operations in or over the glideslope critical area when an arriving aircraft is inside the outer marker (OM), or the fix used in lieu of the OM, unless the arriving aircraft has reported the runway in sight and is circling or side-stepping to land on another runway.

**11.2.3 Weather Conditions.** Official weather observation indicates a ceiling less than 200 feet or runway visual range (RVR) less than 2000 feet.

**11.2.3.1 Localizer Critical Area.** In addition to the critical area protection described in 11.2.2 above, when an arriving aircraft is inside the middle marker (MM), or in the absence of a MM, ½ mile final, ATC will not authorize:

a) A preceding arriving aircraft on the same or another runway to pass over or through the localizer critical area, or;

b) A preceding departing aircraft or missed approach on the same or another runway to pass through or over the localizer critical area.

**11.3** In order to ensure that pilot and controller expectations match with respect to critical area protection for a given approach and landing operation, a flight crew should advise the tower any time it intends to conduct any autoland operation or use an SA CAT I, any CAT II, or any CAT III line of minima anytime the official weather observation is at or above a ceiling of 800 feet and 2 miles visibility. If ATC is unable to protect the critical area, they will advise the flight crew.

**EXAMPLE-**

*Denver Tower, United 1153, Request Autoland (runway) ATC replies with:  
United 1153, Denver Tower, Roger, Critical Areas not protected.*

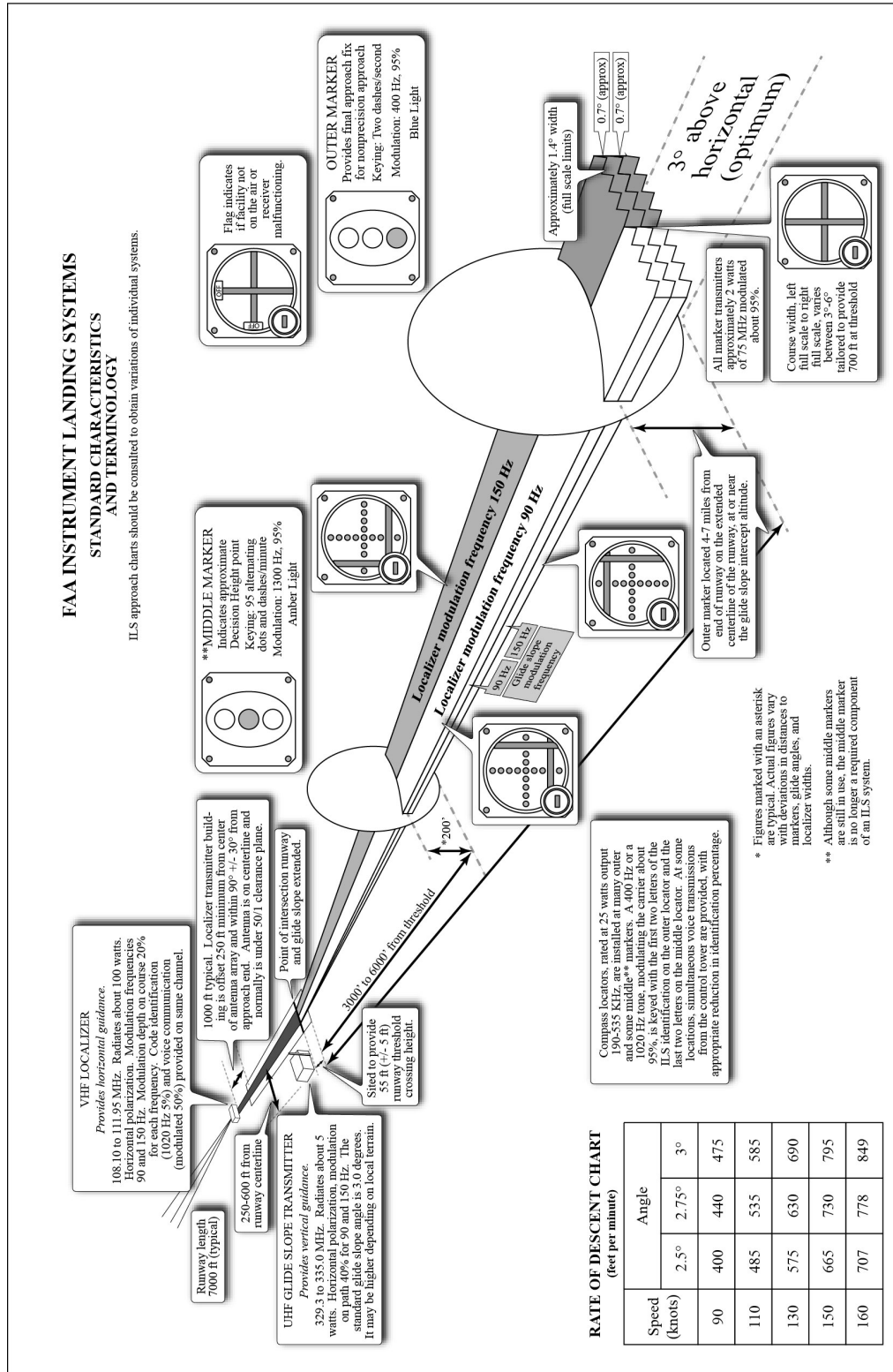
**11.4** Pilots are cautioned that even when the critical areas are considered to be protected, unless the official weather observation including controller observations indicates a ceiling less than 200 feet or RVR less than 2000 feet, ATC may still authorize a preceding arriving, departing, or missed approach aircraft to pass through or over the localizer critical area and that this may cause signal disturbances that could result in an undesired aircraft state during the final stages of the approach, landing, and rollout.

**11.5** Pilots are cautioned that vehicular traffic not subject to ATC may cause momentary deviation to ILS course or glide slope signals. Also, critical areas are not protected at uncontrolled airports or at airports with an operating control tower when weather or visibility conditions are above those requiring protective measures. Aircraft conducting coupled or autoland operations should be especially alert in monitoring automatic flight control systems and be prepared to intervene as necessary. (See FIG ENR 4.1-3.)

**NOTE-**

*Unless otherwise coordinated through Flight Standards, ILS signals to Category I runways are not flight inspected below the point that is 100 feet less than the decision altitude (DA). Guidance signal anomalies may be encountered below this altitude.*

FIG ENR 4.1-3  
FAA Instrument Landing Systems



**12. Continuous Power Facilities**

**12.1** In order to ensure that a basic ATC system remains in operation despite an area wide or catastrophic commercial power failure, key equipment and certain airports have been designated to provide a network of facilities whose operational capability can be utilized independent of any commercial power supply.

**12.2** In addition to those facilities comprising the basic ATC system, the following approach and lighting aids have been included in this program for a selected runway:

**12.2.1** ILS (Localizer, Glide Slope, Compass Locator, Inner, Middle and Outer Markers).

**12.2.2** Wind Measuring Capability.

**12.2.3** Approach Light System (ALS) or Short ALS (SALS).

**12.2.4** Ceiling Measuring Capability.

**12.2.5** Touchdown Zone Lighting (TDZL).

**12.2.6** Centerline Lighting (CL).

**12.2.7** Runway Visual Range (RVR).

**12.2.8** High Intensity Runway Lighting (HIRL).

**12.2.9** Taxiway Lighting.

**12.2.10** Apron Light (Perimeter Only).

*TBL ENR 4.1-3*  
**Continuous Power Airports**

<b>Airport/Ident</b>	<b>Runway No.</b>
Albuquerque (ABQ)	08
Andrews AFB (ADW)	1L
Atlanta (ATL)	9R
Baltimore (BWI)	10
Bismarck (BIS)	31
Boise (BOI)	10R
Boston (BOS)	4R
Charlotte (CLT)	36L
Chicago (ORD)	14R
Cincinnati (CVG)	36
Cleveland (CLE)	5R
Dallas/Fort Worth (DFW)	17L
Denver (DEN)	35R
Des Moines (DSM)	30R
Detroit (DTW)	3L
El Paso (ELP)	22
Great Falls (GTF)	03
Houston (IAH)	08
Indianapolis (IND)	4L
Jacksonville (JAX)	07
Kansas City (MCI)	19
Los Angeles (LAX)	24R
Memphis (MEM)	36L

Airport/Ident	Runway No.
Miami (MIA)	9L
Milwaukee (MKE)	01
Minneapolis (MSP)	29L
Nashville (BNA)	2L
Newark (EWR)	4R
New Orleans (MSY)	10
New York (JFK)	4R
New York (LGA)	22
Oklahoma City (OKC)	35R
Omaha (OMA)	14
Ontario, California (ONT)	26R
Philadelphia (PHL)	9R
Phoenix (PHX)	08R
Pittsburgh (PIT)	10L
Reno (RNO)	16
Salt Lake City (SLC)	34L
San Antonio (SAT)	12R
San Diego (SAN)	09
San Francisco (SFO)	28R
Seattle (SEA)	16R
St. Louis (STL)	24
Tampa (TPA)	36L
Tulsa (TUL)	35R
Washington (DCA)	36
Washington (IAD)	1R
Wichita (ICT)	01

**12.3** The above have been designated “Continuous Power Airports,” and have independent back up capability for the equipment installed.

**NOTE–**

*The existing CPA runway is listed. Pending and future changes at some locations will require a revised runway designation.*

**13. Simplified Directional Facility (SDF)**

**13.1** The SDF provides a final approach course similar to that of the ILS localizer. It does not provide glide slope information. A clear understanding of the ILS localizer and the additional factors listed below completely describe the operational characteristics and use of the SDF.

**13.2** The SDF transmits signals within the range of 108.10 to 111.95 MHz.

**13.3** The approach techniques and procedures used in an SDF instrument approach are essentially the same as those employed in executing a standard no–glide–slope localizer approach except the SDF course may not be aligned with the runway and the course may be wider, resulting in less precision.

**13.4** Usable off–course indications are limited to 35 degrees either side of the course centerline. Instrument indications received beyond 35 degrees should be disregarded.

**13.5** The SDF antenna may be offset from the runway centerline. Because of this, the angle of convergence between the final approach course and the runway bearing should be determined by reference to the instrument

approach procedure chart. This angle is generally not more than 3 degrees. However, it should be noted that inasmuch as the approach course originates at the antenna site, an approach which is continued beyond the runway threshold will lead the aircraft to the SDF offset position rather than along the runway centerline.

**13.6** The SDF signal is fixed at either 6 degrees or 12 degrees as necessary to provide maximum “fly ability” and optimum course quality.

**13.7** Identification consists of a three–letter identifier transmitted in Morse Code on the SDF frequency. The appropriate instrument approach chart will indicate the identifier used at a particular airport.

## **14. LORAN**

### **NOTE–**

*In accordance with the 2010 DHS Appropriations Act, the U.S. Coast Guard (USCG) terminated the transmission of all U.S. LORAN–C signals on 08 Feb 2010. The USCG also terminated the transmission of the Russian American signals on 01 Aug 2010, and the Canadian LORAN–C signals on 03 Aug 2010. For more information, visit <http://www.navcen.uscg.gov/>. Operators should also note that TSO–C60b, AIRBORNE AREA NAVIGATION EQUIPMENT USING LORAN–C INPUTS, has been canceled by the FAA.*

## **15. Inertial Reference Unit (IRU), Inertial Navigation System (INS), and Attitude Heading Reference System (AHRS)**

**15.1** IRUs are self–contained systems comprised of gyros and accelerometers that provide aircraft attitude (pitch, roll, and heading), position, and velocity information in response to signals resulting from inertial effects on system components. Once aligned with a known position, IRUs continuously calculate position and velocity. IRU position accuracy decays with time. This degradation is known as “drift.”

**15.2** INSs combine the components of an IRU with an internal navigation computer. By programming a series of waypoints, these systems will navigate along a predetermined track.

**15.3** AHRSs are electronic devices that provide attitude information to aircraft systems such as weather radar and autopilot, but do not directly compute position information.

**15.4** Aircraft equipped with slaved compass systems may be susceptible to heading errors caused by exposure to magnetic field disturbances (flux fields) found in materials that are commonly located on the surface or buried under taxiways and ramps. These materials generate a magnetic flux field that can be sensed by the aircraft’s compass system flux detector or “gate”, which can cause the aircraft’s system to align with the material’s magnetic field rather than the earth’s natural magnetic field. The system’s erroneous heading may not self-correct. Prior to take off pilots should be aware that a heading misalignment may have occurred during taxi. Pilots are encouraged to follow the manufacturer’s or other appropriate procedures to correct possible heading misalignment before take off is commenced.

## **16. Global Positioning System (GPS)**

### **16.1 System Overview**

**16.1.1** System Description. The Global Positioning System is a space-based radio navigation system used to determine precise position anywhere in the world. The 24 satellite constellation is designed to ensure at least five satellites are always visible to a user worldwide. A minimum of four satellites is necessary for receivers to establish an accurate three–dimensional position. The receiver uses data from satellites above the mask angle (the lowest angle above the horizon at which a receiver can use a satellite). The Department of Defense (DOD) is responsible for operating the GPS satellite constellation and monitors the GPS satellites to ensure proper operation. Each satellite’s orbital parameters (ephemeris data) are sent to each satellite for broadcast as part of the data message embedded in the GPS signal. The GPS coordinate system is the Cartesian earth–centered, earth–fixed coordinates as specified in the World Geodetic System 1984 (WGS–84).

#### **16.1.2 System Availability and Reliability**

**16.1.2.1** The status of GPS satellites is broadcast as part of the data message transmitted by the GPS satellites. GPS status information is also available by means of the U.S. Coast Guard navigation information service: (703) 313–5907, Internet: <http://www.navcen.uscg.gov/>. Additionally, satellite status is available through the Notice to Air Missions (NOTAM) system.

**16.1.2.2** GNSS operational status depends on the type of equipment being used. For GPS–only equipment TSO–C129 or TSO–C196(), the operational status of non–precision approach capability for flight planning purposes is provided through a prediction program that is embedded in the receiver or provided separately.

**16.1.3** Receiver Autonomous Integrity Monitoring (RAIM). RAIM is the capability of a GPS receiver to perform integrity monitoring on itself by ensuring available satellite signals meet the integrity requirements for a given phase of flight. Without RAIM, the pilot has no assurance of the GPS position integrity. RAIM provides immediate feedback to the pilot. This fault detection is critical for performance-based navigation (PBN)(see ENR 1.17, Performance–Based Navigation (PBN) and Area Navigation (RNAV), for an introduction to PBN), because delays of up to two hours can occur before an erroneous satellite transmission is detected and corrected by the satellite control segment.

**16.1.3.1** In order for RAIM to determine if a satellite is providing corrupted information, at least one satellite, in addition to those required for navigation, must be in view for the receiver to perform the RAIM function. RAIM requires a minimum of 5 satellites, or 4 satellites and barometric altimeter input (baro–aiding), to detect an integrity anomaly. Baro–aiding is a method of augmenting the GPS integrity solution by using a non-satellite input source in lieu of the fifth satellite. Some GPS receivers also have a RAIM capability, called fault detection and exclusion (FDE), that excludes a failed satellite from the position solution; GPS receivers capable of FDE require 6 satellites or 5 satellites with baro–aiding. This allows the GPS receiver to isolate the corrupt satellite signal, remove it from the position solution, and still provide an integrity-assured position. To ensure that baro–aiding is available, enter the current altimeter setting into the receiver as described in the operating manual. Do not use the GPS derived altitude due to the large GPS vertical errors that will make the integrity monitoring function invalid.

**16.1.3.2** There are generally two types of RAIM fault messages. The first type of message indicates that there are not enough satellites available to provide RAIM integrity monitoring. The GPS navigation solution may be acceptable, but the integrity of the solution cannot be determined. The second type indicates that the RAIM integrity monitor has detected a potential error and that there is an inconsistency in the navigation solution for the given phase of flight. Without RAIM capability, the pilot has no assurance of the accuracy of the GPS position.

**16.1.4** Selective Availability. Selective Availability (SA) is a method by which the accuracy of GPS is intentionally degraded. This feature was designed to deny hostile use of precise GPS positioning data. SA was discontinued on May 1, 2000, but many GPS receivers are designed to assume that SA is still active. New receivers may take advantage of the discontinuance of SA based on the performance values in ICAO Annex 10.

**16.2 Operational Use of GPS.** U.S. civil operators may use approved GPS equipment in oceanic airspace, certain remote areas, the National Airspace System and other States as authorized (please consult the applicable Aeronautical Information Publication). Equipment other than GPS may be required for the desired operation. GPS navigation is used for both Visual Flight Rules (VFR) and Instrument Flight Rules (IFR) operations.

### **16.2.1 VFR Operations**

**16.2.1.1** GPS navigation has become an asset to VFR pilots by providing increased navigational capabilities and enhanced situational awareness. Although GPS has provided many benefits to the VFR pilot, care must be exercised to ensure that system capabilities are not exceeded. VFR pilots should integrate GPS navigation with electronic navigation (when possible), as well as pilotage and dead reckoning.

**16.2.1.2** GPS receivers used for VFR navigation vary from fully integrated IFR/VFR installation used to support VFR operations to hand–held devices. Pilots must understand the limitations of the receivers prior to using in flight to avoid misusing navigation information. (See TBL ENR 4.1–5.) Most receivers are not intuitive. The

pilot must learn the various keystrokes, knob functions, and displays that are used in the operation of the receiver. Some manufacturers provide computer–based tutorials or simulations of their receivers that pilots can use to become familiar with operating the equipment.

**16.2.1.3** When using GPS for VFR operations, RAIM capability, database currency, and antenna location are critical areas of concern.

a) **RAIM Capability.** VFR GPS panel mount receivers and hand–held units have no RAIM alerting capability. This prevents the pilot from being alerted to the loss of the required number of satellites in view, or the detection of a position error. Pilots should use a systematic cross–check with other navigation techniques to verify position. Be suspicious of the GPS position if a disagreement exists between the two positions.

b) **Database Currency.** Check the currency of the database. Databases must be updated for IFR operations and should be updated for all other operations. However, there is no requirement for databases to be updated for VFR navigation. It is not recommended to use a moving map with an outdated database in and around critical airspace. Pilots using an outdated database should verify waypoints using current aeronautical products; for example, Chart Supplement U.S., Sectional Chart, or En Route Chart.

c) **Antenna Location.** The antenna location for GPS receivers used for IFR and VFR operations may differ. VFR antennae are typically placed for convenience more than performance, while IFR installations ensure a clear view is provided with the satellites. Antennae not providing a clear view have a greater opportunity to lose the satellite navigational signal. This is especially true in the case of hand–held GPS receivers. Typically, suction cups are used to place the GPS antennas on the inside of cockpit windows. While this method has great utility, the antenna location is limited to the cockpit or cabin which rarely provides a clear view of all available satellites. Consequently, signal losses may occur due to aircraft structure blocking satellite signals, causing a loss of navigation capability. These losses, coupled with a lack of RAIM capability, could present erroneous position and navigation information with no warning to the pilot. While the use of a hand–held GPS for VFR operations is not limited by regulation, modification of the aircraft, such as installing a panel– or yoke–mounted holder, is governed by 14 CFR Part 43. Consult with your mechanic to ensure compliance with the regulation and safe installation.

**16.2.1.4** Do not solely rely on GPS for VFR navigation. No design standard of accuracy or integrity is used for a VFR GPS receiver. VFR GPS receivers should be used in conjunction with other forms of navigation during VFR operations to ensure a correct route of flight is maintained. Minimize head–down time in the aircraft by being familiar with your GPS receiver’s operation and by keeping eyes outside scanning for traffic, terrain, and obstacles.

#### **16.2.1.5 VFR Waypoints**

a) VFR waypoints provide VFR pilots with a supplementary tool to assist with position awareness while navigating visually in aircraft equipped with area navigation receivers. VFR waypoints should be used as a tool to supplement current navigation procedures. The uses of VFR waypoints include providing navigational aids for pilots unfamiliar with an area, waypoint definition of existing reporting points, enhanced navigation in and around Class B and Class C airspace, enhanced navigation around Special Use Airspace, and entry points for commonly flown mountain passes. VFR pilots should rely on appropriate and current aeronautical charts published specifically for visual navigation. If operating in a terminal area, pilots should take advantage of the Terminal Area Chart available for that area, if published. The use of VFR waypoints does not relieve the pilot of any responsibility to comply with the operational requirements of 14 CFR Part 91.

b) VFR waypoint names (for computer entry and flight plans) consist of five letters beginning with the letters “VP” and are retrievable from navigation databases. The VFR waypoint names are not intended to be pronounceable, and they are not for use in ATC communications. On VFR charts, stand–alone VFR waypoints will be portrayed using the same four–point star symbol used for IFR waypoints. VFR waypoints collocated with visual check–points on the chart will be identified by small magenta flag symbols. VFR waypoints collocated with visual check–points will be pronounceable based on the name of the visual check–point and may be used for ATC communications. Each VFR waypoint name will appear in parentheses adjacent to the geographic



location on the chart. Latitude/longitude data for all established VFR waypoints may be found in FAA Order JO 7350.9, Location Identifiers.

c) VFR waypoints may not be used on IFR flight plans. VFR waypoints are not recognized by the IFR system and will be rejected for IFR routing purposes.

d) Pilots may use the five–letter identifier as a waypoint in the route of flight section on a VFR flight plan. Pilots may use the VFR waypoints only when operating under VFR conditions. The point may represent an intended course change or describe the planned route of flight. This VFR filing would be similar to how a VOR would be used in a route of flight.

e) VFR waypoints intended for use during flight should be loaded into the receiver while on the ground. Once airborne, pilots should avoid programming routes or VFR waypoint chains into their receivers.

f) Pilots should be vigilant to see and avoid other traffic when near VFR waypoints. With the increased use of GPS navigation and accuracy, expect increased traffic near VFR waypoints. Regardless of the class of airspace, monitor the available ATC frequency for traffic information on other aircraft operating in the vicinity. See ENR 1.17, paragraph 3. VFR in Congested Areas, for more information.

g) Mountain pass entry points are marked for convenience to assist pilots with flight planning and visual navigation. Do not attempt to fly a mountain pass directly from VFR waypoint to VFR waypoint—they do not create a path through the mountain pass. Alternative routes are always available. It is the pilot in command's responsibility to choose a suitable route for the intended flight and known conditions.

**REFERENCE–**

*AIP, Para ENR 5.7–7., Mountain Flying.*

**16.2.2 IFR Use of GPS**

**16.2.2.1 General Requirements.** Authorization to conduct any GPS operation under IFR requires:

a) GPS navigation equipment used for IFR operations must be approved in accordance with the requirements specified in Technical Standard Order (TSO) TSO–C129(), TSO–C196(), TSO–C145(), or TSO–C146(), and the installation must be done in accordance with Advisory Circular AC 20–138(), *Airworthiness Approval of Positioning and Navigation Systems*. Equipment approved in accordance with TSO–C115a does not meet the requirements of TSO–C129. Visual flight rules (VFR) and hand–held GPS systems are not authorized for IFR navigation, instrument approaches, or as a principal instrument flight reference.

b) Aircraft using un-augmented GPS (TSO–C129() or TSO–C196()) for navigation under IFR must be equipped with an alternate approved and operational means of navigation suitable for navigating the proposed route of flight. (Examples of alternate navigation equipment include VOR or DME/DME/IRU capability). Active monitoring of alternative navigation equipment is not required when RAIM is available for integrity monitoring. Active monitoring of an alternate means of navigation is required when the GPS RAIM capability is lost.

c) Procedures must be established for use in the event that the loss of RAIM capability is predicted to occur. In situations where RAIM is predicted to be unavailable, the flight must rely on other approved navigation equipment, re-route to where RAIM is available, delay departure, or cancel the flight.

d) The GPS operation must be conducted in accordance with the FAA–approved aircraft flight manual (AFM) or flight manual supplement. Flight crew members must be thoroughly familiar with the particular GPS equipment installed in the aircraft, the receiver operation manual, and the AFM or flight manual supplement. Operation, receiver presentation and capabilities of GPS equipment vary. Due to these differences, operation of GPS receivers of different brands, or even models of the same brand, under IFR should not be attempted without thorough operational knowledge. Most receivers have a built–in simulator mode, which allows the pilot to become familiar with operation prior to attempting operation in the aircraft.

e) Aircraft navigating by IFR–approved GPS are considered to be performance–based navigation (PBN) aircraft and have special equipment suffixes. File the appropriate equipment suffix in accordance with Appendix

2, TBL 2–2, on the ATC flight plan. If GPS avionics become inoperative, the pilot should advise ATC and amend the equipment suffix.

f) Prior to any GPS IFR operation, the pilot must review appropriate NOTAMs and aeronautical information. (See GPS NOTAMs/Aeronautical Information).

**16.2.2.2 Database Requirements.** The onboard navigation data must be current and appropriate for the region of intended operation and should include the navigation aids, waypoints, and relevant coded terminal airspace procedures for the departure, arrival, and alternate airfields.

a) Further database guidance for terminal and en route requirements may be found in AC 90-100, U.S. Terminal and En Route Area Navigation (RNAV) Operations.

b) Further database guidance on Required Navigation Performance (RNP) instrument approach operations, RNP terminal, and RNP en route requirements may be found in AC 90-105, Approval Guidance for RNP Operations and Barometric Vertical Navigation in the U.S. National Airspace System.

c) All approach procedures to be flown must be retrievable from the current airborne navigation database supplied by the equipment manufacturer or other FAA–approved source. The system must be able to retrieve the procedure by name from the aircraft navigation database, not just as a manually entered series of waypoints. Manual entry of waypoints using latitude/longitude or place/bearing is not permitted for approach procedures.

d) Prior to using a procedure or waypoint retrieved from the airborne navigation database, the pilot should verify the validity of the database. This verification should include the following preflight and inflight steps:

**1) Preflight:**

(a) Determine the date of database issuance, and verify that the date/time of proposed use is before the expiration date/time.

(b) Verify that the database provider has not published a notice limiting the use of the specific waypoint or procedure.

**2) Inflight:**

(a) Determine that the waypoints and transition names coincide with names found on the procedure chart. Do not use waypoints which do not exactly match the spelling shown on published procedure charts.

(b) Determine that the waypoints are logical in location, in the correct order, and their orientation to each other is as found on the procedure chart, both laterally and vertically.

**NOTE–**

*There is no specific requirement to check each waypoint latitude and longitude, type of waypoint and/or altitude constraint, only the general relationship of waypoints in the procedure, or the logic of an individual waypoint's location.*

(c) If the cursory check of procedure logic or individual waypoint location, specified in [b] above, indicates a potential error, do not use the retrieved procedure or waypoint until a verification of latitude and longitude, waypoint type, and altitude constraints indicate full conformity with the published data.

e) Air carrier and commercial operators must meet the appropriate provisions of their approved operations specifications.

1) During domestic operations for commerce or for hire, operators must have a second navigation system capable of reversion or contingency operations.

2) Operators must have two independent navigation systems appropriate to the route to be flown, or one system that is suitable and a second, independent backup capability that allows the operator to proceed safely and land at a different airport, and the aircraft must have sufficient fuel (reference 14 CFR 121.349, 125.203, 129.17, and 135.165). These rules ensure the safety of the operation by preventing a single point of failure.

**NOTE–**

*An aircraft approved for multi-sensor navigation and equipped with a single navigation system must maintain an ability to*

*navigate or proceed safely in the event that any one component of the navigation system fails, including the flight management system (FMS). Retaining a FMS-independent VOR capability would satisfy this requirement.*

3) The requirements for a second system apply to the entire set of equipment needed to achieve the navigation capability, not just the individual components of the system such as the radio navigation receiver. For example, to use two RNAV systems (e.g., GPS and DME/DME/IRU) to comply with the requirements, the aircraft must be equipped with two independent radio navigation receivers and two independent navigation computers (e.g., flight management systems (FMS)). Alternatively, to comply with the requirements using a single RNAV system with an installed and operable VOR capability, the VOR capability must be independent of the FMS.

4) To satisfy the requirement for two independent navigation systems, if the primary navigation system is GPS-based, the second system must be independent of GPS (for example, VOR or DME/DME/IRU). This allows continued navigation in case of failure of the GPS or WAAS services. Recognizing that GPS interference and test events resulting in the loss of GPS services have become more common, the FAA requires operators conducting IFR operations under 14 CFR 121.349, 125.203, 129.17 and 135.65 to retain a non-GPS navigation capability consisting of either DME/DME, IRU, or VOR for en route and terminal operations, and VOR and ILS for final approach. Since this system is to be used as a reversionary capability, single equipage is sufficient.

### **16.2.3 Oceanic, Domestic, En Route, and Terminal Area Operations**

**16.2.3.1** Conduct GPS IFR operations in oceanic areas only when approved avionics systems are installed. TSO-C196 users and TSO-C129 GPS users authorized for Class A1, A2, B1, B2, C1, or C2 operations may use GPS in place of another approved means of long-range navigation, such as dual INS. (See TBL ENR 4.1–4 and TBL ENR 4.1–5.) Aircraft with a single installation GPS, meeting the above specifications, are authorized to operate on short oceanic routes requiring one means of long-range navigation (reference AC 20-138, Appendix 1).

**16.2.3.2** Conduct GPS domestic, en route, and terminal IFR operations only when approved avionics systems are installed. Pilots may use GPS via TSO-C129 authorized for Class A1, B1, B3, C1, or C3 operations GPS via TSO-C196; or GPS/WAAS with either TSO-C145 or TSO-C146. When using TSO-C129 or TSO-C196 receivers, the avionics necessary to receive all of the ground-based facilities appropriate for the route to the destination airport and any required alternate airport must be installed and operational. Ground-based facilities necessary for these routes must be operational.

a) GPS en route IFR operations may be conducted in Alaska outside the operational service volume of ground-based navigation aids when a TSO-C145 or TSO-C146 GPS/wide area augmentation system (WAAS) system is installed and operating. WAAS is the U.S. version of a satellite-based augmentation system (SBAS).

1) In Alaska, aircraft may operate on GNSS Q-routes with GPS (TSO-C129 or TSO-C196) equipment while the aircraft remains in Air Traffic Control (ATC) radar surveillance or with GPS/WAAS (TSO-C145 or TSO-C146) which does not require ATC radar surveillance.

2) In Alaska, aircraft may only operate on GNSS T-routes with GPS/WAAS (TSO-C145 or TSO-C146) equipment.

b) Ground-based navigation equipment is not required to be installed and operating for en route IFR operations when using GPS/WAAS navigation systems. All operators should ensure that an alternate means of navigation is available in the unlikely event the GPS/WAAS navigation system becomes inoperative.

c) Q-routes and T-routes outside Alaska. Q-routes require system performance currently met by GPS, GPS/WAAS, or DME/DME/IRU RNAV systems that satisfy the criteria discussed in AC 90–100, U.S. Terminal and En Route Area Navigation (RNAV) Operations. T-routes require GPS or GPS/WAAS equipment.

#### **REFERENCE–**

*ENR 3.5, Paragraph 1. Airways and Route Systems.*

**16.2.3.3** GPS IFR approach/departure operations can be conducted when approved avionics systems are installed and the following requirements are met:

- a) The aircraft is TSO–C145 or TSO–C146 or TSO–C196 or TSO–C129 in Class A1, B1, B3, C1, or C3; and
- b) The approach/departure must be retrievable from the current airborne navigation database in the navigation computer. The system must be able to retrieve the procedure by name from the aircraft navigation database. Manual entry of waypoints using latitude/longitude or place/bearing is not permitted for approach procedures.
- c) The authorization to fly instrument approaches/departures with GPS is limited to U.S. airspace.
- d) The use of GPS in any other airspace must be expressly authorized by the FAA Administrator.
- e) GPS instrument approach/departure operations outside the U.S. must be authorized by the appropriate sovereign authority.

#### **16.2.4 Departures and Instrument Departure Procedures (DPs)**

The GPS receiver must be set to terminal ( $\pm 1$  NM) CDI sensitivity and the navigation routes contained in the database in order to fly published IFR charted departures and DPs. Terminal RAIM should be automatically provided by the receiver. (Terminal RAIM for departure may not be available unless the waypoints are part of the active flight plan rather than proceeding direct to the first destination.) Certain segments of a DP may require some manual intervention by the pilot, especially when radar vectored to a course or required to intercept a specific course to a waypoint. The database may not contain all of the transitions or departures from all runways and some GPS receivers do not contain DPs in the database. It is necessary that helicopter procedures be flown at 70 knots or less since helicopter departure procedures and missed approaches use a 20:1 obstacle clearance surface (OCS), which is double the fixed-wing OCS, and turning areas are based on this speed as well.

#### **16.2.5 GPS Instrument Approach Procedures**

**16.2.5.1** GPS overlay approaches are designated non-precision instrument approach procedures that pilots are authorized to fly using GPS avionics. Localizer (LOC), localizer type directional aid (LDA), and simplified directional facility (SDF) procedures are not authorized. Overlay procedures are identified by the “name of the procedure” and “or GPS” (e.g., VOR/DME or GPS RWY 15) in the title. Authorized procedures must be retrievable from a current onboard navigation database. The navigation database may also enhance position orientation by displaying a map containing information on conventional NAVAID approaches. This approach information should not be confused with a GPS overlay approach (see the receiver operating manual, AFM, or AFM Supplement for details on how to identify these approaches in the navigation database).

##### **NOTE–**

*Overlay approaches do not adhere to the design criteria described in ENR 1.5 Paragraph 12.13, Area Navigation (RNAV) Instrument Approach Charts, for stand-alone GPS approaches. Overlay approach criteria is based on the design criteria used for ground-based NAVAID approaches.*

**16.2.5.2** Stand-alone approach procedures specifically designed for GPS systems have replaced many of the original overlay approaches. All approaches that contain “GPS” in the title (e.g., “VOR or GPS RWY 24,” “GPS RWY 24,” or “RNAV (GPS) RWY 24”) can be flown using GPS. GPS-equipped aircraft do not need underlying ground-based NAVAIDs or associated aircraft avionics to fly the approach. Monitoring the underlying approach with ground-based NAVAIDs is suggested when able. Existing overlay approaches may be requested using the GPS title; for example, the VOR or GPS RWY 24 may be requested as “GPS RWY 24.” Some GPS procedures have a Terminal Arrival Area (TAA) with an underlining RNAV approach.

**16.2.5.3** For flight planning purposes, TSO-C129 and TSO-C196-equipped users (GPS users) whose navigation systems have fault detection and exclusion (FDE) capability, who perform a preflight RAIM prediction for the approach integrity at the airport where the RNAV (GPS) approach will be flown, and have proper knowledge and any required training and/or approval to conduct a GPS-based IAP, may file based on a GPS-based IAP at either the destination or the alternate airport, but not at both locations. At the alternate airport, pilots may plan for:

- a) Lateral navigation (LNAV) or circling minimum descent altitude (MDA);
- b) LNAV/vertical navigation (LNAV/VNAV) DA, if equipped with and using approved barometric vertical navigation (baro-VNAV) equipment;

c) RNP 0.3 DA on an RNAV (RNP) IAP, if they are specifically authorized users using approved baro-VNAV equipment and the pilot has verified required navigation performance (RNP) availability through an approved prediction program.

**16.2.5.4** If the above conditions cannot be met, any required alternate airport must have an approved instrument approach procedure other than GPS-based that is anticipated to be operational and available at the estimated time of arrival, and which the aircraft is equipped to fly.

#### **16.2.5.5 Procedures for Accomplishing GPS Approaches**

a) An RNAV (GPS) procedure may be associated with a Terminal Arrival Area (TAA). The basic design of the RNAV procedure is the “T” design or a modification of the “T” (See ENR 1.5, Paragraph 12.4, Terminal Arrival Area (TAA), for complete information).

b) Pilots cleared by ATC for an RNAV (GPS) approach should fly the full approach from an Initial Approach Waypoint (IAWP) or feeder fix. Randomly joining an approach at an intermediate fix does not assure terrain clearance.

c) When an approach has been loaded in the navigation system, GPS receivers will give an “arm” annunciation 30 NM straight line distance from the airport/heliport reference point. Pilots should arm the approach mode at this time if not already armed (some receivers arm automatically). Without arming, the receiver will not change from en route CDI and RAIM sensitivity of  $\pm 5$  NM either side of centerline to  $\pm 1$  NM terminal sensitivity. Where the IAWP is inside this 30 mile point, a CDI sensitivity change will occur once the approach mode is armed and the aircraft is inside 30 NM. Where the IAWP is beyond 30 NM from the airport/heliport reference point and the approach is armed, the CDI sensitivity will not change until the aircraft is within 30 miles of the airport/heliport reference point. Feeder route obstacle clearance is predicated on the receiver being in terminal ( $\pm 1$  NM) CDI sensitivity and RAIM within 30 NM of the airport/heliport reference point; therefore, the receiver should always be armed (if required) not later than the 30 NM annunciation.

d) The pilot must be aware of what bank angle/turn rate the particular receiver uses to compute turn anticipation, and whether wind and airspeed are included in the receiver’s calculations. This information should be in the receiver operating manual. Over or under banking the turn onto the final approach course may significantly delay getting on course and may result in high descent rates to achieve the next segment altitude.

e) When within 2 NM of the Final Approach Waypoint (FAWP) with the approach mode armed, the approach mode will switch to active, which results in RAIM and CDI changing to approach sensitivity. Beginning 2 NM prior to the FAWP, the full scale CDI sensitivity will smoothly change from  $\pm 1$  NM to  $\pm 0.3$  NM at the FAWP. As sensitivity changes from  $\pm 1$  NM to  $\pm 0.3$  NM approaching the FAWP, with the CDI not centered, the corresponding increase in CDI displacement may give the impression that the aircraft is moving further away from the intended course even though it is on an acceptable intercept heading. Referencing the digital track displacement information (cross track error), if it is available in the approach mode, may help the pilot remain position oriented in this situation. Being established on the final approach course prior to the beginning of the sensitivity change at 2 NM will help prevent problems in interpreting the CDI display during ramp down. Therefore, requesting or accepting vectors which will cause the aircraft to intercept the final approach course within 2 NM of the FAWP is not recommended.

f) When receiving vectors to final, most receiver operating manuals suggest placing the receiver in the non-sequencing mode on the FAWP and manually setting the course. This provides an extended final approach course in cases where the aircraft is vectored onto the final approach course outside of any existing segment which is aligned with the runway. Assigned altitudes must be maintained until established on a published segment of the approach. Required altitudes at waypoints outside the FAWP or stepdown fixes must be considered. Calculating the distance to the FAWP may be required in order to descend at the proper location.

g) Overriding an automatically selected sensitivity during an approach will cancel the approach mode annunciation. If the approach mode is not armed by 2 NM prior to the FAWP, the approach mode will not become active at 2 NM prior to the FAWP, and the equipment will flag. In these conditions, the RAIM and CDI sensitivity

will not ramp down, and the pilot should not descend to MDA, but fly to the MAWP and execute a missed approach. The approach active annunciator and/or the receiver should be checked to ensure the approach mode is active prior to the FAWP.

**h)** Do not attempt to fly an approach unless the procedure in the onboard database is current and identified as “GPS” on the approach chart. The navigation database may contain information about non–overlay approach procedures that enhances position orientation generally by providing a map, while flying these approaches using conventional NAVAIDs. This approach information should not be confused with a GPS overlay approach (see the receiver operating manual, AFM, or AFM Supplement for details on how to identify these procedures in the navigation database). Flying point to point on the approach does not assure compliance with the published approach procedure. The proper RAIM sensitivity will not be available and the CDI sensitivity will not automatically change to  $\pm 0.3$  NM. Manually setting CDI sensitivity does not automatically change the RAIM sensitivity on some receivers. Some existing non–precision approach procedures cannot be coded for use with GPS and will not be available as overlays.

**i)** Pilots should pay particular attention to the exact operation of their GPS receivers for performing holding patterns and in the case of overlay approaches, operations such as procedure turns. These procedures may require manual intervention by the pilot to stop the sequencing of waypoints by the receiver and to resume automatic GPS navigation sequencing once the maneuver is complete. The same waypoint may appear in the route of flight more than once consecutively (for example, IAWP, FAWP, MAHWP on a procedure turn). Care must be exercised to ensure that the receiver is sequenced to the appropriate waypoint for the segment of the procedure being flown, especially if one or more fly–overs are skipped (for example, FAWP rather than IAWP if the procedure turn is not flown). The pilot may have to sequence past one or more fly–overs of the same waypoint in order to start GPS automatic sequencing at the proper place in the sequence of waypoints.

**j)** Incorrect inputs into the GPS receiver are especially critical during approaches. In some cases, an incorrect entry can cause the receiver to leave the approach mode.

**k)** A fix on an overlay approach identified by a DME fix will not be in the waypoint sequence on the GPS receiver unless there is a published name assigned to it. When a name is assigned, the along track distance (ATD) to the waypoint may be zero rather than the DME stated on the approach chart. The pilot should be alert for this on any overlay procedure where the original approach used DME.

**l)** If a visual descent point (VDP) is published, it will not be included in the sequence of waypoints. Pilots are expected to use normal piloting techniques for beginning the visual descent, such as ATD.

**m)** Unnamed stepdown fixes in the final approach segment may or may not be coded in the waypoint sequence of the aircraft’s navigation database and must be identified using ATD. Stepdown fixes in the final approach segment of RNAV (GPS) approaches are being named, in addition to being identified by ATD. However, GPS avionics may or may not accommodate waypoints between the FAF and MAP. Pilots must know the capabilities of their GPS equipment and continue to identify stepdown fixes using ATD when necessary.

#### **16.2.5.6 Missed Approach**

**a)** A GPS missed approach requires pilot action to sequence the receiver past the MAWP to the missed approach portion of the procedure. The pilot must be thoroughly familiar with the activation procedure for the particular GPS receiver installed in the aircraft and must initiate appropriate action after the MAWP. Activating the missed approach prior to the MAWP will cause CDI sensitivity to immediately change to terminal ( $\pm 1$  NM) sensitivity and the receiver will continue to navigate to the MAWP. The receiver will not sequence past the MAWP. Turns should not begin prior to the MAWP. If the missed approach is not activated, the GPS receiver will display an extension of the inbound final approach course and the ATD will increase from the MAWP until it is manually sequenced after crossing the MAWP.

**b)** Missed approach routings in which the first track is via a course rather than direct to the next waypoint require additional action by the pilot to set the course. Being familiar with all of the inputs required is especially critical during this phase of flight.

### 16.2.5.7 Receiver Autonomous Integrity Monitoring (RAIM)

a) RAIM outages may occur due to an insufficient number of satellites or due to unsuitable satellite geometry which causes the error in the position solution to become too large. Loss of satellite reception and RAIM warnings may occur due to aircraft dynamics (changes in pitch or bank angle). Antenna location on the aircraft, satellite position relative to the horizon, and aircraft attitude may affect reception of one or more satellites. Since the relative positions of the satellites are constantly changing, prior experience with the airport does not guarantee reception at all times, and RAIM availability should always be checked.

b) Civilian pilots may obtain GPS RAIM availability information for nonprecision approach procedures by using a manufacturer-supplied RAIM prediction tool, or using the Service Availability Prediction Tool (SAPT) on the FAA en route and terminal RAIM prediction website. Pilots can also request GPS RAIM aeronautical information from a flight service station during preflight briefings. GPS RAIM aeronautical information can be obtained for a period of 3 hours (for example, if you are scheduled to arrive at 1215 hours, then the GPS RAIM information is available from 1100 to 1400 hours) or a 24-hour timeframe at a particular airport. FAA briefers will provide RAIM information for a period of 1 hour before to 1 hour after the ETA hour, unless a specific timeframe is requested by the pilot. If flying a published GPS departure, a RAIM prediction should also be requested for the departure airport.

c) The military provides airfield specific GPS RAIM NOTAMs for nonprecision approach procedures at military airfields. The RAIM outages are issued as M-series NOTAMs and may be obtained for up to 24 hours from the time of request.

d) Receiver manufacturers and/or database suppliers may supply “NOTAM” type information concerning database errors. Pilots should check these sources, when available, to ensure that they have the most current information concerning their electronic database.

e) If RAIM is not available, use another type of navigation and approach system, select another route or destination, or delay the trip until RAIM is predicted to be available on arrival. On longer flights, pilots should consider rechecking the RAIM prediction for the destination during the flight. This may provide an early indication that an unscheduled satellite outage has occurred since takeoff.

f) If a RAIM failure/status annunciation occurs prior to the final approach waypoint (FAWP), the approach should not be completed since GPS no longer provides the required integrity. The receiver performs a RAIM prediction by 2 NM prior to the FAWP to ensure that RAIM is available as a condition for entering the approach mode. The pilot should ensure the receiver has sequenced from “Armed” to “Approach” prior to the FAWP (normally occurs 2 NM prior). Failure to sequence may be an indication of the detection of a satellite anomaly, failure to arm the receiver (if required), or other problems which preclude flying the approach.

g) If the receiver does not sequence into the approach mode or a RAIM failure/status annunciation occurs prior to the FAWP, the pilot must not initiate the approach nor descend, but instead, proceed to the missed approach waypoint (MAWP) via the FAWP, perform a missed approach, and contact ATC as soon as practical. The GPS receiver may continue to operate after a RAIM flag/status annunciation appears, but the navigation information should be considered advisory only. Refer to the receiver operating manual for specific indications and instructions associated with loss of RAIM prior to the FAF.

h) If the RAIM flag/status annunciation appears after the FAWP, the pilot should initiate a climb and execute the missed approach. The GPS receiver may continue to operate after a RAIM flag/status annunciation appears, but the navigation information should be considered advisory only. Refer to the receiver operating manual for operating mode information during a RAIM annunciation.

### 16.2.5.8 Waypoints

a) GPS receivers navigate from one defined point to another retrieved from the aircraft’s onboard navigational database. These points are waypoints (5-letter pronounceable name), existing VHF intersections, DME fixes with 5-letter pronounceable names and 3-letter NAVAID IDs. Each waypoint is a geographical location defined by a latitude/longitude geographic coordinate. These 5-letter waypoints, VHF intersections, 5-letter

pronounceable DME fixes and 3–letter NAVAID IDs are published on various FAA aeronautical navigation products (IFR En Route Charts, VFR Charts, Terminal Procedures Publications, etc.).

b) A Computer Navigation Fix (CNF) is also a point defined by a latitude/longitude coordinate and is required to support Performance–Based Navigation (PBN) operations. The GPS receiver uses CNFs in conjunction with waypoints to navigate from point to point. However, CNFs are not recognized by ATC. ATC does not maintain CNFs in their database and they do not use CNFs for any air traffic control purpose. CNFs may or may not be charted on FAA aeronautical navigation products, are listed in the chart legends, and are for advisory purposes only. Pilots are not to use CNFs for point to point navigation (proceed direct), filing a flight plan, or in aircraft/ATC communications. CNFs that do appear on aeronautical charts allow pilots increased situational awareness by identifying points in the aircraft database route of flight with points on the aeronautical chart. CNFs are random five-letter identifiers, not pronounceable like waypoints and placed in parenthesis. Eventually, all CNFs will begin with the letters “CF” followed by three consonants (for example, CFWBG). This five-letter identifier will be found next to an “x” on en route charts and possibly on an approach chart. On instrument approach procedures (charts) in the terminal procedures publication, CNFs may represent unnamed DME fixes, beginning and ending points of DME arcs, and sensor (ground-based signal i.e., VOR, NDB, ILS) final approach fixes on GPS overlay approaches. These CNFs provide the GPS with points on the procedure that allow the overlay approach to mirror the ground-based sensor approach. These points should only be used by the GPS system for navigation and should not be used by pilots for any other purpose on the approach. The CNF concept has not been adopted or recognized by the International Civil Aviation Organization (ICAO).

c) GPS approaches use fly–over and fly–by waypoints to join route segments on an approach. Fly–by waypoints connect the two segments by allowing the aircraft to turn prior to the current waypoint in order to roll out on course to the next waypoint. This is known as turn anticipation and is compensated for in the airspace and terrain clearances. The missed approach waypoint (MAWP) will always be a fly–over waypoint. A holding waypoint will always be designed as a fly–over waypoint in the navigational database but may be charted as a fly–by event unless the holding waypoint is used for another purpose in the procedure and both events require the waypoint to be a fly–over event. Some waypoints may have dual use; for example, as a fly–by waypoint when used as an IF for a NoPT route and as a fly–over waypoint when the same waypoint is also used as an IAF/IF hold–in–lieu of PT. Since the waypoint can only be charted one way, when this situation occurs, the fly–by waypoint symbol will be charted in all uses of the waypoint.

d) Unnamed waypoints for each airport will be uniquely identified in the database. Although the identifier may be used at different airports (for example, RW36 will be the identifier at each airport with a runway 36), the actual point, at each airport, is defined by a specific latitude/longitude coordinate.

e) The runway threshold waypoint, normally the MAWP, may have a five–letter identifier (for example, SNEEZ) or be coded as RW## (for example, RW36, RW36L). MAWPs located at the runway threshold are being changed to the RW## identifier, while MAWPs not located at the threshold will have a five–letter identifier. This may cause the approach chart to differ from the aircraft database until all changes are complete. The runway threshold waypoint is also used as the center of the Minimum Safe Altitude (MSA) on most GPS approaches.

#### **16.2.5.9 Position Orientation**

Pilots should pay particular attention to position orientation while using GPS. Distance and track information are provided to the next active waypoint, not to a fixed navigation aid. Receivers may sequence when the pilot is not flying along an active route, such as when being vectored or deviating for weather, due to the proximity to another waypoint in the route. This can be prevented by placing the receiver in the non-sequencing mode. When the receiver is in the non-sequencing mode, bearing and distance are provided to the selected waypoint and the receiver will not sequence to the next waypoint in the route until placed back in the auto sequence mode or the pilot selects a different waypoint. The pilot may have to compute the ATD to stepdown fixes and other points on overlay approaches, due to the receiver showing ATD to the next waypoint rather than DME to the VOR or ILS ground station.

#### **16.2.5.10 Impact of Magnetic Variation on PBN Systems**



a) Differences may exist between PBN systems and the charted magnetic courses on ground-based NAVAID instrument flight procedures (IFP), en route charts, approach charts, and Standard Instrument Departure/Standard Terminal Arrival (SID/STAR) charts. These differences are due to the magnetic variance used to calculate the magnetic course. Every leg of an instrument procedure is first computed along a desired ground track with reference to true north. A magnetic variation correction is then applied to the true course in order to calculate a magnetic course for publication. The type of procedure will determine what magnetic variation value is added to the true course. A ground-based NAVAID IFP applies the facility magnetic variation of record to the true course to get the charted magnetic course. Magnetic courses on PBN procedures are calculated two different ways. SID/STAR procedures use the airport magnetic variation of record, while IFR en route charts use magnetic reference bearing. PBN systems make a correction to true north by adding a magnetic variation calculated with an algorithm based on aircraft position, or by adding the magnetic variation coded in their navigational database. This may result in the PBN system and the procedure designer using a different magnetic variation, which causes the magnetic course *displayed* by the PBN system and the magnetic course *charted* on the IFP plate to be different. It is important to understand, however, that PBN systems, (with the exception of VOR/DME RNAV equipment) navigate by reference to true north and display magnetic course only for pilot reference. As such, a *properly functioning* PBN system, containing a *current and accurate navigational database*, should fly the correct ground track for any loaded instrument procedure, despite differences in displayed magnetic course that may be attributed to magnetic variation application. Should significant differences between the approach chart and the PBN system avionics' application of the navigation database arise, the published approach chart, supplemented by NOTAMs, holds precedence.

b) The course into a waypoint may not always be 180 degrees different from the course leaving the previous waypoint, due to the PBN system avionics' computation of geodesic paths, distance between waypoints, and differences in magnetic variation application. Variations in distances may also occur since PBN system distance-to-waypoint values are ATDs computed to the next waypoint and the DME values published on underlying procedures are slant-range distances measured to the station. This difference increases with aircraft altitude and proximity to the NAVAID.

#### 16.2.5.11 GPS Familiarization

Pilots should practice GPS approaches in visual meteorological conditions (VMC) until thoroughly proficient with all aspects of their equipment (receiver and installation) prior to attempting flight in instrument meteorological conditions (IMC). Pilots should be proficient in the following areas:

- a) Using the receiver autonomous integrity monitoring (RAIM) prediction function;
- b) Inserting a DP into the flight plan, including setting terminal CDI sensitivity, if required, and the conditions under which terminal RAIM is available for departure;
- c) Programming the destination airport;
- d) Programming and flying the approaches (especially procedure turns and arcs);
- e) Changing to another approach after selecting an approach;
- f) Programming and flying "direct" missed approaches;
- g) Programming and flying "routed" missed approaches;
- h) Entering, flying, and exiting holding patterns, particularly on approaches with a second waypoint in the holding pattern;
- i) Programming and flying a "route" from a holding pattern;
- j) Programming and flying an approach with radar vectors to the intermediate segment;
- k) Indication of the actions required for RAIM failure both before and after the FAWP; and
- l) Programming a radial and distance from a VOR (often used in departure instructions).

TBL ENR 4.1–4  
GPS IFR Equipment Classes/Categories

TSO–C129						
Equipment Class	RAIM	Int. Nav Sys. to Prov. RAIM Equiv.	Oceanic	En Route	Terminal	Nonprecision Approach Capable
<b>Class A</b> – GPS sensor and navigation capability.						
A1	yes		yes	yes	yes	yes
A2	yes		yes	yes	yes	no
<b>Class B</b> – GPS sensor data to an integrated navigation system (i.e. FMS, multi–sensor navigation system, etc.).						
B1	yes		yes	yes	yes	yes
B2	yes		yes	yes	yes	no
B3		yes	yes	yes	yes	yes
B4		yes	yes	yes	yes	no
<b>Class C</b> – GPS sensor data to an integrated navigation system (as in Class B) which provides enhanced guidance to an autopilot, or flight director, to reduce flight tech. errors. Limited to 14 CFR Part 121 or equivalent criteria.						
C1	yes		yes	yes	yes	yes
C2	yes		yes	yes	yes	no
C3		yes	yes	yes	yes	yes
C4		yes	yes	yes	yes	no

TBL ENR 4.1–5  
GPS Approval Required/Authorized Use

Equipment Type <sup>1</sup>	Installation Approval Required	Operational Approval Required	IFR En Route <sup>2</sup>	IFR Terminal <sup>2</sup>	IFR Approach <sup>3</sup>	Oceanic Remote	In Lieu of ADF and/or DME <sup>3</sup>
Hand held <sup>4</sup>	X <sup>5</sup>						
VFR Panel Mount <sup>4</sup>	X						
IFR En Route and Terminal	X	X	X	X			X
IFR Oceanic/Remote	X	X	X	X		X	X
IFR En Route, Terminal, and Approach	X	X	X	X	X		X

**NOTE–**

<sup>1</sup>To determine equipment approvals and limitations, refer to the AFM, AFM supplements, or pilot guides.

<sup>2</sup>Requires verification of data for correctness if database is expired.

<sup>3</sup>Requires current database or verification that the procedure has not been amended since the expiration of the database.

<sup>4</sup>VFR and hand–held GPS systems are not authorized for IFR navigation, instrument approaches, or as a primary instrument flight reference. During IFR operations they may be considered only an aid to situational awareness.

<sup>5</sup>Hand–held receivers require no approval. However, any aircraft modification to support the hand–held receiver; i.e., installation of an external antenna or a permanent mounting bracket, does require approval.

## 17. Wide Area Augmentation System (WAAS)

### 17.1 General

**17.1.1** The FAA developed the WAAS to improve the accuracy, integrity and availability of GPS signals. WAAS will allow GPS to be used, as the aviation navigation system, from takeoff through approach when it is complete.

WAAS is a critical component of the FAA's strategic objective for a seamless satellite navigation system for civil aviation, improving capacity and safety.

**17.1.2** The International Civil Aviation Organization (ICAO) has defined Standards and Recommended Practices (SARPs) for satellite-based augmentation systems (SBAS) such as WAAS. India and Europe are building similar systems: EGNOS, the European Geostationary Navigation Overlay System; and India's GPS and Geo-Augmented Navigation (GAGAN) system. The merging of these systems will create an expansive navigation capability similar to GPS, but with greater accuracy, availability, and integrity.

**17.1.3** Unlike traditional ground-based navigation aids, WAAS will cover a more extensive service area. Precisely surveyed wide-area reference stations (WRS) are linked to form the U.S. WAAS network. Signals from the GPS satellites are monitored by these WRSs to determine satellite clock and ephemeris corrections and to model the propagation effects of the ionosphere. Each station in the network relays the data to a wide-area master station (WMS) where the correction information is computed. A correction message is prepared and uplinked to a geostationary earth orbit satellite (GEO) via a GEO uplink subsystem (GUS) which is located at the ground earth station (GES). The message is then broadcast on the same frequency as GPS (L1, 1575.42 MHz) to WAAS receivers within the broadcast coverage area of the WAAS GEO.

**17.1.4** In addition to providing the correction signal, the WAAS GEO provides an additional pseudorange measurement to the aircraft receiver, improving the availability of GPS by providing, in effect, an additional GPS satellite in view. The integrity of GPS is improved through real-time monitoring, and the accuracy is improved by providing differential corrections to reduce errors. The performance improvement is sufficient to enable approach procedures with GPS/WAAS glide paths (vertical guidance).

**17.1.5** The FAA has completed installation of 3 GEO satellite links, 38 WRSs, 3 WMSs, 6 GES, and the required terrestrial communications to support the WAAS network including 2 operational control centers. Prior to the commissioning of the WAAS for public use, the FAA conducted a series of test and validation activities. Future dual frequency operations are planned.

**17.1.6** GNSS navigation, including GPS and WAAS, is referenced to the WGS-84 coordinate system. It should only be used where the Aeronautical Information Publications (including electronic data and aeronautical charts) conform to WGS-84 or equivalent. Other countries civil aviation authorities may impose additional limitations on the use of their SBAS systems.

## **17.2 Instrument Approach Capabilities**

**17.2.1** A class of approach procedures which provide vertical guidance, but which do not meet the ICAO Annex 10 requirements for precision approaches has been developed to support satellite navigation use for aviation applications worldwide. These procedures are not precision and are referred to as Approach with Vertical Guidance (APV), are defined in ICAO Annex 6, and include approaches such as the LNAV/VNAV and localizer performance with vertical guidance (LPV). These approaches provide vertical guidance, but do not meet the more stringent standards of a precision approach. Properly certified WAAS receivers will be able to fly to LPV minima and LNAV/VNAV minima, using a WAAS electronic glide path, which eliminates the errors that can be introduced by using Barometric altimetry.

**17.2.2** LPV minima takes advantage of the high accuracy guidance and increased integrity provided by WAAS. This WAAS generated angular guidance allows the use of the same TERPS approach criteria used for ILS approaches. LPV minima may have a decision altitude as low as 200 feet height above touchdown with visibility minimums as low as  $\frac{1}{2}$  mile, when the terrain and airport infrastructure support the lowest minima. LPV minima is published on the RNAV (GPS) approach charts (see paragraph 12., Instrument Approach Procedure Charts).

**17.2.3** A different WAAS-based line of minima, called Localizer Performance (LP) is being added in locations where the terrain or obstructions do not allow publication of vertically guided LPV minima. LP takes advantage of the angular lateral guidance and smaller position errors provided by WAAS to provide a lateral only procedure similar to an ILS Localizer. LP procedures may provide lower minima than a LNAV procedure due to the narrower obstacle clearance surface.

**NOTE–**

WAAS receivers certified prior to TSO–C145b and TSO–C146b, even if they have LPV capability, do not contain LP capability unless the receiver has been upgraded. Receivers capable of flying LP procedures must contain a statement in the Aircraft Flight Manual (AFM), AFM Supplement, or Approved Supplemental Flight Manual stating that the receiver has LP capability, as well as the capability for the other WAAS and GPS approach procedure types.

**17.2.4** WAAS provides a level of service that supports all phases of flight, including RNAV (GPS) approaches to LNAV, LP, LNAV/VNAV and LPV lines of minima, within system coverage. Some locations close to the edge of the coverage may have a lower availability of vertical guidance.

**17.3 General Requirements**

**17.3.1** WAAS avionics must be certified in accordance with Technical Standard Order (TSO) TSO–C145, Airborne Navigation Sensors Using the (GPS) Augmented by the Wide Area Augmentation System (WAAS); or TSO–C146, Stand–Alone Airborne Navigation Equipment Using the Global Positioning System (GPS) Augmented by the Wide Area Augmentation System (WAAS), and installed in accordance with Advisory Circular (AC) 20–138, *Airworthiness Approval of Positioning and Navigation Systems*.

**17.3.2** GPS/WAAS operation must be conducted in accordance with the FAA–approved aircraft flight manual (AFM) and flight manual supplements. Flight manual supplements will state the level of approach procedure that the receiver supports. IFR approved WAAS receivers support all GPS only operations as long as lateral capability at the appropriate level is functional. WAAS monitors both GPS and WAAS satellites and provides integrity.

**17.3.3** GPS/WAAS equipment is inherently capable of supporting oceanic and remote operations if the operator obtains a fault detection and exclusion (FDE) prediction program.

**17.3.4** Air carrier and commercial operators must meet the appropriate provisions of their approved operations specifications.

**17.3.5** Prior to GPS/WAAS IFR operation, the pilot must review appropriate Notices to Air Missions (NOTAMs) and aeronautical information. This information is available on request from an Automated Flight Service Station. The FAA will provide NOTAMs to advise pilots of the status of the WAAS and level of service available.

**17.3.5.1** The term MAY NOT BE AVBL is used in conjunction with WAAS NOTAMs and indicates that due to ionospheric conditions, lateral guidance may still be available when vertical guidance is unavailable. Under certain conditions, both lateral and vertical guidance may be unavailable. This NOTAM language is an advisory to pilots indicating the expected level of WAAS service (LNAV/VNAV, LPV, LP) may not be available.

**EXAMPLE–**

*/FDC FDC NAV WAAS VNAV/LPV/LP MINIMA MAY NOT BE AVBL 1306111330-1306141930EST*

or

*/FDC FDC NAV WAAS VNAV/LPV MINIMA NOT AVBL, WAAS LP MINIMA MAY NOT BE AVBL 1306021200-1306031200EST*

WAAS MAY NOT BE AVBL NOTAMs are predictive in nature and published for flight planning purposes. Upon commencing an approach at locations NOTAMed WAAS MAY NOT BE AVBL, if the WAAS avionics indicate LNAV/VNAV or LPV service is available, then vertical guidance may be used to complete the approach using the displayed level of service. Should an outage occur during the approach, reversion to LNAV minima or an alternate instrument approach procedure may be required. When GPS testing NOTAMs are published and testing is actually occurring, Air Traffic Control will advise pilots requesting or cleared for a GPS or RNAV (GPS) approach that GPS may not be available and request intentions. If pilots have reported GPS anomalies, Air Traffic Control will request the pilot’s intentions and/or clear the pilot for an alternate approach, if available and operational.

**17.3.5.2** WAAS area-wide NOTAMs are originated when WAAS assets are out of service and impact the service area. Area–wide WAAS NOT AVAILABLE (AVBL) NOTAMs indicate loss or malfunction of the WAAS system. In flight, Air Traffic Control will advise pilots requesting a GPS or RNAV (GPS) approach of WAAS NOT AVBL NOTAMs if not contained in the ATIS broadcast.

**EXAMPLE–**

*For unscheduled loss of signal or service, an example NOTAM is: !FDC FDC NAV WAAS NOT AVBL 1311160600–1311191200EST.*

*For scheduled loss of signal or service, an example NOTAM is: !FDC FDC NAV WAAS NOT AVBL 1312041015–1312082000EST*

**17.3.5.3** Site–specific WAAS MAY NOT BE AVBL NOTAMs indicate an expected level of service; for example, LNAV/VNAV, LP, or LPV may not be available. Pilots must request site–specific WAAS NOTAMs during flight planning. In flight, Air Traffic Control will not advise pilots of WAAS MAY NOT BE AVBL NOTAMs.

**NOTE–**

*Though currently unavailable, the FAA is updating its prediction tool software to provide this site-service in the future.*

**17.3.5.4** Most of North America has redundant coverage by two or more geostationary satellites. One exception is the northern slope of Alaska. If there is a problem with the satellite providing coverage to this area, a NOTAM similar to the following example will be issued:

**EXAMPLE–**

*!FDC 4/3406 (PAZA A0173/14) ZAN NAV WAAS SIGNAL MAY NOT BE AVBL NORTH OF LINE FROM 7000N15000W TO 6400N16400W. RMK WAAS USERS SHOULD CONFIRM RAIM AVAILABILITY FOR IFR OPERATIONS IN THIS AREA. T-ROUTES IN THIS SECTOR NOT AVBL. ANY REQUIRED ALTERNATE AIRPORT IN THIS AREA MUST HAVE AN APPROVED INSTRUMENT APPROACH PROCEDURE OTHER THAN GPS THAT IS ANTICIPATED TO BE OPERATIONAL AND AVAILABLE AT THE ESTIMATED TIME OF ARRIVAL AND WHICH THE AIRCRAFT IS EQUIPPED TO FLY. 1406030812–1406050812EST .*

**17.3.6** When GPS–testing NOTAMs are published and testing is actually occurring, Air Traffic Control will advise pilots requesting or cleared for a GPS or RNAV (GPS) approach that GPS may not be available and request intentions. If pilots have reported GPS anomalies, Air Traffic Control will request the pilot’s intentions and/or clear the pilot for an alternate approach, if available and operational.

**EXAMPLE–**

*Here is an example of a GPS testing NOTAM:*

*!GPS 06/001 ZAB NAV GPS (INCLUDING WAAS, GBAS, AND ADS-B) MAY NOT BE AVAILABLE WITHIN A 468NM RADIUS CENTERED AT 330702N1062540W (TCS 093044) FL400–UNL DECREASING IN AREA WITH A DECREASE IN ALTITUDE DEFINED AS: 425NM RADIUS AT FL250, 360NM RADIUS AT 10000FT, 354NM RADIUS AT 4000FT AGL, 327NM RADIUS AT 50FT AGL. 1406070300–1406071200.*

**17.3.7** When the approach chart is annotated with the **W** symbol, site–specific WAAS MAY NOT BE AVBL NOTAMs or Air Traffic advisories are not provided for outages in WAAS LNAV/VNAV and LPV vertical service. Vertical outages may occur daily at these locations due to being close to the edge of WAAS system coverage. Use LNAV or circling minima for flight planning at these locations, whether as a destination or alternate. For flight operations at these locations, when the WAAS avionics indicate that LNAV/VNAV or LPV service is available, then the vertical guidance may be used to complete the approach using the displayed level of service. Should an outage occur during the procedure, reversion to LNAV minima may be required.

**NOTE–**

*Area–wide WAAS NOT AVBL NOTAMs apply to all airports in the WAAS NOT AVBL area designated in the NOTAM, including approaches at airports where an approach chart is annotated with the **W** symbol.*

**17.3.8** GPS/WAAS was developed to be used within GEO coverage over North America without the need for other radio navigation equipment appropriate to the route of flight to be flown. Outside the WAAS coverage or in the event of a WAAS failure, GPS/WAAS equipment reverts to GPS–only operation and satisfies the requirements for basic GPS equipment. (See ENR 4.1 paragraph 17. for these requirements).

**17.3.9** Unlike TSO–C129 avionics, which were certified as a supplement to other means of navigation, WAAS avionics are evaluated without reliance on other navigation systems. As such, installation of WAAS avionics does not require the aircraft to have other equipment appropriate to the route to be flown. (See ENR 4.1 paragraph 17. for more information on equipment requirements.)

**17.3.9.1** Pilots with WAAS receivers may flight plan to use any instrument approach procedure authorized for use with their WAAS avionics as the planned approach at a required alternate, with the following restrictions. When using WAAS at an alternate airport, flight planning must be based on flying the RNAV (GPS) LNAV or circling minima line, or minima on a GPS approach procedure, or conventional approach procedure with “or GPS” in the title. Code of Federal Regulation (CFR) Part 91 nonprecision weather requirements must be used for planning. Upon arrival at an alternate, when the WAAS navigation system indicates that LNAV/VNAV or LPV service is available, then vertical guidance may be used to complete the approach using the displayed level of service. The FAA has begun removing the **▲ NA** (Alternate Minimums Not Authorized) symbol from select RNAV (GPS) and GPS approach procedures so they may be used by approach approved WAAS receivers at alternate airports. Some approach procedures will still require the **▲ NA** for other reasons, such as no weather reporting, so it cannot be removed from all procedures. Since every procedure must be individually evaluated, removal of the **▲ NA** from RNAV (GPS) and GPS procedures will take some time.

**NOTE–**

*Properly trained and approved, as required, TSO-C145 and TSO-C146 equipped users (WAAS users) with and using approved baro-VNAV equipment may plan for LNAV/VNAV DA at an alternate airport. Specifically authorized WAAS users with and using approved baro-VNAV equipment may also plan for RNP 0.3 DA at the alternate airport as long as the pilot has verified RNP availability through an approved prediction program.*

**17.4 Flying procedures with WAAS**

**17.4.1** WAAS receivers support all basic GPS approach functions and provide additional capabilities. One of the major improvements is the ability to generate glide path guidance, independent of ground equipment or barometric aiding. This eliminates several problems such as hot and cold temperature effects, incorrect altimeter setting or lack of a local altimeter source. It also allows approach procedures to be built without the cost of installing ground stations at each airport or runway. Some approach certified receivers may only generate a glide path with performance similar to Baro-VNAV and are only approved to fly the LNAV/VNAV line of minima on the RNAV (GPS) approach charts. Receivers with additional capability (including faster update rates and smaller integrity limits) are approved to fly the LPV line of minima. The lateral integrity changes dramatically from the 0.3 NM (556 meter) limit for GPS, LNAV and LNAV/VNAV approach mode, to 40 meters for LPV. It also provides vertical integrity monitoring, which bounds the vertical error to 50 meters for LNAV/VNAV and LPVs with minima of 250’ or above, and bounds the vertical error to 35 meters for LPVs with minima below 250’.

**17.4.2** When an approach procedure is selected and active, the receiver will notify the pilot of the most accurate level of service supported by the combination of the WAAS signal, the receiver, and the selected approach, using the naming conventions on the minima lines of the selected approach procedure. For example, if an approach is published with LPV minima and the receiver is only certified for LNAV/VNAV, the equipment would indicate “LNAV/VNAV available,” even though the WAAS signal would support LPV. If flying an existing LNAV/VNAV procedure with no LPV minima, the receiver will notify the pilot “LNAV/VNAV available,” even if the receiver is certified for LPV and the signal supports LPV. If the signal does not support vertical guidance on procedures with LPV and/or LNAV/VNAV minima, the receiver annunciation will read “LNAV available.” On lateral only procedures with LP and LNAV minima the receiver will indicate “LP available” or “LNAV available” based on the level of lateral service available. Once the level of service notification has been given, the receiver will operate in this mode for the duration of the approach procedure, unless that level of service becomes unavailable. The receiver cannot change back to a more accurate level of service until the next time an approach is activated.

**NOTE–**

*Receivers do not “fail down” to lower levels of service once the approach has been activated. If only the vertical off flag appears, the pilot may elect to use the LNAV minima if the rules under which the flight is operating allow changing the type of approach being flown after commencing the procedure. If the lateral integrity limit is exceeded on an LP approach, a missed approach will be necessary since there is no way to reset the lateral alarm limit while the approach is active.*

**17.4.3** Another additional feature of WAAS receivers is the ability to exclude a bad GPS signal and continue operating normally. This is normally accomplished by the WAAS correction information. Outside WAAS

coverage or when WAAS is not available, it is accomplished through a receiver algorithm called FDE. In most cases this operation will be invisible to the pilot since the receiver will continue to operate with other available satellites after excluding the “bad” signal. This capability increases the reliability of navigation.

**17.4.4** Both lateral and vertical scaling for the LNAV/VNAV and LPV approach procedures are different than the linear scaling of basic GPS. When the complete published procedure is flown,  $\pm 1$  NM linear scaling is provided until two (2) NM prior to the FAF, where the sensitivity increases to be similar to the angular scaling of an ILS. There are two differences in the WAAS scaling and ILS: 1) on long final approach segments, the initial scaling will be  $\pm 0.3$  NM to achieve equivalent performance to GPS (and better than ILS, which is less sensitive far from the runway); 2) close to the runway threshold, the scaling changes to linear instead of continuing to become more sensitive. The width of the final approach course is tailored so that the total width is usually 700 feet at the runway threshold. Since the origin point of the lateral splay for the angular portion of the final is not fixed due to antenna placement like localizer, the splay angle can remain fixed, making a consistent width of final for aircraft being vectored onto the final approach course on different length runways. When the complete published procedure is not flown, and instead the aircraft needs to capture the extended final approach course similar to ILS, the vector to final (VTF) mode is used. Under VTF, the scaling is linear at  $\pm 1$  NM until the point where the ILS angular splay reaches a width of  $\pm 1$  NM regardless of the distance from the FAWP.

**17.4.5** The WAAS scaling is also different than GPS TSO–C129 in the initial portion of the missed approach. Two differences occur here. First, the scaling abruptly changes from the approach scaling to the missed approach scaling, at approximately the departure end of the runway or when the pilot selects missed approach guidance rather than ramping as GPS does. Second, when the first leg of the missed approach is a Track to Fix (TF) leg aligned within 3 degrees of the inbound course, the receiver will change to 0.3 NM linear sensitivity until the turn initiation point for the first waypoint in the missed approach procedure, at which time it will abruptly change to terminal ( $\pm 1$  NM) sensitivity. This allows the elimination of close in obstacles in the early part of the missed approach that may otherwise cause the DA to be raised.

**17.4.6** There are two ways to select the final approach segment of an instrument approach. Most receivers use menus where the pilot selects the airport, the runway, the specific approach procedure and finally the IAF, there is also a channel number selection method. The pilot enters a unique 5–digit number provided on the approach chart, and the receiver recalls the matching final approach segment from the aircraft database. A list of information including the available IAFs is displayed and the pilot selects the appropriate IAF. The pilot should confirm that the correct final approach segment was loaded by cross checking the Approach ID, which is also provided on the approach chart.

**17.4.7** The Along–Track Distance (ATD) during the final approach segment of an LNAV procedure (with a minimum descent altitude) will be to the MAWP. On LNAV/VNAV and LPV approaches to a decision altitude, there is no missed approach waypoint so the along–track distance is displayed to a point normally located at the runway threshold. In most cases, the MAWP for the LNAV approach is located on the runway threshold at the centerline, so these distances will be the same. This distance will always vary slightly from any ILS DME that may be present, since the ILS DME is located further down the runway. Initiation of the missed approach on the LNAV/VNAV and LPV approaches is still based on reaching the decision altitude without any of the items listed in 14 CFR Section 91.175 being visible, and must not be delayed while waiting for the ATD to reach zero. The WAAS receiver, unlike a GPS receiver, will automatically sequence past the MAWP if the missed approach procedure has been designed for RNAV. The pilot may also select missed approach prior to the MAWP; however, navigation will continue to the MAWP prior to waypoint sequencing taking place.

## **18. Ground Based Augmentation System (GBAS) Landing System (GLS)**

**18.1** A GBAS ground installation at an airport can provide localized, differential augmentation to the Global Positioning System (GPS) signal–in–space enabling an aircraft’s GLS precision approach capability. Through the GBAS service and the aircraft’s GLS installation a pilot may complete an instrument approach offering three–dimensional angular lateral, and vertical guidance for exact alignment and descent to a runway. The operational benefits of a GLS approach are similar to the benefits of an ILS or LPV approach operation.

**NOTE–**

*To remain consistent with international terminology, the FAA will use the term GBAS in place of the former term Local Area Augmentation System (LAAS).*

**18.2** An aircraft's GLS approach capability relies on the broadcast from a GBAS Ground Facility (GGF) installation. The GGF installation includes at least four ground reference stations near the airport's runway(s), a corrections processor, and a VHF Data Broadcast (VDB) uplink antenna. To use the GBAS GGF output and be eligible to conduct a GLS approach, the aircraft requires eligibility to conduct RNP approach (RNP APCH) operations and must meet the additional, specific airworthiness requirements for installation of a GBAS receiver intended to support GLS approach operations. When the aircraft achieves GLS approach eligibility, the aircraft's onboard navigation database may then contain published GLS instrument approach procedures.

**18.3** During a GLS instrument approach procedure, the installation of an aircraft's GLS capability provides the pilot three-dimensional (3D) lateral and vertical navigation guidance much like an ILS instrument approach. GBAS corrections augment the GPS signal-in-space by offering position corrections, ensures the availability of enhanced integrity parameters, and then transmits the actual approach path definition over the VDB uplink antenna. A single GBAS ground station can support multiple GLS approaches to one or more runways.

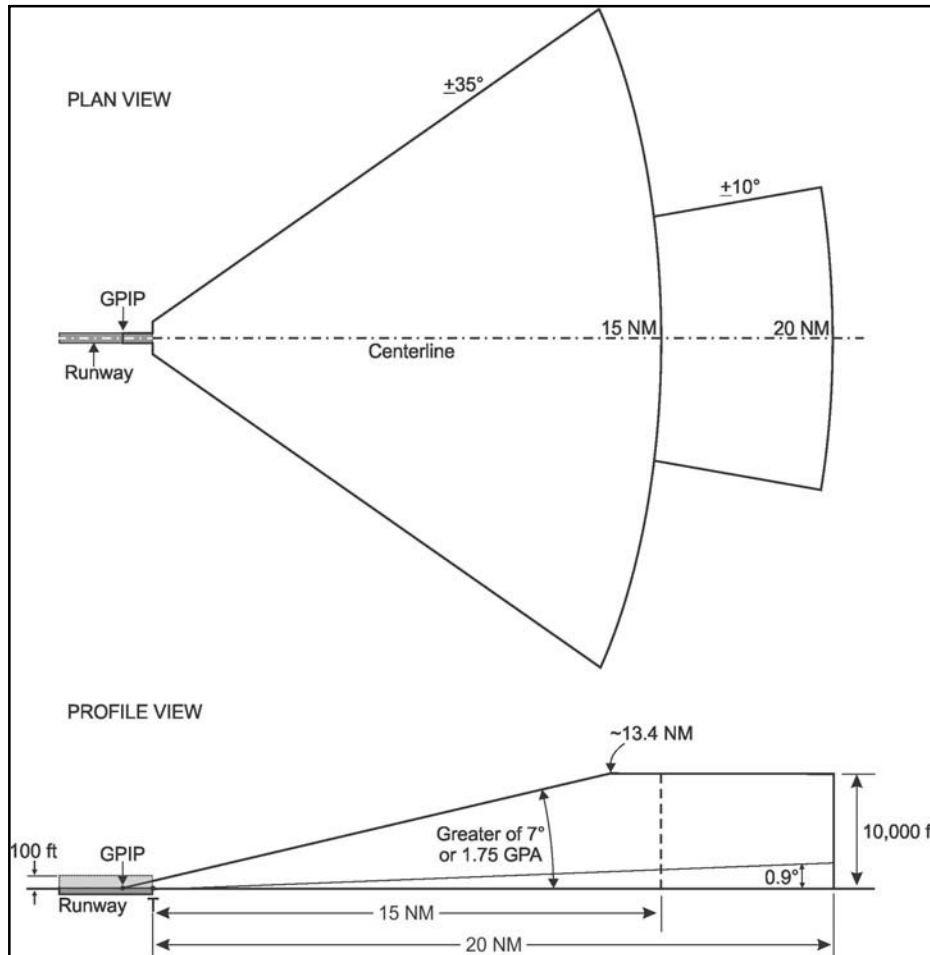
**18.4** Through the GBAS ground station, a GLS approach offers a unique operational service volume distinct from the traditional ILS approach service volume (see FIG ENR 4.1–4). However, despite the unique service volume, in the final approach segment, a GLS approach provides precise 3D angular lateral and vertical guidance mimicking the precision guidance of an ILS approach.

**18.5** Transitions to and segments of the published GLS instrument approach procedures may rely on use of RNAV 1 or RNP 1 prior to an IAF. Then, during the approach procedure prior to the aircraft entering the GLS approach mode, a GLS approach procedure design uses the RNP APCH procedure design criteria to construct the procedural path (the criteria used to publish procedures titled "RNAV (GPS)" in the US). Thus, a GLS approach procedure may include paths requiring turns after the aircraft crosses the IAF, prior to the aircraft's flight guidance entering the GLS approach flight guidance mode. Likewise, the missed approach procedure for a GLS approach procedure relies exclusively on the same missed approach criteria supporting an RNP APCH.

**18.6** When maneuvering the aircraft in compliance with an ATC clearance to intercept a GLS approach prior to the final approach segment (e.g. "being vectored"), the pilot should adhere to the clearance and ensure the aircraft intercepts the extended GLS final approach course within the specified service volume. Once on the GLS final approach course, the pilot should ensure the aircraft is in the GLS approach mode prior to reaching the procedure's glidepath intercept point. Once the aircraft is in the GLS flight guidance mode and captures the GLS glidepath, the pilot should fly the GLS final approach segment using the same pilot techniques they use to fly an ILS final approach or the final approach of an RNAV (GPS) approach flown to LPV minimums. See also the Instrument Procedures Handbook for more information on how to conduct a GLS instrument approach procedure.



FIG ENR 4.1-4  
GLS Standard Approach Service Volume



## 19. Precision Approach Systems Other than ILS and GLS

### 19.1 General

Approval and use of precision approach systems other than ILS and GLS require the issuance of special instrument approach procedures.

### 19.2 Special Instrument Approach Procedure

**19.2.1** Special instrument approach procedures must be issued to the aircraft operator if pilot training, aircraft equipment, and/or aircraft performance is different than published procedures. Special instrument approach procedures are not distributed for general public use. These procedures are issued to an aircraft operator when the conditions for operations approval are satisfied.

**19.2.2** General aviation operators requesting approval for special procedures should contact the local Flight Standards District Office to obtain a letter of authorization. Air carrier operators requesting approval for use of special procedures should contact their Certificate Holding District Office for authorization through their Operations Specification.

## 20. Area Navigation

### 20.1 General

**20.1.1** Area Navigation (RNAV) provides enhanced navigational capability to the pilot. RNAV equipment can compute the airplane position, actual track and ground speed and then provide meaningful information relative to a route of flight selected by the pilot. Typical equipment will provide the pilot with distance, time, bearing and crosstrack error relative to the selected “TO” or “active” waypoint and the selected route. Several navigational systems with different navigational performance characteristics are capable of providing area navigational functions. Present day RNAV includes INS, VOR/DME, and GPS systems. Modern multi-sensor systems can integrate one or more of the above systems to provide a more accurate and reliable navigational system. Due to the different levels of performance, area navigational capabilities can satisfy different levels of required navigation performance (RNP).

## **20.2 RNAV Operations Incorporating RNP**

**20.2.1** During the past four decades, domestic and international air navigation have been conducted using a system of airways and instrument procedures based upon ground-based navigational systems such as NDB, VOR, and ILS. Reliance on ground-based navigational systems has served the aviation community well, but often results in less than optimal routes or instrument procedures and an inefficient use of airspace. With the widespread deployment of RNAV systems and the advent of GPS-based navigation, greater flexibility in defining routes, procedures, and airspace design is now possible with an associated increase in flight safety. To capitalize on the potential of RNAV systems, both the FAA and International Civil Aviation Organization (ICAO) are affecting a shift toward a new standard of navigation and airspace management called RNP.

**20.2.2** Navigational systems are typically described as being sensor specific, such as a VOR or ILS system. By specifying airspace requirements as RNP, various navigation systems or combination of systems may be used as long as the aircraft can achieve the RNP. RNP is intended to provide a single performance standard that can be used and applied by aircraft and aircraft equipment manufacturers, airspace planners, aircraft certification and operations, pilots and controllers, and international aviation authorities. RNP can be applied to obstacle clearance or aircraft separation requirements to ensure a consistent application level.

**20.2.3** ICAO has defined RNP values for the four typical navigation phases of flight: oceanic, en route, terminal, and approach. The RNP applicable to a selected airspace, route, or procedure is designated by its RNP Level or Type. As defined in the Pilot/Controller Glossary, the RNP Level or Type is a value typically expressed as a distance, in nautical miles, from the procedure, route or path within which an aircraft would typically operate. RNP applications also provide performance to protect against larger errors at some multiple of RNP level (e.g., twice the RNP level).

## **20.3 Standard RNP Levels**

**20.3.1** U.S. standard values supporting typical RNP airspace are as specified in TBL ENR 4.1–6 below. Other RNP levels as identified by ICAO, other states and the FAA may also be used.

*TBL ENR 4.1–6*  
**U.S. Standard RNP Levels**

<b>RNP Level</b>	<b>Typical Application</b>
.3	Approach
1	Departure, Terminal
2	En Route

**20.3.1.1 Application of Standard RNP Levels.** U.S. standard levels of RNP typically used for various routes and procedures supporting RNAV operations may be based on use of a specific navigational system or sensor such as GPS, or on multi-sensor RNAV systems having suitable performance. New RNAV routes and procedures will be FAA’s first public use procedures to include a specified RNP level. These procedures are being developed based on earth referenced navigation and do not rely on conventional ground-based navigational aids. Unless otherwise noted on affected charts or procedures, depiction of a specified RNP level will not preclude the use of other airborne RNAV navigational systems.

**20.3.1.2 Depiction of Standard RNP Levels.** The applicable RNP level will be depicted on affected charts and procedures. For example, an RNAV departure procedure may contain a notation referring to eligible aircraft by equipment suffix and a phrase “or RNP–1.0.” A typical RNAV approach procedure may include a notation referring to eligible aircraft by specific navigation sensor(s), equipment suffix, and a phrase “or RNP–0.3.” Specific guidelines for the depiction of RNP levels will be provided through chart bulletins and accompany affected charting changes.

**20.4 Aircraft and Airborne Equipment Eligibility for RNP Operations.** Aircraft meeting RNP criteria will have an appropriate entry including special conditions and limitations, if any, in its Aircraft/Rotorcraft Flight Manual (AFM), or supplement. RNAV installations with AFM–RNP certification based on GPS or systems integrating GPS are considered to meet U.S. standard RNP levels for all phases of flight. Aircraft with AFM–RNP certification without GPS may be limited to certain RNP levels, or phases of flight. For example, RNP based on DME/DME without other augmentation may not be appropriate for phases of flight outside the certified DME service volume. Operators of aircraft not having specific AFM–RNP certification may be issued operational approval including special conditions and limitations, if any, for specific RNP levels. Aircraft navigation systems eligible for RNP airspace will be indicated on charts, or announced through other FAA media such as NOTAMs and chart bulletins.

**20.5 Understanding RNP Operations.** Pilots should have a clear understanding of the aircraft requirements for operation in a given RNP environment, and advise ATC if an equipment failure or other malfunction causes the aircraft to lose its ability to continue operating in the designated RNP airspace. When a pilot determines a specified RNP level cannot be achieved, he/she should be prepared to revise the route, or delay the operation until an appropriate RNP level can be ensured. Some airborne systems use terms other than RNP to indicate the current level of performance. Depending on the airborne system implementation, this may be displayed, and referred to, as actual navigation performance (ANP), estimate of position error (EPE), or other.

**20.6 Other RNP Applications Outside the U.S.** The FAA, in cooperation with ICAO member states has led initiatives in implementing the RNP concept to oceanic operations. For example, RNP–10 routes have been established in the Northern Pacific (NOPAC) which has increased capacity and efficiency by reducing the distance between tracks to 50 NM. Additionally, the FAA has assisted those U.S. air carriers operating in Europe where the routes have been designated as RNP–5. TBL ENR 4.1–7 below, shows examples of current and future RNP levels of airspace.

*TBL ENR 4.1–7*  
**RNP Levels Supported for International Operations**

RNP Level	Typical Application
4	Oceanic/remote areas where performance–based horizontal separation is applied
5	European Basic RNAV (B–RNAV)
10	Oceanic/remote areas where performance–based horizontal separation is applied

## **20.7 RNAV and RNP Operations**

### **20.7.1 Pilot**

**20.7.1.1** If unable to comply with the requirements of an RNAV or RNP procedure, pilots must advise air traffic control as soon as possible. For example, “N1234, failure of GPS system, unable RNAV, request amended clearance.”

**20.7.1.2** Pilots are not authorized to fly a published RNAV or RNP procedure (instrument approach, departure, or arrival procedure) unless it is retrievable by the procedure name from the current aircraft navigation database and conforms to the charted procedure. The system must be able to retrieve the procedure by name from the aircraft navigation database, not just as a manually entered series of waypoints.

**20.7.1.3** Whenever possible, RNAV routes (Q- or T-route) should be extracted from the database in their entirety, rather than loading RNAV route waypoints from the database into the flight plan individually. However, selecting and inserting individual, named fixes from the database is permitted, provided all fixes along the published route to be flown are inserted.

**20.7.1.4** Pilots must not change any database waypoint type from a fly-by to fly-over, or vice versa. No other modification of database waypoints or the creation of user-defined waypoints on published RNAV or RNP procedures is permitted, except to:

a) Change altitude and/or airspeed waypoint constraints to comply with an ATC clearance/ instruction.

b) Insert a waypoint along the published route to assist in complying with ATC instruction, example, “Descend via the WILMS arrival except cross 30 north of BRUCE at/or below FL 210.” This is limited only to systems that allow along-track waypoint construction.

**20.7.1.5** Pilots of FMS-equipped aircraft, who are assigned an RNAV DP or STAR procedure and subsequently receive a change of runway, transition or procedure, must verify that the appropriate changes are loaded and available for navigation.

**20.7.1.6** For RNAV 1 DPs and STARs, pilots must use a CDI, flight director and/or autopilot, in lateral navigation mode. Other methods providing an equivalent level of performance may also be acceptable.

**20.7.1.7** For RNAV 1 DPs and STARs, pilots of aircraft without GPS, using DME/DME/IRU, must ensure the aircraft navigation system position is confirmed, within 1,000 feet, at the start point of take-off roll. The use of an automatic or manual runway update is an acceptable means of compliance with this requirement. Other methods providing an equivalent level of performance may also be acceptable.

**20.7.1.8** For procedures or routes requiring the use of GPS, if the navigation system does not automatically alert the flight crew of a loss of GPS, the operator must develop procedures to verify correct GPS operation.

**20.7.1.9** RNAV terminal procedures (DP and STAR) may be amended by ATC issuing radar vectors and/or clearances direct to a waypoint. Pilots should avoid premature manual deletion of waypoints from their active “legs” page to allow for rejoining procedures.

**20.7.1.10** RAIM Prediction: If TSO-C129 equipment is used to solely satisfy the RNAV and RNP requirement, GPS RAIM availability must be confirmed for the intended route of flight (route and time). If RAIM is not available, pilots need an approved alternate means of navigation.

**REFERENCE–**

AIP, ENR 1.10, Para 11.3, RNAV and RNP Operations.

**20.7.1.11 Definition of “established” for RNAV and RNP operations:** An aircraft is considered to be established on-course during RNAV and RNP operations anytime it is within 1 times the required accuracy for the segment being flown. For example, while operating on a Q-Route (RNAV 2), the aircraft is considered to be established on-course when it is within 2 nm of the course centerline.

**NOTE–**

*Pilots must be aware of how their navigation system operates, along with any AFM limitations, and confirm that the aircraft’s lateral deviation display (or map display if being used as an allowed alternate means) is suitable for the accuracy of the segment being flown. Automatic scaling and alerting changes are appropriate for some operations. For example, TSO-C129 systems change within 30 miles of destination and within 2 miles of FAF to support approach operations. For some navigation systems and operations, manual selection of scaling will be necessary.*

*(a) Pilots flying FMS equipped aircraft with barometric vertical navigation (Baro-VNAV) may descend when the aircraft is established on-course following FMS leg transition to the next segment. Leg transition normally occurs at the turn bisector for a fly-by waypoint (reference paragraph 1-2-1 for more on waypoints). When using full automation, pilots should monitor the aircraft to ensure the aircraft is turning at appropriate lead times and descending once established on-course.*

*(b) Pilots flying TSO-C129 navigation system equipped aircraft without full automation should use normal lead points to begin the turn. Pilots may descend when established on-course on the next segment of the approach.*

## 21. NAVAID Identifier Removal During Maintenance

**21.1** During periods of routine or emergency maintenance, coded identification (or code and voice, where applicable) is removed from certain FAA NAVAIDs. Removal of the identification serves as warning to pilots that the facility is officially off the air for tune-up or repair and may be unreliable even though intermittent or constant signals are received.

**NOTE–**

*During periods of maintenance, VHF ranges may radiate a T–E–S–T code (– ● ● ● ● –).*

**NOTE–**

*DO NOT attempt to fly a procedure that is NOTAMed out of service even if the identification is present. In certain cases, the identification may be transmitted for short periods as part of the testing.*

## 22. User Reports Requested on NAVAID Outages

**22.1** Users of the National Airspace System (NAS) can render valuable assistance in the early correction of NAVAID malfunctions or GNSS problems and are encouraged to report their observations of undesirable avionics performance. Although NAVAIDs are monitored by electronic detectors, adverse effects of electronic interference, new obstructions or changes in terrain near the NAVAID can exist without detection by the ground monitors. Some of the characteristics of malfunction or deteriorating performance which should be reported are: erratic course or bearing indications; intermittent, or full, flag alarm; garbled, missing or obviously improper coded identification; poor quality communications reception; or, in the case of frequency interference, an audible hum or tone accompanying radio communications or NAVAID identification. GNSS problems are often characterized by navigation degradation or service loss indications. For instance, pilots conducting operations in areas where there is GNSS interference may be unable to use GPS for navigation, and ADS–B may be unavailable for surveillance. Radio frequency interference may affect both navigation for the pilot and surveillance by the air traffic controller. Depending on the equipment and integration, either an advisory light or message may alert the pilot. Air traffic controllers monitoring ADS–B reports may stop receiving ADS–B position messages and associated aircraft tracks.

**22.2** Malfunctioning, faulty, inappropriately installed, operated, or modified GPS re–radiator systems, intended to be used for aircraft maintenance activities, have resulted in unintentional disruption of aviation GPS receivers. This type of disruption could result in unflagged, erroneous position–information output to primary flight displays/indicators and to other aircraft and air traffic control systems. Since Receiver Autonomous Integrity Monitoring (RAIM) is only partially effective against this type of disruption (effectively a “signal spoofing”), the pilot may not be aware of any erroneous navigation indications; ATC may be the only means available to identify these disruptions and detect unexpected aircraft positions while monitoring aircraft for IFR separation.

**22.3** Pilots encountering navigation error events should transition to another source of navigation and request amended clearances from ATC as necessary.

**22.4** Pilots are encouraged to submit detailed reports of NAVAID or GPS anomaly as soon as practical. Pilot reports of navigation error events should contain the following information:

**22.4.1** Date and time the anomaly was observed, and NAVAID ID (or GPS).

**22.4.2** Location of the aircraft at the time the anomaly started and ended (e.g., latitude/longitude or bearing/distance from a reference point),

**22.4.3** Heading, altitude, type of aircraft (make/model/call sign).

**22.4.4** Type of avionics/receivers in use (e.g., make/model/software series or version).

**22.4.5** Number of satellites being tracked, if applicable.

**22.4.6** Description of the position/navigation/timing condition observed; and duration of the event.

**22.4.7** Consequences/operational impact(s) of the NAVAID or GPS loss.

**22.4.8** Actions taken to mitigate the anomaly and/or remedy provided by the ATC facility.

**22.4.9** Post flight pilot/maintenance actions taken.

**22.5** Pilots operating an aircraft in controlled airspace under IFR shall comply with CFR § 91.187 and promptly report as soon as practical to ATC any malfunctions of navigational equipment occurring in-flight; pilots should submit initial reports:

**22.5.1** Immediately, by radio to the controlling ATC facility or FSS.

**22.5.2** By telephone to the nearest ATC facility controlling the airspace where the disruption was experienced.

**22.5.3** Additionally, GPS problems should be reported, post flight, by Internet via the GPS Anomaly Reporting Form at [http://www.faa.gov/air\\_traffic/nas/gps\\_reports/](http://www.faa.gov/air_traffic/nas/gps_reports/).

**22.6** To minimize ATC workload, GPS interference/outages associated with known testing NOTAMs should NOT be reported in-flight to ATC in detail; EXCEPT when:

**22.6.1** GPS degradation is experienced outside the NOTAMed area.

**22.6.2** Pilot observes any unexpected consequences (e.g., equipment failure, suspected spoofing, failure of other aircraft systems not identified in AFM, such as TAWS).

### **23. Radio Communications and Navigation Facilities**

**23.1** A complete listing of air traffic radio communications facilities and frequencies and radio navigation facilities and frequencies are contained in the Chart Supplement U.S. Similar information for the Pacific and Alaskan areas is contained in the Chart Supplements Pacific and Alaska.

## ENR 4.2 Special Navigation Systems

### 1. Doppler Radar

**1.1** Doppler Radar is a semiautomatic self-contained dead reckoning navigation system (radar sensor plus computer) which is not continuously dependent on information derived from ground based or external aids. The system employs radar signals to detect and measure ground speed and drift angle, using the aircraft compass system as its directional reference. Doppler is less accurate than INS, however, and the use of an external reference is required for periodic updates if acceptable position accuracy is to be achieved on long range flights.





## ENR 5. NAVIGATION WARNINGS

### ENR 5.1 Prohibited, Restricted, and Other Areas

#### 1. Special Use Airspace

##### 1.1 General

**1.1.1** Special use airspace (SUA) consists of that airspace wherein activities must be confined because of their nature, or wherein limitations are imposed upon aircraft operations that are not a part of those activities, or both. SUA areas are depicted on aeronautical charts, except for controlled firing areas (CFA), temporary military operations areas (MOA), and temporary restricted areas.

**1.1.2** Prohibited and restricted areas are regulatory special use airspace and are established in 14 CFR Part 73 through the rulemaking process.

**1.1.3** Warning areas, MOAs, alert areas, CFAs, and national security areas (NSA) are nonregulatory special use airspace.

**1.1.4** Special use airspace descriptions (except CFAs) are contained in FAA Order JO 7400.10, Special Use Airspace.

**1.1.5** Permanent SUA (except CFAs) is charted on Sectional Aeronautical, VFR Terminal Area, and applicable En Route charts, and include the hours of operation, altitudes, and the controlling agency.

##### 1.2 Prohibited Areas

**1.2.1** Prohibited areas contain airspace of defined dimensions identified by an area on the surface of the earth within which the flight of aircraft is prohibited. Such areas are established for security or other reasons associated with the national welfare. These areas are published in the Federal Register and are depicted on aeronautical charts.

##### 1.3 Restricted Areas

**1.3.1** Restricted areas contain airspace identified by an area on the surface of the earth within which the flight of aircraft, while not wholly prohibited, is subject to restrictions. Activities within these areas must be confined because of their nature or limitations imposed upon aircraft operations that are not a part of those activities or both. Restricted areas denote the existence of unusual, often invisible, hazards to aircraft such as artillery firing, aerial gunnery, or guided missiles. Penetration of restricted areas without authorization from the using or controlling agency may be extremely hazardous to the aircraft and its occupants. Restricted areas are published in the Federal Register and constitute 14 CFR Part 73.

**1.3.2** ATC facilities apply the following procedures when aircraft are operating on an IFR clearance (including those cleared by ATC to maintain VFR-on-top) via a route which lies within joint-use restricted airspace.

**1.3.2.1** If the restricted area is not active and has been released to the controlling agency (FAA), the ATC facility will allow the aircraft to operate in the restricted airspace without issuing specific clearance for it to do so.

**1.3.2.2** If the restricted area is active and has not been released to the controlling agency (FAA), the ATC facility will issue a clearance which will ensure the aircraft avoids the restricted airspace unless it is on an approved altitude reservation mission or has obtained its own permission to operate in the airspace and so informs the controlling facility.

**NOTE-**

*The above apply only to joint-use restricted airspace and not to prohibited and nonjoint-use airspace. For the latter categories, the ATC facility will issue a clearance so the aircraft will avoid the restricted airspace unless it is on an approved altitude reservation mission or has obtained its own permission to operate in the airspace and so informs the controlling facility.*

**1.3.3** Permanent restricted areas are charted on Sectional Aeronautical, VFR Terminal Area, and the appropriate En Route charts.

**NOTE-**

*Temporary restricted areas are not charted. For temporary restricted areas, pilots should review the Domestic Notices found in the External Links section of the Federal NOTAM System (FNS) NOTAM Search or Air Traffic Plans and Publications website, the FAA SUA website, and/or contact the appropriate overlying ATC facility to determine the effect of non-depicted SUA areas along their routes of flight.*

**1.4 Warning Areas**

**1.4.1** A warning area is airspace of defined dimensions, extending from three nautical miles outward from the coast of the U.S., that contains activity that may be hazardous to nonparticipating aircraft. The purpose of such warning areas is to warn nonparticipating pilots of the potential danger. A warning area may be located over domestic or international waters or both.

**2. Other Airspace Areas**

**2.1 National Security Areas**

**2.1.1** NSAs consist of airspace of defined vertical and lateral dimensions established at locations where there is a requirement for increased security and safety of ground facilities. Pilots are requested to voluntarily avoid flying through the depicted NSA. When it is necessary to provide a greater level of security and safety, flight in NSAs may be temporarily prohibited by regulation under the provisions of 14 CFR Section 99.7. Regulatory prohibitions will be issued by System Operations Security and disseminated via NOTAM. Inquiries about NSAs should be directed to System Operations Security.

**2.2 Temporary Flight Restrictions**

**2.2.1 General.** This paragraph describes the types of conditions under which the FAA may impose temporary flight restrictions. It also explains which FAA elements have been delegated authority to issue a temporary flight restrictions NOTAM and lists the types of responsible agencies/offices from which the FAA will accept requests to establish temporary flight restrictions. The 14 CFR is explicit as to what operations are prohibited, restricted, or allowed in a temporary flight restrictions area. Pilots are responsible to comply with 14 CFR Sections 91.137, 91.138, 91.141, and 91.143 when conducting flight in an area where a temporary flight restrictions area is in effect, and should check appropriate NOTAMs during flight planning.

**2.2.2 The purpose for establishing a temporary flight restrictions area is to:**

**2.2.2.1** Protect persons and property in the air or on the surface from an existing or imminent hazard associated with an incident on the surface when the presence of low-flying aircraft would magnify, alter, spread, or compound that hazard (14 CFR Section 91.137(a)(1)).

**2.2.2.2** Provide a safe environment for the operation of disaster relief aircraft (14 CFR Section 91.137(a)(2)).

**2.2.2.3** Prevent an unsafe congestion of sightseeing aircraft above an incident or event which may generate a high degree of public interest (14 CFR Section 91.137(a)(3)).

**2.2.2.4** Protect declared national disasters for humanitarian reasons in the State of Hawaii (14 CFR Section 91.138).

**2.2.2.5** Protect the President, Vice President, or other public figures (14 CFR Section 91.141).

**2.2.2.6** Provide a safe environment for space agency operations (14 CFR Section 91.143).

**2.2.3** Except for hijacking situations, when the provisions of 14 CFR Section 91.137(a)(1) or (a)(2) are necessary, a temporary flight restrictions area will only be established by or through the area manager at the Air Route Traffic Control Center (ARTCC) having jurisdiction over the area concerned. A temporary flight restrictions NOTAM involving the conditions of 14 CFR Section 91.137(a)(3) will be issued at the direction of the service area office director having oversight of the airspace concerned. When hijacking situations are

involved, a temporary flight restrictions area will be implemented through the TSA Aviation Command Center. The appropriate FAA air traffic element, upon receipt of such a request, will establish a temporary flight restrictions area under 14 CFR Section 91.137(a)(1).

**2.2.4** The FAA accepts recommendations for the establishment of a temporary flight restrictions area under 14 CFR Section 91.137(a)(1) from military major command headquarters, regional directors of the Office of Emergency Planning, Civil Defense State Directors, State Governors, or other similar authority. For the situations involving 14 CFR Section 91.137(a)(2), the FAA accepts recommendations from military commanders serving as regional, subregional, or Search and Rescue (SAR) coordinators; by military commanders directing or coordinating air operations associated with disaster relief; or by civil authorities directing or coordinating organized relief air operations (includes representatives of the Office of Emergency Planning, U.S. Forest Service, and State aeronautical agencies). Appropriate authorities for a temporary flight restrictions establishment under 14 CFR Section 91.137(a)(3) are any of those listed above or by State, county, or city government entities.

**2.2.5** The type of restrictions issued will be kept to a minimum by the FAA consistent with achievement of the necessary objective. Situations which warrant the extreme restrictions of 14 CFR Section 91.137(a)(1) include, but are not limited to: toxic gas leaks or spills, flammable agents, or fumes which if fanned by rotor or propeller wash could endanger persons or property on the surface, or if entered by an aircraft could endanger persons or property in the air; imminent volcano eruptions which could endanger airborne aircraft and occupants; nuclear accident or incident; and hijackings. Situations which warrant the restrictions associated with 14 CFR Section 91.137(a)(2) include: forest fires which are being fought by releasing fire retardants from aircraft; and aircraft relief activities following a disaster (earthquake, tidal wave, flood, etc.). 14 CFR Section 91.137 (a)(3) restrictions are established for events and incidents that would attract an unsafe congestion of sightseeing aircraft.

**2.2.6** The amount of airspace needed to protect persons and property or provide a safe environment for rescue/relief aircraft operations is normally limited to within 2,000 feet above the surface and within a 3-nautical-mile radius. Incidents occurring within Class B, Class C, or Class D airspace will normally be handled through existing procedures and should not require the issuance of a temporary flight restrictions NOTAM. Temporary flight restrictions affecting airspace outside of the U.S. and its territories and possessions are issued with verbiage excluding that airspace outside of the 12-mile coastal limits.

**2.2.7** The FSS nearest the incident site is normally the “coordination facility.” When FAA communications assistance is required, the designated FSS will function as the primary communications facility for coordination between emergency control authorities and affected aircraft. The ARTCC may act as liaison for the emergency control authorities if adequate communications cannot be established between the designated FSS and the relief organization. For example, the coordination facility may relay authorizations from the on-scene emergency response official in cases where news media aircraft operations are approved at the altitudes used by relief aircraft.

**2.2.8** ATC may authorize operations in a temporary flight restrictions area under its own authority only when flight restrictions are established under 14 CFR Section 91.137(a)(2) and (a)(3). The appropriate ARTCC/airport traffic control tower manager will, however, ensure that such authorized flights do not hamper activities or interfere with the event for which restrictions were implemented. However, ATC will not authorize local IFR flights into the temporary flight restrictions area.

**2.2.9** To preclude misunderstanding, the implementing NOTAM will contain specific and formatted information. The facility establishing a temporary flight restrictions area will format a NOTAM beginning with the phrase “FLIGHT RESTRICTIONS” followed by: the location of the temporary flight restrictions area; the effective period; the area defined in statute miles; the altitudes affected; the FAA coordination facility and commercial telephone number; the reason for the temporary flight restrictions; the agency directing any relief activities and its commercial telephone number; and other information considered appropriate by the issuing authority.

**EXAMPLE-**

**1.** 14 CFR Section 91.137(a)(1):

*The following NOTAM prohibits all aircraft operations except those specified in the NOTAM.*

*FLIGHT RESTRICTIONS MATTHEWS, VIRGINIA, EFFECTIVE IMMEDIATELY UNTIL 9610211200. PURSUANT TO 14 CFR SECTION 91.137(A)(1) TEMPORARY FLIGHT RESTRICTIONS ARE IN EFFECT. RESCUE OPERATIONS IN PROGRESS. ONLY RELIEF AIRCRAFT OPERATIONS UNDER THE DIRECTION OF THE DEPARTMENT OF DEFENSE ARE AUTHORIZED IN THE AIRSPACE AT AND BELOW 5,000 FEET MSL WITHIN A 2-NAUTICAL-MILE RADIUS OF LASER AFB, MATTHEWS, VIRGINIA. COMMANDER, LASER AFB, IN CHARGE (897) 946-5543 (122.4). STEENSON FSS (792) 555-6141 (123.1) IS THE FAA COORDINATION FACILITY.*

**2. 14 CFR Section 91.137(a)(2):**

*The following NOTAM permits flight operations in accordance with 14 CFR Section 91.137(a)(2). The on-site emergency response official to authorize media aircraft operations below the altitudes used by the relief aircraft.*

*FLIGHT RESTRICTIONS 25 MILES EAST OF BRANSOME, IDAHO, EFFECTIVE IMMEDIATELY UNTIL 9601202359 UTC. PURSUANT TO 14 CFR SECTION 91.137(A)(2) TEMPORARY FLIGHT RESTRICTIONS ARE IN EFFECT WITHIN A 4-NAUTICAL-MILE RADIUS OF THE INTERSECTION OF COUNTY ROADS 564 AND 315 AT AND BELOW 3,500 FEET MSL TO PROVIDE A SAFE ENVIRONMENT FOR FIRE FIGHTING AIRCRAFT OPERATIONS. DAVIS COUNTY SHERIFF'S DEPARTMENT (792) 555-8122 (122.9) IS IN CHARGE OF ON-SCENE EMERGENCY RESPONSE ACTIVITIES. GLIVINGS FSS (792) 555-1618 (122.2) IS THE FAA COORDINATION FACILITY.*

**3. 14 CFR Section 91.137(a)(3):**

*The following NOTAM prohibits sightseeing aircraft operations.*

*FLIGHT RESTRICTIONS BROWN, TENNESSEE, DUE TO OLYMPIC ACTIVITY. EFFECTIVE 9606181100 UTC UNTIL 9607190200 UTC. PURSUANT TO 14 CFR SECTION 91.137(A)(3) TEMPORARY FLIGHT RESTRICTIONS ARE IN EFFECT WITHIN A 3-NAUTICAL-MILE RADIUS OF N355783/W835242 AND VOLUNTEER VORTAC 019 DEGREE RADIAL 3.7 DME FIX AT AND BELOW 2,500 FEET MSL. NORTON FSS (423) 555-6742 (126.6) IS THE FAA COORDINATION FACILITY.*

**4. 14 CFR Section 91.138:**

*The following NOTAM prohibits all aircraft except those operating under the authorization of the official in charge of associated emergency or disaster relief response activities, aircraft carrying law enforcement officials, aircraft carrying personnel involved in an emergency or legitimate scientific purposes, carrying properly accredited news media, and aircraft operating in accordance with an ATC clearance or instruction.*

*FLIGHT RESTRICTIONS KAPALUA, HAWAII, EFFECTIVE 9605101200 UTC UNTIL 9605151500 UTC. PURSUANT TO 14 CFR SECTION 91.138 TEMPORARY FLIGHT RESTRICTIONS ARE IN EFFECT WITHIN A 3-NAUTICAL-MILE RADIUS OF N205778/W1564038 AND MAUI /OGG/ VORTAC 275 DEGREE RADIAL AT 14.1 NAUTICAL MILES. JOHN DOE 808-757-4469 OR 122.4 IS IN CHARGE OF THE OPERATION. HONOLULU /HNL/ 808-757-4470 (123.6) FSS IS THE FAA COORDINATION FACILITY.*

**5. 14 CFR Section 91.141:**

*The following NOTAM prohibits all aircraft.*

*FLIGHT RESTRICTIONS STILLWATER, OKLAHOMA, JUNE 21, 1996. PURSUANT TO 14 CFR SECTION 91.141 AIRCRAFT FLIGHT OPERATIONS ARE PROHIBITED WITHIN A 3-NAUTICAL-MILE RADIUS, BELOW 2000 FEET AGL OF N360962/ W970515 AND THE STILLWATER /SWO/ VOR/DME 176 DEGREE RADIAL 3.8-NAUTICAL-MILE FIX FROM 1400 LOCAL TIME TO 1700 LOCAL TIME JUNE 21, 1996 UNLESS OTHERWISE AUTHORIZED BY ATC.*

**6. 14 CFR Section 91.143:**

*The following NOTAM prohibits any aircraft of U.S. registry, or pilot of any aircraft under the authority of an airman certificate issued by the FAA.*

*KENNEDY SPACE CENTER SPACE OPERATIONS AREA EFFECTIVE IMMEDIATELY UNTIL 9610152100 UTC. PURSUANT TO SECTION 91.143, FLIGHT OPERATIONS CONDUCTED BY FAA CERTIFICATED PILOTS OR CONDUCTED IN AIRCRAFT OF U.S. REGISTRY ARE PROHIBITED AT ANY ALTITUDE FROM SURFACE TO*

UNLIMITED, WITHIN THE FOLLOWING AREA 30–NAUTICAL–MILE RADIUS OF THE MELBOURNE (MLB)/VORTAC 010 DEGREE RADIAL 21–NAUTICAL–MILE FIX. ST. PETERSBURG, FLORIDA, (PIE) FSS 813–545–1645 (122.2) IS THE FAA COORDINATION FACILITY AND SHOULD BE CONTACTED FOR THE CURRENT STATUS OF ANY AIRSPACE ASSOCIATED WITH THE SPACE SHUTTLE OPERATIONS. THIS AIRSPACE ENCOMPASSES R2933, R2932, R2931, R2934, R2935, W497A AND W158A. ADDITIONAL WARNING AND RESTRICTED AREAS WILL BE ACTIVE IN CONJUNCTION WITH THE OPERATIONS. PILOTS MUST CONSULT ALL NOTAMS REGARDING THIS OPERATION.

### 2.3 Parachute Jump Aircraft Operations

**2.3.1** Procedures relating to parachute jump areas are contained in 14 CFR Part 105. Tabulations of parachute jump areas in the U.S. are contained in the Chart Supplement U.S.

**2.3.2** Pilots of aircraft engaged in parachute jump operations are reminded that all reported altitudes must be with reference to mean sea level, or flight level, as appropriate, to enable ATC to provide meaningful traffic information.

**2.3.3 Parachute Operations in the Vicinity of an Airport Without an Operating Control Tower.** There is no substitute for alertness while in the vicinity of an airport. It is essential that pilots conducting parachute operations be alert, look for other traffic, and exchange traffic information as recommended in GEN 3.3, paragraph 9.2, Traffic Advisory Practices at Airports Without Operating Control Towers. In addition, pilots should avoid releasing parachutes while in an airport traffic pattern when there are other aircraft in that pattern. Pilots should make appropriate broadcasts on the designated Common Traffic Advisory Frequency (CTAF), and monitor that CTAF until all parachute activity has terminated or the aircraft has left the area. Prior to commencing a jump operation, the pilot should broadcast the aircraft's altitude and position in relation to the airport, the approximate relative time when the jump will commence and terminate, and listen to the position reports of other aircraft in the area.

### 2.4 Special Air Traffic Rules (SATR) and Special Flight Rules Area (SFRA)

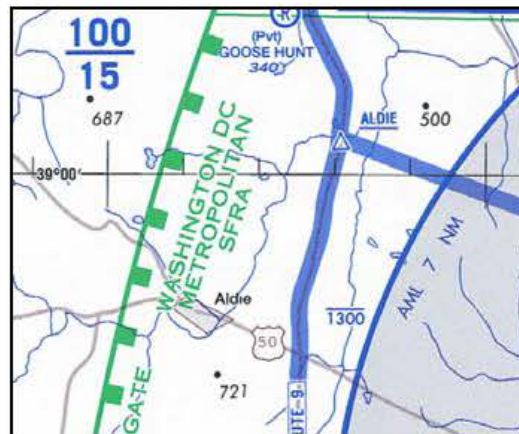
**2.4.1 Background.** The Code of Federal Regulations (CFR) prescribes special air traffic rules for aircraft operating within the boundaries of certain designated airspace. These areas are listed in 14 CFR Part 93 and can be found throughout the NAS. Procedures, nature of operations, configuration, size, and density of traffic vary among the identified areas.

**2.4.2 SFRAs.** Airspace of defined dimensions, above land areas or territorial waters, within which the flight of aircraft is subject to the rules set forth in 14 CFR Part 93, unless otherwise authorized by air traffic control. Not all areas listed in 14 CFR Part 93 are designated SFRA, but special air traffic rules apply to all areas described in 14 CFR Part 93.

**2.4.3 Participation.** Each person operating an aircraft to, from, or within airspace designated as a SATR area or SFRA must adhere to the special air traffic rules set forth in 14 CFR Part 93, as applicable, unless otherwise authorized or required by ATC.

**2.4.4 Charts.** SFRAs are depicted on VFR sectional, terminal area, and helicopter route charts. (See FIG ENR 5.1–1.)

FIG ENR 5.1-1  
SFRA Boundary



**2.4.5 Washington DC Special Flight Rules Area (SFRA) including the Flight Restricted Zone (FRZ).** A pilot conducting any type of flight operation in the Washington DC SFRA/FRZ must comply with the requirements in:

**2.4.5.1** 14 CFR Section 93.339 Washington, DC Metropolitan Area Special Flight Rules Area including the FRZ.

**2.4.5.2** 14 CFR Section 91.161 Special Awareness Training for the DC SFRA/FRZ, also located on the FAA website at <https://www.faasafety.gov/>.

**2.4.5.3** Any 14 CFR Section 99.7 special security instructions for the DC SFRA/FRZ published via NOTAM by FAA in the interest of national security.

## 2.5 Weather Reconnaissance Area (WRA)

**2.5.1 General.** Hurricane Hunters from the United States Air Force Reserve 53<sup>rd</sup> Weather Reconnaissance Squadron (WRS) and the National Oceanic and Atmospheric Administration (NOAA) Aircraft Operations Center (AOC) operate weather reconnaissance/research aircraft missions, in support of the National Hurricane Operations Plan (NHOP), to gather meteorological data on hurricanes and tropical cyclones. 53<sup>rd</sup> WRS and NOAA AOC aircraft normally conduct these missions in airspace identified in a published WRA Notice to Air Missions (NOTAM).

**2.5.2 WRAs.** Airspace with defined dimensions and published by a NOTAM, which is established to support weather reconnaissance/research flights. ATC services are not provided within WRAs. Only participating weather reconnaissance/research aircraft from the 53<sup>rd</sup> WRS and NOAA AOC are permitted to operate within a WRA. A WRA may only be established in airspace within U. S. Flight Information Regions (FIR) outside of U. S. territorial airspace.

**2.5.3** A published WRA NOTAM describes the airspace dimensions of the WRA and the expected activities within the WRA. WRAs may border adjacent foreign FIRs, but are wholly contained within U.S. FIRs. As ATC services are not provided within a WRA, non-participating aircraft should avoid WRAs, and IFR aircraft should expect to be rerouted to avoid WRAs.

## ENR 5.2 Military Exercise and Training Areas

### 1. Military Operations Area (MOA)

**1.1** MOAs consist of airspace of defined vertical and lateral limits established for the purpose of separating certain military training activities from IFR traffic. Whenever a MOA is being used, nonparticipating IFR traffic may be cleared through a MOA if IFR separation can be provided by ATC. Otherwise, ATC will reroute or restrict nonparticipating IFR traffic.

**1.2** Examples of activities conducted in MOAs include, but are not limited to: air combat tactics, air intercepts, aerobatics, formation training, and low-altitude tactics. Military pilots flying in an active MOA are exempted from the provisions of 14 CFR Section 91.303(c) and (d) which prohibits aerobatic flight within Class D and Class E surface areas, and within Federal airways. Additionally, the Department of Defense has been issued an authorization to operate aircraft at indicated airspeeds in excess of 250 knots below 10,000 feet MSL within active MOAs.

**1.3** Pilots operating under VFR should exercise extreme caution while flying within a MOA when military activity is being conducted. The activity status (active/inactive) of MOAs may change frequently. Therefore, pilots should contact any FSS within 100 miles of the area to obtain accurate real-time information concerning the MOA hours of operation. Prior to entering an active MOA, pilots should contact the controlling agency for traffic advisories.

**1.4** Permanent MOAs are charted on Sectional Aeronautical, VFR Terminal Area, and the appropriate En Route Low Altitude charts.

**NOTE-**

*Temporary MOAs are not charted. For temporary restricted areas, pilots should review the Domestic Notices found in the External Links section of the Federal NOTAM System (FNS) NOTAM Search or Air Traffic Plans and Publications website, the FAA SUA website, and/or contact the appropriate overlying ATC facility to determine the effect of non-depicted SUA areas along their routes of flight.*

### 2. Alert Areas

**2.1** Alert Areas are depicted on aeronautical charts to inform nonparticipating pilots of areas that may contain a high volume of pilot training or an unusual type of aerial activity. Pilots should be particularly alert when flying in these areas. All activity within an Alert Area must be conducted in accordance with FAA regulations, without waiver, and pilots of participating aircraft as well as pilots transiting the area must be equally responsible for collision avoidance.

### 3. Controlled Firing Area (CFA)

**3.1** CFAs contain activities which, if not conducted in a controlled environment, could be hazardous to nonparticipating aircraft. The distinguishing feature of the CFA, as compared to other special use airspace, is that its activities are suspended immediately when spotter aircraft, radar, or ground lookout positions indicate an aircraft might be approaching the area. There is no need to chart CFAs since they do not cause a nonparticipating aircraft to change its flight path.

### 4. Military Training Route (MTR)

**4.1** National security depends largely on the deterrent effect of our airborne military forces. To be proficient, the military services must train in a wide range of airborne tactics. One phase of this training involves “low level” combat tactics. The required maneuvers and high speeds are such that they may occasionally make the see-and-avoid aspect of VFR flight more difficult without increased vigilance in areas containing such operations. In an effort to ensure the greatest practical level of safety for all flight operations, the MTR program was conceived.

**4.2** The MTR program is a joint venture by the FAA and the DOD. MTRs are mutually developed for use by the military for the purpose of conducting low–altitude, high–speed training. The routes above 1,500 feet above ground level (AGL) are developed to be flown, to the maximum extent possible, under IFR. The routes at 1,500 feet AGL and below are generally developed to be flown under VFR.

**4.3** Generally, MTRs are established below 10,000 feet MSL for operations at speeds in excess of 250 knots. However, route segments may be defined at higher altitudes for purposes of route continuity. For example, route segments may be defined for descent, climbout, and mountainous terrain. There are IFR and VFR routes as follows:

**4.3.1 IFR Military Training Routes–IR.** Operations on these routes are conducted in accordance with IFR regardless of weather conditions.

**4.3.2 VFR Military Training Routes–VR.** Operations on these routes are conducted in accordance with VFR except flight visibility must be 5 miles or more; and flights must not be conducted below a ceiling of less than 3,000 feet AGL.

**4.4** MTRs will be identified and charted as follows:

#### **4.4.1 Route Identification**

**4.4.1.1** MTRs with no segment above 1,500 feet AGL must be identified by four number characters; e.g., IR1206, VR1207.

**4.4.1.2** MTRs that include one or more segments above 1,500 feet AGL must be identified by three number characters; e.g., IR206, VR207.

**4.4.1.3** Alternate IR/VR routes or route segments are identified by using the basic/principal route designation followed by a letter suffix, e.g., IR008A, VR1007B, etc.

#### **4.4.2 Route Charting**

**4.4.2.1 IFR Enroute Low Altitude Chart.** This chart will depict all IR routes and all VR routes that accommodate operations above 1,500 feet AGL.

**4.4.2.2 VFR Sectional Aeronautical Charts.** These charts will depict military training activities such as IR and VR information.

**4.4.2.3 Area Planning (AP/1B) Chart (DOD Flight Information Publication–FLIP).** This chart is published by the National Geospatial–Intelligence Agency (NGA) primarily for military users and contains detailed information on both IR and VR routes.

**4.5** DoD FLIP– Department of Defense Flight Information Publications describe IR/VR routes through charts and narratives, and the FAA provides information regarding these routes to all users via IFR and VFR charts.

#### **NOTE–**

*DoD users that require copies of FLIP, should contact:*

*Defense Logistics Agency for Aviation  
Mapping Customer Operations (DLA AVN/QAM)  
8000 Jefferson Davis Highway  
Richmond, VA 23297–5339  
Toll free phone: 1–800–826–0342  
Commercial: 804–279–6500*

MTR information from the FLIP is available for pilot briefings through Flight Service. (See subparagraph 4.6.1 below.)

**4.6** Availability of MTR information.

**4.6.1** Pilots may obtain preflight MTR information through Flight Service. (See paragraph ENR 1.10–1., Preflight Preparation.)



**4.6.2** MTR routes are depicted on IFR En Route Low Altitude Charts and VFR Sectional Aeronautical Charts, which are downloaded free and available on the FAA website at [https://www.faa.gov/air\\_traffic/flight\\_info/aeronav/digital\\_products/](https://www.faa.gov/air_traffic/flight_info/aeronav/digital_products/).

**4.7** Nonparticipating aircraft are not prohibited from flying within an MTR; however, extreme vigilance should be exercised when conducting flight through or near these routes. Pilots, while inflight, should contact the FSS within 100 NM of a particular MTR to obtain current information or route usage in their vicinity. Information available includes times of scheduled activity, altitudes in use on each route segment, and actual route width. Route width varies for each MTR and can extend several miles on either side of the charted MTR centerline. Route width information for IFR Military Training Route (IR) and VFR Military Training Route (VR) MTRs is also available in the FLIP AP/1B along with additional MTR (slow routes/air refueling routes) information. When requesting MTR information, pilots should give the FSS their position, route of flight, and destination in order to reduce frequency congestion and permit the FSS specialist to identify the MTR which could be a factor.



## ENR 5.3 [RESERVED]



## ENR 5.4 [RESERVED]



## ENR 5.5 [RESERVED]





## ENR 5.6 Bird Migration and Areas With Sensitive Fauna

### 1. Migratory Bird Activity

**1.1** Bird strike risk increases because of bird migration during the months of March through April and August through November.

**1.2** The altitudes of migrating birds vary with winds aloft, weather fronts, terrain elevations, cloud conditions, and other environmental variables. While over 90 percent of the reported bird strikes occur at or below 3,000 feet AGL, strikes at higher altitudes are common during migration. Ducks and geese are frequently observed up to 7,000 feet AGL and pilots are cautioned to minimize en route flying at lower altitudes during migration.

**1.3** Considered the greatest potential hazard to aircraft because of their size, abundance, or habit of flying in dense flocks are gulls, waterfowl, vultures, hawks, owls, egrets, blackbirds, and starlings. Four major migratory flyways exist in the U.S. The Atlantic Flyway parallels the Atlantic coast, the Mississippi Flyway stretches from Canada through the Great Lakes and follows the Mississippi River. The Central Flyway represents a broad area east of the Rockies, stretching from Canada through Central America. The Pacific Flyway follows the west coast and overflies major parts of Washington, Oregon, and California. There are also numerous smaller flyways which cross these major north-south migratory routes.

### 2. Reducing Bird Strike Risks

**2.1** The most serious strikes are those involving ingestion into an engine (turboprop and turbine jet engines) or windshield strikes. These strikes can result in emergency situations requiring prompt action by the pilot.

**2.2** Engine ingestions may result in sudden loss of power or engine failure. Review engine out procedures, especially when operating from airports with known bird hazards or when operating near high bird concentrations.

**2.3** Windshield strikes have resulted in pilots experiencing confusion, disorientation, loss of communications, and aircraft control problems. Pilots are encouraged to review their emergency procedures before flying in these areas.

**2.4** When encountering birds en route, climb to avoid collision because birds in flocks generally distribute themselves downward, with lead birds being at the highest altitude.

**2.5** Avoid overflight of known areas of bird concentration and flying low altitudes during bird migration. Charted wildlife refuges and other natural areas contain unusually high local concentration of birds which may create a hazard to aircraft.

### 3. Reporting Bird Strikes

**3.1** Pilots are urged to report any bird or other wildlife strike using FAA Form 5200-7, Bird/Other Wildlife Strike Report (FIG ENR 5.6-1). Forms are available at any FSS or any FAA Regional Office. Wildlife strikes can also be reported electronically at: [https://www.faa.gov/airports/airport\\_safety/wildlife/](https://www.faa.gov/airports/airport_safety/wildlife/). The data derived from these reports are used to develop standards to cope with this potential hazard to aircraft and for documentation of necessary habitat control on airports.

### 4. Reporting Bird and Other Wildlife Activities

**4.1** If you observe birds or other animals on or near the runway, request airport management to disperse the wildlife before taking off. Also contact the nearest FAA ARTCC, FSS, or tower (including non-Federal towers) regarding large flocks of birds and report the:

- 4.1.1 Geographic location.
- 4.1.2 Bird type (geese, ducks, gulls, etc.).
- 4.1.3 Approximate numbers.
- 4.1.4 Altitude.
- 4.1.5 Direction of bird flight path.

## 5. Pilot Advisories on Bird and Other Wildlife Hazards

5.1 Many airports advise pilots of other wildlife hazards caused by large animals on the runway through the Chart Supplement U.S. and the NOTAM system. Collisions between landing and departing aircraft with animals on the runway are increasing and are not limited to rural airports. These accidents have also occurred at several major airports. Pilots should exercise extreme caution when warned of the presence of wildlife on and in the vicinity of airports. If in close proximity to movement areas you observe deer or other large animals, advise the FSS, tower, or airport management.

## 6. Flights Over Charted U.S. Wildlife Refuges, Parks, and Forest Service Areas

6.1 The landing of aircraft is prohibited on lands or waters administered by the National Park Service, U.S. Fish and Wildlife Service, or U.S. Forest Service without authorization from the respective agency. Exceptions include (1) when forced to land due to an emergency beyond the control of the operator, (2) at officially designated landing sites, or (3) an approved official business of the Federal Government.

6.2 All pilots are requested to maintain a minimum altitude of 2,000 feet above the terrain of the following: National Parks, Monuments, Seashores, Lakeshores, Recreation Areas and Scenic Riverways administered by the National Park Service, National Wildlife Refuges, Big Game Refuges, Game Ranges, and Wildlife Ranges administered by the U.S. Fish and Wildlife Service, and Wilderness and Primitive Areas administered by the U.S. Forest Service.

**NOTE-**


*FAA Advisory Circular 91-36, Visual Flight Rules (VFR) Flight Near Noise-sensitive Areas, defines the surface of a national park area (including parks, forests, primitive areas, wilderness areas, recreational areas, national seashores, national monuments, national lakeshores, and national wildlife refuge and range areas) as: "The highest terrain within 2,000 feet laterally of the route of flight, or the upper-most rim of a canyon or valley."*

6.3 Federal statutes prohibit certain types of flight activity and/or provide altitude restrictions over designated U.S. Wildlife Refuges, Parks, and Forest Service Areas. These designated areas are charted on Sectional Charts, for example: Boundary Waters Canoe Wilderness Areas, Minnesota; Haleakala National Park, Hawaii; Yosemite National Park, California; and Grand Canyon National Park, Arizona,

6.4 Federal regulations also prohibit airdrops by parachute or other means of persons, cargo, or objects from aircraft on lands administered by the three agencies without authorization from the respective agency. Exceptions include: (1) emergencies involving the safety of human life or (2) threat of serious property loss.

FIG ENR 5.6-1  
**Bird/Other Wildlife Strike Report**

Form Approved OMB NO. 2120-0018

 <b>BIRD/OTHER WILDLIFE STRIKE REPORT</b> U.S. Department of Transportation Federal Aviation Administration					
<b>1. Name of Operator</b>		<b>2. Aircraft Make/Model</b>		<b>3. Engine Make/Model</b>	
<b>4. Aircraft Registration</b>		<b>5. Date of Incident</b> ____/____/____ Month Day Year		<b>6. Local Time of Incident</b> <input type="checkbox"/> Dawn <input type="checkbox"/> Dusk   — HR — MIN <input type="checkbox"/> Day <input type="checkbox"/> Night <input type="checkbox"/> AM <input type="checkbox"/> PM	
<b>7. Airport Name</b>		<b>8. Runway Used</b>		<b>9. Location if En Route</b> (Nearest Town/Reference & State)	
<b>10. Height (AGL)</b>		<b>11. Speed (IAS)</b>			
<b>12. Phase of Flight</b> <input type="checkbox"/> A. Parked <input type="checkbox"/> B. Taxi <input type="checkbox"/> C. Take-off Run <input type="checkbox"/> D. Climb <input type="checkbox"/> E. En Route <input type="checkbox"/> F. Descent <input type="checkbox"/> G. Approach <input type="checkbox"/> H. Landing Roll		<b>13. Part(s) of Aircraft Struck or Damaged</b>			
			<b>Struck</b>	<b>Damaged</b>	
		A. Radome	<input type="checkbox"/>	<input type="checkbox"/>	H. Propeller
		B. Windshield	<input type="checkbox"/>	<input type="checkbox"/>	I. Wing/Rotor
		C. Nose	<input type="checkbox"/>	<input type="checkbox"/>	J. Fuselage
		D. Engine No. 1	<input type="checkbox"/>	<input type="checkbox"/>	K. Landing Gear
		E. Engine No. 2	<input type="checkbox"/>	<input type="checkbox"/>	L. Tail
		F. Engine No. 3	<input type="checkbox"/>	<input type="checkbox"/>	M. Lights
		G. Engine No. 4	<input type="checkbox"/>	<input type="checkbox"/>	N. Other:
		(Specify, if "N. Other" is checked)			
<b>14. Effect on Flight</b> <input type="checkbox"/> None <input type="checkbox"/> Aborted Take-Off <input type="checkbox"/> Precautionary Landing <input type="checkbox"/> Engines Shut Down <input type="checkbox"/> Other: (Specify)		<b>15. Sky Condition</b> <input type="checkbox"/> No Cloud <input type="checkbox"/> Some Cloud <input type="checkbox"/> Overcast		<b>16. Precipitation</b> <input type="checkbox"/> Fog <input type="checkbox"/> Rain <input type="checkbox"/> Snow <input type="checkbox"/> None	
<b>17. Bird/Other Wildlife Species</b>		<b>18. Number or birds seen and/or struck</b>			<b>19. Size of Bird(s)</b>
		Number of Birds	Seen	Struck	<input type="checkbox"/> Small
		1	<input type="checkbox"/>	<input type="checkbox"/>	<input type="checkbox"/> Medium
		2-10	<input type="checkbox"/>	<input type="checkbox"/>	<input type="checkbox"/> Large
		11-100	<input type="checkbox"/>	<input type="checkbox"/>	
		more than 100	<input type="checkbox"/>	<input type="checkbox"/>	
<b>20. Pilot Warned of Birds</b> <input type="checkbox"/> Yes <input type="checkbox"/> No					
<b>21. Remarks</b> (Describe damage, injuries and other pertinent information)					
<b>DAMAGE / COST INFORMATION</b>					
<b>22. Aircraft time out of service:</b> _____ hours		<b>23. Estimated cost of repairs or replacement</b> (U.S. \$): \$ _____		<b>24. Estimated other cost</b> (U.S. \$) (e.g. loss of revenue, fuel, hotels): \$ _____	
<b>Reported by</b> (Optional)			<b>Title</b>	<b>Date</b>	
<p><b>Paperwork Reduction Act Statement:</b> The information collected on this form is necessary to allow the Federal Aviation Administration to assess the magnitude and severity of the wildlife-aircraft strike problem in the U.S. The information is used in determining the best management practices for reducing the hazard to aviation safety caused by wildlife-aircraft strikes. We estimate that it will take approximately <u>5 minutes</u> to complete the form. If you wish to make any comments concerning the accuracy of this burden estimate and any suggestions for reducing this burden, send those comments to the Federal Aviation Administration, Management Staff, ARP-10, 800 Independence Avenue, SW, Washington, DC 20591. The information collected is voluntary. Please note that an agency may not conduct or sponsor, and a person is not required to respond to, a collection of information unless it displays a currently valid OMB control number. The OMB control number associated with this collection is 2120-0045.</p>					



## ENR 5.7 Potential Flight Hazards

### 1. Accident Causal Factors

**1.1** The ten most frequent cause factors for General Aviation Accidents in 1992 that involve the pilot in command are:

**1.1.1** Inadequate preflight preparation and/or planning.

**1.1.2** Failure to obtain/maintain flying speed.

**1.1.3** Failure to maintain direction control.

**1.1.4** Improper level off.

**1.1.5** Failure to see and avoid objects or obstructions.

**1.1.6** Mismanagement of fuel.

**1.1.7** Improper in-flight decisions or planning.

**1.1.8** Misjudgment of distance and speed.

**1.1.9** Selection of unsuitable terrain.

**1.1.10** Improper operation of flight controls.

**1.2** The above factors have continued to plague General Aviation pilots over the years. This list remains relatively stable and points out the need for continued refresher training to establish a higher level of flight proficiency for all pilots. A part of the FAA's continuing effort to promote increased aviation safety is the Aviation Safety Program. For information on the FAA's Aviation Safety Program, readers can contact their nearest Flight Standards District Office's Safety Program Manager.

**1.3** Be alert at all times, especially when the weather is good. Most pilots pay attention to business when they are operating in full IFR weather conditions, but strangely, air collisions almost invariably have occurred under ideal weather conditions. Unlimited visibility appears to encourage a sense of security which is not at all justified. Considerable information of value may be obtained by listening to advisories being issued in the terminal area, even though controller workload may prevent a pilot from obtaining individual service.

**1.4** If you think another aircraft is too close to you, give way instead of waiting for the other pilot to respect the right-of-way to which you may be entitled. It is a lot safer to pursue the right-of-way angle after you have completed your flight.

### 2. Reporting Radio/Radar Altimeter Anomalies

#### 2.1 Background.

**2.1.1** The radio altimeter (also known as radar altimeter or RADALT) is a safety-critical aircraft system used to determine an aircraft's height above terrain. It is the only sensor onboard the aircraft capable of providing a direct measurement of the clearance height above the terrain and obstacles. Information from radio altimeters is essential for flight operations as a main enabler of several safety-critical functions and systems on the aircraft. The receiver on the radio altimeter is highly accurate because it is extremely sensitive, making it susceptible to Radio Frequency Interference (RFI). Harmful RFI in the C-band portion of the spectrum could impact the functions of the radio altimeter during any phase of flight—most critically during takeoff, approach, and landing phases. This could pose a serious risk to flight safety.

**2.1.2** Installed radio altimeters normally supply critical height data to a wide range of automated safety systems, navigation systems, and cockpit displays. RFI affecting the radio altimeter can cause these safety and navigation

systems to operate in unexpected ways and display erroneous information to the pilot. RFI can interrupt, or significantly degrade, radio altimeter functions—precluding radio altimeter-based terrain alerts and low-visibility approach and landing operations. Systems of concern include Terrain Awareness Warning Systems (TAWS), Enhanced Ground Proximity Warning Systems (EGPWS), and Traffic Collision Avoidance Systems (TCAS), to name a few. Pilots of radio altimeter equipped aircraft should become familiar with the radio altimeter’s interdependence with the other aircraft systems and expected failure modes and indications that may be associated with harmful interference.

**2.2 Actions.** Recognizing interference/anomalies in the radio altimeter can be difficult, as it may present as inoperative or erroneous data. Pilots need to monitor their automation, as well as their radio altimeters for discrepancies, and be prepared to take action. Pilots encountering radio altimeter anomalies should transition to procedures that do not require the radio altimeter and inform Air Traffic Control (ATC).

**2.3 Inflight Reporting.** Pilots should report any radio altimeter anomaly to ATC as soon as practical.

**2.4 Post Flight Reporting.**

**2.4.1** Pilots are encouraged to submit detailed reports of radio altimeter interference/anomalies post flight as soon as practical, by internet via the Radio Altimeter Anomaly Reporting Form at [https://www.faa.gov/air\\_traffic/nas/RADALT\\_reports/](https://www.faa.gov/air_traffic/nas/RADALT_reports/).

**2.4.2** The post flight pilot reports of radio altimeter anomalies must contain as much of the following information as applicable:

**2.4.2.1** Date and time the anomaly was observed;

**2.4.2.2** Location of the aircraft at the time the anomaly started and ended (e.g., latitude, longitude or bearing/distance from a reference point or navigational aid);

**2.4.2.3** Magnetic heading;

**2.4.2.4** Altitude (MSL/AGL);

**2.4.2.5** Aircraft type (make/model);

**2.4.2.6** Flight Number or Aircraft number;

**2.4.2.7** Meteorological conditions;

**2.4.2.8** Type of radio altimeter in use (e.g., make/model/software series or version), if known;

**2.4.2.9** Event overview;

**2.4.2.10** Consequences/operational impact, (e.g., impacted equipment, actions taken to mitigate the disruption and/or remedy provided by ATC, required post flight pilot and maintenance actions).

### **3. VFR In Congested Area**

**3.1** A high percentage of near midair collisions occur below 8,000 feet AGL and within 30 miles of an airport. When operating VFR in highly congested areas, whether you intend to land at an airport within the area or are just flying through, it is recommended that extra vigilance be maintained and that you monitor an appropriate control frequency. Normally the appropriate frequency is an approach control frequency. By such monitoring action you can “get the picture” of the traffic in your area. When the approach controller has radar, traffic advisories may be given to VFR pilots who request them, subject to the provisions included in ENR 1.1, paragraph 37.10.4, Radar Traffic Information Service (RTIS).

## **4. Obstructions to Flight**

### **4.1 General**

**4.1.1** Many structures exist that could significantly affect the safety of your flight when operating below 500 feet above ground level (AGL), and particularly below 200 feet AGL. While 14 CFR Section 91.119 allows flight

below 500 AGL when over sparsely populated areas or open water, such operations are very dangerous. At and below 200 feet AGL there are numerous power lines, antenna towers, etc., that are not marked and lighted as obstructions and therefore may not be seen in time to avoid a collision. Notices to Air Missions (NOTAM) are issued on those lighted structures experiencing temporary light outages. However, some time may pass before the FAA is notified of these outages, and the NOTAM issued, thus pilot vigilance is imperative.

## **4.2 Antenna Towers**

**4.2.1** Extreme caution should be exercised when flying less than 2,000 feet above ground level (AGL) because of numerous skeletal structures, such as radio and television antenna towers, that exceed 1,000 feet AGL with some extending higher than 2,000 feet AGL. Most skeletal structures are supported by guy wires which are very difficult to see in good weather and can be invisible at dusk or during periods of reduced visibility. These wires can extend about 1,500 feet horizontally from a structure; therefore, all skeletal structures should be avoided horizontally by at least 2,000 feet. Additionally, new towers may not be on your current chart because the information was not received prior to the printing of the chart.

## **4.3 Overhead Wires**

**4.3.1** Overhead transmission and utility lines often span approaches to runways, natural flyways such as lakes, rivers, gorges, and canyons, and cross other landmarks pilots frequently follow such as highways, railroad tracks, etc. As with antenna towers, these high voltage/power lines or the supporting structures of these lines may not always be readily visible and the wires may be virtually impossible to see under certain conditions. In some locations, the supporting structures of overhead transmission lines are equipped with unique sequence flashing white strobe light systems to indicate that there are wires between the structures. However, many power lines do not require notice to the FAA and, therefore, are not marked and/or lighted. Many of those that do require notice do not exceed 200 feet AGL or meet the Obstruction Standard of 14 CFR Part 77 and, therefore, are not marked and/or lighted. All pilots are cautioned to remain extremely vigilant for these power lines or their supporting structures when following natural flyways or during the approach and landing phase. This is particularly important for seaplane and/or float equipped aircraft when landing on, or departing from, unfamiliar lakes or rivers.

## **4.4 Other Objects/Structures**

**4.4.1** There are other objects or structures that could adversely affect your flight such as construction cranes near an airport, newly constructed buildings, new towers, etc. Many of these structures do not meet charting requirements or may not yet be charted because of the charting cycle. Some structures do not require obstruction marking and/or lighting and some may not be marked and lighted even though the FAA recommended it.

## **5. Avoid Flight Beneath Unmanned Balloons**

**5.1** The majority of unmanned free balloons currently being operated have, extended below them, either a suspension device to which the payload or instrument package is attached, or a trailing wire antenna, or both. In many instances these balloon subsystems may be invisible to the pilot until his/her aircraft is close to the balloon, thereby creating a potentially dangerous situation. Therefore, good judgment on the part of the pilot dictates that aircraft should remain well clear of all unmanned free balloons and flight below them should be avoided at all times.

**5.2** Pilots are urged to report any unmanned free balloons sighted to the nearest FAA ground facility with which communication is established. Such information will assist FAA ATC facilities to identify and flight follow unmanned free balloons operating in the airspace.

## **6. Unmanned Aircraft Systems**

**6.1** Unmanned Aircraft Systems (UAS), formerly referred to as “Unmanned Aerial Vehicles” (UAVs) or “drones,” are having an increasing operational presence in the NAS. Once the exclusive domain of the military, UAS are now being operated by various entities. Although these aircraft are “unmanned,” UAS are flown by a

remotely located pilot and crew. Physical and performance characteristics of unmanned aircraft (UA) vary greatly and unlike model aircraft that typically operate lower than 400 feet AGL, UA may be found operating at virtually any altitude and any speed. Sizes of UA can be as small as several pounds to as large as a commercial transport aircraft. UAS come in various categories including airplane, rotorcraft, powered–lift (tilt–rotor), and lighter–than–air. Propulsion systems of UAS include a broad range of alternatives from piston powered and turbojet engines to battery and solar–powered electric motors.

**6.2** To ensure segregation of UAS operations from other aircraft, the military typically conducts UAS operations within restricted or other special use airspace. However, UAS operations are now being approved in the NAS outside of special use airspace through the use of FAA–issued Certificates of Waiver or Authorization (COA) or through the issuance of a special airworthiness certificate. COA and special airworthiness approvals authorize UAS flight operations to be contained within specific geographic boundaries and altitudes, usually require coordination with an ATC facility, and typically require the issuance of a NOTAM describing the operation to be conducted. UAS approvals also require observers to provide “see–and–avoid” capability to the UAS crew and to provide the necessary compliance with 14 CFR Section 91.113. For UAS operations approved at or above FL180, UAS operate under the same requirements as that of manned aircraft (i.e., flights are operated under instrument flight rules, are in communication with ATC, and are appropriately equipped).

**6.3** UAS operations may be approved at either controlled or uncontrolled airports and are typically disseminated by NOTAM. In all cases, approved UAS operations must comply with all applicable regulations and/or special provisions specified in the COA or in the operating limitations of the special airworthiness certificate. At uncontrolled airports, UAS operations are advised to operate well clear of all known manned aircraft operations. Pilots of manned aircraft are advised to follow normal operating procedures and are urged to monitor the CTAF for any potential UAS activity. At controlled airports, local ATC procedures may be in place to handle UAS operations and should not require any special procedures from manned aircraft entering or departing the traffic pattern or operating in the vicinity of the airport.

**6.4** In addition to approved UAS operations described above, a recently approved agreement between the FAA and the Department of Defense authorizes small UAS operations wholly contained within Class G airspace, and in no instance, greater than 1200 feet AGL over military owned or leased property. These operations do not require any special authorization as long as the UA remains within the lateral boundaries of the military installation as well as other provisions including the issuance of a NOTAM. Unlike special use airspace, these areas may not be depicted on an aeronautical chart.

**6.5** There are several factors a pilot should consider regarding UAS activity in an effort to reduce potential flight hazards. Pilots are urged to exercise increased vigilance when operating in the vicinity of restricted or other special use airspace, military operations areas, and any military installation. Areas with a preponderance of UAS activity are typically noted on sectional charts advising pilots of this activity. Since the size of a UA can be very small, they may be difficult to see and track. If a UA is encountered during flight, as with manned aircraft, never assume that the pilot or crew of the UAS can see you, maintain increased vigilance with the UA and always be prepared for evasive action if necessary. Always check NOTAMs for potential UAS activity along the intended route of flight and exercise increased vigilance in areas specified in the NOTAM.

## ■ 7. Mountain Flying

**7.1** Your first experience of flying over mountainous terrain (particularly if most of your flight time has been over the flatlands of the Midwest) could be a *never-to-be-forgotten nightmare* if proper planning is not done and if you are not aware of the potential hazards awaiting. Those familiar section lines are not present in the mountains; those flat, level fields for forced landings are practically nonexistent; abrupt changes in wind direction and velocity occur; severe updrafts and downdrafts are common, particularly near or above abrupt changes of terrain such as cliffs or rugged areas; even the clouds look different and can build up with startling rapidity. Mountain flying need not be hazardous if you follow the recommendations below:



**7.1.1 File a Flight Plan.** Plan your route to avoid topography which would prevent a safe forced landing. The route should be over populated areas and well known mountain passes. Sufficient altitude should be maintained to permit gliding to a safe landing in the event of engine failure.

**7.1.2** Don't fly a light aircraft when the winds aloft, at your proposed altitude, exceed 35 miles per hour. Expect the winds to be of much greater velocity over mountain passes than reported a few miles from them. Approach mountain passes with as much altitude as possible. Downdrafts of from 1,500 to 2,000 feet per minute are not uncommon on the leeward side.

**7.1.3** Don't fly near or above abrupt changes in terrain. Severe turbulence can be expected, especially in high wind conditions.

**7.1.4 Understand Mountain Obscuration.** The term Mountain Obscuration (MTOS) is used to describe a visibility condition that is distinguished from IFR because ceilings, by definition, are described as "above ground level" (AGL). In mountainous terrain clouds can form at altitudes significantly higher than the weather reporting station and at the same time nearby mountaintops may be obscured by low visibility. In these areas the ground level can also vary greatly over a small area. Beware if operating VFR-on-top. You could be operating closer to the terrain than you think because the tops of mountains are hidden in a cloud deck below. MTOS areas are identified daily on The Aviation Weather Center located at: <http://www.aviationweather.gov>.

**7.2** Navigating in confined terrain when flying through mountain passes can be challenging. For high-traffic mountain passes, VFR checkpoints may be provided on VFR navigation charts to increase situational awareness by indicating key landmarks inside confined terrain. A collocated VFR waypoint and checkpoint may be provided to assist with identifying natural entry points for commonly flown mountain passes. Pilots should reference the name of the charted VFR checkpoint, wherever possible, when making position reports on CTAF frequencies to reduce the risk of midair collisions. Pilots should evaluate the terrain along the route they intend to fly with respect to their aircraft type and performance capabilities, local weather, and their experience level to avoid flying into confined areas without adequate room to execute a 180 degree turn, should conditions require. Always fly with a planned escape route in mind.

**7.3** VFR flight operations may be conducted at night in mountainous terrain with the application of sound judgment and common sense. Proper pre-flight planning, giving ample consideration to winds and weather, knowledge of the terrain and pilot experience in mountain flying are prerequisites for safety of flight. Continuous visual contact with the surface and obstructions is a major concern and flight operations under an overcast or in the vicinity of clouds should be approached with extreme caution.

**7.4** When landing at a high altitude field, the same indicated airspeed should be used as at low elevation fields. Remember: that due to the less dense air at altitude, this same indicated airspeed actually results in a higher true airspeed, a faster landing speed, and more important, a longer landing distance. During gusty wind conditions which often prevail at high altitude fields, a power approach and power landing is recommended. Additionally, due to the faster groundspeed, your takeoff distance will increase considerably over that required at low altitudes.

**7.5 Effects of Density Altitude.** Performance figures in the aircraft owner's handbook for length of takeoff run, horsepower, rate of climb, etc., are generally based on standard atmosphere conditions (59°F, pressure 29.92 inches of mercury) at sea level. However, inexperienced pilots as well as experienced pilots may run into trouble when they encounter an altogether different set of conditions. This is particularly true in hot weather and at higher elevations. Aircraft operations at altitudes above sea level and at higher than standard temperatures are commonplace in mountainous area. Such operations quite often result in a drastic reduction of aircraft performance capabilities because of the changing air density. Density altitude is a measure of air density. It is not to be confused with pressure altitude – true altitude or absolute altitude. It is not to be used as a height reference, but as a determining criteria in the performance capability of an aircraft. Air density decreases with altitude. As air density decreases, density altitude increases. The further effects of high temperature and high humidity are cumulative, resulting in an increasing high density altitude condition. High density altitude reduces all aircraft performance parameters. To the pilot, this means that the normal horsepower output is reduced, propeller efficiency is reduced and a higher true airspeed is required to sustain the aircraft throughout its

operating parameters. It means an increase in runway length requirements for takeoff and landings, and a decreased rate of climb. An average small airplane, for example, requiring 1,000 feet for takeoff at sea level under standard atmospheric conditions will require a takeoff run of approximately 2,000 at an operational altitude of 5,000 feet.

**NOTE-**

*A turbo-charged aircraft engine provides some slight advantage in that it provides sea level horsepower up to a specified altitude above sea level.*

**7.6 Density Altitude Advisories.** At airports with elevations of 2,000 feet and higher, control towers and FSSs will broadcast the advisory “Check Density Altitude” when the temperature reaches a predetermined level. These advisories will be broadcast on appropriate tower frequencies or, where available, ATIS. FSSs will broadcast these advisories as a part of Airport Advisory.

**7.6.1** These advisories are provided by air traffic facilities, as a reminder to pilots that high temperatures and high field elevations will cause significant changes in aircraft characteristics. The pilot retains the responsibility to compute density altitude, when appropriate, as a part of preflight duties.

**NOTE-**

*All FSSs will compute the current density altitude upon request.*

## **8. Use of Runway Half-way Signs at Unimproved Airports**

**8.1** When installed, runway half-way signs provide the pilot with a reference point to judge takeoff acceleration trends. Assuming that the runway length is appropriate for takeoff (considering runway condition and slope, elevation, aircraft weight, wind, and temperature), typical takeoff acceleration should allow the airplane to reach 70 percent of lift-off airspeed by the midpoint of the runway. The “rule of thumb” is that should airplane acceleration not allow the airspeed to reach this value by the midpoint, the takeoff should be aborted, as it may not be possible to liftoff in the remaining runway.

**8.2** Several points are important when considering using this “rule of thumb”:

**8.2.1** Airspeed indicators in small airplanes are not required to be evaluated at speeds below stalling, and may not be usable at 70 percent of liftoff airspeed.

**8.2.2** This “rule of thumb” is based on a uniform surface condition. Puddles, soft spots, areas of tall and/or wet grass, loose gravel, etc., may impede acceleration or even cause deceleration. Even if the airplane achieves 70 percent of liftoff airspeed by the midpoint, the condition of the remainder of the runway may not allow further acceleration. The entire length of the runway should be inspected prior to takeoff to ensure a usable surface.

**8.2.3** This “rule of thumb” applies only to runway required for actual liftoff. In the event that obstacles affect the takeoff climb path, appropriate distance must be available after liftoff to accelerate to best angle of climb speed and to clear the obstacles. This will, in effect, require the airplane to accelerate to a higher speed by midpoint, particularly if the obstacles are close to the end of the runway. In addition, this technique does not take into account the effects of upslope or tailwinds on takeoff performance. These factors will also require greater acceleration than normal and, under some circumstances, prevent takeoff entirely.

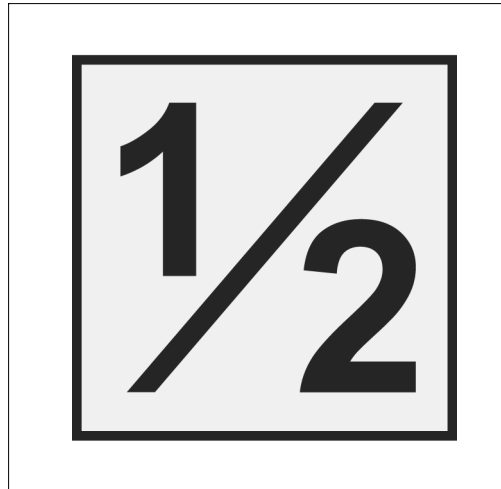
**8.2.4** Use of this “rule of thumb” does not alleviate the pilot’s responsibility to comply with applicable Federal Aviation Regulations, the limitations and performance data provided in the FAA approved Airplane Flight Manual (AFM), or, in the absence of an FAA approved AFM, other data provided by the aircraft manufacturer.

**8.3** In addition to their use during takeoff, runway half-way signs offer the pilot increased awareness of his or her position along the runway during landing operations.

**NOTE-**

*No FAA standard exists for the appearance of the runway half-way sign. FIG ENR 5.7-1 shows a graphical depiction of a typical runway half-way sign.*

FIG ENR 5.7-1  
Typical Runway Half-way Sign



## 9. Mountain Wave

**9.1** Many pilots go all their lives without understanding what a mountain wave is. Quite a few have lost their lives because of this lack of understanding. One need not be a licensed meteorologist to understand the mountain wave phenomenon.

**9.2** Mountain waves occur when air is being blown over a mountain range or even the ridge of a sharp bluff area. As the air hits the upwind side of the range, it starts to climb, thus creating what is generally a smooth updraft which turns into a turbulent downdraft as the air passes the crest of the ridge. From this point, for many miles downwind, there will be a series of downdrafts and updrafts. Satellite photos of the Rockies have shown mountain waves extending as far as 700 miles downwind of the range. Along the east coast area, such photos of the Appalachian chain have picked up the mountain wave phenomenon over a hundred miles eastward. All it takes to form a mountain wave is wind blowing across the range at 15 knots or better at an intersection angle of not less than 30 degrees.

**9.3** Pilots from flatland areas should understand a few things about mountain waves in order to stay out of trouble. Approaching a mountain range from the upwind side (generally the west), there will usually be a smooth updraft; therefore, it is not quite as dangerous an area as the lee of the range. From the leeward side, it is always a good idea to add an extra thousand feet or so of altitude because downdrafts can exceed the climb capability of the aircraft. Never expect an updraft when approaching a mountain chain from the leeward. Always be prepared to cope with a downdraft and turbulence.

**9.4** When approaching a mountain ridge from the downwind side, it is recommended that the ridge be approached at approximately a 45° angle to the horizontal direction of the ridge. This permits a safer retreat from the ridge with less stress on the aircraft should severe turbulence and downdraft be experienced. If severe turbulence is encountered, simultaneously reduce power and adjust pitch until aircraft approaches maneuvering speed, then adjust power and trim to maintain maneuvering speed and fly away from the turbulent area.

## 10. Seaplane Safety

**10.1** Acquiring a seaplane class rating affords access to many areas not available to landplane pilots. Adding a seaplane class rating to your pilot certificate can be relatively uncomplicated and inexpensive. However, more effort is required to become a safe, efficient, competent “bush” pilot. The natural hazards of the backwoods have given way to modern man-made hazards. Except for the far north, the available bodies of water are no longer the exclusive domain of the airman. Seaplane pilots must be vigilant for hazards such as electric power lines, power, sail and rowboats, rafts, mooring lines, water skiers, swimmers, etc.

**10.2** Seaplane pilots must have a thorough understanding of the right-of-way rules as they apply to aircraft versus other vessels. Seaplane pilots are expected to know and adhere to both the United States Coast Guard’s (USCG) Navigation Rules, International–Inland, and Title 14 Code of Federal Regulations (CFR) Section 91.115, Right of Way Rules; Water Operations. The navigation rules of the road are a set of collision avoidance rules as they apply to aircraft on the water. A seaplane is considered a vessel when on the water for the purposes of these collision avoidance rules. In general, a seaplane on the water must keep well clear of all vessels and avoid impeding their navigation. The CFR requires, in part, that aircraft operating on the water “. . . shall, insofar as possible, keep clear of all vessels and avoid impeding their navigation and shall give way to any vessel or other aircraft that is given the right of way . . . .” This means that a seaplane should avoid boats and commercial shipping when on the water. If on a collision course, the seaplane should slow, stop, or maneuver to the right, away from the bow of the oncoming vessel. Also, while on the surface with an engine running, an aircraft must give way to all nonpowered vessels. Since a seaplane in the water may not be as maneuverable as one in the air, the aircraft on the water has right-of-way over one in the air, and one taking off has right-of-way over one landing. A seaplane is exempt from the USCG safety equipment requirements, including the requirements for Personal Floatation Devices (PFD). Requiring seaplanes on the water to comply with USCG equipment requirements in addition to the FAA equipment requirements would be an unnecessary burden on seaplane owners and operators.

**10.3** Unless they are under Federal jurisdiction, navigable bodies of water are under the jurisdiction of the state, or in a few cases, privately owned. Unless they are specifically restricted, aircraft have as much right to operate on these bodies of water as other vessels. To avoid problems, check with Federal or local officials in advance of operating on unfamiliar waters. In addition to the agencies listed in TBL ENR 5.7-1, the nearest Flight Standards District Office can usually offer some practical suggestions as well as regulatory information. If you land on a restricted body of water because of an inflight emergency, or in ignorance of the restrictions you have violated, report as quickly as practical to the nearest local official having jurisdiction and explain your situation.

TBL ENR 5.7-1

**Jurisdictions Controlling Navigable Bodies of Water**

AUTHORITY TO CONSULT FOR USE OF A BODY OF WATER		
Location	Authority	Contact
Wilderness Area	U.S. Department of Agriculture, Forest Service	Local forest ranger
National Forest	USDA Forest Service	Local forest ranger
National Park	U.S. Department of the Interior, National Park Service	Local park ranger
Indian Reservation	USDI, Bureau of Indian Affairs	Local Bureau office
State Park	State government or state forestry or park service	Local state aviation office for further information
Canadian National and Provincial Parks	Supervised and restricted on an individual basis from province to province and by different departments of the Canadian government; consult Canadian Flight Information Manual and/or Water Aerodrome Supplement	Park Superintendent in an emergency

**10.4** When operating a seaplane over or into remote areas, appropriate attention should be given to survival gear. Minimum kits are recommended for summer and winter, and are required by law for flight into sparsely settled areas of Canada and Alaska. Alaska State Department of Transportation and Canadian Ministry of Transport officials can provide specific information on survival gear requirements. The kit should be assembled in one container and be easily reachable and preferably floatable.

**10.5** The FAA recommends that each seaplane owner or operator provide flotation gear for occupants any time a seaplane operates on or near water. 14 CFR Section 91.205(b)(12) requires approved flotation gear for aircraft

operated for hire over water and beyond power-off gliding distance from shore. FAA-approved gear differs from that required for navigable waterways under USCG rules. FAA-approved life vests are inflatable designs as compared to the USCG's non-inflatable PFDs that may consist of solid, bulky material. Such USCG PFDs are impractical for seaplanes and other aircraft because they may block passage through the relatively narrow exits available to pilots and passengers. Life vests approved under Technical Standard Order (TSO) C-13E contain fully inflatable compartments. The wearer inflates the compartments (AFTER exiting the aircraft) primarily by independent CO<sub>2</sub> cartridges, with an oral inflation tube as a backup. The flotation gear also contains a water-activated, self-illuminating signal light. The fact that pilots and passengers can easily don and wear inflatable life vests (when not inflated) provides maximum effectiveness and allows for unrestricted movement. It is imperative that passengers are briefed on the location and proper use of available PFDs prior to leaving the dock.

**10.6** The FAA recommends that seaplane owners and operators obtain Advisory Circular (AC) 91-69, Seaplane Safety for 14 CFR Part 91 Operations, free from:

U.S. Department of Transportation  
Subsequent Distribution Office, SVC-121.23  
Ardmore East Business Center  
3341 Q 75th Avenue  
Landover, MD 20785  
FAX: (301) 386-5394

The USCG Navigation Rules International-Inland (COMDTINST M16672.2B) is available for a fee from the Government Publishing Office by facsimile request to (202) 512-2250. It can be ordered using Mastercard or Visa.

## 11. Flight Operations in Volcanic Ash

**11.1** Severe volcanic eruptions which send ash and sulphur dioxide (SO<sub>2</sub>) gas into the upper atmosphere occur somewhere around the world several times each year. Flying into a volcanic ash cloud can be exceedingly dangerous. A B747-200 lost all four engines after such an encounter, and a B747-400 had the same nearly catastrophic experience. Piston-powered aircraft are less likely to lose power but severe damage is almost certain to ensue after an encounter with a volcanic ash cloud which is only a few hours old.

**11.2** Most important is to avoid any encounter with volcanic ash. The ash plume may not be visible, especially in instrument conditions or at night; and even if visible, it is difficult to distinguish visually between an ash cloud and an ordinary weather cloud. Volcanic ash clouds are not displayed on airborne or ATC radar. The pilot must rely on reports from air traffic controllers and other pilots to determine the location of the ash cloud and use that information to remain well clear of the area. Additionally, detecting SO<sub>2</sub> may indicate volcanic activity but may or may not indicate the presence of volcanic ash. Every attempt should be made to remain on the upwind side of the volcano.

**11.3** It is recommended that pilots encountering an ash cloud should immediately reduce thrust to idle (altitude permitting), and reverse course in order to escape from the cloud. Ash clouds may extend for hundreds of miles, and pilots should not attempt to fly through or climb out of the cloud. In addition, the following procedures are recommended:

**11.3.1** Disengage the autothrottle if engaged. This will prevent the autothrottle from increasing engine thrust.

**11.3.2** Turn on continuous ignition.

**11.3.3** Turn on all accessory airbleeds including all air conditioning packs, nacelles, and wing anti-ice. This will provide an additional engine stall margin by reducing engine pressure.

**11.4** The following has been reported by flight crews who have experienced encounters with volcanic dust clouds.

**11.4.1** Smoke or dust appearing in the cockpit.

**11.4.2** An acrid odor similar to electrical smoke.

**11.4.3** Multiple engine malfunctions, such as compressor stalls, increasing EGT, torching from tailpipe, and flameouts.

**11.4.4** At night, St. Elmo's fire or other static discharges accompanied by a bright orange glow in the engine inlets.

**11.4.5** A fire warning in the forward cargo area.

**11.5** It may become necessary to shut down and then restart engines to prevent exceeding EGT limits. Volcanic ash may block the pitot system and result in unreliable airspeed indications.

**11.6** If you see a volcanic eruption and have not been previously notified of it, you may have been the first person to observe it. In this case, immediately contact ATC and alert them to the existence of the eruption. If possible, use the Volcanic Activity Reporting Form (VAR) depicted at the end of GEN 3.5. Items 1 through 8 of the VAR should be transmitted immediately. The information requested in items 9 through 16 should be passed after landing. If a VAR form is not immediately available, relay enough information to identify the position and nature of the volcanic activity. Do not become unnecessarily alarmed if there is merely steam or very low-level eruptions of ash.

**11.7** When landing at airports where volcanic ash has been deposited on the runway, be aware that even a thin layer of dry ash can be detrimental to braking action. Wet ash on the runway may also reduce effectiveness of braking. It is recommended that reverse thrust be limited to a minimum practical to reduce the possibility of reduced visibility and engine ingestion of airborne ash.

**11.8** When departing from airports where volcanic ash has been deposited it is recommended that pilots avoid operating in visible airborne ash. Allow ash to settle before initiating takeoff roll. It is also recommended that flap extension be delayed until initiating the takeoff checklist and that a rolling takeoff be executed to avoid blowing ash back into the air.

## ■ 12. Emergency Airborne Inspection of Other Aircraft

**12.1** Providing airborne assistance to another aircraft may involve flying in very close proximity to that aircraft. Most pilots receive little, if any, formal training or instruction in this type of flying activity. Close proximity flying without sufficient time to plan (i.e., in an emergency situation), coupled with the stress involved in a perceived emergency can be hazardous.

**12.2** The pilot in the best position to assess the situation should take the responsibility of coordinating the airborne intercept and inspection, taking into account the unique flight characteristics and differences of the category(s) of aircraft involved.

**12.3** Some of the safety considerations are:

**12.3.1** Area, direction, and speed of the intercept.

**12.3.2** Aerodynamic effects (i.e., rotorcraft downwash) which may also affect.

**12.3.3** Minimum safe separation distances.

**12.3.4** Communications requirements, lost communications procedures, coordination with ATC.

**12.3.5** Suitability of diverting the distressed aircraft to the nearest safe airport.

**12.3.6** Emergency actions to terminate the intercept.

**12.4** Close proximity, inflight inspection of another aircraft is uniquely hazardous. The pilot in command of the aircraft experiencing the problem/emergency must not relinquish his/her control of the situation and jeopardize the safety of his/her aircraft. The maneuver must be accomplished with minimum risk to both aircraft.

### 13. Precipitation Static

**13.1** Precipitation static is caused by aircraft in flight coming in contact with uncharged particles. These particles can be rain, snow, fog, sleet, hail, volcanic ash, dust, any solid or liquid particles. When the aircraft strikes these neutral particles, the positive element of the particle is reflected away from the aircraft and the negative particle adheres to the skin of the aircraft. In a very short period of time a substantial negative charge will develop on the skin of the aircraft. If the aircraft is not equipped with static dischargers, or has an ineffective static discharger system, when a sufficient negative voltage level is reached, the aircraft may go into “CORONA.” That is, it will discharge the static electricity from the extremities of the aircraft, such as the wing tips, horizontal stabilizer, vertical stabilizer, antenna, propeller tips, etc. This discharge of static electricity is what you will hear in your headphones and is what we call P-static.

**13.2** A review of pilot reports often shows different symptoms with each problem that is encountered. The following list of problems is a summary of many pilot reports from many different aircraft. Each problem was caused by P-static:

**13.2.1** Complete loss of VHF communications.

**13.2.2** Erroneous magnetic compass readings (30% in error).

**13.2.3** High pitched squeal on audio.

**13.2.4** Motor boat sound on audio.

**13.2.5** Loss of all avionics in clouds.

**13.2.6** VLF navigation system inoperative most of the time.

**13.2.7** Erratic instrument readouts.

**13.2.8** Weak transmissions and poor receptivity of radios.

**13.2.9** “St. Elmo’s Fire” on windshield.

**13.3** Each of these symptoms is caused by one general problem on the airframe. This problem is the inability of the accumulated charge to flow easily to the wing tips and tail of the airframe, and properly discharge to the airstream.

**13.4** Static dischargers work on the principle of creating a relatively easy path for discharging negative charges that develop on the aircraft by using a discharger with fine metal points, carbon coated rods, or carbon wicks rather than wait until a large charge is developed and discharged off the trailing edges of the aircraft that will interfere with avionics equipment. This process offers approximately 50 decibels (dB) static noise reduction which is adequate in most cases to be below the threshold of noise that would cause interference in avionics equipment.

**13.5** It is important to remember that precipitation static problems can only be corrected with the proper number of quality static dischargers, properly installed on a properly bonded aircraft. P-static is indeed a problem in the all weather operation of the aircraft, but there are effective ways to combat it. All possible methods of reducing the effects of P-static should be considered so as to provide the best possible performance in the flight environment.

**13.6** A wide variety of discharger designs is available on the commercial market. The inclusion of well-designed dischargers may be expected to improve airframe noise in P-static conditions by as much as 50 dB. Essentially, the discharger provides a path by which accumulated charge may leave the airframe quietly. This is generally accomplished by providing a group of tiny corona points to permit onset of corona-current flow at a low aircraft potential. Additionally, aerodynamic design of dischargers to permit corona to occur at the lowest possible atmospheric pressure also lowers the corona threshold. In addition to permitting a low potential discharge, the discharger will minimize the radiation of radio frequency (RF) energy which accompanies the corona discharge, in order to minimize effects of RF components at communications and navigation frequencies on avionics performance. These effects are reduced through resistive attachment of the corona point(s) to the airframe, preserving direct current connection but attenuating the higher frequency components of the discharge.

**13.7** Each manufacturer of static dischargers offers information concerning appropriate discharger location on specific airframes. Such locations emphasize the trailing outboard surfaces of wings and horizontal tail surfaces, plus the tip of the vertical stabilizer, where charge tends to accumulate on the airframe. Sufficient dischargers must be provided to allow for current carrying capacity which will maintain airframe potential below the corona threshold of the trailing edges.

**13.8** In order to achieve full performance of avionic equipment, the static discharge system will require periodic maintenance. A pilot's knowledge of P-static causes and effects is an important element in assuring optimum performance by early recognition of these types of problems.

## **14. Light Amplification by Stimulated Emission of Radiation (Laser) Operations and Reporting Illumination of Aircraft**

**14.1** Lasers have many applications. Of concern to users of the National Airspace System are those laser events that may affect pilots; e.g., outdoor laser light shows or demonstrations for entertainment and advertisement at special events and theme parks. Generally, the beams from these events appear as bright blue–green in color; however, they may be red, yellow, or white. Some laser systems produce light which is invisible to the human eye.

**14.2** FAA regulations prohibit the disruption of aviation activity by any person on the ground or in the air. The FAA and the Food and Drug Administration (the Federal agency that has the responsibility to enforce compliance with Federal requirements for laser systems and laser light show products) are working together to ensure that operators of these devices do not pose a hazard to aircraft operators.

**14.3** Pilots should be aware that illuminations from these laser operations is able to create temporary vision impairment miles from the actual location. In addition, these operations can produce permanent eye damage. Pilots should make themselves aware of where laser activities are being conducted and avoid the areas if possible.

**14.4** Recent and increasing incidents of unauthorized illumination of aircraft by lasers, as well as the proliferation and increasing sophistication of laser devices available to the general public, dictates that the FAA, in coordination with other government agencies, take action to safeguard flights from these unauthorized illuminations.

**14.5** Pilots should report laser illumination activity to the controlling Air Traffic Control facilities, Federal Contract Towers or Flight Service Stations as soon as possible after the event. The following information should be included:

**14.5.1** UTC Date and Time of Event.

**14.5.2** Call Sign or Aircraft Registration Number.

**14.5.3** Type Aircraft.

**14.5.4** Nearest Major City.

**14.5.5** Altitude.

**14.5.6** Location of Event (Latitude/Longitude and/or Fixed Radial Distance (FRD)).

**14.5.7** Brief Description of the Event and any other Pertinent Information.

**14.6** Pilots are also encouraged to complete the Laser Beam Exposure Questionnaire located on the FAA Laser Safety Initiative website at <http://www.faa.gov/about/initiatives/lasers/> and submit electronically per the directions on the questionnaire, as soon as possible after landing.

**14.7** When a laser event is reported to an air traffic facility, a general caution warning will be broadcasted on all appropriate frequencies every five minutes for 20 minutes and broadcasted on the ATIS for one hour following the report.

### **PHRASEOLOGY–**

*UNAUTHORIZED LASER ILLUMINATION EVENT, (UTC time), (location), (altitude), (color), (direction).*



**EXAMPLE–**

*“Unauthorized laser illumination event, at 0100z, 8 mile final runway 18R at 3,000 feet, green laser from the southwest.”*

**14.8** When laser activities become known to the FAA, Notices to Air Missions (NOTAM) are issued to inform the aviation community of the events. Pilots should consult NOTAMs or the Special Notices Section of the Chart Supplement U.S. for information regarding laser activities.

## **15. Flying in Flat Light, Brown Out Conditions, and White Out Conditions**

**15.1 Flat Light.** Flat light is an optical illusion, also known as “sector or partial white out.” It is not as severe as “white out” but the condition causes pilots to lose their depth-of-field and contrast in vision. Flat light conditions are usually accompanied by overcast skies inhibiting any visual clues. Such conditions can occur anywhere in the world, primarily in snow covered areas but can occur in dust, sand, mud flats, or on glassy water. Flat light can completely obscure features of the terrain, creating an inability to distinguish distances and closure rates. As a result of this reflected light, it can give pilots the illusion that they are ascending or descending when they may actually be flying level. However, with good judgment and proper training and planning, it is possible to safely operate an aircraft in flat light conditions.

**15.2 Brown Out.** A brownout (or *brown-out*) is an in-flight visibility restriction due to dust or sand in the air. In a brownout, the pilot cannot see nearby objects which provide the outside visual references necessary to control the aircraft near the ground. This can cause spatial disorientation and loss of situational awareness leading to an accident.

**15.2.1** The following factors will affect the probability and severity of brownout: rotor disk loading, rotor configuration, soil composition, wind, approach speed, and approach angle.

**15.2.2** The brownout phenomenon causes accidents during helicopter landing and take-off operations in dust, fine dirt, sand, or arid desert terrain. Intense, blinding dust clouds stirred up by the helicopter rotor downwash during near-ground flight causes significant flight safety risks from aircraft and ground obstacle collisions, and dynamic rollover due to sloped and uneven terrain.

**15.2.3** This is a dangerous phenomenon experienced by many helicopters when making landing approaches in dusty environments, whereby sand or dust particles become swept up in the rotor outwash and obscure the pilot’s vision of the terrain. This is particularly dangerous because the pilot needs those visual cues from their surroundings in order to make a safe landing.

**15.2.4** Blowing sand and dust can cause an illusion of a tilted horizon. A pilot not using the flight instruments for reference may instinctively try to level the aircraft with respect to the false horizon, resulting in an accident. Helicopter rotor wash also causes sand to blow around outside the cockpit windows, possibly leading the pilot to experience an illusion where the helicopter appears to be turning when it is actually in a level hover. This can also cause the pilot to make incorrect control inputs which can quickly lead to disaster when hovering near the ground. In night landings, aircraft lighting can enhance the visual illusions by illuminating the brownout cloud.

**15.3 White Out.** As defined in meteorological terms, white out occurs when a person becomes engulfed in a uniformly white glow. The glow is a result of being surrounded by blowing snow, dust, sand, mud or water. There are no shadows, no horizon or clouds and all depth-of-field and orientation are lost. A white out situation is severe in that there are no visual references. Flying is not recommended in any white out situation. Flat light conditions can lead to a white out environment quite rapidly, and both atmospheric conditions are insidious; they sneak up on you as your visual references slowly begin to disappear. White out has been the cause of several aviation accidents.

**15.4 Self Induced White Out.** This effect typically occurs when a helicopter takes off or lands on a snow-covered area. The rotor down wash picks up particles and re-circulates them through the rotor down wash. The effect can vary in intensity depending upon the amount of light on the surface. This can happen on the sunniest, brightest day with good contrast everywhere. However, when it happens, there can be a complete loss of visual clues. If the pilot has not prepared for this immediate loss of visibility, the results can be disastrous. Good planning does not prevent one from encountering flat light or white out conditions.

### **15.5 Never take off in a white out situation.**

**15.5.1** Realize that in flat light conditions it may be possible to depart but not to return to that site. During takeoff, make sure you have a reference point. Do not lose sight of it until you have a departure reference point in view. Be prepared to return to the takeoff reference if the departure reference does not come into view.

**15.5.2** Flat light is common to snow skiers. One way to compensate for the lack of visual contrast and depth-of-field loss is by wearing amber tinted lenses (also known as blue blockers). Special note of caution: Eyewear is not ideal for every pilot. Take into consideration personal factors – age, light sensitivity, and ambient lighting conditions.

**15.5.3** So what should a pilot do when all visual references are lost?

**15.5.3.1** Trust the cockpit instruments.

**15.5.3.2** Execute a 180 degree turnaround and start looking for outside references.

**15.5.3.3** Above all – fly the aircraft.

**15.6** Landing in Low Light Conditions. When landing in a low light condition – use extreme caution. Look for intermediate reference points, in addition to checkpoints along each leg of the route for course confirmation and timing. The lower the ambient light becomes, the more reference points a pilot should use.

### **15.7 Airport Landings.**

**15.7.1** Look for features around the airport or approach path that can be used in determining depth perception. Buildings, towers, vehicles or other aircraft serve well for this measurement. Use something that will provide you with a sense of height above the ground, in addition to orienting you to the runway.

**15.7.2** Be cautious of snowdrifts and snow banks – anything that can distinguish the edge of the runway. Look for subtle changes in snow texture or shading to identify ridges or changes in snow depth.

### **15.8 Off-Airport Landings.**

**15.8.1** In the event of an off-airport landing, pilots have used a number of different visual cues to gain reference. Use whatever you must to create the contrast you need. Natural references seem to work best (trees, rocks, snow ribs, etc.)

**15.8.1.1** Over flight.

**15.8.1.2** Use of markers.

**15.8.1.3** Weighted flags.

**15.8.1.4** Smoke bombs.

**15.8.1.5** Any colored rags.

**15.8.1.6** Dye markers.

**15.8.1.7** Kool-aid.

**15.8.1.8** Trees or tree branches.

**15.8.2** It is difficult to determine the depth of snow in areas that are level. Dropping items from the aircraft to use as reference points should be used as a visual aid only and not as a primary landing reference. Unless your marker is biodegradable, be sure to retrieve it after landing. Never put yourself in a position where no visual references exist.

**15.8.3** Abort landing if blowing snow obscures your reference. Make your decisions early. Don't assume you can pick up a lost reference point when you get closer.

**15.8.4** Exercise extreme caution when flying from sunlight into shade. Physical awareness may tell you that you are flying straight but you may actually be in a spiral dive with centrifugal force pressing against you. Having

no visual references enhances this illusion. Just because you have a good visual reference does not mean that it's safe to continue. There may be snow-covered terrain not visible in the direction that you are traveling. Getting caught in a no visual reference situation can be fatal.

### **15.9 Flying Around a Lake.**

**15.9.1** When flying along lakeshores, use them as a reference point. Even if you can see the other side, realize that your depth perception may be poor. It is easy to fly into the surface. If you must cross the lake, check the altimeter frequently and maintain a safe altitude while you still have a good reference. Don't descend below that altitude.

**15.9.2** The same rules apply to seemingly flat areas of snow. If you don't have good references, avoid going there.

**15.10 Other Traffic.** Be on the look out for other traffic in the area. Other aircraft may be using your same reference point. Chances are greater of colliding with someone traveling in the same direction as you, than someone flying in the opposite direction.

**15.11 Ceilings.** Low ceilings have caught many pilots off guard. Clouds do not always form parallel to the surface, or at the same altitude. Pilots may try to compensate for this by flying with a slight bank and thus creating a descending turn.

**15.12 Glaciers.** Be conscious of your altitude when flying over glaciers. The glaciers may be rising faster than you are climbing.

## **16. Operations in Ground Icing Conditions**

**16.1** The presence of aircraft airframe icing during takeoff, typically caused by improper or no deicing of the aircraft being accomplished prior to flight has contributed to many recent accidents in turbine aircraft. The General Aviation Joint Steering Committee (GAJSC) is the primary vehicle for government-industry cooperation, communication, and coordination on GA accident mitigation. The Turbine Aircraft Operations Subgroup (TAOS) works to mitigate accidents in turbine accident aviation. While there is sufficient information and guidance currently available regarding the effects of icing on aircraft and methods for deicing, the TAOS has developed a list of recommended actions to further assist pilots and operators in this area.

**16.1.1** While the efforts of the TAOS specifically focus on turbine aircraft, it is recognized that their recommendations are applicable to and can be adapted for the pilot of a small, piston powered aircraft too.

**16.2** The following recommendations are offered:

**16.2.1** Ensure that your aircraft's lift-generating surfaces are COMPLETELY free of contamination before flight through a tactile (hands on) check of the critical surfaces when feasible. Even when otherwise permitted, operators should avoid smooth or polished frost on lift-generating surfaces as an acceptable preflight condition.

**16.2.2** Review and refresh your cold weather standard operating procedures.

**16.2.3** Review and be familiar with the Airplane Flight Manual (AFM) limitations and procedures necessary to deal with icing conditions prior to flight, as well as in flight.

**16.2.4** Protect your aircraft while on the ground, if possible, from sleet and freezing rain by taking advantage of aircraft hangars.

**16.2.5** Take full advantage of the opportunities available at airports for deicing. Do not refuse deicing services simply because of cost.

**16.2.6** Always consider canceling or delaying a flight if weather conditions do not support a safe operation.

**16.3** If you haven't already developed a set of Standard Operating Procedures for cold weather operations, they should include:

**16.3.1** Procedures based on information that is applicable to the aircraft operated, such as AFM limitations and procedures;

**16.3.2** Concise and easy to understand guidance that outlines best operational practices;

**16.3.3** A systematic procedure for recognizing, evaluating and addressing the associated icing risk, and offer clear guidance to mitigate this risk;

**16.3.4** An aid (such as a checklist or reference cards) that is readily available during normal day-to-day aircraft operations.

**16.4** There are several sources for guidance relating to airframe icing, including:  
<http://aircrafticing.grc.nasa.gov/index.html>.

**16.4.1** Advisory Circular (AC) 91–74, Pilot Guide, Flight in Icing Conditions.

**16.4.2** AC 135–17, Pilot Guide Small Aircraft Ground Deicing.

**16.4.3** AC 135–9, FAR Part 135 Icing Limitations.

**16.4.4** AC 120–60, Ground Deicing and Anti-icing Program.

**16.4.5** AC 135–16, Ground Deicing and Anti-icing Training and Checking.

**16.5** The FAA Approved Deicing Program Updates is published annually as a Flight Standards Information Bulletin for Air Transportation and contains detailed information on deicing and anti-icing procedures and holdover times. It may be accessed at the following website by selecting the current year's information bulletins:  
[https://www.faa.gov/other\\_visit/aviation\\_industry/airline\\_operators/airline\\_safety/deicing/](https://www.faa.gov/other_visit/aviation_industry/airline_operators/airline_safety/deicing/).

## **17. Avoid Flight in the Vicinity of Exhaust Plumes (Smoke Stacks and Cooling Towers)**

**17.1 Flight Hazards Exist Around Exhaust Plumes.** Exhaust plumes are defined as visible or invisible emissions from power plants, industrial production facilities, or other industrial systems that release large amounts of vertically directed unstable gases (effluent). High temperature exhaust plumes can cause significant air disturbances such as turbulence and vertical shear. Other identified potential hazards include, but are not necessarily limited to: reduced visibility, oxygen depletion, engine particulate contamination, exposure to gaseous oxides, and/or icing. Results of encountering a plume may include airframe damage, aircraft upset, and/or engine damage/failure. These hazards are most critical during low altitude flight in calm and cold air, especially in and around approach and departure corridors or airport traffic areas.

Whether plumes are visible or invisible, the total extent of their turbulent affect is difficult to predict. Some studies do predict that the significant turbulent effects of an exhaust plume can extend to heights of over 1,000 feet above the height of the top of the stack or cooling tower. Any effects will be more pronounced in calm stable air where the plume is very hot and the surrounding area is still and cold. Fortunately, studies also predict that any amount of crosswind will help to dissipate the effects. However, the size of the tower or stack is not a good indicator of the predicted effect the plume may produce. The major effects are related to the heat or size of the plume effluent, the ambient air temperature, and the wind speed affecting the plume. Smaller aircraft can expect to feel an effect at a higher altitude than heavier aircraft.

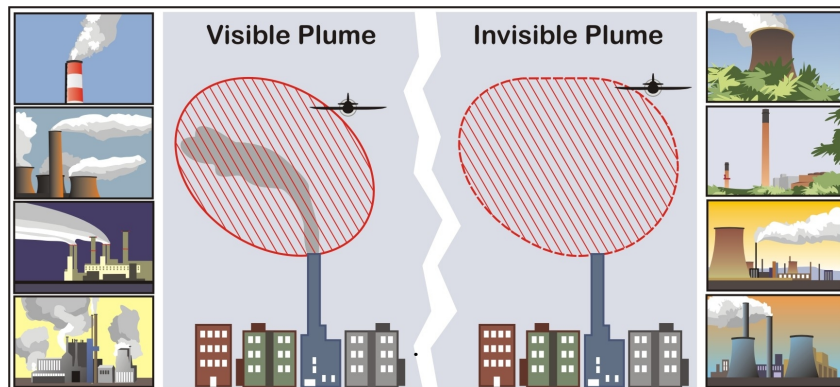
**17.2 When able, a pilot should steer clear of exhaust plumes by flying on the upwind side of smokestacks or cooling towers.** When a plume is visible via smoke or a condensation cloud, remain clear and realize a plume may have both visible and invisible characteristics. Exhaust stacks without visible plumes may still be in full operation, and airspace in the vicinity should be treated with caution. As with mountain wave turbulence or clear air turbulence, an invisible plume may be encountered unexpectedly. Cooling towers, power plant stacks, exhaust fans, and other similar structures are depicted in FIG ENR 5.7–2.

Pilots are encouraged to exercise caution when flying in the vicinity of exhaust plumes. Pilots are also encouraged to reference the Chart Supplement U.S. where amplifying notes may caution pilots and identify the location of structure(s) emitting exhaust plumes.

The best available information on this phenomenon must come from pilots via the PIREP reporting procedures. All pilots encountering hazardous plume conditions are urgently requested to report time, location, and intensity

(light, moderate, severe, or extreme) of the element to the FAA facility with which they are maintaining radio contact. If time and conditions permit, elements should be reported according to the standards for other PIREPs and position reports see GEN 3.5, paragraph 22. PIREPS Relating to Turbulence).

FIG ENR 5.7-2  
Plumes



### 18. Space Launch and Reentry Area

Locations where commercial space launch and/or reentry operations occur. Hazardous operations occur in space launch and reentry areas, and for pilot awareness, a rocket-shaped symbol is used to depict them on sectional aeronautical charts. These locations may have vertical launches from launch pads, horizontal launches from runways, and/or reentering vehicles coming back to land. Because of the wide range of hazards associated with space launch and reentry areas, pilots are expected to check NOTAMS for the specific area prior to flight to determine the location and lateral boundaries of the associated hazard area, and the active time. NOTAMS may include terms such as “rocket launch activity,” “space launch,” or “space reentry,” depending upon the type of operation. Space launch and reentry areas are not established for amateur rocket operations conducted per 14 CFR Part 101.

FIG ENR 5.7-3  
Space Launch and Reentry Area Depicted on a Sectional Chart





## ENR 6. Helicopter Operations

### ENR 6.1 Helicopter IFR Operations

#### 1. Helicopter Flight Control Systems

**1.1** The certification requirements for helicopters to operate under Instrument Flight Rules (IFR) are contained in 14 CFR Part 27, Airworthiness Standards: Normal Category Rotorcraft, and 14 CFR Part 29, Airworthiness Standards: Transport Category Rotorcraft. To meet these requirements, helicopter manufacturers usually utilize a set of stabilization and/or Automatic Flight Control Systems (AFCS).

**1.2** Typically, these systems fall into the following categories:

**1.2.1** Aerodynamic surfaces, which impart some stability or control capability not found in the basic VFR configuration.

**1.2.2** Trim systems, which provide a cyclic centering effect. These systems typically involve a magnetic brake/spring device, and may also be controlled by a four-way switch on the cyclic. This is a system that supports “hands on” flying of the helicopter by the pilot.

**1.2.3** Stability Augmentation Systems (SASs), which provide short-term rate damping control inputs to increase helicopter stability. Like trim systems, SAS supports “hands on” flying.

**1.2.4** Attitude Retention Systems (ATT), which return the helicopter to a selected attitude after a disturbance. Changes in desired attitude can be accomplished usually through a four-way “beep” switch, or by actuating a “force trim” switch on the cyclic, setting the attitude manually, and releasing. Attitude retention may be a SAS function, or may be the basic “hands off” autopilot function.

**1.2.5** Autopilot Systems (AP), which provide for “hands off” flight along specified lateral and vertical paths, including heading, altitude, vertical speed, navigation tracking, and approach. These systems typically have a control panel for mode selection, and system for indication of mode status. Autopilots may or may not be installed with an associated Flight Director System (FD). Autopilots typically control the helicopter about the roll and pitch axes (cyclic control) but may also include yaw axis (pedal control) and collective control servos.

**1.2.6** FDs, which provide visual guidance to the pilot to fly specific selected lateral and vertical modes of operation. The visual guidance is typically provided as either a “dual cue” (commonly known as a “cross-pointer”) or “single cue” (commonly known as a “vee-bar”) presentation superimposed over the attitude indicator. Some FDs also include a collective cue. The pilot manipulates the helicopter’s controls to satisfy these commands, yielding the desired flight path, or may couple the flight director to the autopilot to perform automatic flight along the desired flight path. Typically, flight director mode control and indication is shared with the autopilot.

**1.3** In order to be certificated for IFR operation, a specific helicopter may require the use of one or more of these systems, in any combination.

**1.4** In many cases, helicopters are certificated for IFR operations with either one or two pilots. Certain equipment is required to be installed and functional for two pilot operations, and typically, additional equipment is required for single pilot operation. These requirements are usually described in the limitations section of the Rotorcraft Flight Manual (RFM).

**1.5** In addition, the RFM also typically defines systems and functions that are required to be in operation or engaged for IFR flight in either the single or two pilot configuration. Often, particularly in two pilot operation, this level of augmentation is less than the full capability of the installed systems. Likewise, single pilot operation may require a higher level of augmentation.

**1.6** The RFM also identifies other specific limitations associated with IFR flight. Typically, these limitations include, but are not limited to:

**1.6.1** Minimum equipment required for IFR flight (in some cases, for both single pilot and two pilot operations).

**1.6.2**  $V_{MINI}$  (minimum speed – IFR).

**NOTE–**

$V_{MINI}$  – Instrument flight minimum speed, utilized in complying with minimum limit speed requirements for instrument flight

**NOTE–**

The manufacturer may also recommend a minimum IFR airspeed during instrument approach.

**1.6.3**  $V_{NEI}$  (never exceed speed – IFR).

**NOTE–**

$V_{NEI}$  – Instrument flight never exceed speed, utilized instead of  $V_{NE}$  for compliance with maximum limit speed requirements for instrument flight

$V_{NE}$  – Never exceed speed

**1.6.4** Maximum approach angle.

**1.6.5** Weight and center of gravity limits.

**1.6.6** Aircraft configuration limitations (such as aircraft door positions and external loads).

**1.6.7** Aircraft system limitations (generators, inverters, etc.).

**1.6.8** System testing requirements (many avionics and AFCS/AP/FD systems incorporate a self–test feature).

**1.6.9** Pilot action requirements (such as the pilot must have his/her hands and feet on the controls during certain operations, such as during instrument approach below certain altitudes).

**1.7** It is very important that pilots be familiar with the IFR requirements for their particular helicopter. Within the same make, model and series of helicopter, variations in the installed avionics may change the required equipment or the level of augmentation for a particular operation.

**1.8** During flight operations, pilots must be aware of the mode of operation of the augmentation systems, and the control logic and functions employed. For example, during an ILS approach using a particular system in the three–cue mode (lateral, vertical and collective cues), the flight director *collective cue* responds to glideslope deviation, while the horizontal bar of the “cross–pointer” responds to airspeed deviations. The same system, while flying an ILS in the two–cue mode, provides for the *horizontal bar* to respond to glideslope deviations. This concern is particularly significant when operating using two pilots. Pilots should have an established set of procedures and responsibilities for the control of flight director/autopilot modes for the various phases of flight. Not only does a full understanding of the system modes provide for a higher degree of accuracy in control of the helicopter, it is the basis for crew identification of a faulty system.

**1.9** Relief from the prohibition to takeoff with any inoperative instruments or equipment may be provided through a Minimum Equipment List (see 14 CFR Section 91.213 and 14 CFR Section 135.179, Inoperative Instruments and Equipment). In many cases, a helicopter configured for single pilot IFR may depart IFR with certain equipment inoperative, provided a crew of two pilots is used. Pilots are cautioned to ensure the pilot–in–command and second–in–command meet the requirements of 14 CFR Section 61.58, Pilot–in–Command Proficiency Check: Operation of Aircraft Requiring More Than One Pilot Flight Crewmember, and 14 CFR Section 61.55, Second–in–Command Qualifications, or 14 CFR Part 135, Operating Requirements: Commuter and On–Demand Operations, Subpart E, Flight Crewmember Requirements, and Subpart G, Crewmember Testing Requirements, as appropriate.

**1.10** Experience has shown that modern AFCS/AP/FD equipment installed in IFR helicopters can, in some cases, be very complex. This complexity requires the pilot(s) to obtain and maintain a high level of knowledge of system operation, limitations, failure indications and reversionary modes. In some cases, this may only be reliably accomplished through formal training.

## **2. Helicopter Instrument Approaches**

**2.1** Instrument flight procedures (IFPs) permit helicopter operations to heliports and runways during periods of low ceilings and reduced visibility (e.g. approach/SID/STAR/en route). IFPs can be designed for both public



and private heliports using FAA instrument criteria. The FAA does recognize there are non-FAA service providers with proprietary special criteria. Special IFPs are reviewed and approved by Flight Technologies and Procedures Division and may have specified aircraft performance or equipment requirements, special crew training, airport facility equipment, waivers from published standards, proprietary criteria and restricted access. Special IFPs are not published in the Federal Register or printed in government Flight Information Publications.

**2.1.1** Helicopters flying conventional (i.e. non-Copter) IAPs may reduce the visibility minima to not less than one-half the published Category A landing visibility minima, or  $\frac{1}{4}$  statute mile visibility/1200 RVR, whichever is greater, unless the procedure is annotated with “**Visibility Reduction by Helicopters NA.**” This annotation means that there are penetrations of the final approach obstacle identification surface (OIS) and that the 14 CFR Section 97.3 visibility reduction rule does not apply and you must take precaution to avoid any obstacles in the visual segment. No reduction in MDA/DA is permitted at any time. The helicopter may initiate the final approach segment at speeds up to the upper limit of the highest approach category authorized by the procedure, but must be slowed to no more than 90 KIAS at the missed approach point (MAP) in order to apply the visibility reduction. Pilots are cautioned that such a decelerating approach may make early identification of wind shear on the approach path difficult or impossible. If required, use the Inoperative Components and Visual Aids Table provided inside the front cover of the U.S. Terminal Procedures Publication to derive the Category A minima before applying the 14 CFR Section 97.3 rule.

**2.1.2** Helicopters flying Copter IAPs should use the published minima, with no reductions allowed. Unless otherwise specified on the instrument procedure chart, 90 KIAS is the maximum speed on the approach.

**2.1.3** Pilots flying Area Navigation (RNAV) Copter IAPs should also limit their speed to 90 KIAS unless otherwise specified on the instrument procedure chart. The final and missed approach segment speeds must be limited to no more than 70 KIAS unless otherwise charted. Military RNAV Copter IAPs are limited to no more than 90 KIAS throughout the procedure. Use the published minima; no reductions allowed.

**NOTE-**

*Obstruction clearance surfaces are based on the aircraft speed identified on the approach chart and have been designed on RNAV approaches for 70 knots unless otherwise indicated. If the helicopter is flown at higher speeds, it may fly outside of protected airspace. Some helicopters have a  $V_{MINI}$  greater than 70 knots; therefore, they cannot meet the 70 knot limitation to conduct these RNAV approaches. Some helicopter autopilots, when used in the “go-around” mode, are programmed with a  $V_{YI}$  greater than 70 knots. Therefore, those helicopters, when using the autopilot “go-around” mode, cannot meet the 70 knot limitation for the RNAV approach. It may be possible to use the autopilot for the missed approach in other than the “go-around” mode and meet the 70 knot limitation. When operating at speeds other than  $V_{YI}$  or  $V_Y$ , performance data may not be available in the RFM to predict compliance with climb gradient requirements. Pilots may use observed performance in similar weight/altitude/temperature/speed conditions to evaluate the suitability of performance. Pilots are cautioned to monitor climb performance to ensure compliance with procedure requirements.*

**NOTE-**

*$V_{MINI}$  – Instrument flight minimum speed, utilized in complying with minimum limit speed requirements for instrument flight  
 $V_{YI}$  – Instrument climb speed, utilized instead of  $V_Y$  for compliance with the climb requirements for instrument flight  
 $V_Y$  – Speed for best rate of climb*

**2.1.4** TBL ENR 6.1-1 summarizes these requirements.

*TBL ENR 6.1-1*  
**Helicopter Use of Standard Instrument Approach Procedures**

Procedure	Helicopter Visibility Minima	Helicopter MDA/DA	Maximum Speed Limitations
<b>Conventional (non-Copter)</b>	The greater of: one half the Category A visibility minima, 1/4 statute mile visibility, or 1200 RVR	As published for Category A	The helicopter may initiate the final approach segment at speeds up to the upper limit of the highest Approach Category authorized by the procedure, but must be slowed to no more than 90 KIAS at the MAP in order to apply the visibility reduction.
<b>Copter Procedure</b>	As published	As published	90 KIAS maximum when on a published route/track.
<b>RNAV (GPS) Copter Procedure</b>	As published	As published	The maximum speed for a Copter approach will be 90 KIAS or as published on the chart. Note: Higher approach angles may require a lower approach speed and aircraft V <sub>MINI</sub> . Military procedures are limited to 90 KIAS for all segments.

**NOTE-**

Several factors affect the ability of the pilot to acquire and maintain the visual references specified in 14 CFR Section 91.175(c), even in cases where the flight visibility may be at the minimum derived from the criteria in TBL ENR 6.1-1. These factors include, but are not limited to:

1. Cockpit cutoff angle (the angle at which the cockpit or other airframe structure limits downward visibility below the horizon).
2. Combinations of high MDA/DH and low visibility minimum, such as approaches with reduced helicopter visibility minima (per 14 CFR Section 97.3).
3. Type, configuration, and intensity of approach and runway lighting systems.
4. Type of obscuring phenomenon and/or windshield contamination.

**2.1.5** Even with weather conditions reported at or above minimums, under some combinations of reduced cockpit cutoff angle, approach/runway lighting, and high MDA/DH (coupled with a low visibility minima), the pilot may not be able to identify the required visual reference(s), or those references may only be visible in a very small portion of the available field of view. Even if identified by the pilot, the visual references may not support normal maneuvering and normal rates of descent to landing. The effect of such a combination may be exacerbated by other conditions such as rain on the windshield, or incomplete windshield defogging coverage.

**2.1.6** Pilots should always be prepared to execute a missed approach even though weather conditions may be reported at or above minimums.

**NOTE-**

See Section ENR 1.5, paragraph 27., Missed Approach, for additional information on missed approach procedures.

**3. Helicopter Approach Procedures to VFR Heliports**

**3.1** The FAA may develop helicopter instrument approaches for heliports that do not meet the design standards for an IFR heliport. The majority of IFR approaches to VFR heliports are developed in support of Helicopter Air Ambulance (HAA) operators. These approaches may require use of conventional NAVAIDS or a RNAV system (e.g. GPS). They may be developed either as a special approach (pilot training is required for special procedures due to their unique characteristics) or a public approach (no special training required). These instrument procedures may be designed to guide the helicopter to a specific landing area (Proceed Visually) or to a point-in-space with a “Proceed VFR” segment.

**3.1.1 An approach to a specific landing area.** This type of approach is aligned to a missed approach point from which a landing can be accomplished with a maximum course change of 30 degrees. The visual segment from the MAP to the landing area is evaluated for obstacle hazards. These procedures are annotated: “PROCEED VISUALLY FROM (named MAP) OR CONDUCT THE SPECIFIED MISSED APPROACH.”

**3.1.1.1** “Proceed visually” requires the pilot to acquire and maintain visual contact with the landing area at or prior to the MAP, or execute a missed approach. The visibility minimum is based on the distance from the MAP to the landing area, among other factors.

**3.1.1.2** The pilot is required to have the published minimum visibility throughout the visual segment flying the path described on the approach chart.

**3.1.1.3** Similar to an approach to a runway, the pilot is responsible for obstacle or terrain avoidance from the MAP to the landing area.

**3.1.1.4** Upon reaching the published MAP, or as soon as practicable thereafter, the pilot should advise ATC whether proceeding visually and canceling IFR or complying with the missed approach instructions. See Section ENR 1.10, paragraph 11.2, Canceling IFR Flight Plan.

**3.1.1.5** Where any necessary visual reference requirements are specified by the FAA, at least one of the following visual references for the intended heliport is visible and identifiable before the pilot may proceed visually:

- a) FATO or FATO lights.
- b) TLOF or TLOF lights.
- c) Heliport Instrument Lighting System (HILS).
- d) Heliport Approach Lighting System (HALS).
- e) Visual Glideslope Indicator (VGSI).
- f) Windsock or windsock light.
- g) Heliport beacon.
- h) Other facilities or systems approved by the Flight Technologies and Procedures Division (AFS–400).

**3.1.2 Approach to a Point-in-Space (PinS).** At locations where the MAP is located more than 2 SM from the landing area, or the path from the MAP to the landing area is populated with obstructions which require avoidance actions or requires turn greater than 30 degrees, a PinS Proceed VFR procedure may be developed. These approaches are annotated “PROCEED VFR FROM (named MAP) OR CONDUCT THE SPECIFIED MISSED APPROACH.”

**3.1.2.1** These procedures require the pilot, at or prior to the MAP, to determine if the published minimum visibility, or the weather minimums required by the operating rule (e.g. Part 91, Part 135, etc.), or operations specifications (whichever is higher) is available to safely transition from IFR to VFR flight. If not, the pilot must execute a missed approach. For Part 135 operations, pilots may not begin the instrument approach unless the latest weather report indicates that the weather conditions are at or above the authorized IFR minimums or the VFR weather minimums (as required by the class of airspace, operating rule and/or Operations Specifications) whichever is higher.

**3.1.2.2** Visual contact with the landing area is not required; however, the pilot must have the appropriate VFR weather minimums throughout the visual segment. The visibility is limited to no lower than that published in the procedure, until canceling IFR.

**3.1.2.3** IFR obstruction clearance areas are not applied to the VFR segment between the MAP and the landing area. Pilots are responsible for obstacle or terrain avoidance from the MAP to the landing area.

**3.1.2.4** Upon reaching the MAP defined on the approach procedure, or as soon as practicable thereafter, the pilot should advise ATC whether proceeding VFR and canceling IFR, or complying with the missed approach instructions. See Section ENR 1.10, paragraph 11.2, Canceling IFR Flight Plan.

**3.1.2.5** If the visual segment penetrates Class B, C, or D airspace, pilots are responsible for obtaining a Special VFR clearance, when required.

#### **4. The Gulf of Mexico Grid System**

**4.1** On October 8, 1998, the Southwest Regional Office of the FAA, with assistance from the Helicopter Safety Advisory Conference (HSAC), implemented the world’s first Instrument Flight Rules (IFR) Grid System in the Gulf of Mexico. This navigational route structure is completely independent of ground–based navigation aids (NAVAID) and was designed to facilitate helicopter IFR operations to offshore destinations. The Grid System is defined by over 300 offshore waypoints located 20 minutes apart (latitude and longitude). Flight plan routes are routinely defined by just 4 segments: departure point (lat/long), first en route grid waypoint, last en route grid waypoint prior to approach procedure, and destination point (lat/long). There are over 4,000 possible offshore landing sites. Upon reaching the waypoint prior to the destination, the pilot may execute an Offshore Standard Approach Procedure (OSAP), a Helicopter En Route Descent Areas (HEDA) approach, or an Airborne Radar Approach (ARA). For more information on these helicopter instrument procedures, refer to FAA AC 90–80B, Approval of Offshore Standard Approach Procedures, Airborne Radar Approaches, and Helicopter En Route Descent Areas, on the FAA website <http://www.faa.gov> under Advisory Circulars. The return flight plan is just the reverse with the requested stand–alone GPS approach contained in the remarks section.

**4.2** The large number (over 300) of waypoints in the grid system makes it difficult to assign phonetically pronounceable names to the waypoints that would be meaningful to pilots and controllers. A unique naming system was adopted that enables pilots and controllers to derive the fix position from the name. The five–letter names are derived as follows:

**4.2.1** The waypoints are divided into sets of 3 columns each. A three–letter identifier, identifying a geographical area or a NAVAID to the north, represents each set.

**4.2.2** Each column in a set is named after its position, i.e., left (L), center (C), and right (R).

**4.2.3** The rows of the grid are named alphabetically from north to south, starting with A for the northern most row.

**EXAMPLE–**

*LCHRC would be pronounced “Lake Charles Romeo Charlie.” The waypoint is in the right–hand column of the Lake Charles VOR set, in row C (third south from the northern most row).*

**4.3** In December 2009, significant improvements to the Gulf of Mexico grid system were realized with the introduction of ATC separation services using ADS–B. In cooperation with the oil and gas services industry, HSAC and Helicopter Association International (HAI), the FAA installed an infrastructure of ADS–B ground stations, weather stations (AWOS) and VHF remote communication outlets (RCO) throughout a large area of the Gulf of Mexico. This infrastructure allows the FAA’s Houston ARTCC to provide “domestic–like” air traffic control service in the offshore area beyond 12nm from the coastline to hundreds of miles offshore to aircraft equipped with ADS–B. Properly equipped aircraft can now be authorized to receive more direct routing, domestic en route separation minima and real time flight following. Operators who do not have authorization to receive ATC separation services using ADS–B, will continue to use the low altitude grid system and receive procedural separation from Houston ARTCC. Non–ADS–B equipped aircraft also benefit from improved VHF communication and expanded weather information coverage.

**4.4** Three requirements must be met for operators to file IFR flight plans utilizing the grid:

**4.4.1** The helicopter must be equipped for IFR operations and equipped with IFR approved GPS navigational units.

**4.4.2** The operator must obtain prior written approval from the appropriate Flight Standards District Office through a Letter of Authorization or Operations Specification, as appropriate.

**4.4.3** The operator must be a signatory to the Houston ARTCC Letter of Agreement.

**4.5** Operators who wish to benefit from ADS-B based ATC separation services must meet the following additional requirements:

**4.5.1** The Operator's installed ADS-B Out equipment must meet the performance requirements of one of the following FAA Technical Standard Orders (TSO), or later revisions: TSO-C154c, Universal Access Transceiver (UAT) Automatic Dependent Surveillance-Broadcast (ADS-B) Equipment, or TSO-C166b, Extended Squitter Automatic Dependent Surveillance-Broadcast (ADS-B) and Traffic Information.

**4.5.2** Flight crews must comply with the procedures prescribed in the Houston ARTCC Letter of Agreement dated December 17, 2009, or later.

**NOTE-**

*The unique ADS-B architecture in the Gulf of Mexico depends upon reception of an aircraft's Mode C in addition to the other message elements described in 14 CFR 91.227. Flight crews must be made aware that loss of Mode C also means that ATC will not receive the aircraft's ADS-B signal.*

**4.6** FAA/AIS publishes the grid system waypoints on the IFR Gulf of Mexico Vertical Flight Reference Chart. A commercial equivalent is also available. The chart is updated annually and is available from an FAA print provider or for free download on the AIS website: [http://www.faa.gov/air\\_traffic/flight\\_info/aeronav](http://www.faa.gov/air_traffic/flight_info/aeronav).

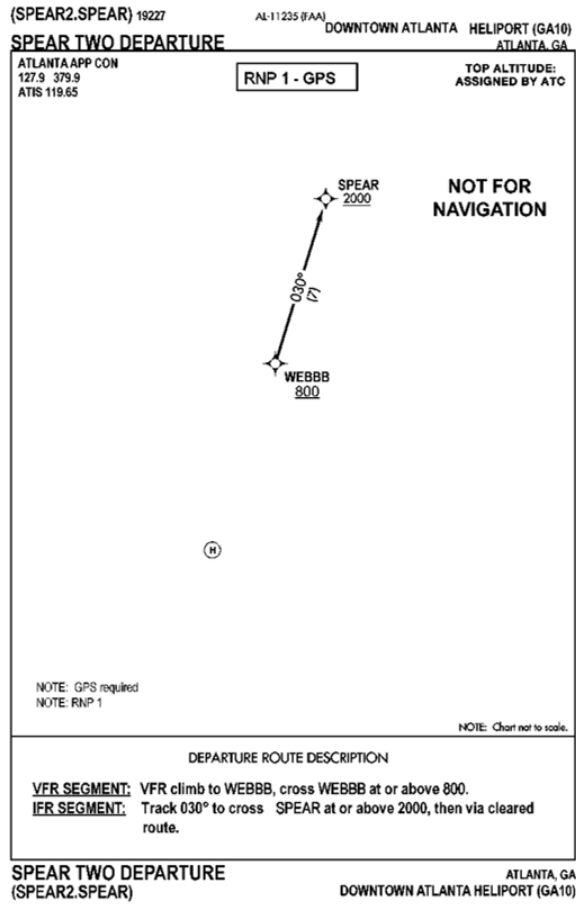
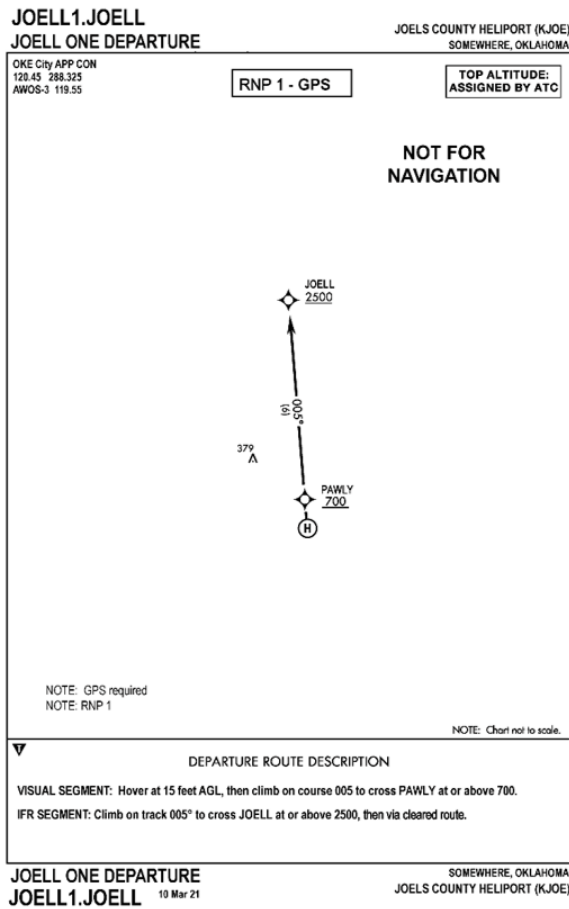
## **5. Departure Procedures**

**5.1** When departing from a location on a point-in-space (PinS) SID with a visual segment indicated and the departure instruction describes the visual segment the aircraft must cross the initial departure fix (IDF) outbound at-or-above the altitude depicted on the chart. The helicopter will initially establish a hover at or above the heliport crossing height (HCH) specified on the chart. The HCH specifies a minimum hover height to begin the climb to assist in avoiding obstacles. The helicopter will leave the departure location on the published outbound heading/course specified, climbing at least 400 ft/per NM (or as depicted on the chart), remaining clear of clouds, crossing at or above the IDF altitude specified, prior to proceeding outbound on the procedure. For example the chart may include these instructions: "Hover at 15 ft AGL, then climb on track 005, remaining clear of clouds, to cross PAWLY at or above 700."

**5.2** When flying a PinS procedure containing a segment with instructions to "proceed VFR," the pilot must keep the aircraft clear of the clouds and cross the IDF outbound at or above the altitude depicted. Departure procedures that support multiple departure locations will have a proceed VFR segment leading to the IDF. The chart will provide a bearing and distance to the IDF from the heliport. That bearing and distance are for pilot orientation purposes only and are not a required procedure track. The helicopter will leave the departure location via pilot navigation in order to align with the departure route and comply with the altitude specified at the IDF. For example, the chart may include these instructions: "VFR Climb to WEBBB, Cross WEBBB at or above 800."

**5.3** Once the aircraft reaches the IDF, the aircraft should proceed out the described route as specified on the chart, crossing each consecutive fix at or above the indicated altitude(s) until reaching the end of the departure or as directed by ATC.

FIG ENR 6.1-1  
Departure Charts



## ENR 6.2 Special Operations

### 1. Offshore Helicopter Operations

#### 1.1 Introduction

**1.1.1** The offshore environment offers unique applications and challenges for helicopter pilots. The mission demands, the nature of oil and gas exploration and production facilities, and the flight environment (weather, terrain, obstacles, traffic), demand special practices, techniques and procedures not found in other flight operations. Several industry organizations have risen to the task of reducing risks in offshore operations, including the Helicopter Safety Advisory Conference (HSAC) (<http://www.hsac.org>), and the Offshore Committee of the Helicopter Association International (HAI) (<https://rotor.org/>). The following recommended practices for offshore helicopter operations are based on guidance developed by HSAC for use in the Gulf of Mexico, and provided here with their permission. While not regulatory, these recommended practices provide aviation and oil and gas industry operators with useful information in developing procedures to avoid certain hazards of offshore helicopter operations.

**NOTE-**

*Like all aviation practices, these recommended practices are under constant review. Any questions or feedback concerning these recommended procedures may be directed to the HSAC through the feedback feature of the HSAC website (<http://www.hsac.org>).*

#### 1.2 Passenger Management on and about Heliport Facilities

**1.2.1 Background.** Several incidents involving offshore helicopter passengers have highlighted the potential for incidents and accidents on and about the heliport area. The following practices will minimize risks to passengers and others involved in heliport operations.

##### 1.2.2 Recommended Practices

**1.2.2.1** Heliport facilities should have a designated and posted passenger waiting area which is clear of the heliport, heliport access points, and stairways.

**1.2.2.2** Arriving passengers and cargo should be unloaded and cleared from the heliport and access route prior to loading departing passengers and cargo.

**1.2.2.3** Where a flight crew consists of more than one pilot, one crewmember should supervise the unloading/loading process from outside the aircraft.

**1.2.2.4** Where practical, a designated facility employee should assist with loading/unloading, etc.

#### 1.3 Crane-Helicopter Operational Procedures

**1.3.1 Background.** Historical experience has shown that catastrophic consequences can occur when industry safe practices for crane/helicopter operations are not observed. The following recommended practices are designed to minimize risks during crane and helicopter operations.

##### 1.3.2 Recommended Practices

###### 1.3.2.1 Personnel awareness

a) Crane operators and pilots should develop a mutual understanding and respect of the others' operational limitations and cooperate in the spirit of safety;

b) Pilots need to be aware that crane operators sometimes cannot release the load to cradle the crane boom, such as when attached to wire line lubricators or supporting diving bells; and

c) Crane operators need to be aware that helicopters require warm up before takeoff, a two-minute cool down before shutdown, and cannot circle for extended lengths of time because of fuel consumption.

**1.3.2.2** It is recommended that when helicopters are approaching, maneuvering, taking off, or running on the heliport, cranes be shutdown and the operator leave the cab. Cranes not in use must have their booms cradled, if feasible. If in use, the crane's boom(s) are to be pointed away from the heliport and the crane shutdown for helicopter operations.

**1.3.2.3** Pilots will not approach, land on, takeoff, or have rotor blades turning on heliports of structures not complying with the above practice.

**1.3.2.4** It is recommended that cranes on offshore platforms, rigs, vessels, or any other facility, which could interfere with helicopter operations (including approach/departure paths):

a) Be equipped with a red rotating beacon or red high intensity strobe light connected to the system powering the crane, indicating the crane is under power;

b) Be designed to allow the operator a maximum view of the helideck area and should be equipped with wide-angle mirrors to eliminate blind spots; and

c) Have their boom tips, headache balls, and hooks painted with high visibility international orange.

## **1.4 Helicopter/Tanker Operations**

**1.4.1 Background.** The interface of helicopters and tankers during shipboard helicopter operations is complex and may be hazardous unless appropriate procedures are coordinated among all parties. The following recommended practices are designed to minimize risks during helicopter/tanker operations.

### **1.4.2 Recommended Practices**

**1.4.2.1** Management, flight operations personnel, and pilots should be familiar with and apply the operating safety standards set forth in "Guide to Helicopter/Ship Operations", International Chamber of Shipping, Third Edition, 5-89 (as amended), establishing operational guidelines/standards and safe practices sufficient to safeguard helicopter/tanker operations.

**1.4.2.2** Appropriate plans, approvals, and communications must be accomplished prior to reaching the vessel, allowing tanker crews sufficient time to perform required safety preparations and position crew members to receive or dispatch a helicopter safely.

**1.4.2.3** Appropriate approvals and direct communications with the bridge of the tanker must be maintained throughout all helicopter/tanker operations.

**1.4.2.4** Helicopter/tanker operations, including landings/departures, must not be conducted until the helicopter pilot-in-command has received and acknowledged permission from the bridge of the tanker.

**1.4.2.5** Helicopter/tanker operations must not be conducted during product/cargo transfer.

**1.4.2.6** Generally, permission will not be granted to land on tankers during mooring operations or while maneuvering alongside another tanker.

## **1.5 Helideck/Heliport Operational Hazard Warning(s) Procedures**

### **1.5.1 Background**

**1.5.1.1** A number of operational hazards can develop on or near offshore helidecks or onshore heliports that can be minimized through procedures for proper notification or visual warning to pilots. Examples of hazards include but are not limited to:

a) Perforating operations: subparagraph 1.6.

b) H<sub>2</sub>S gas presence: subparagraph 1.7.

c) Gas venting: subparagraph 1.8; or,

d) Closed helidecks or heliports: subparagraph 1.9 (unspecified cause).

**1.5.1.2** These and other operational hazards are currently minimized through timely dissemination of a written Notice to Air Missions (NOTAM) for pilots by helicopter companies and operators. A NOTAM provides a



written description of the hazard, time and duration of occurrence, and other pertinent information. ANY POTENTIAL HAZARD should be communicated to helicopter operators or company aviation departments as early as possible to allow the NOTAM to be activated.

**1.5.1.3** To supplement the existing NOTAM procedure and further assist in reducing these hazards, a standardized visual signal(s) on the helideck/heliport will provide a positive indication to an approaching helicopter of the status of the landing area. Recommended Practice(s) have been developed to reinforce the NOTAM procedures and standardize visual signals.

### **1.6 Drilling Rig Perforating Operations: Helideck/Heliport Operational Hazard Warning(s)/Procedure(s)**

**1.6.1 Background.** A critical step in the oil well completion process is perforation, which involves the use of explosive charges in the drill pipe to open the pipe to oil or gas deposits. Explosive charges used in conjunction with perforation operations offshore can potentially be prematurely detonated by radio transmissions, including those from helicopters. The following practices are recommended.

#### **1.6.2 Recommended Practices**

**1.6.2.1 Personnel Conducting Perforating Operations.** Whenever perforating operations are scheduled and operators are concerned that radio transmissions from helicopters in the vicinity may jeopardize the operation, personnel conducting perforating operations should take the following precautionary measures:

a) Notify company aviation departments, helicopter operators or bases, and nearby manned platforms of the pending perforation operation so the Notice to Air Missions (NOTAM) system can be activated for the perforation operation and the temporary helideck closure.

b) Close the deck and make the radio warning clearly visible to passing pilots, install a temporary marking (described in subparagraph 1.9.1.2 with the words “NO RADIO” stenciled in red on the legs of the diagonals. The letters should be 24 inches high and 12 inches wide. (See FIG ENR 6.2-1.)

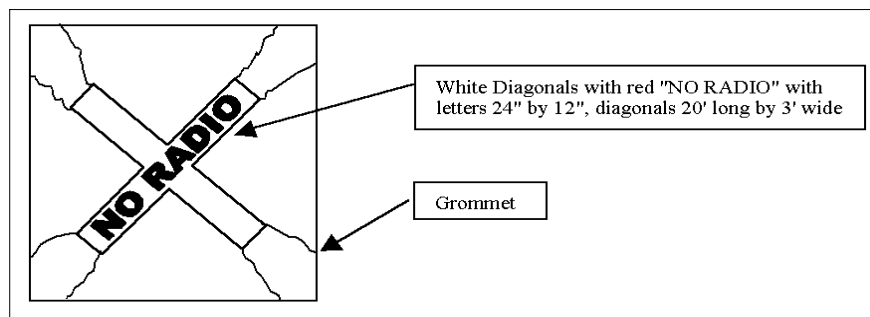
c) The marker should be installed during the time that charges may be affected by radio transmissions.

#### **1.6.2.2 Pilots**

a) When operating within 1,000 feet of a known perforation operation or observing the white X with red “NO RADIO” warning indicating perforation operations are underway, pilots will avoid radio transmissions from or near the helideck (within 1,000 feet) and will not land on the deck if the X is present. In addition to communications radios, radio transmissions are also emitted by aircraft radar, transponders, ADS-B equipment, radar altimeters, and DME equipment, and ELTs.

b) Whenever possible, make radio calls to the platform being approached or to the Flight Following Communications Center at least one mile out on approach. Ensure all communications are complete outside the 1,000 foot hazard distance. If no response is received, or if the platform is not radio equipped, further radio transmissions should not be made until visual contact with the deck indicates it is open for operation (no white “X”).

**FIG ENR 6.2-1**  
**Closed Helideck Marking - No Radio**



## 1.7 Hydrogen Sulfide Gas Helideck/Heliport Operational Hazard Warning(s)/Procedures

**1.7.1 Background.** Hydrogen sulfide (H<sub>2</sub>S) gas: Hydrogen sulfide gas in higher concentrations (300–500 ppm) can cause loss of consciousness within a few seconds and presents a hazard to pilots on/near offshore helidecks. When operating in offshore areas that have been identified to have concentrations of hydrogen sulfide gas, the following practices are recommended.

### 1.7.2 Recommended Practices

#### 1.7.2.1 Pilots

- a) Ensure approved protective air packs are available for emergency use by the crew on the helicopter.
- b) If shutdown on a helideck, request the supervisor in charge provide a briefing on location of protective equipment and safety procedures.
- c) If while flying near a helideck and the visual red beacon alarm is observed or an unusually strong odor of “rotten eggs” is detected, immediately don the protective air pack, exit to an area upwind, and notify the suspected source field of the hazard.

#### 1.7.2.2 Oil Field Supervisors

- a) If presence of hydrogen sulfide is detected, a red rotating beacon or red high intensity strobe light adjacent to the primary helideck stairwell or wind indicator on the structure should be turned on to provide visual warning of hazard. If the beacon is to be located near the stairwell, the State of Louisiana “Offshore Heliport Design Guide” and FAA Advisory Circular AC 150/5390-2A, “Heliport Design Guide,” should be reviewed to ensure proper clearance on the helideck.
- b) Notify nearby helicopter operators and bases of the hazard and advise when hazard is cleared.
- c) Provide a safety briefing to include location of protective equipment to all arriving personnel.
- d) Wind socks or indicator should be clearly visible to provide upwind indication for the pilot.

## 1.8 Gas Venting Helideck/Heliport Operational Hazard Warning(s)/Procedures – Operations Near Gas Vent Booms

**1.8.1 Background.** Ignited flare booms can release a large volume of natural gas and create a hot fire and intense heat with little time for the pilot to react. Likewise, unignited gas vents can release reasonably large volumes of methane gas under certain conditions. Thus, operations conducted very near unignited gas vents require precautions to prevent inadvertent ingestion of combustible gases by the helicopter engine(s). The following practices are recommended.

### 1.8.2 Pilots

**1.8.2.1** Gas will drift upwards and downwind of the vent. Plan the approach and takeoff to observe and avoid the area downwind of the vent, remaining as far away as practicable from the open end of the vent boom.

**1.8.2.2** Do not attempt to start or land on an offshore helideck when the deck is downwind of a gas vent unless properly trained personnel verify conditions are safe.

### 1.8.3 Oil Field Supervisors

**1.8.3.1** During venting of large amounts of unignited raw gas, a red rotating beacon or red high intensity strobe light adjacent to the primary helideck stairwell or wind indicator should be turned on to provide visible warning of hazard. If the beacon is to be located near the stairwell, the State of Louisiana “Offshore Heliport Design Guide” and FAA Advisory Circular AC 150/5390-2A, Heliport Design Guide, should be reviewed to ensure proper clearance from the helideck.

**1.8.3.2** Notify nearby helicopter operators and bases of the hazard for planned operations.

**1.8.3.3** Wind socks or indicator should be clearly visible to provide upward indication for the pilot.

## 1.9 Helideck/Heliport Operational Warning(s)/ Procedure(s) – Closed Helidecks or Heliports

**1.9.1 Background.** A white “X” marked diagonally from corner to corner across a helideck or heliport touchdown area is the universally accepted visual indicator that the landing area is closed for safety of other reasons and that helicopter operations are not permitted. The following practices are recommended.

**1.9.1.1 Permanent Closing.** If a helideck or heliport is to be permanently closed, X diagonals of the same size and location as indicated above should be used, but the markings should be painted on the landing area.

**NOTE–**

*White Decks: If a helideck is painted white, then international orange or yellow markings can be used for the temporary or permanent diagonals.*

**1.9.1.2 Temporary Closing.** A temporary marker can be used for hazards of an interim nature. This marker could be made from vinyl or other durable material in the shape of a diagonal “X.” The marker should be white with legs at least 20 feet long and 3 feet in width. This marker is designed to be quickly secured and removed from the deck using grommets and rope ties. The duration, time, location, and nature of these temporary closings should be provided to and coordinated with company aviation departments, nearby helicopter bases, and helicopter operators supporting the area. These markers **MUST** be removed when the hazard no longer exists. (See FIG ENR 6.2-2.)

## 1.10 Offshore (VFR) Operating Altitudes for Helicopters

**1.10.1 Background.** Mid-air collisions constitute a significant percentage of total fatal offshore helicopter accidents. A method of reducing this risk is the use of coordinated VFR cruising altitudes. To enhance safety through standardized vertical separation of helicopters when flying in the offshore environment, it is recommended that helicopter operators flying in a particular area establish a cooperatively developed Standard Operating Procedure (SOP) for VFR operating altitudes. An example of such an SOP is contained in this example.

### 1.10.2 Recommended Practice Example

**1.10.2.1 Field Operations.** Without compromising minimum safe operating altitudes, helicopters working within an offshore field “constituting a cluster” should use altitudes not to exceed 500 feet.

#### 1.10.2.2 En Route Operations

- a) Helicopters operating below 750’ AGL should avoid transitioning through offshore fields.
- b) Helicopters en route to and from offshore locations, below 3,000 feet, weather permitting, should use en route altitudes as outlined in TBL ENR 6.2-1.

TBL ENR 6.2-1

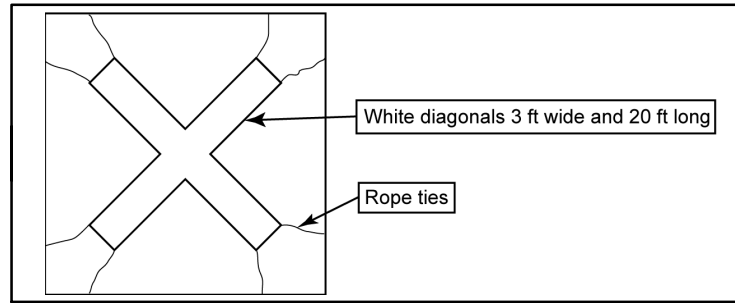
Magnetic Heading	Altitude
0° to 179°	750’
	1750’
	2750’
180° to 359°	1250’
	2250’

**c) Area Agreements.** See HSAC Area Agreement Maps for operating procedures for onshore high density traffic locations.

**NOTE–**

*Pilots of helicopters operating VFR above 3,000 feet above the surface should refer to the current Federal Aviation Regulations (14 CFR Part 91), and Section ENR 1.4, Paragraph 1.7, Basic VFR Weather Minimums, of the AIP.*

FIG ENR 6.2-2  
Closed Helideck Marking



d) **Landing Lights.** Aircraft landing lights should be on to enhance aircraft identification:

- 1) During takeoff and landings;
- 2) In congested helicopter or fixed wing traffic areas;
- 3) During reduced visibility; or,
- 4) Anytime safety could be enhanced.

### 1.11 Offshore Helidecks/Landing Communications

**1.11.1 Background.** To enhance safety, and provide appropriate time to prepare for helicopter operations, the following is recommended when anticipating a landing on an offshore helideck.

#### 1.11.2 Recommended Practices

**1.11.2.1** Before landing on an offshore helideck, pilots are encouraged to establish communications with the company owning or operating the helideck if frequencies exist for that purpose.

**1.11.2.2** When impracticable, or if frequencies do not exist, pilots or operations personnel should attempt to contact the company owning or operating the helideck by telephone. Contact should be made before the pilot departs home base/point of departure to advise of intentions and obtain landing permission if necessary.

**NOTE-**

*It is recommended that communications be established a minimum of 10 minutes prior to planned arrival time. This practice may be a requirement of some offshore owner/operators.*

**NOTE-**

1. See subparagraph 1.4 for Tanker Operations.

2. Private use Heliport. Offshore heliports are privately owned/operated facilities and their use is limited to persons having prior authorization to utilize the facility.

### 1.12 Two (2) Helicopter Operations on Offshore Helidecks

**1.12.1 Background.** Standardized procedures can enhance the safety of operating a second helicopter on an offshore helideck, enabling pilots to determine/maintain minimum operational parameters. Orientation of the parked helicopter on the helideck, wind and other factors may prohibit multi-helicopter operations. More conservative Rotor Diameter (RD) clearances may be required under differing condition, i.e. temperature, wet deck, wind (velocity/direction/gusts), obstacles, approach/departure angles, etc. Operations are at the pilot's discretion.

**1.12.2 Recommended Practice.** Helideck size, structural weight capability, and type of main rotor on the parked and operating helicopter will aid in determining accessibility by a second helicopter. Pilots should determine that multi-helicopter deck operations are permitted by the helideck owner/operator.

#### 1.12.3 Recommended Criteria

**1.12.3.1 Minimum one-third rotor diameter clearance ( $\frac{1}{3}$  RD).** The landing helicopter maintains a minimum  $\frac{1}{3}$  RD clearance between the tips of its turning rotor and the closest part of a parked and secured helicopter (rotors stopped and tied down).

**1.12.3.2 Three foot parking distance from deck edge (3').** Helicopters operating on an offshore helideck land or park the helicopter with a skid/wheel assembly no closer than 3 feet from helideck edge.

**1.12.3.3 Tiedowns.** Main rotors on all helicopters that are shut down be properly secured (tied down) to prevent the rotor blades from turning.

**1.12.3.4** Medium (transport) and larger helicopters should not land on any offshore helideck where a light helicopter is parked unless the light helicopter is properly secured to the helideck and has main rotor tied down.

**1.12.3.5** Helideck owners/operators should ensure that the helideck has a serviceable anti-skid surface.

**1.12.4 Weight and limitations markings on helideck.** The helideck weight limitations should be displayed by markings visible to the pilot (see State of Louisiana “Offshore Heliport Design Guide” and FAA Advisory Circular AC 150/ 5390-2A, Heliport Design Guide).

**NOTE-**

*Some offshore helideck owners/operators have restrictions on the number of helicopters allowed on a helideck. When helideck size permits, multiple (more than two) helicopter operations are permitted by some operators.*

**1.13 Helicopter Rapid Refueling Procedures (HRR)**

**1.13.1 Background.** Helicopter Rapid Refueling (HRR), engine(s)/rotors operating, can be conducted safely when utilizing trained personnel and observing safe practices. This recommended practice provides minimum guidance for HRR as outlined in National Fire Protection Association (NFPA) and industry practices. For detailed guidance, please refer to National Fire Protection Association (NFPA) Document 407, “Standard for Aircraft Fuel Servicing,” 1990 edition, including 1993 HRR Amendment.

**NOTE-**

*Certain operators prohibit HRR, or “hot refueling,” or may have specific procedures for certain aircraft or refueling locations. See the General Operations Manual and/or Operations Specifications to determine the applicable procedures or limitations.*

**1.13.2 Recommended Practices**

**1.13.2.1** Only turbine-engine helicopters fueled with JET A or JET A-1 with fueling ports located below any engine exhausts may be fueled while an onboard engine(s) is (are) operating.

**1.13.2.2** Helicopter fueling while an onboard engine(s) is (are) operating should only be conducted under the following conditions:

a) A properly certificated and current pilot is at the controls and a trained refueler attending the fuel nozzle during the entire fuel servicing process. The pilot monitors the fuel quantity and signals the refueler when quantity is reached.

b) No electrical storms (thunderstorms) are present within 10 nautical miles. Lightning can travel great distances beyond the actual thunderstorm.

c) Passengers disembark the helicopter and move to a safe location prior to HRR operations. When the pilot-in-command deems it necessary for passenger safety that they remain onboard, passengers should be briefed on the evacuation route to follow to clear the area.

d) Passengers not board or disembark during HRR operations nor should cargo be loaded or unloaded.

e) Only designated personnel, trained in HRR operations should conduct HRR written authorization to include safe handling of the fuel and equipment. (See your Company Operations/Safety Manual for detailed instructions.)

f) All doors, windows, and access points allowing entry to the interior of the helicopter that are adjacent to or in the immediate vicinity of the fuel inlet ports kept closed during HRR operations.

g) Pilots ensure that appropriate electrical/electronic equipment is placed in standby–off position, to preclude the possibility of electrical discharge or other fire hazard, such as [i.e., weather radar is on standby and no radio transmissions are made (keying of the microphone/transmitter)]. Remember, in addition to communications radios, radio transmissions are also emitted by aircraft radar, transponders, ADS–B equipment, radar altimeters, DME equipment, and ELTs.

h) Smoking be prohibited in and around the helicopter during all HRR operations.

The HRR procedures are critical and present associated hazards requiring attention to detail regarding quality control, weather conditions, static electricity, bonding, and spill/fires potential.

Any activity associated with rotors turning (i.e., refueling embarking/disembarking, loading/unloading baggage/freight, etc.) personnel should only approach the aircraft when authorized to do so. Approach should be made via safe approach path/walkway or “arc”– **remain clear of all rotors.**

**NOTE–**

1. *Marine vessels, barges etc.: Vessel motion presents additional potential hazards to helicopter operations (blade flex, aircraft movement).*

2. *See National Fire Protection Association (NFPA) Document 407, “Standard for Aircraft Fuel Servicing” for specifics regarding non–HRR (routine refueling operations).*

## 2. Helicopter Night VFR Operations

### 2.1 Effect of Lighting on Seeing Conditions in Night VFR Helicopter Operations

**NOTE–**

*This guidance was developed to support safe night VFR helicopter emergency medical services (HEMS) operations. The principles of lighting and seeing conditions are useful in any night VFR operation.*

While ceiling and visibility significantly affect safety in night VFR operations, lighting conditions also have a profound effect on safety. Even in conditions in which visibility and ceiling are determined to be visual meteorological conditions, the ability to discern unlighted or low contrast objects and terrain at night may be compromised. The ability to discern these objects and terrain is the seeing condition, and is related to the amount of natural and man made lighting available, and the contrast, reflectivity, and texture of surface terrain and obstruction features. In order to conduct operations safely, seeing conditions must be accounted for in the planning and execution of night VFR operations.

Night VFR seeing conditions can be described by identifying “high lighting conditions” and “low lighting conditions.”

2.1.1 High lighting conditions exist when one of two sets of conditions are present:

2.1.1.1 The sky cover is less than broken (less than 5/8 cloud cover), the time is between the local Moon rise and Moon set, and the lunar disk is at least 50% illuminated; or

2.1.1.2 The aircraft is operated over surface lighting which, at least, provides for the lighting of prominent obstacles, the identification of terrain features (shorelines, valleys, hills, mountains, slopes) and a horizontal reference by which the pilot may control the helicopter. For example, this surface lighting may be the result of:

a) Extensive cultural lighting (man–made, such as a built–up area of a city),

b) Significant reflected cultural lighting (such as the illumination caused by the reflection of a major metropolitan area’s lighting reflecting off a cloud ceiling), or

c) Limited cultural lighting combined with a high level of natural reflectivity of celestial illumination, such as that provided by a surface covered by snow or a desert surface.

2.1.2 Low lighting conditions are those that do not meet the high lighting conditions requirements.

2.1.3 Some areas may be considered a high lighting environment only in specific circumstances. For example, some surfaces, such as a forest with limited cultural lighting, normally have little reflectivity, requiring

dependence on significant moonlight to achieve a high lighting condition. However, when that same forest is covered with snow, its reflectivity may support a high lighting condition based only on starlight. Similarly, a desolate area, with little cultural lighting, such as a desert, may have such inherent natural reflectivity that it may be considered a high lighting conditions area regardless of season, provided the cloud cover does not prevent starlight from being reflected from the surface. Other surfaces, such as areas of open water, may never have enough reflectivity or cultural lighting to ever be characterized as a high lighting area.

**2.1.4** Through the accumulation of night flying experience in a particular area, the operator will develop the ability to determine, prior to departure, which areas can be considered supporting high or low lighting conditions. Without that operational experience, low lighting considerations should be applied by operators for both pre-flight planning and operations until high lighting conditions are observed or determined to be regularly available.

## **2.2 Astronomical Definitions and Background Information for Night Operations**

### **2.2.1 Definitions**

**2.2.1.1** Horizon. Wherever one is located on or near the Earth's surface, the Earth is perceived as essentially flat and, therefore, as a plane. If there are no visual obstructions, the apparent intersection of the sky with the Earth's (plane) surface is the horizon, which appears as a circle centered at the observer. For rise/set computations, the observer's eye is considered to be on the surface of the Earth, so that the horizon is geometrically exactly 90 degrees from the local vertical direction.

**2.2.1.2** Rise, Set. During the course of a day the Earth rotates once on its axis causing the phenomena of rising and setting. All celestial bodies, the Sun, Moon, stars and planets, seem to appear in the sky at the horizon to the East of any particular place, then to cross the sky and again disappear at the horizon to the West. Because the Sun and Moon appear as circular disks and not as points of light, a definition of rise or set must be very specific, because not all of either body is seen to rise or set at once.

**2.2.1.3** Sunrise and sunset refer to the times when the upper edge of the disk of the Sun is on the horizon, considered unobstructed relative to the location of interest. Atmospheric conditions are assumed to be average, and the location is in a level region on the Earth's surface.

**2.2.1.4** Moonrise and moonset times are computed for exactly the same circumstances as for sunrise and sunset. However, moonrise and moonset may occur at any time during a 24 hour period and, consequently, it is often possible for the Moon to be seen during daylight, and to have moonless nights. It is also possible that a moonrise or moonset does not occur relative to a specific place on a given date.

**2.2.1.5** Transit. The transit time of a celestial body refers to the instant that its center crosses an imaginary line in the sky – the observer's meridian – running from north to south.

**2.2.1.6** Twilight. Before sunrise and again after sunset there are intervals of time, known as "twilight," during which there is natural light provided by the upper atmosphere, which does receive direct sunlight and reflects part of it toward the Earth's surface.

**2.2.1.7** Civil twilight is defined to begin in the morning, and to end in the evening when the center of the Sun is geometrically 6 degrees below the horizon. This is the limit at which twilight illumination is sufficient, under good weather conditions, for terrestrial objects to be clearly distinguished.

**2.2.2** Title 14 of the Code of Federal Regulations applies these concepts and definitions in addressing the definition of night (Section 1.1), the requirement for aircraft lighting (Section 91.209) and pilot recency of night experience (Section 61.67).

### **2.2.3 Information on Moon Phases and Changes in the Percentage of the Moon Illuminated**

From any location on the Earth, the Moon appears to be a circular disk which, at any specific time, is illuminated to some degree by direct sunlight. During each lunar orbit (a lunar month), we see the Moon's appearance change from not visibly illuminated through partially illuminated to fully illuminated, then back through partially illuminated to not illuminated again. There are eight distinct, traditionally recognized stages, called phases. The

phases designate both the degree to which the Moon is illuminated and the geometric appearance of the illuminated part. These phases of the Moon, in the sequence of their occurrence (starting from New Moon), are listed in FIG ENR 6.2-3.

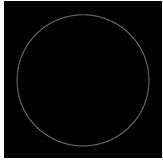
**2.2.3.1** The percent of the Moon's surface illuminated is a more refined, quantitative description of the Moon's appearance than is the phase. Considering the Moon as a circular disk, at New Moon the percent illuminated is 0; at First and Last Quarters it is 50%; and at Full Moon it is 100%. During the crescent phases the percent illuminated is between 0 and 50% and during gibbous phases it is between 50% and 100%.

**2.2.3.2** For practical purposes, phases of the Moon and the percent of the Moon illuminated are independent of the location on the Earth from where the Moon is observed. That is, all the phases occur at the same time regardless of the observer's position.

**2.2.3.3** For more detailed information, refer to the United States Naval Observatory site referenced below.



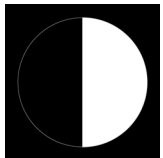
**FIG ENR 6.2-3  
Phases of the Moon**



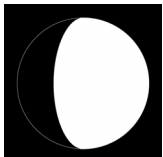
New Moon – The Moon’s unilluminated side is facing the Earth. The Moon is not visible (except during a solar eclipse).



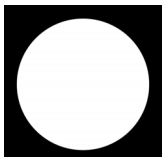
Waxing Crescent – The Moon appears to be partly but less than one-half illuminated by direct sunlight. The fraction of the Moon’s disk that is illuminated is increasing.



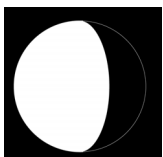
First Quarter – One-half of the Moon appears to be illuminated by direct sunlight. The fraction of the Moon’s disk that is illuminated is increasing.



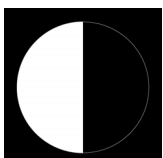
Waxing Gibbous – The Moon appears to be more than one-half but not fully illuminated by direct sunlight. The fraction of the Moon’s disk that is illuminated is increasing.



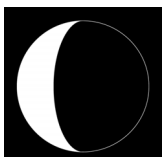
Full Moon – The Moon’s illuminated side is facing the Earth. The Moon appears to be completely illuminated by direct sunlight.



Waning Gibbous – The Moon appears to be more than one-half but not fully illuminated by direct sunlight. The fraction of the Moon’s disk that is illuminated is decreasing.



Last Quarter – One-half of the Moon appears to be illuminated by direct sunlight. The fraction of the Moon’s disk that is illuminated is decreasing.



Waning Crescent – The Moon appears to be partly but less than one-half illuminated by direct sunlight. The fraction of the Moon’s disk that is illuminated is decreasing.

**2.2.4 Access to Astronomical Data for Determination of Moon Rise, Moon Set, and Percentage of Lunar Disk Illuminated**

**2.2.4.1** Astronomical data for the determination of Moon rise and set and Moon phase may be obtained from the United States Naval Observatory using an interactive query available at: <http://aa.usno.navy.mil/>.

**2.2.4.2** Click on “Data Services,” and then on “Complete Sun and Moon Data for One Day.”

**2.2.4.3** You can obtain the times of sunrise, sunset, moonrise, moonset, transits of the Sun and Moon, and the beginning and end of civil twilight, along with information on the Moon’s phase by specifying the date and location in one of the two forms on this web page and clicking on the “Get data” button at the end of the form. Form “A” is used for cities or towns in the U.S. or its territories. Form “B” for all other locations. An example of the data available from this site is shown in TBL ENR 6.2-2.

**2.2.4.4** Additionally, a yearly table may be constructed for a particular location by using the “Table of Sunrise/Sunset, Moonrise/Moonset, or Twilight Times for an Entire Year” selection.

**3. Landing Zone Safety**

**3.1** This information is provided for use by helicopter emergency medical services (HEMS) pilots, program managers, medical personnel, law enforcement, fire, and rescue personnel to further their understanding of the safety issues concerning Landing Zones (LZs). It is recommended that HEMS operators establish working relationships with the ground responder organizations they may come in contact with in their flight operations and share this information in order to establish a common frame of reference for LZ selection, operations, and safety.

*TBL ENR 6.2-2*  
**Sample of Astronomical Data Available from the Naval Observatory**

<b>The following information is provided for New Orleans, Orleans Parish, Louisiana (longitude W90.1, latitude N30.0)</b>	
Tuesday 29 May 2007	Central Daylight Time
SUN	
Begin civil twilight	5:34 a.m.
Sunrise	6:01 a.m.
Sun transit	12:58 p.m.
Sunset	7:55 p.m.
End civil twilight	8:22 p.m.
MOON	
Moonrise	5:10 p.m. on preceding day
Moonset	4:07 a.m.
Moonrise	6:06 p.m.
Moon transit	11:26 p.m.
Moonset	4:41 a.m. on following day
Phase of the Moon on 29 May: waxing gibbous with 95% of the Moon’s visible disk illuminated.	
Full Moon on 31 May 2007 at 8:04 p.m. Central Daylight Time.	

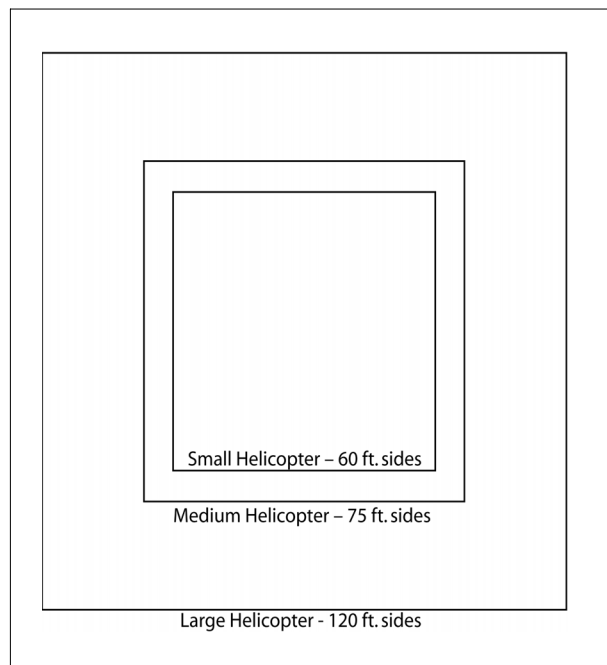
**3.2** The information provided is largely based on the booklet, LZ – Preparing the Landing Zone, issued by National Emergency Medical Services Pilots Association (NEMSPA), and the guidance developed by the University of Tennessee Medical Center’s LIFESTAR program, and is used with their permission. For additional information, go to: <http://www.nemspa.org/>.

**3.3** Information concerning the estimation of wind velocity is based on the Beaufort Scale. See <http://www.spc.noaa.gov/faq/tornado/beaufort.html> for more information.

### **3.4 Selecting a Scene LZ**

**3.4.1** If the situation requires the use of a helicopter, first check to see if there is an area large enough to land a helicopter safely.

**FIG ENR 6.2-4  
Recommended Minimum Landing Zone Dimensions**



**3.4.2** For the purposes of FIG ENR 6.2-4 the following are provided as examples of relative helicopter size:

**3.4.2.1** Small Helicopter: Bell 206/407, Eurocopter AS-350/355, BO-105, BK-117.

**3.4.2.2** Medium Helicopter: Bell UH-1 (Huey) and derivatives (Bell 212/412), Bell 222/230/430 Sikorsky S-76, Eurocopter SA-365.

**3.4.2.3** Large Helicopter: Boeing Chinook, Eurocopter Puma, Sikorsky H-60 series (Blackhawk), SK-92.

**3.4.3** The LZ should be level, firm and free of loose debris that could possibly blow up into the rotor system.

**3.4.4** The LZ should be clear of people, vehicles and obstructions such as trees, poles and wires. Remember that wires are difficult to see from the air. The LZ must also be free of stumps, brush, post and large rocks. See FIG ENR 6.2-5.

FIG ENR 6.2-5  
Landing Zone Hazards



**3.4.5** Keep spectators back at least 200 feet. Keep emergency vehicles 100 feet away and have fire equipment (if available) standing by. Ground personnel should wear eye protection, if available, during landing and takeoff operations. To avoid loose objects being blown around in the LZ, hats should be removed; if helmets are worn, chin straps must be securely fastened.

**3.4.6** Fire fighters (if available) should wet down the LZ if it is extremely dusty.

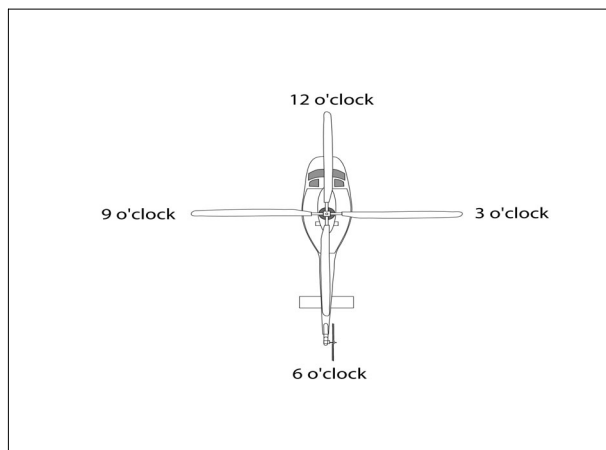
### 3.5 Helping the Flightcrew Locate the Scene

**3.5.1** If the LZ coordinator has access to a GPS unit, the exact latitude and longitude of the LZ should be relayed to the HEMS pilot. If unable to contact the pilot directly, relay the information to the HEMS ground communications specialist for relaying to the pilot, so that they may locate your scene more efficiently. Recognize that the aircraft may approach from a direction different than the direct path from the takeoff point to the scene, as the pilot may have to detour around terrain, obstructions or weather en route.

**3.5.2** Especially in daylight hours, mountainous and densely populated areas can make sighting a scene from the air difficult. Often, the LZ coordinator on the ground will be asked if she or he can see or hear the helicopter.

**3.5.3** Flightcrews use a clock reference method for directing one another's attention to a certain direction from the aircraft. The nose of the aircraft is always 12 o'clock, the right side is 3 o'clock, etc. When the LZ coordinator sees the aircraft, he/she should use this method to assist the flightcrew by indicating the scene's clock reference position from the nose of the aircraft. For example, "Accident scene is located at your 2 o'clock position." See FIG ENR 6.2-6.

FIG ENR 6.2-6  
"Clock" System for Identifying Positions Relative to the Nose of the Aircraft



**3.5.4** When the helicopter approaches the scene, it will normally orbit at least one time as the flight crew observes the wind direction and obstacles that could interfere with the landing. This is often referred to as the “high reconnaissance” maneuver.

### 3.6 Wind Direction and Touchdown Area

**3.6.1** Determine from which direction the wind is blowing. Helicopters normally land and takeoff into the wind.

**3.6.2** If contact can be established with the pilot, either directly or indirectly through the HEMS ground communications specialist, describe the wind in terms of the direction the wind is *from* and the speed.

**3.6.3** Common natural sources of wind direction information are smoke, dust, vegetation movement, water streaks and waves. Flags, pennants, streamers can also be used. When describing the direction, use the compass direction from which the wind is blowing (example: from the North–West).

**3.6.4** Wind speed can be measured by small hand–held measurement devices, or an observer’s estimate can be used to provide velocity information. The wind value should be reported in knots (nautical miles per hour). If unable to numerically measure wind speed, use TBL ENR 6.2–3 to estimate velocity. Also, report if the wind conditions are gusty, or if the wind direction or velocity is variable or has changed recently.

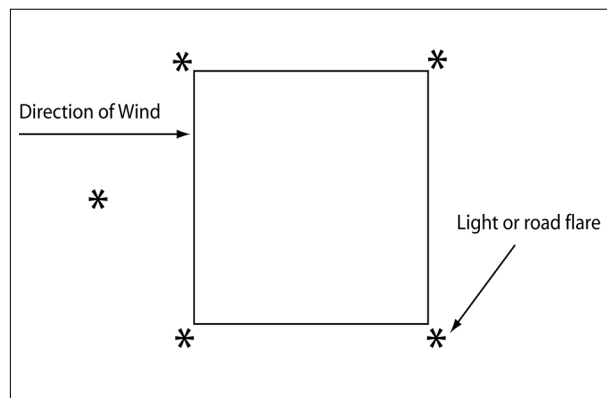
**3.6.5** If any obstacle(s) exist, insure their description, position and approximate height are communicated to the pilot on the initial radio call.

### 3.7 Night LZs

**3.7.1** There are several ways to light a night LZ:

**3.7.1.1** Mark the touchdown area with five lights or road flares, one in each corner and one indicating the direction of the wind. See FIG ENR 6.2–7.

**FIG ENR 6.2–7**  
**Recommended Lighting for Landing Zone Operations at Night**



**NOTE–**

Road flares are an intense source of ignition and may be unsuitable or dangerous in certain conditions. In any case, they must be closely managed and firefighting equipment should be present when used. Other light sources are preferred, if available.

*TBL ENR 6.2–3*  
**Table of Common References for Estimating Wind Velocity**

Wind (Knots)	Wind Classification	Appearance of Wind Effects	
		On the Water	On Land
Less than 1	Calm	Sea surface smooth and mirror–like	Calm, smoke rises vertically
1–3	Light Air	Scaly ripples, no foam crests	Smoke drift indicates wind direction, wind vanes are still
4–6	Light Breeze	Small wavelets, crests glassy, no breaking	Wind felt on face, leaves rustle, vanes begin to move
7–10	Gentle Breeze	Large wavelets, crests begin to break, scattered whitecaps	Leaves and small twigs constantly moving, light flags extended
11–16	Moderate Breeze	Small waves 1–4 ft. becoming longer, numerous whitecaps	Dust, leaves, and loose paper lifted, small tree branches move
17–21	Fresh Breeze	Moderate waves 4–8 ft taking longer form, many whitecaps, some spray	Small trees in leaf begin to sway
22–27	Strong Breeze	Larger waves 8–13 ft, whitecaps common, more spray	Larger tree branches moving, whistling in wires
28–33	Near Gale	Sea heaps up, waves 13–20 ft, white foam streaks off breakers	Whole trees moving, resistance felt walking against wind
34–40	Gale	Moderately high (13–20 ft) waves of greater length, edges of crests begin to break into spindrift, foam blown in streaks	Whole trees in motion, resistance felt walking against wind
41–47	Strong Gale	High waves (20 ft), sea begins to roll, dense streaks of foam, spray may reduce visibility	Slight structural damage occurs, slate blows off roofs
48–55	Storm	Very high waves (20–30 ft) with overhanging crests, sea white with densely blown foam, heavy rolling, lowered visibility	Seldom experienced on land, trees broken or uprooted, “considerable structural damage”
56–63	Violent Storm	Exceptionally high (30–45 ft) waves, foam patches cover sea, visibility more reduced	
64+	Hurricane	Air filled with foam, waves over 45 ft, sea completely white with driving spray, visibility greatly reduced	

**EXAMPLE–**

*Wind from the South–East, estimated speed 15 knots. Wind shifted from North–East about fifteen minutes ago, and is gusty.*

**3.7.1.2** If chemical light sticks may be used, care should be taken to assure they are adequately secured against being dislodged by the helicopter’s rotor wash.

**3.7.1.3** Another method of marking a LZ uses four emergency vehicles with their low beam headlights aimed toward the intended landing area.

**3.7.1.4** A third method for marking a LZ uses two vehicles. Have the vehicles direct their headlight beams into the wind, crossing at the center of the LZ. (If fire/rescue personnel are available, the reflective stripes on their bunker gear will assist the pilot greatly.)

**3.7.2** At night, spotlights, flood lights and hand lights used to define the LZ are not to be pointed at the helicopter. However, they are helpful when pointed toward utility poles, trees or other hazards to the landing aircraft. White lights such as spotlights, flashbulbs and hi–beam headlights ruin the pilot’s night vision and temporarily blind

him. Red lights, however, are very helpful in finding accident locations and do not affect the pilot's night vision as significantly.

**3.7.3** As in Day LZ operations, ensure radio contact is accomplished between ground and air, if possible.

### **3.8 Ground Guide**

**3.8.1** When the helicopter is in sight, one person should assist the LZ Coordinator by guiding the helicopter into a safe landing area. In selecting an LZ Coordinator, recognize that medical personnel usually are very busy with the patient at this time. It is recommended that the LZ Coordinator be someone other than a medical responder, if possible. Eye protection should be worn. The ground guide should stand with his back to the wind and his arms raised over his head (flashlights in each hand for night operations.)

**3.8.2** The pilot will confirm the LZ sighting by radio. If possible, once the pilot has identified the LZ, the ground guide should move out of the LZ.

**3.8.3** As the helicopter turns into the wind and begins a descent, the LZ coordinator should provide assistance by means of radio contact, or utilize the "unsafe signal" to wave off the helicopter if the LZ is not safe (see FIG ENR 6.2–8). The LZ Coordinator should be far enough from the touchdown area that he/she can still maintain visual contact with the pilot.

### **3.9 Assisting the Crew**

**3.9.1** After the helicopter has landed, do not approach the helicopter. The crew will approach you.

**3.9.2** Be prepared to assist the crew by providing security for the helicopter. If asked to provide security, allow no one but the crew to approach the aircraft.

**3.9.3** Once the patient is prepared and ready to load, allow the crew to open the doors to the helicopter and guide the loading of the patient.

**3.9.4** When approaching or departing the helicopter, always be aware of the tail rotor and always follow the directions of the crew. Working around a running helicopter can be potentially dangerous. The environment is very noisy and, with exhaust gases and rotor wash, often windy. In scene operations, the surface may be uneven, soft, or slippery which can lead to tripping. Be very careful of your footing in this environment.

**3.9.5** The tail rotor poses a special threat to working around a running helicopter. The tail rotor turns many times faster than the main rotor, and is often invisible even at idle engine power. Avoid walking towards the tail of a helicopter beyond the end of the cabin, unless specifically directed by the crew.

#### **NOTE–**

*Helicopters typically have doors on the sides of the cabin, but many use aft mounted "clamshell" type doors for loading and unloading patients on litters or stretchers. When using these doors, it is important to avoid moving any further aft than necessary to operate the doors and load/unload the patient. Again, always comply with the crew's instructions.*

### **3.10 General Rules**

**3.10.1** When working around helicopters, always approach and depart from the front, never from the rear. Approaching from the rear can increase your risk of being struck by the tail rotor, which, when at operating engine speed, is nearly invisible.

**3.10.2** To prevent injury or damage from the main rotor, never raise anything over your head.

**3.10.3** If the helicopter landed on a slope, approach and depart from the down slope side only.

**3.10.4** When the helicopter is loaded and ready for take off, keep the departure path free of vehicles and spectators. In an emergency, this area is needed to execute a landing.

### **3.11 Hazardous Chemicals and Gases**

**3.11.1** Responding to accidents involving hazardous materials requires special handling by fire/rescue units on the ground. Equally important are the preparations and considerations for helicopter operations in these areas.

**3.11.2** Hazardous materials of concern are those which are toxic, poisonous, flammable, explosive, irritating, or radioactive in nature. Helicopter ambulance crews normally don't carry protective suits or breathing apparatuses to protect them from hazardous materials.

**3.11.3** The helicopter ambulance crew must be told of hazardous materials on the scene in order to avoid the contamination of the crew. Patients/victims contaminated by hazardous materials may require special precautions in packaging before loading on the aircraft for the medical crew's protection, or may be transported by other means.

**3.11.4** Hazardous chemicals and gases may be fatal to the unprotected person if inhaled or absorbed through the skin.

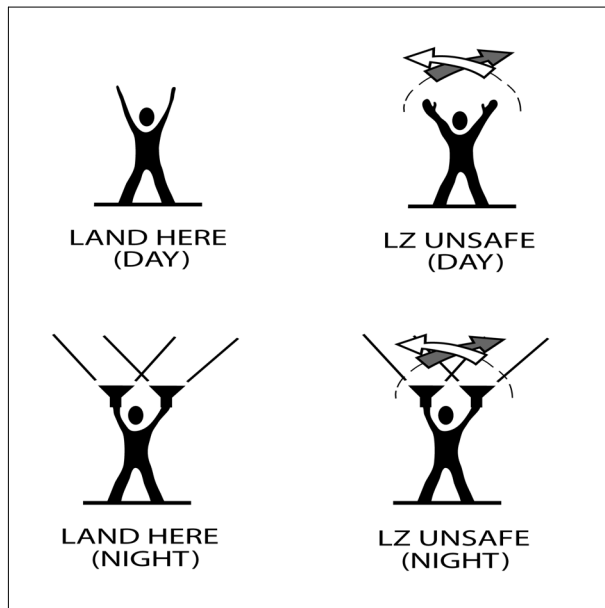
**3.11.5** Upon initial radio contact, the helicopter crew must be made aware of any hazardous gases in the area. Never assume that the crew has already been informed. If the aircraft were to fly through the hazardous gases, the crew could be poisoned and/or the engines could develop mechanical problems.

**3.11.6** Poisonous or irritating gases may cling to a victim's clothing and go unnoticed until the patient is loaded and the doors of the helicopter are closed. To avoid possible compromise of the crew, all of these patients must be decontaminated prior to loading.

### 3.12 Hand Signals

**3.12.1** If unable to make radio contact with the HEMS pilot, use the signals in FIG ENR 6.2-8.

FIG ENR 6.2-8  
Recommended Landing Zone Ground Signals



### 3.13 Emergency Situations

**3.13.1** In the event of a helicopter accident in the vicinity of the LZ, consider the following:

#### 3.13.1.1 Emergency Exits:

a) Doors and emergency exits are typically prominently marked. If possible, operators should familiarize ground responders with the door system on their helicopter in preparation for an emergency event.

b) In the event of an accident during the LZ operation, be cautious of hazards such as sharp and jagged metal, plastic windows, glass, any rotating components, such as the rotors, and fire sources, such as the fuel tank(s) and the engine.



### 3.13.1.2 Fire Suppression:

a) Helicopters used in HEMS operations are usually powered by turboshaft engines, which use jet fuel. Civil HEMS aircraft typically carry between 50 and 250 gallons of fuel, depending upon the size of the helicopter, and planned flight duration, and the fuel remaining after flying to the scene. Use water to control heat and use foam over fuel to keep vapors from ignition sources.

## 4. Emergency Medical Service (EMS) Multiple Helicopter Operations

**4.1 Background.** EMS helicopter operators often overlap other EMS operator areas. Standardized procedures can enhance the safety of operating multiple helicopters to landing zones (LZ) and to hospital heliports. Communication is the key to successful operations and in maintaining organization between helicopters, ground units and communication centers. EMS helicopter operators which operate in the same areas should establish joint operating procedures and provide them to related agencies.

### 4.2 Recommended Procedures.

**4.2.1 Landing Zone Operations.** The first helicopter to arrive on-scene should establish communications with the ground unit at least 10 NMs from the LZ to receive a LZ briefing and to provide ground control the number of helicopters that can be expected. An attempt should be made to contact other helicopters on 123.025 to pass on to them pertinent LZ information and the ground unit's frequency. Subsequent helicopters arriving on scene should establish communications on 123.025 at least 10 NMs from the LZ. After establishing contact on 123.025, they should contact the ground unit for additional information. All helicopters should monitor 123.025 at all times.

**4.2.1.1** If the landing zone is not established by the ground unit when the first helicopter arrives, then the first helicopter should establish altitude and orbit location requirements for the other arriving helicopters. Recommended altitude separation between helicopters is 500 feet (weather and airspace permitting). Helicopters can orbit on cardinal headings from the scene coordinates. (See FIG ENR 6.2–9)

**4.2.1.2** Upon landing in the LZ, the first helicopter should update the other helicopters on the LZ conditions, i.e., space, hazards and terrain.

**4.2.1.3** Before initiating any helicopter movement to leave the LZ, all operators should attempt to contact other helicopters on 123.025, and state their position and route of flight intentions for departing the LZ.

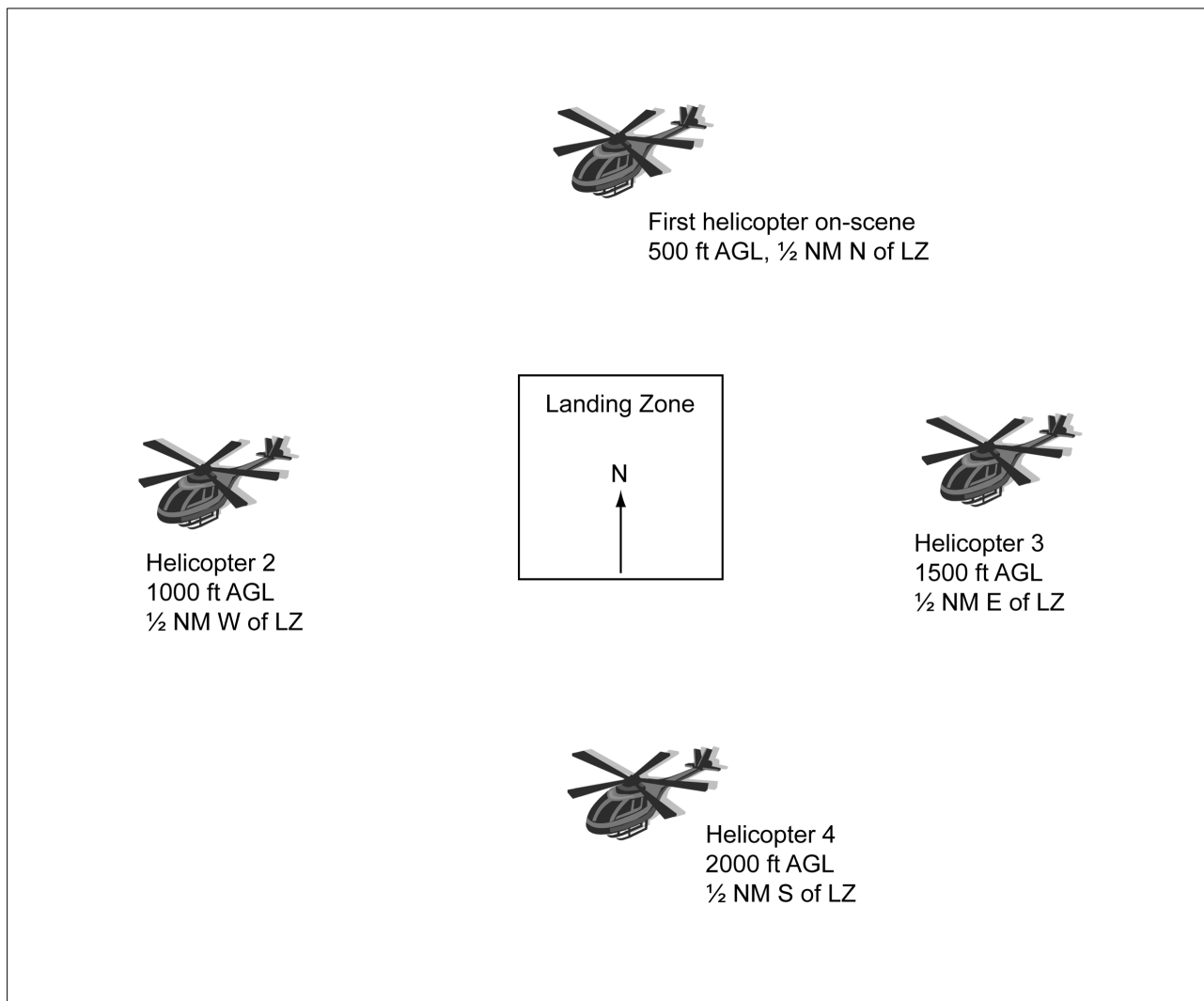
**4.2.2 Hospital Operations.** Because many hospitals require landing permission and have established procedures (frequencies to monitor, primary and secondary routes for approaches and departures, and orbiting areas if the heliport is occupied) pilots should always receive a briefing from the appropriate facility (communication center, flight following, etc.) before proceeding to the hospital.

**4.2.2.1** In the event of multiple helicopters coming into the hospital heliport, the helicopter nearest to the heliport should contact other inbound helicopters on 123.025 and establish intentions. Follow the guidelines established in the LZ operations.

**4.2.2.2** To facilitate approach times, the pilot-in-command of the helicopter occupying the hospital heliport should advise any other operators whether the patient will be off loaded with the rotor blades turning or stopped, and the approximate time to do so.

**4.2.2.3** Before making any helicopter movement to leave the hospital heliport, all operators should attempt to contact other helicopters on 123.025 and state their position and route of flight intentions for departing the heliport.

FIG ENR 6.2-9  
EMS Multiple Helicopter LZ/Heliport Operation



**NOTE-**

*If the LZ/hospital heliport weather conditions or airspace altitude restrictions prohibit the recommended vertical separation, 1 NM separations should be kept between helicopter orbit areas.*

# ENR 7. Oceanic Operations

## ENR 7.1 General Procedures

### 1. IFR/VFR Operations

**1.1** Flights in oceanic airspace must be conducted under Instrument Flight Rule (IFR) procedures when operating:

**1.1.1** Between sunset and sunrise.

**1.1.2** At or above Flight Level (FL) 055 when operating within the New York, Oakland, and Anchorage Oceanic Flight Information Regions (FIRs).

**1.1.3** Above FL180 when operating within the Miami and Houston FIRs and in the San Juan Control Area. Flights between the east coast of the U.S., and Bermuda or Caribbean terminals, and traversing the New York FIR at or above 5,500 feet MSL should be especially aware of this requirement.

**1.1.4** At or above FL230 when operating within the Anchorage Arctic FIR.

**1.2** San Juan CTA/FIR VFR Traffic.

**1.2.1** All VFR aircraft entering and departing the San Juan FIR/CTA will provide San Juan Radio with an ICAO flight plan. All aircraft must establish two-way communications with San Juan Radio on 126.7, 122.2, 123.65, or 255.4.

**1.2.2** Communication can also be established by transmitting on 122.1 and receive using the appropriate VOR frequency for Borinquen (BQN), Mayaguez (MAZ), Ponce (PSE), and St. Croix (COY). For St. Thomas (STT), transmit on 123.6 and receive on the VOR frequency. If unable to contact San Juan Radio, the pilot is responsible for notifying adjacent ATS units and request that a position report be relayed to San Juan Radio for search and rescue purposes and flight following.

**NOTE-**

*This is in accordance with ICAO Doc 4444, Part II, paragraphs 14.1.1, 14.1.4; Part VI, paragraphs 1.2.1, 2.2.2; Annex II, chapter 6, paragraphs 6.1.2.1, 5.1.1, 5.2.1, 5.2.2, 5.2.2.3, 5.3.2.4, 5.4.1.*

**1.3** Non-RVSM aircraft are not permitted in RVSM airspace unless they meet the criteria of excepted aircraft and are previously approved by the ATS unit having authority for the airspace. In addition to those aircraft listed in ENR 1.1, General Rules, paragraph 38, Operational Policy/Procedures for Reduced Vertical Separation Minimum (RVSM) in the Domestic U.S., Alaska, Offshore Airspace, and the San Juan FIR, the following aircraft operating within oceanic and offshore airspace are excepted:

**1.3.1** Aircraft being initially delivered to the State of Registry or Operator.

**1.3.2** Aircraft that was formerly RVSM-approved but has experienced an equipment failure and is being flown to a maintenance facility for repair in order to meet RVSM requirements and/or obtain approval.

**1.3.3** Aircraft being utilized for mercy or humanitarian purposes.

**NOTE-**

*These exceptions are accommodated on a workload or traffic-permitting basis.*

### 2. Flight Plan Filing Requirements

**NOTE-**

*In addition to the following guidance, operators must also consult current Notices to Air Missions (NOTAMs) and chart supplements (Supplement Alaska, Supplement Pacific) to gain a complete understanding of requirements. NOTAMs and supplements may contain guidance that is short term and/or short notice – i.e., having immediate effect.*

**2.1** If you are eligible for oceanic 50 NM lateral separation:

**2.1.1** PBN/A1 or PBN/L1 in Field 18.

**2.1.2** R in Field 10a.

**2.1.3** See FAA Advisory Circular (AC) 90-105, Approval Guidance for RNP Operations and Barometric Vertical Navigation in the U.S. National Airspace System and in Oceanic and Remote Continental Airspace, for guidance on RNP 10 (RNAV 10) authorization.

**2.2** If you are eligible for oceanic 50 NM longitudinal and lateral separation:

**2.2.1** PBN/A1 or PBN/L1 in Field 18.

**2.2.2** P2 in Field 10a.

**2.2.3** D1 in Field 10b.

**2.2.4** (J5, J6, or J7) and R in Field 10a.

**2.2.5** SUR/RSP180 in Field 18.

**2.2.6** See FAA Advisory Circular 90-117, Data Link Communications, for guidance on Required Communication Performance (RCP) and Required Surveillance Performance (RSP) authorization.

**2.2.7** See FAA Advisory Circular 90-105 for guidance on RNP 10 (RNAV 10) authorization.

**2.3** If you are eligible for 23 NM lateral or 30 NM longitudinal separation:

**2.3.1** PBN/L1 in Field 18.

**2.3.2** P2 in Field 10a.

**2.3.3** D1 in Field 10b.

**2.3.4** (J5, J6, or J7) and R in Field 10a.

**2.3.5** SUR/RSP180 in Field 18.

**2.3.6** See FAA Advisory Circular 90-117 for guidance on RCP and RSP authorization.

**2.3.7** See FAA Advisory Circular 90-105 for guidance on RNP 4 authorization.

**2.4** Oakland Oceanic FIR

**2.4.1** In accordance with ICAO Doc 4444, flight plans with routes entering the Oakland Oceanic FIR (KZAK) must contain, among the estimated elapsed times (EET) in Field 18, an entry point for KZAK and an estimated time. It is not mandatory to file the boundary crossing point in Field 15 of the route of flight, but it is permitted.

**2.4.2** The use of CPDLC and ADS-C in the Oakland Oceanic FIR (KZAK) is only permitted by Inmarsat and Iridium customers. All other forms of data link connectivity are not authorized. Users must ensure that the proper data link code is filed in Item 10a of the ICAO FPL in order to indicate which satellite medium(s) the aircraft is equipped with. The identifier for Inmarsat is J5 and the identifier for Iridium is J7. If J5 or J7 is not included in the ICAO FPL, then the LOGON will be rejected by KZAK and the aircraft will not be able to connect.

**2.5** New York Oceanic FIR

**2.5.1** The use of CPDLC and ADS-C in the New York Oceanic FIR (KZWH) is only permitted by Inmarsat and Iridium customers. All other forms of data link connectivity are not authorized. Users must ensure that the proper data link code is filed in Item 10a of the ICAO FPL in order to indicate which satellite medium(s) the aircraft is equipped with. The identifier for Inmarsat is J5 and the identifier for Iridium is J7. If J5 or J7 is not included in the ICAO FPL, then the LOGON will be rejected by KZWH and the aircraft will not be able to connect.

**3. Flight Plan Addressing**

**3.1** In an effort to eliminate erroneous or duplicate flight plans that may be received from diverse locations, and to increase the safety of flight, operators must adhere to the following procedures when filing flight plans for departing flights from foreign aerodromes entering the United States National Airspace System:

**3.1.1** If the filer sends an FPL to an FAA En Route facility in addition to the air traffic service unit (ATSU) responsible for the departure aerodrome, the filer must ensure that the flight plan filed is the same as the flight plan entered by the ATS unit having authority for the departure aerodrome. Note that per ICAO Doc. 4444, an operator may request that movement messages distributed by the responsible ATS unit be routed to the operator.

**3.1.2** Changes to IFR flight plans must be submitted as soon as possible, but no more than 24 hours prior to the flight, to ensure proper processing and distribution before departure.

**3.1.3** The FAA expects changes to be transmitted using the DLA and CHG messages as outlined in ICAO Doc. 4444. Transmitting changes to the FAA by canceling (CNL) and refileing an FPL creates the potential for multiple FPLs in the computer system.

**3.1.4** If Cancel and Refile is used, it is imperative that the cancellation of the original FPL in the FAA system be verified by computer response or verbal coordination before submitting another FPL.

**3.1.5** Changes to an IFR flight plan less than 30 minutes prior to departure must be accomplished via verbal coordination with the ATSU having authority for the departure aerodrome.

**NOTE-**

*These references are contained in ICAO DOC 4444 and FAA Order JO 7210.3, Facility Operation and Administration. Operators should be aware that failure to adhere to these procedures could result in an operational delay or pilot deviation.*

**3.2 Oakland Oceanic FIR**

**3.2.1** All flights that will enter the Oakland Oceanic CTA/FIR must address flight plans to KZAKZQZX.

**3.3 New York FIR**

**3.3.1** All flights entering the New York Oceanic CTA/FIR must address flight plans to KZWYZOZX.

**3.3.2** All flights entering the New York Oceanic CTA/FIR and a U.S. ARTCC (except Boston) and/or Bermuda airspace must address flight plans to both KZWYZOZX and the appropriate U.S. ARTCC. (See TBL ENR 7.1-1).

TBL ENR 7.1-1

<b>Airspace to be Entered: New York Oceanic CTA/ FIR and U.S. ARTCCs</b>	<b>Required AFTN Addresses</b>
New York (NY) Oceanic CTA/FIR	KZWYZOZX
Boston ARTCC & NY Oceanic	KZWYZOZX only
NY domestic and/or Bermuda & NY Oceanic	KZNYZQZX & KZWYZOZX
Washington (KZDC) & NY Oceanic	KZDCZQZX & KZWYZOZX
Jacksonville (KZJX) & NY Oceanic	KZJXZQZX & KZWYZOZX
Miami (KZMA) & NY Oceanic	KZMAZQZX & KZWYZOZX
San Juan & NY Oceanic	TZSUZQZX & KZWYZOZX
Houston (KZHU)	KZHURZRX

### 3.4 Anchorage Oceanic FIRs

#### 3.4.1 Anchorage Arctic FIR

3.4.1.1 Flight plans must be filed with PAZAZQZX.

#### 3.4.2 Anchorage Oceanic FIR

3.4.2.1 Flight plans must be filed with both PAZAZQZX and PAZLNZQZX.

### 3.5 San Juan CTA/FIR

3.5.1 All aircraft transitioning through San Juan FIR/CTA from a foreign facility that will operate in North Atlantic (NAT) High Level Airspace (HLA) must forward the full route of flight for flight plan verification.

3.5.2 This must be accomplished prior to exiting the San Juan FIR/CTA by one of the following means:

3.5.2.1 Via Direct pilot-controller communication; or

3.5.2.2 Via New York Radio, when requested by ATC.

#### **NOTE-**

*This requirement does not apply to aircraft operating outside of NAT HLA.*

## 4. Beacon Code Requirements

4.1 Oakland Oceanic FIR. Upon entering the Oakland Oceanic CTA and after radar service is terminated; all aircraft should adjust their transponder to display code 2000 on their display. Aircraft should maintain code 2000 thereafter until otherwise directed by Air Traffic Control.

### 4.2 New York Oceanic FIR

4.2.1 New York – East Oceanic CTA. All aircraft should squawk code 2000 30 minutes after entry.

#### 4.2.2 New York – West Oceanic CTA.

4.2.2.1 Aircraft transitioning to New York – East Oceanic CTA should squawk code 2000 30 minutes after entry. Exception: aircraft transiting Bermuda RADAR airspace should remain on the last assigned code until clear of that airspace, then squawk 2000.

4.2.2.2 All others should remain on the last assigned code.

4.3 Anchorage Oceanic FIR. CPDLC aircraft crossing the Anchorage/Oakland FIR boundary westbound between 150W and 160W must contact San Francisco Radio by 140W to receive a discrete beacon code for use in Anchorage airspace.

4.4 Houston Oceanic FIR. All aircraft entering the Houston Oceanic CTA/FIR should remain on the last assigned code.

### 4.5 Miami CTA/FIR

4.5.1 There is no primary radar or weather returns available from the Grand Turk, Georgetown, and Nassau radar systems. Since radar separation is dependent upon the receipt of transponder returns, all aircraft within antenna coverage of either system are required to squawk transponder codes as assigned by ATC, or, if none assigned, squawk the appropriate stratum code.

4.5.2 Aircraft departing and overflying the Santo Domingo and Port Au Prince FIRs can expect ATC assigned codes from those ATS providers. If a code is not assigned by either Santo Domingo or Port Au Prince, pilots should request a code. The assigned code should be squawked prior to entering the Miami CTA/FIR.

## 5. Position Reporting in the Oceanic Environment

5.1 Pilots must report over each point used in the flight plan to define the route of flight, even if the point is depicted on aeronautical charts as an “on request” (non-compulsory) reporting point. For aircraft providing

automatic position reporting via an Automatic Dependent Surveillance-Contract (ADS-C) logon, pilots should discontinue voice position reports.

**5.2** Advanced Technology and Oceanic Procedures (ATOP) cannot accept CPDLC position reports containing latitude and longitude in the ARINC 424 format. The flight crew should use latitudes and longitudes encoded as waypoint names in the ICAO format (for example, 54N150W).

**NOTE-**

*ARINC 424 describes a 5-character latitude/longitude format for aircraft navigation databases (for example, 10N40 describes a latitude/longitude of 10N140W). The ATSU will reject any downlink message containing waypoint names in the ARINC 424 format.*

**5.3** Oakland Oceanic FIR

**5.3.1** Aircraft filed on PACOTS routes within Oakland Oceanic CTA/FIR airspace must make position reports using latitude/longitude coordinates or named fixes as specified in the track definition messages (TDM). Position reports must comprise information on present position, estimated next position, and ensuing position. Reporting points of reference not specified in the TDM and/or rounding off geographical coordinates is prohibited.

**5.4** New York Oceanic FIR

**5.4.1** Position reports should be made via ADSC, if the aircraft has ADS-C capability. The two types of ADS-C contracts that will be established with each aircraft are a twenty (20) minute Periodic Report Rate and a five (5) mile Lateral Deviation Event. This is in addition to normal waypoint reports.

**5.4.2** Operators should not use CPDLC for position reports but it should be used for all other ATC communications. Position reports should be made via HF if ADS-C is not available.

**5.5** Anchorage Oceanic FIR

**5.5.1** All waypoints filed in Field 15 of the ICAO flight plan (route field) must be reported as a position report.

**5.5.2** Position reports are to be made via ADS, CPDLC or Voice communication in that order of preference.

**5.5.3** Aircraft with an active ADS connection must make a CPDLC position report when crossing the IFR boundary (inbound) to ensure CPDLC connectivity.

**5.6** Anchorage Arctic FIR

**5.6.1** Flights crossing the Anchorage Arctic FIR along 141W between 72N and 90N must file their 141W crossing point as a route element in field 15 of the ICAO flight plan.

**5.6.2** All waypoints filed in Field 15 of the ICAO flight plan (route field) must be reported as a position report.

**5.7** Houston Oceanic FIR

**5.7.1** Position reports and the ability to communicate at any point of the route of flight is vital to the air traffic safety and control process. When flight planning, users are responsible to ensure that they will be capable of compliance. Inability to comply is in violation of ICAO requirements. The communication requirements for IFR flights within the Houston Oceanic Control Area are:

**5.7.1.1** Functioning two-way radio communications equipment capable of communicating with at least one ground station from any point on the route;

**5.7.1.2** Maintaining a continuous listening watch on the appropriate radio frequency; and

**5.7.1.3** Reporting of mandatory points.

**5.7.2** The following describes an area in the Houston CTA/FIR where reliable VHF air-to-ground communications below FL180 are not available:

**5.7.2.1** 26 30 00N 86 00 00W TO 26 30 00N 92 00 00W;

**5.7.2.2** TO 24 30 00N 93 00 00W TO 24 30 00N 88 00 00W to;

**5.7.2.3** TO 24 00 00N 86 00 00W TO BEGINNING POINT.

**5.7.2.4** Communications within this area are available for all oceanic flights via HF.

**NOTE–**

*The attention of pilots planning flights within the Houston CTA/FIR is directed to the communications and position reports requirements specified in the following ICAO Documents: Annex 2, Paragraphs 3.6.3 and 3.6.5; Annex 11, Paragraph 6.1.2; DOC 4444 Part 2 Paragraph 14; and DOC 7030 CAR Paragraph 3.*

**6. Satellite Voice (SATVOICE) Communication Services for Air Traffic Control (ATC)**

**6.1** The FAA provides Inmarsat and Iridium SATVOICE services for air-to-ground and ground-to-air calls directly with Oakland, New York, and Anchorage Air Route Traffic Control Centers (ARTCC) and New York and San Francisco RADIO. The FAA's SATVOICE services are supplemental to HF voice communication services.

**6.2** The pilot must limit direct SATVOICE contact with ATC to distress and urgency situations, or when other means are not available, and communication is essential.

**6.3** When unable to communicate on HF, the pilot may conduct normal and routine communications with ATC via New York RADIO or San Francisco RADIO on SATVOICE.

**6.4** The aircraft SATVOICE equipment must be approved in accordance with Advisory Circular 20–150, Airworthiness Approval of Satellite Voice (SATVOICE) Equipment Supporting Air Traffic Service (ATS) Communication.

**NOTE–**

*Portable satellite phones are NOT approved for normal and routine ATC communications.*

**6.5** The operator must use the SATVOICE equipment in accordance with ICAO Doc 10038, Satellite Voice Operations Manual (SVOM), with emphasis on the following:

**6.5.1** If the flight intends to use SATVOICE capability, the operator must file the appropriate designator (that is, M1 or M3) in Item 10, and the ICAO aircraft address (that is, hexadecimal code) in Item 18 of the flight plan.

**REFERENCE–**

*Aeronautical Information Manual, Chapter 5, Air Traffic Procedures.*

**6.5.2** The operator must establish procedures to ensure the flight maintains voice communications (that may include SATVOICE and any required HF SELCAL checks) with every ATS unit along the route of flight.

**6.5.3** When using SATVOICE, the pilot must follow RTF conventions identical to HF/VHF communications in accordance with applicable standards and regulations pertaining to aeronautical communications.

**6.5.4** Satellite service providers have assigned ICAO priority level 2/HGH/Q12 Operational high (second highest) to calls between aircraft and Air Navigation Service Providers. The pilot must verify the priority of the call and act only on ATC clearances/instructions from SATVOICE calls with priority level 2/HGH/Q12, and if in doubt terminate the call and initiate a new call for confirmation.

**6.5.5** The pilot must answer SATVOICE calls when contacted either by the ARTCC or RADIO facility.

**6.6** The SATVOICE short codes for ARTCCs and RADIO are in accordance with TBL ENR 7.1–2.



TBL ENR 7.1-2  
SATVOICE Short Codes for ARTCCs and RADIO Facilities

Oceanic Control Area (OCA)	ATC Direct (only for distress, urgency, other means not available)		ATC via RADIO Facility (when unable to communicate on HF)	
	ARTCC	SATVOICE Short Code	RADIO Facility	SATVOICE Short Code
New York East	New York ARTCC	436695	New York RADIO	436623
New York West	New York ARTCC	436696		
Oakland	Oakland ARTCC	436697	San Francisco RADIO	436625
Anchorage	Anchorage ARTCC	436602		

**7. Air-to-Air Frequency**

**7.1 Houston, San Juan and Miami FIRs**

**7.1.1** Frequency 123.45 MHz is the approved air-to-air VHF channel within the above FIRs. This frequency will be used for flights operating over remote and oceanic areas out of range of VHF ground stations to exchange necessary operational information and to facilitate the resolution of operational problems.

**7.1.2** Frequency 123.45 MHz replaces the previously published frequencies used within the Houston, San Juan, and Miami FIRs. This change is necessary to comply with Amendment 74 to ICAO Annex 10, Volume II, which designated 123.45 as the global standard VHF air-to-air frequency.

**8. Strategic Lateral Offset Procedure (SLOP) While Within FAA-Controlled Oceanic Airspace and the Anchorage Flight Information Region (FIR)**

**8.1** These procedures have been developed in accordance with ICAO Document 4444 Procedures for Air Navigation Services – Air Traffic Management, paragraph 16.5.

**8.2** It has been determined that allowing aircraft conducting oceanic flight to fly lateral offsets, in increments of .1 nautical mile (NM) up to a maximum of 2 NM right of centerline, will provide an additional safety margin and mitigate the risk of conflict when non-normal events, such as aircraft navigation errors, altitude deviation errors, and turbulence-induced altitude-keeping errors occur.

**8.3** These procedures are authorized in FAA controlled oceanic airspace, Anchorage FIR, and the airspace surrounding the island of Bermuda, the airspace controlled by the Honolulu Control Facility (HCF) and the airspace controlled by the Guam Combined Center Radar Approach Control (CERAP).

**8.3.1** Pilots should apply an offset outbound after reaching their cruising flight level and retain the offset until the top of descent, unless local ATC dictates otherwise.

**8.3.2** For flights departing Hawaii, pilots should apply SLOP upon reaching their initial cruise flight level and they are within 70 NM of entering the Oakland Oceanic Control Area.

**8.3.3** For flights arriving Hawaii, pilots should discontinue SLOP no later than 70 NM after entering HCF airspace, or when receiving radar vectors from HCF, whichever occurs first. Pilots of Hawaiian inter-island flights must not use SLOP.

**8.3.4** Aircraft transiting Bermuda airspace, HCF airspace, or Guam CERAP airspace may remain on their established offset.

**8.3.5** Aircraft flying in the Anchorage FIR may apply SLOP as follows:

**8.3.5.1** Throughout the entire Anchorage Arctic FIR.

**8.3.5.2** In those portions of the Anchorage Domestic and Anchorage Oceanic FIRs (including offshore control areas) which are more than twelve miles offshore.

**8.3.5.3** Over the land area of the Alaska Peninsula west of 160° West longitude.

**8.4** These procedures provide for offsets within the following guidelines: Along a route or track there will be 21 positions that an aircraft may fly: on centerline or at increments of .1 NM (for example, .1, .2, .3, .4 ..... 1.8, 1.9, 2.0) right of centerline out to a maximum offset of 2 NM. Offsets must not exceed 2 NM right of centerline. The intent of this procedure is to reduce risk (add safety margin) by distributing aircraft laterally across the 21 available positions.

**8.4.1** Pilots must fly the track centerline if their aircraft does not have automatic offset programming capability. Pilots of aircraft unable to offset at .1 NM increments should fly on the track centerline, or at the 1.0 NM or 2.0 NM positions right of centerline when using SLOP.

**8.4.2** Pilots should also fly one of the available offset positions described above to avoid wake turbulence. Pilots should use whatever means available to determine the best offset to fly. An aircraft overtaking a lower altitude aircraft on the same routing should offset within the confines of this procedure, if capable, so as to create the least amount of wake turbulence for the aircraft being overtaken.

**8.4.3** Aircraft should not offset to the left of center line nor offset more than 2 NM right of center line. Pilots may contact other aircraft on VHF frequency 123.45, as necessary, to coordinate the best wake turbulence offset option.

**NOTE-**

*It is recognized that pilots will use their judgment to determine the action most appropriate to any given situation and have the final authority and responsibility for the safe operation of the aircraft.*

**8.4.4** There is no ATC clearance required for this procedure and it is not necessary that ATC be advised.

## ENR 7.2 Data Link Procedures

### 1. Oakland Oceanic Airspace

**1.1** Oakland ARTCC has full CPDLC and ADS-C services in the entire Oakland Oceanic FIR for FANS-1/A capable aircraft. The Oakland Oceanic FIR log-on address is “KZAK;” the facility is “OAKODYA.” CADS LOGON is not supported.

**1.2** The use of CPDLC and ADS-C in the Oakland Oceanic FIR (KZAK) is only permitted by Inmarsat and Iridium customers. All other forms of data link connectivity are not authorized. Users must ensure that the proper data link code is filed in Item 10a of the ICAO FPL in order to indicate which satellite medium(s) the aircraft is equipped with. The identifier for Inmarsat is J5 and the identifier for Iridium is J7. If J5 or J7 is not included in the ICAO FPL, then the LOGON will be rejected by KZAK and the aircraft will not be able to connect.

**1.3** Prior to entering the Oakland Oceanic FIR, contact San Francisco Radio and request a SELCAL check.

**NOTE-**

**1.** Expect to receive primary and secondary HF frequency assignments from San Francisco Radio for the entire route of flight within the Oakland Oceanic FIR.

**2.** Pilots must maintain HF communications capability with San Francisco Radio at all times within the Oakland Oceanic FIR.

**1.4** Aircraft entering the Oakland Oceanic FIR data link service area from non-data link airspace should:

**1.4.1** Log on to CPDLC at least 15 but not more than 45 minutes prior to entering the Oakland Oceanic FIR CPDLC service area.

**1.4.2** Contact San Francisco Radio on HF for a SELCAL check and provide the information outlined in paragraph 1.3.

**1.5** Aircraft entering the Oakland Oceanic FIR data link service area from adjacent data link airspace should:

**1.5.1** Determine the status of the CPDLC connection. If KZAK is the active center, the pilot must contact San Francisco Radio on HF for a SELCAL check.

**1.5.2** If KZAK is not the active center, the pilot must, within 5 minutes after the boundary is crossed, terminate the CPDLC connection, then log on to KZAK, and contact San Francisco Radio on HF for a SELCAL check.

**1.6** Flights overflying Honolulu Control Facility (HCF) airspace will receive an END SERVICE message prior to entering HCF airspace that will result in termination of CPDLC. Aircraft must re-log on to CPDLC prior to reentering Oakland Oceanic FIR airspace when HCF advises to contact en route communications or San Francisco Radio.

**1.7** Flights overflying Guam Combined Center Radar Approach Control (CERAP) airspace should maintain the CPDLC connection with Oakland ARTCC; however, do not use CPDLC for ATC COM until Guam CERAP advises you to again contact en route communications or San Francisco Radio.

### 2. Anchorage Oceanic Airspace

**2.1** Anchorage ARTCC has full CPDLC capability and normal service in the Arctic FIR for FANS-1/A capable aircraft within INMARSAT or Iridium coverage. The Anchorage Arctic FIR log-on address is “PAZN;” the facility is “ANCFXA.” CADS LOGON is not supported.

**2.2** Anchorage ARTCC has full CPDLC capability and normal service in the Anchorage Domestic and Oceanic FIRs, South of N63 and west of W165 for FANS-1/A capable aircraft. The Anchorage log-on address is “PAZN;” the facility is “ANCFYA.” CADS LOGON is not supported.

**2.3** Prior to entering the Anchorage Oceanic FIR, contact San Francisco Radio and request a SELCAL check.

**NOTE-**

1. HF service in the Anchorage Arctic FIR is provided via Gander Radio. San Francisco Radio maintains an HF Long-Distance Operational Control (LDOC) station at Barrow, Alaska that may be of use when the solar conditions inhibit normal communications via Gander. HF service in the Anchorage Oceanic FIR is provided via San Francisco Radio.
2. Expect to receive primary and secondary HF frequency assignments from San Francisco Radio for the entire route of flight when within the Anchorage Oceanic FIR.
3. Pilots must maintain HF communications capability with appropriate en route RADIO (San Francisco Radio or Gander) at all times within the Anchorage Arctic or Oceanic FIRs.

### 3. New York Oceanic Airspace

**3.1** New York ARTCC provides full CPDLC and ADS-C services throughout its Oceanic Airspace to FANS-1/A capable flights. The New York Oceanic FIR FANS LOGON address is "KZWY." CADS LOGON is not supported. Flights should use ADS for position reporting and CPDLC for all other ATC communications while in the New York Oceanic Area.

**3.2** The use of CPDLC and ADS-C in the New York Oceanic FIR (KZWY) is only permitted by Inmarsat and Iridium customers. All other forms of data link connectivity are not authorized. Users must ensure that the proper data link code is filed in Item 10a of the ICAO FPL in order to indicate which satellite medium(s) the aircraft is equipped with. The identifier for Inmarsat is J5 and the identifier for Iridium is J7. If J5 or J7 is not included in the ICAO FPL, then the LOGON will be rejected by KZWY and the aircraft will not be able to connect.

**3.3** Prior to entering the New York Oceanic FIR, contact New York Radio and request a SELCAL check.

**NOTE-**

1. Expect to receive primary and secondary HF frequency assignments from New York Radio for the route of flight within the data link service area.
2. Pilots must maintain HF communications capability with New York Radio at all times within the New York Oceanic FIR.
3. If not filed in the flight plan, NY Radio will request if the flight is CPDLC connected and confirm their exit point from the New York FIR.

**3.4** If the flight will exit ZNY oceanic airspace into domestic airspace (including over New York Bermuda RADAR):

**3.4.1** Identify the flight as ADS and/or CPDLC connected;

**3.4.2** If operating on the Organized Track System (OTS), state the track letter;

**3.4.3** State the name of the next CTA/FIR to be entered along with the latitude and longitude or waypoint exit point leaving the ZNY FIR; and

**3.4.4** Request a SELCAL check.

**NOTE-**

*New York Radio may require flights to contact them at 60 West for HF frequency updates.*

**3.5** Aircraft entering the New York Oceanic FIR data link service area from non-data link airspace should:

**3.5.1** LOGON to KZWY at least 15 minutes but not more than 45 minutes prior to entering the New York Oceanic CTA/FIR.

**3.5.2** Prior to entering the New York Oceanic FIR contact New York Radio on HF or VHF providing the information as outlined in paragraph 3.3.

**NOTE-**

*Do not send a CPDLC position report to confirm CDA prior to, or upon crossing, the FIR.*

**3.6** Aircraft entering the New York Oceanic FIR data link service area from adjacent data link airspace should:

**3.6.1** Determine the status of the FANS connection when crossing the New York Oceanic FIR boundary.

**NOTE-**

*CPDLC and ADS services will be forwarded automatically between New York, Santa Maria, and Gander OCA's. CPDLC connections will be transferred approximately 5 minutes prior to the boundary crossing point.*

**3.6.1.1** If KZWY is the active connection when crossing the New York Oceanic FIR boundary the pilot must:

**3.6.1.2** Contact New York Radio on HF providing the information as outlined in paragraph 3.3.

**3.6.2** If KZWY is not the active center when crossing the New York Oceanic FIR boundary the pilot must:

**3.6.2.1** Terminate the CPDLC connection, then log-on to KZWY; and

**3.6.2.2** Contact New York Radio on HF providing the information as outlined in paragraph 3.3.

**NOTE-**

*Do not send a CPDLC position report to confirm CDA prior to, or upon crossing, the FIR.*

**3.7** Flights overflying Bermuda RADAR airspace should:

**3.7.1** Prior to entering New York Bermuda RADAR airspace, aircraft will receive an END SERVICE message that will result in termination of CPDLC.

**3.7.2** Aircraft must re-log-on to KZWY prior to re-entering the New York Oceanic CTA/FIR when they are advised by ATC to contact New York Radio on HF.

**3.8** Aircraft exiting the KZWY data link service area and approaching New York Center Domestic, New York Center Bermuda RADAR, San Juan, Piarco, Jacksonville, Miami, Moncton, and Gander Domestic can expect a CPDLC uplink message containing the VHF frequency assignment for the next facility. CPDLC End Service will be sent approximately 5 minutes prior to the boundary crossing point.

#### **4. Data Link Failure**

**4.1** In the event of data link failure or outages, flight crews must contact New York Radio or San Francisco Radio via HF voice for routine communications. When unable to communicate on HF, the pilot may conduct normal and routine communications with ATC via New York Radio or San Francisco Radio on SATVOICE. Direct SATVOICE contact with ATC should be limited to distress and urgency situations or when other means are not available and communication is essential.



## ENR 7.3 Special Procedures for In-Flight Contingencies in Oceanic Airspace

### 1. Introduction

**1.1** Although all possible contingencies cannot be covered, the procedures in paragraphs 2, 3, and 5 provide for the more frequent cases such as:

**1.1.1** Inability to comply with assigned clearance due to meteorological conditions (see paragraph 5);

**1.1.2** En route diversion across the prevailing traffic flow (for example, due to medical emergencies (see paragraphs 2 and 3)); and

**1.1.3** A loss, or significant reduction of, the required navigation capability when operating in airspace where the navigation performance accuracy is a prerequisite to the safe conduct of flight operations; or in the event of pressurization failure (see paragraphs 2 and 3).

**NOTE-**

*Guidance on procedures to follow when an aircraft experiences a degradation in navigation capabilities can be found in ICAO Doc 4444, Procedures for Air Navigation Services – Air Traffic Management, Chapter 5, section 5.2.2.*

**1.2** The pilot must take action as necessary to ensure the safety of the aircraft. The pilot's judgment shall determine the sequence of actions to be taken in regard to the prevailing circumstances. Air traffic control shall render all possible assistance.

### 2. General Procedures

**NOTE-**

*FIG ENR 7.3-1 provides an aid for understanding and applying the contingency procedures contained in paragraphs 2 and 3.*

**2.1** If an aircraft is unable to continue the flight in accordance with its ATC clearance, a revised clearance shall be obtained, whenever possible, prior to initiating any action.

**2.2** If prior clearance cannot be obtained, the following contingency procedures should be employed until a revised clearance is received:

**2.2.1** Leave the cleared route or track by initially turning at least 30 degrees to the right or to the left in order to intercept a parallel, same direction track or route offset 9.3 km (5.0 NM). The direction of the turn should be based on one or more of the following:

**2.2.1.1** Aircraft position relative to any organized track or route system;

**2.2.1.2** The direction of flights and flight levels allocated on adjacent tracks;

**2.2.1.3** The direction to an alternate airport;

**2.2.1.4** Any strategic lateral offset being flown; and

**2.2.1.5** Terrain clearance;

**2.2.2** The aircraft should be flown at a flight level and an offset track where other aircraft are less likely to be encountered;

**2.2.3** Watch for conflicting traffic both visually and by ACAS (if equipped), leaving ACAS in RA mode at all times unless aircraft operating limits dictate otherwise;

**2.2.4** Turn on all aircraft exterior lights (commensurate with appropriate operating limitations);

**2.2.5** Keep the SSR transponder on at all times and, when able, squawk 7700, as appropriate;

**2.2.6** As soon as practicable, the pilot shall advise air traffic control of any deviation from assigned clearance;

**2.2.7** Use whatever means is appropriate (i.e., voice and/or CPDLC) to communicate during a contingency or emergency;

**2.2.8** If voice communication is used, the radiotelephony distress signal (MAYDAY) or urgency signal (PAN PAN), preferably spoken three times, shall be used as appropriate;

**2.2.9** When emergency situations are communicated via CPDLC, the controller may respond via CPDLC. However, the controller may also attempt to make voice communication contact with the aircraft;

**NOTE-**

*Additional guidance on emergency procedures for controllers, radio operators, and flight crew, in data link operations can be found in the Global Operational Data Link (GOLD) Manual (Doc 10037).*

**2.2.10** Establish communications with nearby aircraft by broadcasting at suitable intervals on 121.5 MHz (or as a backup on the inter-pilot air-to-air frequency 123.45 MHz). Also broadcast where appropriate on the frequency in use: aircraft identification, the nature of the distress condition, intention of the person in command, position (including the ATS route designator or the track code, as appropriate), and flight level; and

**2.2.11** The controller should attempt to determine the nature of the emergency and ascertain any assistance that may be required. Subsequent ATC action with respect to that aircraft must be based on the intentions of the pilot and overall traffic situation.

**2.3** Actions to be Taken Once Offset from Track:

**NOTE-**

*The pilot's judgement of the situation and the need to ensure the safety of the aircraft will determine whether the actions outlined in 2.3.2.1 or 2.3.2.2 will be taken. Factors for the pilot to consider when diverting from the cleared route or track without an ATC clearance include, but are not limited to: operation within a parallel track system; the potential for User Preferred Routes (UPR) parallel to the aircraft's track or route; the nature of the contingency (for example, aircraft system malfunction); and weather factors (for example, convective weather at lower flight levels).*

**2.3.1** If possible, maintain the assigned flight level until established on the 9.3 km (5.0 NM) parallel, same direction track or route offset. If unable, initially minimize the rate of descent to the extent that is operationally feasible.

**2.3.2** Once established on a parallel, same direction track or route offset by 9.3 km (5.0 NM), either:

**2.3.2.1** Descend below FL 290, establish a 150 m (500 ft) vertical offset from those flight levels normally used, and proceed as required by the operational situation or, if an ATC clearance has been obtained, proceed in accordance with the clearance, or

**NOTE-**

*Descent below FL 290 is considered particularly applicable to operations where there is a predominant traffic flow (for example, east-west) or parallel track system where the aircraft's diversion path will likely cross adjacent tracks or routes. A descent below FL 290 can decrease the likelihood of conflict with other aircraft, ACAS RA events, and delays in obtaining a revised ATC clearance.*

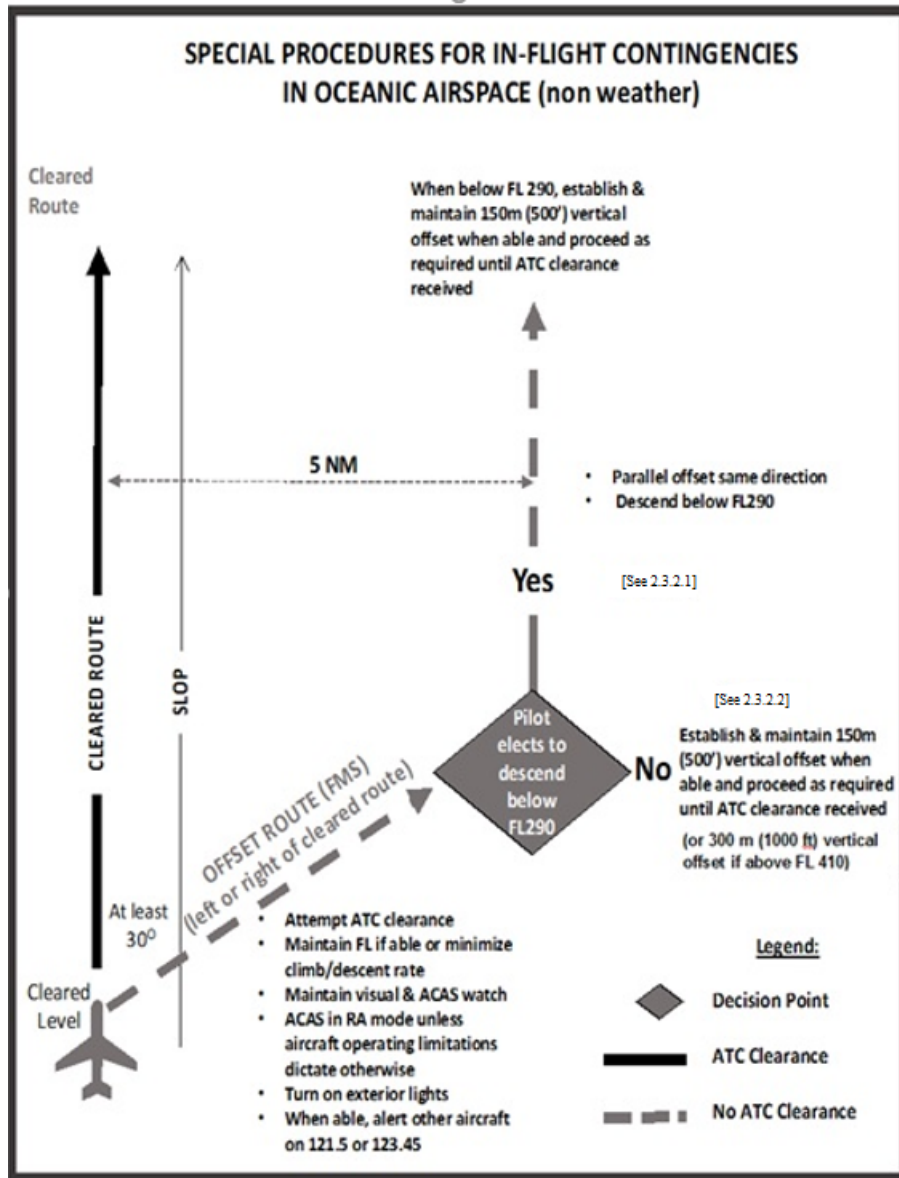
**2.3.2.2** Establish a 150 m (500 ft) vertical offset (or 300 m (1000 ft) vertical offset if above FL 410) from those flight levels normally used, and proceed as required by the operational situation, or if an ATC clearance has been obtained, proceed in accordance with the clearance.

**NOTE-**

*Altimetry system error may lead to less than actual 150 m (500 ft) vertical separation when the procedure above is applied. In addition, with the 150 m (500 ft) vertical offset applied, ACAS RAs may occur.*



FIG ENR 7.3-1  
Visual Aid for Understanding and Applying the Contingency Procedures Guidance



### 3. Extended Range Operations by Airplanes with Two-Turbine Power-Units (ETOPS)

3.1 If the contingency procedures are employed by a twin-engine aircraft as a result of an engine shutdown or failure of an ETOPS critical system, the pilot should advise ATC as soon as practicable of the situation, reminding ATC of the type of aircraft involved, and request expeditious handling.

### 4. Weather Deviation Procedures

#### 4.1 General.

**NOTE-**

*The following procedures are intended for deviations around adverse meteorological conditions.*

4.1.1 When weather deviation is required, the pilot should contact ATC via CPDLC or voice. A rapid response may be obtained by either:

**4.1.1.1** Stating, “WEATHER DEVIATION REQUIRED” to indicate that priority is desired on the frequency and for ATC response; or

**4.1.1.2** Requesting a weather deviation using a CPDLC lateral downlink message.

**4.1.2** When necessary, the pilot should initiate the communications using the urgency call “PAN PAN” (preferably spoken three times) or by using a CPDLC urgency downlink message.

**4.1.3** The pilot shall inform ATC when a weather deviation is no longer required, or when a weather deviation has been completed and the aircraft has returned to its cleared route.

**4.2** Actions to be Taken When Controller–Pilot Communications Are Established:

**4.2.1** The pilot should notify ATC and request clearance to deviate from track or route, advising when possible the extent of the deviation requested. The flight crew will use whatever means are appropriate (i.e., CPDLC and/or voice) to communicate during a weather deviation.

**NOTE–**

*Pilots are advised to contact ATC as soon as possible with requests for clearance in order to provide time for the request to be assessed and acted upon.*

**4.2.2** ATC should take one of the following actions:

**4.2.2.1** When appropriate separation can be applied, issue clearance to deviate from track; or

**4.2.2.2** If there is conflicting traffic and ATC is unable to establish appropriate separation, ATC should:

- a) Advise the pilot of inability to issue clearance for the requested deviation;
- b) Advise the pilot of conflicting traffic; and
- c) Request the pilot’s intentions.

**4.2.3** The pilot should take one of the following actions:

**4.2.3.1** Comply with the ATC clearance issued; or

**4.2.3.2** Advise ATC of intentions and execute the procedures provided in paragraph 4.3.

**4.3** Actions to be Taken if a Revised ATC Clearance Cannot Be Obtained:

**NOTE–**

*The provisions of this paragraph apply to situations where a pilot needs to exercise the authority of a pilot-in-command under the provisions of ICAO Annex 2, 2.3.1.*

**4.3.1** If the aircraft is required to deviate from track or route to avoid adverse meteorological conditions, and prior clearance cannot be obtained, an ATC clearance shall be obtained at the earliest possible time. Until an ATC clearance is received, the pilot shall take the following actions:

**4.3.1.1** If possible, deviate away from an organized track or route system;

**4.3.1.2** Establish communications with and alert nearby aircraft by broadcasting at suitable intervals: aircraft identification, flight level, position (including ATS route designator or the track code) and intentions, on the frequency in use and on 121.5 MHz (or as a backup, on the inter–pilot air–to–air frequency 123.45 MHz);

**4.3.1.3** Watch for conflicting traffic both visually and by reference to ACAS, if equipped;

**4.3.1.4** Turn on all aircraft exterior lights (commensurate with appropriate operating limitations);

**4.3.1.5** For deviations less than 9.3 km (5.0 NM) from the originally cleared track or route, remain at a level assigned by ATC;

**4.3.1.6** For deviations greater than or equal to 9.3 km (5.0 NM) from the originally cleared track or route, when the aircraft is approximately 9.3 km (5.0 NM) from track, initiate a level change in accordance with TBL ENR 7.3–1.

**4.3.1.7** If the pilot receives clearance to deviate from the cleared track or route for a specified distance and subsequently requests but is denied clearance to deviate beyond that distance, the pilot should apply an altitude offset in accordance with TBL ENR 7.3-1 immediately;

**4.3.1.8** When returning to track or route, the aircraft should be at the previously assigned flight level prior to a point 9.3 km (5.0 NM) from the route centerline.

**4.3.2** If contact was not established prior to deviating, continue to attempt to contact ATC to obtain a clearance. If contact was established, continue to keep ATC advised of intentions and obtain essential traffic information.

**NOTE-**

*If, as a result of actions taken under the provisions of 4.3.1 above, the pilot determines that there is another aircraft at or near the same flight level with which a conflict may occur, then the pilot is expected to adjust the path of the aircraft as necessary to avoid conflict.*

*TBL ENR 7.3-1*

**Altitude Offset When Denied Clearance to Deviate 9.3 km (5.0 NM) or More**

<b>Originally Cleared Track or Route Center Line</b>	<b>Deviations ≥ 9.3 km (5 NM)</b>	<b>Level Change</b>
EAST (000° – 179° magnetic)	LEFT	DESCEND 90 m (300 ft)
	RIGHT	CLIMB 90 m (300 ft)
WEST (180° – 359° magnetic)	LEFT	CLIMB 90 m (300 ft)
	RIGHT	DESCEND 90 m (300 ft)

**5. Houston/Miami/New York Oceanic CTA/FIR National Winter Storm Operations**

**5.1** During the winter season, the U.S. Air Force Reserves (AFRES), 53<sup>rd</sup> Weather Squadron has responsibility for flying winter storm reconnaissance missions. Mission aircraft will fly at altitudes between FL290 and FL350. At designated points, the aircraft will release dropsondes, 16-inch cardboard weather cylinders weighing one pound, each with an attached parachute. When in areas with no direct pilot-controller VHF/UHF communications, at five minutes prior to dropsonde release, the mission aircraft commander will broadcast on 121.5 and 243 the time and position of the intended drop. The dropsonde falls at a rate of approximately 2500 feet per minute.

**5.2** Aircraft commanders are directly responsible for or the release of any objects from the aircraft. ATC must provide traffic advisories, when feasible, to the aircraft. ATC will provide separation between the mission aircraft and any nonparticipating aircraft. ATC cannot provide separation between aircraft and the dropsonde.

**5.3** NOTAMs will be issued as early as possible prior to each mission. Airspace operators should consider any national winter storm operations during flight planning in the affected area(s) and nonparticipating aircrews should be especially alert to pertinent broadcasts on 121.5 or 243.0 during national winter storm operations.



## ENR 7.4 Operational Policy 50 NM Lateral Separation

### 1. Houston, Miami, and San Juan Oceanic Airspace

**1.1** The FAA and the Mexican air traffic services (ATS) providers have implemented 50 NM lateral separation between RNP 10 or RNP 4 aircraft operating in Gulf of Mexico oceanic airspace.

**1.2** Fifty (50) NM lateral separation is implemented in the Houston Oceanic CTA/FIR, the Gulf of Mexico portion of the Miami Oceanic CTA/FIR, the Monterrey CTA, and the Merida CTA within the Mexico FIR/UTA.

**1.3** RNAV routes within Houston Oceanic airspace are spaced a minimum of 50 NM to support this reduced lateral separation in the Gulf of Mexico.

**1.4** Information useful for flight planning and operations within the Gulf of Mexico, under this 50 NM lateral separation initiative can be found in the West Atlantic, Gulf of Mexico and Caribbean Resource Guide for U.S. Operators located at: <https://www.faa.gov/headquartersoffices/avs/wat-gomex-and-caribbean-resource-guide>. The Guide can also be found through a web search for “WAT, GOMEX, Caribbean Resource Guide.”

**NOTE–**

*For information pertaining to the operational policy of 50 NM lateral separation in the Atlantic portion of the Miami Oceanic CTA, or the San Juan CTA/FIR, please review ENR 7.4, paragraph 5., New York Oceanic Airspace.*

**1.5** The 50 NM lateral separation is applied at all altitudes above the floor of controlled airspace. Lateral separation of 100 NM will continue to be provided in the Houston Oceanic, Monterrey, and Merida CTA/FIRs to aircraft not authorized RNP 10 or RNP 4. Similarly, those aircraft will experience 90 NM lateral separation in Miami Oceanic CTA/FIR.

**1.6** Operations on certain routes that fall within the boundaries of affected CTAs are not affected by the application of 50 NM lateral separation. Operation on the following routes is not affected:

**1.6.1** Routes that are flown by reference to ICAO standard ground-based navigation aids (VOR, VOR/DME, NDB); and

**1.6.2** Special Area Navigation (RNAV) routes Q100, Q102 and Q105 in the Houston, Jacksonville and Miami CTAs.

### **1.7 Provisions for Accommodation of Non–RNP 10 Aircraft (Not Authorized RNP 10 or RNP 4).**

**1.7.1** Operators of Non–RNP 10 aircraft must:

**1.7.2** Annotate ICAO flight plan Item 18 as follows:

**1.7.2.1** “RMK/NON–RNP10” (no space between letters and numbers).

**1.7.2.2** Use of flight plan item 18 codes “PBN/A1” or “PBN/L1” are restricted to operators and aircraft specifically authorized for RNP 10 or RNP 4, as applicable.

**1.7.3** Pilots of non–RNP 10 aircraft that operate in GoMex CTAs must report the lack of authorization by stating “Negative RNP 10”:

**1.7.3.1** On initial call to ATC in a Gulf of Mexico CTA; or

**1.7.3.2** When approval status is requested by the controller (See paragraph 1.13.1.3).

**1.7.4** Non–RNP 10 operators/aircraft may file any route at any altitude in a Gulf of Mexico CTA. They will be cleared to operate on their preferred routes and altitudes as traffic permits. 50 NM lateral separation will not be applied to non–RNP 10 aircraft.

**1.7.5** Non–RNP 10 aircraft should plan on completing their climb to or descent from higher FLs within radar coverage, if possible.

**1.7.6** In order to maximize operational flexibility provided by 50 NM lateral separation, operators capable of meeting RNP 10 or RNP 4 that operate on oceanic routes or areas in the Gulf of Mexico CTAs should obtain authorization for RNP 10 or RNP 4 and annotate the ICAO flight plan accordingly.

**NOTE—**

*RNP 10 is the minimum Navigation Specification (NavSpec) required for the application of 50 NM lateral separation. RNP 4 is an operator option; operators/aircraft authorized RNP 4 are not required to also obtain RNP 10 authorization.*

**1.8 RNP 10 or RNP 4 Authorization Policy and Procedures for Aircraft and Operators**

**1.8.1** The following is ICAO guidance on the state authority responsible for authorizations such as RNP 10, RNP 4, and RVSM:

**1.8.1.1** International commercial operators:

The State of Registry makes the determination that the aircraft meets the applicable RNP requirements. The State of Operator issues operating authority (for example, Operations Specifications (OpSpecs)).

**1.8.1.2** International general aviation (IGA) operators:

The State of Registry makes the determination that the aircraft meets the applicable RNP requirements and issues operating authority (for example, Letter of Authorization (LOA)).

**1.9 Guidance Material.**

**1.9.1** FAA Advisory Circular (AC) 90–105, Approval Guidance for RNP Operations and Barometric Vertical Navigation in the U.S. National Airspace System and in Oceanic and Remote Continental Airspace, provides operational approval guidance for RNP 4 and 10. It identifies minimum aircraft capabilities and operator procedural and training requirements in order to qualify for RNP 4 and 10. AC 90–105 is consistent with the ICAO PBN Manual discussed below. Pertinent FAA and ICAO documents are posted online in the West Atlantic, Gulf of Mexico, and Caribbean Resource Guide for U.S. Operators described in paragraph 1.4.

**1.9.2** ICAO Performance–based Navigation (PBN) Manual (ICAO Doc 9613). Guidance for authorization of RNP 10 and RNP 4 is provided in ICAO Doc 9613. RNP 10 is addressed in Volume II, Part B; Chapter 1. RNP 4 is addressed in Volume II, Part C; Chapter 1.

**1.9.3** Operators are encouraged to use the B036/B054 Oceanic and Remote Continental Navigation Application Guide located at: <https://www.faa.gov/headquartersoffices/avs/b036b054-application-guide>.

**1.10** Qualification of Aircraft Equipped With a Single Long–Range Navigation System (LRNS) for RNP 10 Operations in Gulf of Mexico CTAs.

**1.10.1** Single LRNS operations in the Gulf of Mexico, the Caribbean Sea and the other designated areas have been conducted for at least 25 years. Provisions allowing aircraft equipage with a single LRNS for operations in specified oceanic and off–shore areas are contained in the following sections of 14 Code of Federal Regulations (CFR): 91.511, 121.351, 125.203 and 135.165.

**1.10.2** The FAA worked with State regulators and ATS providers in the Gulf of Mexico and Caribbean areas, and coordinated with the ICAO North American, Central American, and Caribbean office, to implement a policy allowing single LRNS equipped aircraft, which are also qualified for RNP 10, to take advantage of RNP 10 separation criteria in the Gulf of Mexico CTAs identified in paragraph 1.2 above.

**1.10.2.1** The factors considered in allowing RNP 10 operations in the Gulf of Mexico CTAs with single LRNS equipped aircraft were: the shortness of the legs outside the range of ground navigation aids, the availability of radar and VHF voice coverage in a large portion of Gulf of Mexico airspace, and the absence of adverse events attributed to single LRNS aircraft in Gulf of Mexico operations.

**1.10.2.2** For U.S. operators, operational authorization for both oceanic and RNP 10 operations, when equipped with only a single LRNS, is provided via Operations Specification/Management Specification/Letter of Authorization B054, Oceanic/Remote Continental Airspace Navigation Using a Single Long–Range Navigation System. A U.S. operator must first be issued B054 in order to file a flight plan indicating RNP 10 capability for operations in the Gulf of Mexico CTAs identified in paragraph 1.2 when equipped with only a single LRNS.

**1.10.3** Operators should review their Airplane Flight Manual (AFM), AFM Supplement or other appropriate documents and/or contact the airplane or avionics manufacturer to determine the RNP 10 time limit applicable to their aircraft. They will then need to determine its effect, if any, on their operation. Unless otherwise approved, the basic RNP 10 time limit is 6.2 hours between position updates for aircraft on which Inertial Navigation Systems (INS) or Inertial Reference Units (IRU) provide the only source of long range navigation. Extended RNP 10 time limits of 10 hours and greater are already approved for many IRU systems. FAA Advisory Circular 90–105 contains provisions for extending RNP 10 time limits.

### **1.11 Flight Planning Requirements**

**1.11.1** Operators must make ICAO flight plan annotations in accordance with this paragraph and, if applicable, Paragraph 1.7, Provisions for Accommodation of Non–RNP 10 Aircraft (Not Authorized RNP 10 or RNP 4).

**1.11.2** ICAO flight plans must be filed for operation on oceanic routes and areas in the Houston Oceanic CTA/FIR, the Gulf of Mexico portion of the Miami CTA/FIR, the Monterrey CTA and Merida High CTA.

**1.11.3** To inform ATC that they have obtained RNP 10 or RNP 4 authorization and are eligible for 50 NM lateral separation, operators must:

**1.11.3.1** Annotate ICAO Flight Plan Item 10 (Equipment) with the letter “R”; and

**1.11.3.2** Annotate Item 18 (Other Information) with, as appropriate, “PBN/A1” for RNP 10 aircraft or “PBN/L1” for RNP 4 aircraft (no space between letters and numbers).

**NOTE–**

*The letter “R” indicates that the performance–based navigation specification (for example, RNP 10 or RNP 4) is specified in Item 18 following the indicator “PBN/.”*

### **1.12 Operator Procedures.**

**1.12.1** Operator procedures regarding RNP 10 and RNP 4 are contained in Advisory Circular 90–105 and ICAO PBN Manual, Volume II, Parts B and C, Chapter 1.

**1.12.2** In the course of regular oceanic operations while flying within FAA controlled oceanic airspace and/or the Anchorage Flight Information Region (FIR), pilots should use SLOP procedures as defined in ENR 7.1, paragraph 8., Strategic Lateral Offset Procedure (SLOP).

**1.12.3** ICAO Doc 4444, Procedures for Air Navigation – Air Traffic Management, contains in–flight contingency procedures applicable in oceanic airspace, and is the source document for those procedures given the applicability of ICAO Rules of the Air over the high seas. The FAA publishes substantively identical contingency procedures in ENR 7.3 of the U.S. AIP and in Advisory Circular 91–70, Oceanic and Remote Continental Airspace Operations.

**1.12.3.1** Contingency procedures include General Procedures, as well as Weather Deviation Procedures. The procedures are applicable to in–flight diversion and turn–back, loss of navigation capability, and weather avoidance scenarios.

**1.12.3.2** Oceanic contingency procedures are important components of pilot training programs for oceanic operations.

**1.12.4** When pilots suspect a navigation system malfunction, in addition to the actions suggested in ENR 7.3, the following actions should be taken:

**1.12.4.1** Immediately inform ATC of navigation system malfunction or failure;

**1.12.4.2** Accounting for wind drift, fly magnetic compass heading to maintain track; and

**1.12.4.3** Request radar vectors from ATC, when available.

### **1.13 Pilot Report of Non–RNP 10 Status**

**1.13.1** The pilot must report the lack of RNP 10 or RNP 4 status in accordance with the following:

**1.13.1.1** When the operator/aircraft is not authorized RNP 10 or RNP 4 (See paragraph 1.7.)

**1.13.1.2** If approval status is requested by the controller:

**1.13.1.3** The pilot must communicate approval status using the following phraseology in TBL ENR 7.4-1.

TBL ENR 7.4-1

Controller Request	Pilot Response
[call sign] “CONFIRM RNP 10 OR 4 APPROVED”	“AFFIRM RNP 10 APPROVED”  or  “AFFIRM RNP 4 APPROVED” as appropriate;  or  “NEGATIVE RNP 10”

## 2. Oakland Oceanic Airspace

**2.1** The application of 50 NM lateral separation minima between aircraft authorized RNP 10 or RNP 4 is supported.

**2.2** RNP 10 is required for all aircraft operating in the Central East Pacific (CEP) fixed track system and Pacific Organized Track System (PACOTS).

**2.3** Flight planning guidelines for non-RNP 10 aircraft are published in the Pacific Chart Supplement.

## 3. Anchorage Oceanic FIR

**3.1** The application of 50 NM lateral separation minima between aircraft authorized RNP 10 or RNP 4 is supported.

**3.2** Non-RNP 10 approved aircraft may file via random track, at any altitude, at least 100 NM from the North Pacific (NOPAC) fixed track system. Aircraft entering the NOPAC should flight plan in accordance with Notices contained in the Alaska Chart Supplement.

## 4. Anchorage Arctic FIR

**4.1** The application of 50 NM lateral separation minima between aircraft authorized RNP 10 is supported.

## 5. New York Oceanic Airspace

**5.1** ATC applies 50 NM lateral separation between aircraft authorized RNP 10 or RNP 4 within New York Oceanic West airspace. ATC similarly applies 50 NM lateral separation in the Atlantic portion of the Miami Oceanic CTA as well as the San Juan CTA/FIR. ATC may apply 50 NM lateral separation between aircraft authorized RNP 10 or RNP 4 in New York Oceanic East.

**5.2** Aircraft authorized RNP 10 or RNP 4 will have a better chance of obtaining their preferred routing and altitude in the most densely used airspace (that is, below FL 410) because of their ability to participate in ATC’s use of 50 NM lateral separation. Non-RNP 10 or non-RNP 4 aircraft will be spaced at least 90 NM laterally from other aircraft.



**5.3** ATC will not apply 50 NM lateral separation on routes that are within ATC radar and VHF voice radio coverage. New York Oceanic airspace contains the following routes or route segments, which, at and above FL 310, are within ATC radar and VHF radio coverage:

**5.3.1** M201 between VIRST and VEGAA.

**5.3.2** Y485, Y488, Y493, and Y494. Refer also to ENR 7.10 for guidance on Y–routes.

**NOTE–**

*While flying these route segments, pilots communicate directly with ATC using VHF voice radio, and domestic procedures apply. Strategic Lateral Offset Procedure (SLOP) is not to be used. Oceanic data link procedures described in ENR 7.2 (with KZWW log–on) are also not applicable.*

**5.4** Flight plan filing and addressing requirements are detailed in ENR 7.1, paragraphs 2. and 3.

**5.5** Operators of aircraft not authorized RNP 10 or RNP 4 are expected to follow the procedures in ENR 7.4 paragraphs 1.7 and 1.13 for alerting ATC of the RNP status. Those operators are expected to indicate their “non–RNP 10” status in Item 18 of their ATC flight plan. In addition, pilots are expected to inform ATC of their “non–RNP 10” status on initial call to ATC and when reading back a clearance to descend through FL 410.

**5.6** Filing a flight plan for, and conducting operations under, RNP 10 or RNP 4 navigation specifications require the aircraft to be equipped with two operable long–range navigation systems (LRNS). Operators who indicate RNP 10 or RNP 4 capability on their ATC flight plans, and subsequently experience an LRNS failure, must alert ATC to this failure. If the pilot believes the aircraft can continue to navigate along the cleared route with the single LRNS, ATC should be informed; as such, ATC may continue the aircraft on the cleared route.

**5.7** In the event of LRNS failure, pilots must inform ATC of the failure and ensure ATC is aware the aircraft is no longer qualified for the RNP level indicated on the flight plan. In addition to this notification, pilots should request ATC amend their flight plan to remove the RNP capability indication in Item 18 of the flight plan.

**5.8** Information regarding operations in the New York – West Oceanic CTA, the Atlantic portion of the Miami Oceanic CTA, and the San Juan Oceanic CTA can be found in the West Atlantic, Gulf of Mexico, and Caribbean Resource Guide for U.S. Operators, which is available at:

<https://www.faa.gov/headquartersoffices/avs/wat-gomex-and-caribbean-resource-guide>.

## **6. Provisions for Accommodation of Non–RNP 10 Aircraft (Not Authorized RNP 10 or RNP 4)**

The guidance contained in paragraphs 1.7 and 1.13 of this section is applicable to all operations using Non–RNP 10 aircraft throughout the airspace covered by this document.

## **7. RNP 10 or RNP 4 Authorization Policy and Procedures for Aircraft and Operators**

The guidance contained in paragraphs 1.8 and 1.9 of this section is applicable to operations throughout the airspace covered by this document.

## **8. Flight Planning Requirements**

The guidance contained in paragraphs 1.7 and 1.11 of this section is applicable to operations throughout the airspace covered by this document.

## **9. Pilot and Dispatcher Basic and In–Flight Contingency Procedures**

Information and guidance pertaining to in–flight contingency procedures, applicable in all the oceanic airspace covered by this AIP are provided in ENR 7.4, paragraph 1.12 as well as section ENR 7.3.



# ENR 7.5 Operational Policy Performance-Based Navigation (PBN) and Performance-Based Communication and Surveillance (PBCS)

## 1. Introduction

**1.1** Distance-based longitudinal separation minima using Automatic Dependent Surveillance-Contract (ADS-C) is implemented in Oakland Oceanic airspace as specified in TBL ENR 7.5-1.

*TBL ENR 7.5-1*  
**Minima**

<b>Minima</b>				
<b>Standard</b>	<b>RNP</b>	<b>RCP</b>	<b>RSP</b>	<b>Maximum ADS-C Periodic Reporting Interval</b>
50 NM	10	240	180	27 minutes
50 NM	4	240	180	32 minutes
30 NM	4	240	180	14 minutes

**1.2** Distance-based longitudinal separation minima using ADS-C is implemented in the Anchorage Oceanic and New York Oceanic airspace as specified in TBL ENR 7.5-2.

*TBL ENR 7.5-2*  
**Minima**

<b>Minima</b>				
<b>Standard</b>	<b>RNP</b>	<b>RCP</b>	<b>RSP</b>	<b>Maximum ADS-C Periodic Reporting Interval</b>
50 NM	10	240	180	27 minutes
50 NM	4	240	180	32 minutes
30 NM	4	240	180	10 minutes

**1.3** Aircraft Future Air Navigation System (FANS) 1/A communications, navigation and surveillance (CNS) capabilities, interfaced with Advanced Technology and Oceanic Procedures (ATOP), are required for ADS-C distance based separation to be applied.

**NOTE-**

1. ADS-C distance based separation standards may not be applied to aircraft utilizing High Frequency Data Link (HFDL).
2. ADS-C distance based separation is not currently authorized in the Anchorage Arctic FIR.

**1.4** 23 NM lateral separation is applied between RNP 4 aircraft capable of RSP 180 and RCP 240 with ADS-C waypoint change event and 5 NM lateral deviation event contracts established.

## 2. Application

**2.1** Oakland, New York and Anchorage ARTCCs will apply the following policies to the use of ADS-C distance based separation:

- 2.1.1 The separation will be applied to pairs of suitably equipped pairs of aircraft;
- 2.1.2 Published ATS routes and other tracks (e.g., PACOTS) will continue to be laterally separated by a minimum of 50 NM;
- 2.1.3 Minimum ADS-C based longitudinal separation between RNP 4 eligible aircraft and RNP 10 eligible aircraft is 50 NM; and
- 2.1.4 Lateral and longitudinal separation standards applied between RNP 10 and non-RNP 10 aircraft remains unchanged.

### 3. Aircraft and Operator Eligibility for Performance-Based Separation

- 3.1 The aircraft and operator must be authorized by the State of the Operator or the State of Registry, as appropriate, for 50 NM: at a minimum, RNP 4 or RNAV 10, RCP 240, and RSP 180; and for 30 NM: at a minimum, RNP 4, RCP 240, and RSP 180 operations;
- 3.2 The aircraft must be equipped with a minimum of two approved long range navigation systems that will enable the aircraft to maintain RNP 4 for the duration of flight in the applicable airspace;
- 3.3 The aircraft must be equipped with a FANS1/A package (or equivalent) that includes satellite Controller Pilot Data Link Communication (CPDLC) and ADS-C that meet the standards of RTCA Document 258, Interoperability Requirements for ATS Applications Using ARINC 622 Data Communications;
- 3.4 Satellite CPDLC communications and ADS-C surveillance must be conducted in accordance with the ICAO Global Operational Data Link Document (GOLD), as amended, and maintained for the duration of the flight in the applicable Pacific FIRs; and
- 3.5 Pilots and, if applicable, dispatchers must be trained on policies and procedures applicable to ADS-C distance based separation, including the use of Satellite CPDLC and ADS-C in Pacific oceanic airspace.
- 3.6 Operators should use the ICAO GOLD to develop policy and procedures for CPDLC and ADS-C operations.
  - 3.6.1 Operators must use one of the following documents to develop policy and procedures for RNP 4 operations:
    - 3.6.1.1 FAA Advisory Circular (AC) 90-105, Approval Guidance for RNP Operations and Barometric Vertical Navigation in the U.S. National Airspace System and in Oceanic and Remote Continental Airspace;
    - 3.6.1.2 Australian Civil Aviation Safety Authority (CASA) Advisory Circular 91U3(0); or
    - 3.6.1.3 ICAO Performance-Based Navigation (PBN) Manual ( ICAO Document 9613), Volume II, Part C, Chapter 1.
    - 3.6.1.4 ICAO Performance-Based Communication and Surveillance (PBCS) Manual ( ICAO Doc 9869).

### 4. Flight Planning Requirements

See ENR 7.1, paragraph 2, Flight Plan Filing Requirements.

**NOTE-**

*Other than the flight plan requirements discussed in ENR 7.1, Paragraph 2, Flight Plan Filing Requirements, application of distance based separation does not affect operator planning processes or procedures for filing flight plans. Operators that have filed and flown User Preferred Routes (UPRs) may continue to do so.*

### 5. In-Flight Contingency Actions/ Procedures and Emphasis on Situational Awareness

- 5.1 Pilots should be aware that ADS-C distance based separation can be applied to their aircraft. They should use all available tools to maintain an awareness of other aircraft in their proximity in case an inflight contingency occurs (e.g., aircraft or ATC system malfunction).

**5.2** Pilots must advise ATC of a loss of CPDLC and/or ADS-C capability or an inability to continue to meet RNP 4. ATC will transition the aircraft to another form of separation as expeditiously as possible.

**5.3** If there is a known malfunction of the CPDLC or ADS-C system, ATC will contact aircraft and transition the aircraft to another form of separation as expeditiously as possible.

**5.4** Pilots should use the guidance in ENR 7.3, Special Procedures for In-Flight Contingencies in Oceanic Airspace. This reflects current ICAO guidance calling for a 5 NM track offset when unable to obtain ATC clearance prior to executing maneuvers for contingencies such as rapid descent, turn back, or diversion. This is of particular importance for aircraft to which 30 NM separation can be applied.

**5.5** Pilots are required to maneuver (deviate) around convective weather on a regular basis in the course of Pacific operations. The enhanced CNS requirements and capabilities aid pilots and controllers in situations where aircraft are required to maneuver around convective weather. For weather avoidance maneuvers in areas where ADS-C distance based separation is applied, operators should emphasize the following items in pilot training programs:

**5.5.1** Pilots should not assume the ATOP system will automatically quickly detect significant changes to the aircraft flight path. Unlike radar, the ATOP system does not receive aircraft position updates in real-time. Aircraft position is updated to the ATOP system at intervals of up to 27 minutes. Controllers may change the update intervals as the situation warrants.

**5.5.2** It is imperative that pilots keep ATC advised via CPDLC (or HF voice, if necessary) of their intentions (including significant airspeed changes) during the initial weather avoidance maneuver and any subsequent maneuvers to avoid convective weather.

**5.5.3** Pilots must be aware that other aircraft could be approximately 30 NM ahead or behind on the same track, and inform ATC expeditiously of changes to flight path or airspeed that could erode longitudinal separation.

**5.5.4** Pilots must be familiar with ENR 7.3, Special Procedures for In-Flight Contingencies in Oceanic Airspace.

**NOTE-**

*In particular, pilots should be aware of the provision to climb or descend 300 feet (depending on the direction of flight and direction of deviation from track) to mitigate the chance of conflict with other aircraft when forced to deviate without a clearance.*

**5.5.5** It is recommended that ACAS be operational for aircraft to which 30 NM separation can be applied. ACAS provides a valuable tool to alert the pilot to the presence and proximity of nearby aircraft in weather deviation situations.

**5.5.6** In accordance with ICAO Document 4444, pilots are reminded that, regardless of the magnitude of a deviation from assigned route, whenever possible, clearance should be requested in advance from ATC. Prior coordination with ATC will help prevent the aircraft generating unnecessary alerts to ATC for lateral deviation events.

**NOTE-**

*This does not apply to SLOP.*

**5.5.7** Operators should consider adopting guidance for pilots to use heading mode to maneuver around areas of convective weather. Use of heading mode will prevent transmission of unnecessary lateral deviation event alerts that some flight management systems (FMS) automatically transmit to ATC when the FMS automatic lateral offset feature is used for weather avoidance. It should be emphasized that, when using heading mode, pilots should monitor cross track and heading and return to track when weather avoidance maneuvering is complete.

**5.5.8** Aircraft navigation errors and system malfunctions will be monitored and documented. Operators should cooperate in follow up investigation of these events.



## ENR 7.6 North Atlantic (NAT) Oceanic Clearance Procedures

### 1. Introduction

**1.1** New York ARTCC issues Oceanic Clearances to eastbound aircraft entering North Atlantic High Level Airspace.

**1.2** Due to continuing safety concerns associated with the non-adherence to, or incorrect execution of, Oceanic Clearances and tactical reroutes, the FAA evaluated its current method of issuing an Oceanic Clearance by New York ARTCC. This analysis identified several procedural changes that could be made to the method by which an Oceanic Clearance is issued in order to improve safety.

**1.3** These procedural changes do not eliminate the issuance of any portion of the Oceanic Clearance and satisfy the requirements contained in Nat Doc 007, North Atlantic Operations and Airspace Manual, Chapter 5, Oceanic ATC Clearances. It is not the intent to remove any altitude or speed confirmation; only the re-issuing of the cleared route has been eliminated.

### 2. Procedures

**2.1** There are three components to an Oceanic Clearance: (1) route; (2) altitude; and (3) speed. New York ARTCC will use multiple methods to comply with the NAT requirement to issue the three elements of an Oceanic Clearance.

**2.2** Aircraft entering the New York ARTCC Oceanic CTA from a FAA facility:

**2.2.1** The airport clearance which an aircraft receives on the ground at its departure aerodrome is considered to be the route portion of the Oceanic Clearance. Altitude and speed assignment will occur prior to entry into the New York ARTCC Oceanic CTA.

**2.2.2** As is the current operating procedure, unsolicited en-route route, altitude or speed amendments may occur due to changing traffic situations. At all times, the last assigned route, altitude and speed are to be maintained and should be considered the new oceanic profile.

**2.2.3** Having received all three components, the requirement to receive an oceanic clearance will have been met.

**NOTE-**

*For example – An aircraft has filed an FPL from MDSD to EDDF. This would take the flight from the Santo Domingo FIR, through the Miami FIR and then the New York FIR before entering Santa Maria. The airport clearance provided on the ground at MDSD would fulfill the route requirement of the Oceanic Clearance. Once airborne and in the Miami FIR, final speed and altitude assignment will be given after the flight is coordinated between Miami and New York.*

**2.3** North American (NAM) region departures:

**2.3.1** Aircraft departing airports close to an oceanic boundary will receive the route portion of their Oceanic Clearance from Clearance Delivery. At most major airports in North America, the route portion is up-linked to the flight deck using the Pre-departure Clearance (PDC) method. This is an automated means to transmit the flight plan on file with air traffic control directly to the flight crew. At airports without the use of PDC, clearances are relayed via voice.

**2.3.2** Once airborne and within United States offshore RADAR airspace, aircraft will be assigned an oceanic altitude and Mach number. The oceanic altitude may or may not be the aircraft current cleared altitude.

**2.4** Caribbean/South American (CAR/SAM) region departures:

**2.4.1** For aircraft originating from airports within the CAR/SAM region, New York ARTCC will utilize the procedures outlined in 5.6 of NAT Doc 007 to fulfill the requirements of the route portion of an oceanic clearance.

Once airborne and within United States offshore RADAR airspace, the aircraft will be assigned its oceanic altitude and Mach number.

**2.5** Piarco FIR traffic:

**2.5.1** Aircraft originating from airports within the CAR/SAM region and not entering a United States offshore RADAR sector will not be included in these changes at this time.

**2.5.2** Piarco will continue to use existing procedures for these aircraft.

**2.6** Canadian FIR traffic:

**2.6.1** Aircraft originating from airports within the NAM region and not entering a United States offshore RADAR sector will not be included in these changes at this time.

**2.6.2** Moncton ACC and Gander ACC will continue to use existing procedures for these aircraft.

**2.7** If a route, speed or altitude change en-route is desired, then aircraft should make a request from the ATC unit in which they are operating. At all times, the last assigned route, altitude and speed are to be maintained.

**2.8** In conjunction with this procedure, operators are encouraged to file in Item 15 of the FPL the coordinates of a track in lieu of the track identification letter (e.g., NATU).

**2.9** Operators are reminded of the requirement to file an FPL and any subsequent changes with New York Oceanic at KZWYZOZX, along with any other ATC facilities that may require such filing.



## ENR 7.7 North Atlantic (NAT) Timekeeping Procedures

**1.** Prior to entry into NAT High Level Airspace, the time reference system(s) to be used during the flight for calculation of waypoint estimated times of arrival (ETAs) and waypoint actual times of arrival (ATAs) must be synchronized to universal coordinated time (UTC). All ETAs and ATAs passed to air traffic control must be based on a time reference that has been synchronized to UTC or equivalent. Acceptable sources of UTC include:

**1.1** WWV – National Institute of Standards and Technology (Fort Collins, Colorado). WWV operates 24 hours a day on 2500, 5000, 10000, 15000, 20000 kHz (AM/single sideband (SSB)) and provides UTC voice every minute.

**1.2** GPS (corrected to UTC) – Available 24 hours a day to those pilots who can access the time signal over their shipboard GPS equipment.

**1.3** CHU – National Research Council (NRC) – Available 24 hours a day on 3330, 7335, and 14670 kHz (SSB). In the final 10 – second period of each minute, a bilingual station identification and time announcement is made. Since April 1990, the announced time is UTC.

**1.4** BBC – British Broadcasting Corporation (United Kingdom). The BBC transmits on a number of domestic and worldwide frequencies and transmits the Greenwich time signal (referenced to UTC) once every hour on most frequencies, although there are some exceptions.

**1.5** Any other source shown to the State of Registry or State of Operator, as appropriate, to be an equivalent source of UTC.



## ENR 7.8 North Atlantic (NAT) Safety Information

### 1. Report Leaving, Report Reaching

**1.1** The early discovery of altitude deviations is extremely important to the overall safety of NAT operations. Deferring the required reports of leaving and reaching flight levels until the next routine communication may lead to instances where aircraft fly at the incorrect flight level for long durations. This is not acceptable from a system safety standpoint. While the actual number of vertical errors in the NAT Region is relatively small, some of these errors continue undetected (and therefore uncorrected) for long durations.

**1.2** In practical terms:

**1.2.1** Report leaving a flight level as soon as the aircraft begins climb or descent;

**1.2.2** Report reaching a flight level as soon as the aircraft is level; and

**1.2.3** In RVSM airspace, provide the reports even if air traffic control has not specifically requested them.

### 2. Adherence to Oceanic Clearance

**2.1** As a key part of ensuring the overall safety in the NAT Region, pilots are reminded of the importance of strict adherence to the oceanic clearance. The NAT oceanic clearance provides separation from all known aircraft from the oceanic entry point to the oceanic exit point. This separation can only be assured if all aircraft enter oceanic airspace in accordance with their oceanic clearance.

**2.2** Although it may be desirable to defer climb or descent to the cleared oceanic flight level, delaying the request to domestic air traffic control for a clearance may result in entering oceanic airspace at a less optimum flight level.

**2.3** In practical terms:

**2.3.1** Flights must enter oceanic airspace level at the cleared oceanic flight level;

**2.3.2** Flights must enter oceanic airspace at the cleared oceanic entry point;

**2.3.3** Flights must maintain the assigned true Mach number;

**2.3.4** If a pilot cannot comply with any part of the oceanic clearance, air traffic control must be informed immediately;

**2.3.5** Pilots must ensure that their aircraft performance enables them to maintain the cleared oceanic flight level for the entire oceanic crossing; and

**2.3.6** If a pilot discovers that the aircraft is not able to reach or remain at a cleared flight level, air traffic control must be informed immediately.

### 3. Turbulence Impact Assessment

**3.1** To help in assessing whether moderate or severe turbulence might have an impact on operations in the NAT Region when reduced vertical separation minimum of 1,000 feet is applied between FL290 and FL410 inclusive, the frequency and magnitude of altitude deviations from assigned FL caused by moderate to severe turbulence needs to be quantified.

**3.2** To this end, air crews operating in the NAT Region, are required to include the magnitude of the deviation, in feet, from assigned FL in all required reports of moderate to severe turbulence.

### 4. Common Procedures for Radio Communications Failure in the North Atlantic (NAT)

**NOTE-**

*The following procedures are intended to provide general guidance for NAT aircraft experiencing a communications failure.*

*These procedures are intended to complement and not supersede state procedures/regulations. It is not possible to provide guidance for all situations associated with a communications failure.*

#### **4.1 General.**

**4.1.1** If so equipped, the pilot of an aircraft experiencing a two-way-radio communications failure must operate the secondary radar transponder on identity Mode A (Code 7600) and Mode C.

**4.1.2** The pilot must also attempt to contact any ATC facility or another aircraft and inform them of the difficulty and request they relay information to the ATC facility with which communications are intended.

#### **4.2 Communications failure prior to entering NAT oceanic airspace.**

**4.2.1** If operating with a received and acknowledged oceanic clearance, the pilot must enter oceanic airspace at the cleared oceanic entry point, level and speed and proceed in accordance with the received and acknowledged oceanic clearance. Any level or speed changes required to comply with the oceanic clearance must be completed within the vicinity of the oceanic entry point.

**4.2.2** If operating without a received and acknowledged oceanic clearance, the pilot must enter oceanic airspace at the first oceanic entry point, level, and speed, as contained in the filed flight plan and proceed via the filed flight plan route to landfall. That first oceanic level and speed must be maintained to landfall.

#### **4.3 Communications failure prior to exiting NAT oceanic airspace.**

**4.3.1** If cleared on flight plan route the pilot must proceed in accordance with the last received and acknowledged oceanic clearance to the last specified oceanic route point, normally landfall, then continue on the flight plan route. Maintain the last assigned oceanic level and speed to landfall. After passing the last specified oceanic route point, conform to the relevant State procedures/regulations.

**4.3.2** If cleared on other than flight plan route the pilot must proceed in accordance with the last received and acknowledged oceanic clearance to the last specified oceanic route point, normally landfall. After passing this point, rejoin the filed flight plan route by proceeding directly to the next significant point ahead of the track of the aircraft as contained in the filed flight plan. Where possible use published ATS route structures, then continue on the flight plan route. Maintain the last assigned oceanic level and speed to the last specified oceanic route point. After passing this point conform to the relevant State procedures/regulations.

### **5. When Able Higher (WAH) Reports**

**5.1** To ensure maximum use of available altitudes, aircraft entering RVSM airspace in the New York FIR should be prepared to advise ATC of the time or position the aircraft can accept the next higher altitude. WAH reports are also used to plan the altitude for aircraft; therefore, it is important that the altitude capability of the aircraft is known by controllers.

**5.1.1** If the aircraft is capable of a higher altitude that is not preferred by the pilot, give the altitude in the WAH report and advise that you prefer not to be assigned that altitude.

**5.2** ATC acknowledgment of a WAH report is NOT a clearance to change altitude.

**5.3** The procedures will differ for eastbound and westbound aircraft since many of the eastbound aircraft will enter New York RVSM airspace from ATC sectors that have direct controller-pilot communications.

**5.3.1** Eastbound aircraft entering RVSM airspace in the New York FIR:

**5.3.1.1** Pilots may be requested by ATC to provide an estimate for when the flight can accept the next higher altitude(s). If requested, pilots should provide this information as soon as possible.

**5.3.2** Westbound aircraft entering RVSM airspace in the New York FIR:

**5.3.2.1** Pilots should include in the initial position report the time or location that the next higher altitude can be accepted.

**EXAMPLE-**

*“Global Air 543, 40 north 40 west at 1010, flight level 350, estimating 40 north 50 west at 1110, 40 north 60 west. Next able flight level 360 at 1035.”*

**NOTE-**

*Pilots may include more than one altitude if that information is available.*

**EXAMPLE-**

*(After stating initial report) “Able flight level 360 at 1035, able flight level 370 at 1145, able flight level 390 at 1300.”*



## ENR 7.9 San Juan FIR Customs Procedures

### 1. Introduction

**1.1** Aircraft arriving to locations in U.S. territorial airspace, including the San Juan FIR, must meet the entry requirements as described in AIP Section ENR 1.12, National Security and Interception Procedures.

**1.2** Pilots must comply with all applicable U.S. Customs and Border Protection (CBP) requirements, in accordance with 19 CFR Part 122, Air Commerce Regulations. Information regarding U.S. CBP requirements, including Advance Passenger Information System (APIS), is available at <http://www.cbp.gov>.





## ENR 7.10 Y-Routes

### 1. Introduction

**1.1** The FAA has established a network of area navigation (RNAV) routes to enhance efficiency of air traffic flow and control over the West Atlantic, Gulf of Mexico, the Bahamas, and Puerto Rico. These RNAV routes, charted as “Y” routes, exist largely, but not exclusively, within U.S. “offshore airspace.” Operators may find U.S. offshore airspace labeled as “Atlantic High,” “Atlantic Low,” “Gulf of Mexico High,” etc., on FAA IFR en route charts. In accordance with 14 CFR Part 71, § 71.1, § 71.33, and § 71.71, offshore airspace at and above 18,000 feet MSL is Class A airspace, while that offshore airspace below 18,000 feet MSL is Class E. The FAA normally uses domestic air traffic control procedures, vice oceanic procedures, in offshore airspace. Aircraft flying Y-routes will typically be within signal coverage of U.S. ground navigation facilities and ATC radar. Actual signal reception and radar detection are a function of aircraft altitude. The majority of Y-routes exist only in the upper altitude structure, i.e., Class A offshore airspace.

### 2. General Requirements

**2.1** The Y-routes are designated RNAV 2 with GNSS required. Aircraft flying the Y-routes must be equipped with GNSS and able to meet RNAV 2 performance requirements. RNAV systems relying solely on DME/DME or inertial navigation are not suitable (and therefore not authorized) for use on any Y-route.

**2.2** Pilots must indicate on their ATC flight plan at least the minimum equipment and capability required for RNAV 2 with GNSS. Item 10 of the flight plan must indicate G and R. Item 18 must indicate PBN/C2.

### 3. Operational Requirements

**3.1** Pilots are expected to fly the route centerline, as defined by the aircraft RNAV system. Pilots must not use strategic lateral offset procedures (SLOP) while on the Y-routes.

**3.2** Operators must check predicted RAIM availability for the expected duration of their flight on a Y-route. Five (5) minutes is the maximum predicted continuous loss of RAIM allowed for flight on a Y-route.

### 4. Pilot Knowledge

**4.1** Advisory Circular (AC) 90-100, U.S. Terminal and En Route Area Navigation (RNAV) Operations, contains pilot knowledge subject matter that is generally applicable to any RNAV operation. General aviation pilots in particular should use the RNAV subject matter contained in AC 90-100 in preparation for any flight on an RNAV route, including Y-routes.



## ENR 7.11 Atlantic High Offshore Airspace Offshore Routes Supporting Florida Airspace Optimization

### 1. Introduction

**1.1** On 27 October 2005, nine new directional offshore Class I area navigation (RNAV) Atlantic Routes (ARs) were established between Florida and northeastern US airport pairs. These routes support the Florida Airspace Optimization project and are designed to relieve traffic congestion and reduce in-trail delays. The nine new offshore RNAV routes, designated AR15, AR16, AR17, AR18, AR19, AR21, AR22, AR23 and AR24, were established between FL240 and FL600 inclusive.

**1.2** None of the waypoints will be compulsory reporting points since the new and revised routes are entirely within radar coverage.

**1.3** Southbound routes include AR15, AR17, AR19, and AR22, while northbound routes include AR16 and AR18. AR23, AR24 are bidirectional.

**1.4** Air traffic control services for these routes in offshore airspace is provided by Washington, Jacksonville and Miami ARTCCs.

### 2. Filing Routes

**2.1** Flights departing from and landing at airports within the domestic U.S. should file to conform with the appropriate Preferred IFR Routes listed in the Airport Facility Directories. International traffic southbound from the Wilmington VORTAC/Dixon NDB (ILM/DIW) area filing over MCLAW, FUNDI, Fish Hook NDB (FIS), or CANOA should file AR17. International traffic southbound from the ILM/DIW area filing over Freeport VOR (ZFP) or URSUS should file AR23 or AR24. Traffic originating south of Miami, Florida, filing over the ILM/DIW area should file AR16, AR18, AR23 or AR24.

### 3. RNAV Equipment Eligibility

**3.1** In accordance with 14 CFR Parts 91.511, 121.351, 125.203, and 135.165 (as applicable), an approved Long-Range Navigation System is required for operation on these RNAV routes. Operators must not flight plan or operate on these routes unless their aircraft are equipped with RNAV systems approved for IFR navigation and the pilots are qualified to operate them. Approved GPS IFR units and inertial navigation systems meeting the guidance below provide acceptable performance.

**3.2** Aircraft are eligible to operate on these routes provided that the Airplane Flight Manual or FAA approved documentation indicates that the navigation system installation has received airworthiness approval in accordance with one or more of the following:

**3.2.1** AC 20-138, as amended (Multi-Sensor Navigation System Approval);

**3.2.2** AC 20-138, as amended (GPS approval);

**3.2.3** AC 90-100, Annex 2, as amended (U.S. Terminal and En Route RNAV Operations); and/or

**3.2.4** Title 14 CFR Part 121 Appendix G (INS).

### 4. Operational Requirements and Procedures

**4.1** Operators filing or accepting clearance for these RNAV routes are certifying that the crews and equipment are qualified to conduct RNAV operations.

**4.2** Operators must be responsible for navigating along route centerline, as defined by aircraft navigation systems. Strategic Lateral Offset Procedures used in oceanic airspace are not applicable on these routes.

**4.3** The pilot must notify ATC of any loss of navigation capability that affects the aircraft ability to navigate the routes.

**4.4** ATC will provide radar separation for these routes. In the event of loss of radar, ATC will advise the aircraft and apply appropriate separation.

**4.5** INS or IRS Limitation. While operating on these AR routes, aircraft equipped with Inertial Navigation Systems (INS) or Inertial Reference Systems (IRS) that cannot receive automatic position (for example, DME/DME) updates for the entire length of the route, are limited to 1.0 consecutive hour of un-updated operation. This one hour time period starts when the INS or IRS is placed in the navigation mode, and applies en route between automatic position updates. Systems performing updating after the pilot has manually selected the navigation aid are considered to have “automatic update” capability. If an aircraft is unable to conduct an update in accordance with the above guidance, the pilot must notify ATC and ATC will then provide radar vectors and/or other ATC services.

**4.6** Some AR routes are co-designated Y routes, e.g., AR3/Y307. The route filed in the flight plan governs the navigation equipment and performance requirements. Filing for Y307 on a route designated AR3/Y307 for example, requires the aircraft to be equipped with GNSS and flown with RNAV 2 performance on that route, in accordance with section ENR 7.10.

## ENR 7.12 Reduced Separation Climb/Descent Procedures

### 1. Automatic Dependent Surveillance– Broadcast (ADS–B) In–Trail Procedure (ITP)

**1.1** The ITP is designed for use in non-surveillance oceanic airspace to enable appropriately equipped ADS–B In aircraft to perform flight level (FL) changes previously unavailable with procedural separation minima applied. The improved traffic information available to ADS–B In-equipped aircraft allows ITP maneuvers to occur safely with reduced separation minima applied. ITP will enable flight crews to execute FL changes to improve ride comfort, avoid weather, or obtain more favorable winds to improve fuel economy and arrival times. The ITP is only available within the Anchorage, Oakland, and New York Oceanic Flight Information Regions (FIR).

**1.2** FAA air traffic procedures for the ADS–B ITP mirror those contained within ICAO Document 4444 (Doc. 4444), Procedures for Air Navigation Service– Air Traffic Management (PANS–ATM), Section 5.4.2.7, Longitudinal Separation Minima Based on Distance Using ADS–B In–Trail Procedure (ITP), with one difference. Section 5.4.2.7.3.2 of Doc. 4444 states, “A controller may clear an aircraft for an ITP climb or descent provided the following conditions are satisfied: d) both the ITP aircraft and reference aircraft are either on; 2) parallel or same tracks with no turns permitted during the manoeuvre.” The FAA’s Advanced Technology and Oceanic Procedures (ATOP) automation platform is designed to ensure that separation will not decrease below required minima for same track aircraft should either the reference or maneuvering aircraft turn during the ITP. FAA Order JO 7110.65, Air Traffic Control, states that an aircraft may be cleared for an ITP climb or descent if both the ITP aircraft and reference aircraft are on the “same tracks with no turns permitted that reduce required separation during the ITP.”

**1.3** Equipment specifications and guidance for pilot procedures is available in FAA Advisory Circular (AC) 90–114, Automatic Dependent Surveillance–Broadcast (ADS–B) Operations, Appendix 2, ADS–B In–Trail Procedure.

**1.4** Additional information is also available in ICAO Circular 325, In–Trail Procedure (ITP) Using Automatic Dependent Surveillance–Broadcast (ADS–B).

### 2. Automatic Dependent Surveillance– Contract (ADS–C) Climb Descend Procedure (CDP)

**2.1** The ADS–C CDP is designed to improve service to properly equipped aircraft by allowing an oceanic air traffic controller to have an option for granting an altitude change request when other standard separations (such as ADS–C distance–based 30 NM longitudinal separation minima) do not allow for a climb or descent through the altitude of a blocking aircraft. It is an air traffic control tool to be applied between maneuvering and blocking aircraft pairs. The CDP is only available within the Anchorage, Oakland, and New York Oceanic FIRs.

**2.2** FAA air traffic procedures, published in FAA Order JO 7110.65, Chapter 8, mirror those in ICAO Document 4444 (Doc 4444), Procedures for Air Navigation Service–Air Traffic Management (PANS–ATM), Section 5.4.2.8, Longitudinal Separation Minima Based on Distance Using ADS–C Climb and Descend Procedure (CDP), and in ICAO Circular 342, Automatic Dependent Surveillance – Contract (ADS–C) Climb and Descend Procedure (CDP). The FAA’s ATOP automation platform is designed to alert the controller before separation decreases below the required minima. Aircraft pair distance verification is performed by the ground automation system, using near simultaneous ADS–C demand reports.

**2.3** The implementation of the ADS–C CDP is intended to facilitate increased access to optimum flight levels for aircraft operating in airspace where no ATS surveillance service is available. It is similar to the ADS–B ITP [see ICAO Circular 325, In–Trail Procedure (ITP) Using Automatic Dependent Surveillance–Broadcast (ADS–B)] in that it is a climb or descend through procedure. Unlike the ITP, however, the pilots involved in an ADS–C CDP may not be aware of which separation minima a controller is utilizing.



## ENR 7.13 New York Oceanic Control Area (OCA) West Flight Level Allocation

### 1. Background

**1.1** The primary air traffic flows in the New York OCA West airspace are between Northeast and Mid- Atlantic U.S. airports and Caribbean and South American destinations.

**1.2** This primary flow is regularly crossed by the flow of traffic transitioning to and from the Southeast U.S./Caribbean and the North Atlantic and New York OCA East airspace.

**1.3** The ATS routes that comprise the West Atlantic Route System (WATRS) are bi-directional. Therefore, it is important that the northbound flows are procedurally separated from the southbound flows to the maximum extent possible.

### 2. Altitude Filing

**2.1** A Flight Level schema has been designed as a guide for operators and dispatchers to determine what altitudes to file to transit the OCA West airspace.

**2.2** The following aircraft should file **ODD** flight levels:

**2.2.1** Aircraft operating South or Southeast bound on the following routes: L451, L452, L453, L454, L455, L456, L457, L459, L461, and L462;

**2.2.2** Northeast bound on M201, M202, M203, M204; and

**2.2.3** East or Northeast bound on L375, L435, M325, M326, M327, M328, M329, M330, M331, M593, M594, M595, M596, M597, and M525.

**2.3** For aircraft operating opposite direction to that listed above on the same routes – aircraft should file **EVEN** flight levels.

**NOTE–**

*Due to the amount of crossing traffic throughout the region, final altitude assignments will always be determined dynamically by ATC, based on the current traffic and operational conditions.*





## ENR 7.14 Gulf of Mexico RNAV Routes Q100, Q102, and Q105

### 1. Introduction

The three Q routes over the northern portion of the Gulf of Mexico, Q100, Q102, and Q105, have different navigation equipment requirements and are not the same as the RNAV Q routes over the continental United States. Operators flying any of the three routes require aircraft equipped with a long-range navigation system, as defined in 14 CFR Part 1, § 1.1. Operators may not rely on ground-based navigation aids alone for operations on the three Gulf Q routes.

### 2. Operational Requirements

**2.1** For U.S. commercial operators, i.e., those operating under 14 CFR Parts 91 subpart K, 121, 125, and 135, navigation systems acceptable for flying the Gulf Q routes are those incorporating GPS and/or inertial systems inputs, and authorized in their Operations Specification/Management Specification/Letter of Authorization B034. For operators flying under part 91, an acceptable long-range navigation system is one approved for IFR navigation and incorporating GPS and/or inertial system inputs. Operators' Airplane Flight Manual, Pilot Operating Handbook, avionics manual, or other manufacturer-provided documentation should reference AC 20-138 as the source of guidance for airworthiness approval of applicable positioning and navigation systems.

**2.2** Pilots should fly the route centerlines at all times and must notify Air Traffic Control (ATC) of any loss of navigation capability that affects the aircraft's ability to track the route centerline. Pilots must not use Strategic Lateral Offset Procedures (SLOP) on the three Gulf Q routes.

**2.3** Aircraft without GPS-based RNAV capability that are relying on inertial navigation systems to fly the three Gulf Q routes are limited to 1.5 consecutive hours between inertial position updates (e.g., a DME update of the inertial navigation system). Timing of the 1.5-hour limit begins when automatic updates of the inertial navigation system are no longer available or immediately following the flight crew's manual inertial system position update.

**2.4** Routes Q100 and Q102 are co-designated Y280 and Y290 respectively. The route filed in the flight plan governs the navigation equipment and performance requirements. Filing for Y280 on the route designated Q100/Y280 requires the aircraft to be equipped with GNSS and flown with RNAV 2 performance on that route, in accordance with section ENR 7.10.

**NOTE-**

*ATC normally provides radar monitoring along the three Gulf Q routes. Pilots can expect ATC to advise them when radar monitoring is unavailable and to adjust aircraft separation as necessary.*



## ENR 8. Unmanned Aircraft Systems (UAS)

### ENR 8.1 General

#### 1. General

**1.1** UAS operations are governed by the Code of Federal Regulations (CFR) and the United States Code (USC). The type of operation, purpose of the flight, and weight of the UAS all factor into the specific rule that governs UAS operations.

**1.1.1** 14 CFR Part 107, Small Unmanned Aircraft Systems. Examples of 14 CFR Part 107 operations include commercial aerial photography, commercial aerial survey, other operations for hire, and operations that are not conducted purely for pleasure/recreation. These operations will be referred to as Part 107 operations in ENR 8, Unmanned Aircraft Systems (UAS). Part 107 operations are limited to small UAS (sUAS) weighing less than 55 pounds.

**1.1.2** USC 44809, Exception for Limited Recreational Operations of Unmanned Aircraft, Operations. Recreational flyers operate UAS for pleasure or recreation. These operations will be referred to as Recreational Flyer operations in ENR 8, Unmanned Aircraft Systems (UAS). Recreational flyers typically operate UAS or model aircraft, also called radio-controlled (RC) aircraft. Recreational flyers operating UAS weighing more than 55 pounds may operate in compliance with standards and limitations developed by a CBO and from fixed sites, which are described in ENR 8.4, subparagraph 1.3.1, Fixed Sites.

**1.1.3** CFR Part 91, UAS Operations. 14 CFR Part 91 operations include public UAS, and civil UAS 55 pounds or more Maximum Gross Operating Weight (MGOW). These operations will be referred to as Part 91 UAS operations in ENR 8, Unmanned Aircraft Systems (UAS). For more information on public UAS operations, the requirements for qualification as a public operator, and how aircraft and pilots are certified, refer to AC 00-1.1, Public Aircraft Operations, Manned and Unmanned.

**NOTE-**

*14 CFR Part 91 operations can include UAS weighing less than 55lbs.*

**REFERENCE-**

*14 CFR Part 107, Small Unmanned Aircraft Systems.*

*49 USC 44809, Exception for Limited Recreational Operations of Unmanned Aircraft.*

*FAA Order JO 7210.3, Chapter 5, Section 5, 14 CFR Part 91, UAS Operations.*

*AC 00-1.1 Public Aircraft Operations, Manned and Unmanned.*

#### 2. Access to the National Airspace System (NAS) for UAS Operators

**2.1** UAS operations must be integrated into the NAS while maintaining existing operational capacity and safety without introducing an unacceptable level of risk to airspace users or persons and property on the ground. The FAA is committed to striking the appropriate regulatory and oversight balance to ensure that American innovation is able to thrive without compromising the safest, most efficient aerospace system in the world.

**2.2** UAS operators can access the NAS in multiple ways. Generally, UAS weighing less than 55 pounds MGOW are permitted to operate within Visual Line Of Sight (VLOS) up to 400 feet Above Ground Level (AGL) in Class G airspace. Operations within controlled airspace require specific authorization from Air Traffic Control (ATC).

**2.2.1** Part 107 sUAS operators can request airspace authorizations via Low Altitude Authorization and Notification Capability (LAANC) or DroneZone to fly within Class B, Class C, and Class D or within the lateral boundaries of the surface area of Class E airspace designated for an airport. Operations within controlled airspace can be readily approved in accordance with the altitude values indicated on the corresponding UAS Facility Map (UASFM). The UASFM values indicate the maximum altitude at which a sUAS operation can be approved

without any further coordination with the respective ATC facility. Part 107 remote pilots and operators may request “further coordination” for an airspace authorization to operate above UASFM values, up to 400 feet AGL. See ENR 8.4, subparagraph 2.1, for further information regarding Part 107 operations.

**NOTE-**

*Emergency airspace authorizations for Special Government Interest (SGI) UAS operations will be addressed in ENR 8.8, paragraph 5.*

**2.2.2** Recreational Flyer Operations. Recreational flyers may operate in controlled and uncontrolled airspace under specific conditions. In Class B, C, D or the surface area of Class E airspace designated for an airport. The operator must obtain an ATC authorization prior to operating. In Class G airspace, the aircraft must be flying not more than 400 feet AGL and comply with all airspace restrictions and prohibitions. Recreational flyers may operate at an FAA-recognized fixed site above 400 feet AGL with an FAA-approved letter of agreement with the appropriate ATC authority or up to UASFM altitudes in controlled airspace with an airspace authorization obtained through LAANC.

**2.2.3** Part 91 UAS Operations. Public UAS, and civil UAS 55 pounds or more MGOW operate under 14 CFR Part 91, UAS operations. Public UAS operators and civil, non-recreational UAS weighing 55 pounds or more MGOW are provided NAS access by compliance with certain parts of 14 CFR Part 21, experimental certificates, and 14 CFR Part 91, UAS Operations. Part 91 UAS operators require a COA to operate within the NAS. Specific geographic/altitude limitations are prescribed in the COA. Additional pilot and aircraft requirements are applicable to Part 91 UAS operations. See ENR 8.3, Large UAS (MGOW 55 Pounds or More), and ENR 8.4, paragraph 3., Airspace Access for PAO, for further information on Part 91 UAS operations.

**REFERENCE-**

*14 CFR Section 21.191, Experimental Certificates.  
FAA Order JO 7210.3, Chapter 5, Section 5, 14 CFR Part 91, UAS Operations.*

## ENR 8.2 Small Unmanned Aircraft System (sUAS)

### 1. Part 107 sUAS and Recreational Flyers

**1.1** Part 107 UAS. A regulatory first step for civil non-recreational UAS operations. To fly under 14 CFR Part 107, the UAS must weigh less than 55 pounds and the operator (called a remote pilot) must pass a knowledge test. Also, the UAS must be registered. Part 107 enabled the vast majority of routine sUAS operations, allowing flight within VLOS while maintaining flexibility to accommodate future technological innovations. Part 107 allows sUAS operations for many different purposes without requiring airworthiness certification, exemptions, or a COA for Class G airspace access. Part 107 includes the opportunity for individuals to request waivers for certain provisions of the rules, for example, Beyond Visual Line Of Sight (BVLOS). Part 107 also has specific restrictions which are not subject to waiver, such as the prohibition of the carriage or transport of Hazardous Materials (HAZMAT).

#### 1.2 Recreational Flyer UAS:

**1.2.1** The FAA considers recreational UAS to be aircraft that fall within the statutory and regulatory definitions of an aircraft, in that they are devices that are used or intended to be used for flight in the air. As aircraft, these devices generally are subject to FAA oversight and enforcement.

**REFERENCE-**

*49 USC 40102, Definitions.*

*14 CFR Part 1, Definitions and Abbreviations.*

**1.2.2** Recreational aircraft may operate in Class G airspace where the aircraft is flown from the surface to not more than 400 feet AGL, and the operator must comply with all airspace restrictions and prohibitions. The only exception to this altitude restriction in Class G airspace is at FAA-recognized fixed sites and sanctioned events, with specifically approved procedures for flights above 400 feet AGL.

**NOTE-**

*Higher altitude airspace authorizations for Recreational Flyers are obtained through the FAA's DroneZone website at: <https://faadronezone.faa.gov/#/>.*

**1.2.3** The Recreational UAS Safety Test (TRUST) module was developed in consultation with multiple UAS stakeholders and through interested party feedback. TRUST is available electronically, has no minimum age limit, and is provided by volunteer test administrators, vetted by the FAA. See ENR 8.5, paragraph 1., UAS Pilot Certification and Requirements for Part 107 and Recreational Flyers, for further information on TRUST. Additional information regarding TRUST is available at the FAA's The Recreational UAS Safety Test website.

**NOTE-**

*The FAA's The Recreational UAS Safety Test website may be viewed at: [https://www.faa.gov/uas/recreational\\_fliers/knowledge\\_test\\_updates/](https://www.faa.gov/uas/recreational_fliers/knowledge_test_updates/).*

**1.2.4** Recreational UAS weighing more than .55 lbs must be registered. This can be done electronically through the FAA's DroneZone website. Owners must then label all aircraft with their assigned registration number on the exterior of their aircraft so that the registration can be clearly seen and read from a reasonable distance. For more information on registering UAS See ENR 8.2, paragraph 2., Registration Requirements, for more information on registering UAS.

**NOTE-**

*The FAA's DroneZone website may be viewed at: <https://faadronezone.faa.gov/#/>.*

### 2. Registration Requirements

**2.1** Nearly all UAS flown in the NAS are required to be registered in the FAA aircraft registration database. UAS weighing 55 pounds MGOW or more must be registered under 14 CFR Part 47, Aircraft Registration, while UAS less than 55 pounds may be registered under the FAA's newer 14 CFR Part 48 online system.

**NOTE-**

The FAA's Aircraft Registration Unmanned Aircraft (UA) website may be viewed at: [https://www.faa.gov/licenses\\_certificates/aircraft\\_certification/aircraft\\_registry/UA/](https://www.faa.gov/licenses_certificates/aircraft_certification/aircraft_registry/UA/).

**REFERENCE-**

14 CFR Part 47, Aircraft Registration.

**2.2** Registering UAS under 14 CFR Part 47. For those UAS, which do not meet the weight stipulations for registration under 14 CFR Part 48, registration is accomplished under 14 CFR Part 47. 14 CFR Part 47 registration will result in an "N"-number like those assigned to manned aircraft. To learn more about the process and to register a UAS under Part 47, see the FAA's Aircraft Registration Unmanned Aircraft (UA) website. If desired by the owner, any UAS may be registered under 14 CFR Part 47.

**NOTE-**

The FAA's Aircraft Registration Unmanned Aircraft (UA) website may be viewed at: [https://www.faa.gov/licenses\\_certificates/aircraft\\_certification/aircraft\\_registry/UA/](https://www.faa.gov/licenses_certificates/aircraft_certification/aircraft_registry/UA/).

**2.3** Registering UAS under 14 CFR Part 48. For most operators of sUAS (those UAS weighing less than 55 pounds MGOW), registration under 14 CFR Part 48, Registration and Marking Requirements for Small UA, will be most expedient and the least expensive. 14 CFR Part 48 registrants are those UAS flyers operating under either of the following statutes:

**2.3.1** Part 107. Under the provisions of Part 107, all UAS must be registered regardless of weight. Operations under Part 107 are generally those involving commerce, but can be for recreation as well.

**2.3.2** Recreational Flyers. UAS that are flown exclusively for recreational purposes must be registered if they weigh more than 0.55 pounds (250 grams).

**NOTE-**

1. If you are not sure what kind of a drone flyer you are, refer to the FAA's User Identification Tool at: [https://www.faa.gov/uas/getting\\_started/user\\_identification\\_tool/](https://www.faa.gov/uas/getting_started/user_identification_tool/), or visit the FAA Getting Started webpage at: [https://www.faa.gov/uas/getting\\_started/](https://www.faa.gov/uas/getting_started/).

2. Registrations cannot be transferred between 14 CFR Part 107 UAS and 49 USC 44809 UAS.

**REFERENCE-**

14 CFR Part 48, Registration and Marking Requirements for Small Unmanned Aircraft.

**2.4** How to Register a UAS under 14 CFR Part 48:

**2.4.1** To register a UAS online under Part 48, refer to the FAA's DroneZone website. When registering a UAS online under Part 48, you will need to select registration in either Part 107 or the exception for recreational flyers.

**2.4.2** Registration fees for Part 107 registration are per sUAS, and the registration is valid for three years. Each Part 107 registered sUAS will receive a different number. Recreational flyer registration fees are per UAS and valid for three years, but the same registration number can be applied to any UAS in the registrant's ownership. The recreational flyer will receive one registration number that can be used for all UAS flown by that person. In order to register, a person must be 13 years of age or older and be a U. S. citizen or legal permanent resident. If the owner is less than 13 years of age, another person 13 years of age or older must register the UAS and that person must be a U.S. citizen or legal permanent resident.

**2.4.3** An FAA registration certificate will be issued after UAS registration. The registration certificate (either paper copy or digital copy) must be available for inspection during all flight operations. If an individual other than the registered owner operates a UAS the registration certificate (either paper copy or digital copy) must also be available for inspection during all flight operations. Federal law requires registered UAS operators, if asked, to show their certificate of registration to any federal, state, or local law enforcement officer. Failure to register a UAS that requires registration may result in regulatory and criminal penalties. The FAA may assess civil penalties up to \$27,500.

**NOTE-**

The FAA's DroneZone website may be viewed at: <https://faadronezone.faa.gov/#/>.

**2.5** Labeling a UAS with a Registration Number. All UAS requiring registration must be marked with a registration number before being flown. The UAS registration number can be applied to the aircraft by

engraving, a permanent label, or written on with a permanent marker. The registration number must be visible and on the outside surface of the UAS.





## ENR 8.3 Large UAS (MGOW 55 Pounds Or More)

### 1. Large Public UAS Operations

**1.1** Large public UAS may have wingspans as large as commercial airliners, and may operate in and out of public/military dual-use airfields. Due to the high altitudes at which these UAS routinely operate, and the means through which they reach and vacate operating altitude, encounters with manned or low-altitude unmanned traffic are rare.

**1.2** Public users operating as “public aircraft” retain the responsibility to determine airworthiness and pilot qualifications. Aircraft certification and operating rules apply to the entire UAS, including the aircraft itself, the flight crew with their associated qualifications, the control station, and command and control links.

**NOTE-**

*Large UAS operating in controlled airspace generally communicate on radio frequencies or through an ATC-to-PIC ground communications link assigned to that sector, terminal area, or control tower. The UAS PIC is required to comply with all ATC instructions and uses standard phraseology per FAA Order JO 7110.65, Air Traffic Control, and this manual.*

**REFERENCE-**

*49 USC 40102, Definitions.  
49 USC 40125, Qualifications for Public Aircraft Status.  
FAA Order JO 7110.65, Air Traffic Control.  
AIP, ENR 8.4, Para 3, Airspace Access for PAO.*

**1.3** Operating Characteristics of Large Public UAS. To illustrate the sizes and performance of large public UAS, consider the DoD UAS classification system. The categories (see FIG ENR 8.3-1) are separated based on MGOW, normal operating altitude, and flying speed. These classifications do not apply to non-DoD civil aircraft. Generally, Groups 1 through 3 UAS will operate on and above military bases, in restricted or prohibited airspace. For this reason, these smaller tactical public aircraft will rarely be encountered by civil pilots. Groups 4 and 5 are the largest of DoD UAS, weighing over 1,320 pounds, and operating at all speeds and altitudes. Group 4 aircraft operate at all altitudes, usually below 18,000 feet MSL. Group 5 aircraft typically operate well above 18,000 feet MSL. UAS in Groups 4 and 5 require airfields with specially approved surfaces to safely operate. For specifications and descriptions of the aircraft types that the DoD operates, refer to military service fact sheets.

**NOTE-**

**1.** *The category chart does not specify the actual high gross weights at which some DoD UAS actually operate. For instance, the RQ-4 Global Hawk regularly operates at approximately 32,000 pounds.*

**2.** *JP 3-30, III 31, Joint Publication 3-30, provides the UAS Categorization Chart and may be reviewed at: [https://www.jcs.mil/Portals/36/Documents/Doctrine/pubs/jp3\\_30.pdf?ver=2019-09-04-142255-657](https://www.jcs.mil/Portals/36/Documents/Doctrine/pubs/jp3_30.pdf?ver=2019-09-04-142255-657).*

**3.** *These websites provide unclassified descriptions, performance, and specifications of the varied UAS in the DoD's large category fleet: USAF Fact Sheets at <https://www.af.mil/About-Us/Fact-Sheets/> and USN Fact Files at <https://www.navy.mil/Resources/Fact-Files/>.*

FIG ENR 8.3-1  
DoD UAS Categories

### Unmanned Aircraft Systems Categorization Chart

UA Category	Maximum Gross Takeoff Weight (lbs)	Normal Operating Altitude (ft)	Speed (KIAS)	Representative UAS
Group 1	0-20	< 1200 AGL	100 kts	WASP III, TACMAV RQ-14A/B, Buster, Nighthawk, RQ-11B, FPASS, RQ16A, Pointer, Aqua/Terra Puma
Group 2	21-55	< 3500 AGL	< 250	ScanEagle, Silver Fox, Aerosonde
Group 3	< 1320	< 18,000 MSL	< 250	RQ-7B Shadow, RQ-15 Neptune, XPV-1 Tern, XPV-2 Mako
Group 4	> 1320		Any Airspeed	MQ-5B Hunter, MQ-8B Fire Scout, MQ-1C Gray Eagle, MQ-1A/B/C Predator
Group 5	> 1320	> 18,000 MSL	Any Airspeed	MQ-9 Reaper, RQ-4 Global Hawk, RQ-4N Triton

**Legend**

AGL	above ground level	lbs	pounds
FPASS	force protection aerial surveillance system	MSL	mean sea level
ft	feet	TACMAV	tactical micro air vehicle
KIAS	knots indicated airspeed	UA	unmanned aircraft
kts	knots	UAS	unmanned aircraft system

**1.4 Large Public UAS Engineering Characteristics and Operating Areas:**

**1.4.1** Large public UAS may be sharing airspace with civil aircraft in the NAS. A wide variety of aircraft performance, voice radio communications, command and control link architecture, and operating procedures exists throughout the DoD and other large public UAS enterprises. For example, Group 4 DoD aircraft, such as the MQ-1 Predator and MQ-9 Reaper, are typically propeller-driven with propulsion units that are internal combustion piston- or turbine-powered. The largest public UAS include single-engine jet aircraft such as the RQ-4 Global Hawk and MQ-4C Triton.

**1.4.2** VLOS and BVLOS link systems provide command and control for these large UAS operations. Voice communication capability in the largest public UAS is far more extensive than in the smaller aircraft. Many UAS

are limited to a single voice radio transmitter and receiver system for control inside airspace managed by and/or delegated to the DoD.

**1.4.3** Many of the larger public UAS are equipped with transponders to assist ATC with position and tracking information. These UAS usually operate under IFR under positive ATC control and will tend to be found at very high altitudes; not likely to be encountered by civil aircraft operators. Launch and recovery operations will be likewise under positive ATC control and these UAS will be separated from any other known aircraft traffic. Encounters with low–altitude sUAS, being flown in uncontrolled airspace or under low–altitude controlled airspace authorizations, are therefore unlikely. In accordance with 14 CFR Part 91.215(e)(2), ATC Transponder and Altitude Reporting Equipment and Use, no person may operate an unmanned aircraft under Part 91 with a transponder on unless: (1) the operation is conducted under a flight plan and the person operating the unmanned aircraft maintains two–way communications with ATC; or (2) the use of a transponder is otherwise authorized by the Administrator.

**NOTE–**

*In accordance with 14 CFR Section 107.52, ATC Transponder Equipment Prohibition, unless otherwise authorized by the Administrator, no person may operate a sUAS under Part 107 with a transponder on.*

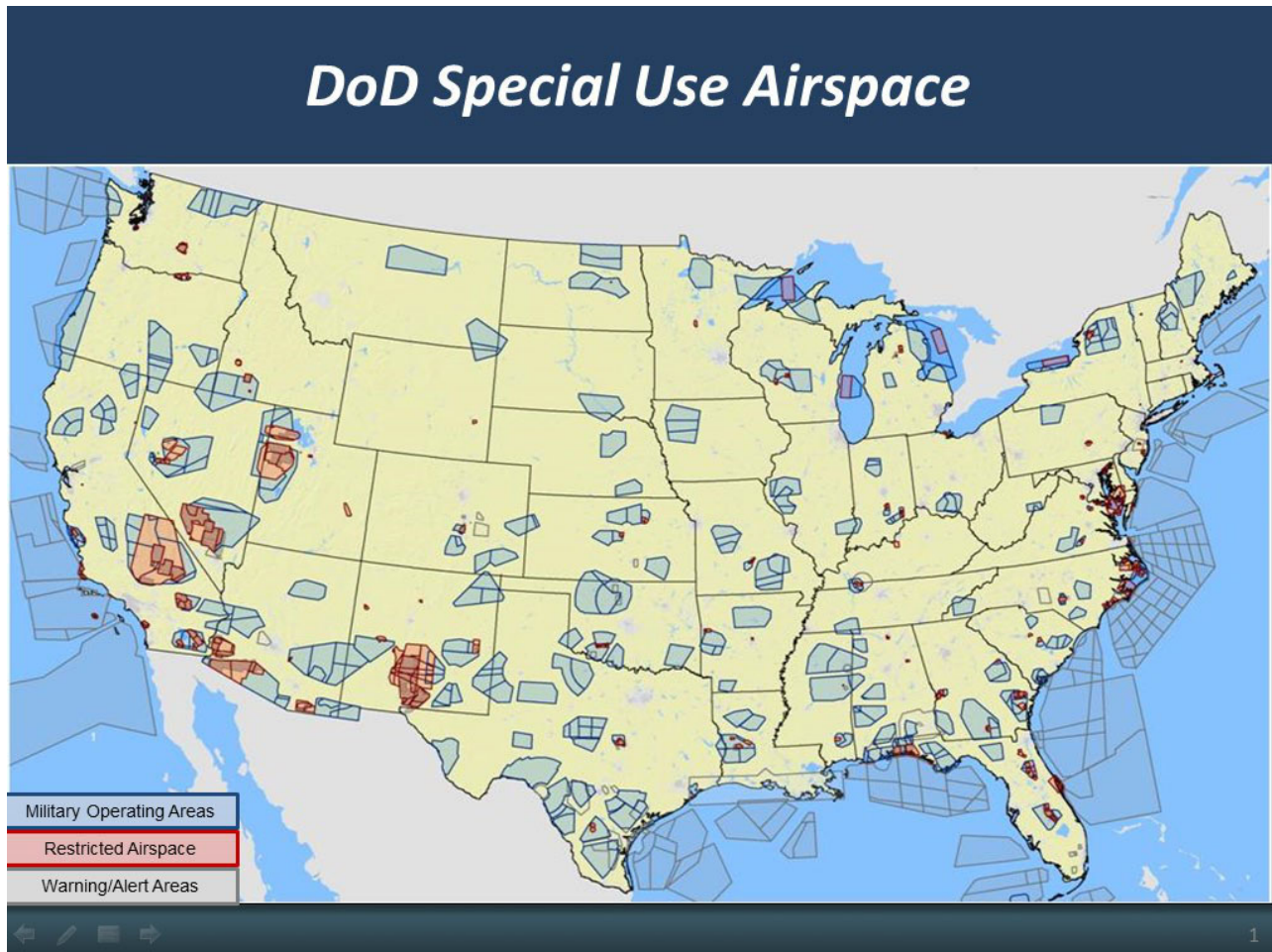
**REFERENCE–**

*14 CFR Section 91.215 ATC Transponder and Altitude Reporting Equipment and Use.  
14 CFR Section 107.52, ATC Transponder Equipment Prohibition.*

**1.5 Large Public UAS Launch, Recovery, and Operating Areas:**

**1.5.1** Large public UAS operations are widespread, they are also carefully managed to ensure enhanced safety for other NAS users. For this reason, DoD UAS operate in many types of special use airspace. See FIG ENR 8.3–2 for examples of Special Use Airspace (SUA) used by DoD UAS.

FIG ENR 8.3-2  
DoD Special Use Airspace



**1.5.2** Temporary Flight Restrictions (TFRs) are issued for the surrounding UAS operating locations and allow for the launch and recovery of larger UAS. Once outside of the terminal environment, DoD UAS utilize the full range of SUA, including a Military Operating Areas (MOA), restricted areas, warning areas, and alert areas to conduct their missions.

## **2. Exemptions under 49 USC 44807, Special Authority for Certain Unmanned Systems**

**2.1** Exemptions are granted to UAS operations which are permitted in accordance with Public Law 115-254, 49 USC 44807, Special Authority for Certain Unmanned Aircraft Systems. The Secretary of Transportation has determined that certain UAS are eligible to operate in the NAS without possessing the airworthiness certification normally required under 49 USC 44807. 49 USC 44807 permits the FAA to use a risk-based approach to determine whether an airworthiness certificate is required for a UAS to operate. Exemptions are generally requested by civil (non-public) UAS operators who fly UAS weighing 55 pounds or more, and thus cannot fly under 14 CFR Part 107. For civil UAS operations conducted under 49 USC 44807 of PL 115-254, the Secretary has determined that specific requirements necessary for safe operation can often be addressed in the form of grants of exemption(s). Operators who desire this regulatory relief must petition the FAA for exemption in accordance with 14 CFR Part 11 and the guidance provided on the FAA's Section 44807, Special Authority for Certain Unmanned Systems website. Examples of petitions that have been granted to conduct civil UAS operations include the following activities:

**2.1.1** Closed-set motion picture and television filming.

- 2.1.2 Agricultural survey and spraying.
- 2.1.3 Aerial photography.
- 2.1.4 Land survey and inspection.
- 2.1.5 Inspection of structures.
- 2.1.6 Search and Rescue (SAR) operations.

**NOTE–**

*Civil agricultural spraying operations will also require a 14 CFR Part 137 certificate; see ENR 8.4, paragraph 5, Airspace Access for 14 CFR Part 135 and 14 CFR Part 137.*

**2.2 Exemption Application.** Petitioners seeking a grant of exemption should fill out an online application on the public docket located on the FAA’s regulations.gov website.

**REFERENCE–**

*49 USC 44807, Special Authority for Certain Unmanned Aircraft Systems.*

**NOTE–**

*The FAA’s Section 44807: Special Authority for Certain Unmanned Systems website may be reviewed at: [https://www.faa.gov/uas/advanced\\_operations/certification/section\\_44807/](https://www.faa.gov/uas/advanced_operations/certification/section_44807/). The FAA’s Regulations.gov website may be reviewed at: [https://www.faa.gov/regulations\\_policies/faq\\_regulations](https://www.faa.gov/regulations_policies/faq_regulations).*

### **3. Emerging Large UAS Civil Operations**

**3.1 Large civil UAS operations in the NAS** are presently considered those UAS weighing 55 pounds or more with or without aircraft airworthiness certification, along with their control stations and radio links operating under 14 CFR Part 91. Examples of current large UAS civil operators include agricultural spraying and operation as radio/telephone airborne relays. Future large UAS operations will include carriage of cargo and passengers, and long–endurance aircraft, staying aloft for extended periods of time.

**NOTE–**

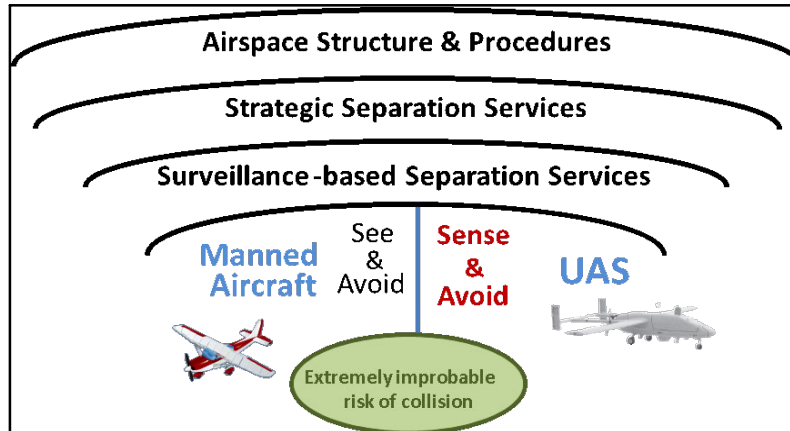
*Large is only used as a term to differentiate from those UAS weighing less than 55 pounds. Large UAS is not an FAA–recognized category of aircraft.*

**3.1.1 Large UAS** must meet performance, equipage requirements, and adhere to relevant procedures commensurate with the airspace in which the UAS is operating.

**3.1.2 Absent an onboard pilot,** large UAS are unable to “see and avoid” other aircraft, as required by regulations governing the general operation of aircraft in the NAS under Title 14 CFR Section 91.111, Operating Near other Aircraft, and 14 CFR Section 91.113, Right of Way Rules: Except Water Operations. As a result, they cannot use on board visual observation to remain “well clear” of other aircraft and avoid collisions. Therefore, an alternate means of compliance is required to remain well clear of other aircraft, surface obstacles, and avoid collisions.

**3.1.3 FIG ENR 8.3–3, A Layered Approach for Collision Avoidance,** illustrates the different layers used to keep aircraft safely separated, beginning with airspace classification and design, then ending with the responsibility of the pilot to prevent collisions.

FIG ENR 8.3-3  
A Layered Approach for Collision Avoidance



**3.2** Transition to Full Integration into the NAS. Over time, full integration of large UAS operations in the NAS will be achieved. Current large UAS operations will continue to be dependent on COAs, the issuance of NOTAMs, and possibly other measures (e.g., chase plane, segregated airspace) as currently used for accommodated operations. This integration is evolving with UAS technology advances, FAA regulatory changes, NAS automation, communications improvements, and evolving use cases and demand.

**NOTE-**

*Transponder equipped UAS, during lost link events, if capable, will squawk secondary surveillance radar (SSR)/Transponder code 7400. If the UAS is not programmed for use of SSR code 7400, then code 7600 may be used.*

**3.3** Large Civil Operations. The following are examples of test and evaluation operations being conducted with large civil and commercial UAS: cargo delivery, infrastructure inspection, surveillance, firefighting, environmental observation, signal relay, and atmospheric sampling.

## ENR 8.4 Airspace Access for UAS

### 1. Recreational Flyers

**1.1** Advisory Circular 91-57, Exception for Limited Recreational Operations of Unmanned Aircraft, provides guidance for recreational flyers. Failure of a recreational flyer to adhere to any of the requirements for recreational status under 14 USC 44809 will result in the flight being considered 14 CFR Part 107 by the FAA, which may result in greater penalties if the operator is found operating in an unsafe manner. Recreational flyers may only operate under the statutory exception if they adhere to all of the conditions listed in the statute.

**REFERENCE-**

*AC 91-57, Exception for Limited Recreational Operations of Unmanned Aircraft.*  
*49 USC 44809, Exception for Limited Recreational Operations of Unmanned Aircraft.*  
*14 CFR Part 107, Small Unmanned Aircraft Systems.*

**1.2** Operations in Class G airspace. Flights in Class G airspace will be the most common environment for many recreational flyers. The upper limit of recreational UAS operations in Class G airspace is 400 feet AGL. When operating in Class G airspace, the recreational flyer must follow the set of safety guidelines outlined and developed by a recognized Community Based Organization (CBO).

**1.3** Operations in controlled airspace or uncontrolled airspace above 400 feet AGL. If a recreational flyer desires to operate in class B, C, or D airspace, or within the lateral boundaries of the surface area of class E airspace designated for an airport, or in class G airspace above 400 feet, the operator must obtain prior authorization from the Administrator or designee before operating. For the recreational flyer wishing to enter controlled airspace, there are two basic routes:

**1.3.1** Fixed sites are flying sites specifically authorized by the FAA, and are posted at the FAA's interactive map on the UAS Data Delivery System (UDDS). On the map, small blue circles depict the location of these sites in controlled airspace, and the altitude limits imposed on those sites. The altitude restrictions are derived from the UASFM which form the basic structure of LAANC and its operating procedures. Recreational flyers can access site-specific information by clicking on the blue circle.

**NOTE-**

*These sites have existing letters of agreement or authorization (LOA) with the FAA. For the CBO to operate in controlled airspace, an airspace authorization agreement between the CBO and the FAA must be in place. Certain sites may have access restrictions or other operating limitations, which are available from the site sponsor.*

**1.3.2** By request, through the LAANC Application. LAANC provides the recreational pilot with access, when permissible, to controlled airspace at or below posted UASFM altitudes in near-real time. LAANC also gives the recreational flyer the ability to stay notified of airspace restrictions and prohibitions. See ENR 8.8, paragraph 7., of this chapter for information on downloading the LAANC application.

**1.4** CBO Sanctioned Events. Sanctioned events, also called sponsored events are generally of short duration and take place at an existing fixed site or temporary fixed site established specifically for the event.

**1.4.1** CBO's requesting a sanctioned or sponsored event authorization within Class B, C, D, or within the lateral boundaries of the surface area of Class E airspace designated for an airport are obligated to make the location known to the FAA Administrator. Mutually agreed-upon operating procedures must be established with the event organizer. This is accomplished through a fixed site application in DroneZone.

**1.4.2** CBO operations and events occurring at 400 feet AGL and below in Class G airspace do not require FAA review, approval or authorization. CBO's intending to conduct events in Class G airspace that may exceed 400 feet AGL must contact the FAA for further information.

### 2. 14 CFR Part 107 and Waivers to 14 CFR Part 107

**2.1** 14 CFR Part 107 was the first rule dedicated to UAS operations. It was designed to provide a path for integration into the NAS for sUAS, flown under VLOS, and operated for non-recreational purposes. Part 107

allows remote pilots to fly for recreation. Part 107 grants certain flight permissions and altitudes in excess of those provided under 49 USC 44809, The Exception for Limited Recreational Operations of UAS, in view of the greater vetting required for 14 CFR Part 107 certification. Eligibility requirements to fly under 14 CFR Part 107, are listed in 14 CFR Section 107.61, Eligibility.

**NOTE-**

*The Administrator may issue a certificate of waiver authorizing a deviation from 14 CFR Section 107.31, Visual Line of Sight Aircraft Operation, if the operation can safely be conducted under the terms of a certificate of waiver.*

**REFERENCE-**

14 CFR Part 107, sUAS.  
14 CFR Section 107.61, Eligibility.  
14 CFR Section 107.31, Visual Line of Sight Aircraft Operation.

**2.2 Operations in class G airspace.** Part 107 remote pilots may fly in class G airspace up to 400 feet AGL, and within 400 feet of a structure without prior coordination with ATC. Other limitations for Part 107 operators are described in 14 CFR Section 107.51, Operating Limitations for sUAS.

**REFERENCE-**

14 CFR Section 107.51, Operating Imitations for Small Unmanned Aircraft.

**2.3 Operations in controlled airspace through LAANC.** LAANC gives the remote pilot the ability to obtain near real-time airspace authorization within UASFM altitudes and stay notified of airspace restrictions and prohibitions. See ENR 8.8, paragraph 7., Resources for UAS Operators, for information on downloading LAANC.

**2.4 Waivers to 14 CFR Part 107:**

**2.4.1** A waiver is an official document issued by the FAA which approves certain operations of UAS outside the limitations of a regulation. These waivers allow UAS pilots to deviate from certain rules under 14 CFR Part 107 by demonstrating they can still fly safely using alternative methods or safety mitigations. 14 CFR Part 107 rules which can be waived are listed in 14 CFR Section 107.205, List of Regulations Subject to Waiver. Any subpart of 14 CFR Part 107 rule which is not specifically listed in 14 CFR Section 107.205, such as the §107.36 prohibition on the carriage or transport of HAZMAT, is not subject to waiver, and would require an exemption under 14 CFR Part 11, General Rulemaking Procedures. See ENR 8.3, paragraph 2, Exemptions Under 49 USC 44807: Special Authority for Certain Unmanned Systems, for guidance on requesting exemptions.

**2.4.2** To request a 14 CFR Part 107 waiver, refer to the FAA's Part 107 Waiver website.

**NOTE-**

*The FAA's Part 107 wavier website may be viewed at: [https://www.faa.gov/uas/commercial\\_operators/part\\_107\\_waivers/](https://www.faa.gov/uas/commercial_operators/part_107_waivers/).*

**REFERENCE-**

14 CFR Section 107.205, List of Regulations Subject to Waiver.  
14 CFR 11, General Rulemaking Procedures.

### **3. Airspace Access for Public Aircraft Operations (PAOs)**

**3.1 General requirements for PAO status.** Governmental entities, as defined by federal law 49 USC 40102(a)(41), Definitions, can fly as a public aircraft operation as long as the flight meets the definition of a governmental function 49 USC 40125, Qualifications for Public Aircraft Status. Public aircraft are an aircraft owned and operated by the government of a state, the District of Columbia, or a territory or possession of the United States, or a political subdivision of one of these governments, except as provided in 49 USC 40125(b), Qualifications for Public Aircraft Status. Public aircraft can also be aircraft exclusively leased for at least 90 continuous days by the government of a state, the District of Columbia, or a territory or possession of the United States or a political subdivision of one of these governments, except as provided in 49 USC 40125(b), Qualifications for Public Aircraft Status.

**NOTE-**

**1.** *The term "government function" refers to one of several activities undertaken by a government, such as national defense, intelligence missions, firefighting, search and rescue, law enforcement (including transportation of prisoners, detainees, and illegal aliens), aeronautical research, or biological or geopolitical resource management*



2. An operation “for the public good” does not necessarily meet the criteria for a public operation. For example, most volunteer fire departments in the United States will not qualify as PAOs.

3. Public safety organizations often conduct operations under 14 CFR Part 107, as well as public aircraft operations.

**REFERENCE–**

49 USC 40102, Definitions.

49 USC 40125, Qualifications for Public Aircraft Status.

**3.2** A PAO is conducted under certain 14 CFR Part 91, UAS Operations Rules, with a COA granted to allow access to the NAS. A PAO COA allows blanket UAS operations in Class G airspace throughout the entire continental United States, including operations at night with appropriate lighting and training, for the duration of the COA. Waivers and/or authorizations to the COA can permit operations beyond the basic COA. Operating as a PAO requires adherence to specific conditions as directed in the COA. Operations under the public aircraft statute cannot include purposes that are not governmental functions. For example, a police UAS flying without remuneration to obtain footage for a department promotional video would not be a governmental function.

**3.3** COA Application Process:

**3.3.1** Public Declaration Letter (PDL). The first step in getting a PAO COA is to be recognized as an authorized government agency by submitting a PDL that shows the organization is indeed a governmental entity as defined by federal law. FAA general counsel reviews this letter, which is usually issued by a city, county or state attorney. Federal agencies are deemed to be governmental entities without submitting a PDL.

**3.3.2** COA Request. If formally recognized as a governmental entity under federal law, entities are given access to the COA Application Process System (CAPS) or DroneZone, where a request for a PAO COA may be submitted. Operating as a PAO requires you to adhere to specific conditions as directed in your COA. Remember that an aircraft described in subparagraph (a), (b), (c), or (d) of 49 USC 40102(a)(41), Definitions, does not qualify as a public aircraft under such section when the aircraft is used for commercial purposes (e.g., performing a non–governmental function).

**REFERENCE–**

AC 00–1.1, Public Aircraft Operations—Manned and Unmanned.

49 USC 40102, Definitions.

**4. 14 CFR Part 89 Remote Identification and FAA–Recognized Identification Areas (FRIAs)**

**4.1** Background:

**4.1.1** Remote identification (RID) of UAS is crucial to UAS integration.

**4.1.2** RID is the ability of a UAS in flight to provide identification and location information that can be received by other parties.

**4.1.3** RID allows the FAA, national security agencies, law enforcement, and others to distinguish compliant airspace users from those potentially posing a safety or security risk. It helps these agencies find the control station when a UAS appears to be flying unsafely or where it is prohibited.

**4.2** Remote ID Rule:

**4.2.1** 14 CFR Part 89, Remote Identification (RID) of Unmanned Aircraft, will require most UAS operating in U.S. airspace to have RID capability. UAS not equipped with RID capability will be limited to operating in specific FAA–approved geographic locations, such as FRIA.

**REFERENCE–**

14 CFR Part 89, Remote Identification of Unmanned Aircraft.

**4.2.2** There are three ways UAS pilots will be able to meet the identification requirements of the RID rule: Standard RID, RID Broadcast Module, and FRIAs.

**4.2.2.1** Standard RID. Only standard RID UAS may be manufactured after the September 16, 2022, rule effective date. Unmanned aircraft broadcast the RID message elements directly from the unmanned aircraft from takeoff to shut down. Message elements include: (1) A unique identifier to establish the identity of the unmanned

aircraft; (2) an indication of the unmanned aircraft latitude, longitude, geometric altitude, and velocity; (3) an indication of the control station latitude, longitude, and geometric altitude; (4) a time mark; and (5) an emergency status indication. Operators may choose whether to use the serial number of the unmanned aircraft or a session ID (e.g., an alternative form of identification that provides additional privacy to the operator) as the unique identifier.

**4.2.2.2 RID Broadcast Modules.** A UAS can be equipped with a RID broadcast module that broadcasts message elements from takeoff to shutdown. Message elements include: (1) The serial number of the broadcast module assigned by the producer; (2) an indication of the latitude, longitude, geometric altitude, and velocity of the unmanned aircraft; (3) an indication of the latitude, longitude, and geometric altitude of the unmanned aircraft takeoff location; and (4) a time mark.

**4.2.2.3 FAA-Recognized Identification Area:**

a) An FAA-Recognized Identification Area (FRIA) is a defined geographic area where persons can operate UAS without remote identification, provided they maintain visual line of sight. Organizations eligible to request establishment of a FRIA include CBOs recognized by the FAA and educational institutions. The latter group includes primary and secondary educational institutions, trade schools, colleges, and universities.

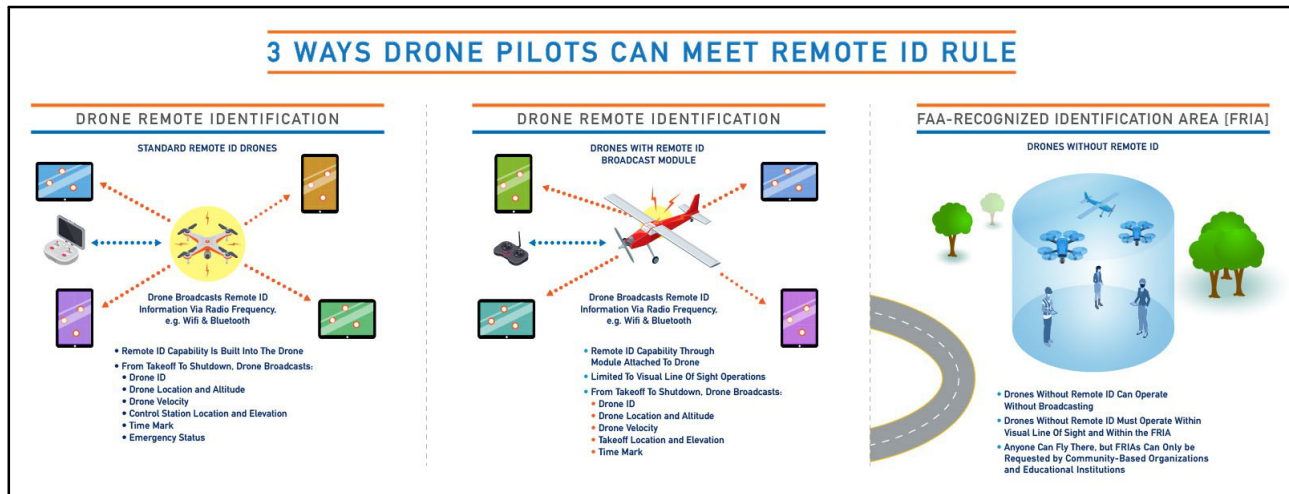
b) To operate in a FRIA according to the 14 CFR Part 89, RID of unmanned aircraft, operators must be physically located within the boundaries of the FRIA, must only operate drones within those boundaries, and must operate within visual line of site (VLOS) at all times. UAS equipped with RID broadcast capability must broadcast continuously even while operating within or transiting a FRIA.

**REFERENCE-**

14 CFR Part 89, Remote Identification of Unmanned Aircraft.

c) FIG ENR 8.4-1 illustrates the three ways UAS operators can comply with the new RID Rule.

FIG ENR 8.4-1  
RID Paths to Compliance



**5. Airspace Access for 14 CFR Part 135 and 14 CFR Part 137**

**5.1 14 CFR Part 135, Operating Requirements: Commuter and on Demand Operations and Rules Governing Persons on Board Such Aircraft:**

**5.1.1** Civil operators of UAS may conduct commercial package delivery BVLOS, or may transport HAZMAT on an interstate basis (crossing state boundaries), only under 14 CFR Part 135. These types of operations are prohibited for UAS operating under 14 CFR Part 107, sUAS. Legally, these operations must be conducted under 14 CFR Part 91, UAS operations, in accordance with an air carrier certificate issued under 14 CFR Part 135, and an exemption from certain federal aviation regulations granted under 14 CFR Part 11, general rulemaking procedures.

**REFERENCE–**

14 CFR Part 135, *Operating Requirements: Commuter and on Demand Operations and Rules Governing Persons on Board Such Aircraft*.  
14 CFR Part 107, *Small Unmanned Aircraft Systems*.  
14 CFR Part 11, *General Rulemaking Procedures*.  
FAA Order JO 7210.3, Chapter 5, Section 5, 14 CFR Part 91, *UAS Operations*.

**5.1.2** Generally, UAS cannot comply with certain 14 CFR regulations originally written for a manned aircraft environment and therefore require relief. UAS operators obtain relief from the requirements of these regulations through exemptions, waivers, and deviations. The relief document lists conditions and limitations that provide a level of safety at least equal to the rule from which relief is needed. Additionally, UAS operators must obtain a Certificate of Waiver or Authorization (COA) from the FAA Air Traffic Organization (ATO). Applicants for 14 CFR Part 135 certification should begin the process by contacting their local FAA Flight Standards District Office (FSDO).

**NOTE–**

*Examples of such regulations include requirements for the provision of seat belts for aircrew and passengers, on-board carriage of an aircraft manual, etc.*

**5.1.2.1** Application for a 14 CFR Part 135 certificate. Application for a 14 CFR Part 135 air carrier certificate for UAS operations uses the same process as that for manned 14 CFR Part 135 applicants. For information on how to apply for an air carrier certificate issued under 14 CFR Part 135, see the FAA 14 CFR Part 135 Air Carrier and Operator Certification website.

**NOTE–**

*The FAA 14 CFR Part 135 Air Carrier and Operator Certification website may be reviewed at: [https://www.faa.gov/licenses\\_certificates/airline\\_certification/135\\_certification/](https://www.faa.gov/licenses_certificates/airline_certification/135_certification/).*

**5.1.2.2** Advisory Circular 120–49A, Parts 121 and 135 Certification, is available to aid an applicant in Part 135 certification.

**REFERENCE–**

*AC 120–49, Parts 121 and 135 Certification.*

**5.1.2.3** Exemptions and COAs. Additional information on how to petition for an exemption and obtain a COA is available on the FAA Advanced Operations website.

**NOTE–**

*The FAA's Advanced Operations website may be reviewed at: [https://www.faa.gov/uas/advanced\\_operations/](https://www.faa.gov/uas/advanced_operations/).*

**5.2** 14 CFR Part 137, Agricultural Aircraft Operations:

**5.2.1** Civil and public operators of UAS may conduct agricultural aircraft operations as defined in 14 CFR Part 137.3, Definition of Terms. These operations must be conducted in accordance with an agricultural aircraft operator certificate issued under 14 CFR Part 137, and an exemption from certain federal aviation regulations granted under 14 CFR Part 11, General Rulemaking Procedures. Operators of sUAS weighing less than 55 pounds MGOW may conduct agricultural aircraft operations under 14 CFR Part 107, sUAS, and 14 CFR Part 137. Operators of large UAS weighing 55 pounds or more MGOW may conduct agricultural aircraft operations under 14 CFR Parts 91, UAS operations, and 14 CFR Part 137.

**REFERENCE–**

14 CFR Part 137, *Agricultural Aircraft Operations*.  
14 CFR Part 11, *General Rulemaking Procedures*.  
14 CFR Part 107, *Small Unmanned Aircraft Systems*.  
FAA Order JO 7210.3, Chapter 5, Section 5, 14 CFR Part 91, *UAS Operations*.

**5.2.2** Generally, as is the case with 14 CFR Part 135 standard cargo operations, UAS cannot comply with certain 14 CFR regulations, and therefore require relief. For example, sUAS require relief from carriage of hazardous material (§107.36), aircraft certification (§137.19(d)), carriage of agricultural aircraft operator certificate (§137.33(a)), and, for large UAS, certain aircraft airworthiness requirements (14 CFR Parts 21 and 91). UAS operators obtain relief from the requirements of these regulations through an exemption. The exemption lists conditions and limitations which provide a level of safety at least equal to that provided by the rule. Additionally, large UAS operators must obtain a COA from the FAA ATO.

**5.2.2.1** Obtaining an exemption for 14 CFR Part 137 operations. For additional information on how to petition for an exemption and obtain a COA, go to the FAA's Advanced Operations website.

**NOTE–**

The FAA's Advanced Operations website may be viewed at: [https://www.faa.gov/uas/advanced\\_operations/](https://www.faa.gov/uas/advanced_operations/).

**5.2.2.2** Advisory Circular 137–1, Certification Process for Agricultural Aircraft Operators, provides additional information on how to apply for an agricultural aircraft operator certificate issued under 14 CFR Part 137.

**REFERENCE–**

AC 137.1, Certification Process for Agricultural Aircraft Operation.

**5.3 Hazardous Materials (HAZMAT):**

**5.3.1** A hazardous material (also known as HAZMAT) or dangerous goods, is any substance or material that is capable of posing an unreasonable risk to health, safety, and property when transported in commerce. See definition of HAZMAT in the Pilot/Controller Glossary. For example, lithium batteries, dry ice, and aerosol whipped cream are considered dangerous goods. These products may seem harmless, however, when transported by air they can be very dangerous. Vibrations, static electricity, temperature and pressure variations can cause items to leak, generate toxic fumes, start a fire, or even explode if these products are not packaged and handled properly. More detailed information is located on the FAA's What are Dangerous Goods website.

**NOTE–**

The FAA's What are Dangerous Goods website may be viewed at: [https://www.faa.gov/hazmat/what\\_is\\_hazmat/](https://www.faa.gov/hazmat/what_is_hazmat/).

**5.3.2** The carriage/transportation of hazardous materials under 14 CFR Part 107, sUAS, is strictly prohibited at all times, and is not subject to waiver. In order to transport hazardous materials, UAS operators must follow the 14 CFR Part 135 certification regulatory path and must develop dangerous goods training programs and manuals as part of the 14 CFR Part 135 Air Carrier and Operator Certificates process, described on the FAA website and ENR 8.4, subparagraph 5.1, 14 CFR Part 135, Operating Requirements. A brief description of applicable regulations as they apply to UAS is found on the FAA's UAS website.

**NOTE–**

The FAA's Unmanned Aircraft System (UAS) website may be viewed at: [https://www.faa.gov/hazmat/air\\_carriers/operations/drones/](https://www.faa.gov/hazmat/air_carriers/operations/drones/).

**REFERENCE–**

14 CFR Part 107, Small Unmanned Aircraft Systems.

14 CFR Part 135, Operating Requirements: Commuter and on Demand Operations and Rules Governing Persons on Board Such Aircraft.

## **6. Airspace Restrictions to Flight**

**6.1** General. The NAS extends from the ground to above 60,000 feet MSL and includes various classifications of airspace, both uncontrolled and controlled. sUAS remote pilots and recreational flyers are generally permitted access to uncontrolled airspace without special permission. All access to controlled airspace whether by manned or unmanned aircraft must be granted by ATC.

**NOTE–**

1. While the NAS is divided into controlled and uncontrolled airspace, users must remember that all airspace is regulated, and certain rules apply throughout the NAS.

2. Recreational flyers are limited to 400 feet AGL in Class G airspace.

**6.2** Controlled Airspace is a generic term that covers the different classification of airspace (Class A, Class B, Class C, Class D, and Class E airspace) and defined dimensions within which air traffic control services can be provided to Instrument Flight Rules (IFR) flights and to Visual Flight Rules (VFR) flights, in accordance with the airspace classification.

**6.3** Special Use Airspace (SUA). SUA consists of that airspace where flight activities must be confined because of their nature, or where limitations are imposed upon aircraft operations that are not a part of those activities, or both. These areas are generally depicted on aeronautical charts and will be indicated on the B4UFLy and LAANC applications for UAS.

**6.4** Temporary Flight Restrictions:

**6.4.1** Temporary Flight Restrictions (TFRs) are non–permanent airspace restrictions created to protect persons and property in the air or on the surface from an existing or imminent hazard associated with an incident on the

surface, when the presence of low flying aircraft would magnify, alter, spread, or compound that hazard (14 CFR Section 91.137(a)(1)). TFRs can exist to protect aircraft from hazards, and also to protect people/objects on the ground from aircraft hazards. Examples of TFRs include natural disaster areas especially forest fires and floods, congested flight areas, the area around spacecraft launches and recoveries, certain stadium sporting events, and the security of national public figures.

**6.4.2** UAS operators should be aware that substantial fines and penalties can be levied on UAS remote pilots or recreational flyers violating a TFR.

### **6.5** Special Restrictions over Critical Infrastructure:

**6.5.1** Operating a UAS over our nation’s critical infrastructure such as power grids, nuclear reactors, transportation centers, political or military sites, etc., can potentially create risk to people on the ground and also to fixed site facilities and associated infrastructure. To address security concerns, Public Law 114–190 and 115–254 mandated a process that would allow applicants to petition the FAA for restrictions from unmanned aircraft overflying their property.

**6.5.2** Special Security Instructions under 14 CFR Part 99.7 of the public laws allow the FAA to prohibit the operation of aircraft in certain airspace, in the interest of national security. The 14 CFR Part 99.7 interim solution prohibits UAS over approved fixed site facilities and limits the fixed site facilities to Federal owned sites UAS operations may be approved under the SGI process.

**6.5.3** UAS remote pilots and recreational flyers must carefully consider the need to fly over critical infrastructure and determine the legality of doing so, infractions may result in significant fines and legal actions.

#### **NOTE–**

*For a list of critical infrastructure sites, see <https://www.cisa.gov/critical-infrastructure-sectors>.*

#### **REFERENCE–**

*Public Law 114–190, FAA Extension, Safety, and Security Act of 2016*

*Public Law 115–254, FAA Reauthorization Act of 2018.*

*14 CFR Section 99.7, Special Security Instructions.*

**6.6** Special Flight Rules Area (SFRAs). SFRAs are airspaces of defined dimensions, above land areas or territorial waters, wherein the flight of aircraft is subject to special rules, as established after the September 11, 2001 attacks. Examples include the Washington, DC, Los Angeles, and Hudson River SFRAs. All aircraft are highly regulated within SFRAs. The inner area of some SFRAs, the Flight Restricted Zone (FRZ) is very highly restricted and prohibits all but previously vetted aircrew and aircraft from entering. Refer to VFR Sectional Charts or the FAA’s Restricted Airspace website for information on specific airspace limitations and instructions for requesting entry.

#### **NOTE–**

*The FAA’s Restricted Airspace website may be viewed at: <https://www.faa.gov/newsroom/restricted-airspace-0>.*

**6.7** There can be certain local restrictions to airspaces. While the FAA is designated by federal law to be the regulator of the NAS, some state and local authorities may also restrict access to local airspace. UAS pilots should be aware of these local rules.

### **6.8** Other Restrictions & Provisions:

**6.8.1** Flight over or near natural habitat or nature preserves. See ENR 8.8, paragraph 6., Environmental Best Practices, for a discussion of UAS flight restrictions over or near wildlife.

**6.8.2** No Drone Zones is an FAA concept and outreach to promote safe and responsible use of UAS. The effort assists landowners (private and public) with designating their land off-limits for UAS take-offs and landings. The idea behind the outreach is to allow landowners who wish to avoid interactions on their property with UAS to state this preference in advance of UAS take-offs or landings. No Drone Zones do not apply to airspace. Generally speaking, for a No Drone Zone in a public place to be legally enforceable, there must exist underlying authority (ordinance, law, etc.). If the property in question is privately owned, the landowner’s right to designate no UAS use is enforceable through trespass law.

**6.8.3** Flight over or near people and manned aircraft. In general, UAS remote pilots and recreational flyers should avoid flying over or near people or manned aircraft operations, and in any manner that could be construed as reckless or dangerous. See ENR 8.8, paragraph 3., Precautions: Flight Over or Near People, Manned Aircraft, and Night Operations, for specific information on flight over or near people.

**6.8.4** Correctional Institutions. Flight over some federal prisons is restricted under 14 CFR Section 99.7, Special Security Instructions. Flight near other correctional institutions may be prohibited by other federal, state or local statutes. ENR 8.4, subparagraph 6.5, Special Restrictions over Critical Infrastructure, contains additional information regarding restrictions over critical infrastructure.

**REFERENCE–**

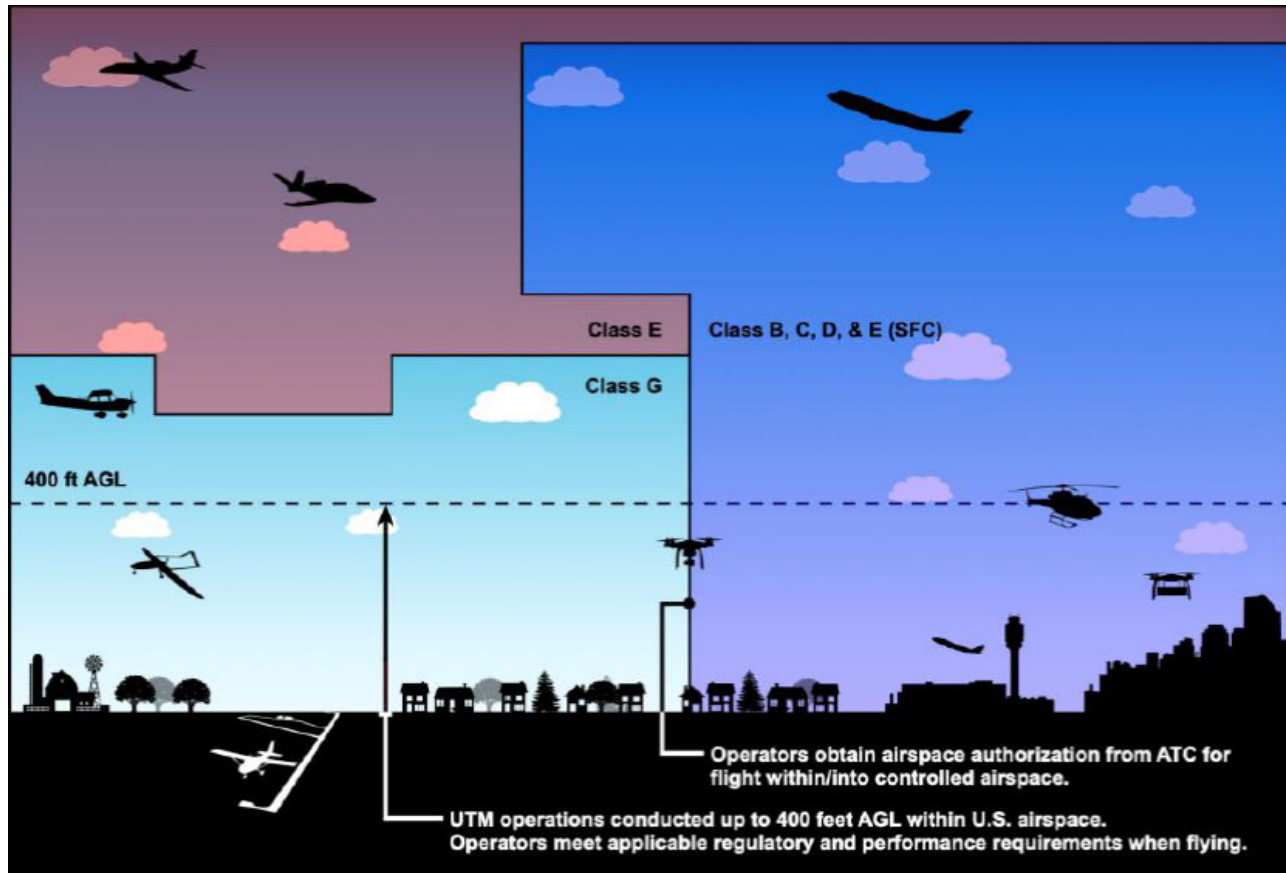
*14 CFR Section 99.7, Special Security Instructions.*

## **7. UAS Traffic Management (UTM)**

**7.1** UTM Operations. UTM is predicated on layers of information sharing and data exchange amongst a range of stakeholders including UAS operators, service providers, and the FAA to achieve safe operations. Operators share their flight intent with each other and coordinate to de–conflict and safely separate trajectories. The primary means of communication and coordination between operators, the FAA, and other stakeholders is through a distributed information network, rather than between pilots and air traffic controllers via traditional voice communications. The FAA makes real–time airspace constraints available to UAS operators, who are responsible for managing their own operations safely within these constraints without receiving ATC services from the FAA. However, the FAA does have access to applicable UTM operational information as necessary.

**7.2** UAS operators not receiving ATC separation services are required to participate in UTM at some level using applicable services to meet the performance requirements of their operations. See FIG ENR 8.4–2 for UTM in the context of Air Traffic Management operations. The number and type of services required varies based on the type and location of the intended operation and the associated communication, navigation, surveillance (CNS), and other operational needs.

FIG ENR 8.4-2  
UTM Operations in Context of Airspace Classes



### 7.3 Stakeholders in UTM:

**7.3.1** FAA, the federal authority over aircraft operations in all airspace, and the regulator and oversight authority for civil aircraft operations in the NAS.

**7.3.2** Operator, the person or entity responsible for the overall management of their operation. The operator meets regulatory responsibilities, plans flight/operations, shares operation intent information, and safely conducts operations using all available information.

**7.3.3** Remote pilot-in-command (RPIC), the person responsible for the safe conduct of each UAS flight. An individual may serve as both the operator and the RPIC.

**7.3.4** Other stakeholders (e.g., public safety and general public), can access information and/or utilize UTM services via the USS Network.





## ENR 8.5 UAS Pilot Testing, Certification and Responsibilities

### 1. UAS Pilot Certification and Requirements for Part 107 Pilots and Recreational Flyers

#### 1.1 General:

**1.1.1** Part 107 Operations. Any person who operates a civil sUAS in the NAS, for any operation that is not for recreational/pleasure purposes, must have a UAS pilot's certificate (also called the "Part 107 Certificate") with a Small Unmanned Aircraft System Rating.

**1.1.2** Recreational Flyer Operations. A person who is flying a sUAS for recreational/pleasure purposes in the NAS must have taken and passed TRUST, as required by 14 USC 44809.

#### 1.2 Eligibility for Testing:

**1.2.1** Part 107 operations. Applicants must be at least 16 years of age and be able to speak and understand English. For further information on Part 107 testing see the FAA's website, Become a Drone Pilot.

#### **NOTE-**

*The FAA's Become a Drone Pilot website may be viewed at:  
[https://www.faa.gov/uas/commercial\\_operators/become\\_a\\_drone\\_pilot/](https://www.faa.gov/uas/commercial_operators/become_a_drone_pilot/).*

**1.2.2** Recreational Flyer Operations. There are no minimum age or other eligibility requirements for a recreational UAS pilot to take TRUST.

#### 1.3 Initial Testing for Certification:

##### 1.3.1 Part 107 Operations:

**1.3.1.1** Current 14 CFR Part 61 Certificate Holder (Online Training). A person who holds a Part 61 manned pilot certificate (other than a student pilot certificate), and who has a current flight review, as per 14 CFR Section 61.56, may complete online training that is offered by the FAA to obtain their 14 CFR Part 107, in lieu of taking the Initial Knowledge Test. However, a Part 61 certificate holder may also take the sUAS Initial Aeronautical Knowledge Test for certification.

**1.3.1.2** Non 14 CFR Part 61 certificate holder, or 14 CFR Part 61 certificate holder lacking currency (Initial Aeronautical Knowledge Test). A person who does not hold a 14 CFR Part 61 manned pilot certificate and/or they do not have a current flight review must take the Initial Aeronautical Knowledge Test at an FAA designated Knowledge Testing Center to obtain their sUAS Certificate.

**1.3.2** Recreational Flyer Operations. Any person who flies a UA for recreational use under 49 USC 44809 must take and pass TRUST. See the FAA website, The Recreational UAS Safety Test (TRUST).

#### **NOTE-**

*A current 14 CFR Part 107 sUAS certificate holder may fly recreationally under that part, but must adhere entirely to 14 CFR Part 107 rules and requirements. If a Part 107 sUAS certificate holder wishes to fly under 49 USC 44809, they must take and pass TRUST.*

#### **NOTE-**

*The FAA's website, The Recreational UAS Safety Test (TRUST), may be viewed at:  
[https://www.faa.gov/uas/recreational\\_flyers/knowledge\\_test\\_updates](https://www.faa.gov/uas/recreational_flyers/knowledge_test_updates).*

#### 1.4 Recurrent Training (Testing) Requirements:

##### 1.4.1 Part 107 operations:

**1.4.1.1** To exercise the privileges of a sUAS certificate that was issued under 14 CFR Part 107, a person must maintain currency. Therefore, the FAA requires that a person take a recurrent course within 24 months from the month the Initial Aeronautical Knowledge Test was passed, or the online training was completed.

**1.4.1.2** Recurrent training (online training) is found at the FAA's Become a Drone Pilot website.

**NOTE-**

The FAA's Become a Drone Pilot website may be viewed at:

[https://www.faa.gov/uas/commercial\\_operators/become\\_a\\_drone\\_pilot/](https://www.faa.gov/uas/commercial_operators/become_a_drone_pilot/).

**1.4.2** Recreational Operations. TRUST is taken on a once-and-done basis; no recurrent testing is required.

**1.5** Pre-Test Training Requirements:

**1.5.1** Part 107 Operations:

**1.5.1.1** No documented pre-test training is required under Part 107 to take the Initial Aeronautical Knowledge Test. However, the FAA Remote Pilot Small Unmanned Aircraft Systems Study Guide is an excellent resource.

**NOTE-**

To view the FAA Remote Pilot – Small Unmanned Aircraft Systems Study Guide see:

[https://www.faa.gov/regulations\\_policies/handbooks\\_manuals/aviation/media/remote\\_pilot\\_study\\_guide.pdf](https://www.faa.gov/regulations_policies/handbooks_manuals/aviation/media/remote_pilot_study_guide.pdf).

**1.5.1.2** Initial Aeronautical Knowledge Test subject areas. The testing topics for the sUAS Knowledge Test can be found in 14 CFR Section 107.73, Knowledge and Training.

**REFERENCE-**

14 CFR Section 107.73, Knowledge and Training.

**1.5.1.3** Part 107 online training. This online training may be used by those who hold a 14 CFR Part 61 pilot certificate (not including a student pilot certificate) seeking 14 CFR Part 107 remote pilot certification. A person who holds a 14 CFR Part 61 pilot certificate must also show, at the time of certification, a current Flight Review as per 14 CFR Section 61.56.

**1.5.2** Recreational Flyer Operations. No pre-test training is necessary to complete TRUST.

**1.6** Endorsements and re-testing. Neither the Part 107 Initial Aeronautical Knowledge Test nor the Recreational TRUST have any requirements for flight instructor endorsements prior to testing. A person who fails the Initial Aeronautical Knowledge Test must wait 14 calendar days before they may retake the test. TRUST may be retaken at any time.

**1.7** Registering to Take the Part 107 sUAS Initial Aeronautical Knowledge Test:

**1.7.1** Before a person can take the sUAS Initial Aeronautical Knowledge Test at an FAA-recognized testing center, that person must obtain an FAA Tracking Number (FTN). To obtain an FTN a person must create an account in the Integrated Airman Certification and Rating Application (IACRA) system. For detailed instructions on how to obtain an FTN, see the FAA's, Airman Certificate Testing Service (ACTS) Contract Briefing.

**NOTE-**

Any person who has any FAA Airman Certificate will already have an FTN.

**NOTE-**

The FAA's Airman Certificate Testing Service (ACTS) Contract Briefing, may be viewed at:

<https://www.youtube.com/watch?v=ETLsH8BruBM>.

**1.7.2** Once an applicant has a FTN, they will go to the testing vendor's website and register for the test. The FAA's testing vendor is PSI Services LLC.

**NOTE-**

The PSI Services LLC website may be viewed at: <https://candidate.psiexams.com/>.

**1.8** Applying for a 14 CFR Part 107 sUAS Certificate. The FAA's Become a Drone Pilot website has instructions on how to obtain the 14 CFR Part 107 Pilot Certificate, following testing or online training completion.

**NOTE-**

The Become a Drone Pilot website may be viewed at:

[https://www.faa.gov/uas/commercial\\_operators/become\\_a\\_drone\\_pilot/](https://www.faa.gov/uas/commercial_operators/become_a_drone_pilot/).

**1.9** Night Operations and Operations over People:

**1.9.1** A person who holds a sUAS Certificate is afforded all of the privileges of the certificate. This includes the ability to operate at night and over people without a waiver, under certain conditions. See ENR 8.8, paragraph 3, Precautions: Flight Over or Near People, Manned Aircraft, and Night Operations, for further information on these operations.

**1.9.2** Any remote pilot who holds a 14 CFR Part 107 sUAS certificate issued prior to April 6, 2021, must take the updated recurrent training (online training) to operate at night or over people.

## **2. Pilot Certification and Requirements for Public Aircraft Operations (PAOs)**

**2.1** When operating as a PAO, the operator is required to train and the agency will self-certify pilots as competent to safely operate in the NAS.

**2.2** For more information and best practices on pilot certification and training within the framework of a PAO, refer to AC 00-1.1, Public Aircraft Operations—Manned and Unmanned.

### **REFERENCE-**

*AC 00-1.1, Public Aircraft Operations—Manned and Unmanned.*

## **3. Pilot Certification for 14 CFR Part 135, Part 137, and Large Civil UAS**

**3.1** Pilot certification for 14 CFR Part 135. Currently, FAA regulations require a commercial pilot certificate for 14 CFR Part 135 Remote PICs.

**3.2** Pilot certification for 14 CFR Part 137. For civil UAS agricultural aircraft operations, the 14 CFR Section 137.19(b) & (c) requirement (that the pilot hold a private or commercial pilot certificate) is exempted; only a 14 CFR Part 107 pilot certificate is required. This policy pertains to all UAS regardless of weight. However, all civil pilots conducting agricultural aircraft operations must satisfactorily pass the knowledge and skill test of 14 CFR Section 137.19(e) and 14 CFR Section 137.41(b) or (c).

**3.3** Pilot certification for other large civil UAS. Requirements for future large civil UAS operations will be addressed in future rulemaking.

## **4. Foreign Pilot Certification**

**4.1** Part 107 Operations:

**4.1.1** Foreign national holding a U.S. issued 14 CFR Part 61 certificate. Foreign nationals are eligible for a sUAS certificate in the same way that a U.S. citizen is eligible.

**4.1.2** Foreign national not holding a U.S. issued 14 CFR Part 61 certificate. A foreign national who does not hold a U.S. issued 14 CFR Part 61 certificate, must take and pass the Initial Aeronautical Knowledge Test to obtain a sUAS Pilot Certificate in order to operate in the NAS.

**4.2** Recreational Flyer Operations. A foreign national is required to have passed TRUST to fly a UAS recreationally under 49 USC 44809 in the United States.

**4.3** Security vetting. All applicants, regardless of nationality, must pass a Transportation Security Administration (TSA) Security Threat Analysis (STA) before the FAA will issue a temporary or permanent Pilot's Certificate, under Part 107.

**4.4** Bi-lateral agreements. Currently, the United States does not have any bi-lateral agreements with any other countries that would allow the issuance of a U.S. sUAS certificate that is based on a foreign UAS Pilot's Certificate.



## ENR 8.6 Advanced Air Mobility

### 1. General

**1.1** Advanced Air Mobility (AAM) is a rapidly-emerging, new sector of the aerospace industry which aims to safely and efficiently integrate highly automated aircraft into the NAS. AAM is not a single technology, but rather a collection of new and emerging technologies being applied to the aviation transportation system, particularly in new aircraft types. Notional AAM use-cases include Urban Air Mobility (UAM), Regional Air Mobility (RAM), public services, large cargo delivery, and private or recreational vehicles.

**1.2** UAM and RAM are subsets of AAM activities occurring in urban environments.



## ENR 8.7 UAS Operations on Airports

### 1. UAS Operations on Airports

**1.1** Larger public and civil UAS operate from military, civilian, and dual-use airports with set protocols and agreements with local ATC, often operate under IFR.

**1.2** sUAS operations on airports require coordination with the airport operator and respective air traffic control facility, Spectrum, the FAA Regional Airport District Office, or the State Department of Aviation, where applicable. Due to the complex nature of these operations, requests for on-airport operations within controlled airspace must be submitted via DroneZone for coordination with the air traffic control facility. On-airport operation requests are evaluated on a case-by-case basis due to the inherent risks associated with operating in close proximity to areas frequented by manned aircraft.

**NOTE-**

The FAA's DroneZone website may be viewed at: <https://faadronezone.faa.gov/#/>.





## ENR 8.8 Other Information and Best Practices

### 1. Best Practices for UAS Operations

Responsibility of the UAS pilot. Just as is the case with a manned aircraft, the UAS remote pilot or recreational flyer is responsible for the safe operation of their unmanned aircraft. The remote pilot or recreational flyer must ensure that they are physically ready to fly and knowledgeable of the flight to be performed to include operational parameters, UAS limitations, local weather, and applicable flight rules; that the UAS itself is mechanically ready.

### 2. UAS Operations and Air Traffic Control (ATC)

Coordination and/or communication of airspace authorizations between UAS pilots or operators and ATC are handled within the airspace access processes (e.g., LAANC, DroneZone, CAPS). They are not coordinated extemporaneously and verbally between the UAS operator and ATC. Any requirements for coordination and/or communication between UAS operator and ATC will be contained in individual COAs, which may include operational waivers, development of LOAs, and through other application processes which allow access to controlled airspace. Any air traffic services provided to sUAS operations shall be based upon the type of airspace authorization issued, along with the mitigations and limitations included in that authorization.

#### *NOTE—*

1. *Small UAS operators should not contact ATC directly by radio or telephone for purposes of airspace access. Also, the use of an aviation radio frequency by the RPIC of a sUAS may constitute a violation of Federal Communications Commission rules. Remote pilots of larger UAS—which are usually under positive control by ATC and flying under Instrument Flight Rules—are an exception to this guideline.*

2. *Small UAS operators are encouraged to monitor local CTAF radio traffic when operating on or near an airport, for situational awareness.*

### 3. Precautions: Flight Over or Near People, Vehicles, Manned Aircraft, and Night Operations

#### 3.1 Flight over or near people or vehicles:

3.1.1 Remote pilots and recreational flyers should carefully consider the hazards of flight operations over or near people. 14 CFR Part 107, Subpart D, operations over human beings, allows certain Operations Over People (OOP) and vehicles, based upon four different operational categories of UA weight and construction, and the likely severity of injury to people on the ground, in the case of contact. Part 107 operators may request a waiver to these restrictions.

3.1.2 Part 91 remote pilots may refer to restrictions and permissions, regarding flight over people, in their respective COAs.

3.1.3 Recreational flyers should consider the safety of other persons when flying. 49 USC 44809(a)(2), Exception for Limited Recreational Operations of Unmanned Aircraft, requires recreational flyers to operate in accordance with the safety guidelines of an accepted CBO; these guidelines will usually include safety precautions for flight near people.

3.1.4 For further information on the rules for flying over people or vehicles, see ENR 8.4, paragraph 6., Airspace Restrictions to Flight.

#### *REFERENCE—*

*14 CFR Part 107, Subpart D, Operations Over Human Beings.  
49 USC 44809(a)(2), Exception for Limited Recreational Operations of Unmanned Aircraft.*

#### 3.2 Flight in the Vicinity of Manned Aircraft:

3.2.1 The pilot of any unmanned aircraft operation retains the ultimate responsibility to avoid manned aircraft traffic. UAS operators should remember that manned aircraft may fly below 400 feet AGL; examples include

helicopters, agricultural aircraft, light civil aircraft, and military aircraft. UAS pilots must ensure they have unblocked visual access to both their UAS and the airspace around it; not seeing a manned aircraft due to blocked line of sight does not absolve the UAS pilot from responsibility for avoidance.

**NOTE-**

*Military aircraft routinely fly low and at very high speeds on low-level Military Training Routes (MTRs). MTR locations can be viewed on the VFR sectional charts. The BAUFly app will also alert the UAS pilot to the location of nearby MTRs.*

**3.2.2** Should public safety or emergency responder aircraft (e.g., police, fire suppression, helicopter emergency medical services) operations be interfered with by UAS, substantial fines can be levied on the UAS operators involved. Enforcement actions can include revocation or suspension of a pilot certificate, and up to a \$20,000 civil penalty per violation.

**3.3 Night Operations:**

**3.3.1** Night operations are permitted under 14 CFR Parts 91, 14 CFR Part 107, and Section 44809. However, requirements for meteorological visibility, and for the operator or visual observer (VO) to maintain VLOS with the UAS at all times, should be considered; see ENR 8.5, subparagraph 1.9.

**3.3.2** 14 CFR Section 107.29, Operation at Night, requirements include initial pilot training and equipment such as an anti-collision light which is visible for at least three statute miles, with a flash rate sufficient to avoid a collision.

**3.3.3** Part 91 operators civil and PAO should refer to their specific COAs for any further instructions or limitations on night flight.

**REFERENCE-**

*14 CFR Part 107.29, Operation at Night.*

**4. Accidents and Incidents: UAS Operator Responsibilities**

**4.1** Reporting responsibility. A drone crash or malfunction, irrespective of which flight rules govern the flight, may trigger a reporting requirement to either the FAA, the NTSB, or both. The NTSB reporting requirements listed in 49 CFR 830.5, immediate notification, are separate and distinct from the FAA reporting requirements. All UAS flyers operating in the NAS recreational, civil, and public are encouraged to read and follow NTSB reporting requirements should they experience a crash or malfunction that meets NTSB criteria and triggers NTSB reporting. See NTSB Reporting Requirements and ENR 8.8, subparagraph 4.2, below. A COA issued to Part 91 civil and public operators will contain specific incident/accident reporting requirements for the operator.

**4.1.1** Part 107 Operations. Part 107 operators have a reporting requirement described in 14 CFR Section 107.9, Accident Reporting. A remote pilot in command is required to report any sUAS crash that causes serious injury or loss of consciousness, or property damage other than to the UAS of over \$500. Property damage refers to any property that is not part of the UA System or attached to the UAS.

**4.1.2** Recreational Flyer Operations. Recreational flyers fully complying with the exception listed in 49 USC 44809 are not required to report crashes to the FAA. However, this does not alleviate the recreational flyer from the requirement to report the crash to the NTSB if the crash meets the NTSB reporting requirements.

**4.1.3** Part 91 Operations. Part 91 operators typically flown by public aircraft operators, civil aircraft operators, or civil operators flying FAA type certificated UAS have unique reporting requirements delineated in the terms and conditions of their certificate of waiver/authorization and must comply with those specific requirements.

**4.2** NTSB Reporting Requirements. The NTSB defines a UAS accident as an occurrence associated with the operations of any public or civil UAS that takes place between the time that the system is activated with the purpose of flight and the time that the system is deactivated at the conclusion of its mission, in which any person suffers death or serious injury, or the UAS holds an airworthiness certificate and sustains substantial damage. In the case of a midair collision involving a UAS, any midair collision must be reported.

**REFERENCE-**

*14 CFR 830.5, Immediate Notification.  
14 CFR Section 107.9, Accident Reporting.*

## 5. Emergency UAS Authorizations Through Special Government Interest (SGI) Airspace Waivers

**5.1** Background. UAS are used by public safety agencies to respond to emergencies. The SGI process is for any Part 107 or Part 91 operator that either due to time limitations, airspace restrictions or emergency situations that requires expedited authorization by contacting the system operations support center (SOSC) at 9-ATOR-HQ-SOSC@faa.gov.

**5.2** The SGI process, depending on the nature of the operation, can be completed in a matter of minutes. This process enables response to an emergency with UAS in an expeditious manner.

**5.3** Public Safety organizations may apply for expedited airspace authorizations through the SGI process. The SGI process is defined in FAA Order JO 7210.3, Facility Operation and Administration.

### REFERENCE-

FAA Order JO 7210.3, Facility Operation And Administration,

**5.4** Additional information regarding SGI authorizations can be located at the FAA's Emergency Situations webpage.

### NOTE-

The FAA's Emergency Situations website may be reviewed at:  
[https://www.faa.gov/uas/advanced\\_operations/emergency\\_situations/](https://www.faa.gov/uas/advanced_operations/emergency_situations/).

## 6. Environmental Best Practices

**6.1** Unmanned aircraft operate in a similar environment to manned aircraft. Since most UAS operations are conducted at low altitude, hazards, risks and potential environment factors may be encountered on a more frequent basis. In addition to the Bird Hazards, Flight over National Refuges, Parks, and Forests, the following factors must also be considered:

**6.1.1** Flight Near Protected Conservation Areas. UAS, if misused, can have devastating impacts on protected wildlife. UAS operators may check for conservation area airspace restrictions on the B4UFLY mobile app.

**6.1.2** Flight(s) Near Noise Sensitive Areas. Consider the following:

**6.1.2.1** UAS operations and flight paths should be planned to avoid prolonged or repetitive flight at low altitude near noise sensitive areas.

**6.1.2.2** As described in FAA Order 1050.1, Environmental Impact: Policies and Procedures, an area is "noise sensitive" if noise interferes with any normal activities associated with the area's use.

### REFERENCE-

FAA Order 1050.1, Environmental Impact: Policies and Procedures.

**6.1.2.3** To the extent consistent with FAA safety requirements, operators should observe best practices developed by the National Park Service, U.S. Fish and Wildlife Service, U.S. Forest Service, and National Oceanic and Atmospheric Administration when operating above areas administered by those agencies. The National Park Service provides additional guidance at their Unmanned Aircraft Systems website.

### NOTE-

The National Park Service, Unmanned Aircraft Systems website may be viewed at:  
<https://www.nps.gov/subjects/sound/uas.htm>.

**6.2** Some bird species have shown the potential to attack UAS that approach their nesting and hunting areas too closely. The type of birds that are most likely to attack sUAS are raptors such as hawks, eagles, and falcons. However, gulls, geese, and crows have also been known to attack UAS. Aggressive bird attacks may damage UAS propellers or other critical equipment, and may result in sudden loss of power or engine failure. Remote pilots and recreational flyers should consider reviewing engine-out procedures, especially when operating near high bird concentrations.

## 7. Resources for UAS Operators

**7.1** FAA.GOV/UAS. The FAA UAS website, [www.faa.gov/uas](http://www.faa.gov/uas), is the central point for information about FAA UAS rules, regulations, and safety best practices.

**7.2 FAA DroneZone.** The FAA DroneZone is the Agency’s portal for registering drones, requesting Part 107 airspace authorizations and waivers, registering as a CBO, requesting fixed sites, and other tasks.

**7.3 Local FAA Offices.** Flight Standards District Offices (FSDOs), can be the best in-person source for UAS information. A list of FSDOs in the United States is at [https://www.faa.gov/about/office\\_org/field\\_offices/fsdo/all\\_fsdos/](https://www.faa.gov/about/office_org/field_offices/fsdo/all_fsdos/).

**7.4 Aeronautical Information.** The FAA provides aeronautical information to NAS users, including UAS pilots, through a variety of methods including publications like this manual, other publications, Advisory Circulars (ACs), charts, website and mobile applications, etc. Check [https://www.faa.gov/air\\_traffic/flight\\_info/aeronav/](https://www.faa.gov/air_traffic/flight_info/aeronav/) for these items.

**7.5 The UAS Support Center.** For general question or comment about UAS or drones, the FAA’s Support Center is available at 844-FLY-MY-UA or [UASHelp@faa.gov](mailto:UASHelp@faa.gov).

**7.6 Clubs and Associations.** Local UAS recreational clubs, CBO organizations, and business associations are excellent resources for information and updates on flying in the local region.

**7.7 LAANC.** LAANC is the Low Altitude Authorization and Notification Capability, a collaboration between FAA and industry. It automates the application and approval process for airspace authorizations. Using applications developed by an FAA-approved UAS service supplier (USS) you can apply for an airspace authorization at over 600 airports. Download the free LAANC app at [https://www.faa.gov/uas/programs\\_partnerships/data\\_exchange/](https://www.faa.gov/uas/programs_partnerships/data_exchange/).

**7.8 B4UFLY.** The B4UFLY mobile application is a partnership between the FAA and Kittyhawk. The app helps recreational flyers know whether it is safe to fly their drone, as well as increases their situational awareness. Download the free B4UFLY app at [https://www.faa.gov/uas/recreational\\_fliers/where\\_can\\_i\\_fly/b4ufly/](https://www.faa.gov/uas/recreational_fliers/where_can_i_fly/b4ufly/).

**7.9 Weather Sources.** Aviation weather services (such as <https://www.aviationweather.gov/>) are generally targeted towards manned aviation, the FAA is currently working on UAS-specific weather applications.

**7.10 NOTAM.** The Notices to Air Missions (NOTAM) system, like aviation weather sources, remains primarily predicated on manned aviation needs. However, the system provides continual updates on all aviation activity to include UAS flight activities which have been input to the FAA, as well as airport status. The NOTAM system will be of greatest use to larger UAS activities, UAS en route operations in controlled airspace, and those flying to or from airports. NOTAM, temporary flight restrictions (TFRs), and aircraft safety alerts can be accessed at [https://www.faa.gov/pilots/safety/notams\\_tfr/](https://www.faa.gov/pilots/safety/notams_tfr/).

**AIP**  
**AERONAUTICAL INFORMATION PUBLICATION**  
**UNITED STATES OF AMERICA**

**PART 3**  
**AERODROMES (AD)**



## PART 3 – AERODROMES (AD)

### AD 0.

AD 0.1 Preface – Not applicable

AD 0.2 Record of AIP Amendments – See GEN 0.2-1

AD 0.3 Record of AIP Supplements – Not applicable

### AD 0.4 Checklist of Pages

PAGE	DATE
<b>PART 3 – AERODROMES (AD)</b>	
<b>AD 0</b>	
0.4-1	5 OCT 23
0.4-2	5 OCT 23
0.4-3	5 OCT 23
0.4-4	5 OCT 23
0.4-5	5 OCT 23
0.4-6	5 OCT 23
0.6-1	19 MAY 22
<b>AD 1</b>	
1.1-1	20 APR 23
1.1-2	20 APR 23
1.1-3	20 APR 23
1.1-4	20 APR 23
1.1-5	20 APR 23
1.1-6	20 APR 23
1.1-7	20 APR 23
1.1-8	20 APR 23
1.1-9	20 APR 23
1.1-10	20 APR 23
1.1-11	20 APR 23
1.1-12	20 APR 23
1.1-13	20 APR 23
1.1-14	20 APR 23
1.1-15	20 APR 23
1.1-16	20 APR 23
1.1-17	20 APR 23
1.1-18	20 APR 23
1.1-19	20 APR 23
1.1-20	20 APR 23
1.1-21	20 APR 23
1.1-22	20 APR 23
1.1-23	20 APR 23
1.1-24	20 APR 23
1.1-25	20 APR 23
1.1-26	20 APR 23
1.1-27	20 APR 23
1.1-28	20 APR 23

PAGE	DATE
1.1-29	20 APR 23
1.1-30	20 APR 23
1.1-31	20 APR 23
1.1-32	20 APR 23
1.1-33	20 APR 23
1.1-34	20 APR 23
1.1-35	20 APR 23
1.1-36	20 APR 23
1.1-37	20 APR 23
1.1-38	20 APR 23
1.1-39	20 APR 23
1.1-40	20 APR 23
1.1-41	20 APR 23
1.1-42	20 APR 23
1.1-43	20 APR 23
1.1-44	20 APR 23
1.1-45	20 APR 23
1.1-46	20 APR 23
1.1-47	20 APR 23
1.1-48	20 APR 23
1.1-49	20 APR 23
1.1-50	20 APR 23
1.1-51	20 APR 23
1.1-52	20 APR 23
1.1-53	20 APR 23
<b>AD 2</b>	
2-1	5 OCT 23
2-2	5 OCT 23
2-3	5 OCT 23
2-4	5 OCT 23
2-5	5 OCT 23
2-6	5 OCT 23
2-7	5 OCT 23
2-8	5 OCT 23
2-9	5 OCT 23
2-10	5 OCT 23
2-11	5 OCT 23
2-12	5 OCT 23
2-13	5 OCT 23
2-14	5 OCT 23

PAGE	DATE
2-15	5 OCT 23
2-16	5 OCT 23
2-17	5 OCT 23
2-18	5 OCT 23
2-19	5 OCT 23
2-20	5 OCT 23
2-21	5 OCT 23
2-22	5 OCT 23
2-23	5 OCT 23
2-24	5 OCT 23
2-25	5 OCT 23
2-26	5 OCT 23
2-27	5 OCT 23
2-28	5 OCT 23
2-29	5 OCT 23
2-30	5 OCT 23
2-31	5 OCT 23
2-32	5 OCT 23
2-33	5 OCT 23
2-34	5 OCT 23
2-35	5 OCT 23
2-36	5 OCT 23
2-37	5 OCT 23
2-38	5 OCT 23
2-39	5 OCT 23
2-40	5 OCT 23
2-41	5 OCT 23
2-42	5 OCT 23
2-43	5 OCT 23
2-44	5 OCT 23
2-45	5 OCT 23
2-46	5 OCT 23
2-47	5 OCT 23
2-48	5 OCT 23
2-49	5 OCT 23
2-50	5 OCT 23
2-51	5 OCT 23
2-52	5 OCT 23
2-53	5 OCT 23
2-54	5 OCT 23

PAGE	DATE
2-55	5 OCT 23
2-56	5 OCT 23
2-57	5 OCT 23
2-58	5 OCT 23
2-59	5 OCT 23
2-60	5 OCT 23
2-61	5 OCT 23
2-62	5 OCT 23
2-63	5 OCT 23
2-64	5 OCT 23
2-65	5 OCT 23
2-66	5 OCT 23
2-67	5 OCT 23
2-68	5 OCT 23
2-69	5 OCT 23
2-70	5 OCT 23
2-71	5 OCT 23
2-72	5 OCT 23
2-73	5 OCT 23
2-74	5 OCT 23
2-75	5 OCT 23
2-76	5 OCT 23
2-77	5 OCT 23
2-78	5 OCT 23
2-79	5 OCT 23
2-80	5 OCT 23
2-81	5 OCT 23
2-82	5 OCT 23
2-83	5 OCT 23
2-84	5 OCT 23
2-85	5 OCT 23
2-86	5 OCT 23
2-87	5 OCT 23
2-88	5 OCT 23
2-89	5 OCT 23
2-90	5 OCT 23
2-91	5 OCT 23
2-92	5 OCT 23
2-93	5 OCT 23
2-94	5 OCT 23
2-95	5 OCT 23
2-96	5 OCT 23
2-97	5 OCT 23
2-98	5 OCT 23
2-99	5 OCT 23
2-100	5 OCT 23
2-101	5 OCT 23
2-102	5 OCT 23
2-103	5 OCT 23
2-104	5 OCT 23
2-105	5 OCT 23
2-106	5 OCT 23

PAGE	DATE
2-107	5 OCT 23
2-108	5 OCT 23
2-109	5 OCT 23
2-110	5 OCT 23
2-111	5 OCT 23
2-112	5 OCT 23
2-113	5 OCT 23
2-114	5 OCT 23
2-115	5 OCT 23
2-116	5 OCT 23
2-117	5 OCT 23
2-118	5 OCT 23
2-119	5 OCT 23
2-120	5 OCT 23
2-121	5 OCT 23
2-122	5 OCT 23
2-123	5 OCT 23
2-124	5 OCT 23
2-125	5 OCT 23
2-126	5 OCT 23
2-127	5 OCT 23
2-128	5 OCT 23
2-129	5 OCT 23
2-130	5 OCT 23
2-131	5 OCT 23
2-132	5 OCT 23
2-133	5 OCT 23
2-134	5 OCT 23
2-135	5 OCT 23
2-136	5 OCT 23
2-137	5 OCT 23
2-138	5 OCT 23
2-139	5 OCT 23
2-140	5 OCT 23
2-141	5 OCT 23
2-142	5 OCT 23
2-143	5 OCT 23
2-144	5 OCT 23
2-145	5 OCT 23
2-146	5 OCT 23
2-147	5 OCT 23
2-148	5 OCT 23
2-149	5 OCT 23
2-150	5 OCT 23
2-151	5 OCT 23
2-152	5 OCT 23
2-153	5 OCT 23
2-154	5 OCT 23
2-155	5 OCT 23
2-156	5 OCT 23
2-157	5 OCT 23
2-158	5 OCT 23

PAGE	DATE
2-159	5 OCT 23
2-160	5 OCT 23
2-161	5 OCT 23
2-162	5 OCT 23
2-163	5 OCT 23
2-164	5 OCT 23
2-165	5 OCT 23
2-166	5 OCT 23
2-167	5 OCT 23
2-168	5 OCT 23
2-169	5 OCT 23
2-170	5 OCT 23
2-171	5 OCT 23
2-172	5 OCT 23
2-173	5 OCT 23
2-174	5 OCT 23
2-175	5 OCT 23
2-176	5 OCT 23
2-177	5 OCT 23
2-178	5 OCT 23
2-179	5 OCT 23
2-180	5 OCT 23
2-181	5 OCT 23
2-182	5 OCT 23
2-183	5 OCT 23
2-184	5 OCT 23
2-185	5 OCT 23
2-186	5 OCT 23
2-187	5 OCT 23
2-188	5 OCT 23
2-189	5 OCT 23
2-190	5 OCT 23
2-191	5 OCT 23
2-192	5 OCT 23
2-193	5 OCT 23
2-194	5 OCT 23
2-195	5 OCT 23
2-196	5 OCT 23
2-197	5 OCT 23
2-198	5 OCT 23
2-199	5 OCT 23
2-200	5 OCT 23
2-201	5 OCT 23
2-202	5 OCT 23
2-203	5 OCT 23
2-204	5 OCT 23
2-205	5 OCT 23
2-206	5 OCT 23
2-207	5 OCT 23
2-208	5 OCT 23
2-209	5 OCT 23
2-210	5 OCT 23



PAGE	DATE
2-211	5 OCT 23
2-212	5 OCT 23
2-213	5 OCT 23
2-214	5 OCT 23
2-215	5 OCT 23
2-216	5 OCT 23
2-217	5 OCT 23
2-218	5 OCT 23
2-219	5 OCT 23
2-220	5 OCT 23
2-221	5 OCT 23
2-222	5 OCT 23
2-223	5 OCT 23
2-224	5 OCT 23
2-225	5 OCT 23
2-226	5 OCT 23
2-227	5 OCT 23
2-228	5 OCT 23
2-229	5 OCT 23
2-230	5 OCT 23
2-231	5 OCT 23
2-232	5 OCT 23
2-233	5 OCT 23
2-234	5 OCT 23
2-235	5 OCT 23
2-236	5 OCT 23
2-237	5 OCT 23
2-238	5 OCT 23
2-239	5 OCT 23
2-240	5 OCT 23
2-241	5 OCT 23
2-242	5 OCT 23
2-243	5 OCT 23
2-244	5 OCT 23
2-245	5 OCT 23
2-246	5 OCT 23
2-247	5 OCT 23
2-248	5 OCT 23
2-249	5 OCT 23
2-250	5 OCT 23
2-251	5 OCT 23
2-252	5 OCT 23
2-253	5 OCT 23
2-254	5 OCT 23
2-255	5 OCT 23
2-256	5 OCT 23
2-257	5 OCT 23
2-258	5 OCT 23
2-259	5 OCT 23
2-260	5 OCT 23
2-261	5 OCT 23
2-262	5 OCT 23

PAGE	DATE
2-263	5 OCT 23
2-264	5 OCT 23
2-265	5 OCT 23
2-266	5 OCT 23
2-267	5 OCT 23
2-268	5 OCT 23
2-269	5 OCT 23
2-270	5 OCT 23
2-271	5 OCT 23
2-272	5 OCT 23
2-273	5 OCT 23
2-274	5 OCT 23
2-275	5 OCT 23
2-276	5 OCT 23
2-277	5 OCT 23
2-278	5 OCT 23
2-279	5 OCT 23
2-280	5 OCT 23
2-281	5 OCT 23
2-282	5 OCT 23
2-283	5 OCT 23
2-284	5 OCT 23
2-285	5 OCT 23
2-286	5 OCT 23
2-287	5 OCT 23
2-288	5 OCT 23
2-289	5 OCT 23
2-290	5 OCT 23
2-291	5 OCT 23
2-292	5 OCT 23
2-293	5 OCT 23
2-294	5 OCT 23
2-295	5 OCT 23
2-296	5 OCT 23
2-297	5 OCT 23
2-298	5 OCT 23
2-299	5 OCT 23
2-300	5 OCT 23
2-301	5 OCT 23
2-302	5 OCT 23
2-303	5 OCT 23
2-304	5 OCT 23
2-305	5 OCT 23
2-306	5 OCT 23
2-307	5 OCT 23
2-308	5 OCT 23
2-309	5 OCT 23
2-310	5 OCT 23
2-311	5 OCT 23
2-312	5 OCT 23
2-313	5 OCT 23
2-314	5 OCT 23

PAGE	DATE
2-315	5 OCT 23
2-316	5 OCT 23
2-317	5 OCT 23
2-318	5 OCT 23
2-319	5 OCT 23
2-320	5 OCT 23
2-321	5 OCT 23
2-322	5 OCT 23
2-323	5 OCT 23
2-324	5 OCT 23
2-325	5 OCT 23
2-326	5 OCT 23
2-327	5 OCT 23
2-328	5 OCT 23
2-329	5 OCT 23
2-330	5 OCT 23
2-331	5 OCT 23
2-332	5 OCT 23
2-333	5 OCT 23
2-334	5 OCT 23
2-335	5 OCT 23
2-336	5 OCT 23
2-337	5 OCT 23
2-338	5 OCT 23
2-339	5 OCT 23
2-340	5 OCT 23
2-341	5 OCT 23
2-342	5 OCT 23
2-343	5 OCT 23
2-344	5 OCT 23
2-345	5 OCT 23
2-346	5 OCT 23
2-347	5 OCT 23
2-348	5 OCT 23
2-349	5 OCT 23
2-350	5 OCT 23
2-351	5 OCT 23
2-352	5 OCT 23
2-353	5 OCT 23
2-354	5 OCT 23
2-355	5 OCT 23
2-356	5 OCT 23
2-357	5 OCT 23
2-358	5 OCT 23
2-359	5 OCT 23
2-360	5 OCT 23
2-361	5 OCT 23
2-362	5 OCT 23
2-363	5 OCT 23
2-364	5 OCT 23
2-365	5 OCT 23
2-366	5 OCT 23

PAGE	DATE
2-367	5 OCT 23
2-368	5 OCT 23
2-369	5 OCT 23
2-370	5 OCT 23
2-371	5 OCT 23
2-372	5 OCT 23
2-373	5 OCT 23
2-374	5 OCT 23
2-375	5 OCT 23
2-376	5 OCT 23
2-377	5 OCT 23
2-378	5 OCT 23
2-379	5 OCT 23
2-380	5 OCT 23
2-381	5 OCT 23
2-382	5 OCT 23
2-383	5 OCT 23
2-384	5 OCT 23
2-385	5 OCT 23
2-386	5 OCT 23
2-387	5 OCT 23
2-388	5 OCT 23
2-389	5 OCT 23
2-390	5 OCT 23
2-391	5 OCT 23
2-392	5 OCT 23
2-393	5 OCT 23
2-394	5 OCT 23
2-395	5 OCT 23
2-396	5 OCT 23
2-397	5 OCT 23
2-398	5 OCT 23
2-399	5 OCT 23
2-400	5 OCT 23
2-401	5 OCT 23
2-402	5 OCT 23
2-403	5 OCT 23
2-404	5 OCT 23
2-405	5 OCT 23
2-406	5 OCT 23
2-407	5 OCT 23
2-408	5 OCT 23
2-409	5 OCT 23
2-410	5 OCT 23
2-411	5 OCT 23
2-412	5 OCT 23
2-413	5 OCT 23
2-414	5 OCT 23
2-415	5 OCT 23
2-416	5 OCT 23
2-417	5 OCT 23
2-418	5 OCT 23

PAGE	DATE
2-419	5 OCT 23
2-420	5 OCT 23
2-421	5 OCT 23
2-422	5 OCT 23
2-423	5 OCT 23
2-424	5 OCT 23
2-425	5 OCT 23
2-426	5 OCT 23
2-427	5 OCT 23
2-428	5 OCT 23
2-429	5 OCT 23
2-430	5 OCT 23
2-431	5 OCT 23
2-432	5 OCT 23
2-433	5 OCT 23
2-434	5 OCT 23
2-435	5 OCT 23
2-436	5 OCT 23
2-437	5 OCT 23
2-438	5 OCT 23
2-439	5 OCT 23
2-440	5 OCT 23
2-441	5 OCT 23
2-442	5 OCT 23
2-443	5 OCT 23
2-444	5 OCT 23
2-445	5 OCT 23
2-446	5 OCT 23
2-447	5 OCT 23
2-448	5 OCT 23
2-449	5 OCT 23
2-450	5 OCT 23
2-451	5 OCT 23
2-452	5 OCT 23
2-453	5 OCT 23
2-454	5 OCT 23
2-455	5 OCT 23
2-456	5 OCT 23
2-457	5 OCT 23
2-458	5 OCT 23
2-459	5 OCT 23
2-460	5 OCT 23
2-461	5 OCT 23
2-462	5 OCT 23
2-463	5 OCT 23
2-464	5 OCT 23
2-465	5 OCT 23
2-466	5 OCT 23
2-467	5 OCT 23
2-468	5 OCT 23
2-469	5 OCT 23
2-470	5 OCT 23

PAGE	DATE
2-471	5 OCT 23
2-472	5 OCT 23
2-472	5 OCT 23
2-473	5 OCT 23
2-474	5 OCT 23
2-475	5 OCT 23
2-476	5 OCT 23
2-477	5 OCT 23
2-478	5 OCT 23
2-479	5 OCT 23
2-480	5 OCT 23
2-481	5 OCT 23
2-482	5 OCT 23
2-483	5 OCT 23
2-484	5 OCT 23
2-485	5 OCT 23
2-486	5 OCT 23
2-487	5 OCT 23
2-488	5 OCT 23
2-489	5 OCT 23
2-490	5 OCT 23
2-491	5 OCT 23
2-492	5 OCT 23
2-493	5 OCT 23
2-494	5 OCT 23
2-495	5 OCT 23
2-496	5 OCT 23
2-497	5 OCT 23
2-498	5 OCT 23
2-499	5 OCT 23
2-500	5 OCT 23
2-501	5 OCT 23
2-502	5 OCT 23
2-503	5 OCT 23
2-504	5 OCT 23
2-505	5 OCT 23
2-506	5 OCT 23
2-507	5 OCT 23
2-508	5 OCT 23
2-509	5 OCT 23
2-510	5 OCT 23
2-511	5 OCT 23
2-512	5 OCT 23
2-513	5 OCT 23
2-514	5 OCT 23
2-515	5 OCT 23
2-516	5 OCT 23
2-517	5 OCT 23
2-518	5 OCT 23
2-519	5 OCT 23
2-520	5 OCT 23
2-521	5 OCT 23

PAGE	DATE
2-522	5 OCT 23
2-523	5 OCT 23
2-524	5 OCT 23
2-525	5 OCT 23
2-526	5 OCT 23
2-527	5 OCT 23
2-528	5 OCT 23
2-529	5 OCT 23
2-530	5 OCT 23
2-531	5 OCT 23
2-532	5 OCT 23
2-533	5 OCT 23
2-534	5 OCT 23
2-535	5 OCT 23
2-536	5 OCT 23
2-537	5 OCT 23
2-538	5 OCT 23
2-539	5 OCT 23
2-540	5 OCT 23
2-541	5 OCT 23
2-542	5 OCT 23
2-543	5 OCT 23
2-544	5 OCT 23
2-545	5 OCT 23
2-546	5 OCT 23
2-547	5 OCT 23
2-548	5 OCT 23
2-549	5 OCT 23
2-550	5 OCT 23
2-551	5 OCT 23
2-552	5 OCT 23
2-553	5 OCT 23
2-554	5 OCT 23
2-555	5 OCT 23
2-556	5 OCT 23
2-557	5 OCT 23
2-558	5 OCT 23
2-559	5 OCT 23
2-560	5 OCT 23
2-561	5 OCT 23
2-562	5 OCT 23
2-563	5 OCT 23
2-564	5 OCT 23
2-565	5 OCT 23
2-566	5 OCT 23
2-567	5 OCT 23
2-568	5 OCT 23
2-569	5 OCT 23
2-570	5 OCT 23
2-571	5 OCT 23
2-572	5 OCT 23
2-572	5 OCT 23

PAGE	DATE
2-573	5 OCT 23
2-574	5 OCT 23
2-575	5 OCT 23
2-576	5 OCT 23
2-577	5 OCT 23
2-578	5 OCT 23
2-579	5 OCT 23
2-580	5 OCT 23
2-581	5 OCT 23
2-582	5 OCT 23
2-583	5 OCT 23
2-584	5 OCT 23
2-585	5 OCT 23
2-586	5 OCT 23
2-587	5 OCT 23
2-588	5 OCT 23
2-589	5 OCT 23
2-590	5 OCT 23
2-591	5 OCT 23
2-592	5 OCT 23
2-593	5 OCT 23
2-594	5 OCT 23
2-595	5 OCT 23
2-596	5 OCT 23
2-597	5 OCT 23
2-598	5 OCT 23
2-599	5 OCT 23
2-601	5 OCT 23
2-602	5 OCT 23
2-603	5 OCT 23
2-604	5 OCT 23
2-605	5 OCT 23
2-606	5 OCT 23
2-607	5 OCT 23
2-608	5 OCT 23
2-609	5 OCT 23
2-610	5 OCT 23
2-611	5 OCT 23
2-612	5 OCT 23
2-613	5 OCT 23
2-614	5 OCT 23
2-615	5 OCT 23
2-616	5 OCT 23
2-617	5 OCT 23
2-618	5 OCT 23
2-619	5 OCT 23
2-620	5 OCT 23
2-621	5 OCT 23
2-622	5 OCT 23
2-623	5 OCT 23
2-624	5 OCT 23
2-625	5 OCT 23

PAGE	DATE
2-626	5 OCT 23
2-627	5 OCT 23
2-628	5 OCT 23
2-629	5 OCT 23
2-630	5 OCT 23
2-631	5 OCT 23
2-632	5 OCT 23
2-633	5 OCT 23
2-634	5 OCT 23
2-635	5 OCT 23
2-636	5 OCT 23
2-637	5 OCT 23
2-638	5 OCT 23
2-639	5 OCT 23
2-640	5 OCT 23
2-641	5 OCT 23
2-642	5 OCT 23
2-643	5 OCT 23
2-644	5 OCT 23
2-645	5 OCT 23
2-646	5 OCT 23
2-647	5 OCT 23
2-648	5 OCT 23
2-649	5 OCT 23
2-650	5 OCT 23
2-651	5 OCT 23
2-652	5 OCT 23

**INDEX**

I-1	5 OCT 23
I-2	5 OCT 23
I-3	5 OCT 23
I-4	5 OCT 23
I-5	5 OCT 23
I-6	5 OCT 23
I-7	5 OCT 23
I-8	5 OCT 23
I-9	5 OCT 23

**APPENDIX**

Appendix 1-1	20 APR 23
1 through 438	N/A
Appendix 2-1	5 OCT 23
Appendix 2-2	19 MAY 22
Appendix 2-3	19 MAY 22
Appendix 2-4	19 MAY 22
Appendix 2-5	19 MAY 22
Appendix 2-6	3 NOV 22

PAGE	DATE
Appendix 2-7	19 MAY 22
Appendix 2-8	19 MAY 22
Appendix 2-9	19 MAY 22
Appendix 2-10	19 MAY 22
Appendix 2-11	3 NOV 22
Appendix 2-12	3 NOV 22
Appendix 2-13	3 NOV 22

PAGE	DATE
Appendix 2-14	3 NOV 22
Appendix 2-15	19 MAY 22
Appendix 2-16	20 APR 23
Appendix 2-17	19 MAY 22
Appendix 2-18	19 MAY 22
Appendix 2-19	5 OCT 23
Appendix 2-20	5 OCT 23

PAGE	DATE
Appendix 2-21	5 OCT 23
Appendix 2-22	5 OCT 23
Appendix 2-23	20 APR 23

AD 0.5 List of Hand Amendments to the AIP – Not applicable

AD 0.5 List of Hand Amendments to the AIP – Not applicable



## AD 0.6 Table of Contents to Part 3

**AD 1. AERODROMES - INTRODUCTION**

AD 1.1 Aerodrome Availability ..... AD 1.1-1

**AD 2. AERODROMES** ..... AD 2-1





# AD 1. AERODROMES – INTRODUCTION

## AD 1.1 Aerodrome Availability

### 1. General Regulations Concerning Airport Use

**1.1** International arrivals with scheduled passenger service are not permitted to land at any aerodrome not listed in this AIP except in cases of real emergency or where special permission has been granted.

**1.2** The conditions under which aircraft may land, be parked, housed or otherwise dealt with at U.S. aerodromes is under the control of the aerodrome owner/operator. Conditions and fees pertaining to landing, parking, or storing are variable from aerodrome to aerodrome and are not published in the U.S. AIP.

**1.3** In the United States, some telecommunication companies launched 5G services on January 19, 2022, using frequencies in a portion of the radio spectrum called the C-band. These frequencies can be close to those used by radio altimeters, an important piece of safety equipment in aircraft. The 5G deployment involves a new combination of power levels, frequencies, proximity to flight operations, and other factors. The FAA requires that radio altimeters are accurate and reliable, and therefore imposes restrictions on flight operations using certain types of radio altimeter equipment. These safety restrictions are posted in a 5G C-Band Domestic Notice, and could affect flight schedules and operations. All operators (domestic and international) must comply with the guidance and restrictions provided in this Domestic Notice.

### 2. Landings Made Elsewhere Than at International Aerodromes

**2.1** Permission to land at airports other than “international” and “landing rights” airports may be obtained in some limited cases; however, advance arrangements (preferably in writing) must be made with the U.S. Customs office nearest the airport of intended arrival (see GEN 1). Advance notice of arrival is required as usual. Pilots should be aware that mileage and per diem costs may be accrued in addition to any overtime charges if applicable.

**2.2** If an emergency landing is made elsewhere than at an international aerodrome or a designated alternate aerodrome, the pilot in command must report the landing as promptly as possible by telephone or the most convenient means to the nearest Customs office. He/she should keep all merchandise or baggage in a segregated place and should not permit any passenger or crewmember to depart the place of arrival or mingle with the public without official permission, unless it is necessary for preservation of life, health, or property.

### 3. Traffic of Persons and Vehicles on Aerodromes

**3.1** The grounds of each aerodrome are divided into two zones:

**3.1.1** A public zone comprising the part of the aerodrome open to the public; and

**3.1.2** A restricted zone comprising the rest of the aerodrome.

#### 3.2 Movement of Persons

**3.2.1** Access to the restricted zone is authorized only under conditions prescribed by the rules governing the aerodrome as established by the officials responsible for aerodrome security.

**3.2.2** The customs, security, immigration and health inspection offices and areas, and the premises assigned to transit traffic are normally accessible only to passengers, to staff members of the responsible authorities or airlines, and to authorized persons in pursuit of their duties.

**3.2.3** The movement of persons having access to the restricted zone of the aerodrome is subject to the conditions prescribed by applicable air traffic and by the security regulations laid down by the person responsible for the management of the aerodrome.

### **3.3 Movement of Vehicles**

**3.3.1** The movement of vehicles in the restricted zone is strictly limited to vehicles driven or used by persons having official permission.

**3.3.2** Drivers of vehicles, of whatever type, driving within the confines of the aerodrome, must respect the direction of traffic, the traffic signs, and the posted speed limits and generally comply with the provisions of the highway code and with instructions given by the competent authorities.

## **4. General Information and Aerodrome Lighting and Marking**

**4.1** Aerodrome lighting information is contained in paragraphs 12. through 16. Information on aerodrome marking aids and signs is contained in paragraph 17.

**4.2** Designated international U.S. aerodromes with scheduled passenger service in large aircraft and certain airports designated as alternate service aerodromes are listed in , Aerodromes.

## **5. Aerodrome Administration**

**5.1** The administration of all airports is the responsibility of the aerodrome owner.

**5.2** Ownership of aerodromes in the U.S. is vested in three different groups: the Federal Government, non-Federal governments, and private organizations or individuals. It is the policy of the U.S. Federal Government to have its aerodromes comply with ICAO Standards and Recommended Practices. Exceptions are noted as differences below and in GEN 1.7. Aerodromes owned by non-Federal governments and private organizations or individuals are encouraged to comply with International Standards and Recommended Practices in part through the regulation of aircraft operations into the aerodromes and in part through agreements under which Federal aid is made available for aerodrome development or improvement. Further compliance is by voluntary action on the part of the aerodrome owner.

## **6. Conditions of Availability**

**6.1** An aerodrome which is open for public use may be used by a particular aircraft upon consideration of the meteorological conditions existing at the time and provided that the aircraft's performance and load classification (runway weight-bearing classification) is consistent with the physical characteristics of the aerodrome.

### **6.2 Civil Use of Military Fields**

**6.2.1** Except at joint-use airfields, U.S. Army, Air Force, Navy, Marine Corps, and Coast Guard airfields are available for use by civil aircraft only with prior permission or in an emergency. An approved civil aircraft landing permit is required for use at all except Coast Guard airfields. With minor exceptions, authority to use military airfields is granted only to aircraft on official government business.

**6.2.2** An application for a permit must be submitted to the appropriate military department a minimum of 30 days prior to the first intended landing. A permit application consists of Department of Defense Forms DD Form 2400, Civil Aircraft Certificate of Insurance; DD Form 2401, Civil Aircraft Landing Permit; and DD Form 2402, Hold Harmless Agreement.

**6.2.3** Forms and instructions can be obtained from the following addresses.

Army: Director, USAASA  
ATTN: MOAS-AS  
Building 1466  
9325 Gunston Road, Suite N319  
Ft. Belvoir, VA 22060-5582  
Telephone: (703) 806-4864

Air Force: HQ USAF/XOO-CA  
1480 Air Force Pentagon,  
Room 4D1010  
Washington DC 20330-1480  
Telephone: (703) 697-5967

Navy/  
Marine Corps: Commander  
Naval Facilities Engineering Command,  
Code 141JB  
200 Stovall Street, Room 10N45  
Alexandria, VA 22332-2300  
Telephone: (703) 325-0475

At Coast Guard airfields, prior permission must be requested from the commanding officer of the airfield to be used.

## **7. Applicable ICAO Documents**

ICAO Standards and Recommended Practices contained in Annex 14 are applied with the exceptions noted in GEN 1.7, Differences from ICAO Standards, Recommended Practices and Procedures.

## **8. Maintenance of Aerodrome Movement Areas**

**8.1** It is the responsibility of the relevant aerodrome authority to maintain the aerodrome in a satisfactory condition.

**8.2** Clearance of snow and measurement of snow, ice, standing water, braking action, etc., and the reporting of such pavement conditions is within the responsibility of the aerodrome authority.

## **9. Dissemination of Information on the Condition of Paved Surface**

**9.1** Information on surface condition of runways, taxiways and aprons will be published, when available and when necessary.

**9.2** At aerodromes where an ATS unit is established, if a runway is affected by standing water, snow, slush or ice during the approach of an aircraft for landing, and such conditions are notified by the aerodrome management to the ATS unit, such conditions will be made available to the aircraft.

## **10. Rescue and Fire Fighting Facilities**

**10.1** Adequate rescue and fire-fighting vehicles, equipment and personnel are provided at aerodromes available for international commercial air transport.

**10.2** Temporary interruptions to rescue and fire-fighting service, or non-availability of such services, are made known by NOTAM.

**10.3** Certificated Aerodromes (14 CFR Part 139)

Aerodromes serving certain air carriers under 14 CFR Part 139 are indicated by a CFR Index which relates to the availability of crash, fire, and rescue equipment. (See TBL AD 1.1-1.)

## 11. Bird Concentrations in the Vicinity of Aerodromes

**11.1** Animal and bird notices are not normally published in aerodrome remarks. Pilots should be aware that animals and birds are frequently found in the vicinity of aerodromes and should exercise due caution. However, selected bird notices may be published, but only after approval by the appropriate Regional Bird Hazard Group.

### TBLAD 1.1-1

## 14 CFR PART 139 CERTIFICATED AIRPORTS

### Indexes and Fire Fighting and Rescue Equipment Requirements

Airport Index	Required Number of Vehicles	Aircraft Length	Agent & Water for Foam
A	1	< 90'	500# DC or 450# DC + 100 gal H <sub>2</sub> O
B	1 or 2	≥ 90' & < 126'	Index A + 1500 gal H <sub>2</sub> O
C	2 or 3	≥ 126' & < 159'	Index A + 3000 gal H <sub>2</sub> O
D	3	≥ 159' & < 200'	Index A + 4000 gal H <sub>2</sub> O
E	3	≥ 200'	Index A + 6000 gal H <sub>2</sub> O
> Greater Than; < Less Than; ≥ Equal To or Greater Than; H <sub>2</sub> O Water; DC Dry Chemical			
<b>NOTE-</b> Vehicle and capacity requirements for airports holding limited operating certificates are determined on a case-by-case basis.			

## 12. Airport Lighting Aids

### 12.1 Approach Light Systems (ALS)

**12.1.1** Approach light systems provide the basic means for transition from instrument flight to visual flight for landing. Operational requirements dictate the sophistication and configuration of the approach light system for a particular runway.

**12.1.2** Approach light systems are a configuration of signal lights starting at the landing threshold and extending into the approach area a distance of 2400–3000 feet for precision instrument runways and 1400–1500 feet for nonprecision instrument runways. Some systems include sequenced flashing lights which appear to the pilot as a ball of light traveling towards the runway at high speed (twice each second).

### 12.2 Visual Glideslope Indicators

#### 12.2.1 Visual Approach Slope Indicator (VASI)

**12.2.1.1** The VASI is a system of lights so arranged to provide visual descent guidance information during the approach to a runway. These lights are visible from 3–5 miles during the day and up to 20 miles or more at night. The visual glide path of the VASI provides safe obstruction clearance within plus or minus 10 degrees of the extended runway centerline and to 4 NM from the runway threshold. Descent, using the VASI, should not be initiated until the aircraft is visually aligned with the runway. Lateral course guidance is provided by the runway or runway lights. In certain circumstances, the safe obstruction clearance area may be reduced by narrowing the beam width or shortening the usable distance due to local limitations, or the VASI may be offset from the extended runway centerline. This will be noted in the Chart Supplement U.S. and/or applicable Notices to Air Missions (NOTAM).

**12.2.1.2** VASI installations may consist of either 2, 4, 6, 12, or 16 light units arranged in bars referred to as near, middle, and far bars. Most VASI installations consist of 2 bars, near and far, and may consist of 2, 4, or 12 light

units. Some airports have VASIs consisting of three bars, near, middle, and far, which provide an additional visual glide path to accommodate high cockpit aircraft. This installation may consist of either 6 or 16 light units. VASI installations consisting of 2, 4, or 6 light units are located on one side of the runway, usually the left. Where the installation consists of 12 or 16 light units, the light units are located on both sides of the runway.

**12.2.1.3** Two–bar VASI installations provide one visual glide path which is normally set at 3 degrees. Three–bar VASI installations provide two visual glide paths. The lower glide path is provided by the near and middle bars and is normally set at 3 degrees while the upper glide path, provided by the middle and far bars, is normally  $\frac{1}{4}$  degree higher. This higher glide path is intended for use only by high cockpit aircraft to provide a sufficient threshold crossing height. Although normal glide path angles are three degrees, angles at some locations may be as high as 4.5 degrees to give proper obstacle clearance. Pilots of high performance aircraft are cautioned that use of VASI angles in excess of 3.5 degrees may cause an increase in runway length required for landing and rollout.

**12.2.1.4** The basic principle of the VASI is that of color differentiation between red and white. Each light unit projects a beam of light having a white segment in the upper part of the beam and red segment in the lower part of the beam. The light units are arranged so that the pilot using the VASIs during an approach will see the combination of lights shown below.

**12.2.1.5** For 2–BAR VASI (4 light units), see FIG AD 1.1–2.

**12.2.1.6** For 3–BAR VASI (6 light units), see FIG AD 1.1–3.

**12.2.1.7** For other VASI configurations, see FIG AD 1.1–4.

**12.2.2 Precision Approach Path Indicator (PAPI).** The precision approach path indicator (PAPI) uses light units similar to the VASI but are installed in a single row of either two or four light units. These lights are visible from about 5 miles during the day and up to 20 miles at night. The visual glide path of the PAPI typically provides safe obstruction clearance within plus or minus 10 degrees of the extended runway centerline and to 3.4 NM from the runway threshold. Descent, using the PAPI, should not be initiated until the aircraft is visually aligned with the runway. The row of light units is normally installed on the left side of the runway and the glide path indications are as depicted. Lateral course guidance is provided by the runway or runway lights. In certain circumstances, the safe obstruction clearance area may be reduced by narrowing the beam width or shortening the usable distance due to local limitations, or the PAPI may be offset from the extended runway centerline. This will be noted in the Chart Supplement U.S. and/or applicable NOTAMs. (See FIG AD 1.1–5.)

**12.2.3 Tri–color Systems.** Tri–color visual approach slope indicators normally consist of a single light unit, projecting a three–color visual approach path into the final approach area of the runway upon which the indicator is installed. The below glide path indication is red, the above glide path indication is amber, and the on glide path indication is green. These types of indicators have a useful range of approximately  $\frac{1}{2}$  to 1 mile during the day and up to 5 miles at night depending upon the visibility conditions. (See FIG AD 1.1–6.)

**12.2.4 Pulsating Systems.** Pulsating visual approach slope indicators normally consist of a single light unit projecting a two–color visual approach path into the final approach area of the runway upon which the indicator is installed. The on glide path indication may be a steady white light or alternating RED and WHITE light. The slightly below glide path indication is a steady red light. If the aircraft descends further below the glide path, the red light starts to pulsate. The above glide path indication is a pulsating white light. The pulsating rate increases as the aircraft gets further above or below the desired glide slope. The useful range of the system is about four miles during the day and up to ten miles at night. (See FIG AD 1.1–7.)

**12.2.5 Alignment of Elements Systems.** Alignment of elements systems are installed on some small general aviation airports and are a low cost system consisting of painted plywood panels, normally black and white or fluorescent orange. Some of these systems are lighted for night use. The useful range of these systems is approximately  $\frac{3}{4}$  mile. To use the system the pilot positions the aircraft so the elements are in alignment. The glide path indications are shown in FIG AD 1.1–8.

## 12.3 Runway End Identifier Lights (REIL)

**12.3.1** REILs are installed at many airfields to provide rapid and positive identification of the approach end of a particular runway. The system consists of a pair of synchronized flashing lights, one of which is located laterally on each side of the runway threshold facing the approach area. They are effective for:

**12.3.1.1** Identification of a runway surrounded by a preponderance of other lighting.

**12.3.1.2** Identification of a runway which lacks contrast with surrounding terrain.

**12.3.1.3** Identification of a runway during reduced visibility.

## **12.4 Runway Edge Light Systems**

**12.4.1** Runway edge lights are used to outline the edges of runways during periods of darkness or restricted visibility conditions. These light systems are classified according to the intensity or brightness they are capable of producing: they are the High Intensity Runway Lights (HIRL), Medium Intensity Runway Lights (MIRL), and the Low Intensity Runway Lights (LIRL). The HIRL and MIRL systems have variable intensity controls; whereas, the LIRLs normally have one intensity setting.

**12.4.2** The runway edge lights are white; except on instrument runways, yellow replaces white on the last 2,000 feet or half the runway length, whichever is less, to form a caution zone for landings.

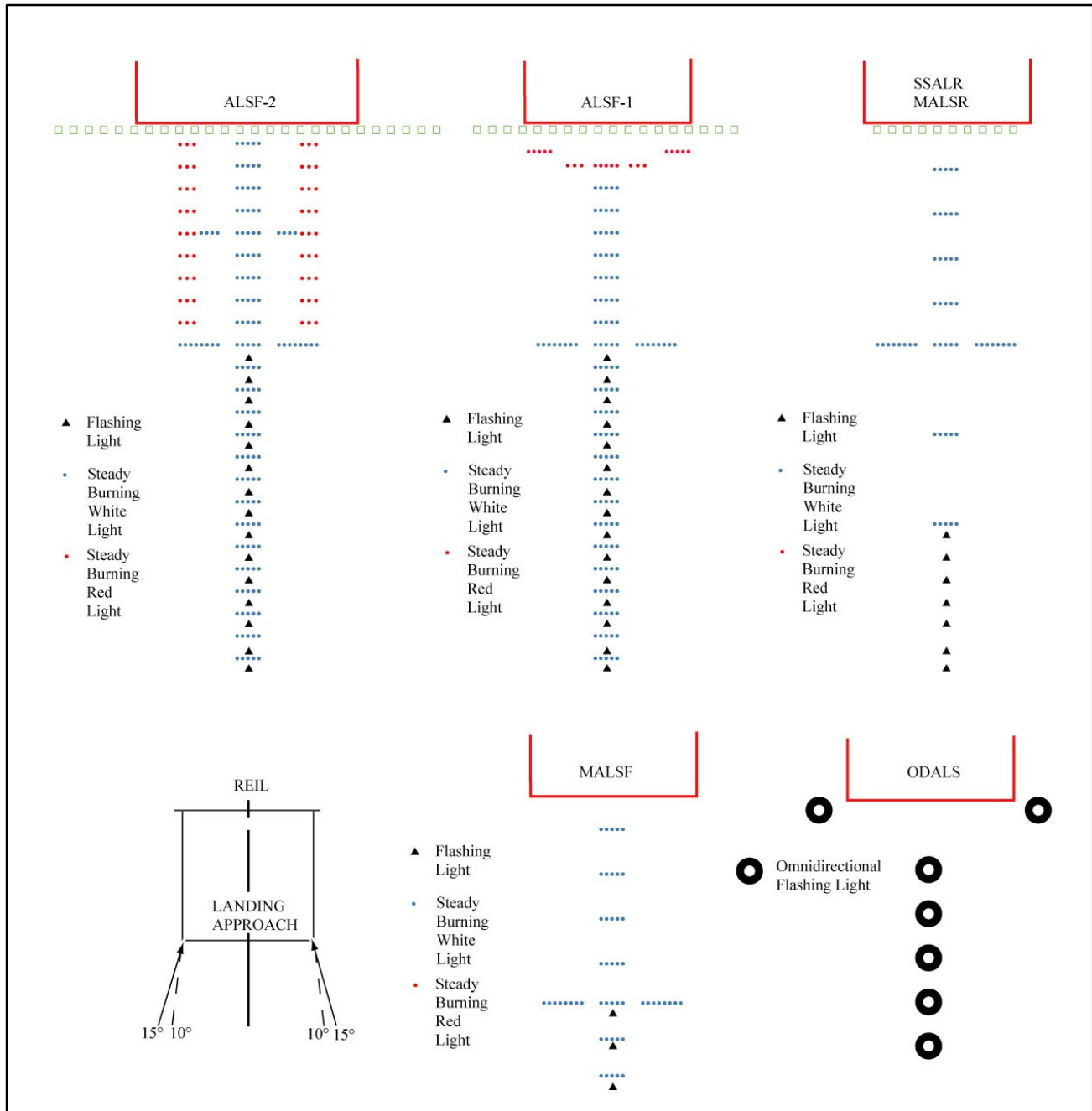
**12.4.3** The lights marking the ends of the runway emit red light toward the runway to indicate the end of the runway to a departing aircraft and emit green outward from the runway end to indicate the threshold to landing aircraft.

## **12.5 In-Runway Lighting**

**12.5.1 Runway Centerline Lighting System (RCLS).** Runway centerline lights are installed on some precision approach runways to facilitate landing under adverse visibility conditions. They are located along the runway centerline and are spaced at 50-foot intervals. When viewed from the landing threshold, the runway centerline lights are white until the last 3,000 feet of the runway. The white lights begin to alternate with red for the next 2,000 feet, and for the last 1,000 feet of the runway, all centerline lights are red.

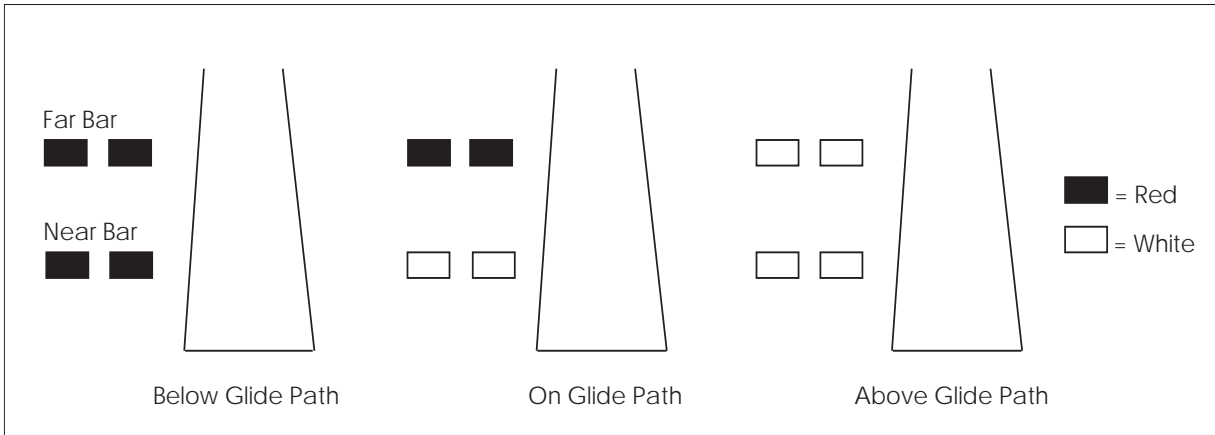
**12.5.2 Touchdown Zone Lights (TDZL).** Touchdown zone lights are installed on some precision approach runways to indicate the touchdown zone when landing under adverse visibility conditions. They consist of two rows of transverse light bars disposed symmetrically about the runway centerline. The system consists of steady-burning white lights which start 100 feet beyond the landing threshold and extend to 3,000 feet beyond the landing threshold or to the midpoint of the runway, whichever is less.

FIG AD 1.1-1  
Precision & Nonprecision Configurations

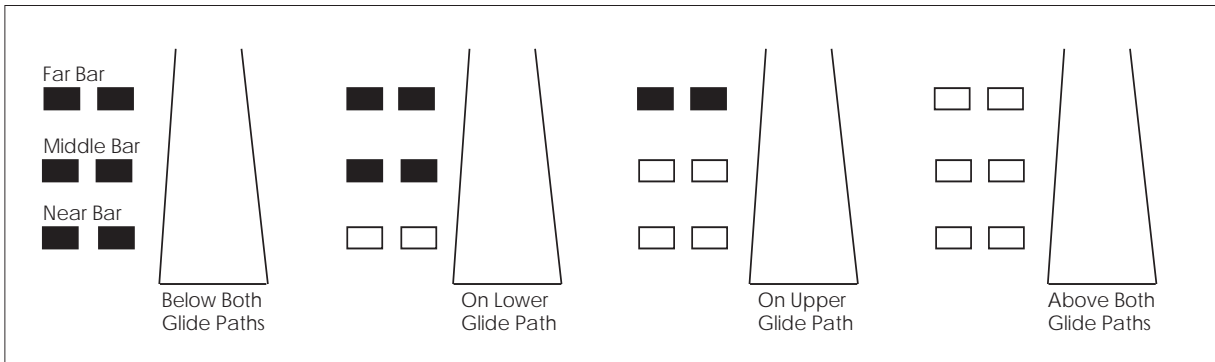


**NOTE-**  
Civil ALSF-2 may be operated as SSALR during favorable weather conditions.

**FIG AD 1.1-2  
2-Bar VASI**



**FIG AD 1.1-3  
3-Bar VASI**



**FIG AD 1.1-4  
VASI Variations**

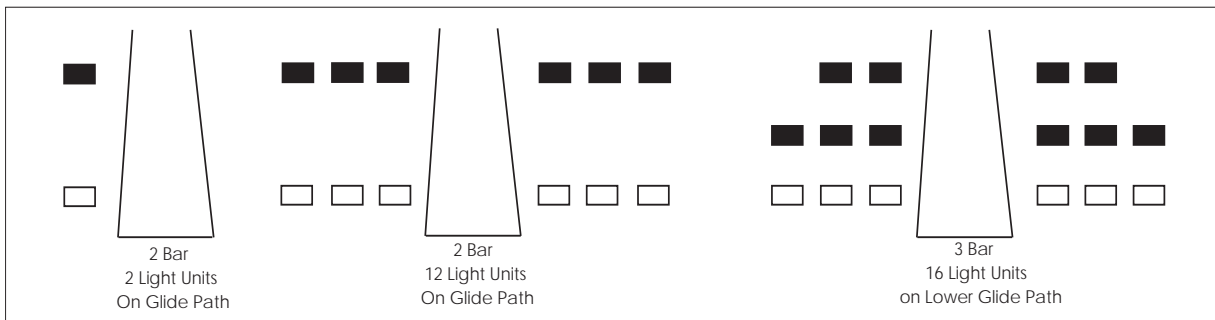




FIG AD 1.1-5  
Precision Approach Path Indicator (PAPI)

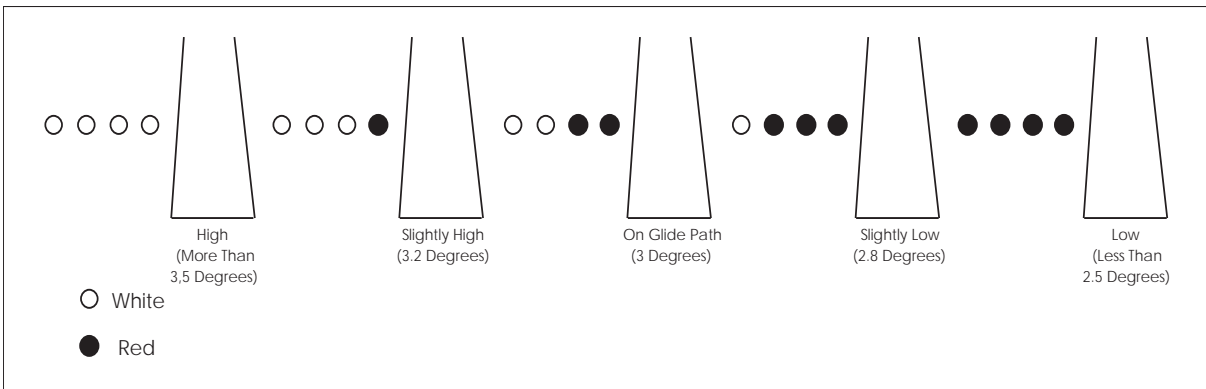
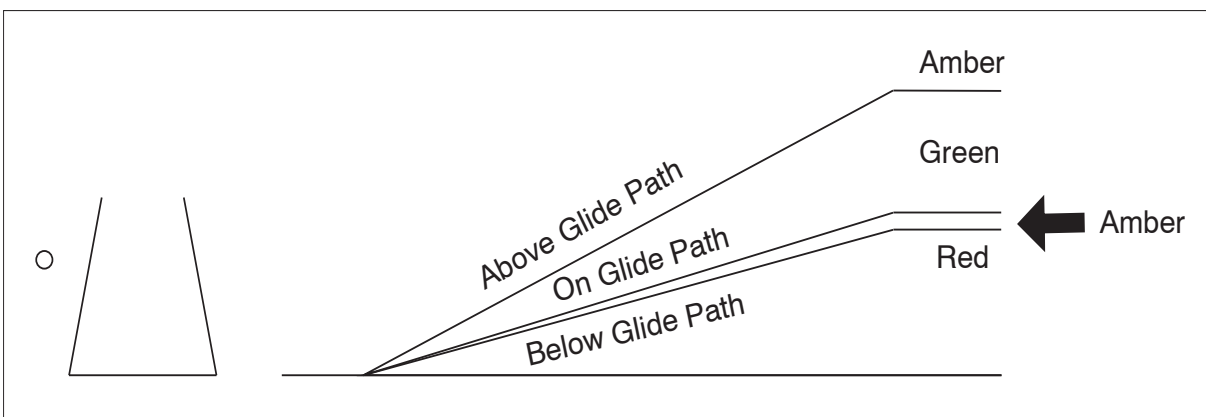


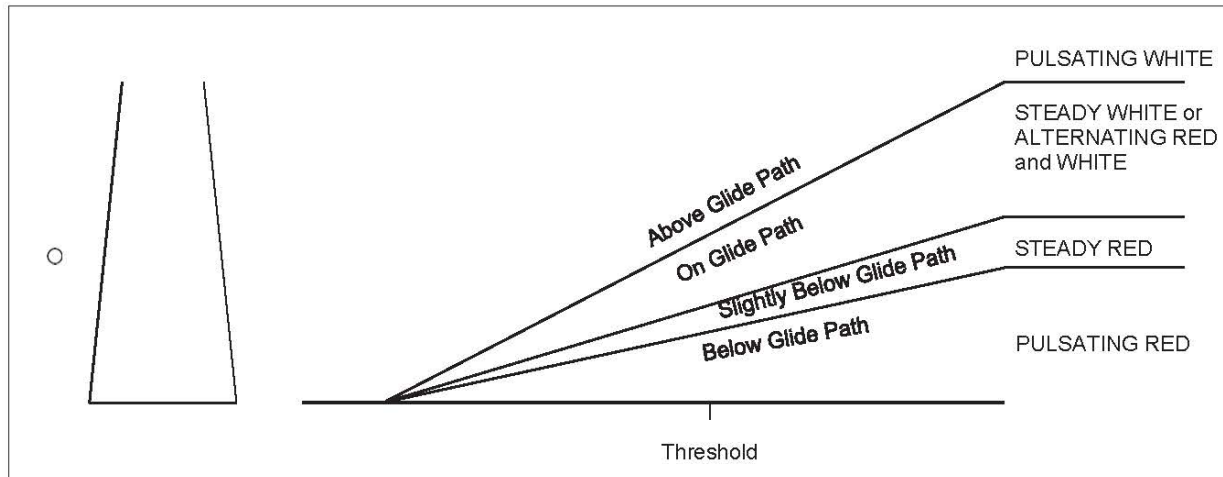
FIG AD 1.1-6  
Tri-Color Visual Approach Slope Indicator



**NOTE-**

1. Since the tri-color VASI consists of a single light source which could possibly be confused with other light sources, pilots should exercise care to properly locate and identify the light signal.
2. When the aircraft descends from green to red, the pilot may see a dark amber color during the transition from green to red.

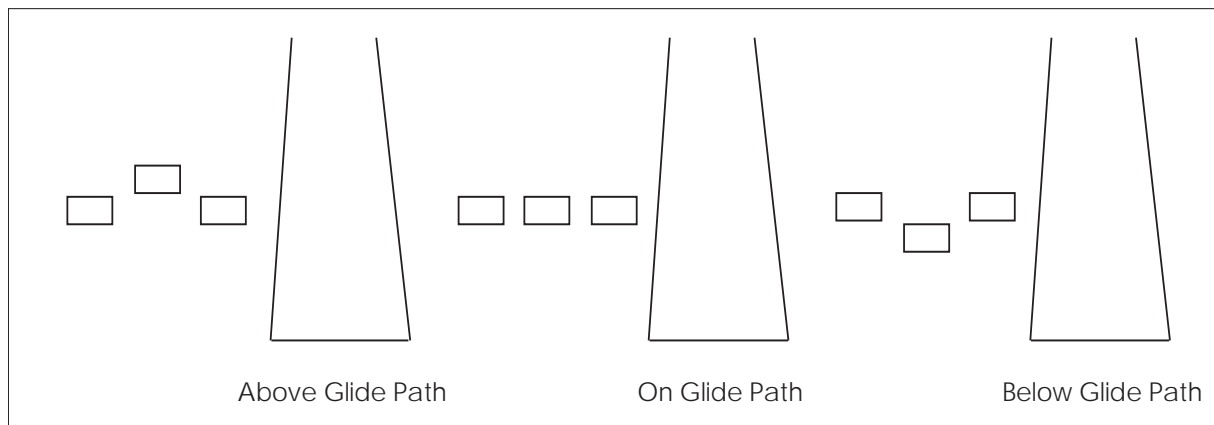
FIG AD 1.1-7  
**Pulsating Visual Approach Slope Indicator**



**NOTE-**

Since the PVASI consists of a single light source which could possibly be confused with other light sources, pilots should exercise care to properly locate and identify the light signal.

FIG AD 1.1-8  
**Alignment of Elements**



**12.5.3 Taxiway Centerline Lead-Off Lights.** Taxiway centerline lead-off lights provide visual guidance to persons exiting the runway. They are color-coded to warn pilots and vehicle drivers that they are within the runway environment or instrument landing system (ILS) critical area, whichever is more restrictive. Alternate green and yellow lights are installed, beginning with green, from the runway centerline to one centerline light position beyond the runway holding position or ILS critical area holding position.

**12.5.4 Taxiway Centerline Lead-On Lights.** Taxiway centerline lead-on lights provide visual guidance to persons entering the runway. These “lead-on” lights are also color-coded with the same color pattern as lead-off lights to warn pilots and vehicle drivers that they are within the runway environment or instrument landing system (ILS) critical area, whichever is more conservative. The fixtures used for lead-on lights are bidirectional, i.e., one side emits light for the lead-on function while the other side emits light for the lead-off function. Any fixture that emits yellow light for the lead-off function must also emit yellow light for the lead-on function. (See FIG AD 1.1-12.)

**12.5.5 Land and Hold Short Lights.** Land and hold short lights are used to indicate the hold short point on certain runways which are approved for Land and Hold Short Operations (LAHSO). Land and hold short lights

consist of a row of pulsing white lights installed across the runway at the hold short point. Where installed, the lights will be on anytime LAHSO is in effect. These lights will be off when LAHSO is not in effect.

**REFERENCE-**

AIP, ENR 1.1, Para 22, Pilot Responsibilities When Conducting Land and Hold Short Operations (LAHSO).

## **12.6 Runway Status Light (RWSL) System**

**12.6.1** Introduction: RWSL is a fully automated system that provides runway status information to pilots and surface vehicle operators to clearly indicate when it is unsafe to enter, cross, or takeoff from a runway. The RWSL system processes information from surveillance systems and activates Runway Entrance Lights (REL) and Takeoff Hold Lights (THL) in accordance with the position and velocity of the detected surface traffic and approach traffic. REL and THL are in-pavement light fixtures that are directly visible to pilots and surface vehicle operators. RWSL is an independent safety enhancement that does not substitute for or convey an ATC clearance. Clearance to enter, cross, takeoff from, or operate on a runway must still be received from ATC. Although ATC has limited control over the system, personnel do not directly use and may not be able to view light fixture activations and deactivations during the conduct of daily ATC operations.

**12.6.2** Runway Entrance Lights (REL): The REL system is composed of flush mounted, in-pavement, unidirectional light fixtures that are parallel to and focused along the taxiway centerline and directed toward the pilot at the hold line. An array of REL lights include the first light at the hold line followed by a series of evenly spaced lights to the runway edge; one additional light at the runway centerline is in line with the last two lights before the runway edge (see FIG AD 1.1-9 and FIG AD 1.1-10). When activated, the red lights indicate that there is high speed traffic on the runway or there is an aircraft on final approach within the activation area.

**12.6.2.1** REL Operating Characteristics – Departing Aircraft: When a departing aircraft reaches a site adaptable speed of approximately 30 knots, all taxiway intersections with REL arrays along the runway ahead of the aircraft will illuminate (see FIG AD 1.1-9). As the aircraft approaches an REL equipped taxiway intersection, the lights at that intersection extinguish approximately 3 to 4 seconds before the aircraft reaches it. This allows controllers to apply “anticipated separation” to permit ATC to move traffic more expeditiously without compromising safety. After the aircraft is declared “airborne” by the system, all REL lights associated with this runway will extinguish.

**12.6.2.2** REL Operating Characteristics – Arriving Aircraft: When an aircraft on final approach is approximately 1 mile from the runway threshold, all sets of taxiway REL light arrays that intersect the runway illuminate. The distance is adjustable and can be configured for specific operations at particular airports. Lights extinguish at each equipped taxiway intersection approximately 3 to 4 seconds before the aircraft reaches it to apply anticipated separation until the aircraft has slowed to approximately 80 knots (site adjustable parameter). Below 80 knots, all arrays that are not within 30 seconds of the aircraft’s forward path are extinguished. Once the arriving aircraft slows to approximately 34 knots (site adjustable parameter), it is declared to be in a taxi state, and all lights extinguish.

**12.6.2.3** What a pilot would observe: A pilot at or approaching the hold line to a runway will observe RELs illuminate and extinguish in reaction to an aircraft or vehicle operating on the runway, or an arriving aircraft operating less than 1 mile from the runway threshold.

**12.6.2.4** When a pilot observes the red lights of the REL, that pilot will stop at the hold line or remain stopped. The pilot will then contact ATC for resolution if the clearance is in conflict with the lights. Should pilots note illuminated lights under circumstances when remaining clear of the runway is impractical for safety reasons (for example, aircraft is already on the runway), the crew should proceed according to their best judgment while understanding the illuminated lights indicate the runway is unsafe to enter or cross. Contact ATC at the earliest possible opportunity.

**12.6.3** Takeoff Hold Lights (THL) : The THL system is composed of flush mounted, in-pavement, unidirectional light fixtures in a double longitudinal row aligned either side of the runway centerline lighting. Fixtures are focused toward the arrival end of the runway at the “line up and wait” point. THLs extend for 1,500 feet in front of the holding aircraft starting at a point 375 feet from the departure threshold (see FIG AD 1.1-11).

Illuminated red lights provide a signal, to an aircraft in position for takeoff or rolling, that it is unsafe to takeoff because the runway is occupied or about to be occupied by another aircraft or ground vehicle. Two aircraft, or a surface vehicle and an aircraft, are required for the lights to illuminate. The departing aircraft must be in position for takeoff or beginning takeoff roll. Another aircraft or a surface vehicle must be on or about to cross the runway.

### 12.6.3.1 THL Operating Characteristics – Departing Aircraft:

THLs will illuminate for an aircraft in position for departure or departing when there is another aircraft or vehicle on the runway or about to enter the runway (see FIG AD 1.1-9.) Once that aircraft or vehicle exits the runway, the THLs extinguish. A pilot may notice lights extinguish prior to the downfield aircraft or vehicle being completely clear of the runway but still moving. Like RELs, THLs have an “anticipated separation” feature.

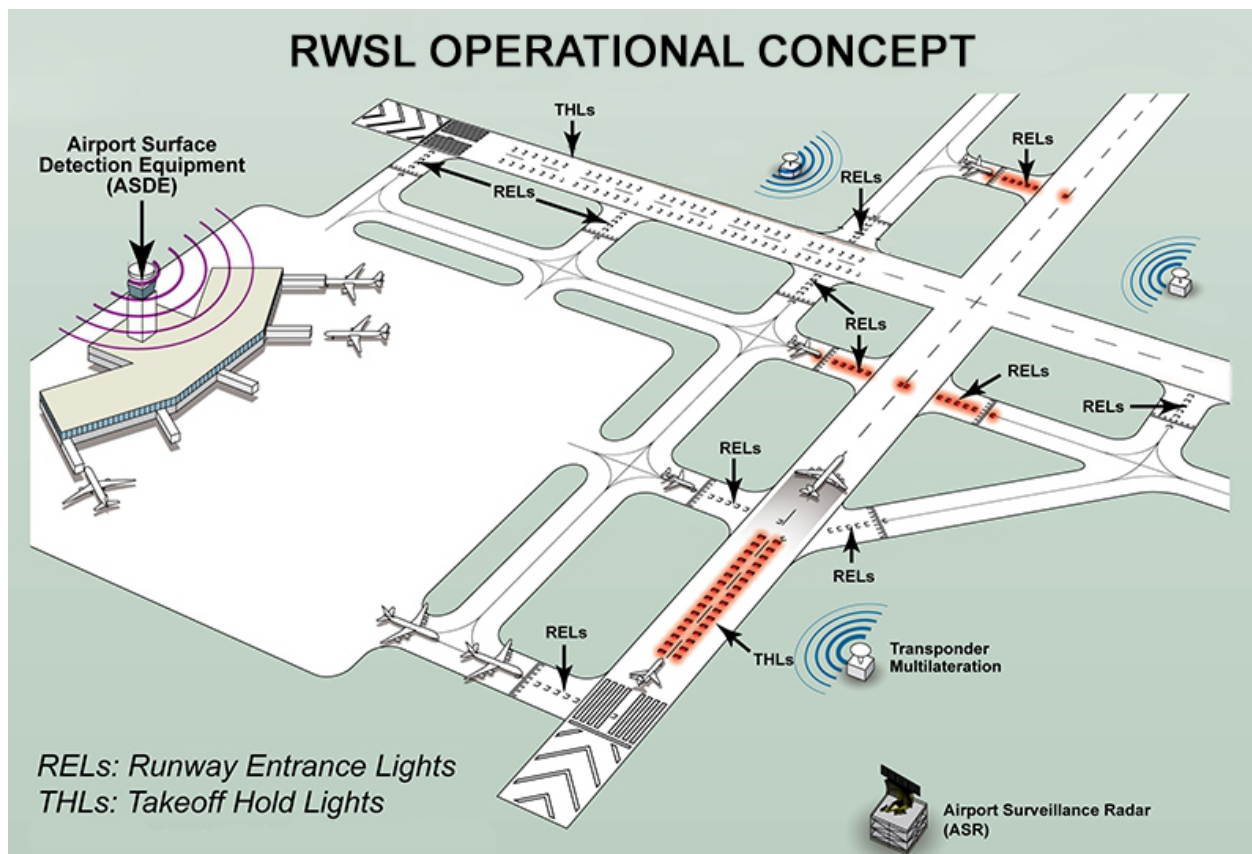
**NOTE–**

*When the THLs extinguish, this is not clearance to begin a takeoff roll. All takeoff clearances will be issued by ATC.*

**12.6.3.2** What a pilot would observe: A pilot in position to depart from a runway, or has begun takeoff roll, will observe THLs illuminate in reaction to an aircraft or vehicle on the runway or entering or crossing it. Lights will extinguish when the runway is clear. A pilot may observe several cycles of illumination and extinguishing depending on the amount of crossing traffic.

**12.6.3.3** When a pilot observes the red light of the THLs, the pilot should safely stop if it’s feasible or remain stopped. The pilot must contact ATC for resolution if any clearance is in conflict with the lights. Should pilots note illuminated lights while in takeoff roll and under circumstances when stopping is impractical for safety reasons, the crew should proceed according to their best judgment while understanding the illuminated lights indicate that continuing the takeoff is unsafe. Contact ATC at the earliest possible opportunity.

FIG AD 1.1-9  
Runway Status Light System



#### 12.6.4 Pilot Actions

**12.6.4.1** When operating at airports with RWSL, pilots will operate with the transponder/ADS-B “On” when departing the gate or parking area until it is shut down upon arrival at the gate or parking area. This ensures interaction with the FAA surveillance systems such as ASDE-X/Airport Surface Surveillance Capability (ASSC) which provide information to the RWSL system.

**12.6.4.2** Pilots must always inform the ATCT when they have stopped due to an RWSL indication that is in conflict with ATC instructions. Pilots must request clarification of the taxi or takeoff clearance.

**12.6.4.3** Never cross over illuminated red lights. Under normal circumstances, RWSL will confirm the pilot’s taxi or takeoff clearance previously issued by ATC. If RWSL indicates that it is unsafe to takeoff from, land on, cross, or enter a runway, immediately notify ATC of the conflict and re-confirm the clearance.

**12.6.4.4** Do not proceed when lights have extinguished without an ATC clearance. RWSL verifies an ATC clearance, it does not substitute for an ATC clearance.

#### 12.6.5 ATC Control of RWSL System:

**12.6.5.1** Controllers can set in-pavement lights to one of five (5) brightness levels to assure maximum conspicuity under all visibility and lighting conditions. REL and THL subsystems may be independently set.

**12.6.5.2** System lights can be disabled should RWSL operations impact the efficient movement of air traffic or contribute, in the opinion of the ATC Manager, to unsafe operations. Whenever the system or a component is disabled, a NOTAM must be issued, and the Automatic Terminal Information System (ATIS) must be updated.

### 12.7 Control of Lighting Systems

**12.7.1** Operation of approach light systems and runway lighting is controlled by the control tower (ATCT). At some locations the FSS may control the lights where there is no control tower in operation.

**12.7.2** Pilots may request that lights be turned on or off. Runway edge lights, in-pavement lights and approach lights also have intensity controls which may be varied to meet the pilot’s request. Sequenced flashing lights may be turned on and off. Some sequenced flashing system also have intensity control.

### 12.8 Pilot Control of Airport Lighting

**12.8.1** Radio control of lighting is available at selected airports to provide airborne control of lights by keying the aircraft’s microphone. Control of lighting system is often available at locations without specified hours for lighting or where there is no control tower or FSS, or when the control tower or FSS is closed (locations with a part-time tower or FSS). All lighting systems which are radio controlled at an airport, whether on a single runway or multiple runways, operate on the same radio frequency. (See TBL AD 1.1–2 and TBL AD 1.1–3.)

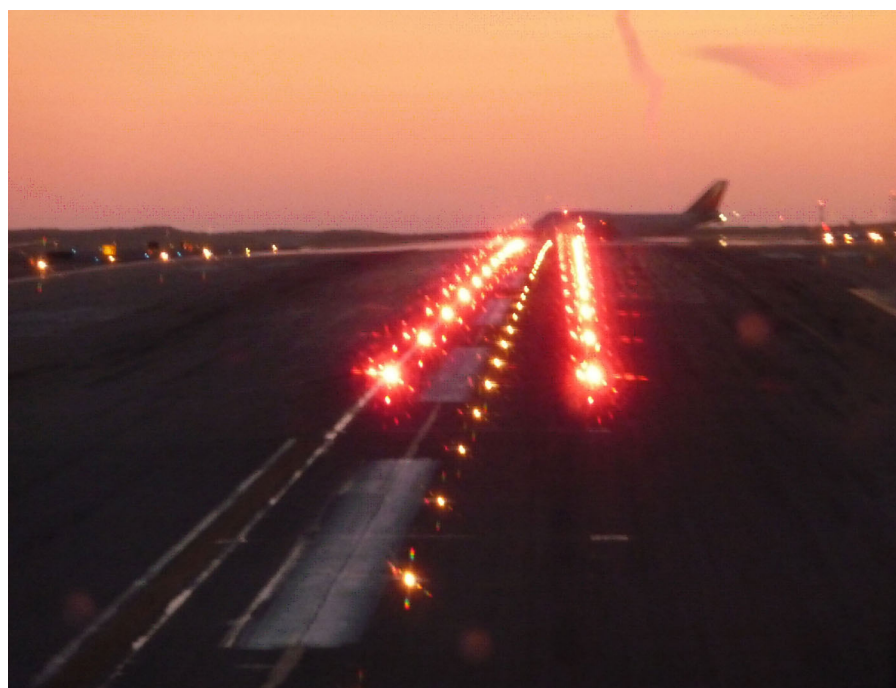
**12.8.2** With FAA approved systems, various combinations of medium intensity approach lights, runway lights, taxiway lights, VASI and/or REIL may be activated by radio control. On runways with both approach lighting and runway lighting (runway edge lights, taxiway lights, etc.) systems, the approach lighting system takes precedence for air-to-ground radio control over the runway lighting system which is set at a predetermined intensity step, based on expected visibility conditions. Runways without approach lighting may provide radio controlled intensity adjustments of runway edge lights. Other lighting systems, including VASI, REIL, and taxiway lights, may be either controlled with the runway edge lights or controlled independently of the runway edge lights.

**12.8.3** The control system consists of a 3-step control responsive to 7, 5, and/or 3 microphone clicks. This 3-step control will turn on lighting facilities capable of either 3-step, 2-step or 1-step operation. The 3-step and 2-step lighting facilities can be altered in intensity, while the 1-step cannot. All lighting is illuminated for a period of 15 minutes from the most recent time of activation and may not be extinguished prior to end of the 15-minute period (except for 1-step and 2-step REILs which may be turned off when desired by keying the mike 5 or 3 times, respectively).

**FIGAD 1.1-10**  
**Runway Entrance Lights**



**FIGAD 1.1-11**  
**Takeoff Hold Lights**



**FIG AD 1.1-12**  
**Taxiway Lead-On Light Configuration**



**TBLAD 1.1-2**  
**Runways With Approach Lights**

Lighting System	Number of Intensity Steps	Status During Nonuse Period	Intensity Step Selected Per Number of Mike Clicks		
			3 Clicks	5 Clicks	7 Clicks
Approach Lights (Med. Int.)	2	Off	Low	Low	High
Approach Lights (Med. Int.)	3	Off	Low	Med	High
MIRL	3	Off or Low	◆	◆	◆
HIRL	5	Off or Low	◆	◆	◆
VASI	2	Off	☆	☆	☆

**NOTES:** ◆Predetermined intensity step.  
☆Low intensity for night use. High intensity for day use as determined by photocell control.

*TBLAD 1.1-3*  
**Runways Without Approach Lights**

Lighting System	Number of Intensity Steps	Status During Nonuse Period	Intensity Step Selected Per Number of Mike Clicks		
			3 Clicks	5 Clicks	7 Clicks
MIRL	3	Off or Low	Low	Med.	High
HIRL	5	Off or Low	Step 1 or 2	Step 3	Step 5
LIRL	1	Off	On	On	On
VASI★	2	Off	◆	◆	◆
REIL★	1	Off	Off	On / Off	On
REIL★	3	Off	Low	Med.	High

**NOTES:** ◆Low intensity for night use. High intensity for day use as determined by photocell control.  
★The control of VASI and/or REIL may be independent of other lighting systems.

**12.8.4** Suggested use is to always initially key the mike 7 times; this assures that all controlled lights are turned on to the maximum available intensity. If desired, adjustment can then be made, where the capability is provided, to a lower intensity (or the REIL turned off) by keying 5 and/or 3 times. Due to the close proximity of airports using the same frequency, radio controlled lighting receivers may be set at a low sensitivity requiring the aircraft to be relatively close to activate the system. Consequently, even when lights are on, always key mike as directed when overflying an airport of intended landing or just prior to entering the final segment of an approach. This will assure the aircraft is close enough to activate the system and a full 15 minutes lighting duration is available. Approved lighting systems may be activated by keying the mike (within 5 seconds) as indicated in TBLAD 1.1-4.

*TBLAD 1.1-4*  
**Radio Control System**

Key Mike	Function
7 times within 5 seconds	Highest intensity available
5 times within 5 seconds	Medium or lower intensity (Lower REIL or REIL-off)
3 times within 5 seconds	Lowest intensity available (Lower REIL or REIL-off)

**12.8.5** The Chart Supplement U.S. contains the types of lighting, runway, and the frequency that is used to activate the system for all public use airports with FAA standard systems. Airports with instrument approach procedures include data on the approach chart identifying the light system(s), the runway on which they are installed, and the frequency that is used to activate the system(s).

**NOTE-**

*Although the CTAF is used to activate the lights at many airports, other frequencies may also be used. The appropriate frequency for activating the lights on the airport is provided in the Chart Supplement U.S. and the standard instrument approach procedures publications. It is not identified on the sectional charts.*

**12.8.6** Where the airport is not served by an instrument approach procedure, it may have either the standard FAA approach control system or an independent type system of different specification installed by the airport sponsor. The Chart Supplement U.S. contains descriptions of pilot-controlled lighting systems for each airport having other than FAA approved systems, and explains the type lights, method of control, and operating frequency in clear text.



### 13. Airport/Heliport Beacons

**13.1** Airport and heliport beacons have a vertical light distribution to make them most effective from one to ten degrees above the horizon; however, they can be seen well above and below this peak spread. The beacon may be an omnidirectional capacitor-discharge device, or it may rotate at a constant speed which produces the visual effect of flashes at regular intervals. Flashes may be one or two colors alternately. The total number of flashes are:

**13.1.1** 24 to 30 per minute for beacons marking airports, landmarks, and points on Federal airways.

**13.1.2** 30 to 45 per minute for beacons marking heliports.

**13.2** The colors and color combinations of beacons are:

**13.2.1** White and Green—Lighted land airport.

**13.2.2** \*Green alone—Lighted land airport.

**13.2.3** White and Yellow—Lighted water airport.

**13.2.4** \*Yellow alone—Lighted water airport.

**13.2.5** Green, Yellow, and White—Lighted heliport.

**NOTE—**

*\*Green alone or yellow alone is used only in connection with a white-and-green or white-and-yellow beacon display, respectively.*

**13.3** Military airport beacons flash alternately white and green, but are differentiated from civil beacons by dual-peaked (two quick) white flashes between the green flashes.

**13.4** In Class B, C, D, and E surface areas, operation of the airport beacon during the hours of daylight indicates that the ground visibility is less than 3 miles and/or the ceiling is less than 1,000 feet. An ATC clearance in accordance with 14 CFR Part 91 is required for landing, takeoff and flight in the traffic pattern. Pilots should not rely solely on the operation of the airport beacon to indicate if weather conditions are IFR or VFR. At locations with control towers, when controls are in the tower, ATC personnel turn the beacon on. At many airports, the airport beacon is turned on by a photoelectric cell or time clocks and ATC personnel cannot control it. There is no regulatory requirement for daylight operation, and it is the pilot's responsibility to comply with proper pre-flight planning in accordance with 14 CFR Section 91.103.

### 14. Taxiway Lights

**14.1 Taxiway Edge Lights.** Taxiway edge lights are used to outline the edges of taxiways during periods of darkness or restricted visibility conditions. These fixtures emit blue light.

**NOTE—**

*At most major airports these lights have variable intensity settings and may be adjusted at pilot request or when deemed necessary by the controller.*

**14.2 Taxiway Centerline Lights.** Taxiway centerline lights are used to facilitate ground traffic under low visibility conditions. They are located along the taxiway centerline in a straight line on straight portions, on the centerline of curved portions, and along designated taxiing paths in portions of runways, ramps, and apron areas. Taxiway centerline lights are steady burning and emit green light.

**14.3 Clearance Bar Lights.** Clearance bar lights are installed at holding positions on taxiways in order to increase the conspicuity of the holding position in low visibility conditions. They may also be installed to indicate the location of an intersecting taxiway during periods of darkness. Clearance bars consist of three in-pavement, steady-burning yellow lights.

**14.4 Runway Guard Lights.** Runway guard lights are installed at taxiway/runway intersections. They are primarily used to enhance the conspicuity of taxiway/runway intersections during low visibility conditions, but

may be used in all weather conditions. Runway guard lights consist of either a pair of elevated flashing yellow lights installed on either side of the taxiway, or a row of in-pavement yellow lights installed across the entire taxiway, at the runway holding position marking.

**NOTE-**

*Some airports may have a row of three or five in-pavement yellow lights installed at taxiway/runway intersections. They should not be confused with clearance bar lights described in paragraph 14.3 above.*

**14.5 Stop Bar Lights.** Stop bar lights, when installed, are used to confirm the ATC clearance to enter or cross the active runway in low visibility conditions (below 1,200 feet Runway Visual Range). A stop bar consists of a row of red, unidirectional, steady-burning in-pavement lights installed across the entire taxiway at the runway holding position, and elevated steady-burning red lights on each side. A controlled stop bar is operated in conjunction with the taxiway centerline lead-on lights which extend from the stop bar toward the runway. Following the ATC clearance to proceed, the stop bar is turned off and the lead-on lights are turned on. The stop bar and lead-on lights are automatically reset by a sensor or backup timer.

**CAUTION-**

*Pilots should never cross a red illuminated stop bar, even if an ATC clearance has been given to proceed onto or across the runway.*

**NOTE-**

*If after crossing a stop bar, the taxiway centerline lead-on lights inadvertently extinguish, pilots should hold their position and contact ATC for further instructions.*

## **15. Air Navigation and Obstruction Lighting**

### **15.1 Aeronautical Light Beacons**

**15.1.1** An aeronautical light beacon is a visual NAVAID displaying flashes of white and/or colored light to indicate the location of an airport, a heliport, a landmark, a certain point of a Federal airway in mountainous terrain, or an obstruction. The light used may be a rotating beacon or one or more flashing lights. The flashing lights may be supplemented by steady burning lights of lesser intensity.

**15.1.2** The color or color combination display by a particular beacon and/or its auxiliary lights tell whether the beacon is indicating a landing place, landmark, point of the Federal airways, or an obstruction. Coded flashes of the auxiliary lights, if employed, further identify the beacon site.

### **15.2 Code Beacons and Course Lights**

**15.2.1 Code Beacons.** The code beacon, which can be seen from all directions, is used to identify airports and landmarks. The code beacon flashes the three- or four-character airport identifier in International Morse Code six to eight times per minute. Green flashes are displayed for land airports while yellow flashes indicate water airports.

**15.2.2 Course Lights.** The course light, which can be seen clearly from only one direction, is used only with rotating beacons of the Federal Airway System; two course lights, back to back, direct coded flashing beams of light in either direction along the course of airway.

**NOTE-**

*Airway beacons are remnants of the "lighted" airways which antedated the present electronically equipped federal airways system. Only a few of those beacons exist today to mark airway segments in remote mountain areas. Flashes in Morse code identify the beacon site.*

### **15.3 Obstruction Lights**

**15.3.1** Obstructions are marked/lighted to warn airmen of their presence during daytime and nighttime conditions. They may be marked/lighted in any of the following combinations:

**15.3.1.1 Aviation Red Obstruction Lights.** Flashing aviation red beacons (20 to 40 flashes per minute) and steady burning aviation red lights during nighttime operation. Aviation orange and white paint is used for daytime marking.

**15.3.1.2 Medium Intensity Flashing White Obstruction Lights.** Medium intensity flashing white obstruction lights may be used during daytime and twilight with automatically selected reduced intensity for nighttime operation. When this system is used on structures 500 feet (153 m) AGL or less in height, other methods of marking and lighting the structure may be omitted. Aviation orange and white paint is always required for daytime marking on structures exceeding 500 feet (153 m) AGL. This system is not normally installed on structures less than 200 feet (61 m) AGL.

**15.3.1.3 High Intensity White Obstruction Lights.** Flashing high intensity white lights during daytime with reduced intensity for twilight and nighttime operation. When this type system is used, the marking of structures with red obstruction lights and aviation orange and white paint may be omitted.

**15.3.1.4 Dual Lighting.** A combination of flashing aviation red beacons and steady burning aviation red lights for nighttime operation and flashing high intensity white lights for daytime operation. Aviation orange and white paint may be omitted.

**15.3.1.5 Catenary Lighting.** Lighted markers are available for increased night conspicuity of high-voltage (69KV or higher) transmission line catenary wires. Lighted markers provide conspicuity both day and night.

**15.3.2** Medium intensity omnidirectional flashing white lighting system provides conspicuity both day and night on catenary support structures. The unique sequential/simultaneous flashing light system alerts pilots of the associated catenary wires.

**15.3.3** High intensity flashing white lights are being used to identify some supporting structures of overhead transmission lines located across rivers, chasms, gorges, etc. These lights flash in a middle, top, lower light sequence at approximately 60 flashes per minute. The top light is normally installed near the top of the supporting structure, while the lower light indicates the approximate lower portion of the wire span. The lights are beamed towards the companion structure and identify the area of the wire span.

**15.3.4** High intensity flashing white lights are also employed to identify tall structures, such as chimneys and towers, and obstructions to air navigation. The lights provide a 360 degree coverage about the structure at 40 flashes per minute and consist of from one to seven levels of lights depending upon the height of the structure. Where more than one level is used, the vertical banks flash simultaneously.

## **15.4 LED Lighting Systems**

**15.4.1** Certain light-emitting diode (LED) lighting systems fall outside the combined visible and near-infrared spectrum of night vision goggles (NVGs) and thus will not be visible to a flightcrew using NVGs.

**15.4.2** The FAA changed specifications for LED-based red obstruction lights to make them visible to pilots using certain NVG systems, however, other colors may not be visible.

**15.4.3** It is recommended that air carriers/operators—including Part 91 operators—who utilize NVGs incorporate procedures into manuals and/or standard operating procedures (SOPs) requiring periodic, unaided scanning when operating at low altitudes and when performing a reconnaissance of landing areas.

## **16. Runway Lead-in Light System (RLLS)**

**16.1** The lead-in lighting system consists of a series of flashing lights installed at or near ground level to describe the desired course to a runway or final approach. Each group of lights is positioned and aimed so as to be conveniently sighted and followed from the approaching aircraft under conditions at or above approach minimums under consideration. The system may be curved, straight, or combination thereof, as required. The lead-in lighting system may be terminated at any approved approach lighting system, or it may be terminated at a distance from the landing threshold which is compatible with authorized visibility minimums permitting visual reference to the runway environment.

**16.2** The outer portion uses groups of lights to mark segments of the approach path beginning at a point within easy visual range of a final approach fix. These groups are spaced close enough together (approximately one mile) to give continuous lead-in guidance. A group consists of at least three flashing lights in a linear or cluster

configuration and may be augmented by steady burning lights where required. When practicable, groups flash in sequence toward runways. Each system is designed to suit local conditions and to provide the visual guidance intended. The design of all RLLS is compatible with the requirements of U.S. Standards for Terminal Instrument Procedures (TERPS) where such procedures are applied for establishing instrument minimums.

## 17. Airport Marking Aids and Signs

### 17.1 General

**17.1.1** Airport pavement markings and signs provide information that is useful to a pilot during takeoff, landing, and taxiing.

**17.1.2** Uniformity in airport markings and signs from one airport to another enhances safety and improves efficiency. Pilots are encouraged to work with the operators of the airports they use to achieve the marking and sign standards described in this section.

**17.1.3** Pilots who encounter ineffective, incorrect, or confusing markings or signs on an airport should make the operator of the airport aware of the problem. These situations may also be reported under the Aviation Safety Reporting Program as described in ENR 1.16. Pilots may also report these situations to the FAA regional airports division.

**17.1.4** The markings and signs described in this section reflect the current FAA recommended standards.

#### REFERENCE–

AC 150/5340–1, *Standards for Airport Markings.*

AC 150/5340–18, *Standards for Airport Sign Systems.*

### 17.2 Airport Pavement Markings

**17.2.1 General.** For the purpose of this section, the airport pavement markings have been grouped into the four areas:

**17.2.1.1** Runway Markings.

**17.2.1.2** Taxiway Markings.

**17.2.1.3** Holding Position Markings.

**17.2.1.4** Other Markings.

**17.2.2 Marking Colors.** Markings for runways are white. Markings defining the landing area on a heliport are also white except for hospital heliports which use a red “H” on a white cross. Markings for taxiways, areas not intended for use by aircraft (closed and hazardous areas), and holding positions (even if they are on a runway) are yellow.

### 17.3 Runway Markings

**17.3.1 General.** There are three types of markings for runways: visual, nonprecision instrument, and precision instrument. TBL AD 1.1–5 identifies the marking elements for each type of runway, and TBL AD 1.1–6 identifies runway threshold markings.

**17.3.2 Runway Designators.** Runway numbers and letters are determined from the approach direction. The runway number is the whole number nearest one–tenth the magnetic azimuth of the centerline of the runway, measured clockwise from the magnetic north. The letters differentiate between left (L), right (R), or center (C) parallel runways, as applicable:

**17.3.2.1** For two parallel runways “L” “R.”

**17.3.2.2** For three parallel runways “L” “C” “R.”

**17.3.3 Runway Centerline Marking.** The runway centerline identifies the center of the runway and provides alignment guidance during takeoff and landing. The centerline consists of a line of uniformly spaced stripes and gaps.

**17.3.4 Runway Aiming Point Marking.** The aiming point marking serves as a visual aiming point for a landing aircraft. These two rectangular markings consist of a broad white stripe located on each side of the runway centerline and approximately 1,000 feet from the landing threshold, as shown in FIG AD 1.1–13, Precision Instrument Runway Markings.

**17.3.5 Runway Touchdown Zone Markers.** The touchdown zone markings identify the touchdown zone for landing operations and are coded to provide distance information in 500 feet (150 m) increments. These markings consist of groups of one, two, and three rectangular bars symmetrically arranged in pairs about the runway centerline as shown in FIG AD 1.1–13. For runways having touchdown zone markings on both ends, those pairs of markings which extend to within 900 feet (270 m) of the midpoint between the thresholds are eliminated.

*TBLAD 1.1–5*  
**Runway Marking Elements**

Marking Element	Visual Runway	Nonprecision Instrument Runway	Precision Instrument Runway
Designation	X	X	X
Centerline	X	X	X
Threshold	X <sup>1</sup>	X	X
Aiming Point	X <sup>2</sup>	X	X
Touchdown Zone			X
Side Stripes			X

<sup>1</sup>On runways used, or intended to be used, by international commercial transports.  
<sup>2</sup>On runways 4,000 feet (1200 m) or longer used by jet aircraft.

*TBLAD 1.1–6*  
**Number of Runway Threshold Stripes**

Runway Width	Number of Stripes
60 feet (18 m)	4
75 feet (23 m)	6
100 feet (30 m)	8
150 feet (45 m)	12
200 feet (60 m)	16

**17.3.6 Runway Side Stripe Marking.** Runway side stripes delineate the edges of the runway. They provide a visual contrast between the runway and the abutting terrain or shoulders. Side stripes consist of continuous white stripes located on each side of the runway. (See FIG AD 1.1–17.)

**17.3.7 Runway Shoulder Markings.** Runway shoulder stripes may be used to supplement runway side stripes to identify pavement areas contiguous to the runway sides that are not intended for use by aircraft. Runway shoulder stripes are yellow. (See FIG AD 1.1–15.)

**17.3.8 Runway Threshold Markings.** Runway threshold markings come in two configurations. They consist of either eight longitudinal stripes of uniform dimensions disposed symmetrically about the runway centerline (as shown in FIG AD 1.1–13) or the number of stripes is related to the runway width as indicated in TBLAD 1.1–6. A threshold marking helps identify the beginning of the runway that is available for landing. In some instances, the landing threshold may be relocated or displaced.

**17.3.8.1 Relocation of a Threshold.** Sometimes construction, maintenance, or other activities require the threshold to be relocated towards the rollout end of the runway. (See FIG AD 1.1–16.) When a threshold is relocated, it closes not only a set portion of the approach end of a runway, but also shortens the length of the opposite direction runway. In these cases, a NOTAM should be issued by the airport operator identifying the

portion of the runway that is closed (for example, 10/28 W 900 CLSD). Because the duration of the relocation can vary from a few hours to several months, methods identifying the new threshold may vary. One common practice is to use a ten-foot wide white threshold bar across the width of the runway. Although the runway lights in the area between the old threshold and new threshold will not be illuminated, the runway markings in this area may or may not be obliterated, removed, or covered.

**17.3.8.2 Displaced Threshold.** A displaced threshold is a threshold located at a point on the runway other than the designated beginning of the runway. Displacement of a threshold reduces the length of runway available for landings. The portion of runway behind a displaced threshold is available for takeoffs in either direction and landings from the opposite direction. A ten-foot wide white threshold bar is located across the width of the runway at the displaced threshold. White arrows are located along the centerline in the area between the beginning of the runway and displaced threshold. White arrowheads are located across the width of the runway just prior to the threshold bar, as shown in FIG AD 1.1–17.

**NOTE–**

*Airport operator. When reporting the relocation or displacement of a threshold, the airport operator should avoid language which confuses the two.*

**17.3.9 Demarcation Bar.** A demarcation bar delineates a runway with a displaced threshold from a blast pad, stopway, or taxiway that precedes the runway. A demarcation bar is 3 feet (1 m) wide and yellow, since it is not located on the runway. (See FIG AD 1.1–18.)

**17.3.10 Chevrons.** These markings are used to show pavement areas aligned with the runway that are unusable for landing, takeoff, and taxiing. Chevrons are yellow. (See FIG AD 1.1–19.)

**17.3.11 Runway Threshold Bar.** A threshold bar delineates the beginning of the runway that is available for landing when the threshold has been relocated or displaced. A threshold bar is 10 feet (3 m) in width and extends across the width of the runway, as shown in FIG AD 1.1–17.

## 18. Taxiway Markings

**18.1 General.** All taxiways should have centerline markings and runway holding position markings whenever they intersect a runway. Taxiway edge markings are present whenever there is a need to separate the taxiway from a pavement that is not intended for aircraft use or to delineate the edge of the taxiway. Taxiways may also have shoulder markings and holding position markings for Instrument Landing System (ILS) critical areas and taxiway/taxiway intersection markings.

**REFERENCE–**

*AD 1.1, Paragraph 19. Holding Position Markings.*

### 18.2 Taxiway Centerline.

**18.2.1 Normal Centerline.** The taxiway centerline is a single continuous yellow line, 6 inches (15 cm) to 12 inches (30 cm) in width. This provides a visual cue to permit taxiing along a designated path. Ideally, the aircraft should be kept centered over this line during taxi. However, being centered on the taxiway centerline does not guarantee wingtip clearance with other aircraft or other objects.

**18.2.2 Enhanced Centerline.** At some airports, mostly the larger commercial service airports, an enhanced taxiway centerline will be used. The enhanced taxiway centerline marking consists of a parallel line of yellow dashes on either side of the normal taxiway centerline. The taxiway centerlines are enhanced for a maximum of 150 feet prior to a runway holding position marking. The purpose of this enhancement is to warn the pilot that he/she is approaching a runway holding position marking and should prepare to stop unless he/she has been cleared onto or across the runway by ATC. (See FIG AD 1.1–20.)

**18.3 Taxiway Edge Markings.** Taxiway edge markings are used to define the edge of the taxiway. They are primarily used when the taxiway edge does not correspond with the edge of the pavement. There are two types of markings depending upon whether the aircraft is supposed to cross the taxiway edge:

**18.3.1 Continuous Markings.** These consist of a continuous double yellow line, with each line being at least 6 inches (15 cm) in width spaced 6 inches (15 cm) apart. They are used to define the taxiway edge from the shoulder or some other abutting paved surface not intended for use by aircraft.

**18.3.2 Dashed Markings.** These markings are used when there is an operational need to define the edge of a taxiway or taxilane on a paved surface where the adjoining pavement to the taxiway edge is intended for use by aircraft (for example, an apron). Dashed taxiway edge markings consist of a broken double yellow line, with each line being at least 6 inches (15 cm) in width, spaced 6 inches (15 cm) apart (edge to edge). These lines are 15 feet (4.5 m) in length with 25-foot (7.5 m) gaps. (See FIG AD 1.1–21.)

**18.4 Taxi Shoulder Markings.** Taxiways, holding bays, and aprons are sometimes provided with paved shoulders to prevent blast and water erosion. Although shoulders may have the appearance of full strength pavement, they are not intended for use by aircraft and may be unable to support an aircraft. Usually the taxiway edge marking will define this area. Where conditions exist such as islands or taxiway curves that may cause confusion as to which side of the edge stripe is for use by aircraft, taxiway shoulder markings may be used to indicate the pavement is unusable. Taxiway shoulder markings are yellow. (See FIG AD 1.1–22.)

**18.5 Surface Painted Taxiway Direction Signs.** Surface painted taxiway direction signs have a yellow background with a black inscription. These signs are provided when it is not possible to provide taxiway direction signs at intersections or when it is necessary to supplement such signs. These markings are located adjacent to the centerline with signs indicating turns to the left being on the left side of the taxiway centerline, and signs indicating turns to the right being on the right side of the centerline. (See FIG AD 1.1–23.)

**18.6 Surface Painted Location Signs.** Surface painted location signs have a black background with a yellow inscription. When necessary, these markings are used to supplement location signs located along side the taxiway and assist the pilot in confirming the designation of the taxiway on which the aircraft is located. These markings are located on the right side of the centerline. (See FIG AD 1.1–23.)

**18.7 Geographic Position Markings.** These markings are located at points along low visibility taxi routes designated in the airport’s Surface Movement Guidance Control System (SMGCS) plan. They are used to identify the location of taxiing aircraft during low visibility operations. Low visibility operations are those that occur when the runway visible range (RVR) is below 1,200 feet (360 m). They are positioned to the left of the taxiway centerline in the direction of taxiing. (See FIG AD 1.1–24.) The geographic position marking is a circle comprised of an outer black ring contiguous to a white ring with a pink circle in the middle. When installed on asphalt or other dark-colored pavements, the white ring and the black ring are reversed (i.e., the white ring becomes the outer ring and the black ring becomes the inner ring). It is designated with either a number or a number and letter. The number corresponds to the consecutive position of the marking on the route.

## 19. Holding Position Markings

**19.1 Runway Holding Position Markings.** For runways, these markings indicate where aircraft **MUST STOP** when approaching a runway. They consist of four yellow lines, two solid and two dashed, spaced six or twelve inches apart, and extending across the width of the taxiway or runway. The solid lines are always on the side where the aircraft must hold. There are three locations where runway holding position markings are encountered.

**19.1.1 Runway Holding Position Markings on Taxiways.** These markings identify the locations on a taxiway where aircraft **MUST STOP** when a clearance has not been issued to proceed onto the runway. Generally, runway holding position markings also identify the boundary of the runway safety area (RSA) for aircraft exiting the runway. Runway holding position markings are shown in FIG AD 1.1–25 and FIG AD 1.1–28. When instructed by ATC, “*Hold short of Runway XX,*” the pilot **MUST STOP** so that no part of the aircraft extends beyond the runway holding position marking. When approaching runways at airports with an operating control tower, pilots must not cross the runway holding position marking without ATC clearance. Pilots approaching runways at airports without an operating control tower must ensure adequate separation from other aircraft, vehicles, and pedestrians prior to crossing the holding position markings. An aircraft exiting a runway is not clear of the runway until all parts of the aircraft have crossed the applicable holding position marking.

### **NOTE–**

*Runway holding position markings identify the beginning of an RSA, and a pilot **MUST STOP** to get clearance before crossing (at airports with operating control towers).*

**REFERENCE–**

*ENR 1.1, Paragraph 23, Exiting the Runway After Landing.*

**19.1.2 Runway Holding Position Markings on Runways.** These markings identify the locations on runways where aircraft MUST STOP. These markings are located on runways used by ATC for Land And Hold Short Operations (for example, see FIG ENR 1.1–8) and Taxiing operations. For taxiing operations, the pilot MUST STOP prior to the holding position markings unless explicitly authorized to cross by ATC. A sign with a white inscription on a red background is located adjacent to these holding position markings. (See FIG AD 1.1–26.) The holding position markings are placed on runways prior to the intersection with another runway, or some designated point. Pilots receiving and accepting instructions “*Cleared to land Runway XX, hold short of Runway YY*” from ATC must either exit Runway XX prior to the holding position markings, or stop at the holding position markings prior to Runway YY. Otherwise, pilots are authorized to use the entire landing length of the runway and disregard the holding position markings.

**19.1.3 Holding Position Markings on Taxiways Located in Runway Approach Areas.** These markings are used at some airports where it is necessary to hold an aircraft on a taxiway located in the approach or departure area of a runway so that the aircraft does not interfere with the operations on that runway. This marking is collocated with the runway approach/departure area holding position sign. When specifically instructed by ATC, “*Hold short of Runway XX approach or Runway XX departure area,*” the pilot MUST STOP so that no part of the aircraft extends beyond the holding position marking. (See Paragraph 21.2.2, Runway Approach Area Holding Position Sign, and FIG AD 1.1–27, Taxiways Located in Runway Approach Area.)

**19.2 Holding Position Markings for Instrument Landing System (ILS).** Holding position markings for ILS critical areas consist of two yellow solid lines spaced two feet apart connected by pairs of solid lines spaced ten feet apart extending across the width of the taxiway as shown in FIG AD 1.1–28. A sign with an inscription in white on a red background is located adjacent to these hold position markings. When instructed by ATC to hold short of the ILS critical area, pilots MUST STOP so that no part of the aircraft extends beyond the holding position marking. When approaching the holding position marking, pilots must not cross the marking without ATC clearance. The ILS critical area is not clear until all parts of the aircraft have crossed the applicable holding position marking.

**REFERENCE–**

*ENR 4.1, Paragraph 6, Instrument Landing System (ILS).*

**19.3 Holding Position Markings for Intersecting Taxiways** Holding position markings for intersecting taxiways consist of a single dashed line extending across the width of the taxiway as shown in FIG AD 1.1–29. They are located on taxiways where ATC holds aircraft short of a taxiway intersection. When instructed by ATC, “*Hold short of Taxiway XX,*” the pilot MUST STOP so that no part of the aircraft extends beyond the holding position marking. When the marking is not present, the pilot MUST STOP the aircraft at a point which provides adequate clearance from an aircraft on the intersecting taxiway.

**19.4 Surface Painted Holding Position Signs.** Surface painted holding position signs have a red background with a white inscription and supplement the signs located at the holding position. This type of marking is normally used where the width of the holding position on the taxiway is greater than 200 feet (60 m). It is located to the left side of the taxiway centerline on the holding side and prior to the holding position marking. (See FIG AD 1.1–23.)

## **20. Other Markings**

**20.1 Vehicle Roadway Markings.** The vehicle roadway markings are used when necessary to define a pathway for vehicle operations on or crossing areas that are also intended for aircraft. These markings consist of a white solid line to delineate each edge of the roadway and a dashed line to separate lanes within the edges of the roadway. In lieu of the solid lines, zipper markings may be used to delineate the edges of the vehicle roadway. (See FIG AD 1.1–30.) Details of the zipper markings are shown in FIG AD 1.1–31.

**20.2 VOR Receiver Checkpoint Markings.** The VOR receiver checkpoint marking allows the pilot to check aircraft instruments with navigational aid signals. It consists of a painted circle with an arrow in the middle; the



arrow is aligned in the direction of the checkpoint azimuth. This marking, and an associated sign, is located on the airport apron or taxiway at a point selected for easy access by aircraft but where other airport traffic is not to be unduly obstructed. (See FIG AD 1.1–32.)

**NOTE–**

*The associated sign contains the VOR station identification letter and course selected (published) for the check, the words “VOR check course,” and DME data (when applicable). The color of the letters and numerals are black on a yellow background.*

**EXAMPLE–**

VOR SIGN

DCA 176–356

VOR check course

DME XXX

### **20.3 Nonmovement Area Boundary Markings.**

These markings delineate the movement area; i.e., area under ATC. These markings are yellow and located on the boundary between the movement and nonmovement area. The nonmovement area boundary markings consist of two yellow lines (one solid and one dashed) 6 inches (15 cm) in width. The solid line is located on the nonmovement area side, while the dashed yellow line is located on the movement area side. The nonmovement boundary marking area is shown in FIG AD 1.1–33.

**20.4 Marking and Lighting of Permanently Closed Runways and Taxiways.** For runways and taxiways which are permanently closed, the lighting circuits will be disconnected. The runway threshold, runway designation, and touchdown markings are obliterated and yellow crosses are placed at each end of the runway and at 1,000 foot intervals. (See FIG AD 1.1–34.)

**20.5 Temporarily Closed Runways and Taxiways.** To provide a visual indication to pilots that a runway is temporarily closed, crosses are placed on the runway only at each end of the runway. The crosses are yellow in color. (See FIG AD 1.1–34.)

**20.5.1** A raised lighted yellow cross may be placed on each runway end in lieu of the markings described in paragraph 20.5 to indicate the runway is closed.

**20.5.2** A visual indication may not be present depending on the reason for the closure, duration of the closure, airfield configuration, and the existence and the hours of operation of an airport traffic control tower. Pilots should check NOTAMs and the Automated Terminal Information System (ATIS) for local runway and taxiway closure information.

**20.5.3** Temporarily closed taxiways are usually treated as hazardous areas, in which no part of an aircraft may enter, and are blocked with barricades. However, as an alternative, a yellow cross may be installed at each entrance to the taxiway.

**20.6 Helicopter Landing Areas.** The markings illustrated in FIG AD 1.1–35 are used to identify the landing and takeoff area at a public use heliport and hospital heliport. The letter “H” in the markings is oriented to align with the intended direction of approach. FIG AD 1.1–35 also depicts the markings for a closed airport.

**20.7 Airport Signs.** There are six types of signs installed on airfields: mandatory instruction signs, location signs, direction signs, destination signs, information signs, and runway distance remaining signs. The characteristics and use of these signs are discussed below.

**REFERENCE–**

*Advisory Circular–150/5340–18, Standards for Airport Sign Systems.*

## **21. Mandatory Instruction Signs**

**21.1** These signs have a red background with a white inscription and are used to denote:

**21.1.1** An entrance to a runway or critical area.

**21.1.2** Areas where an aircraft is prohibited from entering.

## 21.2 Typical mandatory signs and applications are:

**21.2.1 Runway Holding Position Sign.** This sign is located at the holding position on taxiways that intersect a runway or on runways that intersect other runways. The inscription on the sign contains the designation of the intersecting runway, as shown in FIG AD 1.1–36. The runway numbers on the sign are arranged to correspond to the respective runway threshold. For example, “15–33” indicates that the threshold for Runway 15 is to the left and the threshold for Runway 33 is to the right.

**21.2.1.1** On taxiways that intersect the beginning of the takeoff runway, only the designation of the takeoff runway may appear on the sign (as shown in FIG AD 1.1–37) while all other signs will have the designation of both runway directions.

**21.2.1.2** If the sign is located on a taxiway that intersects the intersection of two runways, the designations for both runways will be shown on the sign along with arrows showing the approximate alignment of each runway, as shown in FIG AD 1.1–38. In addition to showing the approximate runway alignment, the arrow indicates the direction to the threshold of the runway whose designation is immediately next to the arrow.

**21.2.2 Runway Approach Area Holding Position Sign.** At some airports, it is necessary to hold an aircraft on a taxiway located in the approach or departure area for a runway so that the aircraft does not interfere with operations on that runway. In these situations, a sign with the designation of the approach end of the runway followed by a “dash” (–) and letters “APCH” will be located at the holding position on the taxiway. Holding position markings in accordance with Paragraph 19. Holding Position Markings, will be located on the taxiway pavement. An example of this sign is shown in FIG AD 1.1–39. In this example, the sign may protect the approach to Runway 15 and/or the departure for Runway 33.

**21.2.3 ILS Critical Area Holding Position Sign.** At some airports, when the instrument landing system is being used, it is necessary to hold an aircraft on a taxiway at a location other than the holding position described in Paragraph 19. Holding Position Markings. In these situations, the holding position sign for these operations will have the inscription “ILS” and be located adjacent to the holding position marking on the taxiway described in paragraph 19. An example of this sign is shown in FIG AD 1.1–40.

**21.2.4 No Entry Sign.** This sign, shown in FIG AD 1.1–41, prohibits an aircraft from entering an area. Typically, this sign would be located on a taxiway intended to be used in only one direction or at the intersection of vehicle roadways with runways, taxiways or aprons where the roadway may be mistaken as a taxiway or other aircraft movement surface.

### **NOTE–**

*Holding position signs provide the pilot with a visual cue as to the location of the holding position marking.*

### **REFERENCE–**

*AD 1.1, Paragraph 19. Holding Position Markings.*

## 22. Location Signs

Location signs are used to identify either a taxiway or runway on which the aircraft is located. Other location signs provide a visual cue to pilots to assist them in determining when they have exited an area. The various location signs are described below.

**22.1 Taxiway Location Sign.** This sign has a black background with a yellow inscription and yellow border, as shown in FIG AD 1.1–42. The inscription is the designation of the taxiway on which the aircraft is located. These signs are installed along taxiways either by themselves or in conjunction with direction signs or runway holding position signs. (See FIG AD 1.1–43 and FIG AD 1.1–47.)

**22.2 Runway Location Sign.** This sign has a black background with a yellow inscription and yellow border, as shown in FIG AD 1.1–44. The inscription is the designation of the runway on which the aircraft is located. These signs are intended to complement the information available to pilots through their magnetic compass and typically are installed where the proximity of two or more runways to one another could cause pilots to be confused as to which runway they are on.

**22.3 Runway Boundary Sign.** This sign has a yellow background with a black inscription with a graphic depicting the pavement holding position marking, as shown in FIG AD 1.1–45. This sign, which faces the runway and is visible to the pilot exiting the runway, is located adjacent to the holding position marking on the pavement. The sign is intended to provide pilots with another visual cue which they can use as a guide in deciding when they are “clear of the runway.”

**22.4 ILS Critical Area Boundary Sign.** This sign has a yellow background with a black inscription with a graphic depicting the ILS pavement holding position marking, as shown in FIG AD 1.1–46. This sign is located adjacent to the ILS holding position marking on the pavement and can be seen by pilots leaving the critical area. The sign is intended to provide pilots with another visual cue which they can use as a guide in deciding when they are “clear of the ILS critical area.”

## 23. Direction Signs

**23.1** Direction signs have a yellow background with a black inscription. The inscription identifies the designation(s) of the intersecting taxiway(s) leading out of intersection that a pilot would normally be expected to turn onto or hold short of. Each designation is accompanied by an arrow indicating the direction of the turn.

**23.2** Except as noted in subparagraph 23.5, each taxiway designation shown on the sign is accompanied by only one arrow. When more than one taxiway designation is shown on the sign, each designation and its associated arrow is separated from the other taxiway designations by either a vertical message divider or a taxiway location sign as shown in FIG AD 1.1–47.

**23.3** Direction signs are normally located on the left prior to the intersection. When used on a runway to indicate an exit, the sign is located on the same side of the runway as the exit. FIG AD 1.1–48 shows a direction sign used to indicate a runway exit.

**23.4** The taxiway designations and their associated arrows on the sign are arranged clockwise starting from the first taxiway on the pilot’s left. (See FIG AD 1.1–47.)

**23.5** If a location sign is located with the direction signs, it is placed so that the designations for all turns to the left will be to the left of the location sign; the designations for continuing straight ahead or for all turns to the right would be located to the right of the location sign. (See FIG AD 1.1–47.)

**23.6** When the intersection is comprised of only one crossing taxiway, it is permissible to have two arrows associated with the crossing taxiway, as shown in FIG AD 1.1–49. In this case, the location sign is located to the left of the direction sign.

## 24. Destination Signs

**24.1** Destination signs also have a yellow background with a black inscription indicating a destination on the airport. These signs always have an arrow showing the direction of the taxiing route to that destination. FIG AD 1.1–50 is an example of a typical destination sign. When the arrow on the destination sign indicates a turn, the sign is located prior to the intersection.

**24.2** Destinations commonly shown on these types of signs include runways, aprons, terminals, military areas, civil aviation areas, cargo areas, international areas, and fixed base operators. An abbreviation may be used as the inscription on the sign for some of these destinations.

**24.3** When the inscription for two or more destinations having a common taxiing route are placed on a sign, the destinations are separated by a “dot” (●) and one arrow would be used, as shown in FIG AD 1.1–51. When the inscription on a sign contains two or more destinations having different taxiing routes, each destination will be accompanied by an arrow and will be separated from the other destinations on the sign with a vertical black message divider as shown in FIG AD 1.1–52.

## 25. Information Signs

**25.1** Information signs have a yellow background with a black inscription. They are used to provide the pilot with information on such things as areas that cannot be seen from the control tower, applicable radio frequencies, and noise abatement procedures. The airport operator determines the need, size, and location for these signs.

## 26. Runway Distance Remaining Signs

**26.1** Runway distance remaining signs have a black background with a white numeral inscription and may be installed along one or both side(s) of the runway. The number on the signs indicates the distance (in thousands of feet) of landing runway remaining. The last sign (i.e., the sign with the numeral “1”) will be located at least 950 feet from the runway end. FIG AD 1.1–53 shows an example of a runway distance remaining sign.

## 27. Aircraft Arresting Systems

**27.1** Certain airports are equipped with a means of rapidly stopping military aircraft on a runway. This equipment, normally referred to as EMERGENCY ARRESTING GEAR, generally consists of pendant cables supported over the runway surface by rubber “donuts.” Although most devices are located in the overrun areas, a few of these arresting systems have cables stretched over the operational areas near the ends of a runway.

**27.2** Arresting cables which cross over a runway require special markings on the runway to identify the cable location. These markings consist of 10 feet diameter solid circles painted “identification yellow,” 30 feet on center, perpendicular to the runway centerline across the entire runway width. Additional details are contained in AC 150/5220–9, Aircraft Arresting Systems for Joint Civil/Military Airports.

**NOTE–**

*Aircraft operations on the runway are not restricted by the installation of aircraft arresting devices.*

**27.3 Engineered Materials Arresting Systems (EMAS).** EMAS, which is constructed of high energy–absorbing materials of selected strength, is located in the safety area beyond the end of the runway. EMAS will be marked with yellow chevrons. EMAS is designed to crush under the weight of commercial aircraft and will exert deceleration forces on the landing gear. These systems do not affect the normal landing and takeoff of airplanes. More information concerning EMAS is in FAA Advisory Circular AC 150/5220–22, Engineered Materials Arresting Systems (EMAS) for Aircraft Overruns. (See FIG AD 1.1–54.)

**NOTE–**

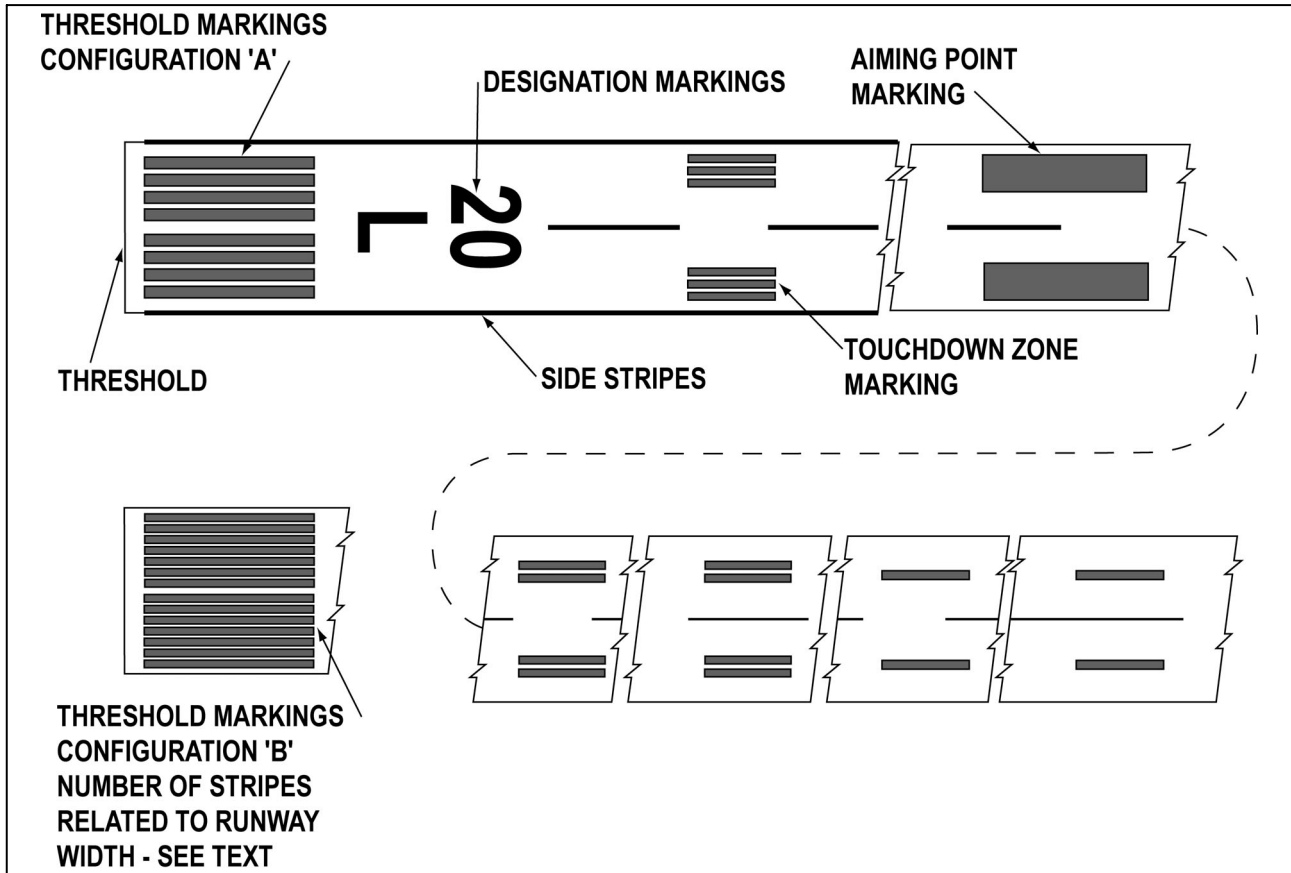
*EMAS may be located as close as 35 feet beyond the end of the runway. Aircraft and ground vehicles should never taxi or drive across the EMAS or beyond the end of the runway if EMAS is present.*

## 28. Security Identification Display Area (SIDA)

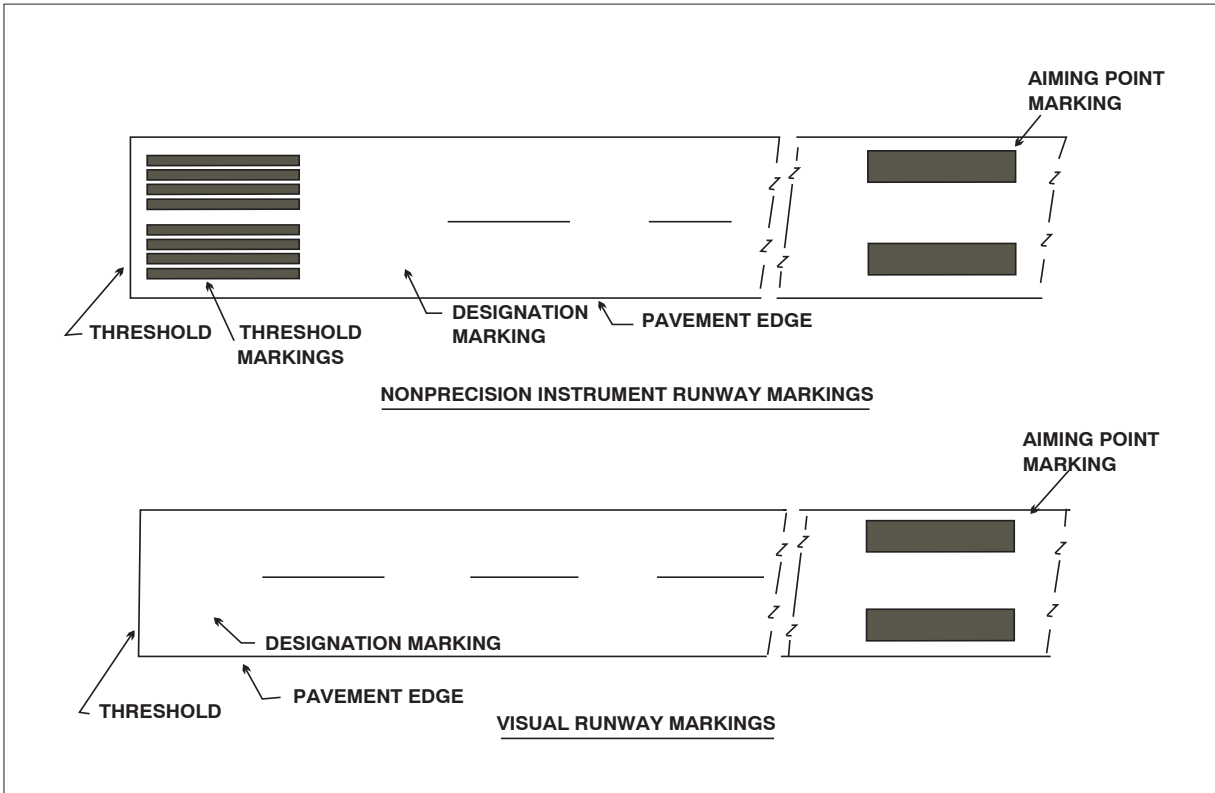
**28.1** Security Identification Display Areas (SIDA) are limited access areas that require a badge issued in accordance with procedures in 49 CFR Part 1542. A SIDA can include the Air Operations Area (AOA), e.g., aircraft movement area or parking area, or a Secured Area, such as where commercial passengers enplane. The AOA may not be a SIDA, but a Secured Area is always a SIDA. Movement through or into a SIDA is prohibited without authorization and proper identification being displayed. If you are unsure of the location of a SIDA, contact the airport authority for additional information. Airports that have a SIDA will have a description and map detailing boundaries and pertinent features available. (See FIG AD 1.1–55.)

**28.2** Pilots or passengers without proper identification that are observed entering a SIDA may be reported to the Transportation Security Administration (TSA) or airport security and may be subject to civil and criminal fines and prosecution. Pilots are advised to brief passengers accordingly. Report suspicious activity to the TSA by calling AOPA’s Airport Watch Program, 866–427–3287. 49 CFR 1540 requires each individual who holds an airman certificate, medical certificate, authorization, or license issued by the FAA to present it for inspection upon a request from TSA.

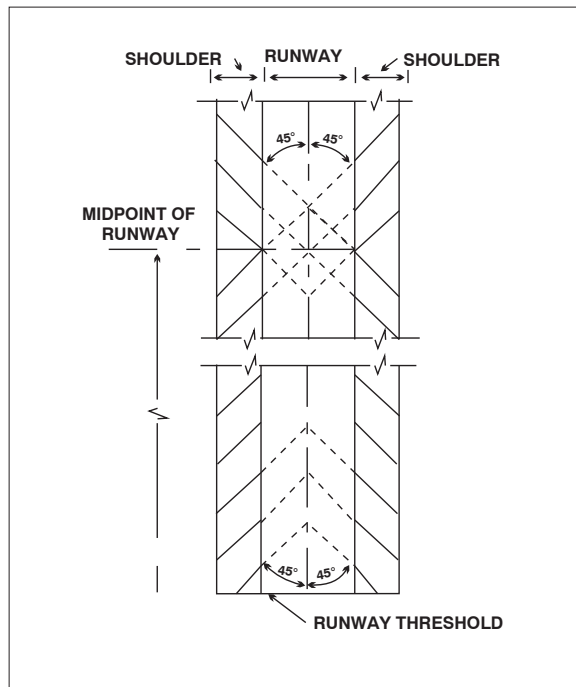
FIG AD 1.1-13  
Precision Instrument Runway Markings



**FIG AD 1.1-14**  
**Nonprecision Instrument Runway and Visual Runway Markings**



**FIG AD 1.1-15**  
**Runway Shoulder Markings**



*FIG AD 1.1-16*  
**Relocation of a Threshold with Markings for Taxiway Aligned with Runway**

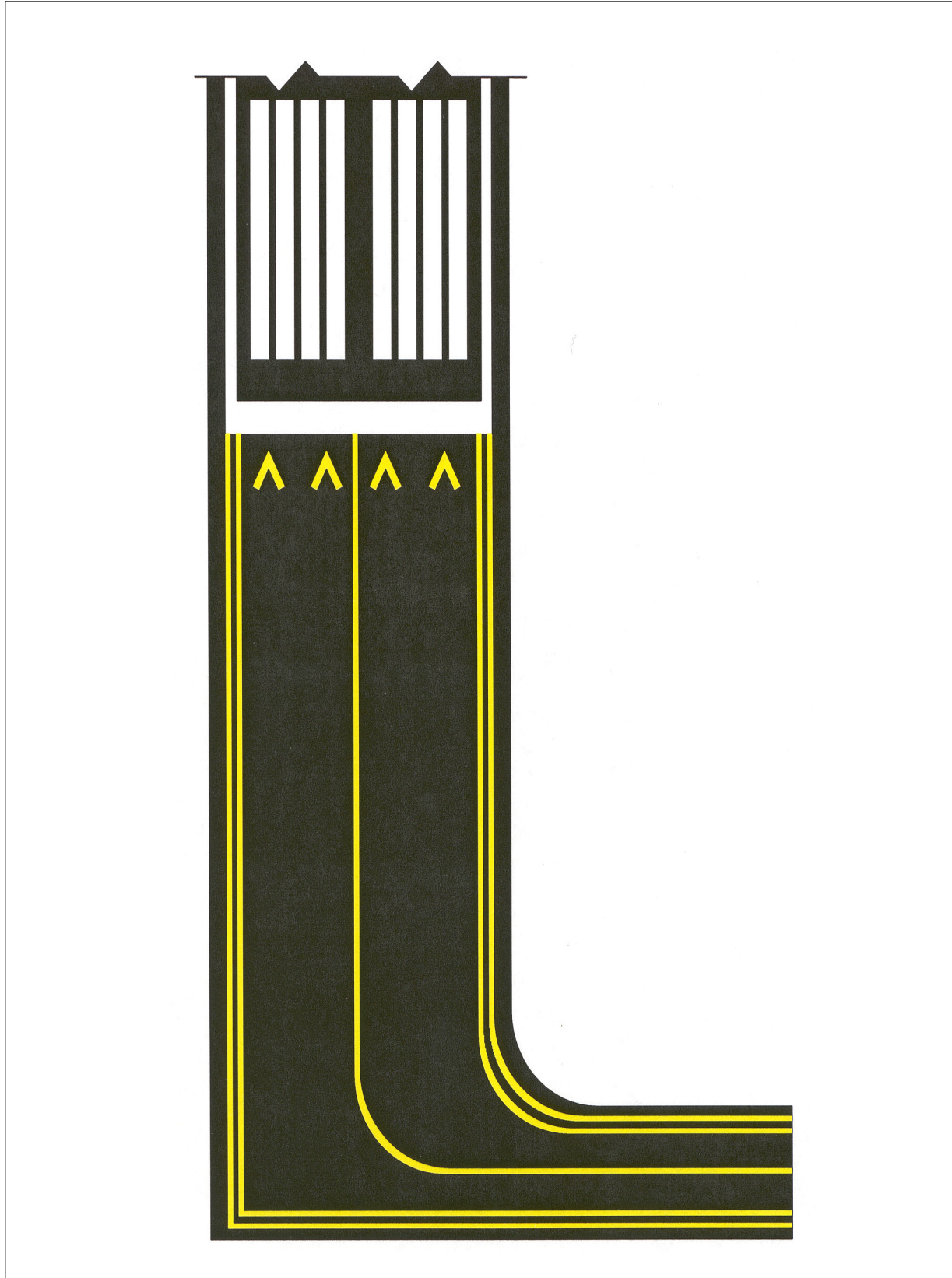


FIG AD 1.1-17  
Displaced Threshold Markings

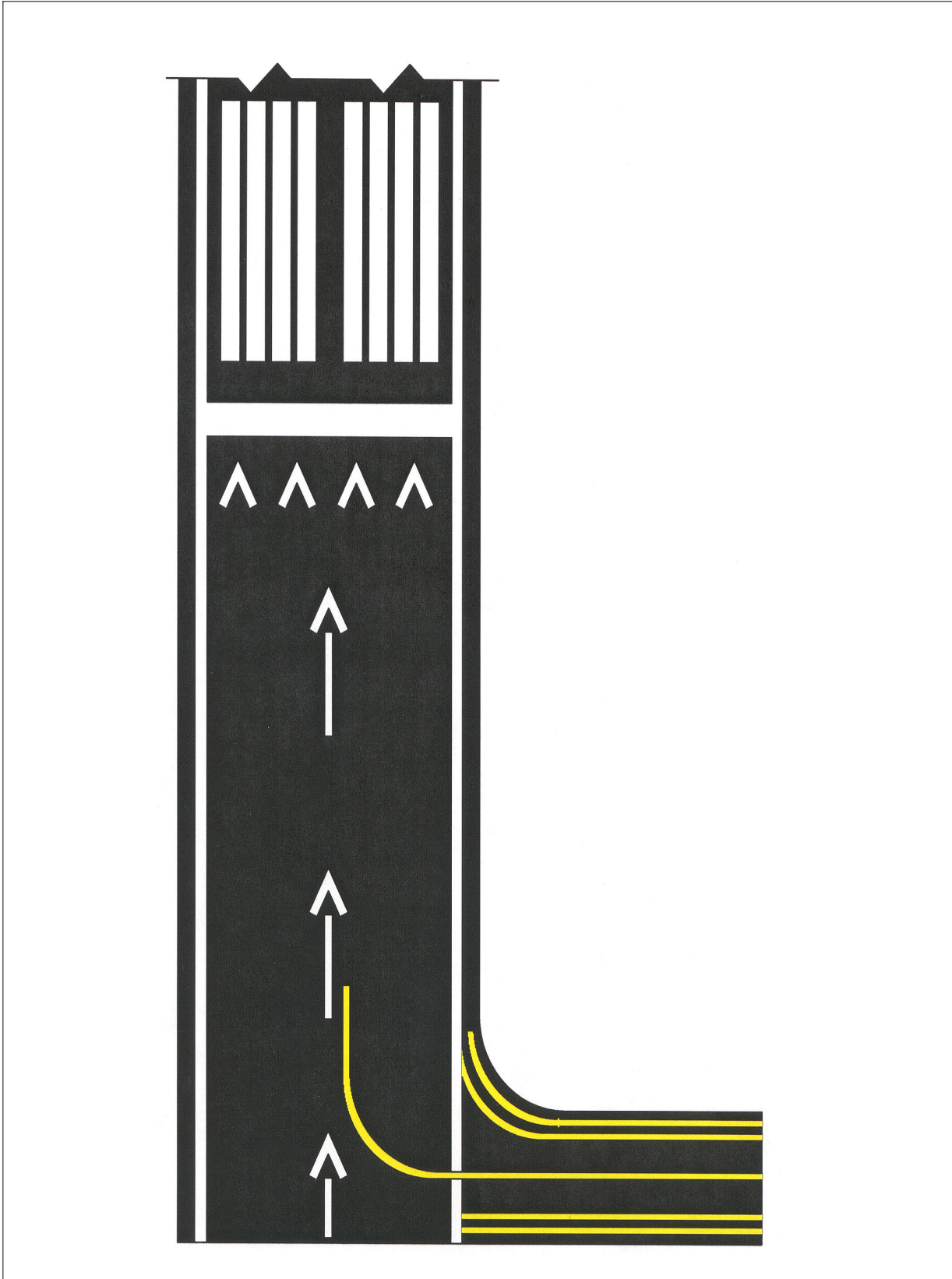




FIG AD 1.1-18  
Markings for Blast Pad or Stopway or Taxiway Preceding a Displaced Threshold

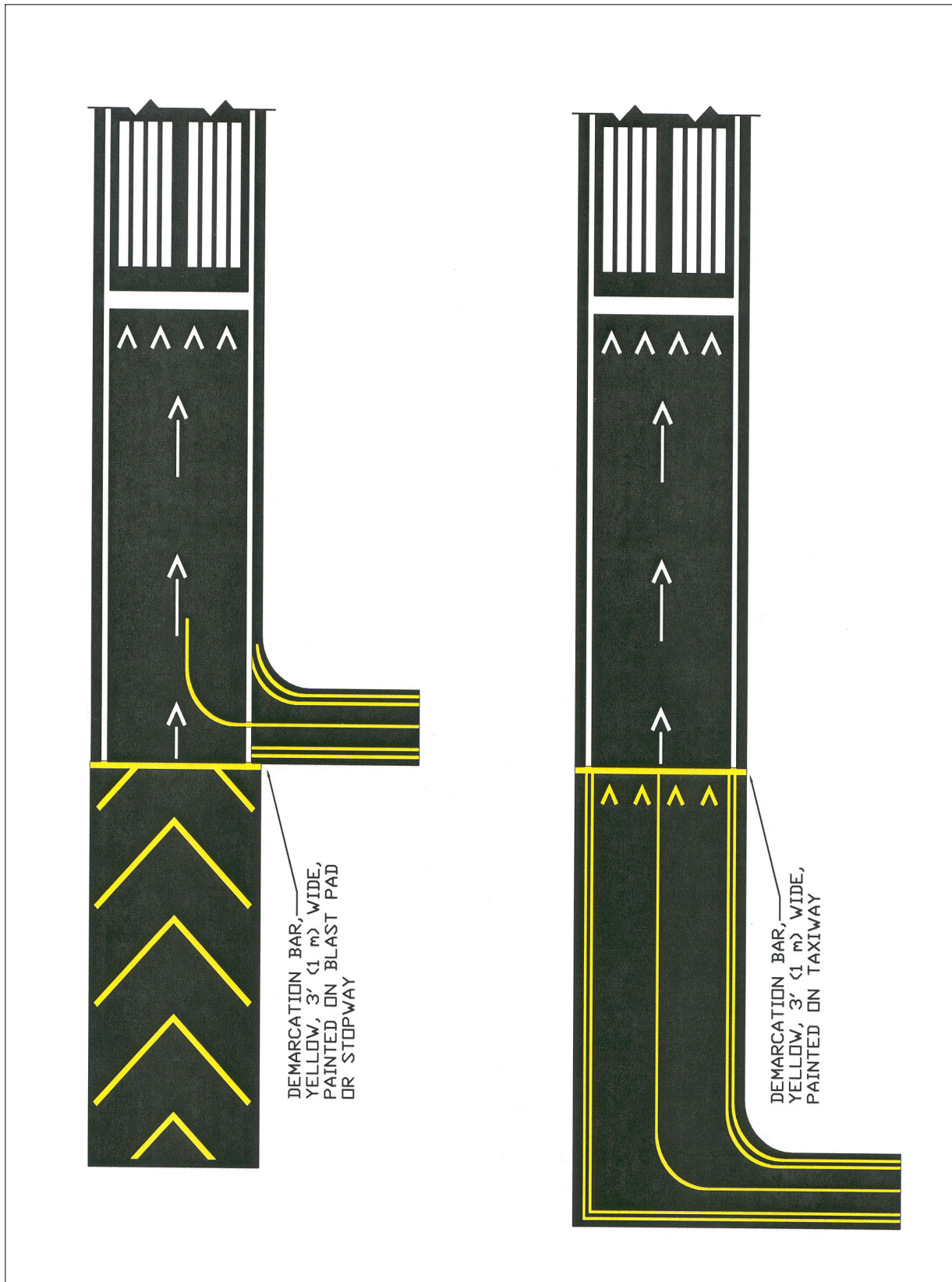
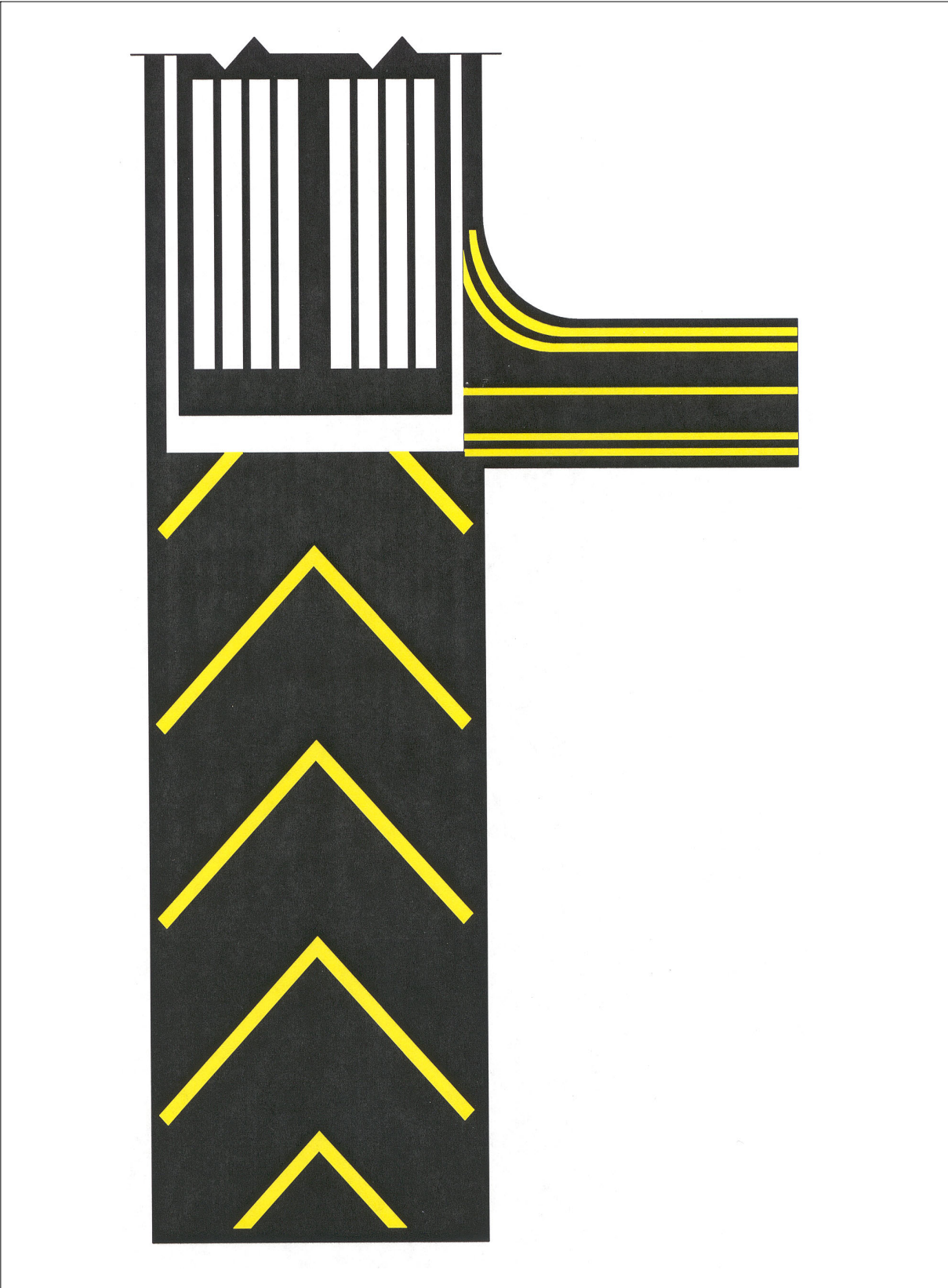
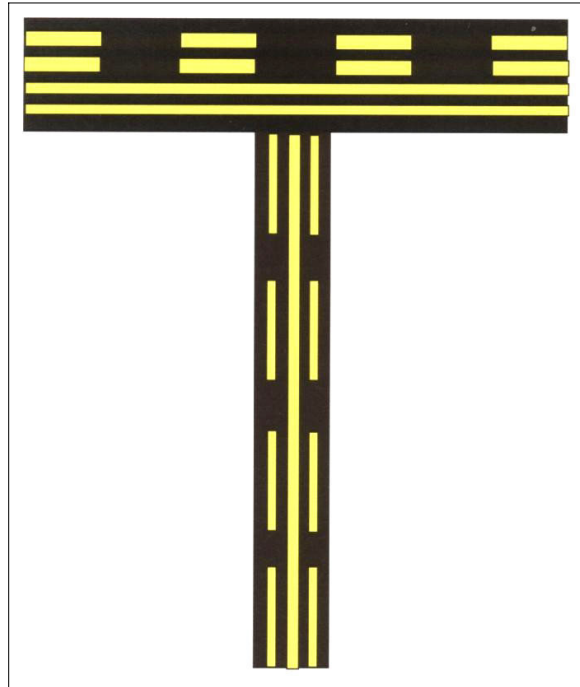


FIG AD 1.1-19  
Markings for Blast Pads and Stopways



**FIG AD 1.1-20**  
**Enhanced Taxiway Centerline**



**FIG AD 1.1-21**  
**Dashed Markings**

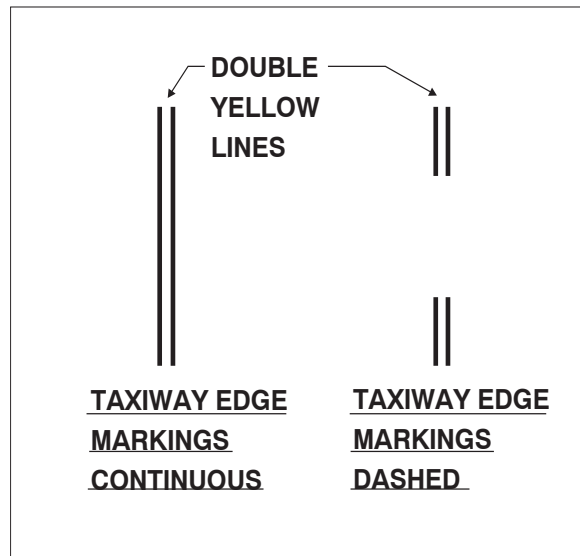


FIG AD 1.1-22  
Taxi Shoulder Markings

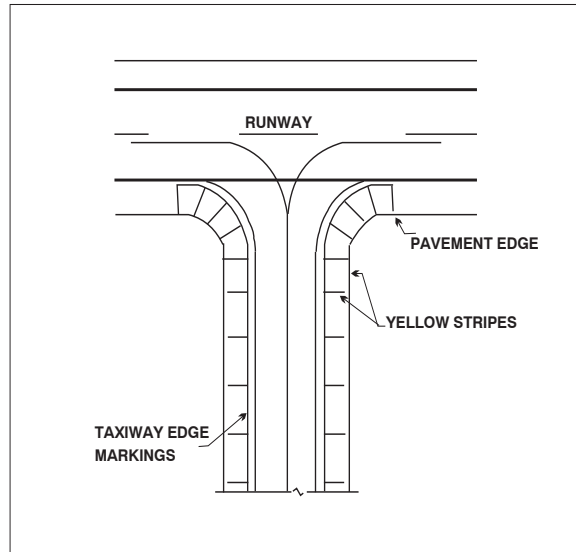


FIG AD 1.1-23  
Surface Painted Signs

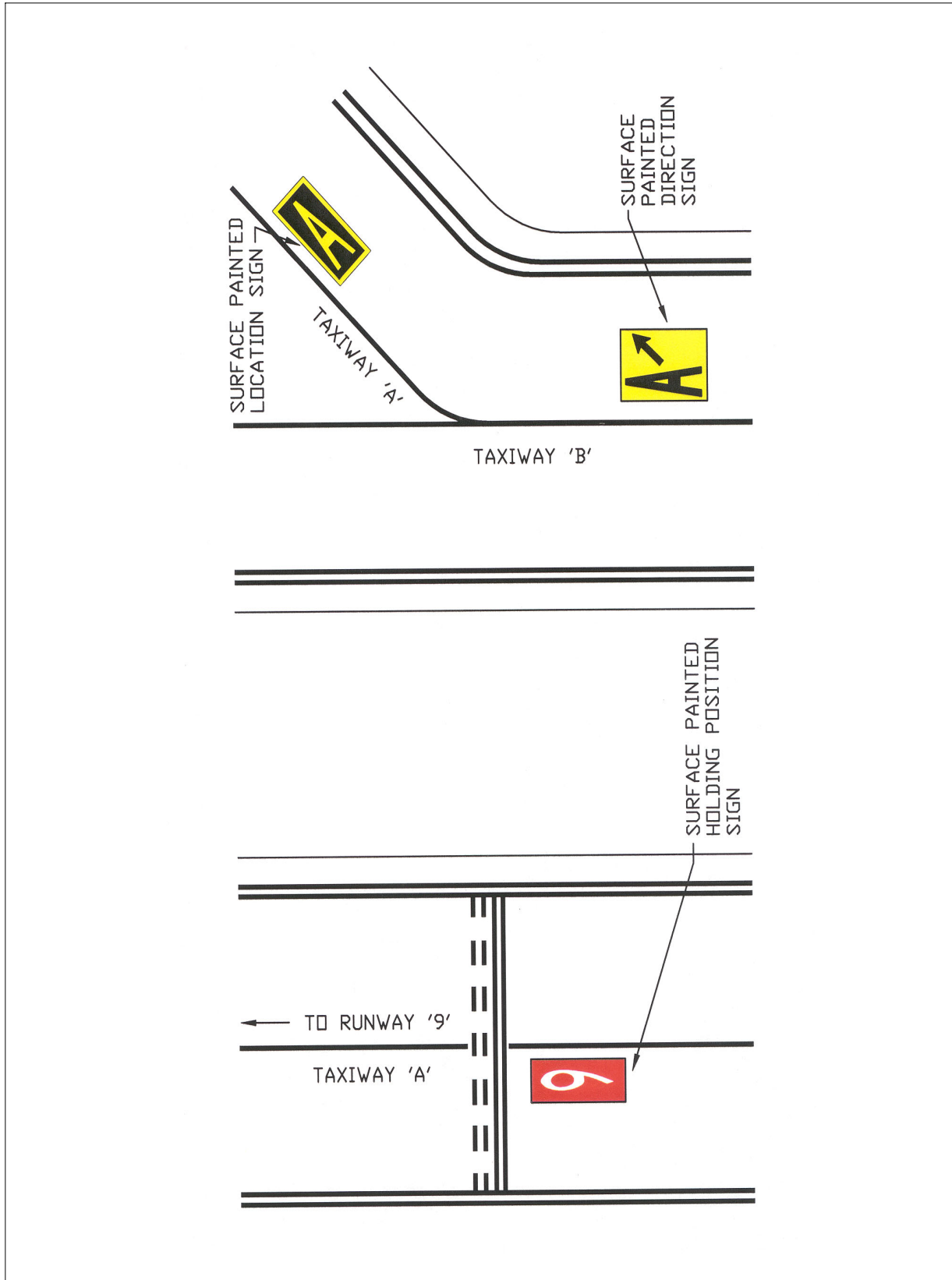


FIG AD 1.1-24  
Geographic Position Markings

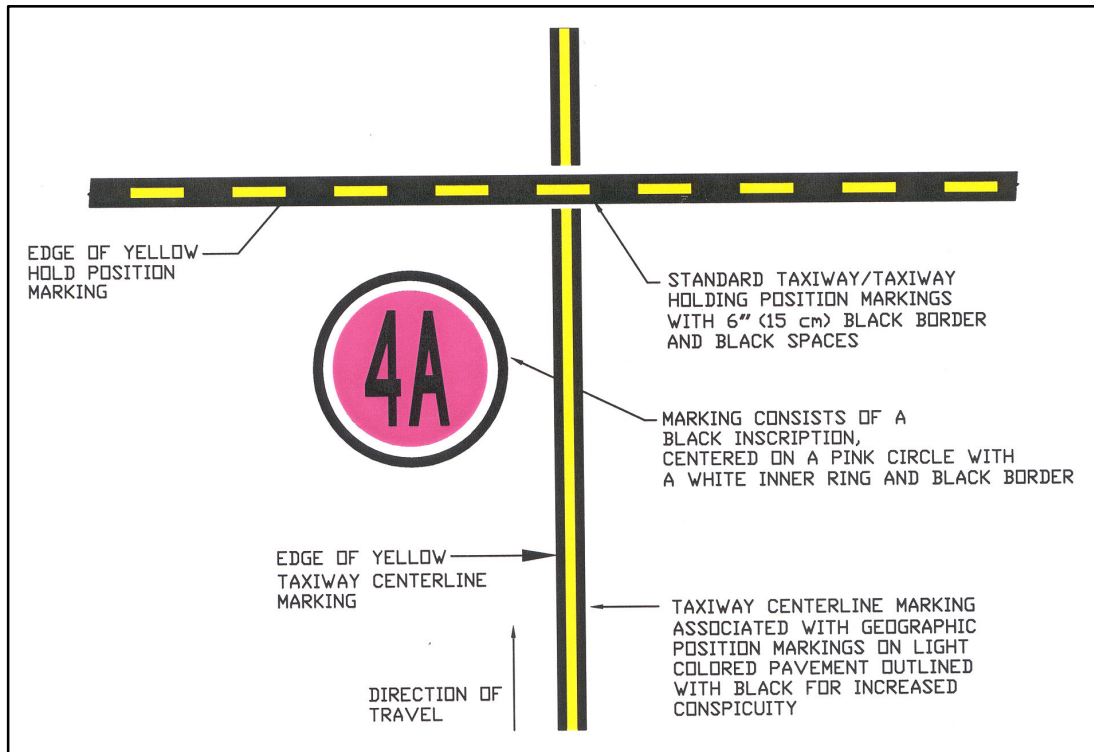


FIG AD 1.1-25  
Runway Holding Position Markings on Taxiway

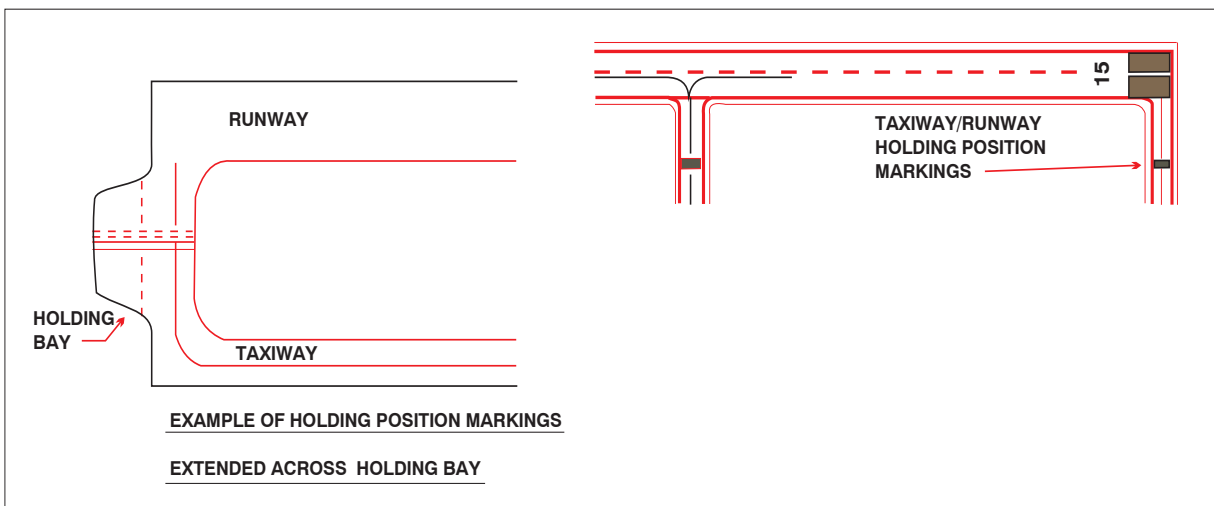


FIG AD 1.1-26  
Runway Holding Position Markings on Runways

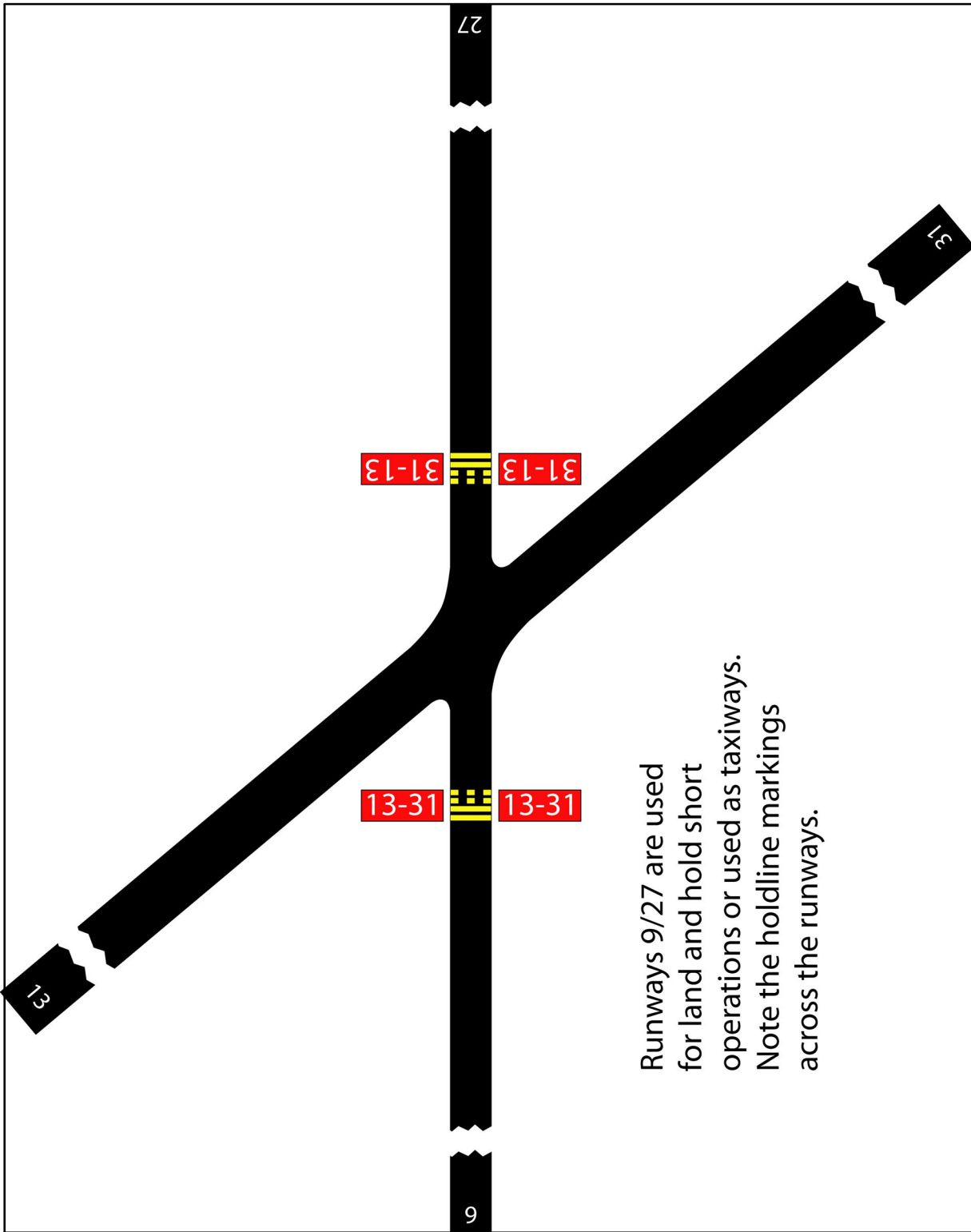


FIG AD 1.1-27  
Taxiways Located in Runway Approach Area

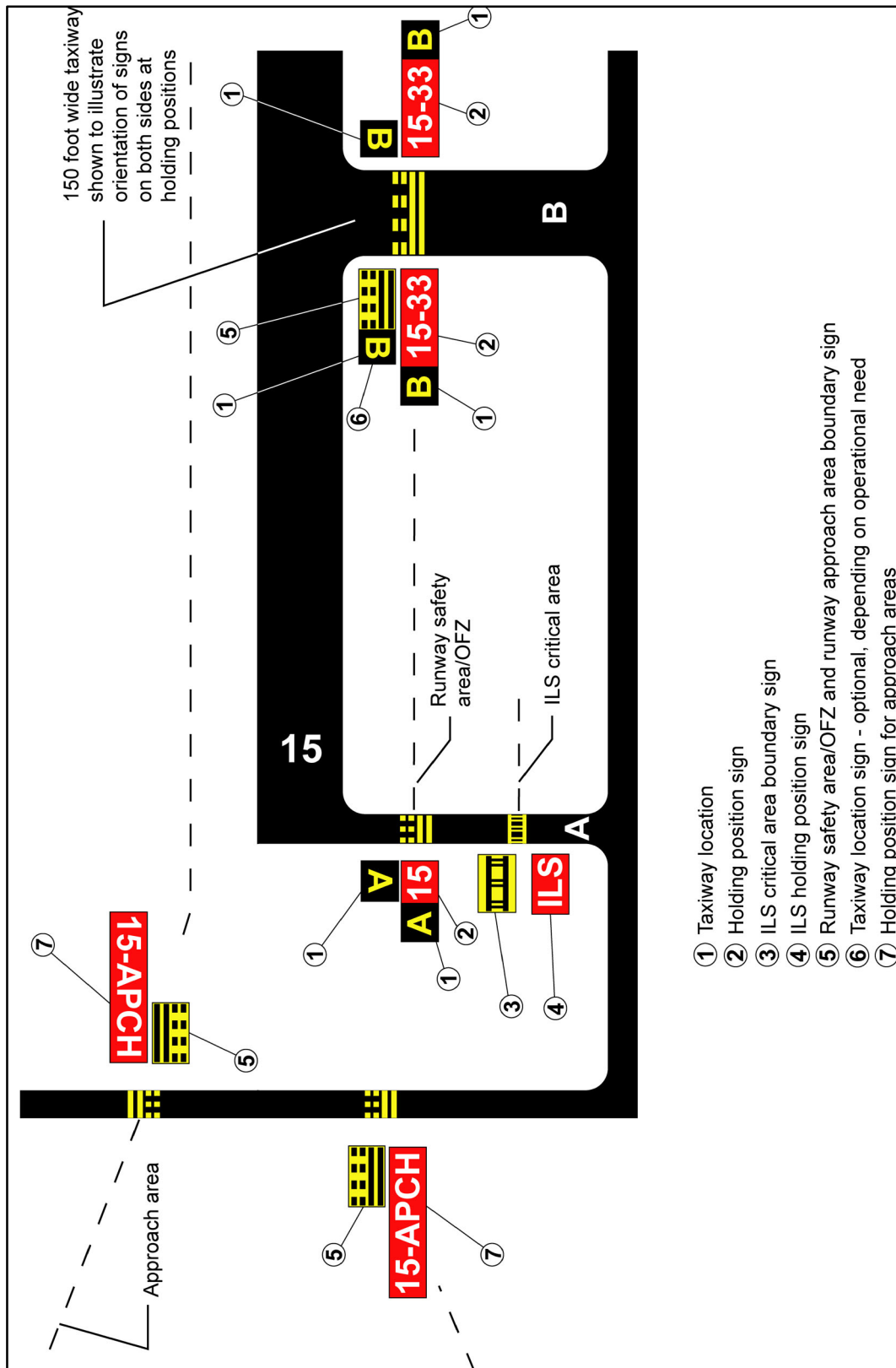




FIG AD 1.1-28  
Holding Position Markings: ILS Critical Area

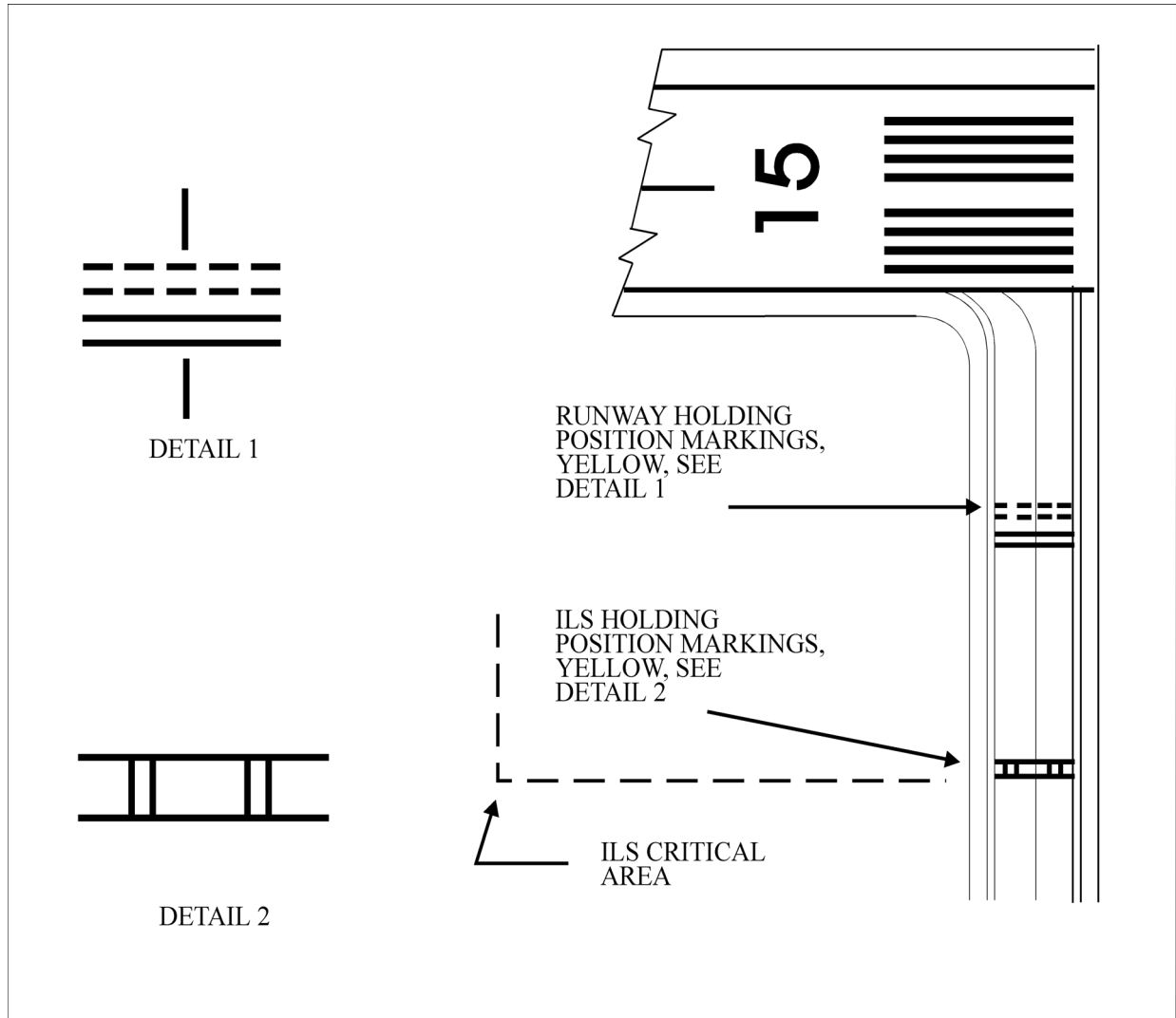


FIG AD 1.1-29  
Holding Position Markings: Taxiway/Taxiway Intersections

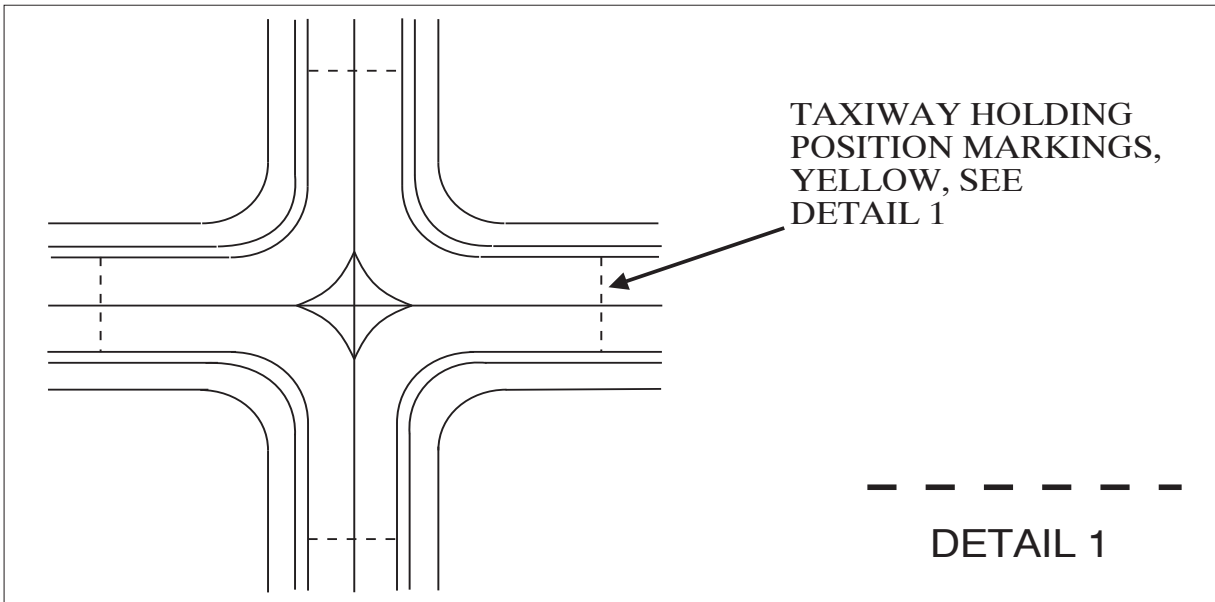
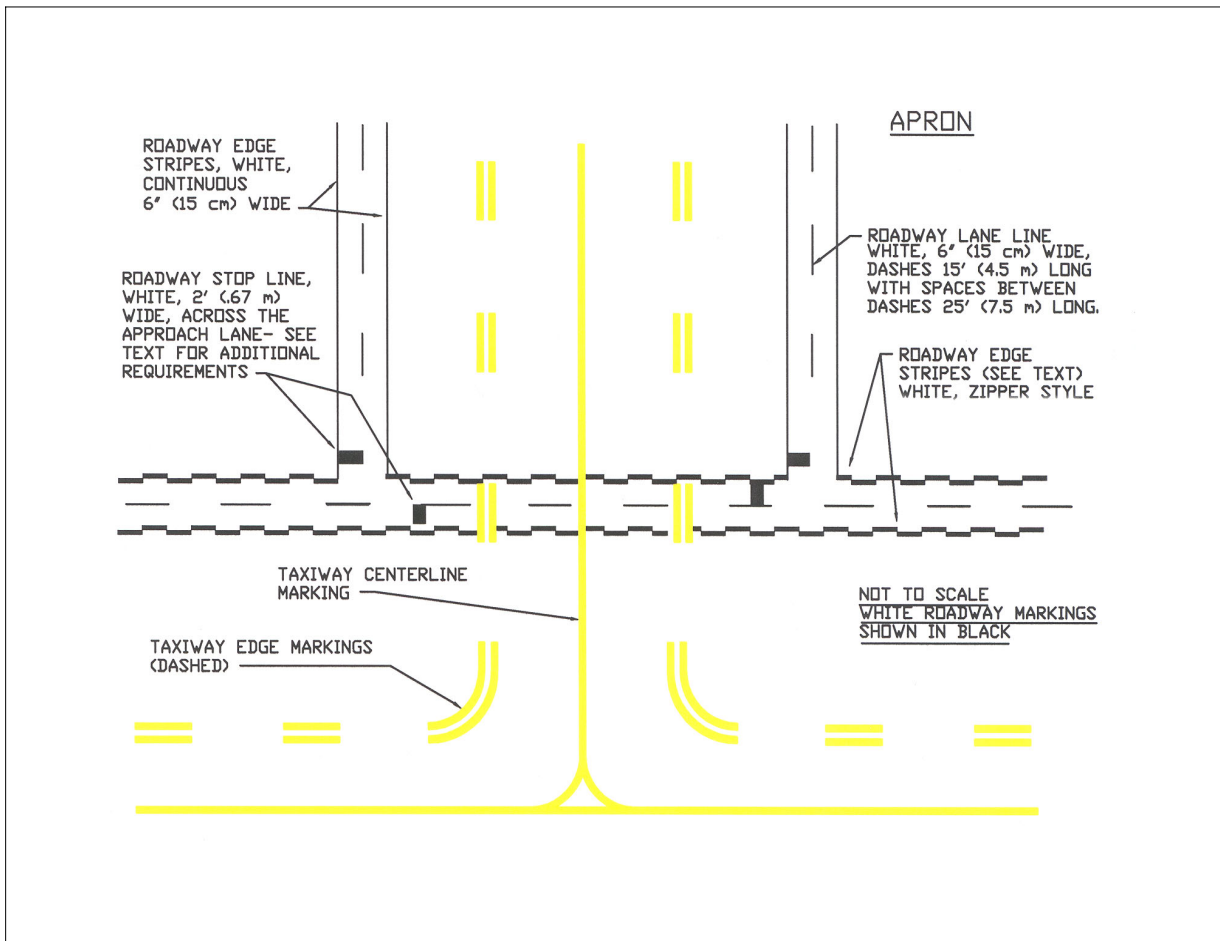
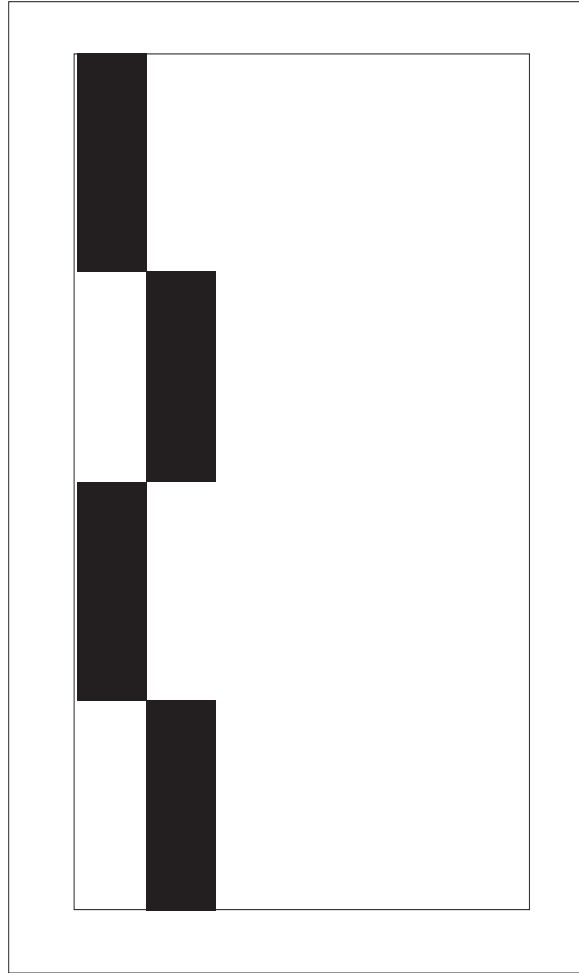


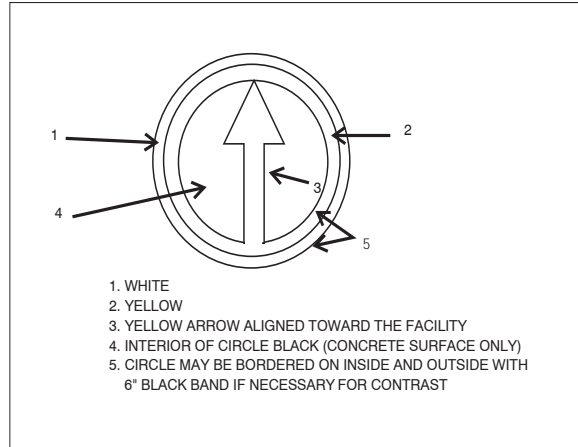
FIG AD 1.1-30  
Vehicle Roadway Markings



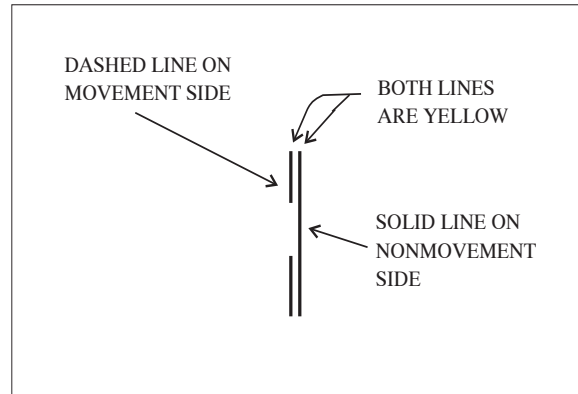
*FIG AD 1.1-31*  
**Roadway Edge Stripes, White, Zipper Style**



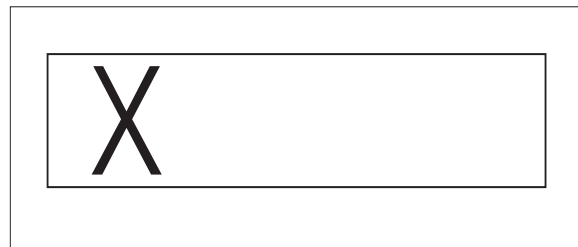
**FIG AD 1.1-32**  
**Ground Receiver Checkpoint Markings**



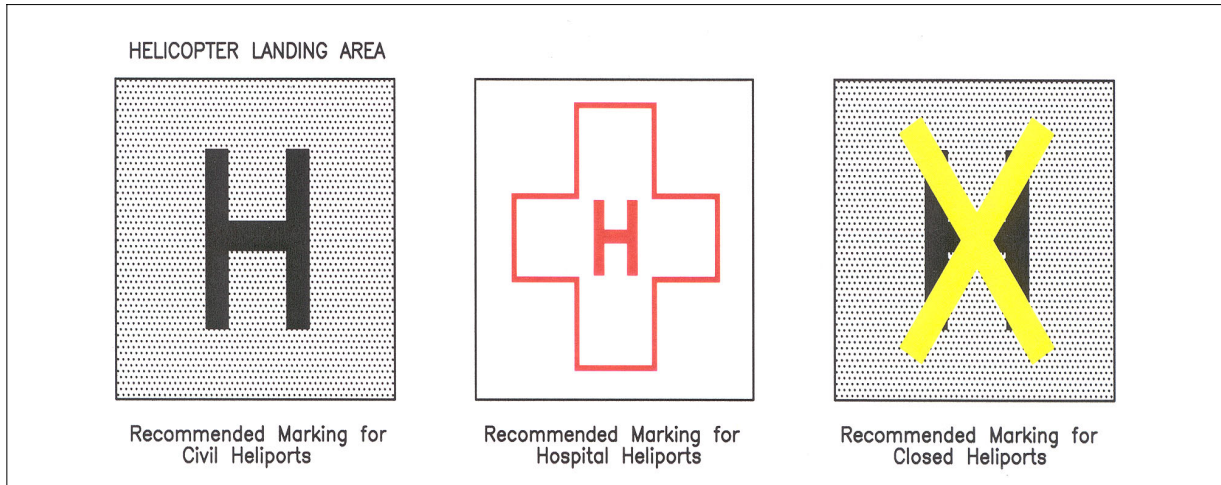
**FIG AD 1.1-33**  
**Nonmovement Area Boundary Markings**



**FIG AD 1.1-34**  
**Closed or Temporarily Closed Runway and Taxiway Markings**



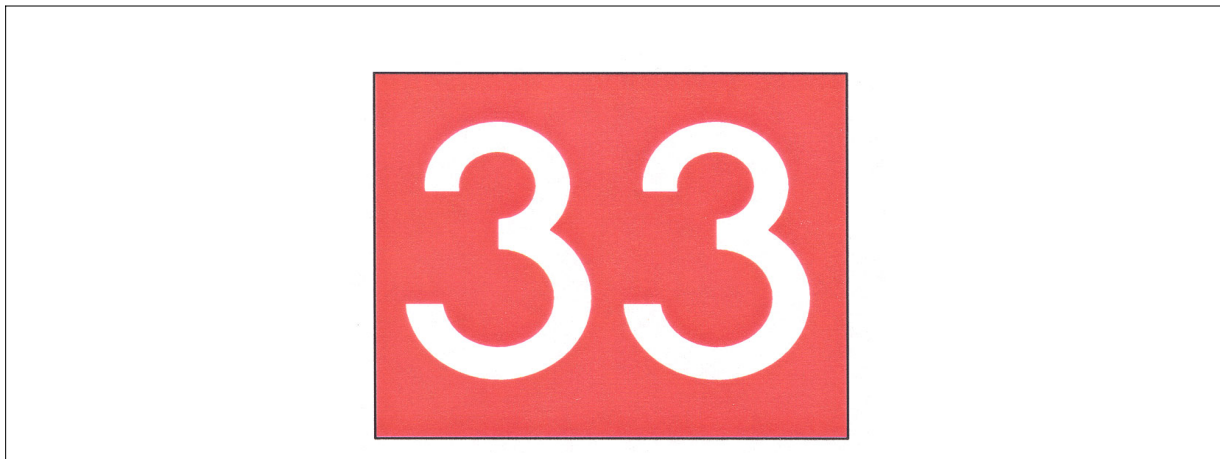
**FIG AD 1.1-35**  
**Helicopter Landing Areas**



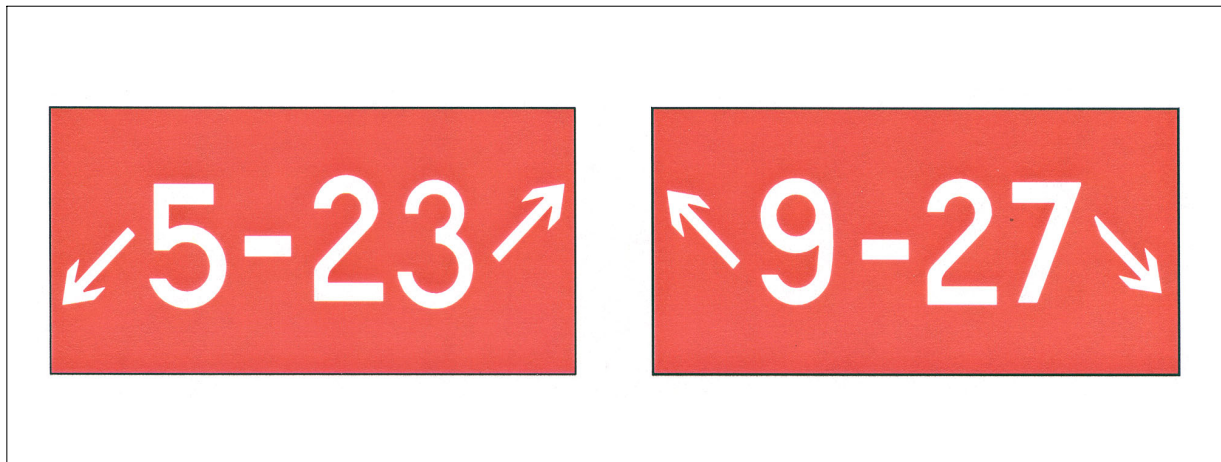
**FIG AD 1.1-36**  
**Runway Holding Position Sign**



**FIG AD 1.1-37**  
**Holding Position Sign at Beginning of Takeoff Runway**



**FIG AD 1.1-38**  
**Holding Position Sign for a Taxiway that Intersects the Intersection of Two Runways**



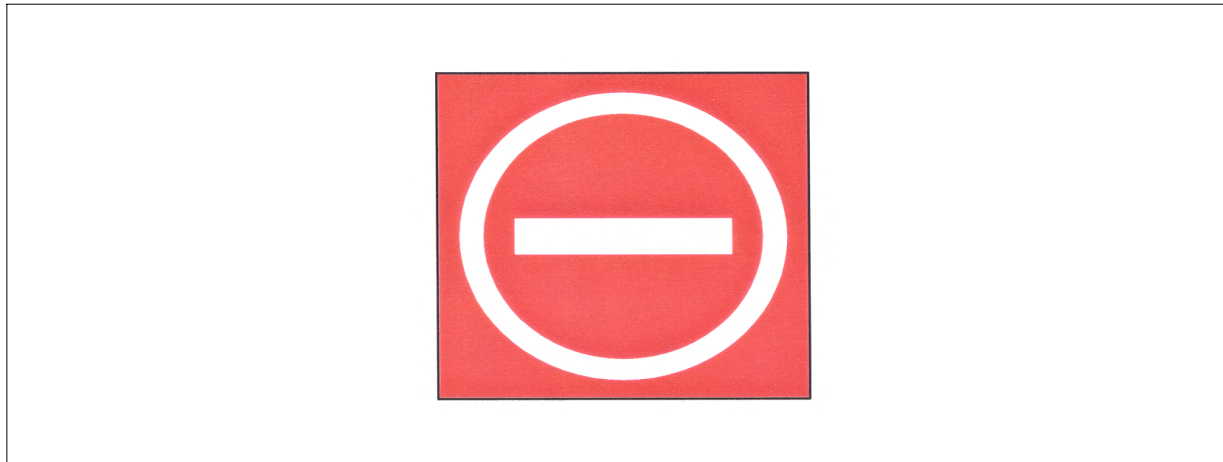
**FIG AD 1.1-39**  
**Holding Position Sign for a Runway Approach Area**



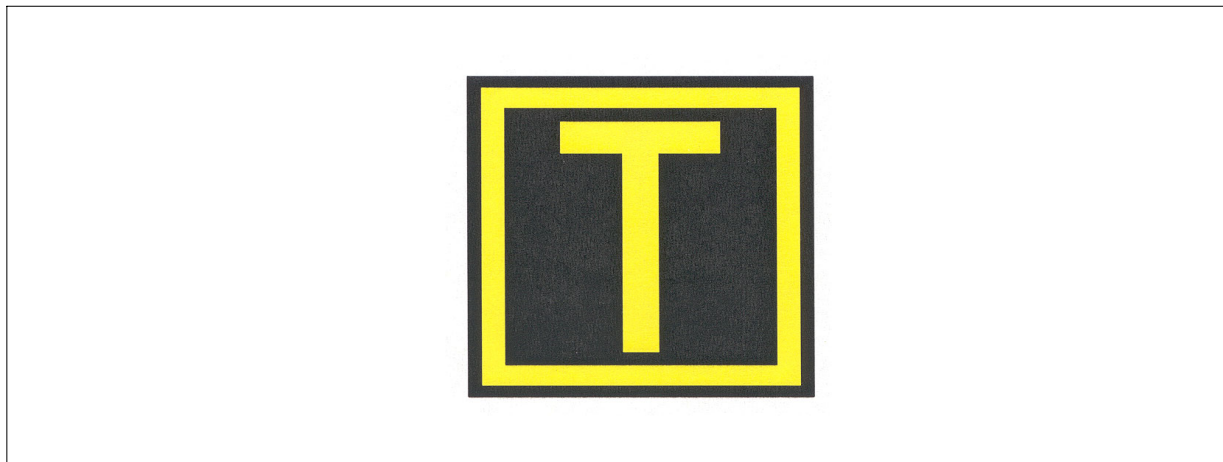
**FIG AD 1.1-40**  
**Holding Position Sign for ILS Critical Area**



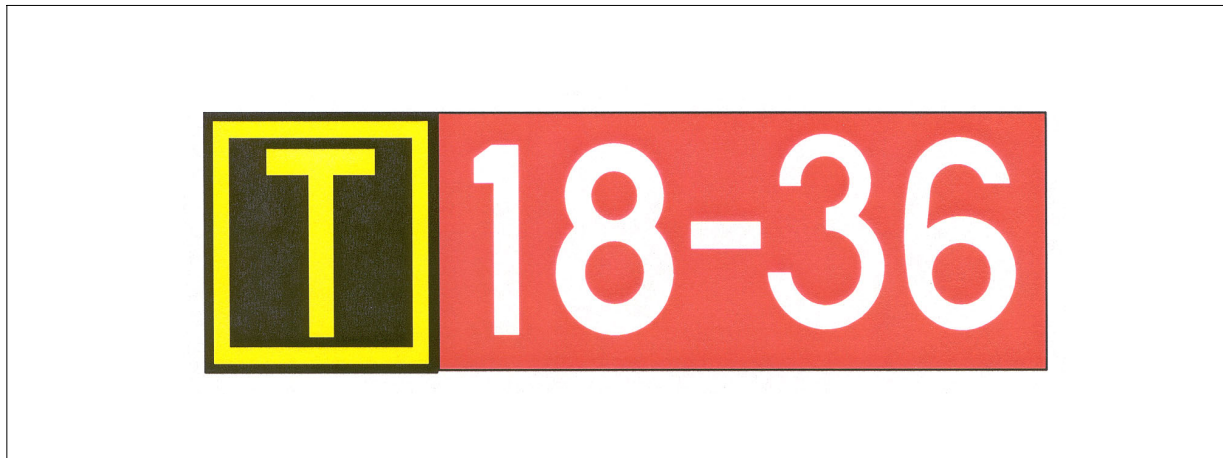
**FIG AD 1.1-41**  
**Sign Prohibiting Aircraft Entry into an Area**



**FIG AD 1.1-42**  
**Taxiway Location Sign**



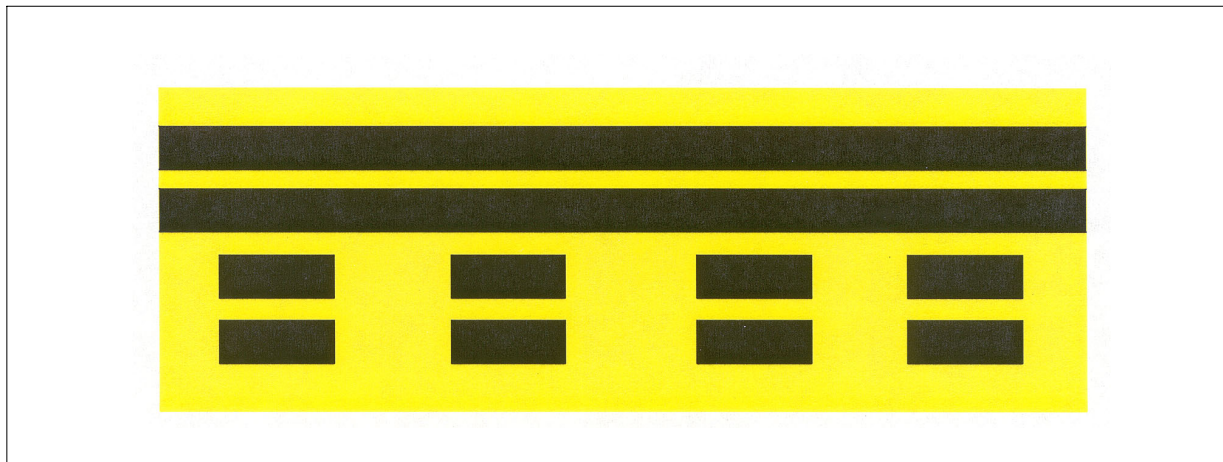
**FIG AD 1.1-43**  
**Taxiway Location Sign Collocated with Runway Holding Position Sign**



**FIG AD 1.1-44**  
**Runway Location Sign**



**FIG AD 1.1-45**  
**Runway Boundary Sign**



**FIG AD 1.1-46**  
**ILS Critical Area Boundary Sign**

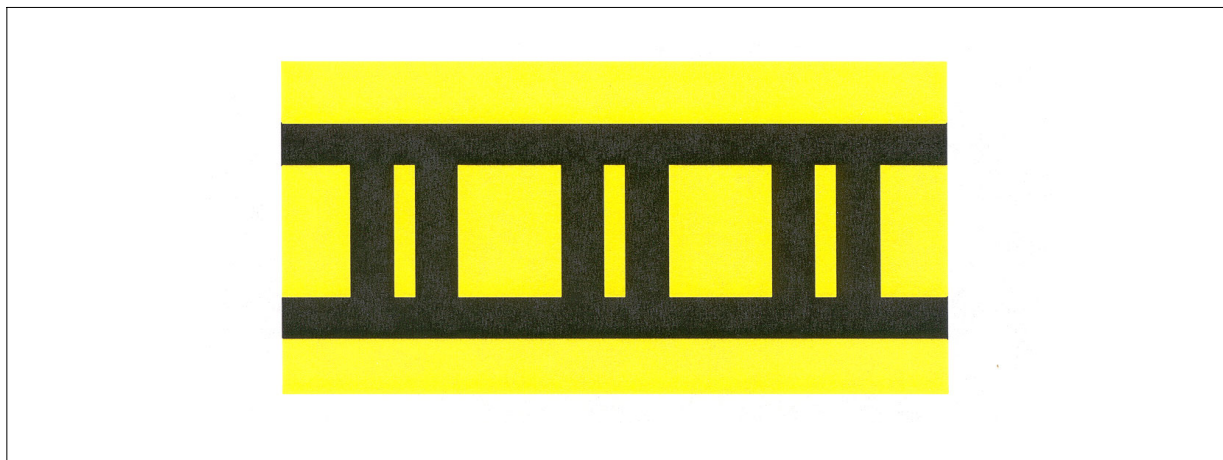




FIG AD 1.1-47  
Direction Sign Array with Location Sign on Far Side of Intersection

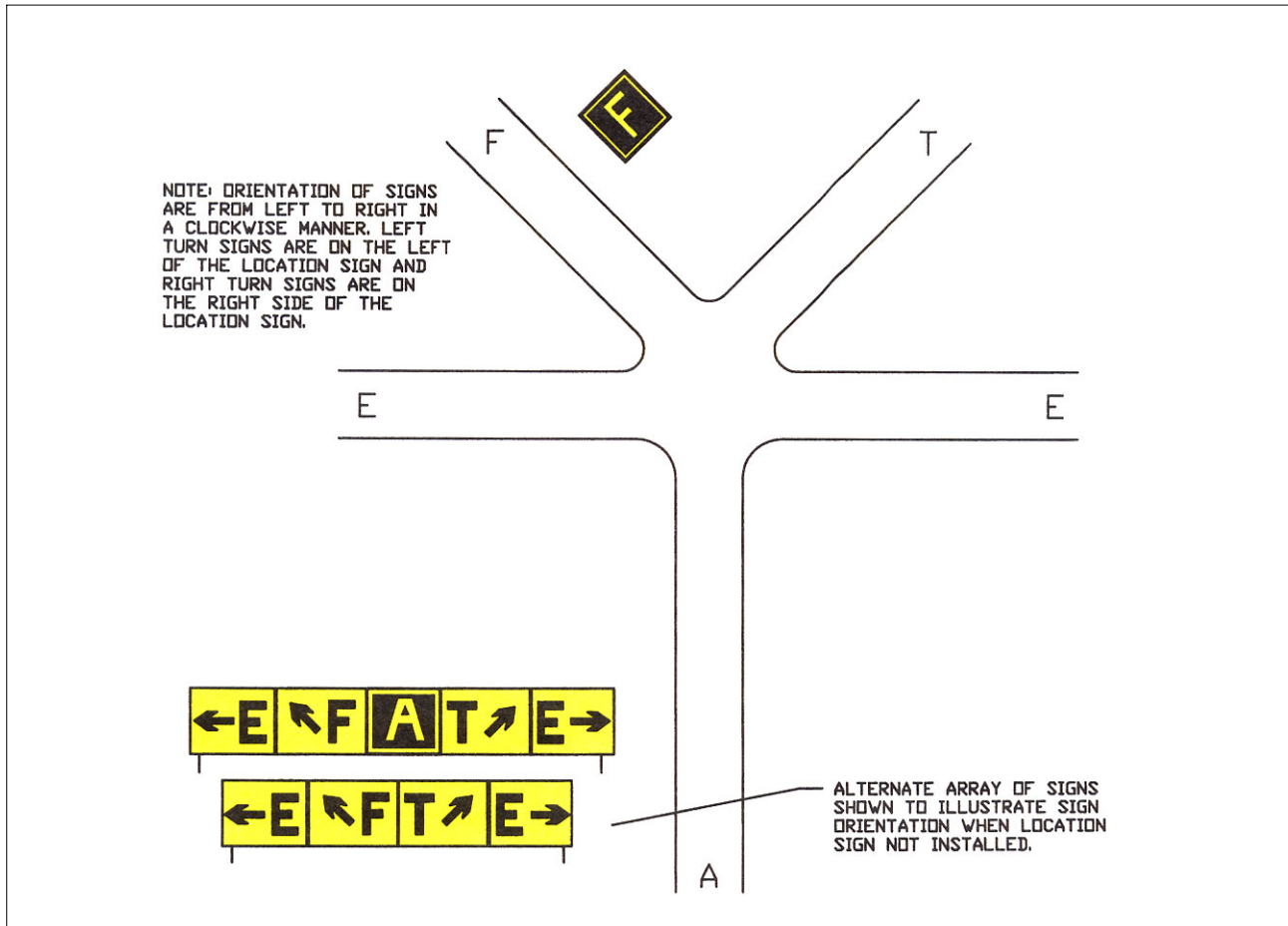


FIG AD 1.1-48  
Direction Sign for Runway Exit



FIG AD 1.1-49  
Direction Sign Array for Simple Intersection

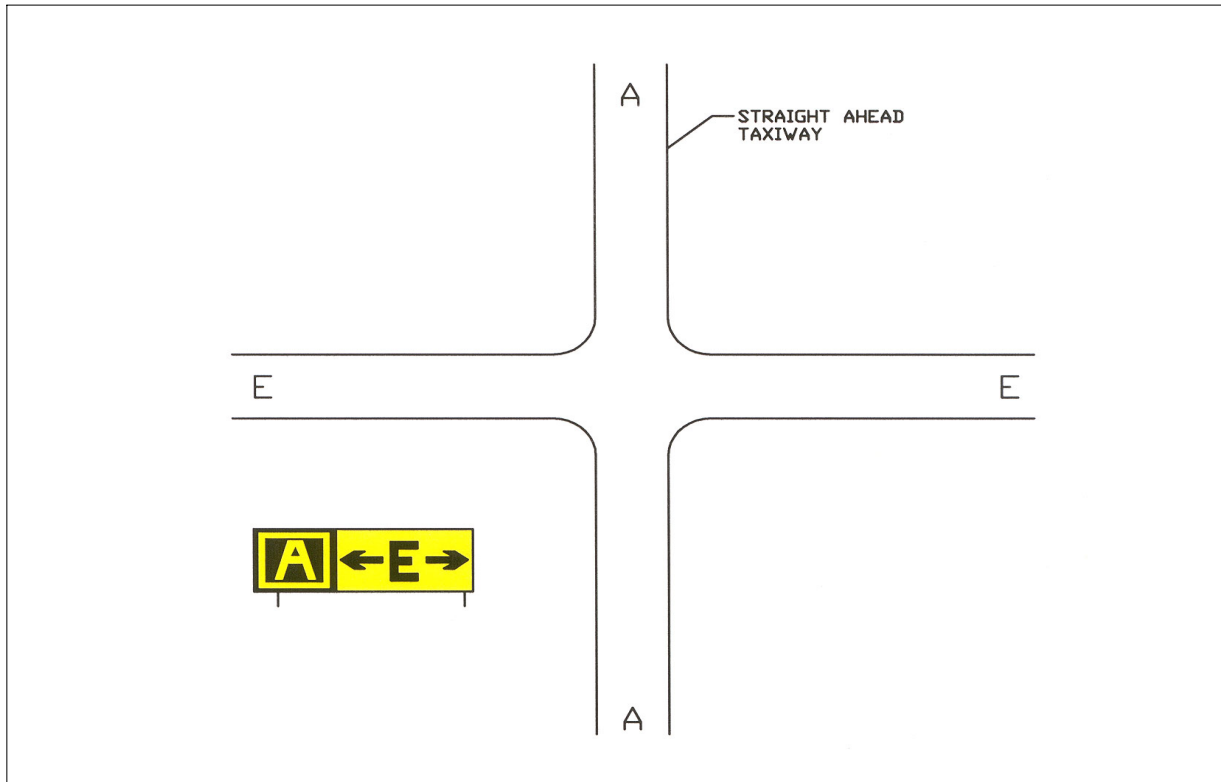
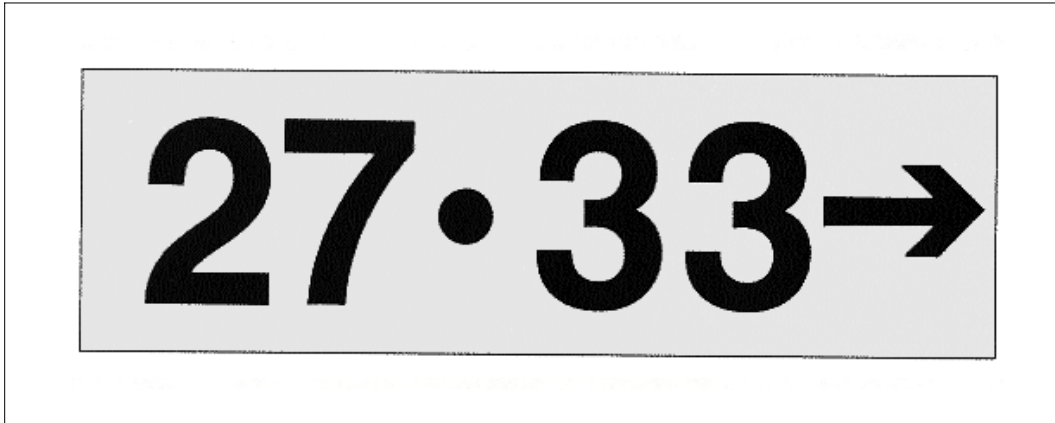


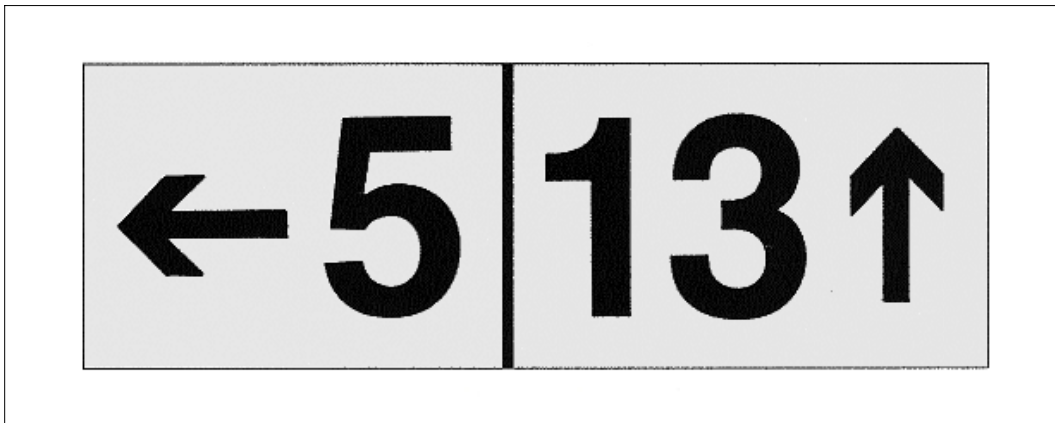
FIG AD 1.1-50  
Destination Sign for Military Area



*FIG AD 1.1-51*  
Destination Sign for Common Taxiing Route to Two Runways



*FIG AD 1.1-52*  
Destination Sign for Different Taxiing Routes to Two Runways



*FIG AD 1.1-53*  
**Runway Distance Remaining Sign Indicating 3,000 feet of Runway Remaining**



*FIG AD 1.1-54*  
**Engineered Materials Arresting System (EMAS)**



*FIG AD 1.1-55*  
**Sample SIDA Warning Sign**





## AD 2. AERODROMES

1. The following is a partial list of U.S. airports designated to serve international operations. This list contains U.S. airports with scheduled passenger service in large aircraft and certain airports designated as alternate service airports. Omitted from this list are designated general aviation airports, airports with scheduled cargo but no scheduled passenger service, and certain airports having international service in commuter-type aircraft.

ICAO ID	Location	Airport Name	Designation
<b>Alaska</b>			
PANC	Anchorage	Ted Stevens Anchorage International	Regular
PAED	Anchorage	Elmendorf AFB	Alternate
PACD	Cold Bay	Cold Bay	Alternate
PAEI	Fairbanks	Eielson AFB	Alternate
PAFA	Fairbanks	Fairbanks International	Regular
PAJN	Juneau	Juneau International	Regular
PAKN	King Salmon	King Salmon	Alternate
<b>American Samoa</b>			
NSTU	Pago Pago	Pago Pago International	Regular
<b>Arizona</b>			
KPHX	Phoenix	Phoenix Sky Harbor International	Regular
KTUS	Tucson	Tucson International	Regular
<b>California</b>			
KFAT	Fresno	Fresno Yosemite International	Alternate
KLAX	Los Angeles	Los Angeles International	Regular
KOAK	Oakland	Metropolitan Oakland International	Regular
KONT	Ontario	Ontario International	Alternate
KPMD	Palmdale	Palmdale Regional/USAF Plant 42	Alternate
KSMF	Sacramento	Sacramento International	Alternate
KSAN	San Diego	San Diego International	Regular
KSFO	San Francisco	San Francisco International	Regular
KSJC	San Jose	San Jose Norman Y. Mineta International	Regular
KSCK	Stockton	Stockton Metropolitan	Alternate
<b>Colorado</b>			
KDEN	Denver	Denver International	Regular
KPUB	Pueblo	Pueblo Memorial	Alternate

ICAO ID	Location	Airport Name	Designation
<b>Connecticut</b>			
KBDL	Windsor Locks	Bradley International	Regular
<b>District of Columbia</b>			
KIAD	Washington	Washington Dulles International	Regular
<b>Florida</b>			
KFLL	Fort Lauderdale	Fort Lauderdale-Hollywood International	Regular
KRSW	Fort Myers	Southwest Florida International	Regular
KMIA	Miami	Miami International	Regular
KMCO	Orlando	Orlando International	Regular
KTPA	Tampa	Tampa International	Regular
KPBI	West Palm Beach	Palm Beach International	Regular
<b>Georgia</b>			
KATL	Atlanta	Hartsfield – Jackson Atlanta International	Regular
<b>Guam</b>			
PGUM	Agana	Guam International	Regular
PGUA	Guam Island	Andersen AFB	Alternate
<b>Hawaii</b>			
PHTO	Hilo	Hilo International	Alternate
PHNL	Honolulu	Honolulu International	Regular
PHOG	Kahului	Kahului	Regular
<b>Illinois</b>			
KORD	Chicago	Chicago-O’Hare International	Regular
<b>Indiana</b>			
KIND	Indianapolis	Indianapolis International	Regular
<b>Kansas</b>			
KICT	Wichita	Wichita Mid-Continent	Alternate
<b>Kentucky</b>			
KCVG	Covington	Cincinnati/Northern Kentucky International	Regular

ICAO ID	Location	Airport Name	Designation
<b>Louisiana</b>			
KMSY	New Orleans	Louis Armstrong New Orleans International	Regular
<b>Maine</b>			
KBGR	Bangor	Bangor International	Alternate
<b>Maryland</b>			
KBWI	Baltimore	Baltimore–Washington International Thurgood Marshall	Regular
<b>Massachusetts</b>			
KBOS	Boston	General Edward Lawrence Logan International	Regular
<b>Michigan</b>			
KDTW	Detroit	Detroit Metropolitan Wayne County	Regular
<b>Minnesota</b>			
KMSP	Minneapolis	Minneapolis–St. Paul International (Wold–Chamberlain)	Regular
<b>Missouri</b>			
KMCI	Kansas City	Kansas City International	Regular
KSTL	St. Louis	Lambert–St. Louis International	Regular
<b>Nevada</b>			
KLAS	Las Vegas	Harry Reid International	Regular
KRNO	Reno	Reno/Tahoe International	Regular
<b>New Jersey</b>			
KEWR	Newark	Newark Liberty International	Regular
<b>New York</b>			
KJFK	New York	John F. Kennedy International	Regular
KIAG	Niagara Falls	Niagara Falls International	Alternate
KSYR	Syracuse	Syracuse Hancock International	Regular
<b>North Carolina</b>			
KCLT	Charlotte	Charlotte/Douglas International	Regular
KRDU	Raleigh–Durham	Raleigh–Durham International	Regular
<b>Northern Mariana Islands</b>			
PGSN	Saipan Island	Francisco C. Ada/Saipan International	Regular

ICAO ID	Location	Airport Name	Designation
<b>Ohio</b>			
KCLE	Cleveland	Cleveland–Hopkins International	Regular
KCMH	Columbus	Port Columbus International	Regular
<b>Oregon</b>			
KPDX	Portland	Portland International	Regular
<b>Pennsylvania</b>			
KPHL	Philadelphia	Philadelphia International	Regular
KPIT	Pittsburgh	Pittsburgh International	Regular
<b>Puerto Rico</b>			
TJMZ	Mayaguez	Eugenio Maria De Hostos	Regular
TJSJ	San Juan	Luis Munoz Marin International	Regular
<b>Tennessee</b>			
KMEM	Memphis	Memphis International	Regular
KBNA	Nashville	Nashville International	Regular
<b>Texas</b>			
KDFW	Dallas	Dallas–Fort Worth International	Regular
KELP	El Paso	El Paso International	Regular
KIAH	Houston	George Bush Intercontinental/Houston	Regular
KLRD	Laredo	Laredo International	Regular
KSAT	San Antonio	San Antonio International	Regular
<b>Utah</b>			
KSLC	Salt Lake City	Salt Lake City International	Regular
<b>Virgin Islands</b>			
TIST	Charlotte Amalie St. Thomas	Cyril E King	Regular
TISX	Christiansted St. Croix	Henry E Rohlsen	Regular
<b>Washington</b>			
KPAE	Everett	Snohomish County (Paine Field)	Alternate
KSEA	Seattle	Seattle–Tacoma International	Regular
KGEG	Spokane	Spokane International	Alternate
<b>Wisconsin</b>			
KMKE	Milwaukee	General Mitchell International	Regular



**1.1** Diagrams of these airports, arranged alphabetically by state and in the order listed above, are on the pages following. The most up-to-date diagrams of these and other U.S. airports are in the Terminal Procedures Publication (TPP). For additional information on these airports, see the Chart Supplement U.S.

**1.2** Public sales of the Chart Supplement U.S. and TPP are available through a network of FAA approved print providers. A listing of products, dates of latest editions, and print providers is available on the AIS website at: [http://www.faa.gov/air\\_traffic/flight\\_info/aeronav](http://www.faa.gov/air_traffic/flight_info/aeronav).

### Instrument Approach Procedures (Charts) Airport Diagram/Airport Sketch

19339

#### LEGEND

#### INSTRUMENT APPROACH PROCEDURES (CHARTS)

### AIRPORT DIAGRAM/AIRPORT SKETCH

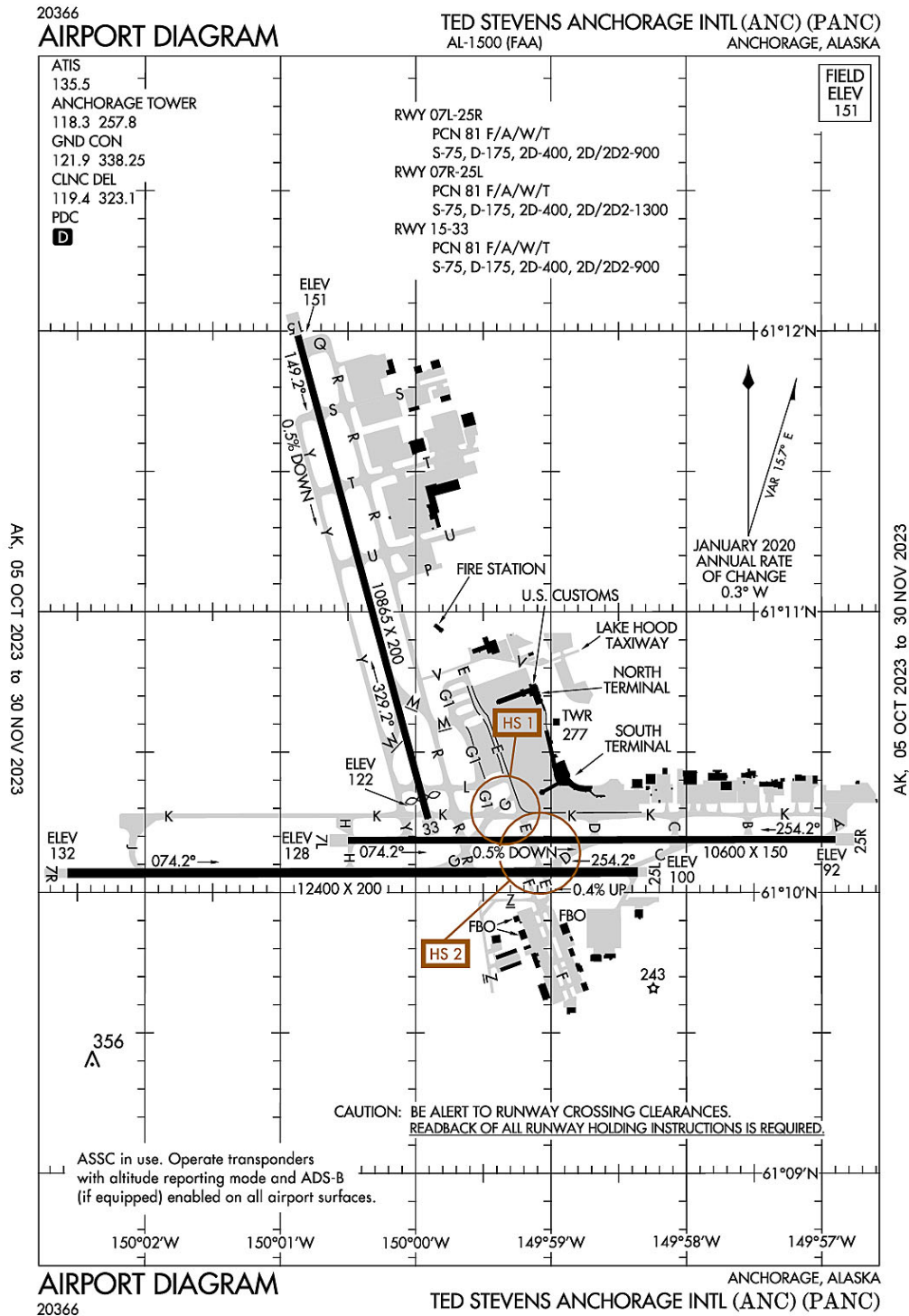
<p><b>Runways</b></p> <table border="0" style="width: 100%;"> <tr> <td> Hard Surface</td> <td> Other Than Hard Surface</td> <td> Stopways, Taxiways, Parking Areas</td> <td> Metal Surface</td> </tr> <tr> <td> Closed Runway</td> <td> Closed Surface</td> <td> Under Construction</td> <td> Water Runway</td> </tr> </table> <p>ARRESTING GEAR: Specific arresting gear systems; e.g., BAK12, MA-1A etc., shown on airport diagrams, not applicable to Civil Pilots. Military Pilots refer to appropriate DOD publications.</p> <p> uni-directional     bi-directional     Jet Barrier</p> <p>ARRESTING SYSTEM  (EMAS)</p> <p><b>REFERENCE FEATURES</b></p> <table border="0" style="width: 100%;"> <tr> <td>Displaced Threshold.....</td> <td></td> </tr> <tr> <td>Hot Spot.....</td> <td></td> </tr> <tr> <td>Runway Holding Position Markings.....</td> <td></td> </tr> <tr> <td>Buildings.....</td> <td></td> </tr> <tr> <td>24-Hour Self-Serve Fuel ##.....</td> <td></td> </tr> <tr> <td>Tanks.....</td> <td></td> </tr> <tr> <td>Obstructions.....</td> <td></td> </tr> <tr> <td>Airport Beacon #.....</td> <td></td> </tr> <tr> <td>Runway Radar Reflectors.....</td> <td></td> </tr> <tr> <td>Control Tower #.....</td> <td> TWR</td> </tr> </table> <p># When Control Tower and Rotating Beacon are co-located, Beacon symbol will be used and further identified as TWR.</p> <p>## A fuel symbol is shown to indicate 24-hour self-serve fuel available, see appropriate Chart Supplement for information.</p> <p><b>NOTE:</b> All new and revised airport diagrams are shown referenced to the World Geodetic System (WGS) (noted on appropriate diagram), and may not be compatible with local coordinates published in FLIP. (Foreign Only)</p> <p>Runway Weight Bearing Capacity/or PCN Pavement Classification Number is shown as a codified expression. Refer to the appropriate Supplement/Directory for applicable codes e.g., RWY 14-32 PCN 80 F/D/X/U S-75, D-185, 2S-175, 2D-325</p>	Hard Surface	Other Than Hard Surface	Stopways, Taxiways, Parking Areas	Metal Surface	Closed Runway	Closed Surface	Under Construction	Water Runway	Displaced Threshold.....		Hot Spot.....		Runway Holding Position Markings.....		Buildings.....		24-Hour Self-Serve Fuel ##.....		Tanks.....		Obstructions.....		Airport Beacon #.....		Runway Radar Reflectors.....		Control Tower #.....	TWR	<p>Helicopter Alighting Areas </p> <p>Negative Symbols used to identify Copter Procedures landing point..... </p> <p><b>NOTE:</b> Landmark features depicted on Copter Approach insets and sketches are provided for visual reference only.</p> <p>Runway TDZ elevation.....TDZE 123</p> <p>Runway Slope.....0.3% DOWN .....0.8% UP (shown when runway slope is greater than or equal to 0.3%)</p> <p><b>NOTE:</b> Runway Slope measured to midpoint on runways 8000 feet or longer.</p> <p> U.S. Navy Optical Landing System (OLS) "OLS" location is shown because of its height of approximately 7 feet and proximity to edge of runway may create an obstruction for some types of aircraft.</p> <p>Approach light symbols are shown in the Flight Information Handbook.</p> <p>Airport diagram scales are variable.</p> <p>True/magnetic North orientation may vary from diagram to diagram</p> <p>Coordinate values are shown in 1 or 1/2 minute increments. They are further broken down into 6 second ticks, within each 1 minute increments.</p> <p>Positional accuracy within ±600 feet unless otherwise noted on the chart.</p> <p>Runway length depicted is the physical length of the runway (end-to-end, including displaced thresholds if any) but excluding areas designated as stopways.</p> <p>A  symbol is shown to indicate runway declared distance information available, see appropriate Chart Supplement for distance information.</p>
Hard Surface	Other Than Hard Surface	Stopways, Taxiways, Parking Areas	Metal Surface																										
Closed Runway	Closed Surface	Under Construction	Water Runway																										
Displaced Threshold.....																													
Hot Spot.....																													
Runway Holding Position Markings.....																													
Buildings.....																													
24-Hour Self-Serve Fuel ##.....																													
Tanks.....																													
Obstructions.....																													
Airport Beacon #.....																													
Runway Radar Reflectors.....																													
Control Tower #.....	TWR																												

SCOPE

Airport diagrams are specifically designed to assist in the movement of ground traffic at locations with complex runway/taxiway configurations. Airport diagrams are not intended to be used for approach and landing or departure operations. For revisions to Airport Diagrams: Consult FAA Order 7910.4.

#### LEGEND

### Anchorage, Alaska Ted Stevens Anchorage International ICAO Identifier PANC



**Anchorage, AK**  
**Ted Stevens Anchorage Intl**  
**ICAO Identifier PANC**

**AD 2.2 Aerodrome geographical and administrative data**

- 2.2.1 Reference Point: 61-10-26.705N / 149-59-53.295W
- 2.2.2 From City: 4 miles SW of ANCHORAGE, AK
- 2.2.3 Elevation: 151.4 ft
- 2.2.5 Magnetic Variation: 16E (2020)
- 2.2.6 Airport Contact: CRAIG CAMPBELL  
BOX 196960  
ANCHORAGE, AK 99519 (907-266-2600)
- 2.2.7 Traffic: IFR/VFR

**AD 2.3 Attendance Schedule**

- 2.3.1 All Months, All Days, All Hours

**AD 2.4 Handling Services and Facilities**

- 2.4.1 Cargo Handling Facilities: YES
- 2.4.2 Fuel Types: 100,100LL,A,A1
- 2.4.5 Hangar Space: YES
- 2.4.6 Repair Facilities: MAJOR

**AD 2.6 Rescue and Firefighting Services**

- 2.6.1 Aerodrome Category: Class-I certified on 4/1/2005
- 2.6.2 Rescue and Firefighting Services: ARFF Index-E

**AD 2.12 Runway Physical Characteristics**

- 2.12.1 Designation: 07L
- 2.12.2 True Bearing: 90
- 2.12.3 Dimensions: 10600 ft x 150 ft
- 2.12.4 PCN: 81 F/A/W/T
- 2.12.5 Coordinates: 61-10-11.1539N / 150-0-29.9998W
- 2.12.6 Threshold Elevation: 127.6 ft
- 2.12.6 Touchdown Zone Elevation: 128.2 ft
  
- 2.12.1 Designation: 25R
- 2.12.2 True Bearing: 270
- 2.12.3 Dimensions: 10600 ft x 150 ft
- 2.12.4 PCN: 81 F/A/W/T
- 2.12.5 Coordinates: 61-10-11.3202N / 149-56-53.8826W
- 2.12.6 Threshold Elevation: 91.5 ft
- 2.12.6 Touchdown Zone Elevation: 91.8 ft
  
- 2.12.1 Designation: 07R

2.12.2 True Bearing: 90  
2.12.3 Dimensions: 12400 ft x 200 ft  
2.12.4 PCN: 81 F/A/W/T  
2.12.5 Coordinates: 61-10-4.1216N / 150-2-34.3367W  
2.12.6 Threshold Elevation: 131.7 ft  
2.12.6 Touchdown Zone Elevation: 131.7 ft

2.12.1 Designation: 25L  
2.12.2 True Bearing: 270  
2.12.3 Dimensions: 12400 ft x 200 ft  
2.12.4 PCN: 81 F/A/W/T  
2.12.5 Coordinates: 61-10-4.3722N / 149-58-21.535W  
2.12.6 Threshold Elevation: 100.4 ft  
2.12.6 Touchdown Zone Elevation: 114.6 ft

2.12.1 Designation: 15  
2.12.2 True Bearing: 165  
2.12.3 Dimensions: 10865 ft x 200 ft  
2.12.4 PCN: 81 F/A/W/T  
2.12.5 Coordinates: 61-11-59.03N / 150-0-52.31W  
2.12.6 Threshold Elevation: 151.3 ft  
2.12.6 Touchdown Zone Elevation: 151.4 ft

2.12.1 Designation: 33  
2.12.2 True Bearing: 345  
2.12.3 Dimensions: 10865 ft x 200 ft  
2.12.4 PCN: 81 F/A/W/T  
2.12.5 Coordinates: 61-10-15.75N / 149-59-54.49W  
2.12.6 Threshold Elevation: 121.7 ft  
2.12.6 Touchdown Zone Elevation: 120.8 ft

### **AD 2.13 Declared Distances**

2.13.1 Designation: 07L  
2.13.2 Take-off Run Available: 10600  
2.13.3 Take-off Distance Available: 10600  
2.13.4 Accelerate-Stop Distance Available: 10600  
2.13.5 Landing Distance Available: 10600

2.13.1 Designation: 25R  
2.13.2 Take-off Run Available: 10600  
2.13.3 Take-off Distance Available: 10600  
2.13.4 Accelerate-Stop Distance Available: 10600  
2.13.5 Landing Distance Available: 10600

- 2.13.1 Designation: 07R
- 2.13.2 Take-off Run Available: 10900
- 2.13.3 Take-off Distance Available: 10900
- 2.13.4 Accelerate-Stop Distance Available: 10900
- 2.13.5 Landing Distance Available: 12400

- 2.13.1 Designation: 25L
- 2.13.2 Take-off Run Available: 12400
- 2.13.3 Take-off Distance Available: 12400
- 2.13.4 Accelerate-Stop Distance Available: 12000
- 2.13.5 Landing Distance Available: 12000

- 2.13.1 Designation: 15
- 2.13.2 Take-off Run Available: 10865
- 2.13.3 Take-off Distance Available: 10865
- 2.13.4 Accelerate-Stop Distance Available: 10000
- 2.13.5 Landing Distance Available: 10000

- 2.13.1 Designation: 33
- 2.13.2 Take-off Run Available: 10865
- 2.13.3 Take-off Distance Available: 11965
- 2.13.4 Accelerate-Stop Distance Available: 10865
- 2.13.5 Landing Distance Available: 10400

#### **AD 2.14 Approach and Runway Lighting**

- 2.14.1 Designation: 07L
- 2.14.2 Approach Lighting System: MALSR
- 2.14.4 Visual Approach Slope Indicator System: P4R

- 2.14.1 Designation: 25R
- 2.14.2 Approach Lighting System:
- 2.14.4 Visual Approach Slope Indicator System: P4L

- 2.14.1 Designation: 07R
- 2.14.2 Approach Lighting System: ALSF2
- 2.14.4 Visual Approach Slope Indicator System: P4R

- 2.14.1 Designation: 25L
- 2.14.2 Approach Lighting System:
- 2.14.4 Visual Approach Slope Indicator System: P4L

- 2.14.1 Designation: 15

2.14.2 Approach Lighting System: MALSF  
2.14.4 Visual Approach Slope Indicator System: P4R

2.14.1 Designation: 33  
2.14.2 Approach Lighting System:  
2.14.4 Visual Approach Slope Indicator System: P4R

**AD 2.18 Air Traffic Services Communication Facilities**

2.18.1 Service Designation: CD/P  
2.18.3 Channel: 119.4  
2.18.5 Hours of Operation: 24

2.18.1 Service Designation: CD/P  
2.18.3 Channel: 323.1  
2.18.5 Hours of Operation: 24

2.18.1 Service Designation: CD/S  
2.18.3 Channel: 128.65  
2.18.5 Hours of Operation: 24

2.18.1 Service Designation: D-ATIS  
2.18.3 Channel: 135.5  
2.18.5 Hours of Operation: 24

2.18.1 Service Designation: EMERG  
2.18.3 Channel: 121.5  
2.18.5 Hours of Operation:

2.18.1 Service Designation: EMERG  
2.18.3 Channel: 243  
2.18.5 Hours of Operation:

2.18.1 Service Designation: GND/P  
2.18.3 Channel: 121.9  
2.18.5 Hours of Operation: 24

2.18.1 Service Designation: GND/P  
2.18.3 Channel: 338.25  
2.18.5 Hours of Operation: 24

2.18.1 Service Designation: LCL/P  
2.18.3 Channel: 118.3  
2.18.5 Hours of Operation: 24

2.18.1 Service Designation: LCL/P

2.18.3 Channel: 257.8

2.18.5 Hours of Operation: 24

**AD 2.19 Radio Navigation and Landing Aids**

2.19.1 ILS Type: DME for runway 07L. Magnetic variation: 16E

2.19.2 ILS Identification: TGN

2.19.5 Coordinates: 61-10-14.0636N / 149-56-33.0327W

2.19.6 Site Elevation: 105.5 ft

2.19.1 ILS Type: Glide Slope for runway 07L. Magnetic variation: 16E

2.19.2 ILS Identification: TGN

2.19.5 Coordinates: 61-10-13.93N / 150-0-9.62W

2.19.6 Site Elevation: 122.8 ft

2.19.1 ILS Type: Localizer for runway 07L. Magnetic variation: 16E

2.19.2 ILS Identification: TGN

2.19.5 Coordinates: 61-10-11.3329N / 149-56-32.6534W

2.19.6 Site Elevation: 84.7 ft

2.19.1 ILS Type: DME for runway 07R. Magnetic variation: 16E

2.19.2 ILS Identification: ANC

2.19.5 Coordinates: 61-10-2.0211N / 149-57-58.3996W

2.19.6 Site Elevation: 112 ft

2.19.1 ILS Type: Glide Slope for runway 07R. Magnetic variation: 16E

2.19.2 ILS Identification: ANC

2.19.5 Coordinates: 61-10-8.1823N / 150-2-12.4572W

2.19.6 Site Elevation: 124.9 ft

2.19.1 ILS Type: Localizer for runway 07R. Magnetic variation: 16E

2.19.2 ILS Identification: ANC

2.19.5 Coordinates: 61-10-4.3906N / 149-57-55.495W

2.19.6 Site Elevation: 97.7 ft

2.19.1 ILS Type: DME for runway 15. Magnetic variation: 16E

2.19.2 ILS Identification: BSC

2.19.5 Coordinates: 61-10-0.0069N / 149-59-40.3379W

2.19.6 Site Elevation: 134.7 ft

2.19.1 ILS Type: Glide Slope for runway 15. Magnetic variation: 16E

2.19.2 ILS Identification: BSC

2.19.5 Coordinates: 61-11-46.76N / 150-0-54.42W

2.19.6 Site Elevation: 151.3 ft

2.19.1 ILS Type: Localizer for runway 15. Magnetic variation: 16E

2.19.2 ILS Identification: BSC

2.19.5 Coordinates: 61-9-59.9158N / 149-59-45.6352W

2.19.6 Site Elevation: 120.9 ft

**General Remarks:**

NON-RADIO NIGHT OPS NA; NON-PARROT OPS 1 HR PPR; NON-RADIO OPS PPR; MUST PRVD ETA & REMAIN WI 15 MIN - ATCT 907-271-2700 WKDAYS 0730-1600; AFT HR & HOL - FAA 907-271-5936.

NOISE SENSITIVE AREA S & E; RWY 07R, 07L, 15 TBJT/TURBOFAN DEP EMPLOY FAA CLOSE IN NADP OR ICAO PROC B NADP WHEN SAFETY PERMITS; INFO - AMGR.

R TURN OUT OF RAMP PRKG R-2 THRU R-4 NA.

COMPASS CLBR PAD N/A.

BIRDS INVOF ARPT SPRING - FALL.

COLD TEMPERATURE AIRPORT. ALTITUDE CORRECTION REQUIRED AT OR BELOW -22C.

TWY V, SCTY GATE E OF TWY E - PCL 121.75 5 TIMES; TWY H-2, LAKESHORE TWY GATES - PCL 121.75 3 TIMES; IF INOP ALLOW 30 SEC RESET & NOTIFY LHD OPS - 907-266-2600.

PTNS OF TWY K BTN TWY H & J NOT VIS FM ATCT.

PPR FOR GND TIME GTR THAN 4 HR AT ARPT CTL SPOTS; APVL REQ 48 HR PRIOR TO DEP FOR ANC - GATE MGMT 907 266-2633 OR EMAIL: DOT.AIA.OPS.GATEMANAGEMENT@ALASKA.GOV.

TSNT MIL PPR.

TWY V RSTRD TO 12500 LB OR LESS; SUBJECT TO JET BLAST W OF TWY E.

ASSC IN USE; OPR PARROT WITH ALT RPRTG MODE & ADS-B IF EQUIPPED ENABLED ON ARPT SFCS.

489 FT UNLGTD TWR 2.5 MI NE.

EXITING PAPA RAMP PARKING SPOTS P1/2/3, USE MIN THRUST REQ DUE TO JET BLAST HAZARD ON PAPA RAMP AND TWY UNIFORM.

ANCHORAGE WX CAMERA AVBL ON INTERNET AT [HTTPS://WEATHERCAMS.FAA.GOV](https://weathercams.faa.gov).

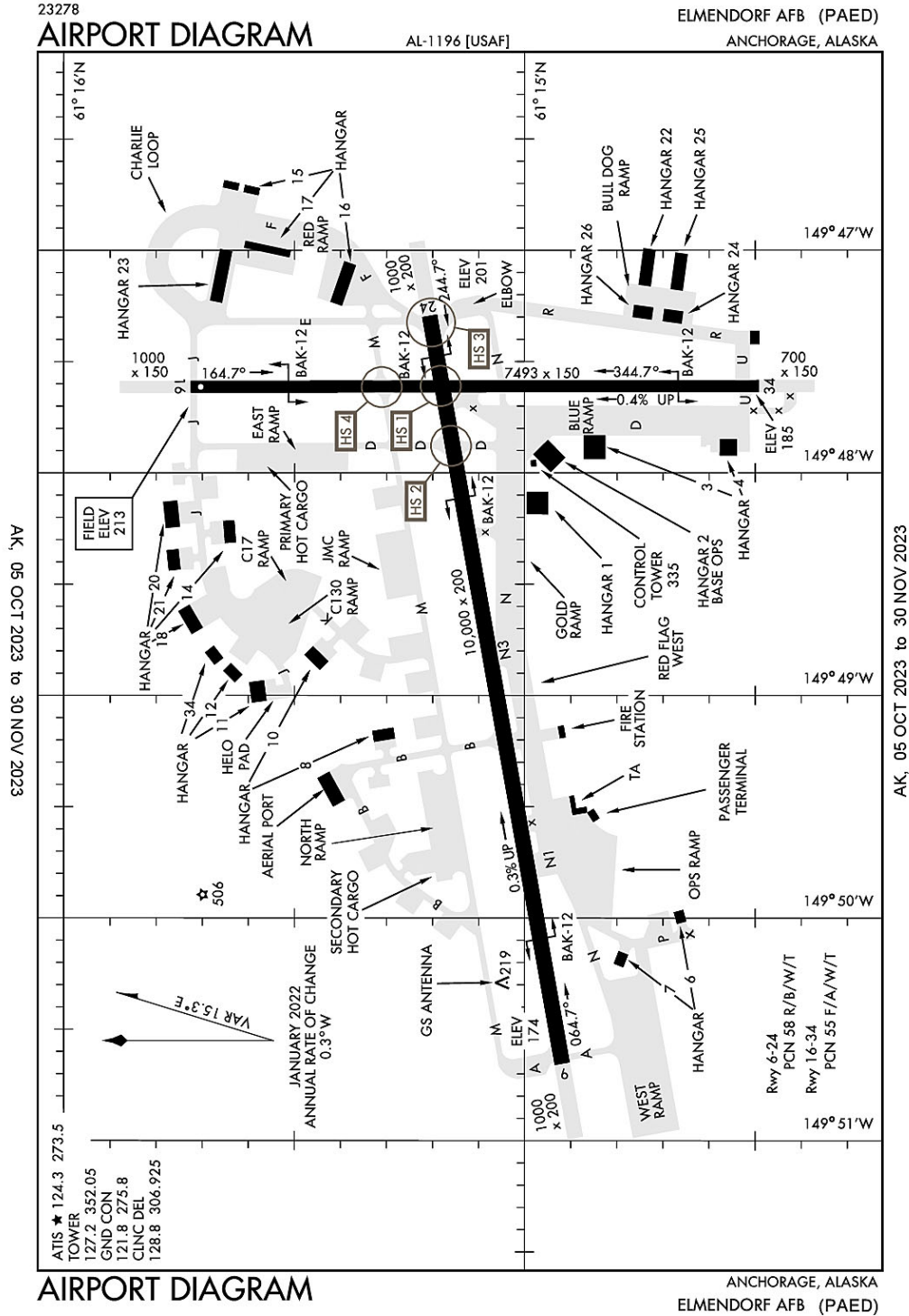
FLT PLANNING IN ANCHORAGE BOWL AREA - RCO 122.55.

FAA RAMP PPR WITH ANC FIFO MON-FRI 0600-1430 - 135.85 OR 907-271-2414 OR AVN 405-954-9780.

WSO - 907-266-5105.



Anchorage, Alaska  
Elmendorf AFB  
ICAO Identifier PAED



**Anchorage, AK**  
**Elmendorf AFB**  
**ICAO Identifier PAED**

**AD 2.2 Aerodrome geographical and administrative data**

- 2.2.1 Reference Point: 61-15-4.8715N / 149-48-23.4924W
- 2.2.2 From City: 3 miles NE of ANCHORAGE, AK
- 2.2.3 Elevation: 213 ft
- 2.2.5 Magnetic Variation: 18E (2015)
- 2.2.6 Airport Contact: AIRFIELD MGR  
300SS/DOFJ  
ELMENDORF AFB, AK 99506 (907-552-2444)
- 2.2.7 Traffic: IFR/VFR

**AD 2.3 Attendance Schedule**

- 2.3.1 All Months, All Days, All Hours

**AD 2.4 Handling Services and Facilities**

- 2.4.1 Cargo Handling Facilities: YES
- 2.4.2 Fuel Types: J8
- 2.4.5 Hangar Space:
- 2.4.6 Repair Facilities: None

**AD 2.6 Rescue and Firefighting Services**

- 2.6.1 Aerodrome Category: None
- 2.6.2 Rescue and Firefighting Services: None

**AD 2.12 Runway Physical Characteristics**

- 2.12.1 Designation: 06
- 2.12.2 True Bearing: 80
- 2.12.3 Dimensions: 10000 ft x 200 ft
- 2.12.4 PCN: 58 R/B/W/T
- 2.12.5 Coordinates: 61-14-55.08N / 149-50-39.34W
- 2.12.6 Threshold Elevation: 174.5 ft
- 2.12.6 Touchdown Zone Elevation: 174.5 ft
  
- 2.12.1 Designation: 24
- 2.12.2 True Bearing: 260
- 2.12.3 Dimensions: 10000 ft x 200 ft
- 2.12.4 PCN: 58 R/B/W/T
- 2.12.5 Coordinates: 61-15-12.16N / 149-47-18.02W
- 2.12.6 Threshold Elevation: 201.3 ft
- 2.12.6 Touchdown Zone Elevation: 201.3 ft
  
- 2.12.1 Designation: 16
- 2.12.2 True Bearing: 180
- 2.12.3 Dimensions: 7493 ft x 150 ft
- 2.12.4 PCN: 55 F/A/W/T
- 2.12.5 Coordinates: 61-15-43.43N / 149-47-36.52W
- 2.12.6 Threshold Elevation: 212.5 ft
- 2.12.6 Touchdown Zone Elevation: 212.4 ft

- 2.12.1 Designation: 34
- 2.12.2 True Bearing: 360
- 2.12.3 Dimensions: 7493 ft x 150 ft
- 2.12.4 PCN: 55 F/A/W/T
- 2.12.5 Coordinates: 61-14-29.64N / 149-47-36.57W
- 2.12.6 Threshold Elevation: 184.9 ft
- 2.12.6 Touchdown Zone Elevation: 194.1 ft

**AD 2.13 Declared Distances**

- 2.13.1 Designation: 06
- 2.13.2 Take-off Run Available:
- 2.13.3 Take-off Distance Available:
- 2.13.4 Accelerate-Stop Distance Available:
- 2.13.5 Landing Distance Available:

- 2.13.1 Designation: 24
- 2.13.2 Take-off Run Available:
- 2.13.3 Take-off Distance Available:
- 2.13.4 Accelerate-Stop Distance Available:
- 2.13.5 Landing Distance Available:

- 2.13.1 Designation: 16
- 2.13.2 Take-off Run Available:
- 2.13.3 Take-off Distance Available:
- 2.13.4 Accelerate-Stop Distance Available:
- 2.13.5 Landing Distance Available:

- 2.13.1 Designation: 34
- 2.13.2 Take-off Run Available:
- 2.13.3 Take-off Distance Available:
- 2.13.4 Accelerate-Stop Distance Available:
- 2.13.5 Landing Distance Available:

**AD 2.14 Approach and Runway Lighting**

- 2.14.1 Designation: 06
- 2.14.2 Approach Lighting System: ALSF1
- 2.14.4 Visual Approach Slope Indicator System: P4L

- 2.14.1 Designation: 24
- 2.14.2 Approach Lighting System:
- 2.14.4 Visual Approach Slope Indicator System: P4L

- 2.14.1 Designation: 16
- 2.14.2 Approach Lighting System:
- 2.14.4 Visual Approach Slope Indicator System: P4L

- 2.14.1 Designation: 34
- 2.14.2 Approach Lighting System:

2.14.4 Visual Approach Slope Indicator System: P4L

**AD 2.18 Air Traffic Services Communication Facilities**

2.18.1 Service Designation: ATIS

2.18.3 Channel: 124.3

2.18.5 Hours of Operation: 0700-2300

2.18.1 Service Designation: ATIS

2.18.3 Channel: 273.5

2.18.5 Hours of Operation: 0700-2300

2.18.1 Service Designation: CD/P

2.18.3 Channel: 128.8

2.18.5 Hours of Operation: 24

2.18.1 Service Designation: CD/P

2.18.3 Channel: 306.925

2.18.5 Hours of Operation: 24

2.18.1 Service Designation: GND/P

2.18.3 Channel: 121.8

2.18.5 Hours of Operation: 24

2.18.1 Service Designation: GND/P

2.18.3 Channel: 275.8

2.18.5 Hours of Operation: 24

2.18.1 Service Designation: LCL/P

2.18.3 Channel: 127.2

2.18.5 Hours of Operation: 24

2.18.1 Service Designation: LCL/P

2.18.3 Channel: 352.05

2.18.5 Hours of Operation: 24

2.18.1 Service Designation: OPS (11AF RESCUE COORD CNTR)

2.18.3 Channel: 123.1

2.18.5 Hours of Operation:

2.18.1 Service Designation: OPS (11AF RESCUE COORD CNTR)

2.18.3 Channel: 282.8

2.18.5 Hours of Operation:

2.18.1 Service Designation: OPS (11AF COMD CEN)

2.18.3 Channel: 381

2.18.5 Hours of Operation:

2.18.1 Service Designation: OPS (ARTIC WARRIOR OPS)

2.18.3 Channel: 381

2.18.5 Hours of Operation:

2.18.1 Service Designation: PMSV METRO  
2.18.3 Channel: 346.6  
2.18.5 Hours of Operation:

2.18.1 Service Designation: PTD  
2.18.3 Channel: 134.8  
2.18.5 Hours of Operation:

2.18.1 Service Designation: PTD  
2.18.3 Channel: 372.2  
2.18.5 Hours of Operation:

**AD 2.19 Radio Navigation and Landing Aids**

2.19.1 ILS Type: Glide Slope for runway 06. Magnetic variation: 18E  
2.19.2 ILS Identification: EDF  
2.19.5 Coordinates: 61-15-1.2N / 149-50-17W  
2.19.6 Site Elevation: 169.2 ft

2.19.1 ILS Type: Localizer for runway 06. Magnetic variation: 18E  
2.19.2 ILS Identification: EDF  
2.19.5 Coordinates: 61-15-14.33N / 149-46-52.29W  
2.19.6 Site Elevation: 212.3 ft

2.19.1 Navigation Aid Type: TACAN. Magnetic variation: 18E  
2.19.2 Navigation Aid Identification: EDF  
2.19.5 Coordinates: 61-15-18.03N / 149-46-9.03W  
2.19.6 Site Elevation: 226.2 ft

**General Remarks:**

DURING VMC DEPS/MISSED APCHS/GO AROUNDS; ACFT SHALL MAINTAIN AT OR BLW 1200 FT MLS UNTIL DEP END OF RWY 06.

RWY 34 HAS A 500 FT DISPLACED THLD ALLOWING 7993 FT USABLE FOR TKFS (RWY 34 TKFS ONLY). ACFT REQ TO USE THE ADDITIONAL 500 FT FOR RWY 34 TKF MUST CTC ATC.

EXTENSIVE SVC DELAY FOR FUEL.

CAUTION: UNLIT TERRAIN 0 FT AGL/341 FT MSL, 1909 FT PRIOR TO THLD, 1914 FT RIGHT OF COURSE.

TRAN ALERT ACFT SVC LTD TO POL SERVICING, INTAKE INSPECTIONS, MAGNETIC CHIP DETECTOR INSPECTIONS AND EOR INSPECTIONS.

QUIET HR 0630-1400Z WKDAYS; 0630-1600Z WKEND & HOLS, AMC ACFT EXEMPT.

PREVENTIVE MAINT: TACAN WED AND FRI 1600-1700Z; ILS TUE AND THR 1500-1700Z; PAR SAT-SUN 1800-2000Z; ASR SAT-SUN 2000-2200.

FREQUENT ACTIVITY IN R2203; WHEN UNABLE TO AVOID, CTC ATCT.

LIMITED MAINTENANCE CAPABILITIES ON WKEND.

JOAP & LOW & HIGH PRESURE NITROGEN SERVICING FURNISHED DURING NORMAL DUTY HOURS, OTR TIMES ON REQUEST.

UNLESS PARTICIPATING IN MAJCOM SPONSORED EXER AT ELMENDORF; DEPLOYED OR STAGED UNITS MUST CTC 3 WG SCHEDULING AT DSN 317-552-2406 OR C907-552-2406 AS EARLY AS POSSIBLE TO COORD LOCAL AREA ORIENTATION BRIEFING, MAINT SPONSORSHIP IF APPLICABLE, AND SUBMIT VISITING UNIT REQUEST FORM FOR 3 OG/CC APVL PRIOR TO LCL AREA OPS.

OIL: O-123, O-128, O-133, O-148, O-156, JOAP.

ACFT UNABLE TO MEET R2203 DEP RSTRNS ADVISE ATC PRIOR TO DEP; CONSIDER DEP RWY 24. SEE ATC NOTES IN GIANT REPORT.

HGR SPACE & WARM STORAGE EXTREMELY LMTD OCT-MAY.

RCR/RSC RWY 06/24 & 16/34 & FLD RCR CTC ATCT. RWY COND CODE & FICON NOT RPTD.

CHANGE JET AIRCRAFT STARTING UNITS (JASU) TO, (A/M32A-86), MC-1A), (MC-2A), (AM32A-60A). (AM32-95)150 +/-5 LBS/MIN (2055 +/-68CFM) AT 51 +/-02 PSIA. LASS 150 +/-5 LBS/MIN @ 49 +/-2 PSIA.

IF EXP TO USE RWY 16 FOR DEP OR RWY 34 FOR LDG SEE JBER CARTEE AIRSPACE DESCRIPTION IN NOTICES SEC OF THIS SUPPLEMENT.

ACFT REQUIRING CABLES DE-RIGGED MUST CTC BASE OPS 24 HR PRIOR TO ARR OR MAKE REQ PRIOR TO PPR BEING ISSUED.

ALL FTR ACFT ON ARR EXPECT REDUCED SEPARATION; SAME TYPE ACFT AND DAY 3000 FT; DISSIMILAR ACFT AND/OR NIGHT 6000 FT; AHEAD/BEHIND FORMATION LDG-6000 FT.

ALL NON-AMC ACFT RQR 732 AMS MAINT/SVC MAY EXPERIENCE LOGISTICAL DELAYS DUE TO MISSION NECESSITIES.

SPECIAL AIR TRAFFIC RULES FAR PART 93, SEE REGULATORY NOTICES IN THE SUPPLEMENT.

FLUID: PRESAIR, DE-ICE, NITROGEN-LHNT.

NORMAL BARRIER CONFIGURATION DUR FTR FLY WINDOW LEAVES 5675 FT BTN CABLES ON RWY 06/24, OUTSIDE OF FTR FLY WINDOWS THERE IS 7658 FT BTN CABLES.

RWY 34 DEPARTURES FOR ACFT WITH WINGSPANS GREATER THAN 98 FT RQR PRIOR COORD WITH AMC, ATC TWR, OR ALD MGT.

DV SPOTS 1 AND 3 LTD TO ACFT WITH WINGSPANS OF 136 FT OR LESS.

ALL VIP ACFT CTC BASE OPS 30 MIN PRIOR TO ARR ON PTD 372.2 OR 134.1 OR C907-552-2107.

UNITS DEPLOYING TO, STAGING OUT OF, OR FLYING LCL SORTIES AT ELMENDORF AFB MUST DEPLOY WITH MAINT PERS REQUIRED TO COMPLETE OPS TO INCLUDE DE-ICE QUALIFIED CREWMEMBERS DUR COLD WX OPS.

ANY DEPLOYED OR STAGED ACFT WILL NOT RCV TA SUPPORT BYD INITIAL BLOCK IN.

C17/C130 OVERT LIGHTS AVBL ON RWY 16/34. C17/C130 COVERT LIGHTS AVBL ON RWY 16.

NO SIGNS ACCOMPANYING HOLD SHORT LINES ON INTERSECTING RWYS.

CAUTION: MOOSE ON & INVOF RWY.

LNDG RWY 16 NOT RCMND FOR JET ACFT EXCPT DURG DAY VFR DUE OBSTRN 337 FT MSL LCTD 1950 FT FM THR & 574 FT W OF CNGLRN.

WX OPR H24; DSN 317-552-4903/4397, C907-552-4903/4397. AUGMENTED SFC VIS RSTD E-SW BY BLDG.

IFF SVC AVBL.

CAUTION: NUMEROUS ACFT WILL BE OPR IFR BETWEEN 1500-2000 MSL FROM BGQ 092/10 INTO R2203 TO EDF 320/07 INVOF BIG LAKE, PALMER, BIRCHWOOD, GOOSEBAY AND WASILLA, AK., MON-SAT 0300-0800Z++, AND TUES AND THU 1800-2200Z++.

CAUTION: WHEN RWY 16 VGS I INOP, STR-IN TO RWY 16 ONLY AUTHORIZED AT NIGHT WITH MAJCOM A3 APVL.

RWY 16/34 RWY DIST REMAINING (RDR) SIGNS NOT LCTD IN CORRECT LCTN. AT RWY 16 - 2 RDR 2487 FT OF RWY REMAINING. AT RWY 16 -1 RDR 1487 FT OF RWY REMAINING.

ACFT WITH WINGSPANS OF 145 FT OR GREATER MAY EXPERIENCE REDUCED WINGTIP CLNC DOWN TO 25 FT WHEN FIGHTER ACFT ARE LCTD IN NORTHERNMOST ELBOW EOR SPOT. TWY N FM RWY 16/34 TO TWY R RSTRD TO FIGHTER ACFT ONLY WHEN ACFT ARE STAGED IN ELBOW EOR. TWY N FM RWY 16/34 TO TWY R UNUSABLE WHEN FIGHTER ACFT STAGED IN SOUTHERNMOST ELBOW EOR SPOT.

NOTICE: A RIDGE EXTENDING FROM APPROXIMATELY 260-020 DEGS ONE TO TWO MILES FROM THE TOWER PREVENTS OBSERVATION OF FOG OVER KNIK ARM. VISIBILITY MAY DROP RAPIDLY AS FOG POURS OVER RIDGE.

CAUTION: RWY 16/34, USE EXTREME CAUTION TO AVOID FALLING BLW GP TO RWY 34. DECREASED OBST CLNC ON APCH END OF RWY 34. SEVERAL TREES EXCEED 2.5 DEG, 40:1, OR PAPI CLNC PLANES, OR FALL ONLY 30 FT BLW STD FLT PATH OF LDG ACFT.

AFLD MGMT DOES NOT HAVE COMSEC STORAGE AVBL, FOR COMSEC STORAGE CTC COMMAND POST DSN 317-552-3000.

AMC ACFT ON AN AMC ASGN MSN CAN EXP TO HAVE MAINT SVC ACCOMPLISHED BY 732 AMS.

ALL ACFT MAINTAIN IDLE POWER ON OUTBOARD ENG WHILE TAXIING.

NVD OPS ON RWY 16/34 & RWY 06/24 MON-FRI FROM 0400-1000Z++.

JOAP, JOINT OIL ANALYSIS PROGRAM AVBL. LHNT, LOW & HIGH PRESSURE NITROGEN SERVICING AVBL. DE-ICE, TYPE 1 DE-ICE LIFTOFF P-88; TYPE 4 ANTI-ICE CLARIANT SAFEWING MP-LAUNCH.

EAST RAMP HOT SPOT 19 LTD; 20K LBS N.E.W. CAT 1.1, AND 10K LBS N.E.W. CAT 1.2. COMPENSATORY MEASURES REQ FOR 1.1 N.E.W. >5K LBS AND 1.2 N.E.W. >8.8K LBS. COORDINATE ACFT PARKING WITH 732 AMS AND AFLD MGR. FOR BLDG EVAC CTC 907-552-2577.

PPRS WILL BE ISSUED NO EARLIER THAN 7 DAYS PRIOR TO ARR.

ACFT REQUIRING CUSTOMS AND AG INSPECTIONS ARE RQR TO CTC BASE OPS NO LATER THAN 90 MIN PRIOR TO ARR.

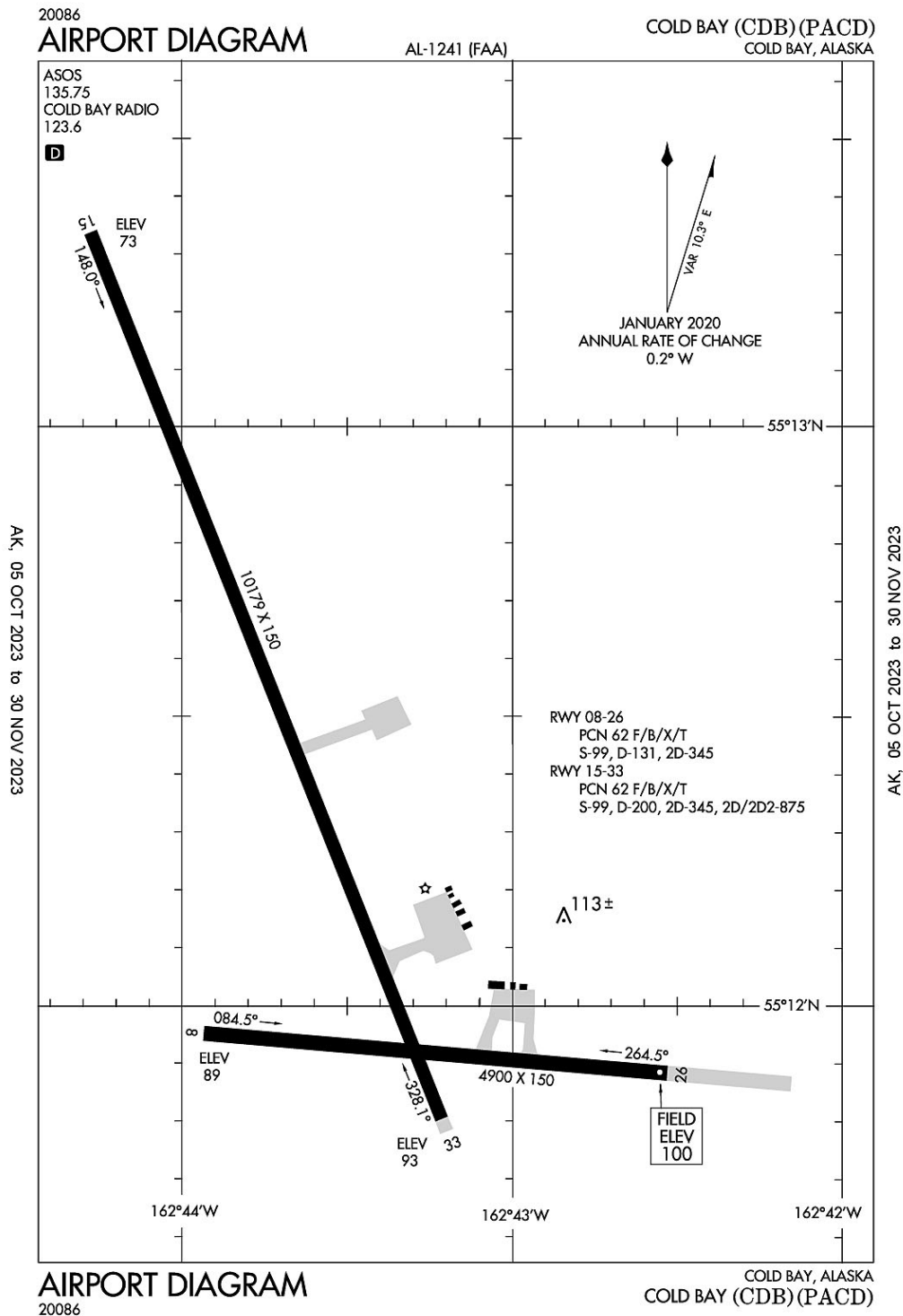
PPR REQUIRED FOR ALL NON JBER ASSIGNED ACFT EXCEPT NON-EXPLOSIVE LADEN AMCC ACFT UNLESS CONDUCTING LCL TRNG.

SUBMIT ALL PPR REQUESTS UTILIZING THE PAED PPR REQUEST FORM LOCATED IN THE PAED GIANT REPORT STIF TO BASEOPS3@US.AF.MIL NO EARLIER THAN 30 DAYS PRIOR AND NO LATER THAN 48 HOURS PRIOR TO ARRIVAL TO BEGIN COORDINATION FOR PPR.

TWYS N2 & N5 PERM CLOSED.



### Cold Bay, Alaska Cold Bay ICAO Identifier PACD



**Cold Bay, AK**  
**Cold Bay**  
**ICAO Identifier PACD**

**AD 2.2 Aerodrome geographical and administrative data**

- 2.2.1 Reference Point: 55-12-21.3N / 162-43-34.5W
- 2.2.2 From City: 0 miles N of COLD BAY, AK
- 2.2.3 Elevation: 99.5 ft
- 2.2.5 Magnetic Variation: 12E (2015)
- 2.2.6 Airport Contact: HAROLD KREMER  
BOX 97  
COLD BAY, AK 99571 (907-532-5000)
- 2.2.7 Traffic: IFR/VFR

**AD 2.3 Attendance Schedule**

- 2.3.1 All Months, MON – SAT Days, 0700 – 1800 Hours

**AD 2.4 Handling Services and Facilities**

- 2.4.1 Cargo Handling Facilities: YES
- 2.4.2 Fuel Types: 100LL,A
- 2.4.5 Hangar Space: YES
- 2.4.6 Repair Facilities: NONE

**AD 2.6 Rescue and Firefighting Services**

- 2.6.1 Aerodrome Category: Class-I certified on 4/1/2005
- 2.6.2 Rescue and Firefighting Services: ARFF Index-B

**AD 2.12 Runway Physical Characteristics**

- 2.12.1 Designation: 08
- 2.12.2 True Bearing: 95
- 2.12.3 Dimensions: 4900 ft x 150 ft
- 2.12.4 PCN: 62 F/B/X/T
- 2.12.5 Coordinates: 55-11-57.1589N / 162-43-56.7308W
- 2.12.6 Threshold Elevation: 88.9 ft
- 2.12.6 Touchdown Zone Elevation: 95.2 ft

- 2.12.1 Designation: 26
- 2.12.2 True Bearing: 275
- 2.12.3 Dimensions: 4900 ft x 150 ft
- 2.12.4 PCN: 62 F/B/X/T
- 2.12.5 Coordinates: 55-11-53.1425N / 162-42-32.588W
- 2.12.6 Threshold Elevation: 99.5 ft
- 2.12.6 Touchdown Zone Elevation: 99.5 ft

- 2.12.1 Designation: 15
- 2.12.2 True Bearing: 158
- 2.12.3 Dimensions: 10179 ft x 150 ft
- 2.12.4 PCN: 62 F/B/X/T
- 2.12.5 Coordinates: 55-13-20.4998N / 162-44-16.4235W
- 2.12.6 Threshold Elevation: 72.5 ft
- 2.12.6 Touchdown Zone Elevation: 75 ft

- 2.12.1 Designation: 33
- 2.12.2 True Bearing: 338
- 2.12.3 Dimensions: 10179 ft x 150 ft
- 2.12.4 PCN: 62 F/B/X/T
- 2.12.5 Coordinates: 55-11-47.2428N / 162-43-11.707W
- 2.12.6 Threshold Elevation: 93.3 ft
- 2.12.6 Touchdown Zone Elevation: 93.4 ft

**AD 2.13 Declared Distances**

- 2.13.1 Designation: 08
- 2.13.2 Take-off Run Available: 4900
- 2.13.3 Take-off Distance Available: 4900
- 2.13.4 Accelerate-Stop Distance Available: 4900
- 2.13.5 Landing Distance Available: 4900

- 2.13.1 Designation: 26
- 2.13.2 Take-off Run Available: 4900
- 2.13.3 Take-off Distance Available: 4900
- 2.13.4 Accelerate-Stop Distance Available: 4900
- 2.13.5 Landing Distance Available: 4900

- 2.13.1 Designation: 15
- 2.13.2 Take-off Run Available: 10179
- 2.13.3 Take-off Distance Available: 10179
- 2.13.4 Accelerate-Stop Distance Available: 10179
- 2.13.5 Landing Distance Available: 10179

- 2.13.1 Designation: 33
- 2.13.2 Take-off Run Available: 10179
- 2.13.3 Take-off Distance Available: 10179
- 2.13.4 Accelerate-Stop Distance Available: 10179
- 2.13.5 Landing Distance Available: 10179

**AD 2.14 Approach and Runway Lighting**

- 2.14.1 Designation: 08
- 2.14.2 Approach Lighting System:
- 2.14.4 Visual Approach Slope Indicator System: P4L

- 2.14.1 Designation: 26
- 2.14.2 Approach Lighting System:
- 2.14.4 Visual Approach Slope Indicator System: P4L

- 2.14.1 Designation: 15
- 2.14.2 Approach Lighting System: MALSR
- 2.14.4 Visual Approach Slope Indicator System:

- 2.14.1 Designation: 33
- 2.14.2 Approach Lighting System:

2.14.4 Visual Approach Slope Indicator System: P4L

## **AD 2.18 Air Traffic Services Communication Facilities**

### **AD 2.19 Radio Navigation and Landing Aids**

2.19.1 ILS Type: Glide Slope for runway 15. Magnetic variation: 12E

2.19.2 ILS Identification: CDB

2.19.5 Coordinates: 55-13-12.7692N / 162-44-3.6464W

2.19.6 Site Elevation: 71 ft

2.19.1 ILS Type: Localizer for runway 15. Magnetic variation: 12E

2.19.2 ILS Identification: CDB

2.19.5 Coordinates: 55-11-40.9813N / 162-43-7.3592W

2.19.6 Site Elevation: 95.9 ft

2.19.1 Navigation Aid Type: VORTAC. Magnetic variation: 10E

2.19.2 Navigation Aid Identification: CDB

2.19.5 Coordinates: 55-16-2.2606N / 162-46-26.3866W

2.19.6 Site Elevation: 98.5 ft

#### **General Remarks:**

PERSONNEL & EQUIP ON RWY.

SNOW, ICE REMOVAL & ARPT HAZ RPTG DURG DUTY HR UNLESS PRIOR ARNGMT IN WRITING – AMGR.

ARPT SAND LRGR GRADE THAN FAA RCMDD/SEE AC150/5200-30.

NWS BALLOON LAUNCH FAC LCTD ON ARPT; SEE INSIDE BACK COVER FOR DETAILS.

WX CAMERA AVBL – [HTTPS://WEATHERCAMS.FAA.GOV](https://weathercams.faa.gov)

NO CUSTOMS AVBL; 24-48 HR WRITTEN PPR FOR FOREIGN ARR RFLG STOPS – FAX 907-271-2684 OR 907-271-2686.

UNLGTD TWR 0.4 NM N; UNLGTD TWR 0.9 NM S; UNLGTD TWR 4.8 NM NW.

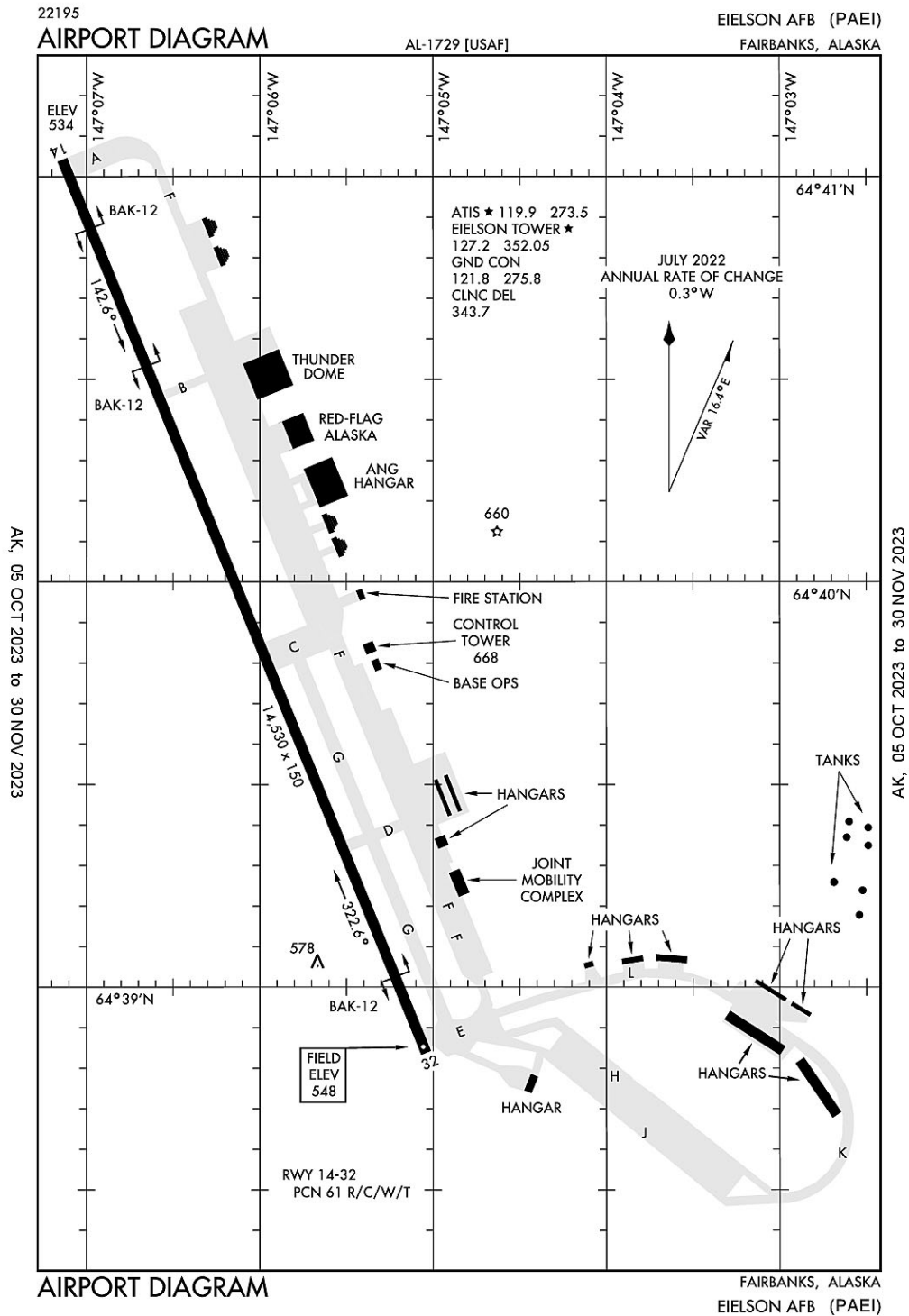
BRAKELOCK TURNS NA.

ROTG BCN UNMON WHEN FSS UNMANNED.

CFR INDEX B; MAY BE REDUCED FOR ACFT LESS THAN 90 FT.

BIRDS INVOF ALL RWY APCH ENDS.

**Fairbanks, Alaska  
Eielson AFB  
ICAO Identifier PAEI**



**Fairbanks, AK**  
**Eielson AFB**  
**ICAO Identifier PAEI**

**AD 2.2 Aerodrome geographical and administrative data**

- 2.2.1 Reference Point: 64-39-56.32N / 147-6-5.18W
- 2.2.2 From City: 17 miles SE of FAIRBANKS, AK
- 2.2.3 Elevation: 547.5 ft
- 2.2.5 Magnetic Variation: 19E (2015)
- 2.2.6 Airport Contact: CHIEF AIRFIELD MANAGEMENT  
343 CSG/OTM  
EIELSON AFB, AK 99702 (907-377-3201)
- 2.2.7 Traffic: IFR/VFR

**AD 2.3 Attendance Schedule**

- 2.3.1 All Months, All Days, 1600-0800Z++ Hours

**AD 2.4 Handling Services and Facilities**

- 2.4.1 Cargo Handling Facilities: NO
- 2.4.2 Fuel Types:
- 2.4.5 Hangar Space: YES
- 2.4.6 Repair Facilities: None

**AD 2.6 Rescue and Firefighting Services**

- 2.6.1 Aerodrome Category: None
- 2.6.2 Rescue and Firefighting Services: None

**AD 2.12 Runway Physical Characteristics**

- 2.12.1 Designation: 32
- 2.12.2 True Bearing: 339
- 2.12.3 Dimensions: 14530 ft x 150 ft
- 2.12.4 PCN: 61 R/C/W/T
- 2.12.5 Coordinates: 64-38-49.48N / 147-5-5.85W
- 2.12.6 Threshold Elevation: 547.5 ft
- 2.12.6 Touchdown Zone Elevation: 547.5 ft

- 2.12.1 Designation: 14
- 2.12.2 True Bearing: 159
- 2.12.3 Dimensions: 14530 ft x 150 ft
- 2.12.4 PCN: 61 R/C/W/T
- 2.12.5 Coordinates: 64-41-3.14N / 147-7-4.52W
- 2.12.6 Threshold Elevation: 533.9 ft
- 2.12.6 Touchdown Zone Elevation: 536.8 ft

**AD 2.13 Declared Distances**

- 2.13.1 Designation: 32
- 2.13.2 Take-off Run Available:
- 2.13.3 Take-off Distance Available:
- 2.13.4 Accelerate-Stop Distance Available:
- 2.13.5 Landing Distance Available:

- 2.13.1 Designation: 14
- 2.13.2 Take-off Run Available:
- 2.13.3 Take-off Distance Available:
- 2.13.4 Accelerate-Stop Distance Available:
- 2.13.5 Landing Distance Available:

**AD 2.14 Approach and Runway Lighting**

- 2.14.1 Designation: 32
- 2.14.2 Approach Lighting System: ALSF1
- 2.14.4 Visual Approach Slope Indicator System: P4L

- 2.14.1 Designation: 14
- 2.14.2 Approach Lighting System: ALSF1
- 2.14.4 Visual Approach Slope Indicator System: P4L

**AD 2.18 Air Traffic Services Communication Facilities**

- 2.18.1 Service Designation: ATIS
- 2.18.3 Channel: 119.9
- 2.18.5 Hours of Operation: 1600-0800Z++

- 2.18.1 Service Designation: ATIS
- 2.18.3 Channel: 273.5
- 2.18.5 Hours of Operation: 1600-0800Z++

- 2.18.1 Service Designation: CD/P
- 2.18.3 Channel: 343.7
- 2.18.5 Hours of Operation: 1600-0800Z++

- 2.18.1 Service Designation: COMD POST (IGLOO OPS)
- 2.18.3 Channel: 259.5
- 2.18.5 Hours of Operation:

- 2.18.1 Service Designation: COMD POST (IGLOO OPS, HAVE QUICK)
- 2.18.3 Channel: 289.4
- 2.18.5 Hours of Operation:

- 2.18.1 Service Designation: GND/P
- 2.18.3 Channel: 121.8
- 2.18.5 Hours of Operation: 1600-0800Z++

- 2.18.1 Service Designation: GND/P
- 2.18.3 Channel: 275.8
- 2.18.5 Hours of Operation: 1600-0800Z++

- 2.18.1 Service Designation: LCL/P
- 2.18.3 Channel: 127.2
- 2.18.5 Hours of Operation: 1600-0800Z++

2.18.1 Service Designation: LCL/P  
2.18.3 Channel: 352.05  
2.18.5 Hours of Operation: 1600-0800Z++

2.18.1 Service Designation: OPS (SOURDOUGH)  
2.18.3 Channel: 139.6  
2.18.5 Hours of Operation:

2.18.1 Service Designation: OPS (168 ANG OPS)  
2.18.3 Channel: 238.3  
2.18.5 Hours of Operation:

2.18.1 Service Designation: OPS (168 ANG OPS)  
2.18.3 Channel: 293.6  
2.18.5 Hours of Operation:

2.18.1 Service Designation: OPS (SOURDOUGH)  
2.18.3 Channel: 359.15  
2.18.5 Hours of Operation:

2.18.1 Service Designation: PTD  
2.18.3 Channel: 139.3  
2.18.5 Hours of Operation:

2.18.1 Service Designation: PTD  
2.18.3 Channel: 372.2  
2.18.5 Hours of Operation:

2.18.1 Service Designation: RANGE CTL (SUAIS RADIO)  
2.18.3 Channel: 125.3  
2.18.5 Hours of Operation:

2.18.1 Service Designation: SFA  
2.18.3 Channel: 118.6  
2.18.5 Hours of Operation:

2.18.1 Service Designation: SFA  
2.18.3 Channel: 259.1  
2.18.5 Hours of Operation:

2.18.1 Service Designation: SFA  
2.18.3 Channel: 318.2  
2.18.5 Hours of Operation:

2.18.1 Service Designation: SFA  
2.18.3 Channel: 320.1  
2.18.5 Hours of Operation:

2.18.1 Service Designation: SFA  
2.18.3 Channel: 324.3  
2.18.5 Hours of Operation:



**AD 2.19 Radio Navigation and Landing Aids**

2.19.1 ILS Type: Glide Slope for runway 14. Magnetic variation: 19E

2.19.2 ILS Identification: EIL

2.19.5 Coordinates: 64-40-51.59N / 147-7-6.54W

2.19.6 Site Elevation: 532 ft

2.19.1 ILS Type: Localizer for runway 14. Magnetic variation: 19E

2.19.2 ILS Identification: EIL

2.19.5 Coordinates: 64-38-33.05N / 147-4-51.27W

2.19.6 Site Elevation: 548 ft

2.19.1 ILS Type: Glide Slope for runway 32. Magnetic variation: 19E

2.19.2 ILS Identification: EAF

2.19.5 Coordinates: 64-38-58.93N / 147-5-25.28W

2.19.6 Site Elevation: 540 ft

2.19.1 ILS Type: Localizer for runway 32. Magnetic variation: 19E

2.19.2 ILS Identification: EAF

2.19.5 Coordinates: 64-41-22.13N / 147-7-21.41W

2.19.6 Site Elevation: 528 ft

2.19.1 Navigation Aid Type: TACAN. Magnetic variation: 19E

2.19.2 Navigation Aid Identification: EIL

2.19.5 Coordinates: 64-39-13.67N / 147-5-38.21W

2.19.6 Site Elevation: 542.4 ft

**General Remarks:**

SEE AP1 SUP RMKS: BASE OPS COMSEC RESPONSIBILITY NA; LTD SECRET & COMSEC STORAGE AVBL.  
TOP SECRET & COMSEC INFO – COMMAND POST D317-377-1500.

ALASKA ANG 168TH AREFS OPS – D317-377-8800/C907-377-8800. ANG OPS H24 – D317-377-1861/3201.

AIR TERM & GND HANDLING SVC 1630-0030Z++ WKDAY; PPR OR EXP DELAY – AFLD MGMT.

EXTSV FUEL DELAYS DURG RED FLAG ALASKA EXER APR-OCT.

CARGO & ACR CTC COMMAND POST 3 HR PRIOR & 30 MIN PROIR TO LNDG.

MAINT OPS CNTR PPR 48 HR FM ETA – D317-377-1205. DEPLOYED OR STAGED ACFT TA SUPPORT NA BYD  
INITIAL BLOCK IN/FINAL BLOCK OUT; EXC MAJCOM EXER AT EIELSON. UHF PREF PAT FREQ.

FAIRBANKS FSS – 474-0137. FLT ADZY OR RSTRD & MIL OPRG AREA STATUS – EIELSON RANGE CTL SUAIS  
RADIO 125.3 OR 1-800-758-8723.

AVOID SMALL ARMS RANGE 2.5 NM E OF RWY 32 END; WKEND 1700-0100Z++; SFC – 3500 FT AGL.

CRYPTO MTRL TSNT CREW NOT AVBL. VIP 30 MIN PPR WITH CHOCK TIME – AFLD MGMT. LTD FLEET SVC.  
NO POTABLE WATER.

PRIME KNIGHT NOT AVBL.

CTN: NSTD LGT; 2000 FT RWY EDGE LGT BTN D – C TWY; 12 FT FM RWY EDGE.

PTNS OF APRON O ROW & S RAMP NOT VIS FROM TWR.

H24 OPS; OFFL BUS ONLY. QUIET HR 0800-1500Z; UNCTLD TKOF/LDG NA; EXCEPTIONS RQR OG/CC APVL.

FICON & RWY COND CODE NOT RPRTD.

BASH PHASE II APR, MAY, AUG & SEP. GULLS, DUCKS & GEESE POSE HAZARD WHEN STANDING WATER ON FLD. RPT BIRD & ANIMAL STRIKES INVOF ARPT TO AFLD MGMT - D317-377-186, PTD OR 354 FW/SE D317-377-4110.

N & S BARRIER RUNOUT REDUCED TO 950 FT.

ARFF STATUS CRITICAL LVL OF SVC (CLS) 62% FOR USAF CAT 10; REDUCED LVL OF SVC (RLS) 81% FOR USAF CAT 9.

TSNT CTC 15 OWS DURG AFLD CLOSURE FOR WX BRIEFING - D576-9755/C618-256-9755; IF PSBL 3 HR PN.

BIRD WATCH COND MOD LCL PAT LTD TO MIN RQR WITH OG/CC APVL; TGL, FORMATION TKOF/LNDG NA; LOW APCH LTD TO 300 FT AGL. BIRD WATCH COND SVR; TKOF, PAT & LNDG NA EXC EMERG.

PPR 5 DAYS - 24 HR PRIOR TO ARR - ARFLD MGMT D317-377-1861/C907-377-1861. PPR GOOD +/- 30 MIN ARR TIME; COORD PPR AFT TIME BY FONE OR PPR CNLD. EXP ARR TIME RSTRN EXC AIR EVAC & DV CODE 7 & UP.

MOOSE ON & INVOF RWY.

CONTINGENCY OPS - AMGR.

NO PALLET TRAINS LONGER THAN T3 WITH OVERHANG WILL BE ACPTD DUE TO 25K LOADER SUPPORT.

LOOP TWY E OF CORROSION HANGAR 1348 THRU 4/8 BAY AREA RSTRD TO WINGSPAN 45 FT OR LESS.

TSNT CTC PTD AT LEAST 30 MIN PRIOR TO ARR. EIELSON AFB IS A 1 MOG STATION.

TRAN ALERT: TSNT MAINT LTD TO F16 SVCG UPON AIRCREW REQ. F16 THRU FLIGHT/BPO/PREFLIGHT INSP NA.

PACAF FTR ARR EXP RDCD RWY SEP; SIMILAR TYPE/DAY - 3000 FT; DISSIMILAR TYPE, NGT, WET RWY, BHND FRMN OR RCR LESS THAN 17 - 6000 FT; FTR LDG BHND NON FTR - 9000 FT; RCR VALIDATED AS COND WARRANT.

TRANS ALERT SVC 0700-0000 MON-FRI EXP HOL; AFT HR PPR - BASOPS.

CTN: FIRE HYDRANTS 64 FT NE OF TWY H CNTLN.

RADIO/NAV/WX RMRKS - (F) 1500-0700Z ++ DAILY.

PAEW ON RWY WHEN TWR UNMANNED.

LOAD/OFF LOAD ENG RUN NA. ERO SVC AVBL FOR AMC ACFT.

VHF PTD FREQ UNMNT.

MIL FLUID DE-ICE AVBL; ANTI ICE UNAVBL.

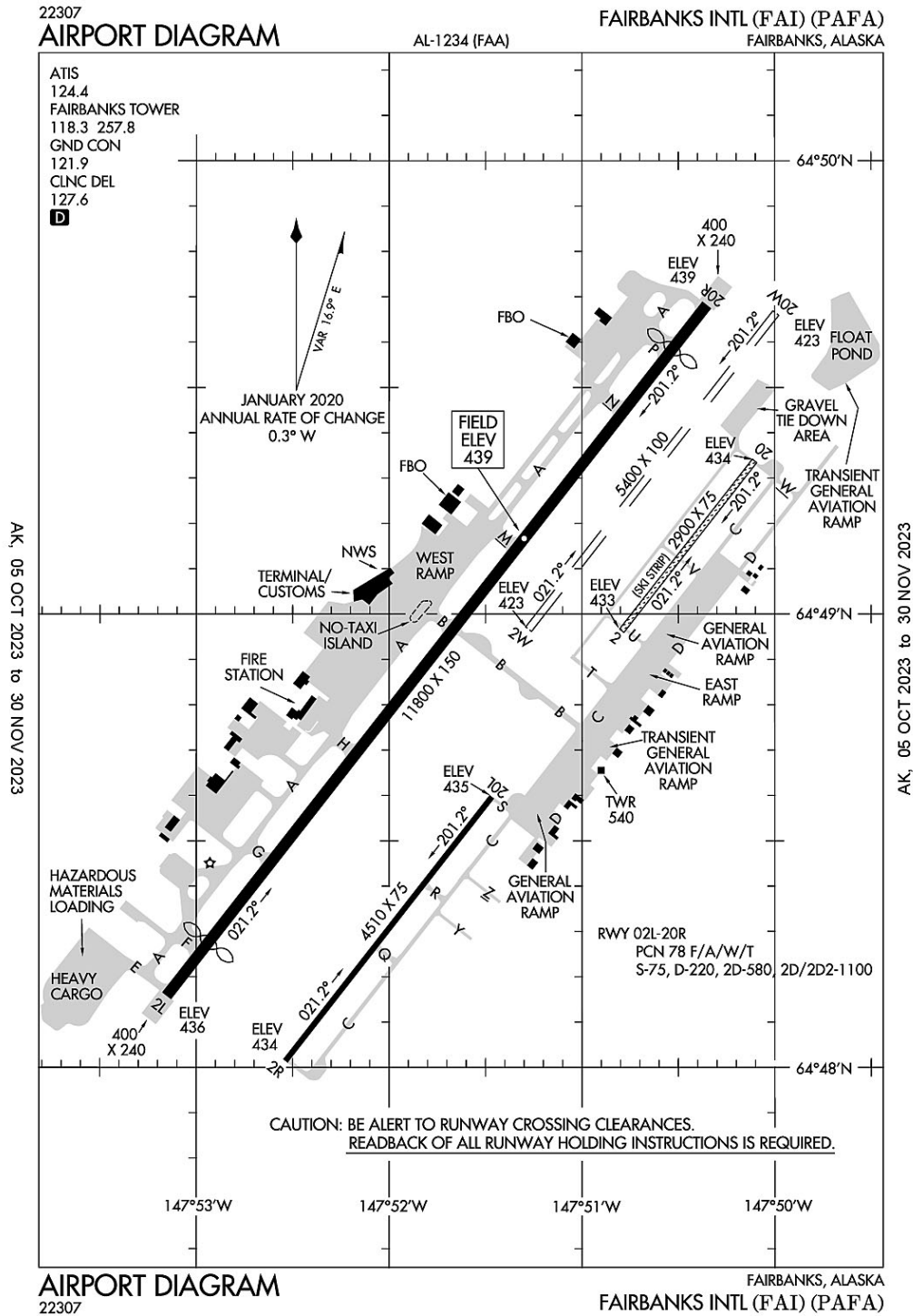
WX SVC H24 EXC AFLD/TWR CLOSURE - D377-1160/3140/C907-377-1160/3140; AN/FMQ-19 AUTOMATED OBS SYS AUGMENTED BY HUMAN OBSN. FMQ19 907-377-5846.

FILE FLT PLAN 2 HR BFR DEP. ARR RQR CUSTOMS 1.5 HR PPR - COMMAND POST. U.S. IMMIGRATION SVC NOT AVBL.

OVHD TFC PAT ALT 2000 FT MSL; RECTANGULAR TFC PAT ALT 1500 FT MSL.

RWY 14/32 BAK-12 DEP END CABLES IN RAISED POSITION; BAK-12 AER 14/32 AVBL WITH 20 MIN PRIOR NOTICE. NORTH BARRIER RUNOUT REDUCED TO 950 FT, HOOK EQUIPPED ACFT BE ALERT.

### Fairbanks, Alaska Fairbanks International ICAO Identifier PAFA



**Fairbanks, AK**  
**Fairbanks Intl**  
**ICAO Identifier PAFA**

**AD 2.2 Aerodrome geographical and administrative data**

- 2.2.1 Reference Point: 64-48-55.28N / 147-51-24W
- 2.2.2 From City: 3 miles SW of FAIRBANKS, AK
- 2.2.3 Elevation: 439 ft
- 2.2.5 Magnetic Variation: 15E (2025)
- 2.2.6 Airport Contact: ANGIE SPEAR  
6450 AIRPORT WAY – SUITE 1  
FAIRBANKS, AK 99709 (907-474-2500)
- 2.2.7 Traffic: IFR/VFR

**AD 2.3 Attendance Schedule**

- 2.3.1 All Months, All Days, All Hours

**AD 2.4 Handling Services and Facilities**

- 2.4.1 Cargo Handling Facilities: YES
- 2.4.2 Fuel Types: 100LL,A1
- 2.4.5 Hangar Space: YES
- 2.4.6 Repair Facilities: MAJOR

**AD 2.6 Rescue and Firefighting Services**

- 2.6.1 Aerodrome Category: Class-I certified on 3/1/2005
- 2.6.2 Rescue and Firefighting Services: ARFF Index-C

**AD 2.12 Runway Physical Characteristics**

- 2.12.1 Designation: 02
- 2.12.2 True Bearing: 38
- 2.12.3 Dimensions: 2900 ft x 75 ft
- 2.12.4 PCN:
- 2.12.5 Coordinates: 64-48-57.8002N / 147-50-47.5998W
- 2.12.6 Threshold Elevation: 433 ft
- 2.12.6 Touchdown Zone Elevation: 434.6 ft

- 2.12.1 Designation: 20
- 2.12.2 True Bearing: 218
- 2.12.3 Dimensions: 2900 ft x 75 ft
- 2.12.4 PCN:
- 2.12.5 Coordinates: 64-49-20.2644N / 147-50-6.2715W
- 2.12.6 Threshold Elevation: 433.6 ft
- 2.12.6 Touchdown Zone Elevation: 434.6 ft

- 2.12.1 Designation: 02L
- 2.12.2 True Bearing: 38
- 2.12.3 Dimensions: 11800 ft x 150 ft
- 2.12.4 PCN: 78 F/A/W/T
- 2.12.5 Coordinates: 64-48-9.4756N / 147-53-9.1838W
- 2.12.6 Threshold Elevation: 435.6 ft
- 2.12.6 Touchdown Zone Elevation: 438.6 ft

2.12.1 Designation: 20R  
2.12.2 True Bearing: 218  
2.12.3 Dimensions: 11800 ft x 150 ft  
2.12.4 PCN: 78 F/A/W/T  
2.12.5 Coordinates: 64-49-40.9108N / 147-50-21.1293W  
2.12.6 Threshold Elevation: 438.9 ft  
2.12.6 Touchdown Zone Elevation: 439 ft

2.12.1 Designation: 02R  
2.12.2 True Bearing: 38  
2.12.3 Dimensions: 4510 ft x 75 ft  
2.12.4 PCN:  
2.12.5 Coordinates: 64-48-0.8616N / 147-52-32.2332W  
2.12.6 Threshold Elevation: 433.5 ft  
2.12.6 Touchdown Zone Elevation: 433.8 ft

2.12.1 Designation: 20L  
2.12.2 True Bearing: 218  
2.12.3 Dimensions: 4510 ft x 75 ft  
2.12.4 PCN:  
2.12.5 Coordinates: 64-48-35.8092N / 147-51-28.0275W  
2.12.6 Threshold Elevation: 434.5 ft  
2.12.6 Touchdown Zone Elevation: 434.5 ft

2.12.1 Designation: 20W  
2.12.2 True Bearing: 218  
2.12.3 Dimensions: 5400 ft x 100 ft  
2.12.4 PCN:  
2.12.5 Coordinates: 64-49-39.8349N / 147-49-59.6293W  
2.12.6 Threshold Elevation: 423.4 ft  
2.12.6 Touchdown Zone Elevation: 423.4 ft

2.12.1 Designation: 02W  
2.12.2 True Bearing: 38  
2.12.3 Dimensions: 5400 ft x 100 ft  
2.12.4 PCN:  
2.12.5 Coordinates: 64-48-58.0039N / 147-51-16.5892W  
2.12.6 Threshold Elevation: 423.4 ft  
2.12.6 Touchdown Zone Elevation: 423.4 ft

**AD 2.13 Declared Distances**

2.13.1 Designation: 02  
2.13.2 Take-off Run Available:  
2.13.3 Take-off Distance Available:  
2.13.4 Accelerate-Stop Distance Available:  
2.13.5 Landing Distance Available:

2.13.1 Designation: 20  
2.13.2 Take-off Run Available:

2.13.3 Take-off Distance Available:  
2.13.4 Accelerate-Stop Distance Available:  
2.13.5 Landing Distance Available:

2.13.1 Designation: 02L  
2.13.2 Take-off Run Available: 11800  
2.13.3 Take-off Distance Available: 12800  
2.13.4 Accelerate-Stop Distance Available: 11800  
2.13.5 Landing Distance Available: 11050

2.13.1 Designation: 20R  
2.13.2 Take-off Run Available: 11800  
2.13.3 Take-off Distance Available: 12800  
2.13.4 Accelerate-Stop Distance Available: 11800  
2.13.5 Landing Distance Available: 11050

2.13.1 Designation: 02R  
2.13.2 Take-off Run Available:  
2.13.3 Take-off Distance Available:  
2.13.4 Accelerate-Stop Distance Available:  
2.13.5 Landing Distance Available:

2.13.1 Designation: 20L  
2.13.2 Take-off Run Available:  
2.13.3 Take-off Distance Available:  
2.13.4 Accelerate-Stop Distance Available:  
2.13.5 Landing Distance Available:

2.13.1 Designation: 20W  
2.13.2 Take-off Run Available:  
2.13.3 Take-off Distance Available:  
2.13.4 Accelerate-Stop Distance Available:  
2.13.5 Landing Distance Available:

2.13.1 Designation: 02W  
2.13.2 Take-off Run Available:  
2.13.3 Take-off Distance Available:  
2.13.4 Accelerate-Stop Distance Available:  
2.13.5 Landing Distance Available:

#### **AD 2.14 Approach and Runway Lighting**

2.14.1 Designation: 02  
2.14.2 Approach Lighting System:  
2.14.4 Visual Approach Slope Indicator System:

2.14.1 Designation: 20  
2.14.2 Approach Lighting System:  
2.14.4 Visual Approach Slope Indicator System:

2.14.1 Designation: 02L

2.14.2 Approach Lighting System: ALSF2  
2.14.4 Visual Approach Slope Indicator System: P4L

2.14.1 Designation: 20R  
2.14.2 Approach Lighting System: MALSR  
2.14.4 Visual Approach Slope Indicator System: P4L

2.14.1 Designation: 02R  
2.14.2 Approach Lighting System:  
2.14.4 Visual Approach Slope Indicator System: P4L

2.14.1 Designation: 20L  
2.14.2 Approach Lighting System:  
2.14.4 Visual Approach Slope Indicator System: P4L

2.14.1 Designation: 20W  
2.14.2 Approach Lighting System:  
2.14.4 Visual Approach Slope Indicator System:

2.14.1 Designation: 02W  
2.14.2 Approach Lighting System:  
2.14.4 Visual Approach Slope Indicator System:

**AD 2.18 Air Traffic Services Communication Facilities**

2.18.1 Service Designation: APCH/P DEP/P (360-179)  
2.18.3 Channel: 127.1  
2.18.5 Hours of Operation: 24

2.18.1 Service Designation: APCH/P DEP/P (360-179)  
2.18.3 Channel: 251.1  
2.18.5 Hours of Operation: 24

2.18.1 Service Designation: APCH/P DEP/P IC (180-359)  
2.18.3 Channel: 125.35  
2.18.5 Hours of Operation: 24

2.18.1 Service Designation: APCH/P DEP/P IC (180-359)  
2.18.3 Channel: 363.2  
2.18.5 Hours of Operation: 24

2.18.1 Service Designation: APCH/S  
2.18.3 Channel: 119.85  
2.18.5 Hours of Operation: 24

2.18.1 Service Designation: ATIS  
2.18.3 Channel: 124.4  
2.18.5 Hours of Operation: 24

2.18.1 Service Designation: CD/P  
2.18.3 Channel: 127.6



2.18.5 Hours of Operation: 24

2.18.1 Service Designation: DEP/S

2.18.3 Channel: 327.1

2.18.5 Hours of Operation: 24

2.18.1 Service Designation: EMERG

2.18.3 Channel: 121.5

2.18.5 Hours of Operation:

2.18.1 Service Designation: EMERG

2.18.3 Channel: 243

2.18.5 Hours of Operation:

2.18.1 Service Designation: GND/P

2.18.3 Channel: 121.9

2.18.5 Hours of Operation: 24

2.18.1 Service Designation: LCL/P

2.18.3 Channel: 118.3

2.18.5 Hours of Operation: 24

2.18.1 Service Designation: LCL/P

2.18.3 Channel: 257.8

2.18.5 Hours of Operation: 24

2.18.1 Service Designation: TRSA (180–359)

2.18.3 Channel: 125.35

2.18.5 Hours of Operation: 24

2.18.1 Service Designation: TRSA (360–179)

2.18.3 Channel: 127.1

2.18.5 Hours of Operation: 24

2.18.1 Service Designation: TRSA (360–179)

2.18.3 Channel: 251.1

2.18.5 Hours of Operation: 24

2.18.1 Service Designation: TRSA (180–359)

2.18.3 Channel: 363.2

2.18.5 Hours of Operation: 24

### **AD 2.19 Radio Navigation and Landing Aids**

2.19.1 ILS Type: DME for runway 02L. Magnetic variation: 15E

2.19.2 ILS Identification: CNA

2.19.5 Coordinates: 64–49–50.7376N / 147–50–15.0194W

2.19.6 Site Elevation: 434.8 ft

2.19.1 ILS Type: Glide Slope for runway 02L. Magnetic variation: 15E

2.19.2 ILS Identification: CNA

2.19.5 Coordinates: 64-48-21.0041N / 147-52-36.2974W  
2.19.6 Site Elevation: 431.4 ft

2.19.1 ILS Type: Inner Marker for runway 02L. Magnetic variation: 15E  
2.19.2 ILS Identification: CNA  
2.19.5 Coordinates: 64-48-7.6611N / 147-53-12.5267W  
2.19.6 Site Elevation: 429.8 ft

2.19.1 ILS Type: Localizer for runway 02L. Magnetic variation: 15E  
2.19.2 ILS Identification: CNA  
2.19.5 Coordinates: 64-49-49.8419N / 147-50-4.688W  
2.19.6 Site Elevation: 438.1 ft

2.19.1 ILS Type: DME for runway 20R. Magnetic variation: 15E  
2.19.2 ILS Identification: FAI  
2.19.5 Coordinates: 64-48-2.289N / 147-53-30.754W  
2.19.6 Site Elevation: 430 ft

2.19.1 ILS Type: Glide Slope for runway 20R. Magnetic variation: 15E  
2.19.2 ILS Identification: FAI  
2.19.5 Coordinates: 64-49-24.4215N / 147-50-39.7123W  
2.19.6 Site Elevation: 434.3 ft

2.19.1 ILS Type: Localizer for runway 20R. Magnetic variation: 15E  
2.19.2 ILS Identification: FAI  
2.19.5 Coordinates: 64-48-1.4733N / 147-53-23.8771W  
2.19.6 Site Elevation: 429.1 ft

2.19.1 Navigation Aid Type: VORTAC. Magnetic variation: 21E  
2.19.2 Navigation Aid Identification: FAI  
2.19.5 Coordinates: 64-48-0.2537N / 148-0-43.1132W  
2.19.6 Site Elevation: 1526.4 ft

**General Remarks:**

WATERLANE IS CONTROLLED; CTC ATCT ON FREQ 118.3 FOR APPROVAL. WATERLANE THRESHOLD BUOYS ARE 500 FROM N AND S SHORES AND MARK WATERLANE. STEP TAXI PROHIBITED OUTSIDE OF WATERLANE. EAST OF WATERLANE IS UNCONTROLLED; AIRCRAFT MAY TAXI IN THIS AREA AT PILOT DISCRETION. RECOMMEND CTC CLNC DEL AS SOON AS PRACTICAL AFTER ENG START. SFC FROZEN IN WINTER, NOT MONITORED. LIMITED TRANSIENT FLOAT PLANE PARKING AVBL CTC 907-455-4571. MIGRATORY BIRDS IN THE VICINITY OF ARPT DURING SPRING THRU FALL.

ALL RWY HOLD LINES OBSCURED OCTOBER 1 THRU APRIL 1.

WX CAMERA AVBL ON INTERNET AT [HTTPS://WEATHERCAMS.FAA.GOV](https://weathercams.faa.gov).

NWS WEATHER BALLOON LAUNCH SITE 2000 FEET WEST OF MIDFIELD RUNWAY 02L/20R. LAUNCHES ARE TWICE DAILY AT 1100 AND 2300 HOURS UTC.

MILITARY CONTRACT FUEL AVBL.

COLD TEMPERATURE AIRPORT. ALTITUDE CORRECTION REQUIRED AT OR BELOW -32C.

FOR AVBLTY OF SUMMER GRAVEL STRIP RWY 02/20 AND WINTER SKI STRIP RWY 02/20 CONSULT LOCAL NOTAMS AND CTC TWR PRIOR TO ARRIVAL /DEPARTURE.

TWY B SECURITY GATE BETWEEN RWY 02L/20R AND TWY CHARLIE KEY 121.75 5 TIMES TO ACTIVATE. IF TWY B GATE INOPERATIVE, WAIT 30 SECONDS TO RESET AND TRY AGAIN. IF UNSUCCESSFUL, NOTIFY FAI OPS, 907-451-2300

COMPASS ROSE NOT CALIBRATED.

FOR TRANSIENT HELICOPTER PARKING CALL ARPT OPS 907-451-2300.

RWY 02R/20L & RWY GRVL/SKI 02/20 NOT AVBL FOR SCHEDULED OR UNSCHEDULED ACR OPNS WITH MORE THAN 30 PSGR SEATS.

FOR FLIGHTS IN MOAS EAST OF FAIRBANKS RECOMMEND CONTACTING EIELSON RANGR CONTROL ON 125.3/126.3 OR CALL 1-800-758-8723 FOR INFORMATION ON MILITARY ACTIVITES.

ATCT LOCATED AT 64-48-39.438N 147-50-55.722W, ELEVATION 538 FT MSL.

BE ALERT FOR SNOW REMOVAL EQUIPMENT OPNS FM 1 OCT TO 15 MAY.

TRANSIENT PARKING EAST RAMP FOR ACFT WITH WINGSPAN LESS THAN 79 FT. NO TRANSIENT ACFT PARKING ON WEST RAMP, CTC APT OPS 907-451-2300 FOR INFO & MEDIVAC PARKING.

PPR FOR MIL ACFT UTILIZING HEAVY CARGO OR TRML APN, CTC APRT OPS

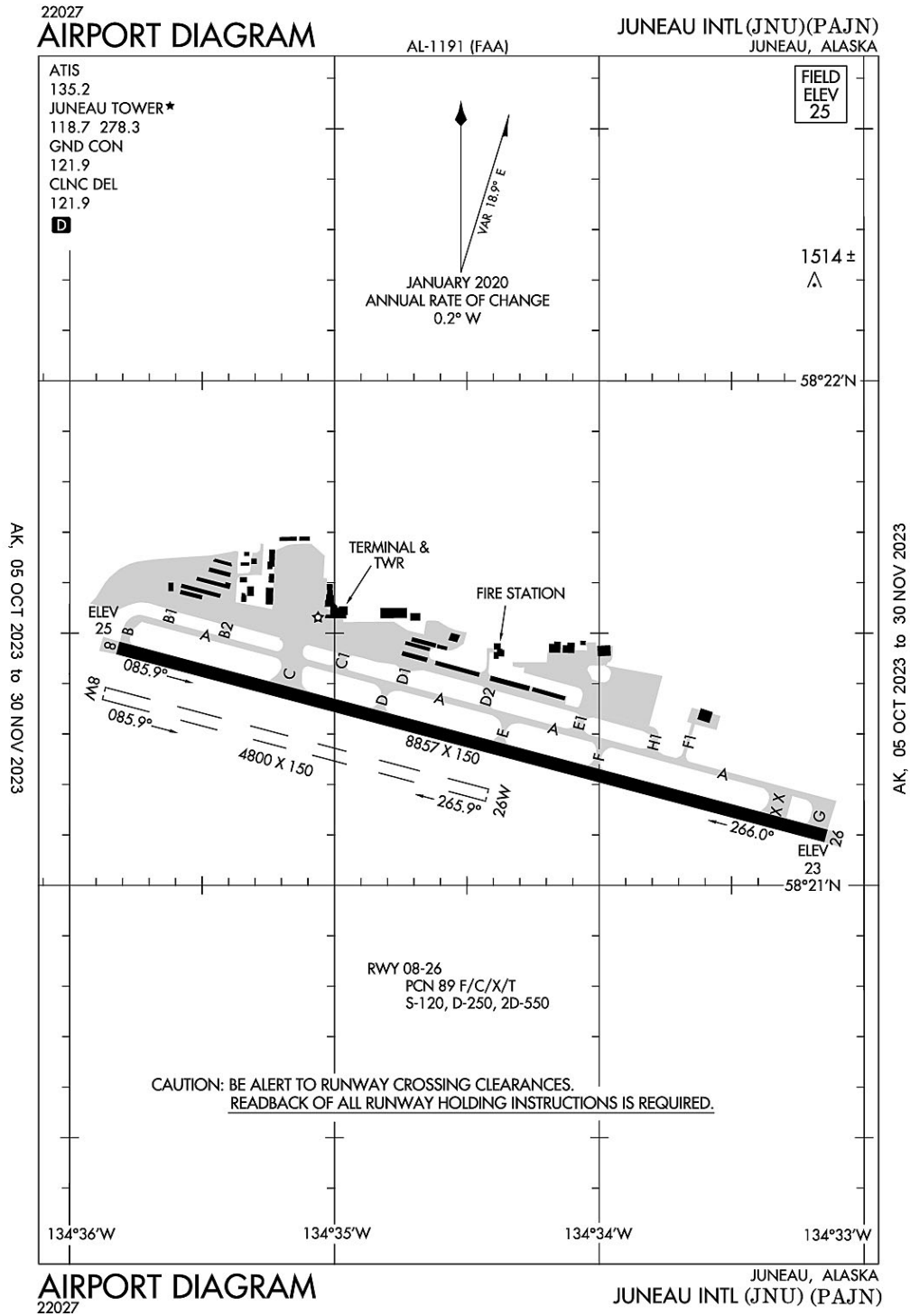
NOISE ABATEMENT PROCEDURES IN EFECT FM 2200-0800 ALL LARGE ACFT, TURBINE ENGINE, AND HEAVY ACFT UTILIZE RWY 02L FOR ARRS AND RWY 20R FOR DEPS WHEN WIND IS NOT AN OPERATIOINAL FACTOR. CTC APRT OPNS FOR ENGINE RUN-UP LOCATIONS.

N/S TAXIWAY (TWY A) IS WEST AND PARALLEL TO RWY 02L/20R. BE ALERT TO AVOID LANDING ON TAXIWAY.

SEE ADDITIONAL PAGES UNDER NOTICES FOR TRSA AND FAIRBANKS AREA INFORMATION.

RWY 02R/20L IS LIMITED FOR USE BY ACFT DESIGN GROUP B II, ACFT OR SMALLER.

### Juneau, Alaska Juneau International ICAO Identifier PAJN



**Juneau, AK**  
**Juneau Intl**  
**ICAO Identifier PAJN**

**AD 2.2 Aerodrome geographical and administrative data**

- 2.2.1 Reference Point: 58-21-16.9625N / 134-34-42.4939W
- 2.2.2 From City: 7 miles NW of JUNEAU, AK
- 2.2.3 Elevation: 25.3 ft
- 2.2.5 Magnetic Variation: 20E (2015)
- 2.2.6 Airport Contact: PATTY WAHTO  
1873 SHELL SIMMONS DR, SUITE 200  
JUNEAU, AK 99801 (907-789-7821)
- 2.2.7 Traffic: IFR/VFR

**AD 2.3 Attendance Schedule**

- 2.3.1 All Months, All Days, All Hours

**AD 2.4 Handling Services and Facilities**

- 2.4.1 Cargo Handling Facilities: YES
- 2.4.2 Fuel Types: 100LL,A1+
- 2.4.5 Hangar Space: YES
- 2.4.6 Repair Facilities: MAJOR

**AD 2.6 Rescue and Firefighting Services**

- 2.6.1 Aerodrome Category: Class-I certified on 4/1/2005
- 2.6.2 Rescue and Firefighting Services: ARFF Index-C

**AD 2.12 Runway Physical Characteristics**

- 2.12.1 Designation: 08
- 2.12.2 True Bearing: 105
- 2.12.3 Dimensions: 8857 ft x 150 ft
- 2.12.4 PCN: 89 F/C/X/T
- 2.12.5 Coordinates: 58-21-28.25N / 134-35-49.09W
- 2.12.6 Threshold Elevation: 25 ft
- 2.12.6 Touchdown Zone Elevation: 25 ft

- 2.12.1 Designation: 26
- 2.12.2 True Bearing: 285
- 2.12.3 Dimensions: 8857 ft x 150 ft
- 2.12.4 PCN: 89 F/C/X/T
- 2.12.5 Coordinates: 58-21-5.88N / 134-33-8.63W
- 2.12.6 Threshold Elevation: 23.4 ft
- 2.12.6 Touchdown Zone Elevation: 23.4 ft

- 2.12.1 Designation: 08W
- 2.12.2 True Bearing:
- 2.12.3 Dimensions: 4800 ft x 150 ft
- 2.12.4 PCN:
- 2.12.5 Coordinates: 58-21-22.82N / 134-35-52.23W
- 2.12.6 Threshold Elevation: ft
- 2.12.6 Touchdown Zone Elevation: ft

- 2.12.1 Designation: 26W
- 2.12.2 True Bearing:
- 2.12.3 Dimensions: 4800 ft x 150 ft
- 2.12.4 PCN:
- 2.12.5 Coordinates: 58-21-10.71N / 134-34-25.26W
- 2.12.6 Threshold Elevation: ft
- 2.12.6 Touchdown Zone Elevation: ft

**AD 2.13 Declared Distances**

- 2.13.1 Designation: 08
- 2.13.2 Take-off Run Available: 8857
- 2.13.3 Take-off Distance Available: 8857
- 2.13.4 Accelerate-Stop Distance Available: 8457
- 2.13.5 Landing Distance Available: 8457

- 2.13.1 Designation: 26
- 2.13.2 Take-off Run Available: 8857
- 2.13.3 Take-off Distance Available: 8857
- 2.13.4 Accelerate-Stop Distance Available: 8457
- 2.13.5 Landing Distance Available: 8457

- 2.13.1 Designation: 08W
- 2.13.2 Take-off Run Available:
- 2.13.3 Take-off Distance Available:
- 2.13.4 Accelerate-Stop Distance Available:
- 2.13.5 Landing Distance Available:

- 2.13.1 Designation: 26W
- 2.13.2 Take-off Run Available:
- 2.13.3 Take-off Distance Available:
- 2.13.4 Accelerate-Stop Distance Available:
- 2.13.5 Landing Distance Available:

**AD 2.14 Approach and Runway Lighting**

- 2.14.1 Designation: 08
- 2.14.2 Approach Lighting System: MALSF
- 2.14.4 Visual Approach Slope Indicator System: V2L

- 2.14.1 Designation: 26
- 2.14.2 Approach Lighting System: MALS
- 2.14.4 Visual Approach Slope Indicator System: P4L

- 2.14.1 Designation: 08W
- 2.14.2 Approach Lighting System:
- 2.14.4 Visual Approach Slope Indicator System:

- 2.14.1 Designation: 26W
- 2.14.2 Approach Lighting System:

2.14.4 Visual Approach Slope Indicator System:

**AD 2.18 Air Traffic Services Communication Facilities**

2.18.1 Service Designation: ATIS

2.18.3 Channel: 135.2

2.18.5 Hours of Operation: 24

2.18.1 Service Designation: CD/P

2.18.3 Channel: 121.9

2.18.5 Hours of Operation: 1 APR – SEP 30 0600 – 2300, 1 OCT – MAR 31, 0700 – 2000.

2.18.1 Service Designation: GND/P

2.18.3 Channel: 121.9

2.18.5 Hours of Operation: 1 APR – SEP 30 0600 – 2300, 1 OCT – MAR 31, 0700 – 2000.

2.18.1 Service Designation: LCL/P

2.18.3 Channel: 118.7

2.18.5 Hours of Operation: 1 APR – SEP 30 0600 – 2300, 1 OCT – MAR 31, 0700 – 2000.

2.18.1 Service Designation: LCL/P

2.18.3 Channel: 278.3

2.18.5 Hours of Operation: 1 APR – SEP 30 0600 – 2300, 1 OCT – MAR 31, 0700 – 2000.

2.18.1 Service Designation: LCL/S (SEASONAL USE ONLY)

2.18.3 Channel: 120.7

2.18.5 Hours of Operation: 1 APR – SEP 30 0600 – 2300, 1 OCT – MAR 31, 0700 – 2000.

2.18.1 Service Designation: NG OPS

2.18.3 Channel: 64.7

2.18.5 Hours of Operation:

2.18.1 Service Designation: NG OPS

2.18.3 Channel: 124.65

2.18.5 Hours of Operation:

**AD 2.19 Radio Navigation and Landing Aids**

2.19.1 ILS Type: DME for runway 08. Magnetic variation: 20E

2.19.2 ILS Identification: JDL

2.19.5 Coordinates: 58-21-31.0221N / 134-38-10.216W

2.19.6 Site Elevation: 179.8 ft

2.19.1 ILS Type: Localizer for runway 08. Magnetic variation: 20E

2.19.2 ILS Identification: JDL

2.19.5 Coordinates: 58-21-32.035N / 134-38-10.3944W

2.19.6 Site Elevation: 165 ft

2.19.1 ILS Type: Outer Marker for runway 08. Magnetic variation: 20E

2.19.2 ILS Identification: JDL

2.19.5 Coordinates: 58-21-33.5717N / 134-41-58.0236W

2.19.6 Site Elevation: 57.9 ft

**General Remarks:**

FOR LCL CALL TO JUNEAU FSS CALL 907-789-7380.

TRANSIENT DOCK AVBL FOR PUBLIC USE FOR UP TO SIX ACFT, SW CORNER.

RY 08/26 SAND USED TO ENHANCE RY FRICTION MAY NOT MEET FAA SPECS.

TPA 1500 AGL FOR LARGE TURBINE ACFT; 1000 FT AGL FOR FIXED WING ACFT; 500 FT AGL FOR HELICOPTERS.

APRON TERMINAL RAMP CLSD TO ROTORCRAFT. APRON US CUSTOMS RAMP CLSD TO ACFT WITH WINGSPAN MORE THAN 79 FT INTL ACFT WITH WINGSPAN MORE THAN 79 FT AND ALL INTL ROTORCRAFT USE E-1 RAMP (NTL GUARD RAMP).

WILDLIFE & BIRDS ON & INVOF ARPT.

BATTLESHIP ISLAND RLLS GROUPING; CENTER LIGHT 582132.88N 1344012.22W. IJDL-LOCALIZER RLLS GROUPING; CENTER LIGHT 582132.02N 1343810.39W.

COLD TEMPERATURE AIRPORT. ALTITUDE CORRECTION REQUIRED AT OR BELOW -0C.

LENA POINT, PEDERSON HILL AND SISTERS ISLAND WX CAMERAS AVBL ON INTERNET AT [HTTPS://WEATHERCAMS.FAA.GOV](https://weathercams.faa.gov)

PARAGLIDING ACTIVITY 3 MILES N OF ARPT INVOF THUNDER MOUNTAIN & OVER GASTINEAU CHANNEL NEARS DOWNTOWN APR 15-OCT 1 6000 FT & BLO.

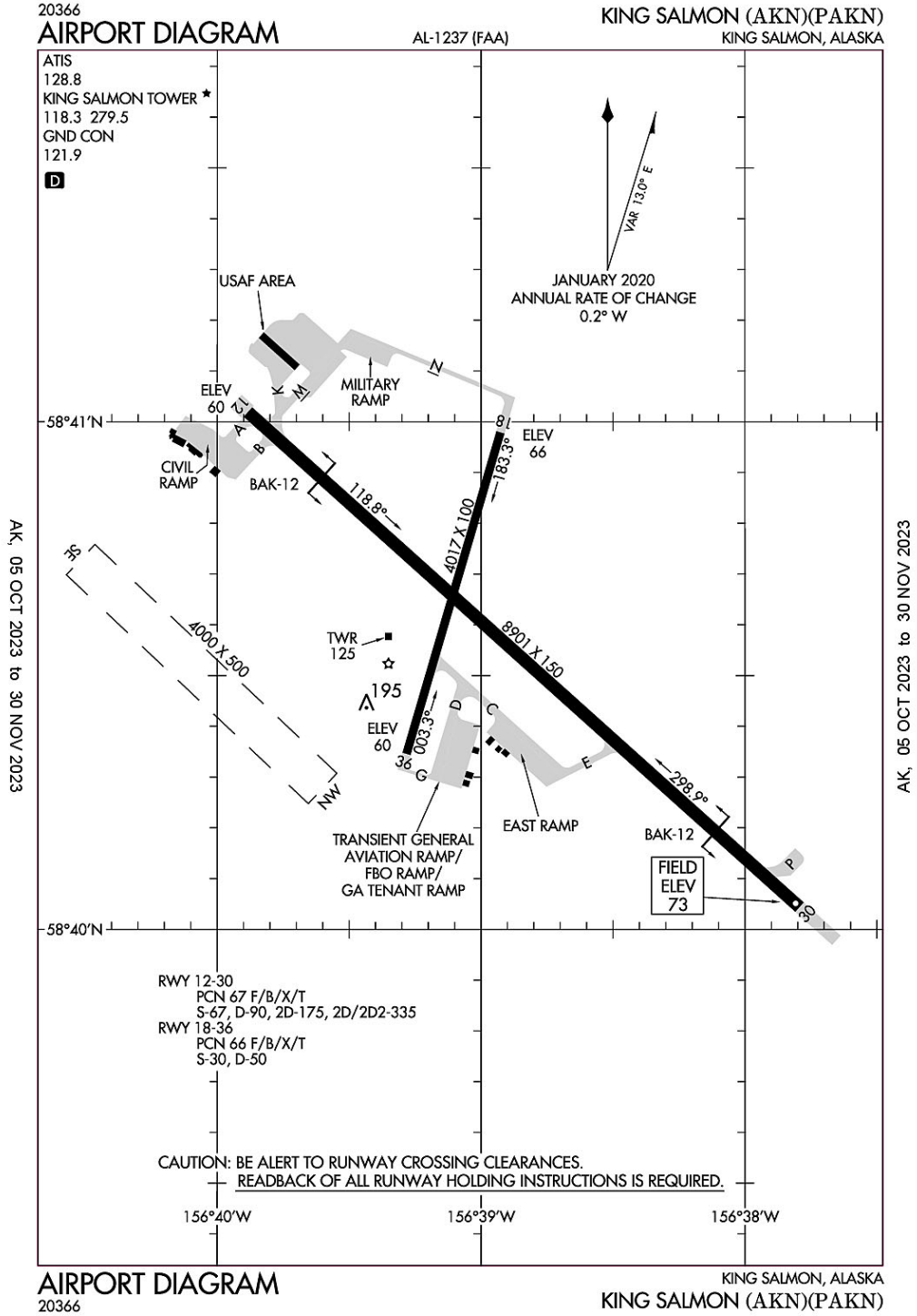
INCREASED HELICOPTER/LIGH ACFT ACTIVITY APR 15-OCT 1 ENTIRE LENGTH ON GASTINEAU CHANNEL & WITHIN 5 MILES OF ARPT.

NATIONAL GUARD 24 HR PPR DUE TO LIMITED PARKING C907-789-3366. 0730-1600 WEEKDAYS CONTACT GUARD OPS 10 MIN PRIOR TO LANDING ON 124.65.

SEE SPECIAL NOTICES AND GENERAL NOTICES FOR ADDITIONAL INFORMATION ON OPNS IN JUNEAU AREA.



### King Salmon, Alaska King Salmon ICAO Identifier PAKN



**King Salmon, AK**  
**King Salmon**  
**ICAO Identifier PAKN**

**AD 2.2 Aerodrome geographical and administrative data**

- 2.2.1 Reference Point: 58-40-35.3765N / 156-38-55.2876W
- 2.2.2 From City: 0 miles SE of KING SALMON, AK
- 2.2.3 Elevation: 73.4 ft
- 2.2.5 Magnetic Variation: 11E (2025)
- 2.2.6 Airport Contact: FLOYD WILSON  
PO BOX 65  
KING SALMON, AK 99613 (907-246-3325)
- 2.2.7 Traffic: IFR/VFR

**AD 2.3 Attendance Schedule**

- 2.3.1 All Months, All Days, 0700-1700 Hours

**AD 2.4 Handling Services and Facilities**

- 2.4.1 Cargo Handling Facilities: YES
- 2.4.2 Fuel Types: 100LL,A
- 2.4.5 Hangar Space:
- 2.4.6 Repair Facilities: MAJOR

**AD 2.6 Rescue and Firefighting Services**

- 2.6.1 Aerodrome Category: Class-I certified on 3/21/2005
- 2.6.2 Rescue and Firefighting Services: ARFF Index-B

**AD 2.12 Runway Physical Characteristics**

- 2.12.1 Designation: 12
- 2.12.2 True Bearing: 132
- 2.12.3 Dimensions: 8901 ft x 150 ft
- 2.12.4 PCN: 67 F/B/X/T
- 2.12.5 Coordinates: 58-41-2.184N / 156-39-53.0154W
- 2.12.6 Threshold Elevation: 59.9 ft
- 2.12.6 Touchdown Zone Elevation: 61.8 ft
  
- 2.12.1 Designation: 30
- 2.12.2 True Bearing: 312
- 2.12.3 Dimensions: 8901 ft x 150 ft
- 2.12.4 PCN: 67 F/B/X/T
- 2.12.5 Coordinates: 58-40-3.68N / 156-37-47.63W
- 2.12.6 Threshold Elevation: 73.4 ft
- 2.12.6 Touchdown Zone Elevation: 73.4 ft
  
- 2.12.1 Designation: 18
- 2.12.2 True Bearing: 196
- 2.12.3 Dimensions: 4017 ft x 100 ft
- 2.12.4 PCN: 66 F/B/X/T
- 2.12.5 Coordinates: 58-40-59.7835N / 156-38-55.6139W
- 2.12.6 Threshold Elevation: 66.1 ft
- 2.12.6 Touchdown Zone Elevation: 66.1 ft

2.12.1 Designation: 36  
2.12.2 True Bearing: 16  
2.12.3 Dimensions: 4017 ft x 100 ft  
2.12.4 PCN: 66 F/B/X/T  
2.12.5 Coordinates: 58-40-21.7997N / 156-39-16.9583W  
2.12.6 Threshold Elevation: 59.9 ft  
2.12.6 Touchdown Zone Elevation: 65.2 ft

2.12.1 Designation: NW  
2.12.2 True Bearing:  
2.12.3 Dimensions: 4000 ft x 500 ft  
2.12.4 PCN:  
2.12.5 Coordinates: -- / --  
2.12.6 Threshold Elevation: ft  
2.12.6 Touchdown Zone Elevation: ft

2.12.1 Designation: SE  
2.12.2 True Bearing:  
2.12.3 Dimensions: 4000 ft x 500 ft  
2.12.4 PCN:  
2.12.5 Coordinates: -- / --  
2.12.6 Threshold Elevation: ft  
2.12.6 Touchdown Zone Elevation: ft

#### **AD 2.13 Declared Distances**

2.13.1 Designation: 12  
2.13.2 Take-off Run Available: 8901  
2.13.3 Take-off Distance Available: 8901  
2.13.4 Accelerate-Stop Distance Available: 8501  
2.13.5 Landing Distance Available: 8501

2.13.1 Designation: 30  
2.13.2 Take-off Run Available: 8901  
2.13.3 Take-off Distance Available: 8901  
2.13.4 Accelerate-Stop Distance Available: 8501  
2.13.5 Landing Distance Available: 8501

2.13.1 Designation: 18  
2.13.2 Take-off Run Available:  
2.13.3 Take-off Distance Available:  
2.13.4 Accelerate-Stop Distance Available:  
2.13.5 Landing Distance Available:

2.13.1 Designation: 36  
2.13.2 Take-off Run Available:  
2.13.3 Take-off Distance Available:  
2.13.4 Accelerate-Stop Distance Available:  
2.13.5 Landing Distance Available:

2.13.1 Designation: NW  
2.13.2 Take-off Run Available:  
2.13.3 Take-off Distance Available:  
2.13.4 Accelerate-Stop Distance Available:  
2.13.5 Landing Distance Available:

2.13.1 Designation: SE  
2.13.2 Take-off Run Available:  
2.13.3 Take-off Distance Available:  
2.13.4 Accelerate-Stop Distance Available:  
2.13.5 Landing Distance Available:

**AD 2.14 Approach and Runway Lighting**

2.14.1 Designation: 12  
2.14.2 Approach Lighting System: SSALR  
2.14.4 Visual Approach Slope Indicator System: P4L

2.14.1 Designation: 30  
2.14.2 Approach Lighting System:  
2.14.4 Visual Approach Slope Indicator System: P4L

2.14.1 Designation: 18  
2.14.2 Approach Lighting System:  
2.14.4 Visual Approach Slope Indicator System:

2.14.1 Designation: 36  
2.14.2 Approach Lighting System:  
2.14.4 Visual Approach Slope Indicator System:

2.14.1 Designation: NW  
2.14.2 Approach Lighting System:  
2.14.4 Visual Approach Slope Indicator System:

2.14.1 Designation: SE  
2.14.2 Approach Lighting System:  
2.14.4 Visual Approach Slope Indicator System:

**AD 2.18 Air Traffic Services Communication Facilities**

2.18.1 Service Designation: ATIS  
2.18.3 Channel: 128.8  
2.18.5 Hours of Operation: 24

2.18.1 Service Designation: GND/P  
2.18.3 Channel: 121.9  
2.18.5 Hours of Operation: 0800-2000 1 AUG-14 JUN. 0800-2200 15 JUN- 31 JUL.

2.18.1 Service Designation: LCL/P  
2.18.3 Channel: 118.3  
2.18.5 Hours of Operation: 0800-2000 1 AUG-14 JUN. 0800-2200 15 JUN- 31 JUL.

2.18.1 Service Designation: LCL/P  
2.18.3 Channel: 279.5  
2.18.5 Hours of Operation: 0800-2000 1 AUG-14 JUN. 0800-2200 15 JUN- 31 JUL.

2.18.1 Service Designation: PTD  
2.18.3 Channel: 372.2  
2.18.5 Hours of Operation:

**AD 2.19 Radio Navigation and Landing Aids**

2.19.1 ILS Type: DME for runway 12. Magnetic variation: 11E  
2.19.2 ILS Identification: AKN  
2.19.5 Coordinates: 58-39-59.6N / 156-37-31.7W  
2.19.6 Site Elevation: 78 ft

2.19.1 ILS Type: Glide Slope for runway 12. Magnetic variation: 11E  
2.19.2 ILS Identification: AKN  
2.19.5 Coordinates: 58-40-57.3435N / 156-39-29.887W  
2.19.6 Site Elevation: 63.5 ft

2.19.1 ILS Type: Localizer for runway 12. Magnetic variation: 11E  
2.19.2 ILS Identification: AKN  
2.19.5 Coordinates: 58-39-56.5549N / 156-37-32.3734W  
2.19.6 Site Elevation: 77.7 ft

2.19.1 Navigation Aid Type: VORTAC. Magnetic variation: 16E  
2.19.2 Navigation Aid Identification: AKN  
2.19.5 Coordinates: 58-43-28.9653N / 156-45-8.4483W  
2.19.6 Site Elevation: 94.6 ft

**General Remarks:**

USAF FAC CIV OPRD WITH LTD SUPPORT; CALL 24 HR PRIOR TO ARR FOR OPS HR; MIL CONFIRM FUEL RQMNTS 24-48 HR PRIOR.

FIGHTER ARR EXP RDCD SEPN; SIMILAR APCH CHARCS & DALGT 3000 FT; DISSIMILAR APCH CHARCS & NGT 6000 FT; AHD/BHND FRMN LNDG 6000 FT.

FLOCKS OF LRG BIRDS INVOF DURG SEASON.

TWY P CLSD. APRON SPOTS 4 - 7 N OF MIL HANGAR CLSD EXC PROP ACFT.

RCR DURG 11TH AF FIGHTER FLYING WINDOW; COORD RCR WITH KING SALMON OPS 907-439-3001/907-439-6000. OPS RSTRD TO LOW APCH/FSL ONLY.

600 FT SAFETY AREA AER 12.

BUSINESS JET PRKG GTR THAN 1 HR 48 HR PPR.

FLIGHT ORIG OUTSIDE AK REFER TO USAF FCG; CSTMS NOT AVBL.

CIV TSNT PRKG ON SE RAMP ONLY; OTR PRKG GTR THAN 48 HR RQRS PERMIT.

LOCKED WHEEL TURN NA ALL SFCS.

MIL FIGHTER/EMERG DVRSN CTC WARRIOR/ELMENDORF SOF 395.15; NON FIGHTER/EMERG CTC KING SALMON OPS. 24 HR POINT MNTS CTAF DURG OPS HR.

GA APRON PAVEMENT CRUMBLING; PSBL FOD HAZ. JET ACFT BE ALERT DURG RUN UP TO AVOID JET WASH DMG.

SNOW/ICE REMOVAL & ARPT HAZ COND RPRTD DURG ATND HR.

OFF PAVEMENT OPS BY ACFT & HEL NA AT ACR APRON. LNDG, TKOF OR PRKG FM DIRT OR GRASS NA.

TSA REG ARPT; SEE 49 CFR 1542. ALL GATES & DOORS RMN SECURE ALL TIMES. TSNT OR UNFAMILIAR PILOTS – AMGR FOR INFO.

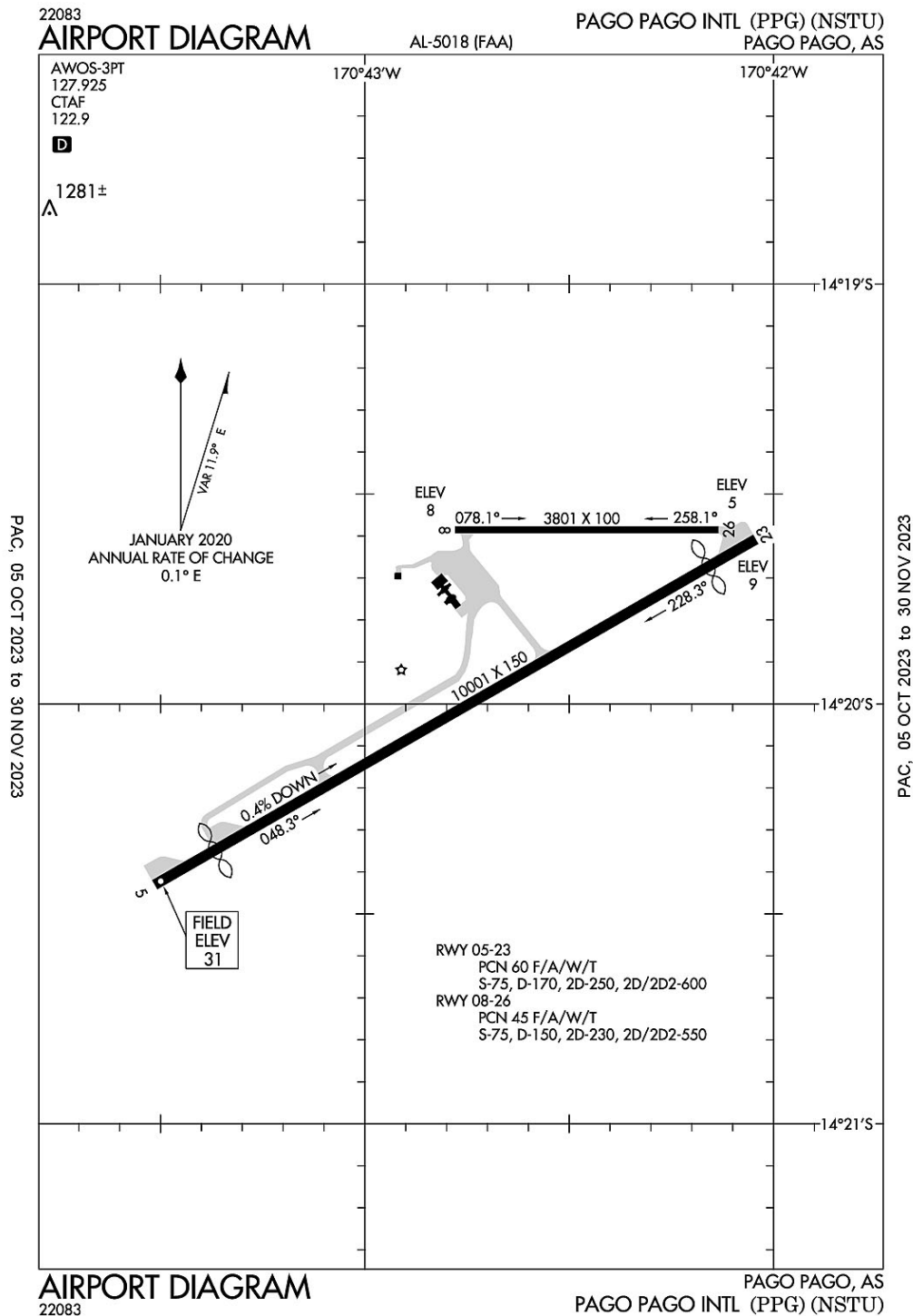
PVT JET PRKG SE SECTION OF E RAMP – AMGR FOR INFO.

WX CAMERA AVBL ON INTERNET AT [HTTPS://WEATHERCAMS.FAA.GOV](https://weathercams.faa.gov)

ARFF AVBL FOR PART 121 ACR INVOLVED IN ETOPS WITH 30 MIN NOTICE.

NWS BLN LAUNCH FAC ON ARPT; SEE INSIDE BACK COVER FOR OPS DETAIL.

**Pago Pago, American Samoa**  
**Pago Pago/International**  
**ICAO Identifier NSTU**



**Pago Pago, AS**  
**Pago Pago Intl**  
**ICAO Identifier NSTU**

**AD 2.2 Aerodrome geographical and administrative data**

- 2.2.1 Reference Point: 14-19-53.984S / 170-42-41.411W
- 2.2.2 From City: 3 miles SW of PAGO PAGO, AS
- 2.2.3 Elevation: 31.2 ft
- 2.2.5 Magnetic Variation: 12E (1990)
- 2.2.6 Airport Contact: TAVITA S FUIMAONO  
1539 AIRPORT WAY P.O. BOX 1539  
PAGO PAGO, AS 96799 (684-733-3154)
- 2.2.7 Traffic: IFR/VFR

**AD 2.3 Attendance Schedule**

- 2.3.1 All Months, All Days, All Hours

**AD 2.4 Handling Services and Facilities**

- 2.4.1 Cargo Handling Facilities: YES
- 2.4.2 Fuel Types: 100,A1+
- 2.4.5 Hangar Space:
- 2.4.6 Repair Facilities: NONE

**AD 2.6 Rescue and Firefighting Services**

- 2.6.1 Aerodrome Category: Class-I certified on 5/1/1973
- 2.6.2 Rescue and Firefighting Services: ARFF Index-C

**AD 2.12 Runway Physical Characteristics**

- 2.12.1 Designation: 05
- 2.12.2 True Bearing: 60
- 2.12.3 Dimensions: 10001 ft x 150 ft
- 2.12.4 PCN: 60 F/A/W/T
- 2.12.5 Coordinates: 14-20-25.8311S / 170-43-30.8448W
- 2.12.6 Threshold Elevation: 31.2 ft
- 2.12.6 Touchdown Zone Elevation: 29.3 ft
  
- 2.12.1 Designation: 23
- 2.12.2 True Bearing: 240
- 2.12.3 Dimensions: 10001 ft x 150 ft
- 2.12.4 PCN: 60 F/A/W/T
- 2.12.5 Coordinates: 14-19-36.4755S / 170-42-2.6116W
- 2.12.6 Threshold Elevation: 8.7 ft
- 2.12.6 Touchdown Zone Elevation: 8.7 ft
  
- 2.12.1 Designation: 08
- 2.12.2 True Bearing: 90
- 2.12.3 Dimensions: 3801 ft x 100 ft
- 2.12.4 PCN: 45 F/A/W/T
- 2.12.5 Coordinates: 14-19-35.126S / 170-42-46.7563W
- 2.12.6 Threshold Elevation: 8.1 ft
- 2.12.6 Touchdown Zone Elevation: 8.1 ft



- 2.12.1 Designation: 26
- 2.12.2 True Bearing: 270
- 2.12.3 Dimensions: 3801 ft x 100 ft
- 2.12.4 PCN: 45 F/A/W/T
- 2.12.5 Coordinates: 14-19-35.1106S / 170-42-8.096W
- 2.12.6 Threshold Elevation: 4.8 ft
- 2.12.6 Touchdown Zone Elevation: 5.7 ft

**AD 2.13 Declared Distances**

- 2.13.1 Designation: 05
- 2.13.2 Take-off Run Available: 9200
- 2.13.3 Take-off Distance Available: 10000
- 2.13.4 Accelerate-Stop Distance Available: 9200
- 2.13.5 Landing Distance Available: 8200

- 2.13.1 Designation: 23
- 2.13.2 Take-off Run Available: 10000
- 2.13.3 Take-off Distance Available: 10000
- 2.13.4 Accelerate-Stop Distance Available: 10000
- 2.13.5 Landing Distance Available: 9200

- 2.13.1 Designation: 08
- 2.13.2 Take-off Run Available:
- 2.13.3 Take-off Distance Available:
- 2.13.4 Accelerate-Stop Distance Available:
- 2.13.5 Landing Distance Available:

- 2.13.1 Designation: 26
- 2.13.2 Take-off Run Available:
- 2.13.3 Take-off Distance Available:
- 2.13.4 Accelerate-Stop Distance Available:
- 2.13.5 Landing Distance Available:

**AD 2.14 Approach and Runway Lighting**

- 2.14.1 Designation: 05
- 2.14.2 Approach Lighting System: MALSR
- 2.14.4 Visual Approach Slope Indicator System: P4L

- 2.14.1 Designation: 23
- 2.14.2 Approach Lighting System:
- 2.14.4 Visual Approach Slope Indicator System: P4L

- 2.14.1 Designation: 08
- 2.14.2 Approach Lighting System:
- 2.14.4 Visual Approach Slope Indicator System:

- 2.14.1 Designation: 26
- 2.14.2 Approach Lighting System:

2.14.4 Visual Approach Slope Indicator System:

**AD 2.18 Air Traffic Services Communication Facilities**

**AD 2.19 Radio Navigation and Landing Aids**

2.19.1 ILS Type: DME for runway 05. Magnetic variation: 12E

2.19.2 ILS Identification: TUT

2.19.5 Coordinates: 14-19-37.6403S / 170-42-14.7077W

2.19.6 Site Elevation: 19.1 ft

2.19.1 ILS Type: Glide Slope for runway 05. Magnetic variation: 12E

2.19.2 ILS Identification: TUT

2.19.5 Coordinates: 14-20-13.069S / 170-43-15.1842W

2.19.6 Site Elevation: 24.5 ft

2.19.1 ILS Type: Localizer for runway 05. Magnetic variation: 12E

2.19.2 ILS Identification: TUT

2.19.5 Coordinates: 14-19-38.7728S / 170-42-12.8837W

2.19.6 Site Elevation: 5.1 ft

**General Remarks:**

OLOTELE MT 1617 FT MSL 3.5 MILES WEST OF THLD RY 08.

ALL ACFT TRANSITING PAGO PAGO (EXCP COMMERCIAL CARRIERS) MUST MAKE FUEL ARRANGEMENTS WITH PPG AT 684-733-3158.

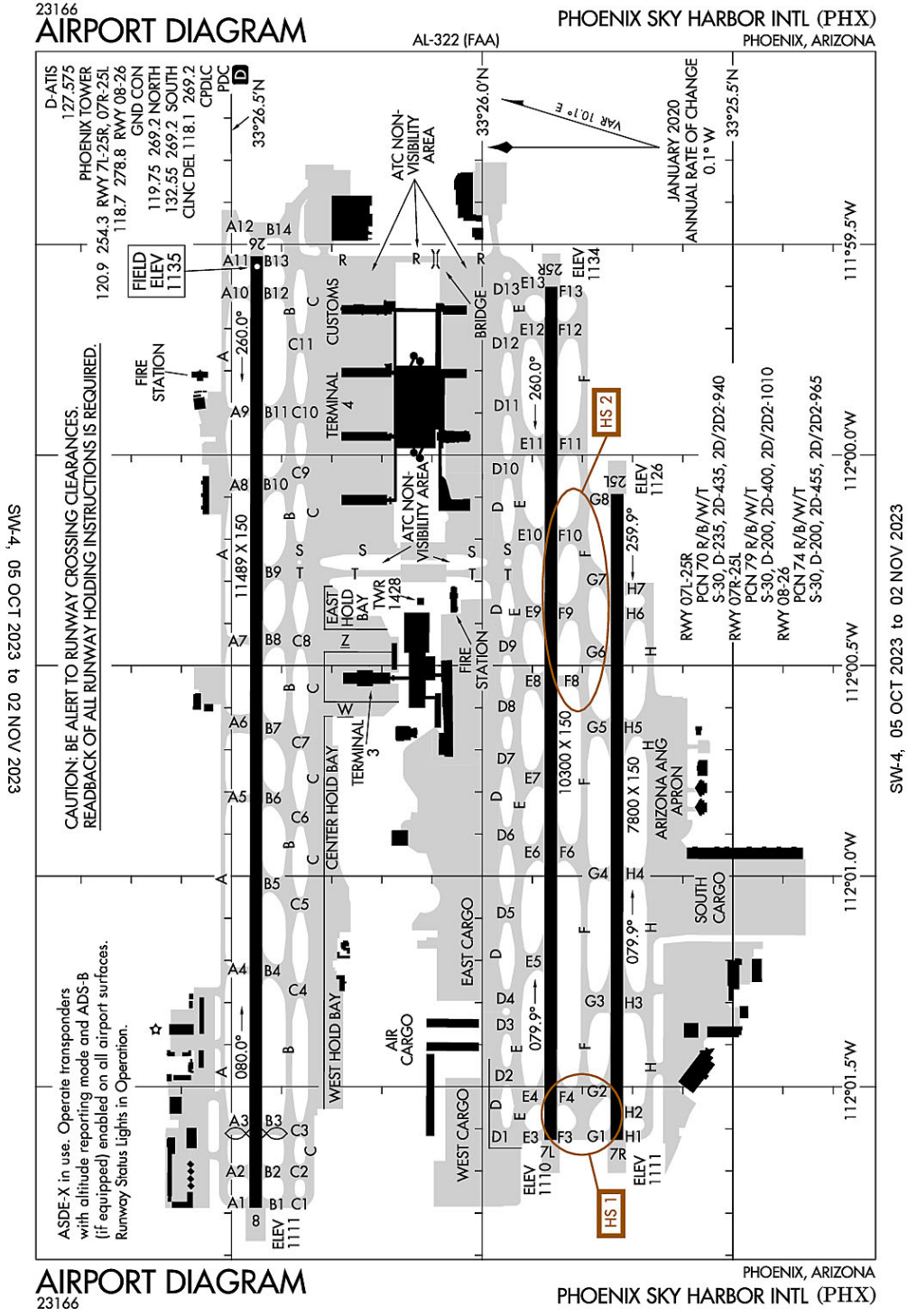
<ALL FLTS (EXCP SKED) PRIOR PMSN FROM AMGR WITH 24 HRS PRIOR NOTICE.

FOR NOTAM CONTACT NEW ZEALAND (643) 358-1688FSS: NEW ZEALAND

SEA SPRAY FM SURF & BLOW HOLES MAY DRIFT ACRS RWY 05/23 UNDER ROUGH SEA CONDS.

PERMLY LGTD & MKD 226' TWR ATOP MT ALAVA 4.3SM NNE ARPT.

Phoenix, Arizona  
Phoenix Sky Harbor International  
ICAO Identifier KPHX



SW-4, 05 OCT 2023 to 02 NOV 2023

SW-4, 05 OCT 2023 to 02 NOV 2023

**Phoenix, AZ**  
**Phoenix Sky Harbor Intl**  
**ICAO Identifier KPHX**

**AD 2.2 Aerodrome geographical and administrative data**

- 2.2.1 Reference Point: 33-26-3.4N / 112-0-41.7W
- 2.2.2 From City: 3 miles E of PHOENIX, AZ
- 2.2.3 Elevation: 1134.8 ft
- 2.2.5 Magnetic Variation: 12E (2000)
- 2.2.6 Airport Contact: CHAD R. MAKOVSKY  
2485 E BUCKEYE RD  
PHOENIX, AZ 85034 (602-273-3302)
- 2.2.7 Traffic: IFR/VFR

**AD 2.3 Attendance Schedule**

- 2.3.1 All Months, All Days, All Hours

**AD 2.4 Handling Services and Facilities**

- 2.4.1 Cargo Handling Facilities: YES
- 2.4.2 Fuel Types: 100LL,A
- 2.4.5 Hangar Space: YES
- 2.4.6 Repair Facilities: MAJOR

**AD 2.6 Rescue and Firefighting Services**

- 2.6.1 Aerodrome Category: Class-I certified on 5/1/1973
- 2.6.2 Rescue and Firefighting Services: ARFF Index-D

**AD 2.12 Runway Physical Characteristics**

- 2.12.1 Designation: 07L
- 2.12.2 True Bearing: 90
- 2.12.3 Dimensions: 10300 ft x 150 ft
- 2.12.4 PCN: 70 R/B/W/T
- 2.12.5 Coordinates: 33-25-51.8081N / 112-1-37.5659W
- 2.12.6 Threshold Elevation: 1110.2 ft
- 2.12.6 Touchdown Zone Elevation: 1116.5 ft
  
- 2.12.1 Designation: 25R
- 2.12.2 True Bearing: 270
- 2.12.3 Dimensions: 10300 ft x 150 ft
- 2.12.4 PCN: 70 R/B/W/T
- 2.12.5 Coordinates: 33-25-51.7284N / 111-59-36.0429W
- 2.12.6 Threshold Elevation: 1134 ft
- 2.12.6 Touchdown Zone Elevation: 1134.1 ft
  
- 2.12.1 Designation: 25L
- 2.12.2 True Bearing: 270
- 2.12.3 Dimensions: 7800 ft x 150 ft
- 2.12.4 PCN: 79 R/B/W/T
- 2.12.5 Coordinates: 33-25-43.8354N / 112-0-5.5412W
- 2.12.6 Threshold Elevation: 1126.3 ft
- 2.12.6 Touchdown Zone Elevation: 1126.4 ft

2.12.1 Designation: 07R  
2.12.2 True Bearing: 90  
2.12.3 Dimensions: 7800 ft x 150 ft  
2.12.4 PCN: 79 R/B/W/T  
2.12.5 Coordinates: 33-25-43.8923N / 112-1-37.5686W  
2.12.6 Threshold Elevation: 1111 ft  
2.12.6 Touchdown Zone Elevation: 1115.9 ft

2.12.1 Designation: 26  
2.12.2 True Bearing: 270  
2.12.3 Dimensions: 11489 ft x 150 ft  
2.12.4 PCN: 74 R/B/W/T  
2.12.5 Coordinates: 33-26-26.9643N / 111-59-31.6884W  
2.12.6 Threshold Elevation: 1134.7 ft  
2.12.6 Touchdown Zone Elevation: 1134.8 ft

2.12.1 Designation: 08  
2.12.2 True Bearing: 90  
2.12.3 Dimensions: 11489 ft x 150 ft  
2.12.4 PCN: 74 R/B/W/T  
2.12.5 Coordinates: 33-26-27.0993N / 112-1-47.257W  
2.12.6 Threshold Elevation: 1111.1 ft  
2.12.6 Touchdown Zone Elevation: 1118 ft

#### **AD 2.13 Declared Distances**

2.13.1 Designation: 07L  
2.13.2 Take-off Run Available: 10300  
2.13.3 Take-off Distance Available: 10300  
2.13.4 Accelerate-Stop Distance Available: 10300  
2.13.5 Landing Distance Available: 10300

2.13.1 Designation: 25R  
2.13.2 Take-off Run Available: 10300  
2.13.3 Take-off Distance Available: 10300  
2.13.4 Accelerate-Stop Distance Available: 10300  
2.13.5 Landing Distance Available: 10300

2.13.1 Designation: 25L  
2.13.2 Take-off Run Available: 7800  
2.13.3 Take-off Distance Available: 7800  
2.13.4 Accelerate-Stop Distance Available: 7800  
2.13.5 Landing Distance Available: 7800

2.13.1 Designation: 07R  
2.13.2 Take-off Run Available: 7800  
2.13.3 Take-off Distance Available: 7800  
2.13.4 Accelerate-Stop Distance Available: 7800  
2.13.5 Landing Distance Available: 7800

2.13.1 Designation: 26  
2.13.2 Take-off Run Available: 11489  
2.13.3 Take-off Distance Available: 11489  
2.13.4 Accelerate-Stop Distance Available: 11489  
2.13.5 Landing Distance Available: 11489

2.13.1 Designation: 08  
2.13.2 Take-off Run Available: 11489  
2.13.3 Take-off Distance Available: 11489  
2.13.4 Accelerate-Stop Distance Available: 11489  
2.13.5 Landing Distance Available: 10591

**AD 2.14 Approach and Runway Lighting**

2.14.1 Designation: 07L  
2.14.2 Approach Lighting System: MALSR  
2.14.4 Visual Approach Slope Indicator System: P4L

2.14.1 Designation: 25R  
2.14.2 Approach Lighting System:  
2.14.4 Visual Approach Slope Indicator System: P4L

2.14.1 Designation: 25L  
2.14.2 Approach Lighting System: MALSR  
2.14.4 Visual Approach Slope Indicator System: P4L

2.14.1 Designation: 07R  
2.14.2 Approach Lighting System: MALSR  
2.14.4 Visual Approach Slope Indicator System: P4L

2.14.1 Designation: 26  
2.14.2 Approach Lighting System:  
2.14.4 Visual Approach Slope Indicator System: P4L

2.14.1 Designation: 08  
2.14.2 Approach Lighting System: MALSF  
2.14.4 Visual Approach Slope Indicator System: P4L

**AD 2.18 Air Traffic Services Communication Facilities**

2.18.1 Service Designation: CD/P  
2.18.3 Channel: 118.1  
2.18.5 Hours of Operation: 24

2.18.1 Service Designation: CD/P  
2.18.3 Channel: 269.2  
2.18.5 Hours of Operation: 24

2.18.1 Service Designation: D-ATIS  
2.18.3 Channel: 127.575  
2.18.5 Hours of Operation: 24

2.18.1 Service Designation: EMERG  
2.18.3 Channel: 243  
2.18.5 Hours of Operation:

2.18.1 Service Designation: GND/P (NORTH)  
2.18.3 Channel: 119.75  
2.18.5 Hours of Operation: 24

2.18.1 Service Designation: GND/P (SOUTH)  
2.18.3 Channel: 132.55  
2.18.5 Hours of Operation: 24

2.18.1 Service Designation: GND/P  
2.18.3 Channel: 269.2  
2.18.5 Hours of Operation: 24

2.18.1 Service Designation: LCL/P (RWY 08/26)  
2.18.3 Channel: 118.7  
2.18.5 Hours of Operation: 24

2.18.1 Service Designation: LCL/P (RWY 07L/25R, 07R/25L)  
2.18.3 Channel: 120.9  
2.18.5 Hours of Operation: 24

2.18.1 Service Designation: LCL/P (RWY 07L/25R, 07R/25L)  
2.18.3 Channel: 254.3  
2.18.5 Hours of Operation: 24

2.18.1 Service Designation: LCL/P (RWY 08/26)  
2.18.3 Channel: 278.8  
2.18.5 Hours of Operation: 24

#### **AD 2.19 Radio Navigation and Landing Aids**

2.19.1 ILS Type: DME for runway 07L. Magnetic variation: 12E  
2.19.2 ILS Identification: PHX  
2.19.5 Coordinates: 33-25-54.0771N / 111-59-19.1054W  
2.19.6 Site Elevation: 1143 ft

2.19.1 ILS Type: Glide Slope for runway 07L. Magnetic variation: 12E  
2.19.2 ILS Identification: PHX  
2.19.5 Coordinates: 33-25-49.0529N / 112-1-25.2134W  
2.19.6 Site Elevation: 1106.5 ft

2.19.1 ILS Type: Localizer for runway 07L. Magnetic variation: 12E  
2.19.2 ILS Identification: PHX  
2.19.5 Coordinates: 33-25-51.7152N / 111-59-20.367W  
2.19.6 Site Elevation: 1133.5 ft

2.19.1 ILS Type: DME for runway 07R. Magnetic variation: 12E

2.19.2 ILS Identification: AHA  
2.19.5 Coordinates: 33-25-41.1847N / 111-59-52.1833W  
2.19.6 Site Elevation: 1135.8 ft

2.19.1 ILS Type: Glide Slope for runway 07R. Magnetic variation: 12E  
2.19.2 ILS Identification: AHA  
2.19.5 Coordinates: 33-25-46.628N / 112-1-25.0931W  
2.19.6 Site Elevation: 1107.4 ft

2.19.1 ILS Type: Localizer for runway 07R. Magnetic variation: 12E  
2.19.2 ILS Identification: AHA  
2.19.5 Coordinates: 33-25-43.8252N / 111-59-52.2902W  
2.19.6 Site Elevation: 1124.2 ft

2.19.1 ILS Type: DME for runway 25L. Magnetic variation: 12E  
2.19.2 ILS Identification: RJG  
2.19.5 Coordinates: 33-25-41.1847N / 111-59-52.1833W  
2.19.6 Site Elevation: 1117.1 ft

2.19.1 ILS Type: Glide Slope for runway 25L. Magnetic variation: 12E  
2.19.2 ILS Identification: RJG  
2.19.5 Coordinates: 33-25-40.9318N / 112-0-16.8722W  
2.19.6 Site Elevation: 1120.3 ft

2.19.1 ILS Type: Localizer for runway 25L. Magnetic variation: 12E  
2.19.2 ILS Identification: RJG  
2.19.5 Coordinates: 33-25-43.8995N / 112-1-49.6368W  
2.19.6 Site Elevation: 1103.2 ft

2.19.1 ILS Type: DME for runway 08. Magnetic variation: 12E  
2.19.2 ILS Identification: SYQ  
2.19.5 Coordinates: 33-26-24.3207N / 111-59-19.7057W  
2.19.6 Site Elevation: 1149.2 ft

2.19.1 ILS Type: Glide Slope for runway 08. Magnetic variation: 12E  
2.19.2 ILS Identification: SYQ  
2.19.5 Coordinates: 33-26-29.6544N / 112-1-24.6276W  
2.19.6 Site Elevation: 1111.7 ft

2.19.1 ILS Type: Localizer for runway 08. Magnetic variation: 12E  
2.19.2 ILS Identification: SYQ  
2.19.5 Coordinates: 33-26-26.9483N / 111-59-19.7443W  
2.19.6 Site Elevation: 1134.1 ft

2.19.1 ILS Type: DME for runway 26. Magnetic variation: 12E  
2.19.2 ILS Identification: CWJ  
2.19.5 Coordinates: 33-26-24.3207N / 111-59-19.7057W  
2.19.6 Site Elevation: 1149.2 ft

2.19.1 ILS Type: Glide Slope for runway 26. Magnetic variation: 12E  
2.19.2 ILS Identification: CWJ



2.19.5 Coordinates: 33-26-29.603N / 111-59-44.4331W

2.19.6 Site Elevation: 1129.1 ft

2.19.1 ILS Type: Localizer for runway 26. Magnetic variation: 12E

2.19.2 ILS Identification: CWJ

2.19.5 Coordinates: 33-26-27.1078N / 112-1-59.2267W

2.19.6 Site Elevation: 1105.1 ft

**General Remarks:**

TWYS A, A1, A2, A3, A4, A5, A6, A7, A8, A9, A10, A11, A12, F BTN G2 AND G3, D BTN D8 AND T, D BTN S AND R, RESTRICTED TO A WINGSPAN OF LESS THAN 135 FT.

NO EXPERIMENTAL FLT OR GND DMSTRN ON ARPT WO PRIOR WRITTEN CONSENT FM THE AIRSIDE OPS.

NO ENG RUNS ON ARPT WO PRIOR COORDN WITH AIRSIDE OPS. NO ENG RUNS ON ARPT BETWEEN 2300L - 0500L.

RWY STATUS LGTS ARE IN OPN.

FOR GENERAL QUESTIONS CALL AIRPORT COMMUNICATIONS CENTER (602) 273-3302

ASDE-X IN USE. OPERATE TRANSPONDERS WITH ALTITUDE REPORTING MODE AND ADS-B (IF EQUIPPED) ENABLED ON ALL AIRPORT SURFACES.

TWY R OVERHEAD TRAIN BRIDGE AT MIDPOINT PROVIDES 82FT-4 IN. CLEARANCE.

TWY H5, H6, H7, TWY H BTN TWY H4 AND TWY H7 CLSD TO ACFT WINGSPAN MORE THAN 171 FT.

TWY F BTW TWY INT G2 AND G3 CLSD TO ACFT WITH WINGSPAN GREATER THAN 135 FT DUE TO FAA NAV EQUIPMENT.

PPR ACFT WITH WINGSPAN 215 FT OR GREATER (GROUP VI) CALL ARPT OPNS 602-272-2008 FOR FOLLOW-ME SERVICES WHILE TAXIING TO AND FROM RAMP AND RWYS.

REVIEW HOT SPOT INFO ON AIRPORT DIAGRAM. ADDITIONAL SAFETY VIDEO @ [HTTP://SKYHARBOR.COM/BUSINESS/FORPILOTS/SAFETYVIDEOFORPILOTS](http://skyharbor.com/business/forpilots/safetyvideoforpilots)

FEE FOR ALL CHARTERS; TRAVEL CLUBS AND CERTAIN REVENUE PRODUCING ACFT.

PRACTICE INSTRUMENT APPROACHES, STOP & TAXI BACK LANDINGS, STOP & GO LANDINGS, TOUCH & GO LANDINGS ARE PROHIBITED. ALL OTHER FLIGHT TRAINING OPERATIONS PROHIBITED WO PRIOR WRITTEN APPROVAL (AIRSIDE OPS 602-272-2008).

TWYS C BTN S AND R, D BTN D2 AND D7, D3, D6, H BTN H4 AND H7, H7 RESTRICTED TO WINGSPAN OF LESS THAN 171 FT.

TWY R AND PORTIONS OF TWYS S AND T DIRECTLY BELOW THE ATCT ARE NON VISIBLE AREAS FROM THE ATCT.

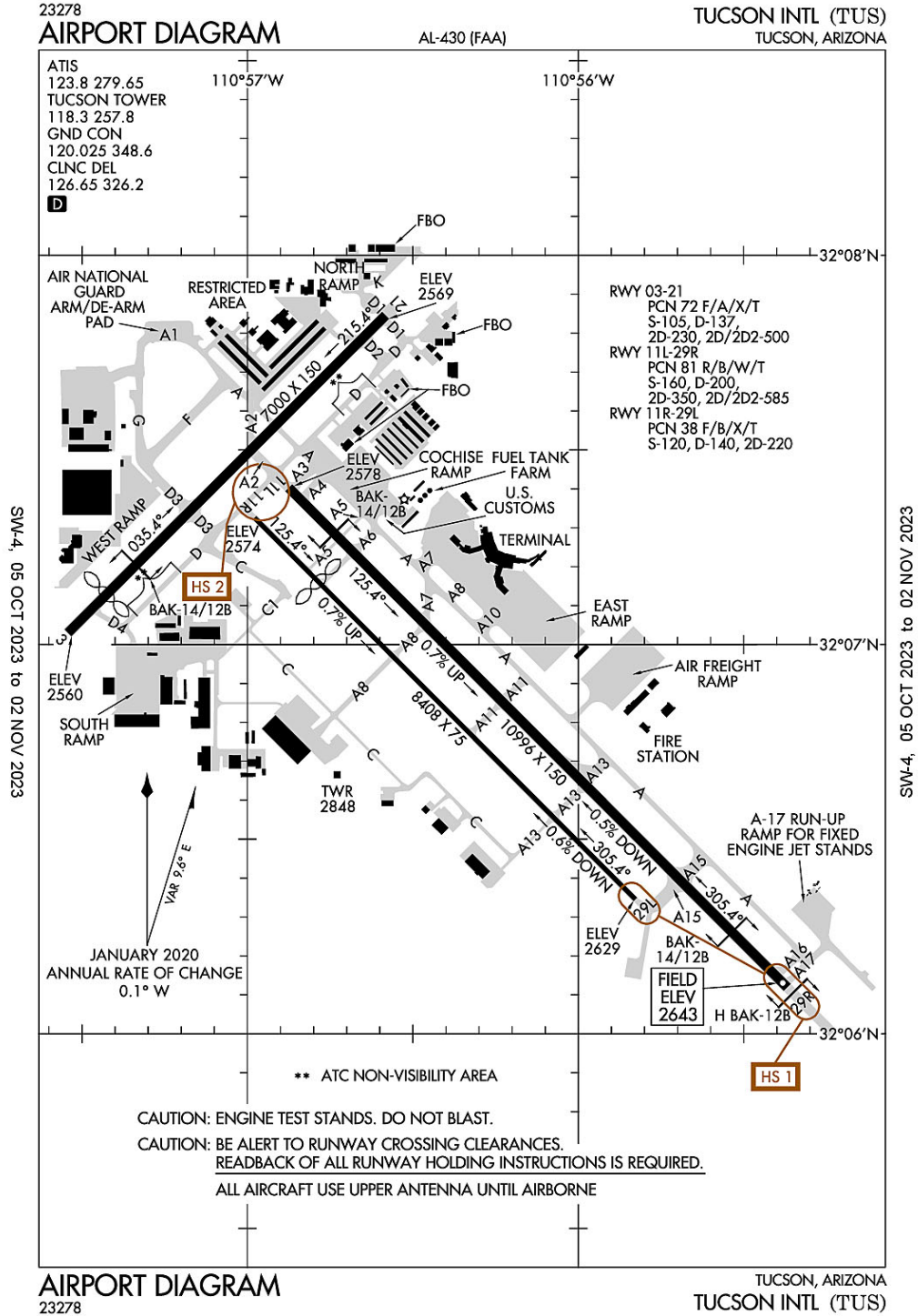
NATL GUARD HAS LMTD TSNT MAINTENANCE AND PARKING RON BY PPR (602)302-9119.

INTERNATIONAL GATE USE RQS COORDN WITH ARPT OPS 48 HOURS PRIOR TO ARRIVAL.

NOISE ABATEMENT PROCEDURES ARE IN AFFECT AT ALL TIMES.

INTERNATIONAL LANDING RIGHTS RQRS US CUSTOMS AND BORDER PROTECTION NOTIFICATION 48 HOURS PRIOR TO LANDING.

**Tucson, Arizona**  
**Tucson International**  
**ICAO Identifier KTUS**



**Tucson, AZ**  
**Tucson Intl**  
**ICAO Identifier KTUS**

**AD 2.2 Aerodrome geographical and administrative data**

- 2.2.1 Reference Point: 32-6-57.849N / 110-56-27.65W
- 2.2.2 From City: 6 miles S of TUCSON, AZ
- 2.2.3 Elevation: 2643 ft
- 2.2.5 Magnetic Variation: 12E (1995)
- 2.2.6 Airport Contact: DANETTE BEWLEY  
TUCSON APT AUTH 7250 S TUCSON BLVD  
TUCSON, AZ 85756 (520-573-8100)
- 2.2.7 Traffic: IFR/VFR

**AD 2.3 Attendance Schedule**

- 2.3.1 All Months, All Days, All Hours

**AD 2.4 Handling Services and Facilities**

- 2.4.1 Cargo Handling Facilities: YES
- 2.4.2 Fuel Types: 100LL,A,A++
- 2.4.5 Hangar Space:
- 2.4.6 Repair Facilities: MAJOR

**AD 2.6 Rescue and Firefighting Services**

- 2.6.1 Aerodrome Category: Class-I certified on 5/1/1973
- 2.6.2 Rescue and Firefighting Services: ARFF Index-C

**AD 2.12 Runway Physical Characteristics**

- 2.12.1 Designation: 03
- 2.12.2 True Bearing: 45
- 2.12.3 Dimensions: 7000 ft x 150 ft
- 2.12.4 PCN: 72 F/A/X/T
- 2.12.5 Coordinates: 32-7-1.7975N / 110-57-32.5438W
- 2.12.6 Threshold Elevation: 2560.2 ft
- 2.12.6 Touchdown Zone Elevation: 2572.1 ft
  
- 2.12.1 Designation: 21
- 2.12.2 True Bearing: 225
- 2.12.3 Dimensions: 7000 ft x 150 ft
- 2.12.4 PCN: 72 F/A/X/T
- 2.12.5 Coordinates: 32-7-50.7361N / 110-56-34.9535W
- 2.12.6 Threshold Elevation: 2568.8 ft
- 2.12.6 Touchdown Zone Elevation: 2572.4 ft
  
- 2.12.1 Designation: 11L
- 2.12.2 True Bearing: 135
- 2.12.3 Dimensions: 10996 ft x 150 ft
- 2.12.4 PCN: 81 R/B/W/T
- 2.12.5 Coordinates: 32-7-24.1289N / 110-56-52.4852W
- 2.12.6 Threshold Elevation: 2577.7 ft
- 2.12.6 Touchdown Zone Elevation: 2598.5 ft

2.12.1 Designation: 29R  
2.12.2 True Bearing: 315  
2.12.3 Dimensions: 10996 ft x 150 ft  
2.12.4 PCN: 81 R/B/W/T  
2.12.5 Coordinates: 32-6-7.1598N / 110-55-22.1441W  
2.12.6 Threshold Elevation: 2643 ft  
2.12.6 Touchdown Zone Elevation: 2643 ft

2.12.1 Designation: 11R  
2.12.2 True Bearing: 135  
2.12.3 Dimensions: 8408 ft x 75 ft  
2.12.4 PCN: 38 F/B/X/T  
2.12.5 Coordinates: 32-7-19.5659N / 110-56-58.741W  
2.12.6 Threshold Elevation: 2573.5 ft  
2.12.6 Touchdown Zone Elevation: 2605 ft

2.12.1 Designation: 29L  
2.12.2 True Bearing: 315  
2.12.3 Dimensions: 8408 ft x 75 ft  
2.12.4 PCN: 38 F/B/X/T  
2.12.5 Coordinates: 32-6-20.7186N / 110-55-49.6599W  
2.12.6 Threshold Elevation: 2628.6 ft  
2.12.6 Touchdown Zone Elevation: 2628.7 ft

#### **AD 2.13 Declared Distances**

2.13.1 Designation: 03  
2.13.2 Take-off Run Available: 7000  
2.13.3 Take-off Distance Available: 7000  
2.13.4 Accelerate-Stop Distance Available: 7000  
2.13.5 Landing Distance Available: 6150

2.13.1 Designation: 21  
2.13.2 Take-off Run Available: 6000  
2.13.3 Take-off Distance Available: 7000  
2.13.4 Accelerate-Stop Distance Available: 6000  
2.13.5 Landing Distance Available: 6000

2.13.1 Designation: 11L  
2.13.2 Take-off Run Available: 10996  
2.13.3 Take-off Distance Available: 10996  
2.13.4 Accelerate-Stop Distance Available: 10996  
2.13.5 Landing Distance Available: 10996

2.13.1 Designation: 29R  
2.13.2 Take-off Run Available: 10996  
2.13.3 Take-off Distance Available: 10996  
2.13.4 Accelerate-Stop Distance Available: 10996  
2.13.5 Landing Distance Available: 10996

2.13.1 Designation: 11R  
2.13.2 Take-off Run Available: 8408  
2.13.3 Take-off Distance Available: 8408  
2.13.4 Accelerate-Stop Distance Available: 8408  
2.13.5 Landing Distance Available: 6998

2.13.1 Designation: 29L  
2.13.2 Take-off Run Available: 8408  
2.13.3 Take-off Distance Available: 8408  
2.13.4 Accelerate-Stop Distance Available: 8408  
2.13.5 Landing Distance Available: 8408

#### **AD 2.14 Approach and Runway Lighting**

2.14.1 Designation: 03  
2.14.2 Approach Lighting System:  
2.14.4 Visual Approach Slope Indicator System:

2.14.1 Designation: 21  
2.14.2 Approach Lighting System:  
2.14.4 Visual Approach Slope Indicator System: P4L

2.14.1 Designation: 11L  
2.14.2 Approach Lighting System: MALSR  
2.14.4 Visual Approach Slope Indicator System: P4L

2.14.1 Designation: 29R  
2.14.2 Approach Lighting System:  
2.14.4 Visual Approach Slope Indicator System: P4L

2.14.1 Designation: 11R  
2.14.2 Approach Lighting System:  
2.14.4 Visual Approach Slope Indicator System: P4L

2.14.1 Designation: 29L  
2.14.2 Approach Lighting System:  
2.14.4 Visual Approach Slope Indicator System:

#### **AD 2.18 Air Traffic Services Communication Facilities**

2.18.1 Service Designation: ANG COMD POST  
2.18.3 Channel: 138.525  
2.18.5 Hours of Operation:

2.18.1 Service Designation: ATIS  
2.18.3 Channel: 123.8  
2.18.5 Hours of Operation: 24

2.18.1 Service Designation: ATIS  
2.18.3 Channel: 279.65  
2.18.5 Hours of Operation: 24

2.18.1 Service Designation: CD/P  
2.18.3 Channel: 126.65  
2.18.5 Hours of Operation: 24

2.18.1 Service Designation: CD/P  
2.18.3 Channel: 326.2  
2.18.5 Hours of Operation: 24

2.18.1 Service Designation: EMERG  
2.18.3 Channel: 121.5  
2.18.5 Hours of Operation:

2.18.1 Service Designation: EMERG  
2.18.3 Channel: 243  
2.18.5 Hours of Operation:

2.18.1 Service Designation: GND/P  
2.18.3 Channel: 120.025  
2.18.5 Hours of Operation: 24

2.18.1 Service Designation: GND/P  
2.18.3 Channel: 348.6  
2.18.5 Hours of Operation: 24

2.18.1 Service Designation: LCL/P  
2.18.3 Channel: 118.3  
2.18.5 Hours of Operation: 24

2.18.1 Service Designation: LCL/P  
2.18.3 Channel: 257.8  
2.18.5 Hours of Operation: 24

2.18.1 Service Designation: LCL/S  
2.18.3 Channel: 119  
2.18.5 Hours of Operation: 24

### **AD 2.19 Radio Navigation and Landing Aids**

2.19.1 ILS Type: DME for runway 11L. Magnetic variation: 12E  
2.19.2 ILS Identification: TUS  
2.19.5 Coordinates: 32-5-54.9712N / 110-55-3.2284W  
2.19.6 Site Elevation: 2676.1 ft

2.19.1 ILS Type: Glide Slope for runway 11L. Magnetic variation: 12E  
2.19.2 ILS Identification: TUS  
2.19.5 Coordinates: 32-7-14.7604N / 110-56-48.0571W  
2.19.6 Site Elevation: 2580.1 ft

2.19.1 ILS Type: Localizer for runway 11L. Magnetic variation: 12E  
2.19.2 ILS Identification: TUS

2.19.5 Coordinates: 32-5-53.5044N / 110-55-6.1189W

2.19.6 Site Elevation: 2659.9 ft

2.19.1 Navigation Aid Type: VORTAC. Magnetic variation: 12E

2.19.2 Navigation Aid Identification: TUS

2.19.5 Coordinates: 32-5-42.7296N / 110-54-53.4781W

2.19.6 Site Elevation: 2670.5 ft

**General Remarks:**

CTN: REVIEW ARPT DIAGRAM HOT SPOT INFO.

MIL: ANG OFFL BUS ONLY; 72 HR PPR - D844-6731/C520-295-6731; FAX EXTN 6732. BASE OPS 1300Z-2300Z MON-FRI & DRILL WKEND 1300Z-2130Z; CLSD OTR WKENDS, HOL & SKED OFF DAYS. TRAN ALERT MAINT NA. TSNT SI FSL ONLY. CONTR FUEL NA.

ACR USE RWY 03/21 & 11L/29R.

SERVICE-A-GEAR: BAK-14/BAK-12B APCH END RWY 11L AND BAK-14/BAK-12B APCH END RWY 29R, ENGAGEMENTS AVBL ONLY DUR ANG DUTY HR AND 15 MIN PN RQR.

TWY A5 LTD 70000 LB OR LESS.

ALL ACFT USE UPPER ANTENNA UNTIL AIRBORNE.

PPR REQUIRED FOR ALL CHARTER, SPORTS TEAM, CARGO AND MILITARY AIRCRAFT. CONTACT FBO FOR PPR REQUEST. LANDING AND PARKING FEES MAY APPLY FOR ACFT 12500 LBS AND UP.

FLT TRNG 2200-0600 NA EXC PPR - 520-573-8190.

MIL/COMM/BASE OPS ARR CTC TITAN OR PUMA - ANG BASE OPS/COMD POST FREQ.

TL K, TWY D1, NW OF RWY 03/21, AND NORTH RAMP CLSD TO ACFT WITH WINGSPAN GREATER THAN 79 FT.

PTNS TWY D NOT VIS FM ATCT.

CTN: RWY 29L SHORTER NARROW RWY S OF RWY 29R. NW ARR & DEP DO NOT MISTAKE TWY A FOR LNDG SFC; TWY A IS N & PARL TO RWY 29R.

GEN ARPT INFO - 520-573-8182.

GROUP V TAX WITH INBOARD ENG ONLY.

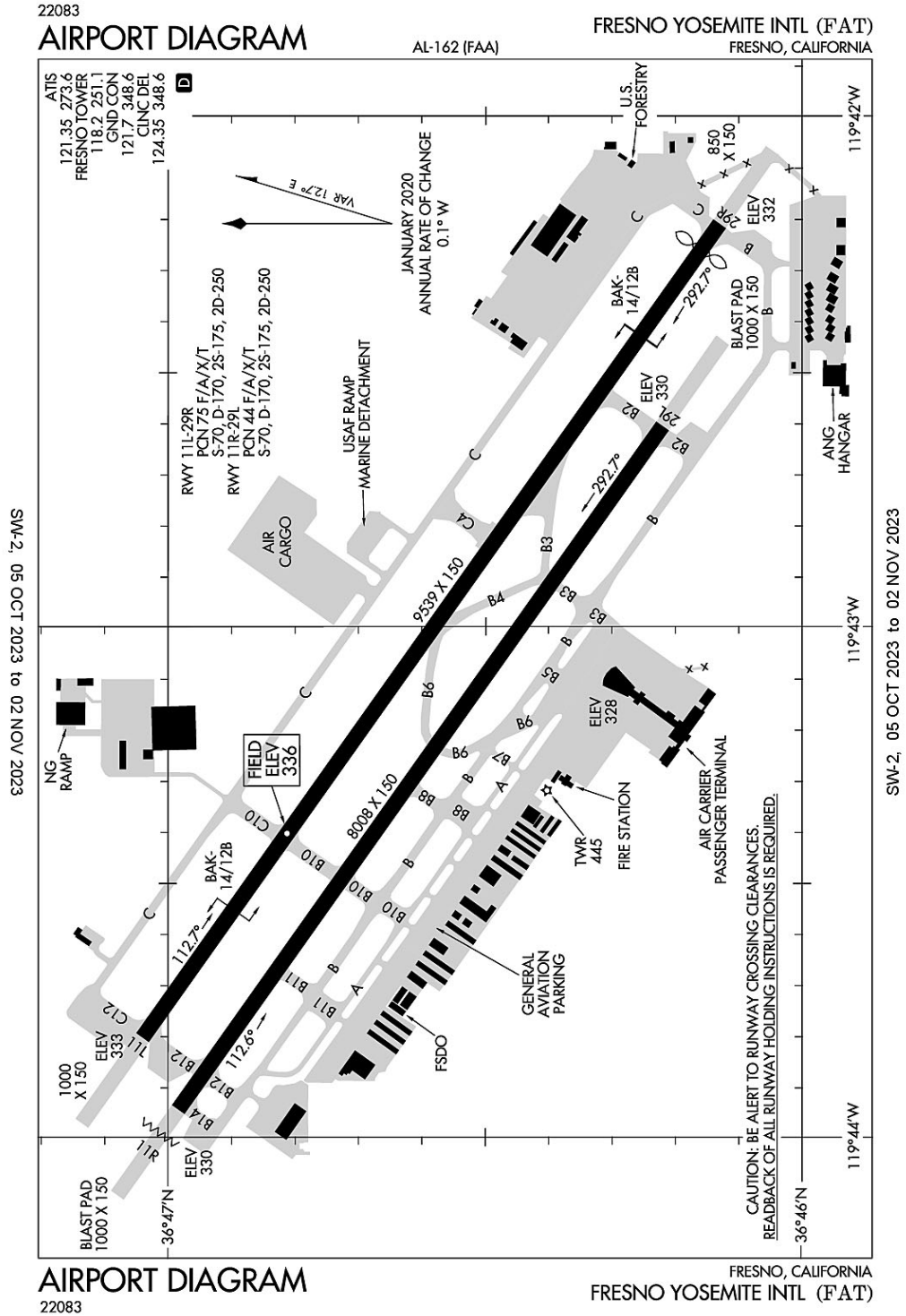
OPERATE TRANSPONDERS ON ALL AIRPORT SURFACES, INCLUDING PUSHBACK AND GATE ARRIVAL.

MIL: BIRD ACT PHASE II IN EFCT 1 JUL-31 AUG.

USCBP INSP RAMP RFLG NA EXC MED EMERG.



### Fresno, California Fresno Yosemite International ICAO Identifier KEAT



**Fresno, CA**  
**Fresno Yosemite Intl**  
**ICAO Identifier KFAT**

**AD 2.2 Aerodrome geographical and administrative data**

- 2.2.1 Reference Point: 36-46-35.6N / 119-43-7.8W
- 2.2.2 From City: 5 miles NE of FRESNO, CA
- 2.2.3 Elevation: 335.5 ft
- 2.2.5 Magnetic Variation: 13E (2020)
- 2.2.6 Airport Contact: HENRY L. THOMPSON  
4995 E CLINTON WAY  
FRESNO, CA 93722 (559-621-4600)
- 2.2.7 Traffic: IFR/VFR

**AD 2.3 Attendance Schedule**

- 2.3.1 All Months, All Days, All Hours

**AD 2.4 Handling Services and Facilities**

- 2.4.1 Cargo Handling Facilities: YES
- 2.4.2 Fuel Types: 100,A,A++
- 2.4.5 Hangar Space: YES
- 2.4.6 Repair Facilities: MAJOR

**AD 2.6 Rescue and Firefighting Services**

- 2.6.1 Aerodrome Category: Class-I certified on 5/1/1973
- 2.6.2 Rescue and Firefighting Services: ARFF Index-C

**AD 2.12 Runway Physical Characteristics**

- 2.12.1 Designation: 11L
- 2.12.2 True Bearing: 125
- 2.12.3 Dimensions: 9539 ft x 150 ft
- 2.12.4 PCN: 75 F/A/X/T
- 2.12.5 Coordinates: 36-47-2.406N / 119-43-48.3081W
- 2.12.6 Threshold Elevation: 333 ft
- 2.12.6 Touchdown Zone Elevation: 335.5 ft
  
- 2.12.1 Designation: 29R
- 2.12.2 True Bearing: 305
- 2.12.3 Dimensions: 9539 ft x 150 ft
- 2.12.4 PCN: 75 F/A/X/T
- 2.12.5 Coordinates: 36-46-7.8228N / 119-42-12.6898W
- 2.12.6 Threshold Elevation: 332 ft
- 2.12.6 Touchdown Zone Elevation: 332.6 ft
  
- 2.12.1 Designation: 29L
- 2.12.2 True Bearing: 305
- 2.12.3 Dimensions: 8008 ft x 150 ft
- 2.12.4 PCN: 44 F/A/X/T
- 2.12.5 Coordinates: 36-46-13.2042N / 119-42-36.4402W
- 2.12.6 Threshold Elevation: 329.9 ft
- 2.12.6 Touchdown Zone Elevation: 330.7 ft

- 2.12.1 Designation: 11R
- 2.12.2 True Bearing: 125
- 2.12.3 Dimensions: 8008 ft x 150 ft
- 2.12.4 PCN: 44 F/A/X/T
- 2.12.5 Coordinates: 36-46-59.0217N / 119-43-56.7171W
- 2.12.6 Threshold Elevation: 330 ft
- 2.12.6 Touchdown Zone Elevation: 332.9 ft

**AD 2.13 Declared Distances**

- 2.13.1 Designation: 11L
- 2.13.2 Take-off Run Available: 9539
- 2.13.3 Take-off Distance Available: 9539
- 2.13.4 Accelerate-Stop Distance Available: 9279
- 2.13.5 Landing Distance Available: 9279

- 2.13.1 Designation: 29R
- 2.13.2 Take-off Run Available: 9539
- 2.13.3 Take-off Distance Available: 9539
- 2.13.4 Accelerate-Stop Distance Available: 9539
- 2.13.5 Landing Distance Available: 9227

- 2.13.1 Designation: 29L
- 2.13.2 Take-off Run Available: 8008
- 2.13.3 Take-off Distance Available: 8008
- 2.13.4 Accelerate-Stop Distance Available: 8008
- 2.13.5 Landing Distance Available: 8008

- 2.13.1 Designation: 11R
- 2.13.2 Take-off Run Available: 8008
- 2.13.3 Take-off Distance Available: 8008
- 2.13.4 Accelerate-Stop Distance Available: 8008
- 2.13.5 Landing Distance Available: 8008

**AD 2.14 Approach and Runway Lighting**

- 2.14.1 Designation: 11L
- 2.14.2 Approach Lighting System:
- 2.14.4 Visual Approach Slope Indicator System: P4L

- 2.14.1 Designation: 29R
- 2.14.2 Approach Lighting System: ALSF2
- 2.14.4 Visual Approach Slope Indicator System: P4L

- 2.14.1 Designation: 29L
- 2.14.2 Approach Lighting System:
- 2.14.4 Visual Approach Slope Indicator System: P4L

- 2.14.1 Designation: 11R
- 2.14.2 Approach Lighting System:

2.14.4 Visual Approach Slope Indicator System:

**AD 2.18 Air Traffic Services Communication Facilities**

2.18.1 Service Designation: ANG OPS

2.18.3 Channel: 140

2.18.5 Hours of Operation:

2.18.1 Service Designation: ANG OPS

2.18.3 Channel: 298.3

2.18.5 Hours of Operation:

2.18.1 Service Designation: APCH/P DEP/P (091-239)

2.18.3 Channel: 132.35

2.18.5 Hours of Operation: 24

2.18.1 Service Designation: APCH/P DEP/P (091-239)

2.18.3 Channel: 323.25

2.18.5 Hours of Operation: 24

2.18.1 Service Designation: APCH/P DEP/P IC (240-090)

2.18.3 Channel: 119.6

2.18.5 Hours of Operation: 24

2.18.1 Service Designation: APCH/P DEP/P IC (240-090)

2.18.3 Channel: 351.95

2.18.5 Hours of Operation: 24

2.18.1 Service Designation: APCH/S DEP/S (S/SE VISALIA AREA)

2.18.3 Channel: 118.5

2.18.5 Hours of Operation: 24

2.18.1 Service Designation: APCH/S DEP/S (S/SE VISALIA AREA)

2.18.3 Channel: 268.7

2.18.5 Hours of Operation: 24

2.18.1 Service Designation: ATIS

2.18.3 Channel: 121.35

2.18.5 Hours of Operation: 24

2.18.1 Service Designation: ATIS

2.18.3 Channel: 273.6

2.18.5 Hours of Operation: 24

2.18.1 Service Designation: CD/P

2.18.3 Channel: 124.35

2.18.5 Hours of Operation: 24

2.18.1 Service Designation: CD/P

2.18.3 Channel: 348.6

2.18.5 Hours of Operation: 24

2.18.1 Service Designation: CLASS C (240-090)  
2.18.3 Channel: 119.6  
2.18.5 Hours of Operation: 24

2.18.1 Service Designation: CLASS C (091-239)  
2.18.3 Channel: 132.35  
2.18.5 Hours of Operation: 24

2.18.1 Service Designation: CLASS C (091-239)  
2.18.3 Channel: 323.25  
2.18.5 Hours of Operation: 24

2.18.1 Service Designation: CLASS C (240-090)  
2.18.3 Channel: 351.95  
2.18.5 Hours of Operation: 24

2.18.1 Service Designation: EMERG  
2.18.3 Channel: 121.5  
2.18.5 Hours of Operation:

2.18.1 Service Designation: EMERG  
2.18.3 Channel: 243  
2.18.5 Hours of Operation:

2.18.1 Service Designation: GND/P  
2.18.3 Channel: 121.7  
2.18.5 Hours of Operation: 24

2.18.1 Service Designation: GND/P  
2.18.3 Channel: 348.6  
2.18.5 Hours of Operation: 24

2.18.1 Service Designation: LCL/P  
2.18.3 Channel: 118.2  
2.18.5 Hours of Operation: 24

2.18.1 Service Designation: LCL/P  
2.18.3 Channel: 251.1  
2.18.5 Hours of Operation: 24

2.18.1 Service Designation: NG OPS  
2.18.3 Channel: 40.95  
2.18.5 Hours of Operation:

2.18.1 Service Designation: NG OPS  
2.18.3 Channel: 132  
2.18.5 Hours of Operation:

2.18.1 Service Designation: NG OPS  
2.18.3 Channel: 255.8

2.18.5 Hours of Operation:

**AD 2.19 Radio Navigation and Landing Aids**

2.19.1 ILS Type: DME for runway 11L. Magnetic variation: 13E

2.19.2 ILS Identification: RPW

2.19.5 Coordinates: 36-47-10.81N / 119-43-56.63W

2.19.6 Site Elevation: 347.1 ft

2.19.1 ILS Type: Localizer for runway 11L. Magnetic variation: 13E

2.19.2 ILS Identification: RPW

2.19.5 Coordinates: 36-46-2.54N / 119-42-3.44W

2.19.6 Site Elevation: 331.3 ft

2.19.1 ILS Type: DME for runway 29R. Magnetic variation: 13E

2.19.2 ILS Identification: FAT

2.19.5 Coordinates: 36-47-10.81N / 119-43-56.63W

2.19.6 Site Elevation: 347.1 ft

2.19.1 ILS Type: Glide Slope for runway 29R. Magnetic variation: 13E

2.19.2 ILS Identification: FAT

2.19.5 Coordinates: 36-46-18.84N / 119-42-23.4799W

2.19.6 Site Elevation: 332 ft

2.19.1 ILS Type: Localizer for runway 29R. Magnetic variation: 13E

2.19.2 ILS Identification: FAT

2.19.5 Coordinates: 36-47-8.2801N / 119-43-58.6W

2.19.6 Site Elevation: 333.7 ft

**General Remarks:**

MILITARY: SVC: RWY 29R AND 11L A-GEAR CABLE AVBL UPON REQ ONLY; DEFAULT POSN DOWN.

MILITARY: ANG: CTC ANG OPS FOR LCL BIRD WATCH COND (BWC).

SERVICE- JET AIR START UNIT (JASU): (AM32A-60) 2(AGPU)

FRESNO YOSEMITE INTL IS NOISE SENSITIVE; NOISE ABATEMENT PROCEDURES IN EFFECT.

SERVICE - FUEL: ROSS AVIATION, C559-251-1555

RETRACTABLE BAK-12/14 AVBL ON RY 11L AND RY 29R ARE KEPT IN RECESSED POSITION UNTIL REQ FOR USE; TWR MUST BE NOTIFIED AT LEAST 5 SECONDS PRIOR TO ENGAGEMENT SO THAT THE AG CABLE MAY BE RAISED.

POSSIBLE WAKE TURBULENCE OR WIND SHEAR ARR TO RY 29L OR DEP FM RY 11R. JET TESTING CONDUCTED AT AIR NATIONAL GUARD RAMP LCTD AT SE CORNER OF ARPT.

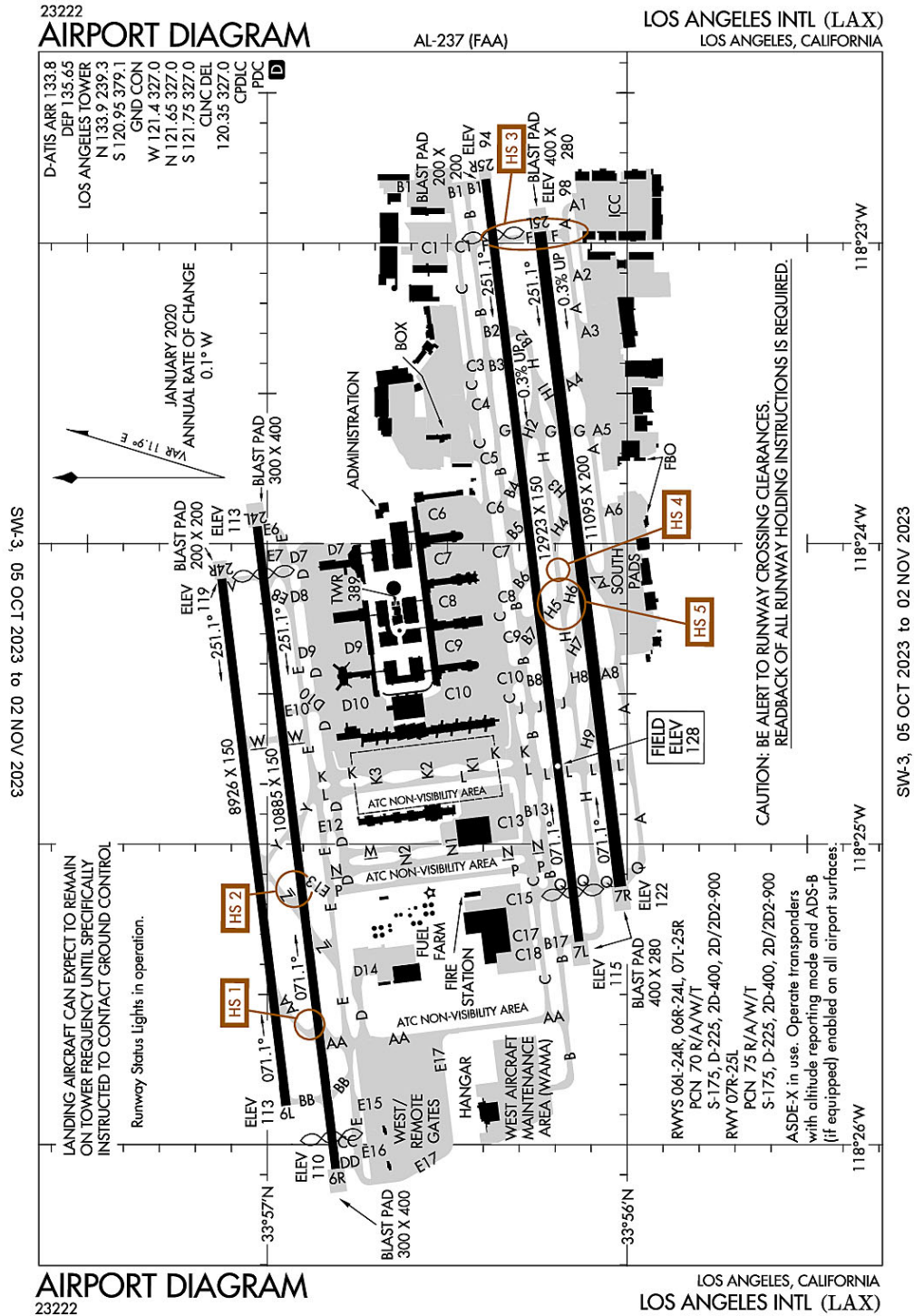
SERVICE-FUEL: SIGNATURE FLIGHT SUPPORT, C559-981-2490

NO MULT APCHS AND LNDGS MON-SAT 2200-0700 AND SUN 1800-1000.

LGTD RY DISTANCE REMAINING MARKERS ON SOUTH SIDE OF RY 11R/29L; LGTD RY DISTANCE REMAINING MARKERS BOTH SIDES OF RY 11L/29R- 11L DRM ON NORTH SIDE; 29R DRM ON SOUTH SIDE.

NUMEROUS BIRDS INVOF ARPT.

Los Angeles, California  
Los Angeles International  
ICAO Identifier KLAX





**Los Angeles, CA**  
**Los Angeles Intl**  
**ICAO Identifier KLAX**

**AD 2.2 Aerodrome geographical and administrative data**

- 2.2.1 Reference Point: 33-56-32.987N / 118-24-28.975W
- 2.2.2 From City: 9 miles SW of LOS ANGELES, CA
- 2.2.3 Elevation: 127.8 ft
- 2.2.5 Magnetic Variation: 12E (2020)
- 2.2.6 Airport Contact: DOUGLAS WEBSTER  
ONE WORLD WAY  
LOS ANGELES, CA 90009 (424-646-8829)
- 2.2.7 Traffic: IFR/VFR

**AD 2.3 Attendance Schedule**

- 2.3.1 All Months, All Days, All Hours

**AD 2.4 Handling Services and Facilities**

- 2.4.1 Cargo Handling Facilities: YES
- 2.4.2 Fuel Types: A
- 2.4.5 Hangar Space:
- 2.4.6 Repair Facilities: MAJOR

**AD 2.6 Rescue and Firefighting Services**

- 2.6.1 Aerodrome Category: Class-I certified on 5/1/1973
- 2.6.2 Rescue and Firefighting Services: ARFF Index-E

**AD 2.12 Runway Physical Characteristics**

- 2.12.1 Designation: 06L
- 2.12.2 True Bearing: 83
- 2.12.3 Dimensions: 8926 ft x 150 ft
- 2.12.4 PCN: 70 R/A/W/T
- 2.12.5 Coordinates: 33-56-56.8049N / 118-25-52.1755W
- 2.12.6 Threshold Elevation: 113.1 ft
- 2.12.6 Touchdown Zone Elevation: 118.8 ft

- 2.12.1 Designation: 24R
- 2.12.2 True Bearing: 263
- 2.12.3 Dimensions: 8926 ft x 150 ft
- 2.12.4 PCN: 70 R/A/W/T
- 2.12.5 Coordinates: 33-57-7.5741N / 118-24-7.0161W
- 2.12.6 Threshold Elevation: 118.9 ft
- 2.12.6 Touchdown Zone Elevation: 122.4 ft

- 2.12.1 Designation: 06R
- 2.12.2 True Bearing: 83
- 2.12.3 Dimensions: 10885 ft x 150 ft
- 2.12.4 PCN: 70 R/A/W/T
- 2.12.5 Coordinates: 33-56-48.5368N / 118-26-4.8042W
- 2.12.6 Threshold Elevation: 109.9 ft
- 2.12.6 Touchdown Zone Elevation: 116.2 ft

2.12.1 Designation: 24L  
2.12.2 True Bearing: 263  
2.12.3 Dimensions: 10885 ft x 150 ft  
2.12.4 PCN: 70 R/A/W/T  
2.12.5 Coordinates: 33-57-1.6678N / 118-23-56.5656W  
2.12.6 Threshold Elevation: 112.9 ft  
2.12.6 Touchdown Zone Elevation: 122.5 ft

2.12.1 Designation: 25R  
2.12.2 True Bearing: 263  
2.12.3 Dimensions: 12923 ft x 150 ft  
2.12.4 PCN: 70 R/A/W/T  
2.12.5 Coordinates: 33-56-23.5604N / 118-22-47.2005W  
2.12.6 Threshold Elevation: 94.3 ft  
2.12.6 Touchdown Zone Elevation: 103.8 ft

2.12.1 Designation: 07L  
2.12.2 True Bearing: 83  
2.12.3 Dimensions: 12923 ft x 150 ft  
2.12.4 PCN: 70 R/A/W/T  
2.12.5 Coordinates: 33-56-7.9864N / 118-25-19.4335W  
2.12.6 Threshold Elevation: 114.8 ft  
2.12.6 Touchdown Zone Elevation: 127.8 ft

2.12.1 Designation: 07R  
2.12.2 True Bearing: 83  
2.12.3 Dimensions: 11095 ft x 200 ft  
2.12.4 PCN: 75 R/A/W/T  
2.12.5 Coordinates: 33-56-1.1378N / 118-25-8.466W  
2.12.6 Threshold Elevation: 121.7 ft  
2.12.6 Touchdown Zone Elevation: 127.6 ft

2.12.1 Designation: 25L  
2.12.2 True Bearing: 263  
2.12.3 Dimensions: 11095 ft x 200 ft  
2.12.4 PCN: 75 R/A/W/T  
2.12.5 Coordinates: 33-56-14.5069N / 118-22-57.7701W  
2.12.6 Threshold Elevation: 97.8 ft  
2.12.6 Touchdown Zone Elevation: 103.7 ft

#### **AD 2.13 Declared Distances**

2.13.1 Designation: 06L  
2.13.2 Take-off Run Available: 8926  
2.13.3 Take-off Distance Available: 8926  
2.13.4 Accelerate-Stop Distance Available: 8566  
2.13.5 Landing Distance Available: 8566

2.13.1 Designation: 24R  
2.13.2 Take-off Run Available: 8926

2.13.3 Take-off Distance Available: 8926  
2.13.4 Accelerate-Stop Distance Available: 8926  
2.13.5 Landing Distance Available: 8926

2.13.1 Designation: 06R  
2.13.2 Take-off Run Available: 10285  
2.13.3 Take-off Distance Available: 10285  
2.13.4 Accelerate-Stop Distance Available: 10285  
2.13.5 Landing Distance Available: 9748

2.13.1 Designation: 24L  
2.13.2 Take-off Run Available: 10285  
2.13.3 Take-off Distance Available: 10285  
2.13.4 Accelerate-Stop Distance Available: 10285  
2.13.5 Landing Distance Available: 9483

2.13.1 Designation: 25R  
2.13.2 Take-off Run Available: 12091  
2.13.3 Take-off Distance Available: 12091  
2.13.4 Accelerate-Stop Distance Available: 12091  
2.13.5 Landing Distance Available: 11134

2.13.1 Designation: 07L  
2.13.2 Take-off Run Available: 12091  
2.13.3 Take-off Distance Available: 12091  
2.13.4 Accelerate-Stop Distance Available: 12091  
2.13.5 Landing Distance Available: 11259

2.13.1 Designation: 07R  
2.13.2 Take-off Run Available: 11095  
2.13.3 Take-off Distance Available: 11095  
2.13.4 Accelerate-Stop Distance Available: 11095  
2.13.5 Landing Distance Available: 11095

2.13.1 Designation: 25L  
2.13.2 Take-off Run Available: 11095  
2.13.3 Take-off Distance Available: 11095  
2.13.4 Accelerate-Stop Distance Available: 11095  
2.13.5 Landing Distance Available: 11095

#### **AD 2.14 Approach and Runway Lighting**

2.14.1 Designation: 06L  
2.14.2 Approach Lighting System: MALSR  
2.14.4 Visual Approach Slope Indicator System: P4L

2.14.1 Designation: 24R  
2.14.2 Approach Lighting System: ALSF2  
2.14.4 Visual Approach Slope Indicator System: P4L

2.14.1 Designation: 06R

2.14.2 Approach Lighting System: MALSR  
2.14.4 Visual Approach Slope Indicator System: P4L

2.14.1 Designation: 24L  
2.14.2 Approach Lighting System: MALSR  
2.14.4 Visual Approach Slope Indicator System: P4R

2.14.1 Designation: 25R  
2.14.2 Approach Lighting System: MALSR  
2.14.4 Visual Approach Slope Indicator System: P4L

2.14.1 Designation: 07L  
2.14.2 Approach Lighting System: MALSR  
2.14.4 Visual Approach Slope Indicator System: P4L

2.14.1 Designation: 07R  
2.14.2 Approach Lighting System: MALSR  
2.14.4 Visual Approach Slope Indicator System: P4L

2.14.1 Designation: 25L  
2.14.2 Approach Lighting System: ALSF2  
2.14.4 Visual Approach Slope Indicator System: P4R

**AD 2.18 Air Traffic Services Communication Facilities**

2.18.1 Service Designation: CD/P  
2.18.3 Channel: 120.35  
2.18.5 Hours of Operation: 24

2.18.1 Service Designation: CD/P  
2.18.3 Channel: 327  
2.18.5 Hours of Operation: 24

2.18.1 Service Designation: D-ATIS (ARR)  
2.18.3 Channel: 133.8  
2.18.5 Hours of Operation: 24

2.18.1 Service Designation: D-ATIS (DEP)  
2.18.3 Channel: 135.65  
2.18.5 Hours of Operation: 24

2.18.1 Service Designation: EMERG  
2.18.3 Channel: 121.5  
2.18.5 Hours of Operation:

2.18.1 Service Designation: EMERG  
2.18.3 Channel: 243  
2.18.5 Hours of Operation:

2.18.1 Service Designation: GND/P (WEST)  
2.18.3 Channel: 121.4

2.18.5 Hours of Operation: 24

2.18.1 Service Designation: GND/P (NORTH-CMPLX)

2.18.3 Channel: 121.65

2.18.5 Hours of Operation: 24

2.18.1 Service Designation: GND/P (SOUTH CMPLX)

2.18.3 Channel: 121.75

2.18.5 Hours of Operation: 24

2.18.1 Service Designation: GND/P

2.18.3 Channel: 327

2.18.5 Hours of Operation: 24

2.18.1 Service Designation: LCL/P (HELICOPTERS)

2.18.3 Channel: 119.8

2.18.5 Hours of Operation: 24

2.18.1 Service Designation: LCL/P IC (SOUTH CMPLX)

2.18.3 Channel: 120.95

2.18.5 Hours of Operation: 24

2.18.1 Service Designation: LCL/P IC (NORTH CMPLX)

2.18.3 Channel: 133.9

2.18.5 Hours of Operation: 24

2.18.1 Service Designation: LCL/P IC (NORTH CMPLX & HELI)

2.18.3 Channel: 239.3

2.18.5 Hours of Operation: 24

2.18.1 Service Designation: LCL/P IC (SOUTH CMPLX)

2.18.3 Channel: 379.1

2.18.5 Hours of Operation: 24

2.18.1 Service Designation: OPS (SAMSO FLT OPS)

2.18.3 Channel: 372.2

2.18.5 Hours of Operation:

2.18.1 Service Designation: RAMP CTL (TXL C10 0630L-2330L)

2.18.3 Channel: 129.325

2.18.5 Hours of Operation: 24

2.18.1 Service Designation: RAMP CTL (TXL C7 0600L-2300L)

2.18.3 Channel: 129.4

2.18.5 Hours of Operation: 24

2.18.1 Service Designation: RAMP CTL (TXL C6 0600L-2300L)

2.18.3 Channel: 129.5

2.18.5 Hours of Operation: 24

2.18.1 Service Designation: RAMP CTL (TXL C9 0530L-2230L)

2.18.3 Channel: 130.5  
2.18.5 Hours of Operation: 24

2.18.1 Service Designation: RAMP CTL (TXL C8 0500L-2359L)  
2.18.3 Channel: 130.85  
2.18.5 Hours of Operation: 24

2.18.1 Service Designation: RAMP CTL (TXL D9)  
2.18.3 Channel: 131.45  
2.18.5 Hours of Operation: 24

2.18.1 Service Designation: SFRA  
2.18.3 Channel: 128.55  
2.18.5 Hours of Operation:

### **AD 2.19 Radio Navigation and Landing Aids**

2.19.1 ILS Type: DME for runway 06L. Magnetic variation: 12E  
2.19.2 ILS Identification: UWU  
2.19.5 Coordinates: 33-56-50.7522N / 118-26-26.6221W  
2.19.6 Site Elevation: 139.3 ft

2.19.1 ILS Type: Glide Slope for runway 06L. Magnetic variation: 12E  
2.19.2 ILS Identification: UWU  
2.19.5 Coordinates: 33-56-54.5859N / 118-25-39.8249W  
2.19.6 Site Elevation: 110.5 ft

2.19.1 ILS Type: Localizer for runway 06L. Magnetic variation: 12E  
2.19.2 ILS Identification: UWU  
2.19.5 Coordinates: 33-57-8.5767N / 118-23-57.1965W  
2.19.6 Site Elevation: 108.5 ft

2.19.1 ILS Type: DME for runway 24R. Magnetic variation: 12E  
2.19.2 ILS Identification: OSS  
2.19.5 Coordinates: 33-56-50.7522N / 118-26-26.6221W  
2.19.6 Site Elevation: 139.3 ft

2.19.1 ILS Type: Glide Slope for runway 24R. Magnetic variation: 12E  
2.19.2 ILS Identification: OSS  
2.19.5 Coordinates: 33-57-2.4082N / 118-24-18.522W  
2.19.6 Site Elevation: 116.7 ft

2.19.1 ILS Type: Localizer for runway 24R. Magnetic variation: 12E  
2.19.2 ILS Identification: OSS  
2.19.5 Coordinates: 33-56-53.1648N / 118-26-27.6839W  
2.19.6 Site Elevation: 125.5 ft

2.19.1 ILS Type: DME for runway 06R. Magnetic variation: 12E  
2.19.2 ILS Identification: GPE  
2.19.5 Coordinates: 33-56-49.9191N / 118-26-22.7714W  
2.19.6 Site Elevation: 134.3 ft

2.19.1 ILS Type: Glide Slope for runway 06R. Magnetic variation: 12E  
2.19.2 ILS Identification: GPE  
2.19.5 Coordinates: 33-56-53.3646N / 118-25-47.3623W  
2.19.6 Site Elevation: 108 ft

2.19.1 ILS Type: Localizer for runway 06R. Magnetic variation: 12E  
2.19.2 ILS Identification: GPE  
2.19.5 Coordinates: 33-57-2.4125N / 118-23-49.2874W  
2.19.6 Site Elevation: 106.3 ft

2.19.1 ILS Type: DME for runway 24L. Magnetic variation: 12E  
2.19.2 ILS Identification: HQB  
2.19.5 Coordinates: 33-56-49.9191N / 118-26-22.7714W  
2.19.6 Site Elevation: 134.3 ft

2.19.1 ILS Type: Glide Slope for runway 24L. Magnetic variation: 12E  
2.19.2 ILS Identification: HQB  
2.19.5 Coordinates: 33-57-2.31N / 118-24-18.51W  
2.19.6 Site Elevation: 116.7 ft

2.19.1 ILS Type: Localizer for runway 24L. Magnetic variation: 12E  
2.19.2 ILS Identification: HQB  
2.19.5 Coordinates: 33-56-46.746N / 118-26-22.2482W  
2.19.6 Site Elevation: 123.4 ft

2.19.1 ILS Type: DME for runway 07L. Magnetic variation: 12E  
2.19.2 ILS Identification: IAS  
2.19.5 Coordinates: 33-56-4.8698N / 118-25-24.8206W  
2.19.6 Site Elevation: 104.3 ft

2.19.1 ILS Type: Glide Slope for runway 07L. Magnetic variation: 12E  
2.19.2 ILS Identification: IAS  
2.19.5 Coordinates: 33-56-7.743N / 118-24-56.7237W  
2.19.6 Site Elevation: 119.8 ft

2.19.1 ILS Type: Localizer for runway 07L. Magnetic variation: 12E  
2.19.2 ILS Identification: IAS  
2.19.5 Coordinates: 33-56-24.7529N / 118-22-35.5432W  
2.19.6 Site Elevation: 90 ft

2.19.1 ILS Type: DME for runway 25R. Magnetic variation: 12E  
2.19.2 ILS Identification: CFN  
2.19.5 Coordinates: 33-56-4.8698N / 118-25-24.8206W  
2.19.6 Site Elevation: 104.3 ft

2.19.1 ILS Type: Glide Slope for runway 25R. Magnetic variation: 12E  
2.19.2 ILS Identification: CFN  
2.19.5 Coordinates: 33-56-17.8773N / 118-23-10.1796W  
2.19.6 Site Elevation: 97.5 ft

2.19.1 ILS Type: Localizer for runway 25R. Magnetic variation: 12E  
2.19.2 ILS Identification: CFN  
2.19.5 Coordinates: 33-56-7.2503N / 118-25-26.6262W  
2.19.6 Site Elevation: 119.3 ft

2.19.1 ILS Type: DME for runway 07R. Magnetic variation: 12E  
2.19.2 ILS Identification: MKZ  
2.19.5 Coordinates: 33-56-3.1899N / 118-25-20.7882W  
2.19.6 Site Elevation: 126 ft

2.19.1 ILS Type: Glide Slope for runway 07R. Magnetic variation: 12E  
2.19.2 ILS Identification: MKZ  
2.19.5 Coordinates: 33-55-59.9253N / 118-24-55.0492W  
2.19.6 Site Elevation: 118.2 ft

2.19.1 ILS Type: Localizer for runway 07R. Magnetic variation: 12E  
2.19.2 ILS Identification: MKZ  
2.19.5 Coordinates: 33-56-15.7853N / 118-22-45.2443W  
2.19.6 Site Elevation: 92.5 ft

2.19.1 ILS Type: DME for runway 25L. Magnetic variation: 12E  
2.19.2 ILS Identification: LAX  
2.19.5 Coordinates: 33-56-3.1899N / 118-25-20.7882W  
2.19.6 Site Elevation: 126 ft

2.19.1 ILS Type: Glide Slope for runway 25L. Magnetic variation: 12E  
2.19.2 ILS Identification: LAX  
2.19.5 Coordinates: 33-56-17.7739N / 118-23-10.2139W  
2.19.6 Site Elevation: 97.3 ft

2.19.1 ILS Type: Localizer for runway 25L. Magnetic variation: 12E  
2.19.2 ILS Identification: LAX  
2.19.5 Coordinates: 33-55-59.8649N / 118-25-20.8676W  
2.19.6 Site Elevation: 118.4 ft

2.19.1 Navigation Aid Type: VORTAC. Magnetic variation: 15E  
2.19.2 Navigation Aid Identification: LAX  
2.19.5 Coordinates: 33-55-59.3368N / 118-25-55.246W  
2.19.6 Site Elevation: 185 ft

**General Remarks:**

TWY D BTN TWY D7 AND D8 (N OF TRML ONE) CLSD TO ACFT WITH WINGSPAN GTR THAN 157 FT.

SIMUL ACFT OPNS PROHIBITED ON TWYS L AND H9 BTWN RWYS 07L/25R AND 07R/25L.

SBND TURN NOT AVBL FROM WEST REMOTE GATE 408 AND WEST REMOTE GATE 409

RWY STATUS LGTS IN OPN.

RWY 7R/25L PREFERRED EMERG RWY.

AMERICAN EAGLE TRML SOUTHBOUND TAXING ACFT USE MNM PWR DUE TO BLAST HAZ.



ANY ACFT THAT COMES TO A STOP OR HAS ITS MOMENTUM INTRPD WHILE TURNING AND TAXING INTO ITS PRKG PSN, MUST STOP AND BE TOWED.

LAX SVC TXL M LAWA RAMP TWR OPN CTC LAWA RAMP TWR 131.975.

TURB MAY BE DEFLECTED UPWARD FM THE BLAST FENCE 180 FT E OF RWY 25R.

ASDE-X IN USE. OPERATE TRANSPONDERS WITH ALTITUDE REPORTING MODE AND ADS-B (IF EQUIPPED) ENABLED ON ALL AIRPORT SURFACES.

PRACTICE INSTRUMENT APPROACHES & TOUCH AND GO LANDINGS ARE PROHIBITED.

NMRS BIRDS ON AND IN VCNTY OF ARPT.

WEST REMOTE GATES: ACFT USE OF OPEN GATES AS TAXI PATH IS PROHIBITED (GATES 406, 407, 408, 409).

NOISE SENS ARPT ON WESTERLY TAKEOFFS NO TURNS BEFORE CROSSING SHORELINE OVER-OCEAN APCHS UTILIZED 0000-0630.

ACFT USE MINIMAL PWR WHEN TXG VCNTY TRMLS DUE BLAST HAZ.

PILOTS SHOULD USE CTN FOR POSS LASER ACT IN THE LAX AREA.

MILITARY RSTD: ALL MIL ACFT OFFL BUS ONLY, MIN 24 HR PPR, CTC 61 ABW/CP FLT OPS DSN 633-3779/4014,C310-653-3779/4014.

ACFT WITH LEN GTR THAN 240 FT ARE PROHIBITED ON TXLS C7, C8 AND C9 BTN TXL C AND TWY B.

ACFT WITH WINGSPAN GTR THAN 198 FT OBND FM TXL D8 MAY NOT TURN WBND ONTO TXL D.

MILITARY AF: ALL MIL AIRCREWS MUST CTC 61 ABW/CP FLT OPS FOR PRKG LCTN/INSTRNS. NO GOVT TRNSPN, QTRS OR SECURITY AVBL. VIP NOTIFICATION PROCS APPLY. USER FEES ASSESSED USING AVCARD CREDIT. CTC SIGNATURE FLIGHT SUPPORT FBO 130.6 INBD. INBD RELAY ETA, VIP CODE, SVC REQ 30 MIN PRIOR TO ARR.

ACFT WITH WINGSPAN GTR THAN 155 FT WB ON TXL C ARE NOT AUTHD TO MAKE LEFT TURN ON TWY C10 UNDER PWR.

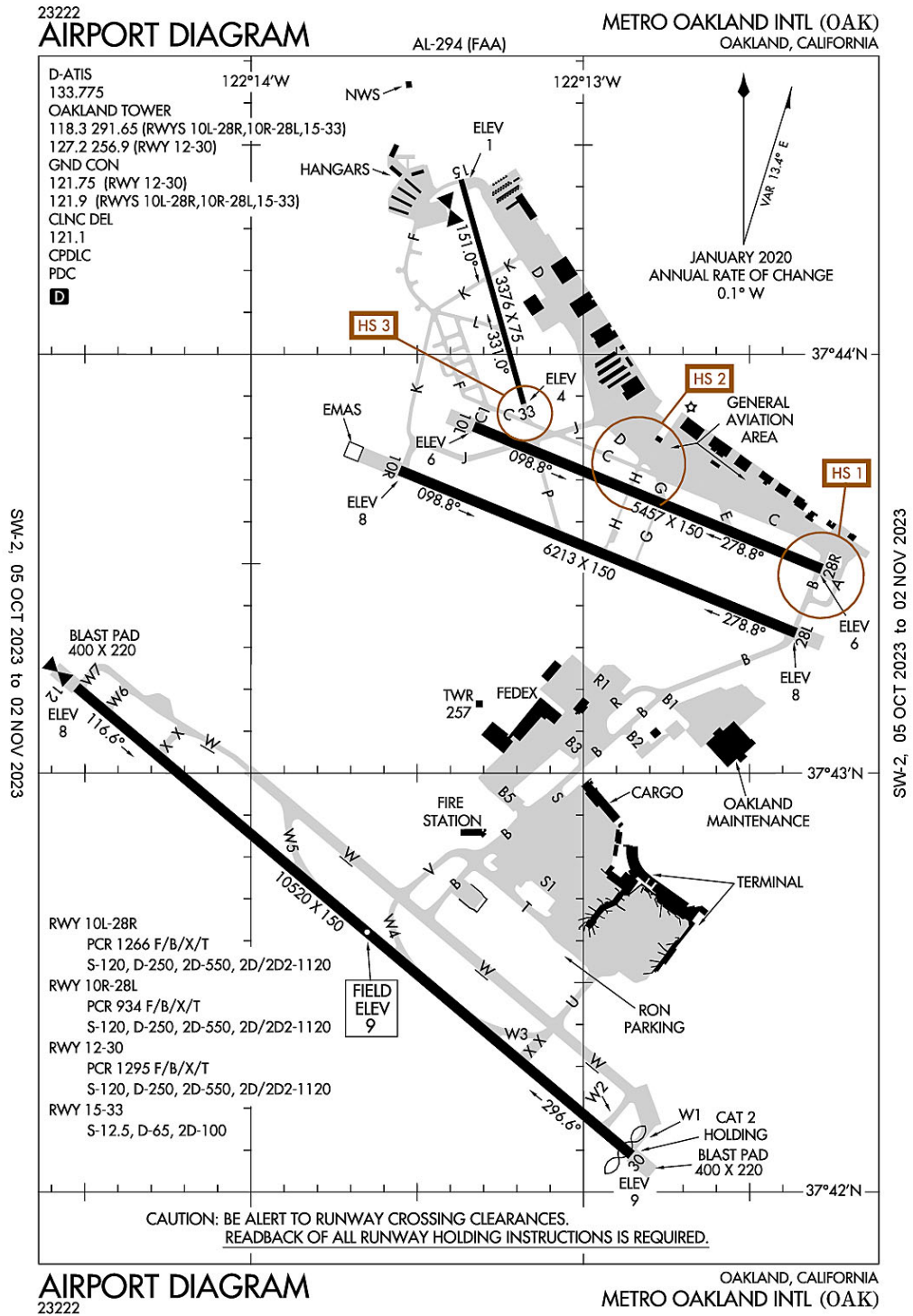
FOR ACFT WITH WINGSPAN GTR THAN 214 FT CTC LAX AIRSIDE OPS (424)-646-5292 FOR ARPT RESTRICTIONS.

MAJOR CONSTRUCTION ON AIRPORT, DAILY.

LAX SVC TXL K AND TXL L LAWA RAMP TWR OPN CTC LAWA RAMP TWR 131.075.

SIMUL ACFT OPNS PROHIBITED ON TWY H2 AND G BTN RWYS 07L/25R AND 07R/25L.

### Oakland, California Metropolitan Oakland International ICAO Identifier KOAK



**Oakland, CA**  
**Metropolitan Oakland Intl**  
**ICAO Identifier KOAK**

**AD 2.2 Aerodrome geographical and administrative data**

- 2.2.1 Reference Point: 37-43-16.541N / 122-13-16.142W
- 2.2.2 From City: 4 miles S of OAKLAND, CA
- 2.2.3 Elevation: 9 ft
- 2.2.5 Magnetic Variation: 14E (2015)
- 2.2.6 Airport Contact: MATT DAVIS  
METROPOLITAN OAKLAND INTL ARPT  
OAKLAND, CA 94621 (510-563-6436)
- 2.2.7 Traffic: IFR/VFR

**AD 2.3 Attendance Schedule**

- 2.3.1 All Months, All Days, All Hours

**AD 2.4 Handling Services and Facilities**

- 2.4.1 Cargo Handling Facilities: YES
- 2.4.2 Fuel Types: 100LL,A
- 2.4.5 Hangar Space:
- 2.4.6 Repair Facilities: MAJOR

**AD 2.6 Rescue and Firefighting Services**

- 2.6.1 Aerodrome Category: Class-I certified on 5/1/1973
- 2.6.2 Rescue and Firefighting Services: ARFF Index-D

**AD 2.12 Runway Physical Characteristics**

- 2.12.1 Designation: 28R
- 2.12.2 True Bearing: 292
- 2.12.3 Dimensions: 5457 ft x 150 ft
- 2.12.4 PCN:
- 2.12.5 Coordinates: 37-43-29.3324N / 122-12-16.9514W
- 2.12.6 Threshold Elevation: 5.8 ft
- 2.12.6 Touchdown Zone Elevation: 6.8 ft

- 2.12.1 Designation: 10L
- 2.12.2 True Bearing: 112
- 2.12.3 Dimensions: 5457 ft x 150 ft
- 2.12.4 PCN:
- 2.12.5 Coordinates: 37-43-49.6892N / 122-13-19.8482W
- 2.12.6 Threshold Elevation: 5.5 ft
- 2.12.6 Touchdown Zone Elevation: 6.3 ft

- 2.12.1 Designation: 28L
- 2.12.2 True Bearing: 292
- 2.12.3 Dimensions: 6213 ft x 150 ft
- 2.12.4 PCN:
- 2.12.5 Coordinates: 37-43-20.1859N / 122-12-21.6335W
- 2.12.6 Threshold Elevation: 8.2 ft
- 2.12.6 Touchdown Zone Elevation: 8.6 ft

2.12.1 Designation: 10R  
2.12.2 True Bearing: 112  
2.12.3 Dimensions: 6213 ft x 150 ft  
2.12.4 PCN:  
2.12.5 Coordinates: 37-43-43.3496N / 122-13-33.2487W  
2.12.6 Threshold Elevation: 8 ft  
2.12.6 Touchdown Zone Elevation: 8.9 ft

2.12.1 Designation: 30  
2.12.2 True Bearing: 310  
2.12.3 Dimensions: 10520 ft x 150 ft  
2.12.4 PCN:  
2.12.5 Coordinates: 37-42-5.3755N / 122-12-51.3287W  
2.12.6 Threshold Elevation: 9 ft  
2.12.6 Touchdown Zone Elevation: 9 ft

2.12.1 Designation: 12  
2.12.2 True Bearing: 130  
2.12.3 Dimensions: 10520 ft x 150 ft  
2.12.4 PCN:  
2.12.5 Coordinates: 37-43-12.2254N / 122-14-31.6144W  
2.12.6 Threshold Elevation: 8.3 ft  
2.12.6 Touchdown Zone Elevation: 8.6 ft

2.12.1 Designation: 15  
2.12.2 True Bearing: 164  
2.12.3 Dimensions: 3376 ft x 75 ft  
2.12.4 PCN:  
2.12.5 Coordinates: 37-44-25.0534N / 122-13-22.1141W  
2.12.6 Threshold Elevation: 1.4 ft  
2.12.6 Touchdown Zone Elevation: 4.6 ft

2.12.1 Designation: 33  
2.12.2 True Bearing: 344  
2.12.3 Dimensions: 3376 ft x 75 ft  
2.12.4 PCN:  
2.12.5 Coordinates: 37-43-52.9059N / 122-13-10.8261W  
2.12.6 Threshold Elevation: 3.9 ft  
2.12.6 Touchdown Zone Elevation: 4.6 ft

#### **AD 2.13 Declared Distances**

2.13.1 Designation: 28R  
2.13.2 Take-off Run Available: 5457  
2.13.3 Take-off Distance Available: 5457  
2.13.4 Accelerate-Stop Distance Available: 5457  
2.13.5 Landing Distance Available: 5457

2.13.1 Designation: 10L  
2.13.2 Take-off Run Available: 5457

2.13.3 Take-off Distance Available: 5457  
2.13.4 Accelerate-Stop Distance Available: 5336  
2.13.5 Landing Distance Available: 5336

2.13.1 Designation: 28L  
2.13.2 Take-off Run Available: 6213  
2.13.3 Take-off Distance Available: 6213  
2.13.4 Accelerate-Stop Distance Available: 6213  
2.13.5 Landing Distance Available: 6213

2.13.1 Designation: 10R  
2.13.2 Take-off Run Available: 6213  
2.13.3 Take-off Distance Available: 6213  
2.13.4 Accelerate-Stop Distance Available: 6213  
2.13.5 Landing Distance Available: 6213

2.13.1 Designation: 30  
2.13.2 Take-off Run Available: 10000  
2.13.3 Take-off Distance Available: 10000  
2.13.4 Accelerate-Stop Distance Available: 10000  
2.13.5 Landing Distance Available: 10000

2.13.1 Designation: 12  
2.13.2 Take-off Run Available: 10000  
2.13.3 Take-off Distance Available: 10000  
2.13.4 Accelerate-Stop Distance Available: 10000  
2.13.5 Landing Distance Available: 10000

2.13.1 Designation: 15  
2.13.2 Take-off Run Available:  
2.13.3 Take-off Distance Available:  
2.13.4 Accelerate-Stop Distance Available:  
2.13.5 Landing Distance Available:

2.13.1 Designation: 33  
2.13.2 Take-off Run Available:  
2.13.3 Take-off Distance Available:  
2.13.4 Accelerate-Stop Distance Available:  
2.13.5 Landing Distance Available:

#### **AD 2.14 Approach and Runway Lighting**

2.14.1 Designation: 28R  
2.14.2 Approach Lighting System: MALSR  
2.14.4 Visual Approach Slope Indicator System: P4L

2.14.1 Designation: 10L  
2.14.2 Approach Lighting System:  
2.14.4 Visual Approach Slope Indicator System: P4R

2.14.1 Designation: 28L

2.14.2 Approach Lighting System:  
2.14.4 Visual Approach Slope Indicator System: P4R

2.14.1 Designation: 10R  
2.14.2 Approach Lighting System:  
2.14.4 Visual Approach Slope Indicator System: P4L

2.14.1 Designation: 30  
2.14.2 Approach Lighting System: ALSF2  
2.14.4 Visual Approach Slope Indicator System: P4L

2.14.1 Designation: 12  
2.14.2 Approach Lighting System: MALSR  
2.14.4 Visual Approach Slope Indicator System: P4R

2.14.1 Designation: 15  
2.14.2 Approach Lighting System:  
2.14.4 Visual Approach Slope Indicator System:

2.14.1 Designation: 33  
2.14.2 Approach Lighting System:  
2.14.4 Visual Approach Slope Indicator System:

**AD 2.18 Air Traffic Services Communication Facilities**

2.18.1 Service Designation: CD/P  
2.18.3 Channel: 121.1  
2.18.5 Hours of Operation: 24

2.18.1 Service Designation: D-ATIS  
2.18.3 Channel: 133.775  
2.18.5 Hours of Operation: 24

2.18.1 Service Designation: EMERG  
2.18.3 Channel: 243  
2.18.5 Hours of Operation:

2.18.1 Service Designation: GND/P (RWY 12/30)  
2.18.3 Channel: 121.75  
2.18.5 Hours of Operation: 24

2.18.1 Service Designation: GND/P (RWY 10L/28R, 10R/28L, 15/33)  
2.18.3 Channel: 121.9  
2.18.5 Hours of Operation: 24

2.18.1 Service Designation: LCL/P (RWY 10L/28R, 10R/28L, 15/33)  
2.18.3 Channel: 118.3  
2.18.5 Hours of Operation: 24

2.18.1 Service Designation: LCL/P (RWY 12/30)  
2.18.3 Channel: 127.2

2.18.5 Hours of Operation: 24

2.18.1 Service Designation: LCL/P (RWY 12/30)

2.18.3 Channel: 256.9

2.18.5 Hours of Operation: 24

2.18.1 Service Designation: LCL/P (RWY 10L/28R, 10R/28L, 15/33)

2.18.3 Channel: 291.65

2.18.5 Hours of Operation: 24

2.18.1 Service Designation: LCL/S

2.18.3 Channel: 124.9

2.18.5 Hours of Operation: 24

### **AD 2.19 Radio Navigation and Landing Aids**

2.19.1 ILS Type: Glide Slope for runway 28R. Magnetic variation: 14E

2.19.2 ILS Identification: OAK

2.19.5 Coordinates: 37-43-28.5969N / 122-12-30.6109W

2.19.6 Site Elevation: 3.5 ft

2.19.1 ILS Type: Localizer for runway 28R. Magnetic variation: 14E

2.19.2 ILS Identification: OAK

2.19.5 Coordinates: 37-43-54.5477N / 122-13-34.872W

2.19.6 Site Elevation: 3.2 ft

2.19.1 ILS Type: Glide Slope for runway 12. Magnetic variation: 14E

2.19.2 ILS Identification: AAZ

2.19.5 Coordinates: 37-43-2.9271N / 122-14-22.8372W

2.19.6 Site Elevation: 3.2 ft

2.19.1 ILS Type: Localizer for runway 12. Magnetic variation: 14E

2.19.2 ILS Identification: AAZ

2.19.5 Coordinates: 37-42-2.2566N / 122-12-46.6504W

2.19.6 Site Elevation: 7.2 ft

2.19.1 ILS Type: DME for runway 30. Magnetic variation: 14E

2.19.2 ILS Identification: INB

2.19.5 Coordinates: 37-43-33.0786N / 122-14-59.0097W

2.19.6 Site Elevation: 22.7 ft

2.19.1 ILS Type: Glide Slope for runway 30. Magnetic variation: 14E

2.19.2 ILS Identification: INB

2.19.5 Coordinates: 37-42-9.7498N / 122-13-5.6377W

2.19.6 Site Elevation: 4.1 ft

2.19.1 ILS Type: Localizer for runway 30. Magnetic variation: 14E

2.19.2 ILS Identification: INB

2.19.5 Coordinates: 37-43-29.8615N / 122-14-58.0858W

2.19.6 Site Elevation: 9.3 ft

2.19.1 Navigation Aid Type: VOR/DME. Magnetic variation: 17E  
2.19.2 Navigation Aid Identification: OAK  
2.19.5 Coordinates: 37-43-33.332N / 122-13-24.9305W  
2.19.6 Site Elevation: 13.2 ft

**General Remarks:**

100 FT LGTD MICROWAVE ANT TWR LCTD 1320 FT WSW OF OAK VORTAC; S OF UPWIND END OF RWY 28L.

TWY A, E, G, H BTN RWY 28R AND TWY C MAX ACFT WT 150,000 LBS.

PREFERENTIAL RWY USE PROGRAM IN EFFECT 2200-0600. NORTH FLD PREF ARR RWY 28L, NORTH FLD PREF DEP RWYS 10R OR 28R. IF THESE RWYS UNACCEPTABLE FOR SAFETY OR ATC INSTRN THEN RWY 12/30 MUST BE USED.

TWY C BTN TWY G & J MAX ACFT WEIGHT 90,000 LBS SINGLE; 144,000 LBS DUAL; 257,000 LBS TANDEM.

400 FT BY 220 FT BLAST PAD RWY 12 AND RWY 30.

TWY P MAX ACFT WT 116,000 LBS SINGLE; 190,000 LBS DUAL; 305,000 LBS DUAL TANDEM; 735,000 LBS DOUBLE DUAL TANDEM.

NOISE ABATEMENT PROCS N/A IN EMERGS OR WHENEVER RWY 12/30 IS CLSD DUE TO MAINT, SAFETY, WINDS OR WX.

RWY 15/33 CLSD TO ACR ACFT.

FOR NOISE ABATEMENT INFO CTC NOISE ABATEMENT OFC AT (510) 563-6463.

TWY C BTN RWY 28R & TWY G AND TWYS B, J, AND D MAX ACFT WT 861,000 LBS.

TWY K BTN TWY J AND INT TWYS F, L, K MAX ACFT WT 33000 LBS SINGLE; 45000 LBS DUAL; TANDEM NA.

24 HR NOISE ABATEMENT PROCEDURE - TBJT AND TURBOFAN PWRD ACFT, TURBOROPS OVER 17,000 LBS, FOUR-ENGINE RECIPROCATING PWRD ACFT, AND SURPLUS MIL ACFT OVER 12,500 POUNDS SHOULD NOT DEP RWYS 28L & 28R OR LAND ON RWYS 10R & 10L.

TWY C BTN TWY J & F MAX ACFT WEIGHT 76,000 LBS SINGLE; 115,000 LBS DUAL; 257,000 LBS TANDEM (DUAL TANDEM NA).

RWYS 30, 28R AND RWY 28L DIST RMNG SIGNS L SIDE.

ACFT WITH EXPERIMENTAL OR LTD CERTIF HAVING OVER 1000 HORSEPOWER OR 4000 LBS ARE RSTRD TO RWY 12/30.

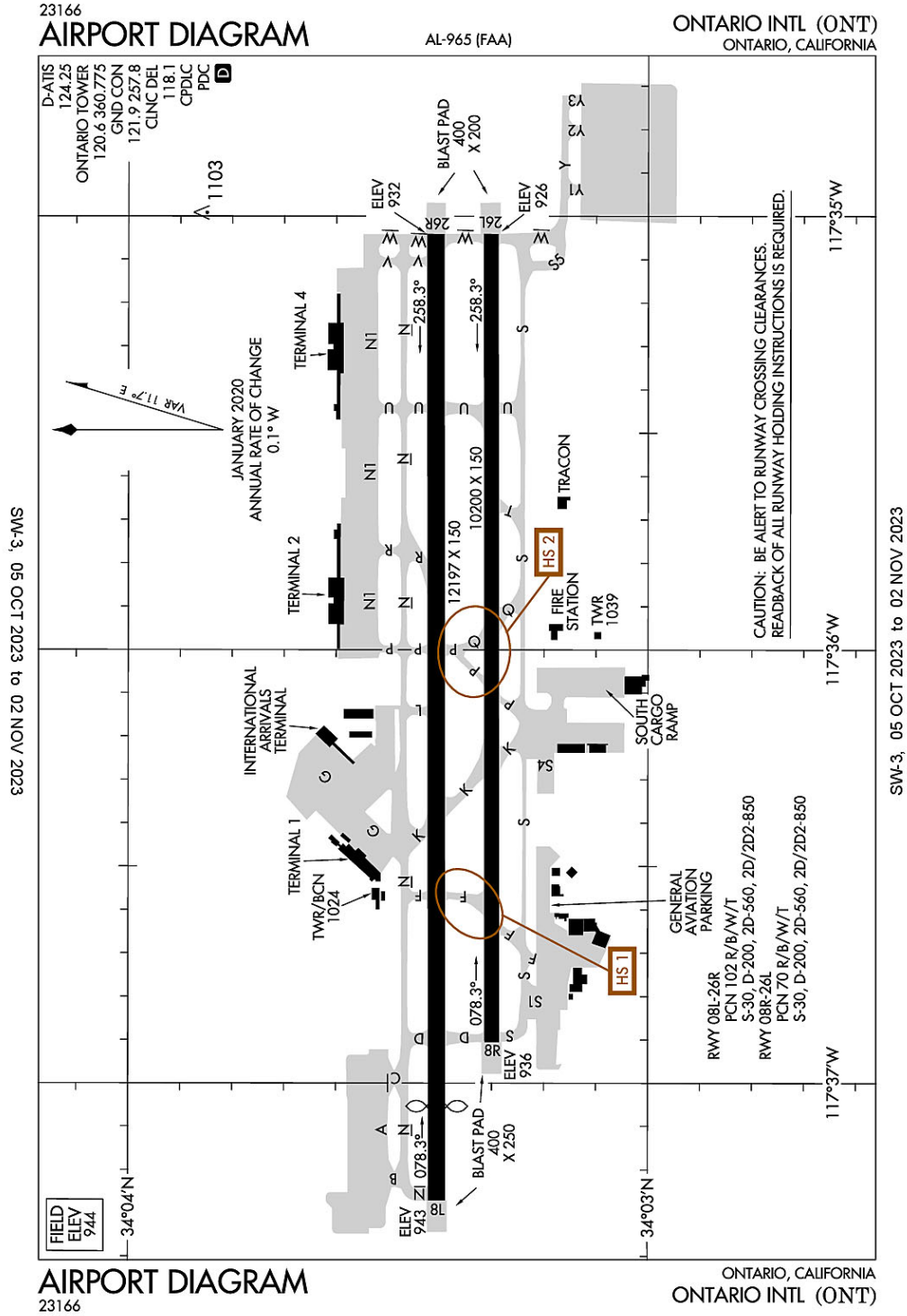
BIRDS ON & INVOF ARPT.

TWY G & H BTN RWY 28L & 28R: MAX ACFT WT 12,500 LBS.

TWY K BTN TWY D & INT TWYS F, L, K MAX ACFT WEIGHT 56,000 LBS SINGLE; 70,000 LBS DUAL; 130,000 LBS TANDEM.



Ontario, California  
Ontario International  
ICAO Identifier KONT



**Ontario, CA**  
**Ontario Intl**  
**ICAO Identifier KONT**

**AD 2.2 Aerodrome geographical and administrative data**

- 2.2.1 Reference Point: 34-3-21.651N / 117-36-4.275W
- 2.2.2 From City: 2 miles E of ONTARIO, CA
- 2.2.3 Elevation: 944.1 ft
- 2.2.5 Magnetic Variation: 12E (2020)
- 2.2.6 Airport Contact: ATIF ELKADI  
1923 EAST AVION STREET  
ONTARIO, CA 91761 (909-544-5432)
- 2.2.7 Traffic: IFR/VFR

**AD 2.3 Attendance Schedule**

- 2.3.1 All Months, All Days, All Hours

**AD 2.4 Handling Services and Facilities**

- 2.4.1 Cargo Handling Facilities: YES
- 2.4.2 Fuel Types: 100LL,A,J
- 2.4.5 Hangar Space:
- 2.4.6 Repair Facilities: MAJOR

**AD 2.6 Rescue and Firefighting Services**

- 2.6.1 Aerodrome Category: Class-I certified on 5/1/1973
- 2.6.2 Rescue and Firefighting Services: ARFF Index-D

**AD 2.12 Runway Physical Characteristics**

- 2.12.1 Designation: 08L
- 2.12.2 True Bearing: 90
- 2.12.3 Dimensions: 12197 ft x 150 ft
- 2.12.4 PCN: 102 R/B/W/T
- 2.12.5 Coordinates: 34-3-24.7651N / 117-37-22.1586W
- 2.12.6 Threshold Elevation: 943.2 ft
- 2.12.6 Touchdown Zone Elevation: 944.1 ft

- 2.12.1 Designation: 26R
- 2.12.2 True Bearing: 270
- 2.12.3 Dimensions: 12197 ft x 150 ft
- 2.12.4 PCN: 102 R/B/W/T
- 2.12.5 Coordinates: 34-3-24.8259N / 117-34-57.2057W
- 2.12.6 Threshold Elevation: 931.8 ft
- 2.12.6 Touchdown Zone Elevation: 931.8 ft

- 2.12.1 Designation: 08R
- 2.12.2 True Bearing: 90
- 2.12.3 Dimensions: 10200 ft x 150 ft
- 2.12.4 PCN: 70 R/B/W/T
- 2.12.5 Coordinates: 34-3-17.8579N / 117-36-58.4219W
- 2.12.6 Threshold Elevation: 936 ft
- 2.12.6 Touchdown Zone Elevation: 936 ft

- 2.12.1 Designation: 26L
- 2.12.2 True Bearing: 270
- 2.12.3 Dimensions: 10200 ft x 150 ft
- 2.12.4 PCN: 70 R/B/W/T
- 2.12.5 Coordinates: 34-3-17.9013N / 117-34-57.1985W
- 2.12.6 Threshold Elevation: 926.2 ft
- 2.12.6 Touchdown Zone Elevation: 926.2 ft

**AD 2.13 Declared Distances**

- 2.13.1 Designation: 08L
- 2.13.2 Take-off Run Available: 12197
- 2.13.3 Take-off Distance Available: 12197
- 2.13.4 Accelerate-Stop Distance Available: 12197
- 2.13.5 Landing Distance Available: 11200

- 2.13.1 Designation: 26R
- 2.13.2 Take-off Run Available: 12197
- 2.13.3 Take-off Distance Available: 12197
- 2.13.4 Accelerate-Stop Distance Available: 12197
- 2.13.5 Landing Distance Available: 12197

- 2.13.1 Designation: 08R
- 2.13.2 Take-off Run Available: 10200
- 2.13.3 Take-off Distance Available: 10200
- 2.13.4 Accelerate-Stop Distance Available: 10200
- 2.13.5 Landing Distance Available: 10200

- 2.13.1 Designation: 26L
- 2.13.2 Take-off Run Available: 10200
- 2.13.3 Take-off Distance Available: 10200
- 2.13.4 Accelerate-Stop Distance Available: 10200
- 2.13.5 Landing Distance Available: 10200

**AD 2.14 Approach and Runway Lighting**

- 2.14.1 Designation: 08L
- 2.14.2 Approach Lighting System: MALSR
- 2.14.4 Visual Approach Slope Indicator System: P4L

- 2.14.1 Designation: 26R
- 2.14.2 Approach Lighting System: ALSF2
- 2.14.4 Visual Approach Slope Indicator System: P4L

- 2.14.1 Designation: 08R
- 2.14.2 Approach Lighting System:
- 2.14.4 Visual Approach Slope Indicator System: P4L

- 2.14.1 Designation: 26L
- 2.14.2 Approach Lighting System: ALSF2

2.14.4 Visual Approach Slope Indicator System: P4R

**AD 2.18 Air Traffic Services Communication Facilities**

2.18.1 Service Designation: CD/P

2.18.3 Channel: 118.1

2.18.5 Hours of Operation: 24

2.18.1 Service Designation: D-ATIS

2.18.3 Channel: 124.25

2.18.5 Hours of Operation: 24

2.18.1 Service Designation: EMERG

2.18.3 Channel: 121.5

2.18.5 Hours of Operation:

2.18.1 Service Designation: EMERG

2.18.3 Channel: 243

2.18.5 Hours of Operation:

2.18.1 Service Designation: GND/P

2.18.3 Channel: 121.9

2.18.5 Hours of Operation: 24

2.18.1 Service Designation: GND/P

2.18.3 Channel: 257.8

2.18.5 Hours of Operation: 24

2.18.1 Service Designation: LCL/P

2.18.3 Channel: 120.6

2.18.5 Hours of Operation: 24

2.18.1 Service Designation: LCL/P

2.18.3 Channel: 360.775

2.18.5 Hours of Operation: 24

**AD 2.19 Radio Navigation and Landing Aids**

2.19.1 ILS Type: Glide Slope for runway 08L. Magnetic variation: 12E

2.19.2 ILS Identification: AOD

2.19.5 Coordinates: 34-3-21.2425N / 117-36-59.9428W

2.19.6 Site Elevation: 935.9 ft

2.19.1 ILS Type: Localizer for runway 08L. Magnetic variation: 12E

2.19.2 ILS Identification: AOD

2.19.5 Coordinates: 34-3-24.8274N / 117-34-45.0837W

2.19.6 Site Elevation: 929.1 ft

2.19.1 ILS Type: DME for runway 26R. Magnetic variation: 12E

2.19.2 ILS Identification: ONT

2.19.5 Coordinates: 34-3-22.0428N / 117-37-33.7049W

2.19.6 Site Elevation: 955 ft

2.19.1 ILS Type: Glide Slope for runway 26R. Magnetic variation: 12E

2.19.2 ILS Identification: ONT

2.19.5 Coordinates: 34-3-22.0256N / 117-35-11.0293W

2.19.6 Site Elevation: 925.2 ft

2.19.1 ILS Type: Localizer for runway 26R. Magnetic variation: 12E

2.19.2 ILS Identification: ONT

2.19.5 Coordinates: 34-3-24.7616N / 117-37-34.6764W

2.19.6 Site Elevation: 946.2 ft

2.19.1 ILS Type: DME for runway 26L. Magnetic variation: 12E

2.19.2 ILS Identification: TWO

2.19.5 Coordinates: 34-3-20.4777N / 117-37-8.8646W

2.19.6 Site Elevation: 947.7 ft

2.19.1 ILS Type: Glide Slope for runway 26L. Magnetic variation: 12E

2.19.2 ILS Identification: TWO

2.19.5 Coordinates: 34-3-21.9048N / 117-35-11.0216W

2.19.6 Site Elevation: 925.2 ft

2.19.1 ILS Type: Inner Marker for runway 26L. Magnetic variation: 12E

2.19.2 ILS Identification: TWO

2.19.5 Coordinates: 34-3-17.924N / 117-34-47.8618W

2.19.6 Site Elevation: 923.6 ft

2.19.1 ILS Type: Localizer for runway 26L. Magnetic variation: 12E

2.19.2 ILS Identification: TWO

2.19.5 Coordinates: 34-3-17.8524N / 117-37-10.2711W

2.19.6 Site Elevation: 931.1 ft

**General Remarks:**

ALL MILITARY AND GENERAL AVIATION (FIXED OR ROTOR WING) ACFT OPS ARE RESTRICTED TO FBO FACILITIES WITH ADVANCE COORDINATION; OVERNIGHT TIEDOWN AND PARKING FEE.

PILOTS SHOULD USE JUDGEMENTAL OVERSTEER ON TWY S-4.

ACFT PRKG AND CONTR GND SVCS ARE LTD FOR UNSKED OPS. FOR SKED INFO CALL AIRFIELD OPS (909) 214-7682/7683.

EASTBOUND B747, B777, A330, A340 OR LARGER ACFT ON TWY S PROHIBITED FROM NORTHBOUND TURNS ONTO TWY K.

TWY S-4 RSTD TO ACFT WITH WINGSPAN 117 FT OR SMALLER.

FBO ON FREQ 130.75.

B747, B777, A330, A340 OR LARGER ACFT ON TWY S PROHIBITED FROM NORTHBOUND TURNS ONTO TWY P.

NOISE ABATEMENT PROCEDURES IN EFFECT; FULL-LENGTH TURBOJET DEP ENCOURAGED, NIGHTLY PREFERENTIAL RWY USAGE, 2200-0700.

TWY Y EAST OF TWY W IS A NON-MOVEMENT AREA; ALL ACFT CTC RAMP CTL 131.325 FOR ACCESS.

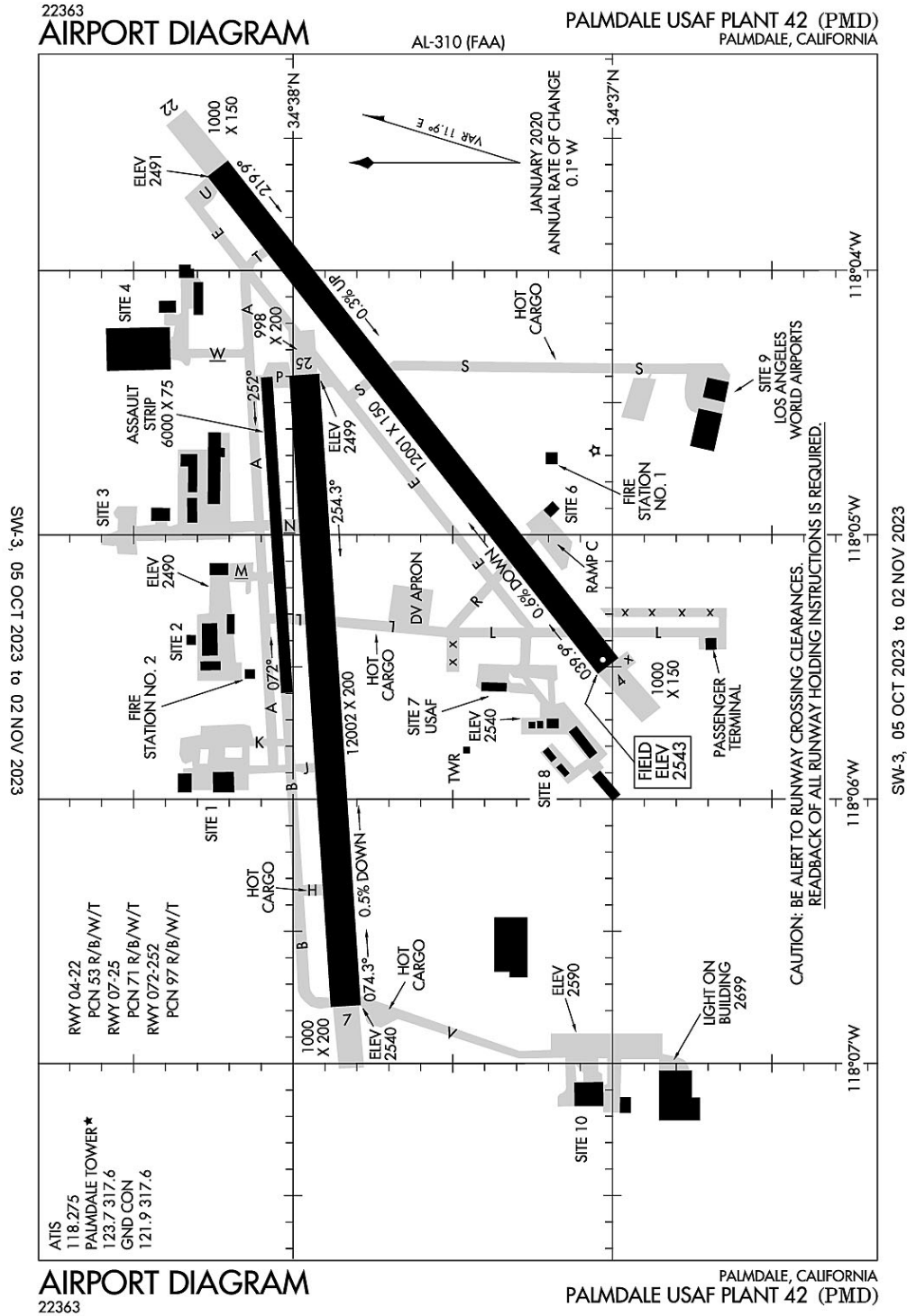
PTNS OF TWY S IN THE VCY OF TWY F ARE NOT VSB FM ATCT; PILOTS USE CTN ENTERING TWY F SOUTH OF TWY S.

WILDLIFE HAZARD MGT PLAN IN EFFECT; POTENTIAL BIRD HAZARDS MAY EXIST ON AND INVOF ARPT; BE ALERT TO LARGE NUMBERS OF STARLINGS AND CROWS POSSIBLE ON APCH TO RY 26L AND RY 26R, HAWKS, EAGLES, FALCONS AND OWLS SPOTTED ON OCCASION.

ACFT ACCESS TO TWY R FROM RWY 26R PROHIBITED

TWY F SOUTH OF TWY S RSTRD TO ACFT WITH 117 FT WINGSPAN AND SMALLER. TWY F SOUTH OF RWY 26L RSTRD TO ACFT WITH 180 FT WINGSPAN.

**Palmdale, California**  
**Palmdale Regional/USAF Plant 42**  
**ICAO Identifier KPMD**



**Palmdale, CA**  
**Palmdale Rgnl/USAF Plant 42**  
**ICAO Identifier KPMD**

**AD 2.2 Aerodrome geographical and administrative data**

- 2.2.1 Reference Point: 34-37-45.8N / 118-5-4.39W
- 2.2.2 From City: 3 miles NE of PALMDALE, CA
- 2.2.3 Elevation: 2542.5 ft
- 2.2.5 Magnetic Variation: 12E (2020)
- 2.2.6 Airport Contact: MATT FISHER  
2503 E AVE P  
PALMDALE, CA 93550 (661-275-9342)
- 2.2.7 Traffic: IFR/VFR

**AD 2.3 Attendance Schedule**

- 2.3.1 All Months, All Days, 1330-0600Z++ Hours

**AD 2.4 Handling Services and Facilities**

- 2.4.1 Cargo Handling Facilities: NO
- 2.4.2 Fuel Types:
- 2.4.5 Hangar Space:
- 2.4.6 Repair Facilities: None

**AD 2.6 Rescue and Firefighting Services**

- 2.6.1 Aerodrome Category: None
- 2.6.2 Rescue and Firefighting Services: None

**AD 2.12 Runway Physical Characteristics**

- 2.12.1 Designation: 04
- 2.12.2 True Bearing: 52
- 2.12.3 Dimensions: 12001 ft x 150 ft
- 2.12.4 PCN: 53 R/B/W/T
- 2.12.5 Coordinates: 34-37-0.842N / 118-5-29.802W
- 2.12.6 Threshold Elevation: 2542.5 ft
- 2.12.6 Touchdown Zone Elevation: 2542.5 ft
  
- 2.12.1 Designation: 22
- 2.12.2 True Bearing: 232
- 2.12.3 Dimensions: 12001 ft x 150 ft
- 2.12.4 PCN: 53 R/B/W/T
- 2.12.5 Coordinates: 34-38-14.236N / 118-3-36.966W
- 2.12.6 Threshold Elevation: 2491.1 ft
- 2.12.6 Touchdown Zone Elevation: 2497.9 ft
  
- 2.12.1 Designation: 25
- 2.12.2 True Bearing: 266
- 2.12.3 Dimensions: 12002 ft x 200 ft
- 2.12.4 PCN: 71 R/B/W/T
- 2.12.5 Coordinates: 34-37-57.991N / 118-4-23.743W
- 2.12.6 Threshold Elevation: 2498.7 ft
- 2.12.6 Touchdown Zone Elevation: 2503.4 ft



2.12.1 Designation: 07  
2.12.2 True Bearing: 86  
2.12.3 Dimensions: 12002 ft x 200 ft  
2.12.4 PCN: 71 R/B/W/T  
2.12.5 Coordinates: 34-37-50.106N / 118-6-47.029W  
2.12.6 Threshold Elevation: 2540.2 ft  
2.12.6 Touchdown Zone Elevation: 2540.2 ft

2.12.1 Designation: 252  
2.12.2 True Bearing:  
2.12.3 Dimensions: 6000 ft x 75 ft  
2.12.4 PCN: 97 R/B/W/T  
2.12.5 Coordinates: -- / --  
2.12.6 Threshold Elevation: ft  
2.12.6 Touchdown Zone Elevation: ft

2.12.1 Designation: 072  
2.12.2 True Bearing:  
2.12.3 Dimensions: 6000 ft x 75 ft  
2.12.4 PCN: 97 R/B/W/T  
2.12.5 Coordinates: -- / --  
2.12.6 Threshold Elevation: ft  
2.12.6 Touchdown Zone Elevation: ft

#### **AD 2.13 Declared Distances**

2.13.1 Designation: 04  
2.13.2 Take-off Run Available:  
2.13.3 Take-off Distance Available:  
2.13.4 Accelerate-Stop Distance Available:  
2.13.5 Landing Distance Available:

2.13.1 Designation: 22  
2.13.2 Take-off Run Available:  
2.13.3 Take-off Distance Available:  
2.13.4 Accelerate-Stop Distance Available:  
2.13.5 Landing Distance Available:

2.13.1 Designation: 25  
2.13.2 Take-off Run Available:  
2.13.3 Take-off Distance Available:  
2.13.4 Accelerate-Stop Distance Available:  
2.13.5 Landing Distance Available:

2.13.1 Designation: 07  
2.13.2 Take-off Run Available:  
2.13.3 Take-off Distance Available:  
2.13.4 Accelerate-Stop Distance Available:  
2.13.5 Landing Distance Available:

2.13.1 Designation: 252  
2.13.2 Take-off Run Available:  
2.13.3 Take-off Distance Available:  
2.13.4 Accelerate-Stop Distance Available:  
2.13.5 Landing Distance Available:

2.13.1 Designation: 072  
2.13.2 Take-off Run Available:  
2.13.3 Take-off Distance Available:  
2.13.4 Accelerate-Stop Distance Available:  
2.13.5 Landing Distance Available:

#### **AD 2.14 Approach and Runway Lighting**

2.14.1 Designation: 04  
2.14.2 Approach Lighting System:  
2.14.4 Visual Approach Slope Indicator System: P4L

2.14.1 Designation: 22  
2.14.2 Approach Lighting System:  
2.14.4 Visual Approach Slope Indicator System: P4L

2.14.1 Designation: 25  
2.14.2 Approach Lighting System:  
2.14.4 Visual Approach Slope Indicator System: P4L

2.14.1 Designation: 07  
2.14.2 Approach Lighting System:  
2.14.4 Visual Approach Slope Indicator System: P4L

2.14.1 Designation: 252  
2.14.2 Approach Lighting System:  
2.14.4 Visual Approach Slope Indicator System:

2.14.1 Designation: 072  
2.14.2 Approach Lighting System:  
2.14.4 Visual Approach Slope Indicator System:

#### **AD 2.18 Air Traffic Services Communication Facilities**

2.18.1 Service Designation: ATIS  
2.18.3 Channel: 118.275  
2.18.5 Hours of Operation: 24

2.18.1 Service Designation: EMERG  
2.18.3 Channel: 121.5  
2.18.5 Hours of Operation:

2.18.1 Service Designation: EMERG  
2.18.3 Channel: 243  
2.18.5 Hours of Operation:

2.18.1 Service Designation: GND/P  
2.18.3 Channel: 121.9  
2.18.5 Hours of Operation: OPR 1330-0600Z++.

2.18.1 Service Designation: GND/P  
2.18.3 Channel: 317.6  
2.18.5 Hours of Operation: OPR 1330-0600Z++.

2.18.1 Service Designation: LCL/P  
2.18.3 Channel: 123.7  
2.18.5 Hours of Operation: OPR 1330-0600Z++.

2.18.1 Service Designation: LCL/P  
2.18.3 Channel: 317.6  
2.18.5 Hours of Operation: OPR 1330-0600Z++.

2.18.1 Service Designation: LCL/S  
2.18.3 Channel: 236.6  
2.18.5 Hours of Operation: OPR 1330-0600Z++.

#### **AD 2.19 Radio Navigation and Landing Aids**

2.19.1 ILS Type: Glide Slope for runway 25. Magnetic variation: 12E  
2.19.2 ILS Identification: PMD  
2.19.5 Coordinates: 34-38-1.256N / 118-4-40.078W  
2.19.6 Site Elevation: 2491.8 ft

2.19.1 ILS Type: Localizer for runway 25. Magnetic variation: 12E  
2.19.2 ILS Identification: PMD  
2.19.5 Coordinates: 34-37-48.786N / 118-7-10.911W  
2.19.6 Site Elevation: 2552.2 ft

2.19.1 Navigation Aid Type: VORTAC. Magnetic variation: 15E  
2.19.2 Navigation Aid Identification: PMD  
2.19.5 Coordinates: 34-37-53.0341N / 118-3-49.7607W  
2.19.6 Site Elevation: 2498 ft

#### **General Remarks:**

PRKG RAMP LCTD S OF RWY 22 & TWY V NOT VSB FM ATCT.

MISC: COMSEC STORAGE UNAVBL.

MISC: WINDS ARE EST DUE TO FMQ-13 WIND SENSORS BEING ACCURATE TO WITHIN ONLY +/- 2 KT. ATC/WX WILL NOT INCL/RELAY WIND CORR INTO FCST/PHRASEOLOGY. THEREFORE, AIRCREWS WILL INCORPORATE A +/- 2 KT ACCURACY INTO THEIR DECISION MAKING PROCESS FOR FLYING OPR.

CAUTION: RWY 25 NSTD MRK: SPOT LDG ZONE MRK LCTD AT 6000 FT REMAINING MRK. RWY 07-25 DECEPTIVE SFC MRK EXCEED STANDARD BY APPROX 50 FT.

ALL DEPT ACFT MUST FILE FPL WITH P42 AFLD MGMT OPS.

MISC: BASE OPS OPR 1330-0600Z++, CLSD FEDERAL HOL.

CAUTION: USE EXTREME CAUTION FOR UNMANNED AERIAL SYSTEMS (UAS) OPS IN VCNTY.

MILITARY USE: ASSAULT LDG ZONE LCTD 1ST 6,000 EAST END OF TWY B. RWY 252 MRK ONLY FOR C-130 ASSAULT OPR; ONE-WAY LDG ONLY.

RSTD: OVERNIGHT PRK UNAUTHD ON C-RAMP.

TRAN ALERT (2 OF 2): UNABLE TO SVC ACFT WITH ORDNANCE. LTD GRD SUPPORT EQUIPMENT AVBL. NO POTABLE WATER SVC. NO TRAN MAINT AVBL. GND SVC UNAVBL WHEN LIGHTNING WITHIN 5 NM.

CAUTION: CONTRACTOR LEASED SITES ARE INTENDED FOR ACFT BASED THEREIN; ENTRY GATES AND APRONS MAY NOT MEET AF OBST STDS.

BIRD HAZ POTENTIAL EXISTS. MIGRATORY SEASON PHASE II 1 OCT - 31 MAR. DURG BWC MODERATE, TKOF AND LNDG PERMITTED. DURG BWC SEVERE, TKOF AND LNDG PROHIBITED.

FUEL: A++ AVBL. NO TRANS ACFT FUEL SVC AVBL. LTD FUELING AVBL; GOVT ACFT ONLY 1600-2300Z++ MON-FRI. 24 HR PN WITH AFLD MGR RQR; NO SAME DAY REQ; GAS AND GO UNAVBL. EXPECT 2+ HR DELAY FOR FUEL.

RSTD - OFFL BUS ONLY. MIL ARPT. CIVIL USE RQR USAF APVL AND DD FORM 2400/01/02. PPR RQR FOR FULL STOP LDG ONLY. CALL C661-275-9342.

SERVICE-JASU: POWER CARS UNAVBL.

DRAINAGE DITCHES PARL RWY 22 FM TWY S TO TWY U.

MISC: FLT PLANS MUST BE FILED AND ACTIVATED WITH P42 AFLD MGMT. USE FLT SVC WHEN P42 AFLD MGMT CLSD.

CAUTION: VARIOUS ACFT TEST OPS MARKINGS PAINTED IN WHITE ON TAXIWAY UNIFORM.

CAUTION: CIV ACFT MAY NOT BE GRANTED ACCESS TO KPMD CLASS D FOR PRACTICE APCH OR TRSN OVER ARPT BDRYS.

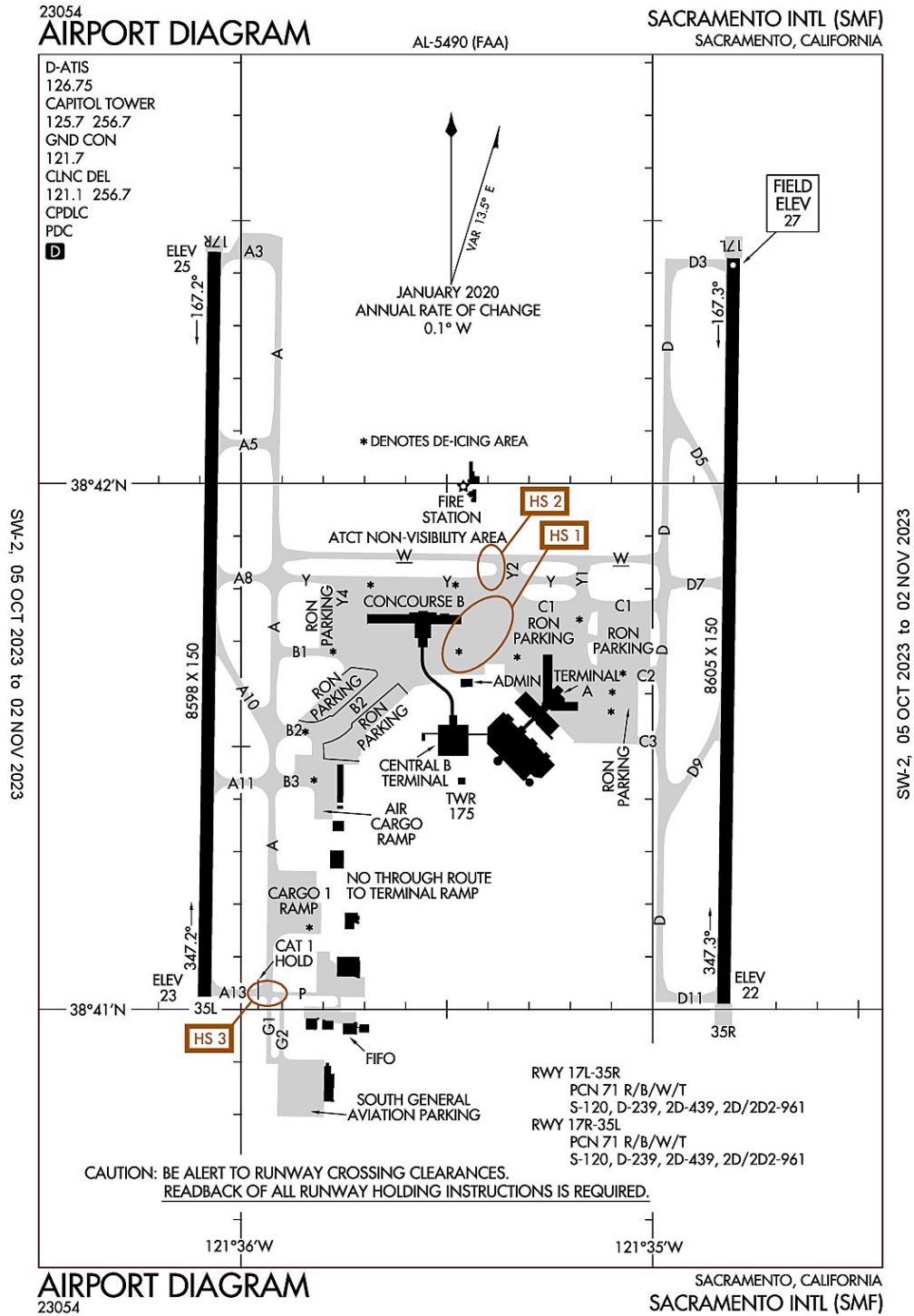
TRAN ALERT (1 OF 2): NO FLEET SVC AVBL. NO FLW ME SVC AVBL. EXP PROGRESSIVE TAXI TO PRK. AIRCREW RESPONSIBLE FOR ACFT PINNING/SAFING.

UNLGT OBSTN SURROUND AFLD.

MISC: INDUS INSTLN - NO TRNSPN, LODGING OR NML SVC AVBL ON SITE.

RSTD: TWY L BTN RWY 04/22 AND PAX TRML UNLGTD AND USABLE FOR DAYLT VFR ONLY.

### Sacramento, California Sacramento International ICAO Identifier KSMF



**Sacramento, CA**  
**Sacramento Intl**  
**ICAO Identifier KSMF**

**AD 2.2 Aerodrome geographical and administrative data**

- 2.2.1 Reference Point: 38-41-43.6N / 121-35-26.8W
- 2.2.2 From City: 10 miles NW of SACRAMENTO, CA
- 2.2.3 Elevation: 26.9 ft
- 2.2.5 Magnetic Variation: 13E (2020)
- 2.2.6 Airport Contact: SHERI THOMPSON-DUARTE  
6900 AIRPORT BLVD  
SACRAMENTO, CA 95837 ((916) 874-0560)
- 2.2.7 Traffic: IFR/VFR

**AD 2.3 Attendance Schedule**

- 2.3.1 All Months, All Days, All Hours

**AD 2.4 Handling Services and Facilities**

- 2.4.1 Cargo Handling Facilities: YES
- 2.4.2 Fuel Types: 100LL,A
- 2.4.5 Hangar Space:
- 2.4.6 Repair Facilities: MINOR

**AD 2.6 Rescue and Firefighting Services**

- 2.6.1 Aerodrome Category: Class-I certified on 5/1/1973
- 2.6.2 Rescue and Firefighting Services: ARFF Index-C

**AD 2.12 Runway Physical Characteristics**

- 2.12.1 Designation: 17L
- 2.12.2 True Bearing: 181
- 2.12.3 Dimensions: 8605 ft x 150 ft
- 2.12.4 PCN: 71 R/B/W/T
- 2.12.5 Coordinates: 38-42-25.6973N / 121-34-48.2125W
- 2.12.6 Threshold Elevation: 26.9 ft
- 2.12.6 Touchdown Zone Elevation: 26.9 ft

- 2.12.1 Designation: 35R
- 2.12.2 True Bearing: 1
- 2.12.3 Dimensions: 8605 ft x 150 ft
- 2.12.4 PCN: 71 R/B/W/T
- 2.12.5 Coordinates: 38-41-0.6506N / 121-34-49.642W
- 2.12.6 Threshold Elevation: 22.1 ft
- 2.12.6 Touchdown Zone Elevation: 23.8 ft

- 2.12.1 Designation: 17R
- 2.12.2 True Bearing: 181
- 2.12.3 Dimensions: 8598 ft x 150 ft
- 2.12.4 PCN: 71 R/B/W/T
- 2.12.5 Coordinates: 38-42-26.4236N / 121-36-3.8961W
- 2.12.6 Threshold Elevation: 24.8 ft
- 2.12.6 Touchdown Zone Elevation: 25.3 ft

- 2.12.1 Designation: 35L
- 2.12.2 True Bearing: 1
- 2.12.3 Dimensions: 8598 ft x 150 ft
- 2.12.4 PCN: 71 R/B/W/T
- 2.12.5 Coordinates: 38-41-1.439N / 121-36-5.3075W
- 2.12.6 Threshold Elevation: 22.5 ft
- 2.12.6 Touchdown Zone Elevation: 23.9 ft

**AD 2.13 Declared Distances**

- 2.13.1 Designation: 17L
- 2.13.2 Take-off Run Available: 8605
- 2.13.3 Take-off Distance Available: 8605
- 2.13.4 Accelerate-Stop Distance Available: 8605
- 2.13.5 Landing Distance Available: 8605

- 2.13.1 Designation: 35R
- 2.13.2 Take-off Run Available: 8605
- 2.13.3 Take-off Distance Available: 8605
- 2.13.4 Accelerate-Stop Distance Available: 8605
- 2.13.5 Landing Distance Available: 8605

- 2.13.1 Designation: 17R
- 2.13.2 Take-off Run Available: 8598
- 2.13.3 Take-off Distance Available: 8598
- 2.13.4 Accelerate-Stop Distance Available: 8598
- 2.13.5 Landing Distance Available: 8598

- 2.13.1 Designation: 35L
- 2.13.2 Take-off Run Available: 8598
- 2.13.3 Take-off Distance Available: 8598
- 2.13.4 Accelerate-Stop Distance Available: 8598
- 2.13.5 Landing Distance Available: 8598

**AD 2.14 Approach and Runway Lighting**

- 2.14.1 Designation: 17L
- 2.14.2 Approach Lighting System: MALSR
- 2.14.4 Visual Approach Slope Indicator System: P4L

- 2.14.1 Designation: 35R
- 2.14.2 Approach Lighting System:
- 2.14.4 Visual Approach Slope Indicator System: P4L

- 2.14.1 Designation: 17R
- 2.14.2 Approach Lighting System: ALSF2
- 2.14.4 Visual Approach Slope Indicator System: P4R

- 2.14.1 Designation: 35L
- 2.14.2 Approach Lighting System: MALSR

2.14.4 Visual Approach Slope Indicator System: P4R

**AD 2.18 Air Traffic Services Communication Facilities**

2.18.1 Service Designation: CD/P

2.18.3 Channel: 121.1

2.18.5 Hours of Operation: 24

2.18.1 Service Designation: CD/P

2.18.3 Channel: 256.7

2.18.5 Hours of Operation: 24

2.18.1 Service Designation: D-ATIS

2.18.3 Channel: 126.75

2.18.5 Hours of Operation: 24

2.18.1 Service Designation: GND/P

2.18.3 Channel: 121.7

2.18.5 Hours of Operation: 24

2.18.1 Service Designation: GND/P

2.18.3 Channel: 256.7

2.18.5 Hours of Operation: 24

2.18.1 Service Designation: LCL/P

2.18.3 Channel: 125.7

2.18.5 Hours of Operation: 24

2.18.1 Service Designation: LCL/P

2.18.3 Channel: 256.7

2.18.5 Hours of Operation: 24

**AD 2.19 Radio Navigation and Landing Aids**

2.19.1 ILS Type: DME for runway 17L. Magnetic variation: 13E

2.19.2 ILS Identification: MDK

2.19.5 Coordinates: 38-40-50.2189N / 121-34-46.3009W

2.19.6 Site Elevation: 30.9 ft

2.19.1 ILS Type: Glide Slope for runway 17L. Magnetic variation: 13E

2.19.2 ILS Identification: MDK

2.19.5 Coordinates: 38-42-15.18N / 121-34-43.22W

2.19.6 Site Elevation: 21.7 ft

2.19.1 ILS Type: Localizer for runway 17L. Magnetic variation: 13E

2.19.2 ILS Identification: MDK

2.19.5 Coordinates: 38-40-50.67N / 121-34-49.81W

2.19.6 Site Elevation: 17.4 ft

2.19.1 ILS Type: DME for runway 17R. Magnetic variation: 13E

2.19.2 ILS Identification: SMF



2.19.5 Coordinates: 38-40-34.7038N / 121-36-3.046W

2.19.6 Site Elevation: 34 ft

2.19.1 ILS Type: Glide Slope for runway 17R. Magnetic variation: 13E

2.19.2 ILS Identification: SMF

2.19.5 Coordinates: 38-42-15.8608N / 121-36-9.106W

2.19.6 Site Elevation: 22.9 ft

2.19.1 ILS Type: Inner Marker for runway 17R. Magnetic variation: 13E

2.19.2 ILS Identification: SMF

2.19.5 Coordinates: 38-42-34.0974N / 121-36-3.7746W

2.19.6 Site Elevation: 23 ft

2.19.1 ILS Type: Localizer for runway 17R. Magnetic variation: 13E

2.19.2 ILS Identification: SMF

2.19.5 Coordinates: 38-40-35.7492N / 121-36-5.7322W

2.19.6 Site Elevation: 19.6 ft

2.19.1 ILS Type: DME for runway 35L. Magnetic variation: 13E

2.19.2 ILS Identification: HUX

2.19.5 Coordinates: 38-40-34.7038N / 121-36-3.046W

2.19.6 Site Elevation: 34 ft

2.19.1 ILS Type: Glide Slope for runway 35L. Magnetic variation: 13E

2.19.2 ILS Identification: HUX

2.19.5 Coordinates: 38-41-12.5012N / 121-36-0.0807W

2.19.6 Site Elevation: 21.7 ft

2.19.1 ILS Type: Localizer for runway 35L. Magnetic variation: 13E

2.19.2 ILS Identification: HUX

2.19.5 Coordinates: 38-42-36.65N / 121-36-3.72W

2.19.6 Site Elevation: 22 ft

**General Remarks:**

WEST RAMP SPOTS 56-60 & F1 RSTRD TO TOW IN AND TOW OUT ONLY FROM TXL B2. WHEN PUSHING BACK FOR DEP FROM WEST RAMP SPOTS 56-60 & F1 EACH ACFT IS TO PUSH BACK ON TO TXL B2 AND PULL FWD TO THE "ENGINE START LINE" PRIOR TO STARTING ENGS.

CROP DUSTERS OPER INVOF ARPT AT OR BELOW 200 FT AGL.

MILITARY AIRCRAFT PARKING LIMITED. CONTACT ARPT OPNS IF PARKING IS REQUIRED (916) 806-5309.

NOISE SENSITIVE AREAS W OF ARPT ON SAC RIVER. LCL TURN DISCOURAGED FOR JET ACFT. WHEN CONDUCTING IFR APCH IN VFR CONDITIONS EXECUTE MISSED APCH AT DEP END OF RYS. PLAN VFR PATTERNS TO E. USE MIN POWER SETTINGS.

UNPAVED SFC NORTH OF TWY P AND EAST OF TWY A AND SOUTH OF CARGO 1 RAMP CLSD TO HEL.

TWY B1 CLSD TO CARGO ACFT.

PORTION OF TWY W 500 FT EAST OF TWY A TO 2100 FT EAST OF TWY A IS NOT VISIBLE FROM ATCT.

TWY Y4 RESTRICTED TO AIRCRAFT WITH A WINGSPAN OF LESS THAN 118 FT (GROUP III).

ALL ACFT CTC ATC GND CTL PRIOR TO MOVEMENT ON RAMP.

TWY RMK #2: THE MAXIMUM ALLOWABLE GROSS AIRCRAFT LOAD FOR TWYS G1, G2, AND THE GENERAL AVIATION PARKING APRON IS: 70,000 LBS FOR SINGLE GEAR AIRCRAFT; 170,000 LBS FOR DUAL GEAR AIRCRAFT; AND 250,000 LBS FOR DUAL TANDEM GEAR AIRCRAFT.

FAA GWT STRENGTH EVALUATION MD-11 = 590,000 LBS.

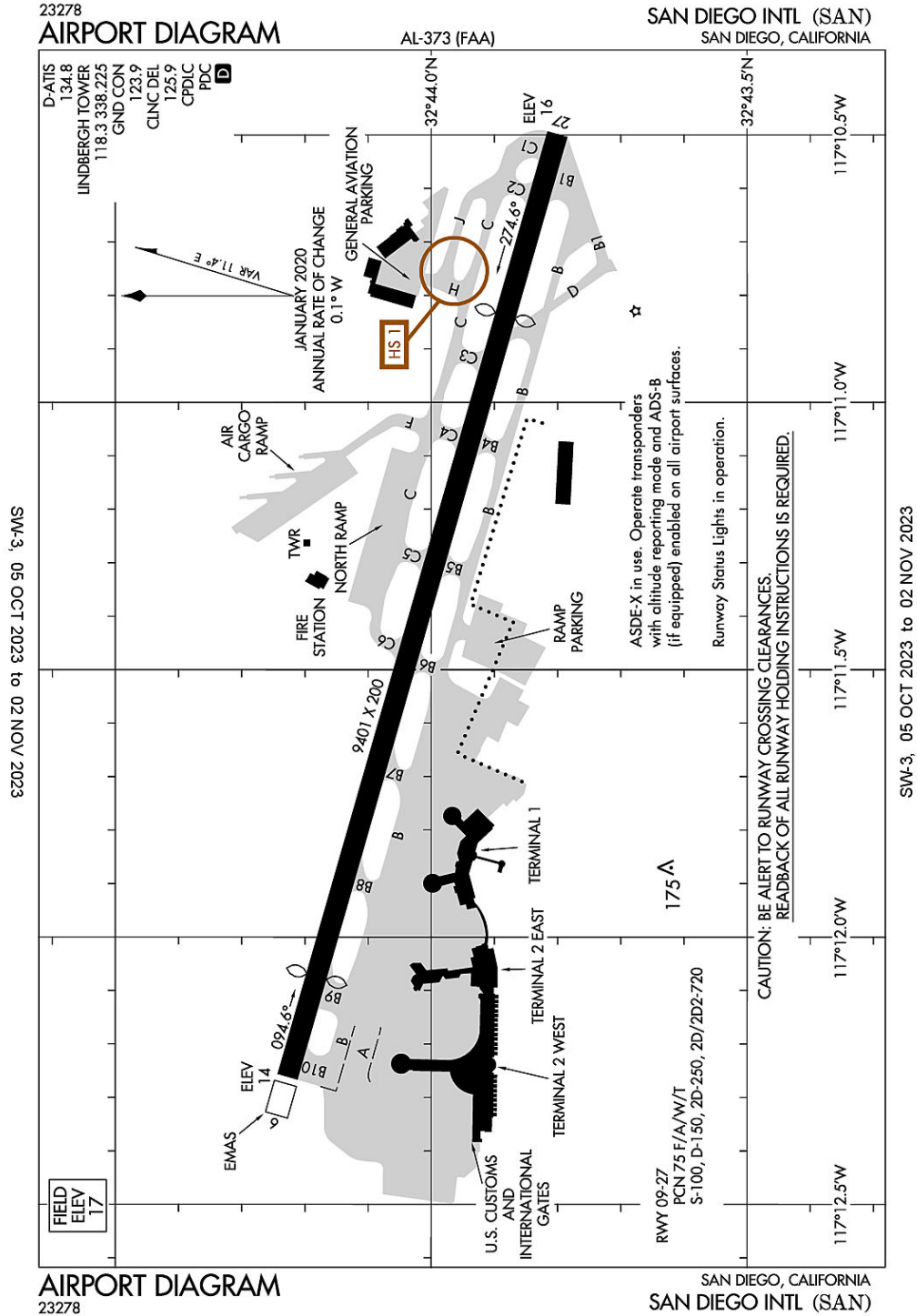
ACFT MUST PUSH BACK TAIL TO THE NORTH FROM TRML GATES A1, A3 AND A5.

GND VEHICLE SURVEILLANCE SYS IN USE. OPR TRANSPONDERS WITH ALT RPRTG MODE AND ADS-B (IF EQUIPPED) ENABLED ON ALL AP SFCS.

BIRDS ON AND IN VICINITY OF ARPT.

TWY RMK #2 CONT'D: AN AIRCRAFT CANNOT EXCEED THE AIRPLANE DESIGN GROUP III CRITERIA AND MUST HAVE A WHEEL BASE OF LESS THAN 60 FT.

**San Diego, California  
San Diego International  
ICAO Identifier KSAN**



**San Diego, CA**  
**San Diego Intl**  
**ICAO Identifier KSAN**

**AD 2.2 Aerodrome geographical and administrative data**

- 2.2.1 Reference Point: 32-44-0.826N / 117-11-22.788W
- 2.2.2 From City: 2 miles W of SAN DIEGO, CA
- 2.2.3 Elevation: 16.8 ft
- 2.2.5 Magnetic Variation: 11E (2020)
- 2.2.6 Airport Contact: DEAN ROBBINS  
3225 N HARBOR DRIVE  
SAN DIEGO, CA 92101 (619-400-2718)
- 2.2.7 Traffic: IFR/VFR

**AD 2.3 Attendance Schedule**

- 2.3.1 All Months, All Days, All Hours

**AD 2.4 Handling Services and Facilities**

- 2.4.1 Cargo Handling Facilities: YES
- 2.4.2 Fuel Types: 100LL,A
- 2.4.5 Hangar Space: YES
- 2.4.6 Repair Facilities: MINOR

**AD 2.6 Rescue and Firefighting Services**

- 2.6.1 Aerodrome Category: Class-I certified on 5/1/1973
- 2.6.2 Rescue and Firefighting Services: ARFF Index-D

**AD 2.12 Runway Physical Characteristics**

- 2.12.1 Designation: 27
- 2.12.2 True Bearing: 286
- 2.12.3 Dimensions: 9401 ft x 200 ft
- 2.12.4 PCN: 75 F/A/W/T
- 2.12.5 Coordinates: 32-43-48.0054N / 117-10-29.8979W
- 2.12.6 Threshold Elevation: 16.4 ft
- 2.12.6 Touchdown Zone Elevation: 16.8 ft

- 2.12.1 Designation: 09
- 2.12.2 True Bearing: 106
- 2.12.3 Dimensions: 9401 ft x 200 ft
- 2.12.4 PCN: 75 F/A/W/T
- 2.12.5 Coordinates: 32-44-13.6407N / 117-12-15.6832W
- 2.12.6 Threshold Elevation: 13.9 ft
- 2.12.6 Touchdown Zone Elevation: 16.7 ft

**AD 2.13 Declared Distances**

- 2.13.1 Designation: 27
- 2.13.2 Take-off Run Available: 9401
- 2.13.3 Take-off Distance Available: 9401
- 2.13.4 Accelerate-Stop Distance Available: 9401
- 2.13.5 Landing Distance Available: 7591

- 2.13.1 Designation: 09
- 2.13.2 Take-off Run Available: 8280
- 2.13.3 Take-off Distance Available: 9401
- 2.13.4 Accelerate-Stop Distance Available: 8280
- 2.13.5 Landing Distance Available: 7280

**AD 2.14 Approach and Runway Lighting**

- 2.14.1 Designation: 27
- 2.14.2 Approach Lighting System: MALS
- 2.14.4 Visual Approach Slope Indicator System: P4R

- 2.14.1 Designation: 09
- 2.14.2 Approach Lighting System: MALSR
- 2.14.4 Visual Approach Slope Indicator System: P4L

**AD 2.18 Air Traffic Services Communication Facilities**

- 2.18.1 Service Designation: CD/P
- 2.18.3 Channel: 125.9
- 2.18.5 Hours of Operation: 24

- 2.18.1 Service Designation: D-ATIS
- 2.18.3 Channel: 134.8
- 2.18.5 Hours of Operation: 24

- 2.18.1 Service Designation: GND/P
- 2.18.3 Channel: 123.9
- 2.18.5 Hours of Operation: 24

- 2.18.1 Service Designation: LCL/P
- 2.18.3 Channel: 118.3
- 2.18.5 Hours of Operation: 24

- 2.18.1 Service Designation: LCL/P
- 2.18.3 Channel: 338.225
- 2.18.5 Hours of Operation: 24

**AD 2.19 Radio Navigation and Landing Aids**

- 2.19.1 ILS Type: DME for runway 09. Magnetic variation: 11E
- 2.19.2 ILS Identification: SAN
- 2.19.5 Coordinates: 32-43-46.8256N / 117-10-28.5519W
- 2.19.6 Site Elevation: 34 ft

- 2.19.1 ILS Type: Glide Slope for runway 09. Magnetic variation: 11E
- 2.19.2 ILS Identification: SAN
- 2.19.5 Coordinates: 32-44-10.7741N / 117-11-52.1594W
- 2.19.6 Site Elevation: 13.1 ft

2.19.1 ILS Type: Localizer for runway 09. Magnetic variation: 11E  
2.19.2 ILS Identification: SAN  
2.19.5 Coordinates: 32-43-47.605N / 117-10-28.2382W  
2.19.6 Site Elevation: 26.4 ft

2.19.1 ILS Type: DME for runway 27. Magnetic variation: 11E  
2.19.2 ILS Identification: UBR  
2.19.5 Coordinates: 32-44-11.4186N / 117-12-19.9319W  
2.19.6 Site Elevation: 25.9 ft

2.19.1 ILS Type: Localizer for runway 27. Magnetic variation: 11E  
2.19.2 ILS Identification: UBR  
2.19.5 Coordinates: 32-44-14.7918N / 117-12-20.4335W  
2.19.6 Site Elevation: 10.9 ft

**General Remarks:**

CROSS-BLEED ENGINE STARTS PERMITTED ONLY ON PARALLEL TWY WITH ACFT ALIGNED ON TWY CNTRLN.

RWY STATUS LGTS IN OPN.

DEP CURFEW IN EFCT. DEPS PROHIBITED 2330-0630. SGFNT FINES. MED FLTS EXEMPT WITH FORM. NOISE OFC 619-400-2660.

747 AND LARGER ACFT ARE PROHIBITED FM MAKING INTERSECTION TKOFS.

INTERMITTENT PRESENCE OF BIRDS ON AND INVOF OF ARPT.

ACFT WITH WINGSPANS GTR THAN 171 FT (52M) RSTD FROM USING TWY D SOUTH OF TWY B, AND WHEN EXITING RWY 09 WB ON TWY B.

DUE TO PAEW ON RY 09-27, 30 MINUTE PPR 0830-1230Z FOR ALL LANDINGS AND DEPARTURES CALL 619-400-2710.

IN THE EVENT OF A DIVERSION OR IRREGULAR OPERATIONS EVENTS, ACFT OPERATORS CONTACT THE APT DUTY MGR (619) 400-2710 FOR PPR DUE TO LIMITATIONS ASSOCIATED WITH HANDLING DIVERTED FLTS. LIMITATIONS INCLUDE RESTRICTED GATE SPACE, CUSTOMS SERVICES AS WELL AS ACFT SERVICING & PARKING.

MILITARY ACFT ON OFFICIAL BUSINESS ONLY CONTACT ARPT OPS AT 619-400-2710 FOR PPR.

TERRAIN & BLDGS TO 500' MSL N & E WITHIN 1 1/2 MI.

ASDE-X IN USE. OPERATE TRANSPONDERS WITH ALTITUDE REPORTING MODE AND ADS-B (IF EQUIPPED) ENABLED ON ALL AIRPORT SURFACES.

PILOTS REQUIRED TO CTC ATCT GROUND CONTROLLER PRIOR TO PUSHBACK, TOW OUT AND TAXI FOR TRAFFIC ADVISORIES.

30 MIN PPR (619-400-2710) FOR ACFT WITH OVER 171 FT WINGSPAN.

ACFT CROSSING RY 09/27 ON TWY C6, HOLD SHORT OF TWY C6 FACING WEST ON TWY C, PARALLEL TO RY.

ULTRALIGHT ACFT PROHIBITED ON AP.

TAXIING ACFT ARE PROHIBITED FROM PASSING TO THE SOUTH OF ACFT LCTD ON TWY B INTO ALLEY LCTD BTWN GATES 7 AND 14.

TAXILANE A RSTRD TO ACFT WITH WINGSPANS OF 135 FT OR LESS.

TWY C EDGE LGTS OTS INDEFLY.

OUTBOARD ENGINES OF FOUR-ENGINE ACFT ARE TO BE KEPT AT IDLE POWER FOR ALL GND MANEUVERING.

TAXIING ACFT SHALL FOLLOW LEAD-IN LINES UNTIL THE NOSE WHEEL OF THE ACFT HAS ENTERED THE NON-MOVEMENT AREA OF THE ALLEY.

TO REDUCE JET BLAST IMPACT AT N END OF TWY F ACFT WILL NOT START ENG UNTIL 800 FT FM N END OF TWY F; ABEAM THE SECOND PARKING PAD.

PRACTICE APPROACHES AND TGL PROHIBITED.

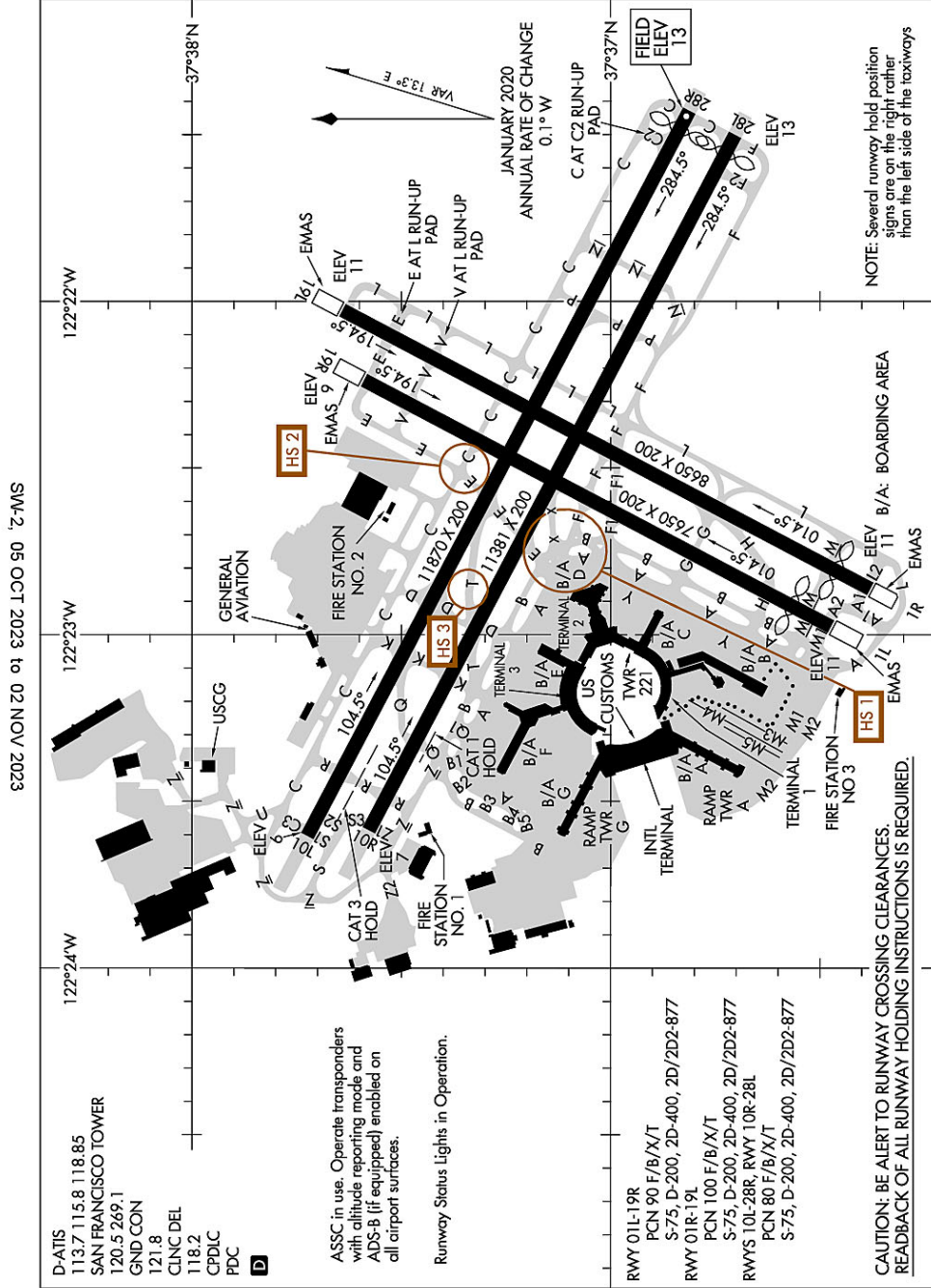
FOR ACCESS TO/FR TERMINAL 2: GATES 23, 25, 27, 29, 31, 33-51 AND THE ISLAND AND WEST RON PRKG RAMPS, CTC RAMP CTL ON 129.775 SRY 131.975 FR 0600-2400. FR 0000-0600 CTC GROUND CTL ON 123.9.

**San Francisco, California**  
**San Francisco International**  
**ICAO Identifier KSFO**

21224  
**AIRPORT DIAGRAM**

**SAN FRANCISCO INTL (SFO)**  
SAN FRANCISCO, CALIFORNIA

AL-375 (FAA)



SW-2, 05 OCT 2023 to 02 NOV 2023

SW-2, 05 OCT 2023 to 02 NOV 2023

**AIRPORT DIAGRAM**  
21224

**SAN FRANCISCO, CALIFORNIA**  
**SAN FRANCISCO INTL (SFO)**



**San Francisco, CA**  
**San Francisco Intl**  
**ICAO Identifier KSFO**

**AD 2.2 Aerodrome geographical and administrative data**

- 2.2.1 Reference Point: 37-37-7.7N / 122-22-31.5W
- 2.2.2 From City: 8 miles SE of SAN FRANCISCO, CA
- 2.2.3 Elevation: 13.1 ft
- 2.2.5 Magnetic Variation: 14E (2015)
- 2.2.6 Airport Contact: IVAR SATERO  
PO BOX 8097  
SAN FRANCISCO, CA 94128 ((650) 821-3355)
- 2.2.7 Traffic: IFR/VFR

**AD 2.3 Attendance Schedule**

- 2.3.1 All Months, All Days, All Hours

**AD 2.4 Handling Services and Facilities**

- 2.4.1 Cargo Handling Facilities: YES
- 2.4.2 Fuel Types: 100LL,A,A++
- 2.4.5 Hangar Space: YES
- 2.4.6 Repair Facilities: NONE

**AD 2.6 Rescue and Firefighting Services**

- 2.6.1 Aerodrome Category: Class-I certified on 5/1/1973
- 2.6.2 Rescue and Firefighting Services: ARFF Index-E

**AD 2.12 Runway Physical Characteristics**

- 2.12.1 Designation: 01L
- 2.12.2 True Bearing: 28
- 2.12.3 Dimensions: 7650 ft x 200 ft
- 2.12.4 PCN: 90 F/B/X/T
- 2.12.5 Coordinates: 37-36-28.4323N / 122-22-58.5426W
- 2.12.6 Threshold Elevation: 10.7 ft
- 2.12.6 Touchdown Zone Elevation: 10.9 ft

- 2.12.1 Designation: 19R
- 2.12.2 True Bearing: 208
- 2.12.3 Dimensions: 7650 ft x 200 ft
- 2.12.4 PCN: 90 F/B/X/T
- 2.12.5 Coordinates: 37-37-35.3329N / 122-22-14.1939W
- 2.12.6 Threshold Elevation: 9.2 ft
- 2.12.6 Touchdown Zone Elevation: 11.2 ft

- 2.12.1 Designation: 01R
- 2.12.2 True Bearing: 28
- 2.12.3 Dimensions: 8650 ft x 200 ft
- 2.12.4 PCN: 100 F/B/X/T
- 2.12.5 Coordinates: 37-36-22.7876N / 122-22-51.7467W
- 2.12.6 Threshold Elevation: 11.4 ft
- 2.12.6 Touchdown Zone Elevation: 11.2 ft

2.12.1 Designation: 19L  
2.12.2 True Bearing: 208  
2.12.3 Dimensions: 8650 ft x 200 ft  
2.12.4 PCN: 100 F/B/X/T  
2.12.5 Coordinates: 37-37-38.4319N / 122-22-1.599W  
2.12.6 Threshold Elevation: 10.5 ft  
2.12.6 Touchdown Zone Elevation: 11 ft

2.12.1 Designation: 10L  
2.12.2 True Bearing: 118  
2.12.3 Dimensions: 11870 ft x 200 ft  
2.12.4 PCN: 80 F/B/X/T  
2.12.5 Coordinates: 37-37-43.4594N / 122-23-36.2107W  
2.12.6 Threshold Elevation: 5.5 ft  
2.12.6 Touchdown Zone Elevation: 7 ft

2.12.1 Designation: 28R  
2.12.2 True Bearing: 298  
2.12.3 Dimensions: 11870 ft x 200 ft  
2.12.4 PCN: 80 F/B/X/T  
2.12.5 Coordinates: 37-36-48.721N / 122-21-25.708W  
2.12.6 Threshold Elevation: 13 ft  
2.12.6 Touchdown Zone Elevation: 12.9 ft

2.12.1 Designation: 10R  
2.12.2 True Bearing: 118  
2.12.3 Dimensions: 11381 ft x 200 ft  
2.12.4 PCN: 80 F/B/X/T  
2.12.5 Coordinates: 37-37-34.648N / 122-23-35.1796W  
2.12.6 Threshold Elevation: 7.1 ft  
2.12.6 Touchdown Zone Elevation: 8 ft

2.12.1 Designation: 28L  
2.12.2 True Bearing: 298  
2.12.3 Dimensions: 11381 ft x 200 ft  
2.12.4 PCN: 80 F/B/X/T  
2.12.5 Coordinates: 37-36-42.163N / 122-21-30.057W  
2.12.6 Threshold Elevation: 12.6 ft  
2.12.6 Touchdown Zone Elevation: 12.6 ft

#### **AD 2.13 Declared Distances**

2.13.1 Designation: 01L  
2.13.2 Take-off Run Available: 7650  
2.13.3 Take-off Distance Available: 7650  
2.13.4 Accelerate-Stop Distance Available: 7650  
2.13.5 Landing Distance Available: 7010

2.13.1 Designation: 19R  
2.13.2 Take-off Run Available: 7650

2.13.3 Take-off Distance Available: 7650  
2.13.4 Accelerate-Stop Distance Available: 7650  
2.13.5 Landing Distance Available: 7650

2.13.1 Designation: 01R  
2.13.2 Take-off Run Available: 8650  
2.13.3 Take-off Distance Available: 8650  
2.13.4 Accelerate-Stop Distance Available: 8650  
2.13.5 Landing Distance Available: 8090

2.13.1 Designation: 19L  
2.13.2 Take-off Run Available: 8650  
2.13.3 Take-off Distance Available: 8650  
2.13.4 Accelerate-Stop Distance Available: 8650  
2.13.5 Landing Distance Available: 8650

2.13.1 Designation: 10L  
2.13.2 Take-off Run Available: 11870  
2.13.3 Take-off Distance Available: 11870  
2.13.4 Accelerate-Stop Distance Available: 11193  
2.13.5 Landing Distance Available: 11193

2.13.1 Designation: 28R  
2.13.2 Take-off Run Available: 11870  
2.13.3 Take-off Distance Available: 11870  
2.13.4 Accelerate-Stop Distance Available: 11870  
2.13.5 Landing Distance Available: 11236

2.13.1 Designation: 10R  
2.13.2 Take-off Run Available: 11381  
2.13.3 Take-off Distance Available: 11381  
2.13.4 Accelerate-Stop Distance Available: 10704  
2.13.5 Landing Distance Available: 10704

2.13.1 Designation: 28L  
2.13.2 Take-off Run Available: 11381  
2.13.3 Take-off Distance Available: 11381  
2.13.4 Accelerate-Stop Distance Available: 10981  
2.13.5 Landing Distance Available: 10275

**AD 2.14 Approach and Runway Lighting**

2.14.1 Designation: 01L  
2.14.2 Approach Lighting System:  
2.14.4 Visual Approach Slope Indicator System:

2.14.1 Designation: 19R  
2.14.2 Approach Lighting System:  
2.14.4 Visual Approach Slope Indicator System: P4L

2.14.1 Designation: 01R

2.14.2 Approach Lighting System:  
2.14.4 Visual Approach Slope Indicator System:

2.14.1 Designation: 19L  
2.14.2 Approach Lighting System: MALSF  
2.14.4 Visual Approach Slope Indicator System: P4L

2.14.1 Designation: 10L  
2.14.2 Approach Lighting System:  
2.14.4 Visual Approach Slope Indicator System: P4L

2.14.1 Designation: 28R  
2.14.2 Approach Lighting System: ALSF2  
2.14.4 Visual Approach Slope Indicator System: P4L

2.14.1 Designation: 10R  
2.14.2 Approach Lighting System:  
2.14.4 Visual Approach Slope Indicator System: P4L

2.14.1 Designation: 28L  
2.14.2 Approach Lighting System: MALSR  
2.14.4 Visual Approach Slope Indicator System: P4L

**AD 2.18 Air Traffic Services Communication Facilities**

2.18.1 Service Designation: CD PRE TAXI CLNC  
2.18.3 Channel: 118.2  
2.18.5 Hours of Operation: 24

2.18.1 Service Designation: D-ATIS  
2.18.3 Channel: 113.7  
2.18.5 Hours of Operation: 24

2.18.1 Service Designation: D-ATIS  
2.18.3 Channel: 115.8  
2.18.5 Hours of Operation: 24

2.18.1 Service Designation: D-ATIS  
2.18.3 Channel: 118.85  
2.18.5 Hours of Operation: 24

2.18.1 Service Designation: EMERG  
2.18.3 Channel: 121.5  
2.18.5 Hours of Operation:

2.18.1 Service Designation: GND/P  
2.18.3 Channel: 121.8  
2.18.5 Hours of Operation: 24

2.18.1 Service Designation: LCL/P  
2.18.3 Channel: 120.5

2.18.5 Hours of Operation: 24

2.18.1 Service Designation: LCL/P

2.18.3 Channel: 269.1

2.18.5 Hours of Operation: 24

**AD 2.19 Radio Navigation and Landing Aids**

2.19.1 ILS Type: DME for runway 19L. Magnetic variation: 14E

2.19.2 ILS Identification: SIA

2.19.5 Coordinates: 37-36-18.7188N / 122-22-59.4082W

2.19.6 Site Elevation: 20.6 ft

2.19.1 ILS Type: Glide Slope for runway 19L. Magnetic variation: 14E

2.19.2 ILS Identification: SIA

2.19.5 Coordinates: 37-37-30.7381N / 122-22-11.0577W

2.19.6 Site Elevation: 6.3 ft

2.19.1 ILS Type: Localizer for runway 19L. Magnetic variation: 14E

2.19.2 ILS Identification: SIA

2.19.5 Coordinates: 37-36-16.2796N / 122-22-56.0614W

2.19.6 Site Elevation: 19 ft

2.19.1 ILS Type: DME for runway 28R. Magnetic variation: 14E

2.19.2 ILS Identification: GWQ

2.19.5 Coordinates: 37-37-48.1978N / 122-23-40.6085W

2.19.6 Site Elevation: 17.7 ft

2.19.1 ILS Type: Glide Slope for runway 28R. Magnetic variation: 14E

2.19.2 ILS Identification: GWQ

2.19.5 Coordinates: 37-36-51.3989N / 122-21-43.1171W

2.19.6 Site Elevation: 8.2 ft

2.19.1 ILS Type: Localizer for runway 28R. Magnetic variation: 14E

2.19.2 ILS Identification: GWQ

2.19.5 Coordinates: 37-37-46.3566N / 122-23-43.1194W

2.19.6 Site Elevation: 5.3 ft

2.19.1 ILS Type: DME for runway 28L. Magnetic variation: 14E

2.19.2 ILS Identification: SFO

2.19.5 Coordinates: 37-37-39.5363N / 122-23-41.4575W

2.19.6 Site Elevation: 20.3 ft

2.19.1 ILS Type: Glide Slope for runway 28L. Magnetic variation: 14E

2.19.2 ILS Identification: SFO

2.19.5 Coordinates: 37-36-51.2769N / 122-21-43.1999W

2.19.6 Site Elevation: 8.2 ft

2.19.1 ILS Type: Localizer for runway 28L. Magnetic variation: 14E

2.19.2 ILS Identification: SFO

2.19.5 Coordinates: 37-37-37.471N / 122-23-41.9198W

2.19.6 Site Elevation: 9.3 ft

2.19.1 Navigation Aid Type: VOR/DME. Magnetic variation: 17E

2.19.2 Navigation Aid Identification: SFO

2.19.5 Coordinates: 37-37-10.1465N / 122-22-26.0165W

2.19.6 Site Elevation: 6 ft

**General Remarks:**

SEVERAL RY HOLD POSITION SIGNS ARE ON THE RIGHT RATHER THAN THE LEFT SIDE OF THE TWYS.

NOISE SENSITIVE ARPT; FOR NOISE ABATEMENT PROCEDURES CTC ARPT NOISE OFFICE MON-FRI 0800-1700 BY CALLING 650-821-5100.

RWY STATUS LGTS IN OPN.

PAEW APCH END RYS 28L, 28R, 19L INDEFINITE.

TWY S BTN TWY Z AND TWY S2 CLSD TO ACFT WITH WINGSPAN OVER 215 FT.

ALL OUBD TWY ZULU 2 HVY ACFT WITH A WINGSPAN OF 171 FT OR GTR UNDER PWR PROHIBITED FROM ENTERING WB TWY ZULU.

RWY 1L CLSD TO DEPARTING TRIJET ACFT WITH WINGSPAN GREATER THAN 155 FT.

AIRLINE PILOTS SHALL STRICTLY FOLLOW THE PAINTED NOSE GEAR LINES AND NO OVERSTEERING ADJUSTMENT IS PERMITTED.

ASSC IN USE. OPERATE TRANSPONDERS WITH ALTITUDE REPORTING MODE AND ADS-B (IF EQUIPPED) ENABLED ON ALL AIRPORT SURFACES.

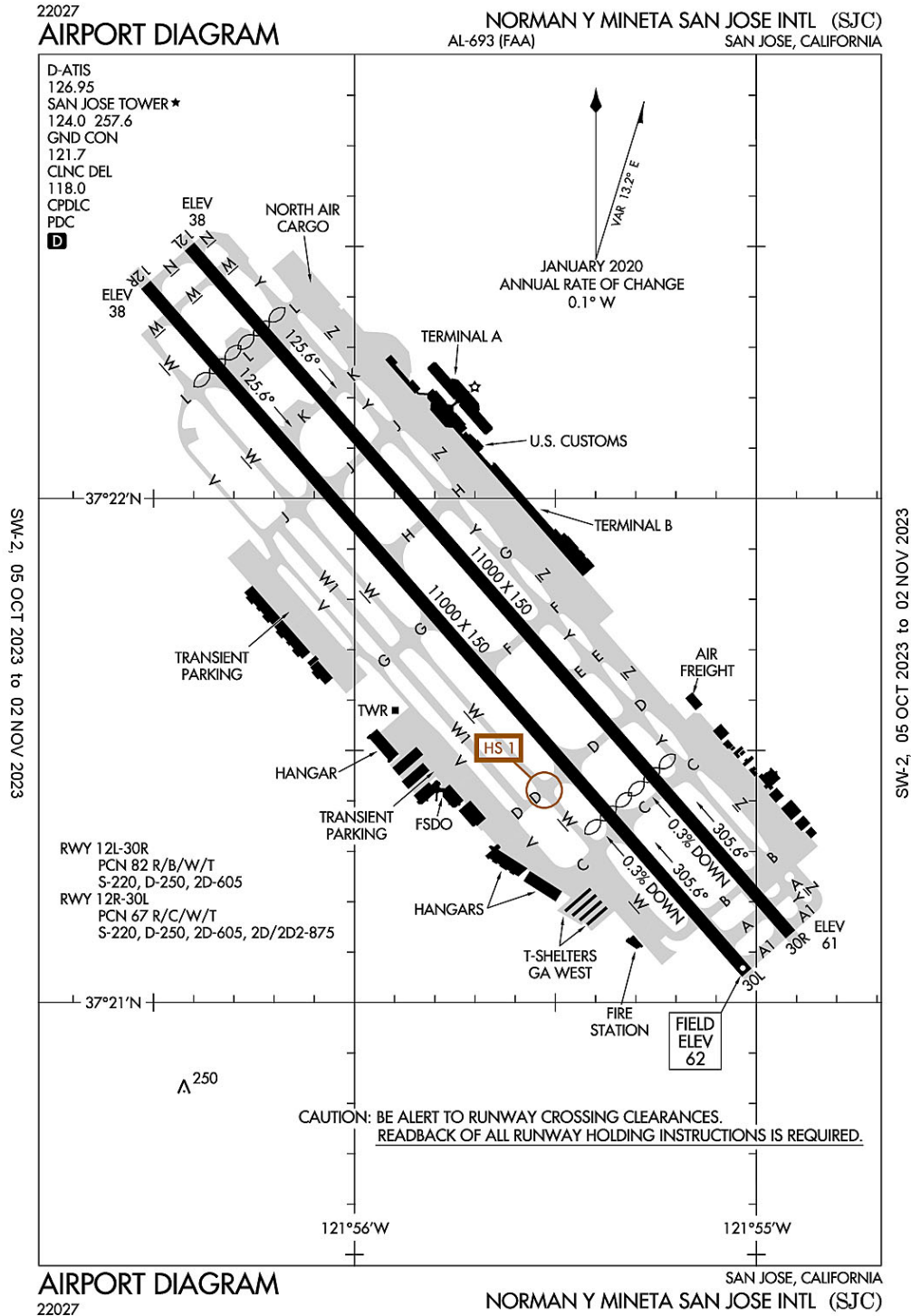
FLOCKS OF BIRDS FEEDING ALONG SHORELINE ADJ TO ARPT; ON OCCASIONS FLY ACROSS VARIOUS PARTS OF THE ARPT.

HIGH SPEED TWY (T) GRVD FULL WIDTH BTN RWY 28R AND 28L.

RY 10 PREFERRED RY BTWN 0100-0600 WEATHER AND FLIGHT CONDITIONS PERMITTING.

SIMULTANEOUS OPERATIONS IN EFFECT ALL RYS.

### San Jose, California Norman Y. Mineta San Jose International ICAO Identifier KSJC



**San Jose, CA**  
**Norman Y. Mineta San Jose Intl**  
**ICAO Identifier KSJC**

**AD 2.2 Aerodrome geographical and administrative data**

- 2.2.1 Reference Point: 37-21-46.781N / 121-55-43.034W
- 2.2.2 From City: 2 miles NW of SAN JOSE, CA
- 2.2.3 Elevation: 62.2 ft
- 2.2.5 Magnetic Variation: 13E (2020)
- 2.2.6 Airport Contact: JOHN AITKEN  
1701 AIRPORT BLVD., SUITE B-1130  
SAN JOSE, CA 95110 ((408) 277-5100)
- 2.2.7 Traffic: IFR/VFR

**AD 2.3 Attendance Schedule**

- 2.3.1 All Months, All Days, All Hours

**AD 2.4 Handling Services and Facilities**

- 2.4.1 Cargo Handling Facilities: YES
- 2.4.2 Fuel Types: 100LL,A
- 2.4.5 Hangar Space: YES
- 2.4.6 Repair Facilities: MAJOR

**AD 2.6 Rescue and Firefighting Services**

- 2.6.1 Aerodrome Category: Class-I certified on 5/1/1973
- 2.6.2 Rescue and Firefighting Services: ARFF Index-D

**AD 2.12 Runway Physical Characteristics**

- 2.12.1 Designation: 12L
- 2.12.2 True Bearing: 139
- 2.12.3 Dimensions: 11000 ft x 150 ft
- 2.12.4 PCN: 82 R/B/W/T
- 2.12.5 Coordinates: 37-22-29.9801N / 121-56-24.6377W
- 2.12.6 Threshold Elevation: 37.7 ft
- 2.12.6 Touchdown Zone Elevation: 43.8 ft

- 2.12.1 Designation: 30R
- 2.12.2 True Bearing: 319
- 2.12.3 Dimensions: 11000 ft x 150 ft
- 2.12.4 PCN: 82 R/B/W/T
- 2.12.5 Coordinates: 37-21-8.1324N / 121-54-54.9212W
- 2.12.6 Threshold Elevation: 61.1 ft
- 2.12.6 Touchdown Zone Elevation: 55.2 ft

- 2.12.1 Designation: 12R
- 2.12.2 True Bearing: 139
- 2.12.3 Dimensions: 11000 ft x 150 ft
- 2.12.4 PCN: 67 R/C/W/T
- 2.12.5 Coordinates: 37-22-25.4266N / 121-56-31.1597W
- 2.12.6 Threshold Elevation: 38.2 ft
- 2.12.6 Touchdown Zone Elevation: 45.6 ft



- 2.12.1 Designation: 30L
- 2.12.2 True Bearing: 319
- 2.12.3 Dimensions: 11000 ft x 150 ft
- 2.12.4 PCN: 67 R/C/W/T
- 2.12.5 Coordinates: 37-21-3.5766N / 121-55-1.4432W
- 2.12.6 Threshold Elevation: 62.1 ft
- 2.12.6 Touchdown Zone Elevation: 57 ft

#### **AD 2.13 Declared Distances**

- 2.13.1 Designation: 12L
- 2.13.2 Take-off Run Available: 10139
- 2.13.3 Take-off Distance Available: 11000
- 2.13.4 Accelerate-Stop Distance Available: 10139
- 2.13.5 Landing Distance Available: 8831

- 2.13.1 Designation: 30R
- 2.13.2 Take-off Run Available: 10134
- 2.13.3 Take-off Distance Available: 11000
- 2.13.4 Accelerate-Stop Distance Available: 10134
- 2.13.5 Landing Distance Available: 7597

- 2.13.1 Designation: 12R
- 2.13.2 Take-off Run Available: 9883
- 2.13.3 Take-off Distance Available: 11000
- 2.13.4 Accelerate-Stop Distance Available: 9883
- 2.13.5 Landing Distance Available: 8587

- 2.13.1 Designation: 30L
- 2.13.2 Take-off Run Available: 10152
- 2.13.3 Take-off Distance Available: 11000
- 2.13.4 Accelerate-Stop Distance Available: 10152
- 2.13.5 Landing Distance Available: 7614

#### **AD 2.14 Approach and Runway Lighting**

- 2.14.1 Designation: 12L
- 2.14.2 Approach Lighting System:
- 2.14.4 Visual Approach Slope Indicator System: P4R

- 2.14.1 Designation: 30R
- 2.14.2 Approach Lighting System:
- 2.14.4 Visual Approach Slope Indicator System: P4L

- 2.14.1 Designation: 12R
- 2.14.2 Approach Lighting System: MALSR
- 2.14.4 Visual Approach Slope Indicator System: P4R

- 2.14.1 Designation: 30L
- 2.14.2 Approach Lighting System: MALSR

2.14.4 Visual Approach Slope Indicator System: P4L

**AD 2.18 Air Traffic Services Communication Facilities**

2.18.1 Service Designation: CD PRE TAXI CLNC

2.18.3 Channel: 118

2.18.5 Hours of Operation: 0600-0000

2.18.1 Service Designation: D-ATIS

2.18.3 Channel: 126.95

2.18.5 Hours of Operation: 24

2.18.1 Service Designation: GND/P

2.18.3 Channel: 121.7

2.18.5 Hours of Operation: 0600-0000

2.18.1 Service Designation: LCL/P

2.18.3 Channel: 124

2.18.5 Hours of Operation: 0600-0000

2.18.1 Service Designation: LCL/P IC

2.18.3 Channel: 257.6

2.18.5 Hours of Operation: 0600-0000

**AD 2.19 Radio Navigation and Landing Aids**

2.19.1 ILS Type: DME for runway 12R. Magnetic variation: 13E

2.19.2 ILS Identification: SLV

2.19.5 Coordinates: 37-21-2.6639N / 121-55-1.3459W

2.19.6 Site Elevation: 81.4 ft

2.19.1 ILS Type: Glide Slope for runway 12R. Magnetic variation: 13E

2.19.2 ILS Identification: SLV

2.19.5 Coordinates: 37-22-6.0334N / 121-56-14.5901W

2.19.6 Site Elevation: 36.8 ft

2.19.1 ILS Type: Localizer for runway 12R. Magnetic variation: 13E

2.19.2 ILS Identification: SLV

2.19.5 Coordinates: 37-21-3.0434N / 121-55-0.8585W

2.19.6 Site Elevation: 75.1 ft

2.19.1 ILS Type: DME for runway 30L. Magnetic variation: 13E

2.19.2 ILS Identification: SJC

2.19.5 Coordinates: 37-22-27.575N / 121-56-32.6145W

2.19.6 Site Elevation: 56 ft

2.19.1 ILS Type: Glide Slope for runway 30L. Magnetic variation: 13E

2.19.2 ILS Identification: SJC

2.19.5 Coordinates: 37-21-33.0094N / 121-55-27.8798W

2.19.6 Site Elevation: 48.6 ft

2.19.1 ILS Type: Localizer for runway 30L. Magnetic variation: 13E  
2.19.2 ILS Identification: SJC  
2.19.5 Coordinates: 37-22-27.1917N / 121-56-33.1047W  
2.19.6 Site Elevation: 49.6 ft

2.19.1 Navigation Aid Type: VOR/DME. Magnetic variation: 16E  
2.19.2 Navigation Aid Identification: SJC  
2.19.5 Coordinates: 37-22-28.9638N / 121-56-40.8069W  
2.19.6 Site Elevation: 34.5 ft

**General Remarks:**

UNSCHEDULED OPNS BY GROUP 5 ACFT (B747) AND LARGER NOT AUTH EXCEPT WITH PRIOR ARPT APPROVAL CTC AMGR (408) 392-3500.

CURFEW HRS 2300-0700 FAR 36 STAGE II, 2330-0630 FAR 36 STAGE III ACFT LISTED ON THE SCHEDULE OF AUTHORIZED AIRCRAFT ISSUED BY THE DIRECTOR OF AVIATION. DELAYED SCHEDULED FLIGHTS, AND ALTERNATE/EMERGENCY OPERATIONS MAY BE EXEMPT FROM CURFEW HOUR RESTRICTIONS.

PRIOR AIRPORT NOTIFICATION IS REQUIRED FOR ALL LATE/EARLY ARRIVALS. CONTACT MANAGER ON DUTY AT (408) 392-3500.

FIRST 400 FT RY 30R & RY 30L CLSD FOR TKOF DC10, MD11, L1011.

TWY V LTD TO ACFT WITH WINGSPAN OF LESS THAN 118 FT (B-737-900 OR SMALLER).

TWY W BETWEEN TWY J AND TWY L CAN SUPPORT GROUP IV ACFT.

RRP RQRD FM FBO FOR TSNT HEL OPS.

FOR CD WHEN ATCT IS CLSD CTC NORCAL APCH AT 916-361-3748.

TWY Y WILL BE PERIODICALLY RSTRD TO ACFT WITH A WINGSPAN OF LESS THAN 171 FT (MD-11 OR SMALLER) DRG B-787 AND B-747 OPNS ON RWY 12L/30R.

TWY D BETWEEN TWY W AND TWY V LIMITED TO ACFT WITH A WINGSPAN OF LESS THAN 118 FT (B-737-900 OR SMALLER).

TWY Z WILL BE PERIODICALLY RSTRD TO ACFT WITH A WINGSPAN OF LESS THAN 118 FT (B-737-900 OR SMALLER) DRG B-787 AND B-747 OPNS. TWY Z BTN 200 FT NW OF TWY H AND 200 FT NW OF TWY K LTD TO ACFT WITH WINGSPAN OF LESS THAN 135 FT (B-757-300 OR SMALLER).

HIGH INTENSITY LIGHT ACTIVITY: HIGH INTENSITY LIGHTS (LASERS AND LARGE MEDIA SCREENS) MAY BE VISIBLE TO ARR AND DEP ACFT TO SAN JOSE INTERNATIONAL AIRPORT DURING EVENTS AT THE LEVI STADIUM COMPLEX (37-24-15N/121-58-14W, SJC VORTAC R-303/2.1 DME). FLIGHT CREWS SHOULD USE CAUTION WHEN OPERATING IN THIS AREA DURING STADIUM EVENTS. COCKPIT ILLUMINATION AND GLARE EFFECT REDUCING VIS MAY BE INTENSIFIED DURING ARR AND DEP OPS ESPECIALLY AT NIGHT.

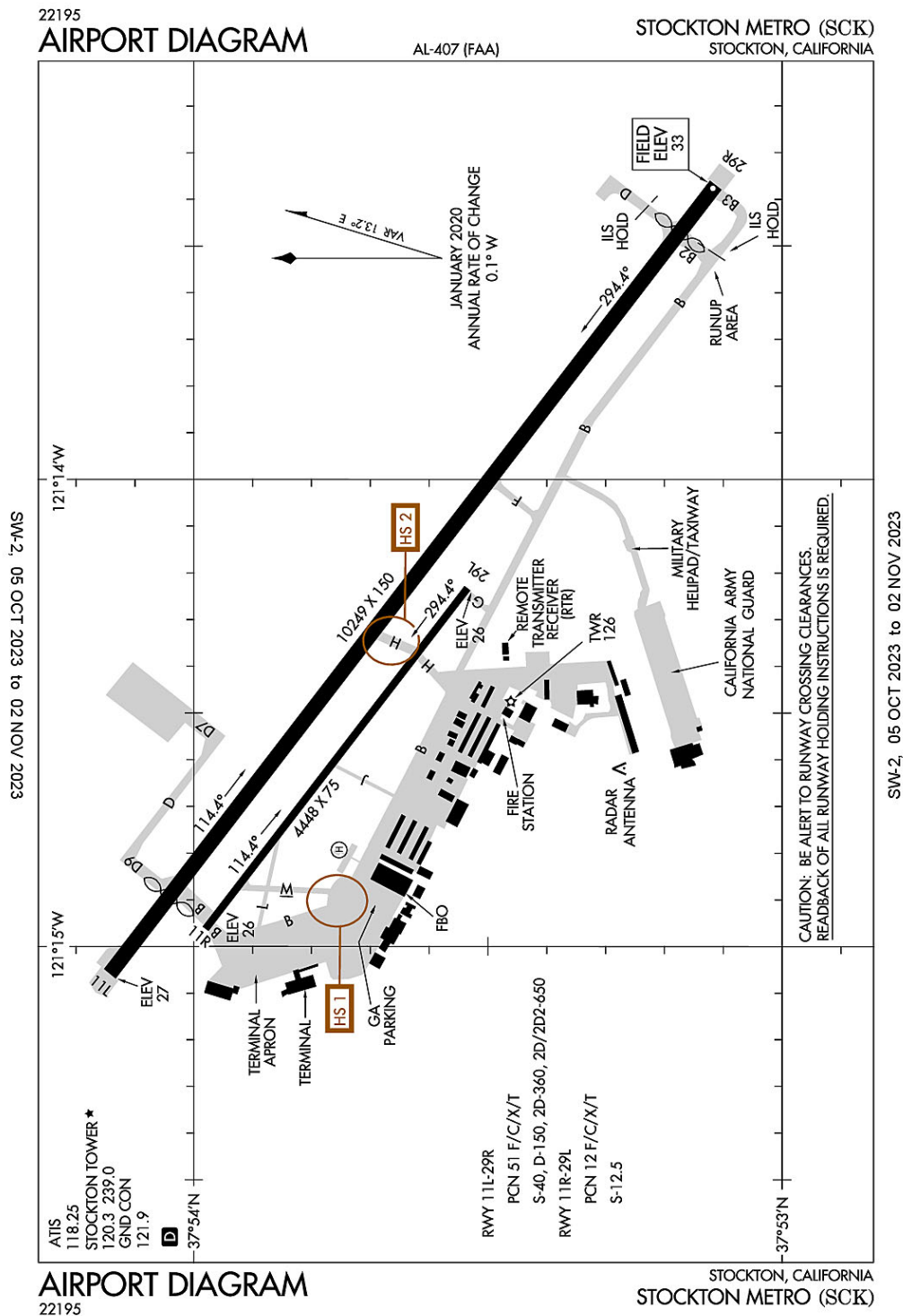
BIRDS FREQUENTLY ON OR IN VICINITY OF AIRPORT.

ALL TURBINE ENGINE RUN-UPS REQUIRE PRIOR AIRPORT APPROVAL, CONTACT MGR ON DUTY (408) 392-3500.

NOISE ABATEMENT PROCEDURE: RY 30L/12R IS PREFERRED ARRIVAL RY FOR JET ACFT AND RY 12L/30R

IS THE PREFERRED DEPARTURE FOR JET AIRCRAFT. ALL JET AIRCRAFT TAKEOFFS ARE TO BE INITIATED FROM THE EAST END UNLESS DIRECTED OTHERWISE BY ATIS.

**Stockton, California  
Stockton Metropolitan  
ICAO Identifier KSKK**



**Stockton, CA**  
**Stockton Metropolitan**  
**ICAO Identifier KSCK**

**AD 2.2 Aerodrome geographical and administrative data**

- 2.2.1 Reference Point: 37-53-39.877N / 121-14-19.464W
- 2.2.2 From City: 3 miles SE of STOCKTON, CA
- 2.2.3 Elevation: 33.2 ft
- 2.2.5 Magnetic Variation: 14E (2010)
- 2.2.6 Airport Contact: RICHARD SOKOL  
5000 S. AIRPORT WAY ROOM 202  
STOCKTON, CA 95206 (209-468-4700)
- 2.2.7 Traffic: IFR/VFR

**AD 2.3 Attendance Schedule**

- 2.3.1 All Months, All Days, All Hours

**AD 2.4 Handling Services and Facilities**

- 2.4.1 Cargo Handling Facilities: NO
- 2.4.2 Fuel Types: 100,100LL,A
- 2.4.5 Hangar Space: YES
- 2.4.6 Repair Facilities: MAJOR

**AD 2.6 Rescue and Firefighting Services**

- 2.6.1 Aerodrome Category: Class-I certified on 5/1/1973
- 2.6.2 Rescue and Firefighting Services: ARFF Index-B

**AD 2.12 Runway Physical Characteristics**

- 2.12.1 Designation: 29R
- 2.12.2 True Bearing: 308
- 2.12.3 Dimensions: 10249 ft x 150 ft
- 2.12.4 PCN: 51 F/C/X/T
- 2.12.5 Coordinates: 37-53-6.64N / 121-13-21.88W
- 2.12.6 Threshold Elevation: 33.2 ft
- 2.12.6 Touchdown Zone Elevation: 32.3 ft
  
- 2.12.1 Designation: 11L
- 2.12.2 True Bearing: 128
- 2.12.3 Dimensions: 10249 ft x 150 ft
- 2.12.4 PCN: 51 F/C/X/T
- 2.12.5 Coordinates: 37-54-8.4321N / 121-15-3.2005W
- 2.12.6 Threshold Elevation: 26.5 ft
- 2.12.6 Touchdown Zone Elevation: 29.1 ft
  
- 2.12.1 Designation: 29L
- 2.12.2 True Bearing: 308
- 2.12.3 Dimensions: 4448 ft x 75 ft
- 2.12.4 PCN: 12 F/C/X/T
- 2.12.5 Coordinates: 37-53-31.8561N / 121-14-13.4466W
- 2.12.6 Threshold Elevation: 25.9 ft
- 2.12.6 Touchdown Zone Elevation: 26.6 ft

2.12.1 Designation: 11R  
2.12.2 True Bearing: 128  
2.12.3 Dimensions: 4448 ft x 75 ft  
2.12.4 PCN: 12 F/C/X/T  
2.12.5 Coordinates: 37-53-58.6715N / 121-14-57.4211W  
2.12.6 Threshold Elevation: 26.2 ft  
2.12.6 Touchdown Zone Elevation: 26.4 ft

2.12.1 Designation: H1  
2.12.2 True Bearing:  
2.12.3 Dimensions: 70 ft x 70 ft  
2.12.4 PCN:  
2.12.5 Coordinates: 37-53-45.27N / 121-14-47.57W  
2.12.6 Threshold Elevation: 26 ft  
2.12.6 Touchdown Zone Elevation: ft

### **AD 2.13 Declared Distances**

2.13.1 Designation: 29R  
2.13.2 Take-off Run Available: 8856  
2.13.3 Take-off Distance Available: 9856  
2.13.4 Accelerate-Stop Distance Available: 9210  
2.13.5 Landing Distance Available: 8650

2.13.1 Designation: 11L  
2.13.2 Take-off Run Available: 8474  
2.13.3 Take-off Distance Available: 9474  
2.13.4 Accelerate-Stop Distance Available: 8604  
2.13.5 Landing Distance Available: 8650

2.13.1 Designation: 29L  
2.13.2 Take-off Run Available: 4448  
2.13.3 Take-off Distance Available: 4448  
2.13.4 Accelerate-Stop Distance Available: 4448  
2.13.5 Landing Distance Available: 3386

2.13.1 Designation: 11R  
2.13.2 Take-off Run Available: 4448  
2.13.3 Take-off Distance Available: 4448  
2.13.4 Accelerate-Stop Distance Available: 4448  
2.13.5 Landing Distance Available: 4448

2.13.1 Designation: H1  
2.13.2 Take-off Run Available:  
2.13.3 Take-off Distance Available:  
2.13.4 Accelerate-Stop Distance Available:  
2.13.5 Landing Distance Available:

### **AD 2.14 Approach and Runway Lighting**

2.14.1 Designation: 29R  
2.14.2 Approach Lighting System: MALSR  
2.14.4 Visual Approach Slope Indicator System: P4L

2.14.1 Designation: 11L  
2.14.2 Approach Lighting System:  
2.14.4 Visual Approach Slope Indicator System: P4L

2.14.1 Designation: 29L  
2.14.2 Approach Lighting System:  
2.14.4 Visual Approach Slope Indicator System:

2.14.1 Designation: 11R  
2.14.2 Approach Lighting System:  
2.14.4 Visual Approach Slope Indicator System:

2.14.1 Designation: H1  
2.14.2 Approach Lighting System: ODALS  
2.14.4 Visual Approach Slope Indicator System:

#### **AD 2.18 Air Traffic Services Communication Facilities**

2.18.1 Service Designation: ANG OPS  
2.18.3 Channel: 49  
2.18.5 Hours of Operation:

2.18.1 Service Designation: ATIS  
2.18.3 Channel: 118.25  
2.18.5 Hours of Operation: 24

2.18.1 Service Designation: GND/P  
2.18.3 Channel: 121.9  
2.18.5 Hours of Operation: 0700-2100

2.18.1 Service Designation: LCL/P  
2.18.3 Channel: 120.3  
2.18.5 Hours of Operation: 0700-2100

2.18.1 Service Designation: LCL/P  
2.18.3 Channel: 239  
2.18.5 Hours of Operation: 0700-2100

2.18.1 Service Designation: NG OPS  
2.18.3 Channel: 139.4  
2.18.5 Hours of Operation:

2.18.1 Service Designation: NG OPS  
2.18.3 Channel: 356.9  
2.18.5 Hours of Operation:



**AD 2.19 Radio Navigation and Landing Aids**

2.19.1 ILS Type: DME for runway 29R. Magnetic variation: 14E

2.19.2 ILS Identification: SCK

2.19.5 Coordinates: 37-54-12.58N / 121-15-15.2W

2.19.6 Site Elevation: 22 ft

2.19.1 ILS Type: Glide Slope for runway 29R. Magnetic variation: 14E

2.19.2 ILS Identification: SCK

2.19.5 Coordinates: 37-53-19.8816N / 121-13-35.2049W

2.19.6 Site Elevation: 29.3 ft

2.19.1 ILS Type: Localizer for runway 29R. Magnetic variation: 14E

2.19.2 ILS Identification: SCK

2.19.5 Coordinates: 37-54-14.48N / 121-15-13.13W

2.19.6 Site Elevation: 23.5 ft

**General Remarks:**

PRACTICE CIRCLING APPROACHES TO RWYS 11L/11R NA FOR ANY TURBINE POWERED ACFT/PROP DRIVEN ACFT EXCEEDING 12500 LBS EXCP BY PPR FM AMGR.

TSNT PILOTS USE CTN; DO NOT ENTER THE TSA RSTRD AREA ADJ TO THE TSNT PRKG AREA.

BE ALERT TO ELEVD MALSR APCH END RWY 29R LCTD ON BLAST PAD.

PAVEMENT PRIOR TO THLD OF RWY 11L NOT AVBL FOR TAXI BACK OPS.

ARPT CLSD TO TGL & PLANNED LOW APCHS FOR TURBOJET ACFT 2200-0700 EXCEPT BY PPR FM AMGR PART 36 STAGE 3 ACFT.

TRANSIENT PARKING AVBL AT FBO.

THE FLWG AREAS NOT VISIBLE FM ATCT: TWY B FM TRML APN TO INT AT TWY M; TWY B FM 300 FT W OF TWY J TO 375 FT E OF TWY J; NON MOVEMENT AREA S OF TWY B FROM TRML APN TO 200 FT W OF TWY H; SE HALF OF TRML APN; TSNT PRKG APN.

AVOID OVERFLYING SAN JOAQUIN GENERAL HOSPITAL & THE CITY OF MANTECA.

TWY F RSTRD TO ACFT WINGSPAN LESS THAN 118 FT.

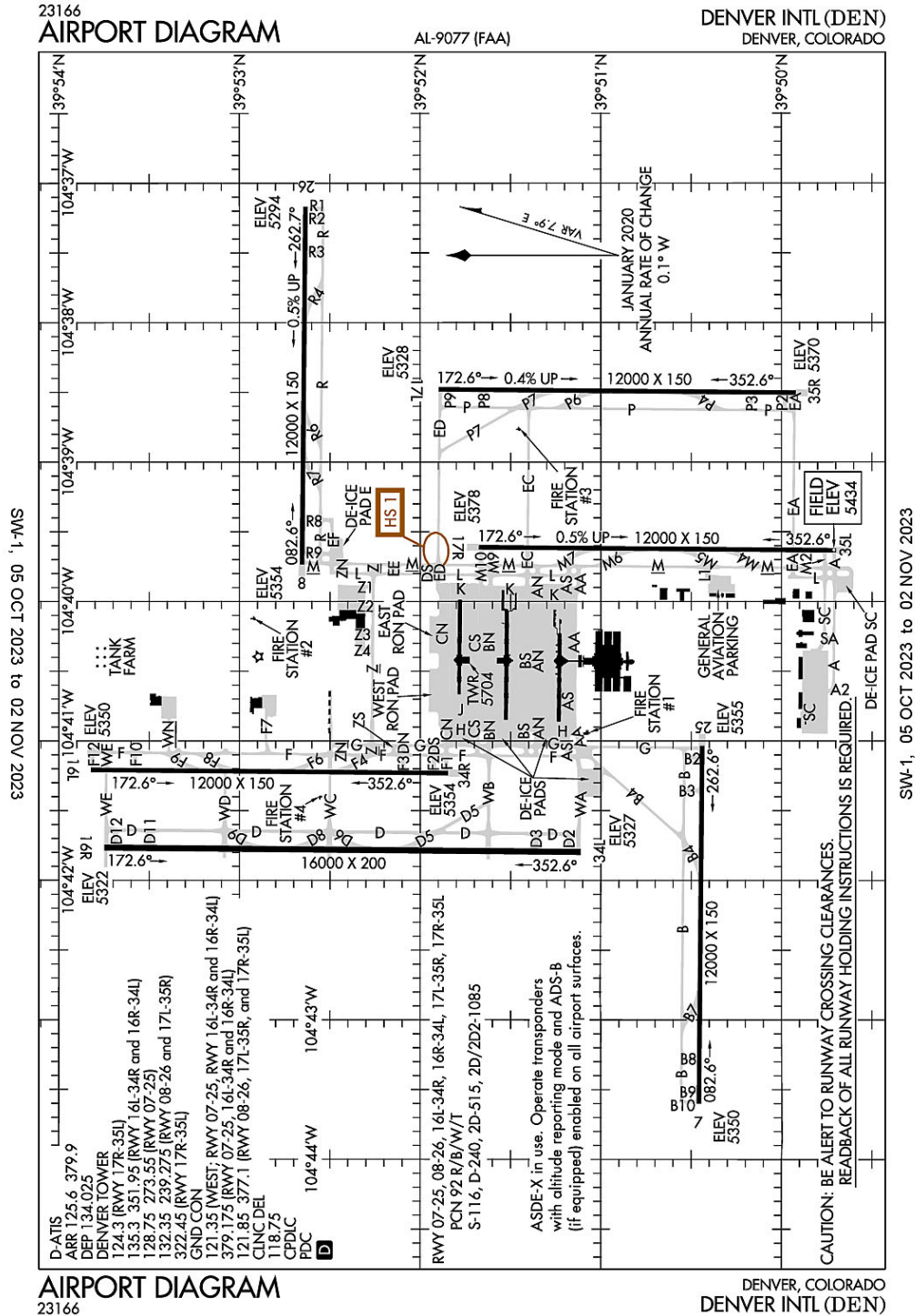
FOR CD WHEN ATCT CLSD CTC NORCAL APCH AT 916-361-0516.

MILITARY USE: ARNG OPR 1500-2330Z++ MON-FRI. DSN 466-5319, C209-983-5319, FAX 5391. PPR REQUIRED. LDTD TRAN SVC AND MAINT AVBL FOR CH47.

SEAGULLS ON AND IN VCNTY OF ARPT MOSTLY DURING RAINY WEATHER.

TRML APN, CARGO APN, TWYS B, B2, B3, F, D, D7, D9, AND H FOR ACFT OVER 12500 LBS. ALL OTR TWYS RSTRD TO ACFT LESS THAN 12500 LBS.

Denver, Colorado  
Denver International  
ICAO Identifier KDEN



**Denver, CO**  
**Denver Intl**  
**ICAO Identifier KDEN**

**AD 2.2 Aerodrome geographical and administrative data**

- 2.2.1 Reference Point: 39-51-42N / 104-40-23.4W
- 2.2.2 From City: 16 miles NE of DENVER, CO
- 2.2.3 Elevation: 5433.8 ft
- 2.2.5 Magnetic Variation: 8E (2015)
- 2.2.6 Airport Contact: PHIL WASHINGTON  
ADMIN BLDG, 8500 PENA BLVD  
DENVER, CO 80249 ((303) 342-2206)
- 2.2.7 Traffic: IFR/VFR

**AD 2.3 Attendance Schedule**

- 2.3.1 All Months, All Days, All Hours

**AD 2.4 Handling Services and Facilities**

- 2.4.1 Cargo Handling Facilities: NO
- 2.4.2 Fuel Types: 100LL,A
- 2.4.5 Hangar Space: YES
- 2.4.6 Repair Facilities: MAJOR

**AD 2.6 Rescue and Firefighting Services**

- 2.6.1 Aerodrome Category: Class-I certified on 2/1/1995
- 2.6.2 Rescue and Firefighting Services: ARFF Index-E

**AD 2.12 Runway Physical Characteristics**

- 2.12.1 Designation: 25
- 2.12.2 True Bearing: 271
- 2.12.3 Dimensions: 12000 ft x 150 ft
- 2.12.4 PCN: 92 R/B/W/T
- 2.12.5 Coordinates: 39-50-26.3667N / 104-41-2.1712W
- 2.12.6 Threshold Elevation: 5355 ft
- 2.12.6 Touchdown Zone Elevation: 5355 ft

- 2.12.1 Designation: 07
- 2.12.2 True Bearing: 90
- 2.12.3 Dimensions: 12000 ft x 150 ft
- 2.12.4 PCN: 92 R/B/W/T
- 2.12.5 Coordinates: 39-50-27.4022N / 104-43-35.963W
- 2.12.6 Threshold Elevation: 5350.2 ft
- 2.12.6 Touchdown Zone Elevation: 5351.6 ft

- 2.12.1 Designation: 26
- 2.12.2 True Bearing: 271
- 2.12.3 Dimensions: 12000 ft x 150 ft
- 2.12.4 PCN: 92 R/B/W/T
- 2.12.5 Coordinates: 39-52-38.0769N / 104-37-10.1479W
- 2.12.6 Threshold Elevation: 5294.4 ft
- 2.12.6 Touchdown Zone Elevation: 5309.4 ft

2.12.1 Designation: 08  
2.12.2 True Bearing: 91  
2.12.3 Dimensions: 12000 ft x 150 ft  
2.12.4 PCN: 92 R/B/W/T  
2.12.5 Coordinates: 39-52-39.2009N / 104-39-44.0267W  
2.12.6 Threshold Elevation: 5354.3 ft  
2.12.6 Touchdown Zone Elevation: 5354.3 ft

2.12.1 Designation: 16L  
2.12.2 True Bearing: 181  
2.12.3 Dimensions: 12000 ft x 150 ft  
2.12.4 PCN: 92 R/B/W/T  
2.12.5 Coordinates: 39-53-49.3301N / 104-41-12.4998W  
2.12.6 Threshold Elevation: 5349.9 ft  
2.12.6 Touchdown Zone Elevation: 5357.1 ft

2.12.1 Designation: 34R  
2.12.2 True Bearing: 1  
2.12.3 Dimensions: 12000 ft x 150 ft  
2.12.4 PCN: 92 R/B/W/T  
2.12.5 Coordinates: 39-51-50.7743N / 104-41-13.8782W  
2.12.6 Threshold Elevation: 5353.7 ft  
2.12.6 Touchdown Zone Elevation: 5353.7 ft

2.12.1 Designation: 16R  
2.12.2 True Bearing: 181  
2.12.3 Dimensions: 16000 ft x 200 ft  
2.12.4 PCN: 92 R/B/W/T  
2.12.5 Coordinates: 39-53-44.869N / 104-41-45.9006W  
2.12.6 Threshold Elevation: 5321.8 ft  
2.12.6 Touchdown Zone Elevation: 5326.3 ft

2.12.1 Designation: 34L  
2.12.2 True Bearing: 1  
2.12.3 Dimensions: 16000 ft x 200 ft  
2.12.4 PCN: 92 R/B/W/T  
2.12.5 Coordinates: 39-51-6.7926N / 104-41-47.7166W  
2.12.6 Threshold Elevation: 5327 ft  
2.12.6 Touchdown Zone Elevation: 5327 ft

2.12.1 Designation: 17L  
2.12.2 True Bearing: 181  
2.12.3 Dimensions: 12000 ft x 150 ft  
2.12.4 PCN: 92 R/B/W/T  
2.12.5 Coordinates: 39-51-53.8287N / 104-38-28.6959W  
2.12.6 Threshold Elevation: 5328.1 ft  
2.12.6 Touchdown Zone Elevation: 5338.5 ft

2.12.1 Designation: 35R  
2.12.2 True Bearing: 1

2.12.3 Dimensions: 12000 ft x 150 ft  
2.12.4 PCN: 92 R/B/W/T  
2.12.5 Coordinates: 39-49-55.2707N / 104-38-30.1554W  
2.12.6 Threshold Elevation: 5370 ft  
2.12.6 Touchdown Zone Elevation: 5370 ft

2.12.1 Designation: 17R  
2.12.2 True Bearing: 181  
2.12.3 Dimensions: 12000 ft x 150 ft  
2.12.4 PCN: 92 R/B/W/T  
2.12.5 Coordinates: 39-51-40.4821N / 104-39-36.5561W  
2.12.6 Threshold Elevation: 5377.9 ft  
2.12.6 Touchdown Zone Elevation: 5391.9 ft

2.12.1 Designation: 35L  
2.12.2 True Bearing: 1  
2.12.3 Dimensions: 12000 ft x 150 ft  
2.12.4 PCN: 92 R/B/W/T  
2.12.5 Coordinates: 39-49-41.9262N / 104-39-37.9841W  
2.12.6 Threshold Elevation: 5433.8 ft  
2.12.6 Touchdown Zone Elevation: 5433.8 ft

**AD 2.13 Declared Distances**

2.13.1 Designation: 25  
2.13.2 Take-off Run Available: 12000  
2.13.3 Take-off Distance Available: 13000  
2.13.4 Accelerate-Stop Distance Available: 12000  
2.13.5 Landing Distance Available: 12000

2.13.1 Designation: 07  
2.13.2 Take-off Run Available: 12000  
2.13.3 Take-off Distance Available: 12000  
2.13.4 Accelerate-Stop Distance Available: 12000  
2.13.5 Landing Distance Available: 12000

2.13.1 Designation: 26  
2.13.2 Take-off Run Available: 12000  
2.13.3 Take-off Distance Available: 12000  
2.13.4 Accelerate-Stop Distance Available: 12000  
2.13.5 Landing Distance Available: 12000

2.13.1 Designation: 08  
2.13.2 Take-off Run Available: 12000  
2.13.3 Take-off Distance Available: 13000  
2.13.4 Accelerate-Stop Distance Available: 12000  
2.13.5 Landing Distance Available: 12000

2.13.1 Designation: 16L  
2.13.2 Take-off Run Available: 12000  
2.13.3 Take-off Distance Available: 12000

2.13.4 Accelerate-Stop Distance Available: 12000  
2.13.5 Landing Distance Available: 12000

2.13.1 Designation: 34R  
2.13.2 Take-off Run Available: 12000  
2.13.3 Take-off Distance Available: 13000  
2.13.4 Accelerate-Stop Distance Available: 12000  
2.13.5 Landing Distance Available: 12000

2.13.1 Designation: 16R  
2.13.2 Take-off Run Available: 16000  
2.13.3 Take-off Distance Available: 16000  
2.13.4 Accelerate-Stop Distance Available: 16000  
2.13.5 Landing Distance Available: 16000

2.13.1 Designation: 34L  
2.13.2 Take-off Run Available: 16000  
2.13.3 Take-off Distance Available: 16000  
2.13.4 Accelerate-Stop Distance Available: 16000  
2.13.5 Landing Distance Available: 16000

2.13.1 Designation: 17L  
2.13.2 Take-off Run Available: 12000  
2.13.3 Take-off Distance Available: 12000  
2.13.4 Accelerate-Stop Distance Available: 12000  
2.13.5 Landing Distance Available: 12000

2.13.1 Designation: 35R  
2.13.2 Take-off Run Available: 12000  
2.13.3 Take-off Distance Available: 12000  
2.13.4 Accelerate-Stop Distance Available: 12000  
2.13.5 Landing Distance Available: 12000

2.13.1 Designation: 17R  
2.13.2 Take-off Run Available: 12000  
2.13.3 Take-off Distance Available: 12000  
2.13.4 Accelerate-Stop Distance Available: 12000  
2.13.5 Landing Distance Available: 12000

2.13.1 Designation: 35L  
2.13.2 Take-off Run Available: 12000  
2.13.3 Take-off Distance Available: 12000  
2.13.4 Accelerate-Stop Distance Available: 12000  
2.13.5 Landing Distance Available: 12000

**AD 2.14 Approach and Runway Lighting**

2.14.1 Designation: 25  
2.14.2 Approach Lighting System: MALSR  
2.14.4 Visual Approach Slope Indicator System: P4L

2.14.1 Designation: 07  
2.14.2 Approach Lighting System: MALSR  
2.14.4 Visual Approach Slope Indicator System: P4R

2.14.1 Designation: 26  
2.14.2 Approach Lighting System: MALSR  
2.14.4 Visual Approach Slope Indicator System: P4L

2.14.1 Designation: 08  
2.14.2 Approach Lighting System: MALSR  
2.14.4 Visual Approach Slope Indicator System: P4L

2.14.1 Designation: 16L  
2.14.2 Approach Lighting System: MALSR  
2.14.4 Visual Approach Slope Indicator System: P4L

2.14.1 Designation: 34R  
2.14.2 Approach Lighting System: ALSF2  
2.14.4 Visual Approach Slope Indicator System: P4L

2.14.1 Designation: 16R  
2.14.2 Approach Lighting System: MALSR  
2.14.4 Visual Approach Slope Indicator System: P4R

2.14.1 Designation: 34L  
2.14.2 Approach Lighting System: ALSF2  
2.14.4 Visual Approach Slope Indicator System: P4L

2.14.1 Designation: 17L  
2.14.2 Approach Lighting System: MALSR  
2.14.4 Visual Approach Slope Indicator System: P4L

2.14.1 Designation: 35R  
2.14.2 Approach Lighting System: ALSF2  
2.14.4 Visual Approach Slope Indicator System: P4R

2.14.1 Designation: 17R  
2.14.2 Approach Lighting System: MALSR  
2.14.4 Visual Approach Slope Indicator System: P4L

2.14.1 Designation: 35L  
2.14.2 Approach Lighting System: ALSF2  
2.14.4 Visual Approach Slope Indicator System: P4R

**AD 2.18 Air Traffic Services Communication Facilities**

2.18.1 Service Designation: CD/P  
2.18.3 Channel: 118.75  
2.18.5 Hours of Operation: 24

2.18.1 Service Designation: CD/P

2.18.3 Channel: 118.75

2.18.5 Hours of Operation: 24

2.18.1 Service Designation: D-ATIS (ARR)

2.18.3 Channel: 125.6

2.18.5 Hours of Operation: 24

2.18.1 Service Designation: D-ATIS (ARR)

2.18.3 Channel: 125.6

2.18.5 Hours of Operation: 24

2.18.1 Service Designation: D-ATIS (DEP)

2.18.3 Channel: 134.025

2.18.5 Hours of Operation: 24

2.18.1 Service Designation: D-ATIS (DEP)

2.18.3 Channel: 134.025

2.18.5 Hours of Operation: 24

2.18.1 Service Designation: D-ATIS (ARR)

2.18.3 Channel: 379.9

2.18.5 Hours of Operation: 24

2.18.1 Service Designation: D-ATIS (ARR)

2.18.3 Channel: 379.9

2.18.5 Hours of Operation: 24

2.18.1 Service Designation: EMERG

2.18.3 Channel: 121.5

2.18.5 Hours of Operation:

2.18.1 Service Designation: EMERG

2.18.3 Channel: 121.5

2.18.5 Hours of Operation:

2.18.1 Service Designation: EMERG

2.18.3 Channel: 243

2.18.5 Hours of Operation:

2.18.1 Service Designation: EMERG

2.18.3 Channel: 243

2.18.5 Hours of Operation:

2.18.1 Service Designation: GND/P (WEST; RWY 07/25, RWY 16L/34R, RWY 16R/34L)

2.18.3 Channel: 121.35

2.18.5 Hours of Operation: 24

2.18.1 Service Designation: GND/P (WEST; RWY 07/25, RWY 16L/34R, RWY 16R/34L)

2.18.3 Channel: 121.35

2.18.5 Hours of Operation: 24



2.18.1 Service Designation: GND/P (RWY 08/26, 17L/35R, 17R/35L)  
2.18.3 Channel: 121.85  
2.18.5 Hours of Operation: 24

2.18.1 Service Designation: GND/P (RWY 08/26, 17L/35R, 17R/35L)  
2.18.3 Channel: 121.85  
2.18.5 Hours of Operation: 24

2.18.1 Service Designation: GND/P (RWY 08/26, 17L/35R, 17R/35L)  
2.18.3 Channel: 377.1  
2.18.5 Hours of Operation: 24

2.18.1 Service Designation: GND/P (RWY 08/26, 17L/35R, 17R/35L)  
2.18.3 Channel: 377.1  
2.18.5 Hours of Operation: 24

2.18.1 Service Designation: GND/P (RWY 07/25, 16L/34R, 16R/34L)  
2.18.3 Channel: 379.175  
2.18.5 Hours of Operation: 24

2.18.1 Service Designation: GND/P (RWY 07/25, 16L/34R, 16R/34L)  
2.18.3 Channel: 379.175  
2.18.5 Hours of Operation: 24

2.18.1 Service Designation: LCL/P (RWY 17R/35L)  
2.18.3 Channel: 124.3  
2.18.5 Hours of Operation: 24

2.18.1 Service Designation: LCL/P (RWY 17R/35L)  
2.18.3 Channel: 124.3  
2.18.5 Hours of Operation: 24

2.18.1 Service Designation: LCL/P (RWY 07/25)  
2.18.3 Channel: 128.75  
2.18.5 Hours of Operation: 24

2.18.1 Service Designation: LCL/P (RWY 07/25)  
2.18.3 Channel: 128.75  
2.18.5 Hours of Operation: 24

2.18.1 Service Designation: LCL/P (RWY 08/26, 17L/35R)  
2.18.3 Channel: 132.35  
2.18.5 Hours of Operation: 24

2.18.1 Service Designation: LCL/P (RWY 08/26, 17L/35R)  
2.18.3 Channel: 132.35  
2.18.5 Hours of Operation: 24

2.18.1 Service Designation: LCL/P (RWY 16L/34R, 16R/34L)  
2.18.3 Channel: 135.3  
2.18.5 Hours of Operation: 24

2.18.1 Service Designation: LCL/P (RWY 16L/34R, 16R/34L)  
2.18.3 Channel: 135.3  
2.18.5 Hours of Operation: 24

2.18.1 Service Designation: LCL/P (RWY 08/26, 17L/35R)  
2.18.3 Channel: 239.275  
2.18.5 Hours of Operation: 24

2.18.1 Service Designation: LCL/P (RWY 08/26, 17L/35R)  
2.18.3 Channel: 239.275  
2.18.5 Hours of Operation: 24

2.18.1 Service Designation: LCL/P (RWY 07/25)  
2.18.3 Channel: 273.55  
2.18.5 Hours of Operation: 24

2.18.1 Service Designation: LCL/P (RWY 07/25)  
2.18.3 Channel: 273.55  
2.18.5 Hours of Operation: 24

2.18.1 Service Designation: LCL/P (RWY 17R/35L)  
2.18.3 Channel: 322.45  
2.18.5 Hours of Operation: 24

2.18.1 Service Designation: LCL/P (RWY 17R/35L)  
2.18.3 Channel: 322.45  
2.18.5 Hours of Operation: 24

2.18.1 Service Designation: LCL/P (RWY 16L/34R, 16R/34L)  
2.18.3 Channel: 351.95  
2.18.5 Hours of Operation: 24

2.18.1 Service Designation: LCL/P (RWY 16L/34R, 16R/34L)  
2.18.3 Channel: 351.95  
2.18.5 Hours of Operation: 24

#### **AD 2.19 Radio Navigation and Landing Aids**

2.19.1 ILS Type: DME for runway 07. Magnetic variation: 8E  
2.19.2 ILS Identification: DZG  
2.19.5 Coordinates: 39-50-23.6632N / 104-40-48.6232W  
2.19.6 Site Elevation: 5359.1 ft

2.19.1 ILS Type: Glide Slope for runway 07. Magnetic variation: 8E  
2.19.2 ILS Identification: DZG  
2.19.5 Coordinates: 39-50-23.2656N / 104-43-22.6558W  
2.19.6 Site Elevation: 5340.5 ft

2.19.1 ILS Type: Localizer for runway 07. Magnetic variation: 8E  
2.19.2 ILS Identification: DZG

2.19.5 Coordinates: 39-50-26.2755N / 104-40-49.0613W  
2.19.6 Site Elevation: 5354.9 ft

2.19.1 ILS Type: DME for runway 25. Magnetic variation: 8E  
2.19.2 ILS Identification: ERP  
2.19.5 Coordinates: 39-50-23.6632N / 104-40-48.6232W  
2.19.6 Site Elevation: 5359.1 ft

2.19.1 ILS Type: Glide Slope for runway 25. Magnetic variation: 8E  
2.19.2 ILS Identification: ERP  
2.19.5 Coordinates: 39-50-22.4098N / 104-41-15.7881W  
2.19.6 Site Elevation: 5344.2 ft

2.19.1 ILS Type: Localizer for runway 25. Magnetic variation: 8E  
2.19.2 ILS Identification: ERP  
2.19.5 Coordinates: 39-50-27.4883N / 104-43-49.0723W  
2.19.6 Site Elevation: 5348.9 ft

2.19.1 ILS Type: DME for runway 08. Magnetic variation: 8E  
2.19.2 ILS Identification: FUI  
2.19.5 Coordinates: 39-52-41.8784N / 104-39-57.5078W  
2.19.6 Site Elevation: 5360.2 ft

2.19.1 ILS Type: Glide Slope for runway 08. Magnetic variation: 8E  
2.19.2 ILS Identification: FUI  
2.19.5 Coordinates: 39-52-43.1529N / 104-39-29.8599W  
2.19.6 Site Elevation: 5342.2 ft

2.19.1 ILS Type: Localizer for runway 08. Magnetic variation: 8E  
2.19.2 ILS Identification: FUI  
2.19.5 Coordinates: 39-52-37.9791N / 104-36-57.0352W  
2.19.6 Site Elevation: 5283.1 ft

2.19.1 ILS Type: DME for runway 26. Magnetic variation: 8E  
2.19.2 ILS Identification: JOY  
2.19.5 Coordinates: 39-52-41.8784N / 104-39-57.5078W  
2.19.6 Site Elevation: 5360.2 ft

2.19.1 ILS Type: Glide Slope for runway 26. Magnetic variation: 8E  
2.19.2 ILS Identification: JOY  
2.19.5 Coordinates: 39-52-42.2239N / 104-37-22.3854W  
2.19.6 Site Elevation: 5293.2 ft

2.19.1 ILS Type: Localizer for runway 26. Magnetic variation: 8E  
2.19.2 ILS Identification: JOY  
2.19.5 Coordinates: 39-52-39.2968N / 104-39-57.142W  
2.19.6 Site Elevation: 5347.6 ft

2.19.1 ILS Type: DME for runway 16L. Magnetic variation: 8E  
2.19.2 ILS Identification: LTT  
2.19.5 Coordinates: 39-53-59.6091N / 104-41-15.7719W

2.19.6 Site Elevation: 5357 ft

2.19.1 ILS Type: Glide Slope for runway 16L. Magnetic variation: 8E  
2.19.2 ILS Identification: LTT  
2.19.5 Coordinates: 39-53-39.5473N / 104-41-17.8695W  
2.19.6 Site Elevation: 5346.5 ft

2.19.1 ILS Type: Localizer for runway 16L. Magnetic variation: 8E  
2.19.2 ILS Identification: LTT  
2.19.5 Coordinates: 39-51-40.6701N / 104-41-13.996W  
2.19.6 Site Elevation: 5343.2 ft

2.19.1 ILS Type: DME for runway 34R. Magnetic variation: 8E  
2.19.2 ILS Identification: OUF  
2.19.5 Coordinates: 39-53-59.6091N / 104-41-15.7719W  
2.19.6 Site Elevation: 5357 ft

2.19.1 ILS Type: Glide Slope for runway 34R. Magnetic variation: 8E  
2.19.2 ILS Identification: OUF  
2.19.5 Coordinates: 39-52-1.3925N / 104-41-19.0115W  
2.19.6 Site Elevation: 5346.4 ft

2.19.1 ILS Type: Inner Marker for runway 34R. Magnetic variation: 8E  
2.19.2 ILS Identification: OUF  
2.19.5 Coordinates: 39-51-42.2879N / 104-41-13.9788W  
2.19.6 Site Elevation: 5345 ft

2.19.1 ILS Type: Localizer for runway 34R. Magnetic variation: 8E  
2.19.2 ILS Identification: OUF  
2.19.5 Coordinates: 39-53-59.4426N / 104-41-12.3812W  
2.19.6 Site Elevation: 5349.7 ft

2.19.1 ILS Type: DME for runway 16R. Magnetic variation: 8E  
2.19.2 ILS Identification: DQQ  
2.19.5 Coordinates: 39-53-55.7414N / 104-41-50.8967W  
2.19.6 Site Elevation: 5323.5 ft

2.19.1 ILS Type: Glide Slope for runway 16R. Magnetic variation: 8E  
2.19.2 ILS Identification: DQQ  
2.19.5 Coordinates: 39-53-34.8236N / 104-41-51.2764W  
2.19.6 Site Elevation: 5316.8 ft

2.19.1 ILS Type: Localizer for runway 16R. Magnetic variation: 8E  
2.19.2 ILS Identification: DQQ  
2.19.5 Coordinates: 39-50-56.7831N / 104-41-47.8336W  
2.19.6 Site Elevation: 5320.8 ft

2.19.1 ILS Type: DME for runway 34L. Magnetic variation: 8E  
2.19.2 ILS Identification: DXU  
2.19.5 Coordinates: 39-53-55.7414N / 104-41-50.8967W  
2.19.6 Site Elevation: 5323.5 ft

2.19.1 ILS Type: Glide Slope for runway 34L. Magnetic variation: 8E  
2.19.2 ILS Identification: DXU  
2.19.5 Coordinates: 39-51-17.5994N / 104-41-52.8493W  
2.19.6 Site Elevation: 5317.6 ft

2.19.1 ILS Type: Inner Marker for runway 34L. Magnetic variation: 8E  
2.19.2 ILS Identification: DXU  
2.19.5 Coordinates: 39-50-58.2971N / 104-41-47.8092W  
2.19.6 Site Elevation: 5321.4 ft

2.19.1 ILS Type: Localizer for runway 34L. Magnetic variation: 8E  
2.19.2 ILS Identification: DXU  
2.19.5 Coordinates: 39-53-54.875N / 104-41-45.7848W  
2.19.6 Site Elevation: 5320.1 ft

2.19.1 ILS Type: DME for runway 17L. Magnetic variation: 8E  
2.19.2 ILS Identification: BXP  
2.19.5 Coordinates: 39-52-4.266N / 104-38-25.1893W  
2.19.6 Site Elevation: 5345.1 ft

2.19.1 ILS Type: Glide Slope for runway 17L. Magnetic variation: 8E  
2.19.2 ILS Identification: BXP  
2.19.5 Coordinates: 39-51-44.0596N / 104-38-23.5605W  
2.19.6 Site Elevation: 5326 ft

2.19.1 ILS Type: Localizer for runway 17L. Magnetic variation: 8E  
2.19.2 ILS Identification: BXP  
2.19.5 Coordinates: 39-49-45.1652N / 104-38-30.282W  
2.19.6 Site Elevation: 5362.9 ft

2.19.1 ILS Type: DME for runway 35R. Magnetic variation: 8E  
2.19.2 ILS Identification: DPP  
2.19.5 Coordinates: 39-52-4.266N / 104-38-25.1893W  
2.19.6 Site Elevation: 5345.1 ft

2.19.1 ILS Type: Glide Slope for runway 35R. Magnetic variation: 8E  
2.19.2 ILS Identification: DPP  
2.19.5 Coordinates: 39-50-6.3585N / 104-38-24.7651W  
2.19.6 Site Elevation: 5359.9 ft

2.19.1 ILS Type: Inner Marker for runway 35R. Magnetic variation: 8E  
2.19.2 ILS Identification: DPP  
2.19.5 Coordinates: 39-49-46.7811N / 104-38-30.2697W  
2.19.6 Site Elevation: 5364.5 ft

2.19.1 ILS Type: Localizer for runway 35R. Magnetic variation: 8E  
2.19.2 ILS Identification: DPP  
2.19.5 Coordinates: 39-52-3.9404N / 104-38-28.572W  
2.19.6 Site Elevation: 5335.5 ft

2.19.1 ILS Type: DME for runway 17R. Magnetic variation: 8E  
2.19.2 ILS Identification: ACX  
2.19.5 Coordinates: 39-51-50.9244N / 104-39-33.0513W  
2.19.6 Site Elevation: 5388 ft

2.19.1 ILS Type: Glide Slope for runway 17R. Magnetic variation: 8E  
2.19.2 ILS Identification: ACX  
2.19.5 Coordinates: 39-51-30.9128N / 104-39-31.4164W  
2.19.6 Site Elevation: 5378 ft

2.19.1 ILS Type: Localizer for runway 17R. Magnetic variation: 8E  
2.19.2 ILS Identification: ACX  
2.19.5 Coordinates: 39-49-31.8218N / 104-39-38.1041W  
2.19.6 Site Elevation: 5427.6 ft

2.19.1 ILS Type: DME for runway 35L. Magnetic variation: 8E  
2.19.2 ILS Identification: AQD  
2.19.5 Coordinates: 39-51-50.9244N / 104-39-33.0513W  
2.19.6 Site Elevation: 5388 ft

2.19.1 ILS Type: Glide Slope for runway 35L. Magnetic variation: 8E  
2.19.2 ILS Identification: AQD  
2.19.5 Coordinates: 39-49-52.7648N / 104-39-32.5991W  
2.19.6 Site Elevation: 5422.6 ft

2.19.1 ILS Type: Localizer for runway 35L. Magnetic variation: 8E  
2.19.2 ILS Identification: AQD  
2.19.5 Coordinates: 39-51-50.5996N / 104-39-36.4352W  
2.19.6 Site Elevation: 5377.3 ft

2.19.1 Navigation Aid Type: VOR/DME. Magnetic variation: 8E  
2.19.2 Navigation Aid Identification: DEN  
2.19.5 Coordinates: 39-48-45.0506N / 104-39-38.6643W  
2.19.6 Site Elevation: 5452.1 ft

**General Remarks:**

TWY F7 CLSD TO ACFT WINGSPAN MORE THAN 118 FT.

INFORMAL RWY USE PROGRAM IN EFCT H24; NOISE ABATEMENT INFO – ARPT MGMT 303-342-4200.

OVHD PAX BRIDGE S SIDE OF CONCOURSE-A PRVDS 42 FT TAIL & 118 FT WINGSPAN CLNC WHEN ON TWY CNTRLN.

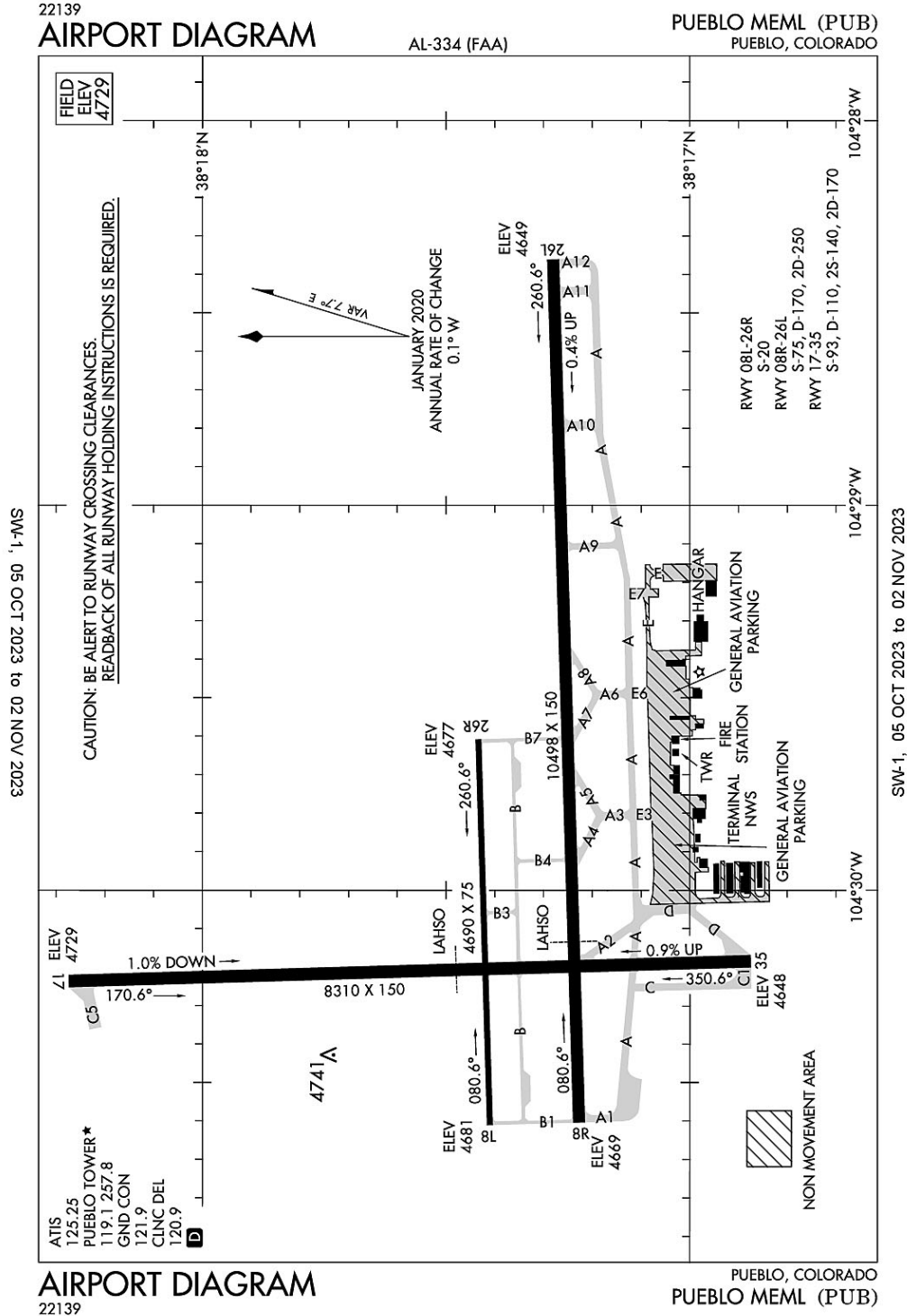
ASDE-X IN USE; OPR TRANSPONDERS WITH ALT RPRTG MODE & ADS-B IF EQUIPPED ENABLED ON ALL ARPT SFCS.

WATERFOWL & BIRDS INVOF ARPT.

CUSTOMS AVBL PPR.

DEP RWY 08, 25 & 34R HAS MNTND CWY 500 X 1000 FT 1.25 SLOPE.

**Pueblo, Colorado  
Pueblo Memorial  
ICAO Identifier KPUB**



**Pueblo, CO**  
**Pueblo Memorial**  
**ICAO Identifier KPUB**

**AD 2.2 Aerodrome geographical and administrative data**

- 2.2.1 Reference Point: 38-17-23.811N / 104-29-52.901W
- 2.2.2 From City: 5 miles E of PUEBLO, CO
- 2.2.3 Elevation: 4729.3 ft
- 2.2.5 Magnetic Variation: 8E (2015)
- 2.2.6 Airport Contact: GREG PEDROZA  
31201 BRYAN CIRCLE  
PUEBLO, CO 81001 (719-553-2744)
- 2.2.7 Traffic: IFR/VFR

**AD 2.3 Attendance Schedule**

- 2.3.1 All Months, All Days, 0500-2200 Hours

**AD 2.4 Handling Services and Facilities**

- 2.4.1 Cargo Handling Facilities: NO
- 2.4.2 Fuel Types: 100LL,A
- 2.4.5 Hangar Space: YES
- 2.4.6 Repair Facilities: MAJOR

**AD 2.6 Rescue and Firefighting Services**

- 2.6.1 Aerodrome Category: Class-I certified on 5/1/1973
- 2.6.2 Rescue and Firefighting Services: ARFF Index-A

**AD 2.12 Runway Physical Characteristics**

- 2.12.1 Designation: 08L
- 2.12.2 True Bearing: 88
- 2.12.3 Dimensions: 4690 ft x 75 ft
- 2.12.4 PCN:
- 2.12.5 Coordinates: 38-17-24.3081N / 104-30-36.6451W
- 2.12.6 Threshold Elevation: 4681.2 ft
- 2.12.6 Touchdown Zone Elevation: 4681.2 ft

- 2.12.1 Designation: 26R
- 2.12.2 True Bearing: 268
- 2.12.3 Dimensions: 4690 ft x 75 ft
- 2.12.4 PCN:
- 2.12.5 Coordinates: 38-17-25.7014N / 104-29-37.865W
- 2.12.6 Threshold Elevation: 4677 ft
- 2.12.6 Touchdown Zone Elevation: 4678.1 ft

- 2.12.1 Designation: 08R
- 2.12.2 True Bearing: 88
- 2.12.3 Dimensions: 10498 ft x 150 ft
- 2.12.4 PCN:
- 2.12.5 Coordinates: 38-17-13.6348N / 104-30-36.2409W
- 2.12.6 Threshold Elevation: 4669.4 ft
- 2.12.6 Touchdown Zone Elevation: 4671.4 ft



2.12.1 Designation: 26L  
2.12.2 True Bearing: 268  
2.12.3 Dimensions: 10498 ft x 150 ft  
2.12.4 PCN:  
2.12.5 Coordinates: 38-17-16.7526N / 104-28-24.6616W  
2.12.6 Threshold Elevation: 4648.8 ft  
2.12.6 Touchdown Zone Elevation: 4658.9 ft

2.12.1 Designation: 17  
2.12.2 True Bearing: 178  
2.12.3 Dimensions: 8310 ft x 150 ft  
2.12.4 PCN:  
2.12.5 Coordinates: 38-18-15.0609N / 104-30-14.6942W  
2.12.6 Threshold Elevation: 4729.3 ft  
2.12.6 Touchdown Zone Elevation: 4729.3 ft

2.12.1 Designation: 35  
2.12.2 True Bearing: 358  
2.12.3 Dimensions: 8310 ft x 150 ft  
2.12.4 PCN:  
2.12.5 Coordinates: 38-16-52.9717N / 104-30-11.6348W  
2.12.6 Threshold Elevation: 4648.1 ft  
2.12.6 Touchdown Zone Elevation: 4676.9 ft

**AD 2.13 Declared Distances**

2.13.1 Designation: 08L  
2.13.2 Take-off Run Available: 4690  
2.13.3 Take-off Distance Available: 4690  
2.13.4 Accelerate-Stop Distance Available: 4690  
2.13.5 Landing Distance Available: 4690

2.13.1 Designation: 26R  
2.13.2 Take-off Run Available: 4690  
2.13.3 Take-off Distance Available: 4690  
2.13.4 Accelerate-Stop Distance Available: 4690  
2.13.5 Landing Distance Available: 4690

2.13.1 Designation: 08R  
2.13.2 Take-off Run Available: 10496  
2.13.3 Take-off Distance Available: 10496  
2.13.4 Accelerate-Stop Distance Available: 10496  
2.13.5 Landing Distance Available: 10496

2.13.1 Designation: 26L  
2.13.2 Take-off Run Available: 10496  
2.13.3 Take-off Distance Available: 10496  
2.13.4 Accelerate-Stop Distance Available: 10496  
2.13.5 Landing Distance Available: 10496

2.13.1 Designation: 17  
2.13.2 Take-off Run Available: 8308  
2.13.3 Take-off Distance Available: 8308  
2.13.4 Accelerate-Stop Distance Available: 8308  
2.13.5 Landing Distance Available: 8308

2.13.1 Designation: 35  
2.13.2 Take-off Run Available: 8308  
2.13.3 Take-off Distance Available: 8308  
2.13.4 Accelerate-Stop Distance Available: 8308  
2.13.5 Landing Distance Available: 8308

**AD 2.14 Approach and Runway Lighting**

2.14.1 Designation: 08L  
2.14.2 Approach Lighting System:  
2.14.4 Visual Approach Slope Indicator System: P4L

2.14.1 Designation: 26R  
2.14.2 Approach Lighting System:  
2.14.4 Visual Approach Slope Indicator System: P4L

2.14.1 Designation: 08R  
2.14.2 Approach Lighting System: MALSR  
2.14.4 Visual Approach Slope Indicator System: P4L

2.14.1 Designation: 26L  
2.14.2 Approach Lighting System:  
2.14.4 Visual Approach Slope Indicator System: P4L

2.14.1 Designation: 17  
2.14.2 Approach Lighting System:  
2.14.4 Visual Approach Slope Indicator System: P4L

2.14.1 Designation: 35  
2.14.2 Approach Lighting System:  
2.14.4 Visual Approach Slope Indicator System: P4L

**AD 2.18 Air Traffic Services Communication Facilities**

2.18.1 Service Designation: ATIS  
2.18.3 Channel: 125.25  
2.18.5 Hours of Operation: 24

2.18.1 Service Designation: CD/P  
2.18.3 Channel: 120.9  
2.18.5 Hours of Operation: 0600-2200

2.18.1 Service Designation: EMERG  
2.18.3 Channel: 121.5  
2.18.5 Hours of Operation:

2.18.1 Service Designation: EMERG  
2.18.3 Channel: 243  
2.18.5 Hours of Operation:

2.18.1 Service Designation: GND/P  
2.18.3 Channel: 121.9  
2.18.5 Hours of Operation: 0600-2200

2.18.1 Service Designation: LCL/P  
2.18.3 Channel: 119.1  
2.18.5 Hours of Operation: 0600-2200

2.18.1 Service Designation: LCL/P  
2.18.3 Channel: 257.8  
2.18.5 Hours of Operation: 0600-2200

**AD 2.19 Radio Navigation and Landing Aids**

2.19.1 ILS Type: Glide Slope for runway 08R. Magnetic variation: 8E  
2.19.2 ILS Identification: PUB  
2.19.5 Coordinates: 38-17-18.9334N / 104-30-21.5794W  
2.19.6 Site Elevation: 4672.8 ft

2.19.1 ILS Type: Localizer for runway 08R. Magnetic variation: 8E  
2.19.2 ILS Identification: PUB  
2.19.5 Coordinates: 38-17-17.2016N / 104-28-6.1097W  
2.19.6 Site Elevation: 4653.1 ft

2.19.1 ILS Type: Glide Slope for runway 26L. Magnetic variation: 8E  
2.19.2 ILS Identification: TFR  
2.19.5 Coordinates: 38-17-21.3596N / 104-28-39.1966W  
2.19.6 Site Elevation: 4649.4 ft

2.19.1 ILS Type: Localizer for runway 26L. Magnetic variation: 8E  
2.19.2 ILS Identification: TFR  
2.19.5 Coordinates: 38-17-13.2497N / 104-30-52.5582W  
2.19.6 Site Elevation: 4668 ft

2.19.1 Navigation Aid Type: VORTAC. Magnetic variation: 8E  
2.19.2 Navigation Aid Identification: PUB  
2.19.5 Coordinates: 38-17-39.3132N / 104-25-46.0107W  
2.19.6 Site Elevation: 4755.5 ft

**General Remarks:**

HIGH VOLUME TRNG DA-20 ACFT SR-SS MON-FRI. OVERHEAD PATTERN DURG TRNG. EXTENSIVE USE OF TRNG AREA 12-28 DME N-SW OF ARPT 500 FT AGL-8500 FT MSL.

BE ALERT; INTENSIVE USAF STUDENT TRAINING IN VICINITY OF COLORADO SPRINGS & PUEBLO COLORADO.

CONDITIONS NOT MONITORED 2200L-0500L.

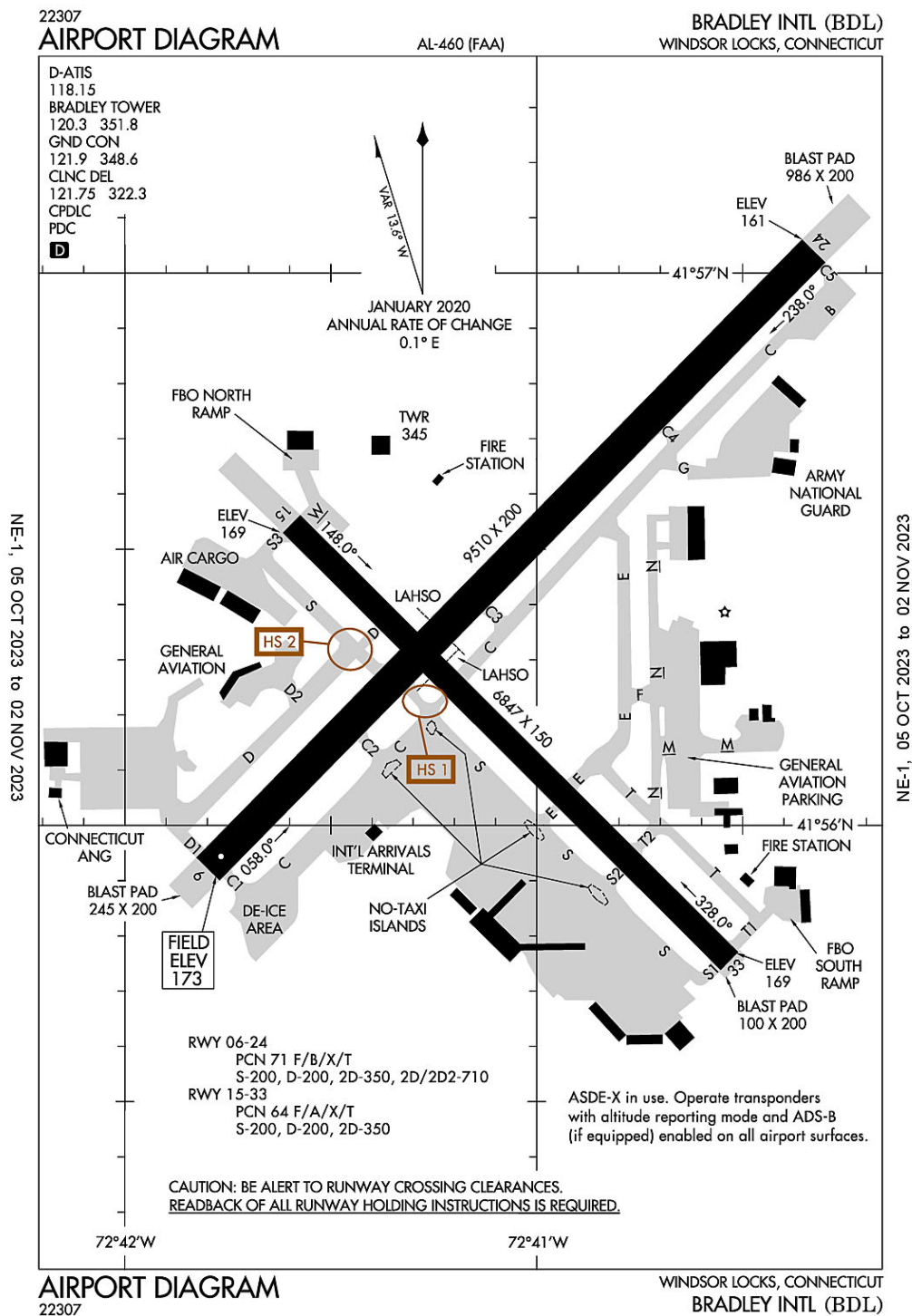
SEE FLIP AP/1 SUPPLEMENTARY ARPT INFO.

RAMP-TAXI LANE E EXTD 30 FT WIDE FM EAST RAMP TO TWY E7.

TWY A BTN TWY A2 AND A6 50 FT WID.

FOR CD CTC PUEBLO APCH AT 303-342-1916, WHEN APCH CLSD CTC DENVER ARTCC AT 303-651-4257.

**Windsor Locks, Connecticut  
Bradley International  
ICAO Identifier KBDL**



**Windsor Locks, CT**  
**Bradley Intl**  
**ICAO Identifier KBDL**

**AD 2.2 Aerodrome geographical and administrative data**

- 2.2.1 Reference Point: 41-56-20.516N / 72-41-3.537W
- 2.2.2 From City: 3 miles W of WINDSOR LOCKS, CT
- 2.2.3 Elevation: 173.3 ft
- 2.2.5 Magnetic Variation: 14W (1980)
- 2.2.6 Airport Contact: KEVIN DILLON, AAE  
BRADLEY INTL AIRPORT  
WINDSOR LOCKS, CT 6096 (860-292-2000)
- 2.2.7 Traffic: IFR/VFR

**AD 2.3 Attendance Schedule**

- 2.3.1 All Months, All Days, All Hours

**AD 2.4 Handling Services and Facilities**

- 2.4.1 Cargo Handling Facilities: YES
- 2.4.2 Fuel Types: 100LL,A
- 2.4.5 Hangar Space: YES
- 2.4.6 Repair Facilities: MAJOR

**AD 2.6 Rescue and Firefighting Services**

- 2.6.1 Aerodrome Category: Class-I certified on 5/1/1973
- 2.6.2 Rescue and Firefighting Services: ARFF Index-C

**AD 2.12 Runway Physical Characteristics**

- 2.12.1 Designation: 06
- 2.12.2 True Bearing: 44
- 2.12.3 Dimensions: 9510 ft x 200 ft
- 2.12.4 PCN: 71 F/B/X/T
- 2.12.5 Coordinates: 41-55-55.25N / 72-41-47.6885W
- 2.12.6 Threshold Elevation: 173 ft
- 2.12.6 Touchdown Zone Elevation: 173.3 ft
  
- 2.12.1 Designation: 24
- 2.12.2 True Bearing: 224
- 2.12.3 Dimensions: 9510 ft x 200 ft
- 2.12.4 PCN: 71 F/B/X/T
- 2.12.5 Coordinates: 41-57-2.3952N / 72-40-19.6697W
- 2.12.6 Threshold Elevation: 160.9 ft
- 2.12.6 Touchdown Zone Elevation: 170 ft
  
- 2.12.1 Designation: 15
- 2.12.2 True Bearing: 134
- 2.12.3 Dimensions: 6847 ft x 150 ft
- 2.12.4 PCN: 64 F/A/X/T
- 2.12.5 Coordinates: 41-56-32.6254N / 72-41-35.7104W
- 2.12.6 Threshold Elevation: 168.8 ft
- 2.12.6 Touchdown Zone Elevation: 170.8 ft

- 2.12.1 Designation: 33
- 2.12.2 True Bearing: 314
- 2.12.3 Dimensions: 6847 ft x 150 ft
- 2.12.4 PCN: 64 F/A/X/T
- 2.12.5 Coordinates: 41-55-45.3238N / 72-40-30.9557W
- 2.12.6 Threshold Elevation: 168.5 ft
- 2.12.6 Touchdown Zone Elevation: 171.4 ft

#### **AD 2.13 Declared Distances**

- 2.13.1 Designation: 06
- 2.13.2 Take-off Run Available: 9509
- 2.13.3 Take-off Distance Available: 9509
- 2.13.4 Accelerate-Stop Distance Available: 9509
- 2.13.5 Landing Distance Available: 9509

- 2.13.1 Designation: 24
- 2.13.2 Take-off Run Available: 9509
- 2.13.3 Take-off Distance Available: 9509
- 2.13.4 Accelerate-Stop Distance Available: 9509
- 2.13.5 Landing Distance Available: 9509

- 2.13.1 Designation: 15
- 2.13.2 Take-off Run Available: 6847
- 2.13.3 Take-off Distance Available: 6847
- 2.13.4 Accelerate-Stop Distance Available: 6847
- 2.13.5 Landing Distance Available: 6847

- 2.13.1 Designation: 33
- 2.13.2 Take-off Run Available: 6847
- 2.13.3 Take-off Distance Available: 6847
- 2.13.4 Accelerate-Stop Distance Available: 6847
- 2.13.5 Landing Distance Available: 6847

#### **AD 2.14 Approach and Runway Lighting**

- 2.14.1 Designation: 06
- 2.14.2 Approach Lighting System: ALSF2
- 2.14.4 Visual Approach Slope Indicator System: P4L

- 2.14.1 Designation: 24
- 2.14.2 Approach Lighting System: MALSR
- 2.14.4 Visual Approach Slope Indicator System: P4L

- 2.14.1 Designation: 15
- 2.14.2 Approach Lighting System:
- 2.14.4 Visual Approach Slope Indicator System: P4L

- 2.14.1 Designation: 33
- 2.14.2 Approach Lighting System: MALSF

2.14.4 Visual Approach Slope Indicator System: P4R

**AD 2.18 Air Traffic Services Communication Facilities**

2.18.1 Service Designation: ANG OPS

2.18.3 Channel: 138.55

2.18.5 Hours of Operation:

2.18.1 Service Designation: ANG OPS

2.18.3 Channel: 349.7

2.18.5 Hours of Operation:

2.18.1 Service Designation: CD/P

2.18.3 Channel: 121.75

2.18.5 Hours of Operation: 24

2.18.1 Service Designation: CD/P

2.18.3 Channel: 322.3

2.18.5 Hours of Operation: 24

2.18.1 Service Designation: D-ATIS

2.18.3 Channel: 118.15

2.18.5 Hours of Operation: 24

2.18.1 Service Designation: EMERG

2.18.3 Channel: 121.5

2.18.5 Hours of Operation:

2.18.1 Service Designation: EMERG

2.18.3 Channel: 243

2.18.5 Hours of Operation:

2.18.1 Service Designation: GND/P

2.18.3 Channel: 121.9

2.18.5 Hours of Operation: 24

2.18.1 Service Designation: GND/P

2.18.3 Channel: 348.6

2.18.5 Hours of Operation: 24

2.18.1 Service Designation: LCL/P

2.18.3 Channel: 120.3

2.18.5 Hours of Operation: 24

2.18.1 Service Designation: LCL/P

2.18.3 Channel: 351.8

2.18.5 Hours of Operation: 24

2.18.1 Service Designation: NG OPS

2.18.3 Channel: 41.9

2.18.5 Hours of Operation:



2.18.1 Service Designation: NG OPS  
2.18.3 Channel: 123.45  
2.18.5 Hours of Operation:

2.18.1 Service Designation: NG OPS  
2.18.3 Channel: 243.9  
2.18.5 Hours of Operation:

**AD 2.19 Radio Navigation and Landing Aids**

2.19.1 ILS Type: DME for runway 06. Magnetic variation: 14W  
2.19.2 ILS Identification: BDL  
2.19.5 Coordinates: 41-57-17.2894N / 72-39-56.5118W  
2.19.6 Site Elevation: 163.8 ft

2.19.1 ILS Type: Glide Slope for runway 06. Magnetic variation: 14W  
2.19.2 ILS Identification: BDL  
2.19.5 Coordinates: 41-56-5.5448N / 72-41-41.8869W  
2.19.6 Site Elevation: 169.3 ft

2.19.1 ILS Type: Localizer for runway 06. Magnetic variation: 14W  
2.19.2 ILS Identification: BDL  
2.19.5 Coordinates: 41-57-17.8499N / 72-39-59.4045W  
2.19.6 Site Elevation: 149.5 ft

2.19.1 ILS Type: DME for runway 24. Magnetic variation: 14W  
2.19.2 ILS Identification: MYQ  
2.19.5 Coordinates: 41-57-17.2894N / 72-39-56.5118W  
2.19.6 Site Elevation: 163.8 ft

2.19.1 ILS Type: Glide Slope for runway 24. Magnetic variation: 14W  
2.19.2 ILS Identification: MYQ  
2.19.5 Coordinates: 41-56-53.5757N / 72-40-25.9626W  
2.19.6 Site Elevation: 156.7 ft

2.19.1 ILS Type: Localizer for runway 24. Magnetic variation: 14W  
2.19.2 ILS Identification: MYQ  
2.19.5 Coordinates: 41-55-47.661N / 72-41-57.6296W  
2.19.6 Site Elevation: 170.3 ft

2.19.1 ILS Type: DME for runway 33. Magnetic variation: 14W  
2.19.2 ILS Identification: IKX  
2.19.5 Coordinates: 41-56-37.9724N / 72-41-47.432W  
2.19.6 Site Elevation: 181.8 ft

2.19.1 ILS Type: Glide Slope for runway 33. Magnetic variation: 14W  
2.19.2 ILS Identification: IKX  
2.19.5 Coordinates: 41-55-54.7672N / 72-40-38.5896W  
2.19.6 Site Elevation: 167.6 ft

2.19.1 ILS Type: Localizer for runway 33. Magnetic variation: 14W  
2.19.2 ILS Identification: IKX  
2.19.5 Coordinates: 41-56-40.2961N / 72-41-46.2065W  
2.19.6 Site Elevation: 168.3 ft

**General Remarks:**

TWY D CLSD BTN S & D1 TO ACFT WITH WING SPANS IN EXCESS OF 170 FT.

ASDE-X IN USE. OPR TRANSPONDERS WITH ALT RPRTG MODE AND ADS-B (IF EQUIPPED) ENABLED ON ALL ARPT SFCS.

TWY C BTN TWY B & TWY C4 ACFT TAX SPD RSTRN OF 8 KTS/10 MPH MAX FOR ACFT WITH WING-SPAN 214 FT OR GTR.

LGTD OBST ANT 36 FT AGL/205 FT MSL (RWY 24 ILS/GS ANT) 162 FT NW OF TWY C CNTRLN MARKING BTN TWY B & TWY C4.

CAUTION: ANG RAMP MRK MAY NOT BE APPROPRIATE FOR LARGE ACFT: FLW MARSHALLERS INSTR.

OPS CTC AUTOVON 636-8385; COML 860-627-3001.

NMRS BIRDS FQTLY ON OR INVOF ARPT.

MILITARY: ANG: WHEN CKG ATIS, BIRDS IN VCY MAY INDC HEIGHTENED BIRD WATCH CONDITION (BWC). USAF ACFT CTC ANG AIRFIELD OPS ON UHF FOR CURRENT BWC & ANY ASSOCD RSTRNS.

MILITARY: ARNG - DSN 636-7519/7520. C860-292-4519/4520.

MILITARY: ANG: OG/CC WAIVER ON FILE FOR C-130H/J WITH OPR WT UP TO 155000 LB. ALL OTHER ACFT OVR ANG RAMP PCN RQR WAIVER FR OG/CC THRU AFLD MGMT.

MILITARY: ANG: AFLD MGR DOES NOT ISSUE OR STORE COMSEC FOR TRAN CREWS.

MILITARY: ANG: PPR V220-2356.

FUEL: A++ (MIL).

NON-BASED DVRSN ACRS CTC ARPT OPS 860-627-3001 PRIOR TO DIVG & PRVD CO FLT OPS CTC INFO, ACFT TYPE, POB, INTL OR DOM FLT & GND OPS AGRMTS. ONLY 1 INTL ACR JETBRIDGE AVBL FOR PAX.

MILITARY: ARNG: OPR 1200-2030Z++ MON, TUE, FRI; 1200-0400++ WED, THU. 41.9 149.825 335.775 (HAV-OC OPS).

NO DE-ICING AVBL AT ANG.

MILITARY: ANG: NSTD YELLOW AEROSPACE GND EQPT AND FIRE BOTTLE BOXES PAINTED ON ANG RAMP.

RWY 6 DE-ICE PAD CLSD TO ACFT WITH WINGSPAN 171 FT OR GTR EXC WITH FOLLOW-ME ESCORT BY ARPT OPS.

NO TRNG FLTS, NO PLAS, NO TGLS BTN: 2300 – 0700 MON THRU SAT & 2300 – 1200 SUN.

MILITARY: ANG: OPR 1200–2030Z++ MON–FRI (SAT, SUN UTA).

FIXED WING ACFT USE LOW IDLE FOR TAXI, NO ENGINE CHECKS OR POWER RUNS ALLOWED ON THE ARNG RAMP DUE TO POSSIBLE FOD HAZARD.

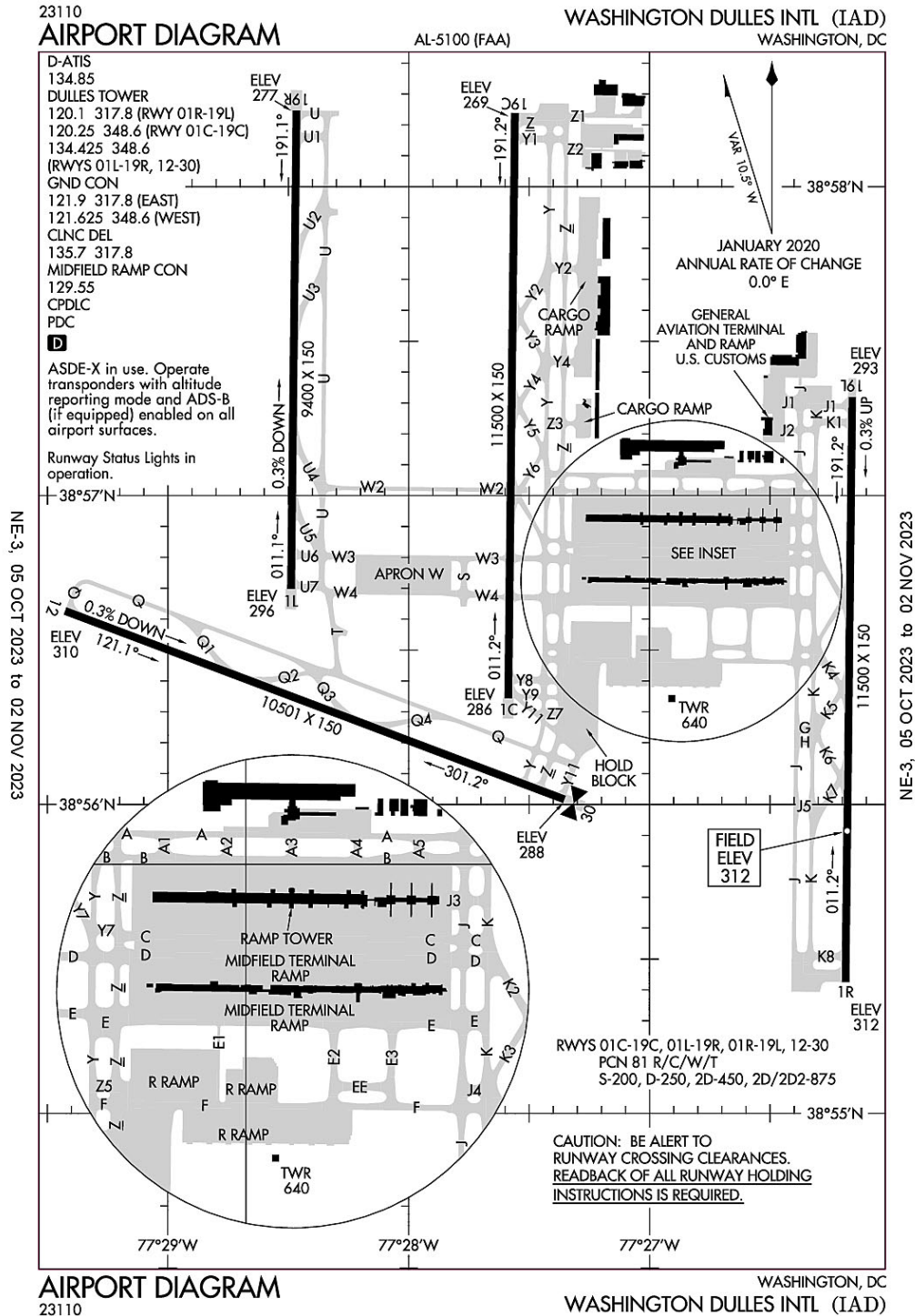
BASH PHASE II INCRD BIRD ACTVTVY SEP–OCT AND MAR–APR.

PARL TWY OPS ON TWY C & TWY B RSTRD TO ACFT WITH WINGSPANS OF 171 FT OR LESS.

(E117) CT ANG AND U.S. ARMY NG.

ACFT REQG US CUST SVCS MUST PARK ON THE CUST SPOT W/ THE NOSE OF THE ACFT FACING SW.  
CTC CUST AT 860–292–1314 WHEN PARKED.

### Washington, District of Columbia Washington Dulles International ICAO Identifier KIAD



**Washington, DC**  
**Washington Dulles Intl**  
**ICAO Identifier KIAD**

**AD 2.2 Aerodrome geographical and administrative data**

- 2.2.1 Reference Point: 38-56-50.843N / 77-27-35.743W
- 2.2.2 From City: 20 miles W of WASHINGTON, VA
- 2.2.3 Elevation: 312.3 ft
- 2.2.5 Magnetic Variation: 10W (2000)
- 2.2.6 Airport Contact: RICHARD GOLINOWSKI  
1 SAARINEN CIRCLE  
DULLES, VA 20166 (703-572-2730)
- 2.2.7 Traffic: IFR/VFR

**AD 2.3 Attendance Schedule**

- 2.3.1 All Months, All Days, All Hours

**AD 2.4 Handling Services and Facilities**

- 2.4.1 Cargo Handling Facilities: YES
- 2.4.2 Fuel Types: 100LL,A
- 2.4.5 Hangar Space: YES
- 2.4.6 Repair Facilities: MAJOR

**AD 2.6 Rescue and Firefighting Services**

- 2.6.1 Aerodrome Category: Class-I certified on 5/1/1973
- 2.6.2 Rescue and Firefighting Services: ARFF Index-E

**AD 2.12 Runway Physical Characteristics**

- 2.12.1 Designation: 19C
- 2.12.2 True Bearing: 181
- 2.12.3 Dimensions: 11500 ft x 150 ft
- 2.12.4 PCN: 81 R/C/W/T
- 2.12.5 Coordinates: 38-58-14.3073N / 77-27-33.5451W
- 2.12.6 Threshold Elevation: 268.6 ft
- 2.12.6 Touchdown Zone Elevation: 271.8 ft

- 2.12.1 Designation: 01C
- 2.12.2 True Bearing: 1
- 2.12.3 Dimensions: 11500 ft x 150 ft
- 2.12.4 PCN: 81 R/C/W/T
- 2.12.5 Coordinates: 38-56-20.6385N / 77-27-35.199W
- 2.12.6 Threshold Elevation: 286.1 ft
- 2.12.6 Touchdown Zone Elevation: 286.1 ft

- 2.12.1 Designation: 01L
- 2.12.2 True Bearing: 1
- 2.12.3 Dimensions: 9400 ft x 150 ft
- 2.12.4 PCN: 81 R/C/W/T
- 2.12.5 Coordinates: 38-56-41.8795N / 77-28-29.3169W
- 2.12.6 Threshold Elevation: 296 ft
- 2.12.6 Touchdown Zone Elevation: 296 ft

2.12.1 Designation: 19R  
2.12.2 True Bearing: 181  
2.12.3 Dimensions: 9400 ft x 150 ft  
2.12.4 PCN: 81 R/C/W/T  
2.12.5 Coordinates: 38-58-14.784N / 77-28-27.984W  
2.12.6 Threshold Elevation: 277 ft  
2.12.6 Touchdown Zone Elevation: 278.3 ft

2.12.1 Designation: 01R  
2.12.2 True Bearing: 1  
2.12.3 Dimensions: 11500 ft x 150 ft  
2.12.4 PCN: 81 R/C/W/T  
2.12.5 Coordinates: 38-55-25.5244N / 77-26-11.2132W  
2.12.6 Threshold Elevation: 311.7 ft  
2.12.6 Touchdown Zone Elevation: 312.3 ft

2.12.1 Designation: 19L  
2.12.2 True Bearing: 181  
2.12.3 Dimensions: 11500 ft x 150 ft  
2.12.4 PCN: 81 R/C/W/T  
2.12.5 Coordinates: 38-57-19.1867N / 77-26-9.5086W  
2.12.6 Threshold Elevation: 293 ft  
2.12.6 Touchdown Zone Elevation: 302 ft

2.12.1 Designation: 30  
2.12.2 True Bearing: 291  
2.12.3 Dimensions: 10501 ft x 150 ft  
2.12.4 PCN: 81 R/C/W/T  
2.12.5 Coordinates: 38-56-0.9996N / 77-27-21.2257W  
2.12.6 Threshold Elevation: 287.6 ft  
2.12.6 Touchdown Zone Elevation: 287.7 ft

2.12.1 Designation: 12  
2.12.2 True Bearing: 111  
2.12.3 Dimensions: 10501 ft x 150 ft  
2.12.4 PCN: 81 R/C/W/T  
2.12.5 Coordinates: 38-56-37.5897N / 77-29-25.5882W  
2.12.6 Threshold Elevation: 309.9 ft  
2.12.6 Touchdown Zone Elevation: 309.9 ft

#### **AD 2.13 Declared Distances**

2.13.1 Designation: 19C  
2.13.2 Take-off Run Available: 11500  
2.13.3 Take-off Distance Available: 11500  
2.13.4 Accelerate-Stop Distance Available: 11500  
2.13.5 Landing Distance Available: 11089

2.13.1 Designation: 01C  
2.13.2 Take-off Run Available: 11500

2.13.3 Take-off Distance Available: 11500  
2.13.4 Accelerate-Stop Distance Available: 11500  
2.13.5 Landing Distance Available: 11500

2.13.1 Designation: 01L  
2.13.2 Take-off Run Available: 9400  
2.13.3 Take-off Distance Available: 9400  
2.13.4 Accelerate-Stop Distance Available: 9400  
2.13.5 Landing Distance Available: 9400

2.13.1 Designation: 19R  
2.13.2 Take-off Run Available: 9400  
2.13.3 Take-off Distance Available: 9400  
2.13.4 Accelerate-Stop Distance Available: 9400  
2.13.5 Landing Distance Available: 9400

2.13.1 Designation: 01R  
2.13.2 Take-off Run Available: 11500  
2.13.3 Take-off Distance Available: 11500  
2.13.4 Accelerate-Stop Distance Available: 11500  
2.13.5 Landing Distance Available: 11500

2.13.1 Designation: 19L  
2.13.2 Take-off Run Available: 11500  
2.13.3 Take-off Distance Available: 11500  
2.13.4 Accelerate-Stop Distance Available: 11500  
2.13.5 Landing Distance Available: 11500

2.13.1 Designation: 30  
2.13.2 Take-off Run Available: 10501  
2.13.3 Take-off Distance Available: 10501  
2.13.4 Accelerate-Stop Distance Available: 10501  
2.13.5 Landing Distance Available: 10501

2.13.1 Designation: 12  
2.13.2 Take-off Run Available: 10501  
2.13.3 Take-off Distance Available: 10501  
2.13.4 Accelerate-Stop Distance Available: 10501  
2.13.5 Landing Distance Available: 10501

#### **AD 2.14 Approach and Runway Lighting**

2.14.1 Designation: 19C  
2.14.2 Approach Lighting System: ALSF2  
2.14.4 Visual Approach Slope Indicator System: P4R

2.14.1 Designation: 01C  
2.14.2 Approach Lighting System: MALSR  
2.14.4 Visual Approach Slope Indicator System: P4L

2.14.1 Designation: 01L

2.14.2 Approach Lighting System: ALSF2  
2.14.4 Visual Approach Slope Indicator System: P4L

2.14.1 Designation: 19R  
2.14.2 Approach Lighting System: ALSF2  
2.14.4 Visual Approach Slope Indicator System: P4L

2.14.1 Designation: 01R  
2.14.2 Approach Lighting System: ALSF2  
2.14.4 Visual Approach Slope Indicator System: P4R

2.14.1 Designation: 19L  
2.14.2 Approach Lighting System: ALSF2  
2.14.4 Visual Approach Slope Indicator System: P4L

2.14.1 Designation: 30  
2.14.2 Approach Lighting System:  
2.14.4 Visual Approach Slope Indicator System: P4L

2.14.1 Designation: 12  
2.14.2 Approach Lighting System: MALSR  
2.14.4 Visual Approach Slope Indicator System: P4R

#### **AD 2.18 Air Traffic Services Communication Facilities**

2.18.1 Service Designation: CD/P  
2.18.3 Channel: 135.7  
2.18.5 Hours of Operation: 24

2.18.1 Service Designation: CD/P  
2.18.3 Channel: 317.8  
2.18.5 Hours of Operation: 24

2.18.1 Service Designation: D-ATIS  
2.18.3 Channel: 134.85  
2.18.5 Hours of Operation: 24

2.18.1 Service Designation: EMERG  
2.18.3 Channel: 121.5  
2.18.5 Hours of Operation:

2.18.1 Service Designation: EMERG  
2.18.3 Channel: 243  
2.18.5 Hours of Operation:

2.18.1 Service Designation: GND/P (WEST)  
2.18.3 Channel: 121.625  
2.18.5 Hours of Operation: 24

2.18.1 Service Designation: GND/P (EAST)  
2.18.3 Channel: 121.9



2.18.5 Hours of Operation: 24

2.18.1 Service Designation: GND/P (EAST)

2.18.3 Channel: 317.8

2.18.5 Hours of Operation: 24

2.18.1 Service Designation: GND/P (WEST)

2.18.3 Channel: 348.6

2.18.5 Hours of Operation: 24

2.18.1 Service Designation: LCL/P (RWY 01R/19L)

2.18.3 Channel: 120.1

2.18.5 Hours of Operation: 24

2.18.1 Service Designation: LCL/P (RWY 01C/19C)

2.18.3 Channel: 120.25

2.18.5 Hours of Operation: 24

2.18.1 Service Designation: LCL/P (RWY 01L/19R, RWY 12/30)

2.18.3 Channel: 134.425

2.18.5 Hours of Operation: 24

2.18.1 Service Designation: LCL/P (RWY 01R/19L)

2.18.3 Channel: 317.8

2.18.5 Hours of Operation: 24

2.18.1 Service Designation: LCL/P (RWY 01C/19C)

2.18.3 Channel: 348.6

2.18.5 Hours of Operation: 24

2.18.1 Service Designation: LCL/P (RWY 01L/19R, RWY 12/30)

2.18.3 Channel: 348.6

2.18.5 Hours of Operation: 24

2.18.1 Service Designation: RAMP CTL (MIDFLD)

2.18.3 Channel: 129.55

2.18.5 Hours of Operation: 24

### **AD 2.19 Radio Navigation and Landing Aids**

2.19.1 ILS Type: Glide Slope for runway 01C. Magnetic variation: 10W

2.19.2 ILS Identification: OSZ

2.19.5 Coordinates: 38-56-31.0626N / 77-27-40.739W

2.19.6 Site Elevation: 281.7 ft

2.19.1 ILS Type: Localizer for runway 01C. Magnetic variation: 10W

2.19.2 ILS Identification: OSZ

2.19.5 Coordinates: 38-58-24.6804N / 77-27-33.3938W

2.19.6 Site Elevation: 263.3 ft

2.19.1 ILS Type: Glide Slope for runway 19C. Magnetic variation: 10W

2.19.2 ILS Identification: DLX  
2.19.5 Coordinates: 38-58-4.1642N / 77-27-37.9988W  
2.19.6 Site Elevation: 264.9 ft

2.19.1 ILS Type: Inner Marker for runway 19C. Magnetic variation: 10W  
2.19.2 ILS Identification: DLX  
2.19.5 Coordinates: 38-58-22.945N / 77-27-33.4229W  
2.19.6 Site Elevation: 263.5 ft

2.19.1 ILS Type: Localizer for runway 19C. Magnetic variation: 10W  
2.19.2 ILS Identification: DLX  
2.19.5 Coordinates: 38-56-14.5833N / 77-27-35.2871W  
2.19.6 Site Elevation: 283.8 ft

2.19.1 ILS Type: DME for runway 01L. Magnetic variation: 10W  
2.19.2 ILS Identification: OIU  
2.19.5 Coordinates: 38-58-25.077N / 77-28-31.1445W  
2.19.6 Site Elevation: 288.2 ft

2.19.1 ILS Type: Glide Slope for runway 01L. Magnetic variation: 10W  
2.19.2 ILS Identification: OIU  
2.19.5 Coordinates: 38-56-52.8758N / 77-28-34.3489W  
2.19.6 Site Elevation: 288.1 ft

2.19.1 ILS Type: Inner Marker for runway 01L. Magnetic variation: 10W  
2.19.2 ILS Identification: OIU  
2.19.5 Coordinates: 38-56-33.3882N / 77-28-29.4318W  
2.19.6 Site Elevation: 298.4 ft

2.19.1 ILS Type: Localizer for runway 01L. Magnetic variation: 10W  
2.19.2 ILS Identification: OIU  
2.19.5 Coordinates: 38-58-24.7952N / 77-28-27.8419W  
2.19.6 Site Elevation: 276.9 ft

2.19.1 ILS Type: DME for runway 19R. Magnetic variation: 10W  
2.19.2 ILS Identification: ISU  
2.19.5 Coordinates: 38-58-25.077N / 77-28-31.1445W  
2.19.6 Site Elevation: 288.2 ft

2.19.1 ILS Type: Glide Slope for runway 19R. Magnetic variation: 10W  
2.19.2 ILS Identification: ISU  
2.19.5 Coordinates: 38-58-4.4532N / 77-28-33.3236W  
2.19.6 Site Elevation: 272 ft

2.19.1 ILS Type: Inner Marker for runway 19R. Magnetic variation: 10W  
2.19.2 ILS Identification: ISU  
2.19.5 Coordinates: 38-58-23.5162N / 77-28-27.8521W  
2.19.6 Site Elevation: 275 ft

2.19.1 ILS Type: Localizer for runway 19R. Magnetic variation: 10W  
2.19.2 ILS Identification: ISU

2.19.5 Coordinates: 38-56-31.869N / 77-28-29.461W

2.19.6 Site Elevation: 298.3 ft

2.19.1 ILS Type: DME for runway 01R. Magnetic variation: 10W

2.19.2 ILS Identification: IAD

2.19.5 Coordinates: 38-55-11.037N / 77-26-8.2071W

2.19.6 Site Elevation: 326.3 ft

2.19.1 ILS Type: Glide Slope for runway 01R. Magnetic variation: 10W

2.19.2 ILS Identification: IAD

2.19.5 Coordinates: 38-55-35.8487N / 77-26-4.7355W

2.19.6 Site Elevation: 306.4 ft

2.19.1 ILS Type: Localizer for runway 01R. Magnetic variation: 10W

2.19.2 ILS Identification: IAD

2.19.5 Coordinates: 38-57-30.8651N / 77-26-9.3346W

2.19.6 Site Elevation: 301.5 ft

2.19.1 ILS Type: DME for runway 19L. Magnetic variation: 10W

2.19.2 ILS Identification: SGC

2.19.5 Coordinates: 38-55-11.037N / 77-26-8.2071W

2.19.6 Site Elevation: 326.3 ft

2.19.1 ILS Type: Glide Slope for runway 19L. Magnetic variation: 10W

2.19.2 ILS Identification: SGC

2.19.5 Coordinates: 38-57-9.2652N / 77-26-4.5983W

2.19.6 Site Elevation: 290.9 ft

2.19.1 ILS Type: Localizer for runway 19L. Magnetic variation: 10W

2.19.2 ILS Identification: SGC

2.19.5 Coordinates: 38-55-11.8054N / 77-26-11.4157W

2.19.6 Site Elevation: 315.1 ft

2.19.1 ILS Type: Glide Slope for runway 12. Magnetic variation: 10W

2.19.2 ILS Identification: AJU

2.19.5 Coordinates: 38-56-30.4069N / 77-29-15.5183W

2.19.6 Site Elevation: 303.4 ft

2.19.1 ILS Type: Localizer for runway 12. Magnetic variation: 10W

2.19.2 ILS Identification: AJU

2.19.5 Coordinates: 38-55-57.2399N / 77-27-8.4716W

2.19.6 Site Elevation: 281 ft

**General Remarks:**

TAXILANE 'C' ACTIVE; PUSHBACK CLNCS ON NORTH SIDE OF MIDFIELD TERMINAL ARE ONTO TAXILANE 'D' ONLY UNLESS OTHERWISE AUTH.

RWY STATUS LGTS ARE IN OPN.

ASDE-X IN USE. OPERATE TRANSPONDERS WITH ALTITUDE REPORTING MODE AND ADS-B (IF EQUIPPED) ENABLED ON ALL AIRPORT SURFACES.

ENGINE RUN-UPS BTW 2200L & 0700L REQUIRE PRIOR APPROVAL FM ARPT OPS.

LARGE FLOCKS OF BIRDS ON & INVOF ARPT/DEER INVOF ARPT.

B747-8 RESTRICTED TO MAXIMUM TAXI SPEED 17 KTS (20 MPH) ON TWY J.

RUNUP BLX FOR RWY 30 DSGND AS NON-MOVEMENT AREA.

RWY 30 DEPARTURES USE UPPER ANTENNA FOR ATC COMMUNICATIONS.

ACR PUSH BACKS & PWR FM ALL APRON PSNS REQUIRE CLNC FM MWAA RAMP TWR.

ALL AIRCRAFT WITH WINGSPAN EXCEEDING 118 FT ARE RESTRICTED FROM USING TAXILANE A BTN A1 & A5.

ALL 180 DEG TURNS OUT OF APRON POSITIONS SHALL BE MADE USING MINIMUM POWER.

TWY E1 RESTRICTED TO ACFT WITH A WINGSPAN LESS THAN 79 FT.

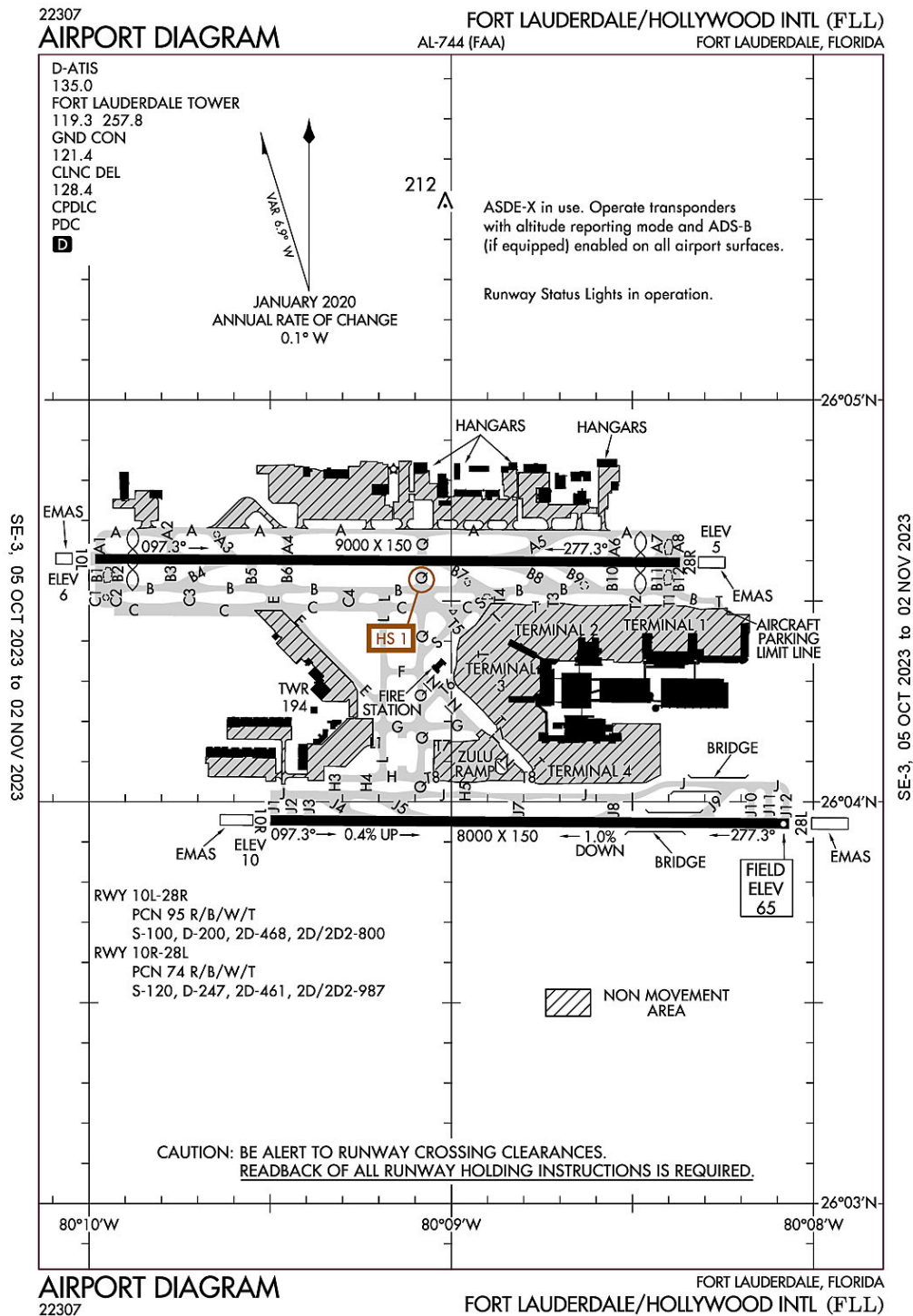
FLIGHT TRAINING BETWEEN 2200-0700 IS PROHIBITED.

DURING PERIODS OF ACFT SATURATION LONG TERM PARKING MAY NOT BE AVAILABLE. SERVICES FOR FUEL AND GO ONLY WILL BE AVAILABLE.

ITNRNT ACFT CTC FBO ON 122.95 OR 129.77 FOR SVCS.

LDG FEE. FLIGHT NOTIFICATION SERVICE (ADCUS) AVBL. NOTE: SEE SPECIAL NOTICES --CONTINUOUS POWER FACILITIES.

**Fort Lauderdale, Florida**  
**Fort Lauderdale-Hollywood International**  
**ICAO Identifier KFLI**



**Fort Lauderdale, FL**  
**Fort Lauderdale/Hollywood Intl**  
**ICAO Identifier KFLL**

**AD 2.2 Aerodrome geographical and administrative data**

- 2.2.1 Reference Point: 26-4-18N / 80-8-58.9W
- 2.2.2 From City: 3 miles SW of FORT LAUDERDALE, FL
- 2.2.3 Elevation: 65 ft
- 2.2.5 Magnetic Variation: 6W (2015)
- 2.2.6 Airport Contact: MARK GALE  
320 TERMINAL DRIVE SUITE 200  
FORT LAUDERDALE, FL 33315 (954-359-6100)
- 2.2.7 Traffic: IFR/VFR

**AD 2.3 Attendance Schedule**

- 2.3.1 All Months, All Days, All Hours

**AD 2.4 Handling Services and Facilities**

- 2.4.1 Cargo Handling Facilities: YES
- 2.4.2 Fuel Types: 100LL,A
- 2.4.5 Hangar Space: YES
- 2.4.6 Repair Facilities: MAJOR

**AD 2.6 Rescue and Firefighting Services**

- 2.6.1 Aerodrome Category: Class-I certified on 5/21/1973
- 2.6.2 Rescue and Firefighting Services: ARFF Index-E

**AD 2.12 Runway Physical Characteristics**

- 2.12.1 Designation: 10L
- 2.12.2 True Bearing: 90
- 2.12.3 Dimensions: 9000 ft x 150 ft
- 2.12.4 PCN: 95 R/B/W/T
- 2.12.5 Coordinates: 26-4-37.0166N / 80-9-59.5381W
- 2.12.6 Threshold Elevation: 5.6 ft
- 2.12.6 Touchdown Zone Elevation: 7.1 ft

- 2.12.1 Designation: 28R
- 2.12.2 True Bearing: 270
- 2.12.3 Dimensions: 9000 ft x 150 ft
- 2.12.4 PCN: 95 R/B/W/T
- 2.12.5 Coordinates: 26-4-36.4507N / 80-8-20.835W
- 2.12.6 Threshold Elevation: 5.3 ft
- 2.12.6 Touchdown Zone Elevation: 6.7 ft

- 2.12.1 Designation: 10R
- 2.12.2 True Bearing: 90
- 2.12.3 Dimensions: 8000 ft x 150 ft
- 2.12.4 PCN: 74 R/B/W/T
- 2.12.5 Coordinates: 26-3-57.1919N / 80-9-30.056W
- 2.12.6 Threshold Elevation: 10.1 ft
- 2.12.6 Touchdown Zone Elevation: 14.3 ft

- 2.12.1 Designation: 28L
- 2.12.2 True Bearing: 270
- 2.12.3 Dimensions: 8000 ft x 150 ft
- 2.12.4 PCN: 74 R/B/W/T
- 2.12.5 Coordinates: 26-3-56.6718N / 80-8-2.3388W
- 2.12.6 Threshold Elevation: 65 ft
- 2.12.6 Touchdown Zone Elevation: 65 ft

**AD 2.13 Declared Distances**

- 2.13.1 Designation: 10L
- 2.13.2 Take-off Run Available: 9000
- 2.13.3 Take-off Distance Available: 9000
- 2.13.4 Accelerate-Stop Distance Available: 9000
- 2.13.5 Landing Distance Available: 8424

- 2.13.1 Designation: 28R
- 2.13.2 Take-off Run Available: 9000
- 2.13.3 Take-off Distance Available: 9000
- 2.13.4 Accelerate-Stop Distance Available: 9000
- 2.13.5 Landing Distance Available: 8394

- 2.13.1 Designation: 10R
- 2.13.2 Take-off Run Available: 8000
- 2.13.3 Take-off Distance Available: 8000
- 2.13.4 Accelerate-Stop Distance Available: 8000
- 2.13.5 Landing Distance Available: 8000

- 2.13.1 Designation: 28L
- 2.13.2 Take-off Run Available: 8000
- 2.13.3 Take-off Distance Available: 8000
- 2.13.4 Accelerate-Stop Distance Available: 8000
- 2.13.5 Landing Distance Available: 8000

**AD 2.14 Approach and Runway Lighting**

- 2.14.1 Designation: 10L
- 2.14.2 Approach Lighting System: MALSR
- 2.14.4 Visual Approach Slope Indicator System: P4L

- 2.14.1 Designation: 28R
- 2.14.2 Approach Lighting System: MALSR
- 2.14.4 Visual Approach Slope Indicator System: P4L

- 2.14.1 Designation: 10R
- 2.14.2 Approach Lighting System: MALSF
- 2.14.4 Visual Approach Slope Indicator System: P4R

- 2.14.1 Designation: 28L
- 2.14.2 Approach Lighting System: MALSF

2.14.4 Visual Approach Slope Indicator System: P4L

**AD 2.18 Air Traffic Services Communication Facilities**

2.18.1 Service Designation: CD PRE TAXI CLNC

2.18.3 Channel: 128.4

2.18.5 Hours of Operation: 24

2.18.1 Service Designation: D-ATIS

2.18.3 Channel: 135

2.18.5 Hours of Operation: 24

2.18.1 Service Designation: GND/P

2.18.3 Channel: 121.4

2.18.5 Hours of Operation: 24

2.18.1 Service Designation: GND/S

2.18.3 Channel: 121.7

2.18.5 Hours of Operation: 24

2.18.1 Service Designation: LCL/P

2.18.3 Channel: 119.3

2.18.5 Hours of Operation: 24

2.18.1 Service Designation: LCL/P

2.18.3 Channel: 257.8

2.18.5 Hours of Operation: 24

2.18.1 Service Designation: LCL/S

2.18.3 Channel: 120.2

2.18.5 Hours of Operation: 24

2.18.1 Service Designation: RAMP CTL (NORTH)

2.18.3 Channel: 118.175

2.18.5 Hours of Operation: 24

2.18.1 Service Designation: RAMP CTL (SOUTH)

2.18.3 Channel: 129.875

2.18.5 Hours of Operation: 24

**AD 2.19 Radio Navigation and Landing Aids**

2.19.1 ILS Type: DME for runway 10L. Magnetic variation: 6W

2.19.2 ILS Identification: LHI

2.19.5 Coordinates: 26-4-40.1757N / 80-8-15.6721W

2.19.6 Site Elevation: 11.3 ft

2.19.1 ILS Type: Glide Slope for runway 10L. Magnetic variation: 6W

2.19.2 ILS Identification: LHI

2.19.5 Coordinates: 26-4-39.6411N / 80-9-42.3329W

2.19.6 Site Elevation: 2.9 ft



2.19.1 ILS Type: Localizer for runway 10L. Magnetic variation: 6W  
2.19.2 ILS Identification: LHI  
2.19.5 Coordinates: 26-4-36.4066N / 80-8-13.1434W  
2.19.6 Site Elevation: 4.3 ft

2.19.1 ILS Type: DME for runway 28R. Magnetic variation: 6W  
2.19.2 ILS Identification: UDL  
2.19.5 Coordinates: 26-4-34.5346N / 80-10-2.4136W  
2.19.6 Site Elevation: 10.4 ft

2.19.1 ILS Type: Glide Slope for runway 28R. Magnetic variation: 6W  
2.19.2 ILS Identification: UDL  
2.19.5 Coordinates: 26-4-39.627N / 80-8-39.0644W  
2.19.6 Site Elevation: 5 ft

2.19.1 ILS Type: Localizer for runway 28R. Magnetic variation: 6W  
2.19.2 ILS Identification: UDL  
2.19.5 Coordinates: 26-4-37.0351N / 80-10-2.8297W  
2.19.6 Site Elevation: 4.6 ft

2.19.1 ILS Type: DME for runway 10R. Magnetic variation: 6W  
2.19.2 ILS Identification: FLL  
2.19.5 Coordinates: 26-3-58.8348N / 80-7-55.7162W  
2.19.6 Site Elevation: 68.3 ft

2.19.1 ILS Type: Glide Slope for runway 10R. Magnetic variation: 6W  
2.19.2 ILS Identification: FLL  
2.19.5 Coordinates: 26-3-53.1134N / 80-9-18.5896W  
2.19.6 Site Elevation: 5.7 ft

2.19.1 ILS Type: Localizer for runway 10R. Magnetic variation: 6W  
2.19.2 ILS Identification: FLL  
2.19.5 Coordinates: 26-3-56.6314N / 80-7-55.5666W  
2.19.6 Site Elevation: 64.4 ft

2.19.1 ILS Type: DME for runway 28L. Magnetic variation: 6W  
2.19.2 ILS Identification: ADI  
2.19.5 Coordinates: 26-3-59.4802N / 80-9-40.4489W  
2.19.6 Site Elevation: 14.7 ft

2.19.1 ILS Type: Glide Slope for runway 28L. Magnetic variation: 6W  
2.19.2 ILS Identification: ADI  
2.19.5 Coordinates: 26-3-52.7404N / 80-8-15.5298W  
2.19.6 Site Elevation: 45 ft

2.19.1 ILS Type: Localizer for runway 28L. Magnetic variation: 6W  
2.19.2 ILS Identification: ADI  
2.19.5 Coordinates: 26-3-57.2361N / 80-9-37.7655W  
2.19.6 Site Elevation: 7.5 ft

2.19.1 Navigation Aid Type: VOR/DME. Magnetic variation: 6W

2.19.2 Navigation Aid Identification: FLL

2.19.5 Coordinates: 26-4-26.1833N / 80-9-59.1921W

2.19.6 Site Elevation: 5.6 ft

**General Remarks:**

PPR FOR ACFT WITH EXPLOSIVES.

ASDE-X IN USE; OPR PARROT WITH ALT RPRTG MODE & ADS-B (IF EQUIPPED) ENABLED ON ARPT SFCS.

TWY E BTN TWY C & TWY L CLSD TO ACFT WINGSPAN MORE THAN 118 FT EXC 10 MIN PPR 954-816-3179.

ARR FM N & W MNTN 6000 FT UNTIL ABM RWY 28R ON DOWNWIND; ARR FM N MNTN 6000 FT UNTIL ABM RWY 10L ON DOWNWIND.

EAST SIDE OF CONCOURSE B AVBL TO ACFT WITH WINGSPAN LESS THAN 124.9 FT.

ALL RWYS NOISE SENSITIVE; NOISE ABATEMENT IN EFCT - 954-359-6181.

RWY STATUS LIGHTS IN OPRN.

NO VFR APCHS OR BASE LEGS UNTIL OFFSHORE.

TURB BLW 1000 FT OVR LANDFILL LCTD 2 NM W.

JET RUNUPS NA 2300-0700.

ACFT OPRG FROM TRML 1, 2, 3, 4 MUST CTC RAMP CTL. RAMP CTL EFF - CTC ARPT OPS FOR HRS.

IR CARRIER ACFT USE RAMP PUSH BACK PROCS PRESCRIBED BY ARPT OPS.

TWY J BGN TO ELEV 900 FT EAST OF TWY Q. DUE TO ELEV ALL ACFT REMAIN ON CNTRLN; TWY T8 & TAXILANE T NOT ACCESSIBLE FM TWY J.

ACFT LDG RWY 10R & EXITING J9 FOLLOW TWY LEAD OFF LINE ONTO J9.

NMRS TREES SW QUADRANT OF ARPT.

BIRDS ON & INVOF ARPT; CONCENTRATION OF BIRDS BLW 500 FT 2.0 NM W OF 10L & 10R AER.

CLSD TO ACR TRAINING; LRG ACFT TRNG OVER 58000 LBS MAX CERTD GROSS TKOF WEIGHT; ALL TRNG 2300-0700.

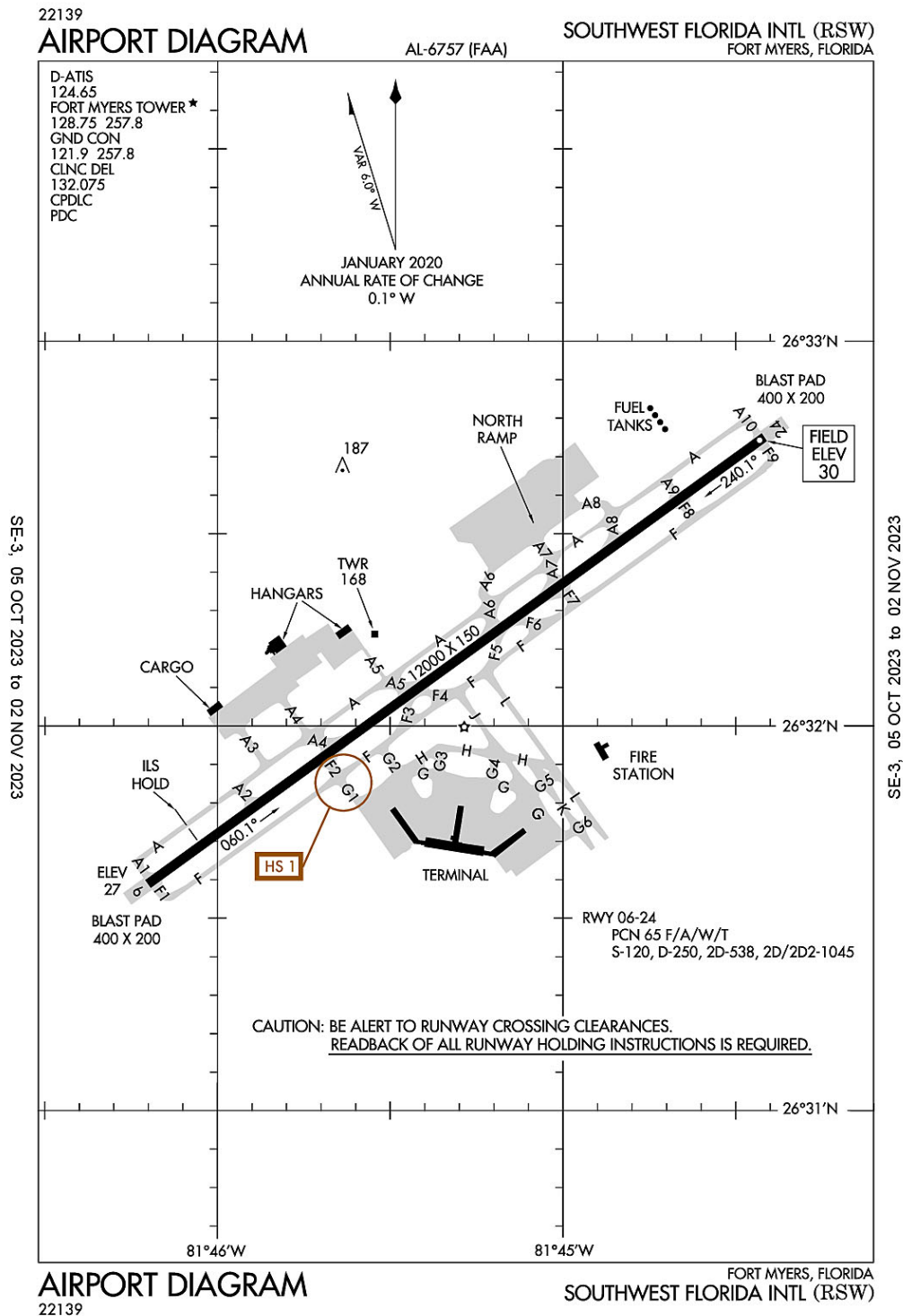
PREFERENTIAL RWY USE PROGRAM IN EFCT; CTC NOISE ABATEMENT OFFICE.

TWY B EAST OF TWY B12 & TAXILANE T EAST OF TWY T1 CLSD TO ACFT WITH WINGSPAN GTR THAN 118 FT & TAIL HGT GTR THAN 45 FT. TWY A BTN TWY A2 & TWY A3 CLSD TO ACFT WINGSPAN MORE THAN 170 FT & TAIL HGT MORE THAN 59 FT EXC 10 MIN PPR 954-816-3179.

PPR FOR ACFT WITH WINGSPAN GTR THAN 171 FT & TAIL HGT GTR THAN 60 FT ON TWY N BTWN TWY Q & TWY T6

HIGH LIGHT MASTS WNW APCH END RWY 28L.

### Fort Myers, Florida Southwest Florida International ICAO Identifier KRSW



**Fort Myers, FL**  
**Southwest Florida Intl**  
**ICAO Identifier KRSW**

**AD 2.2 Aerodrome geographical and administrative data**

- 2.2.1 Reference Point: 26-32-10.19N / 81-45-18.558W
- 2.2.2 From City: 10 miles SE of FORT MYERS, FL
- 2.2.3 Elevation: 29.9 ft
- 2.2.5 Magnetic Variation: 4W (2000)
- 2.2.6 Airport Contact: BEN SIEGEL  
11000 TERMINAL ACCESS RD.  
FORT MYERS, FL 33913 (239-590-4400)
- 2.2.7 Traffic: IFR/VFR

**AD 2.3 Attendance Schedule**

- 2.3.1 All Months, All Days, 0700-0100 Hours

**AD 2.4 Handling Services and Facilities**

- 2.4.1 Cargo Handling Facilities: YES
- 2.4.2 Fuel Types: 100LL,A,A+
- 2.4.5 Hangar Space: YES
- 2.4.6 Repair Facilities: MAJOR

**AD 2.6 Rescue and Firefighting Services**

- 2.6.1 Aerodrome Category: Class-I certified on 5/1/1983
- 2.6.2 Rescue and Firefighting Services: ARFF Index-D

**AD 2.12 Runway Physical Characteristics**

- 2.12.1 Designation: 24
- 2.12.2 True Bearing: 234
- 2.12.3 Dimensions: 12000 ft x 150 ft
- 2.12.4 PCN: 65 F/A/W/T
- 2.12.5 Coordinates: 26-32-45.0262N / 81-44-25.0374W
- 2.12.6 Threshold Elevation: 29.8 ft
- 2.12.6 Touchdown Zone Elevation: 29.9 ft

- 2.12.1 Designation: 06
- 2.12.2 True Bearing: 54
- 2.12.3 Dimensions: 12000 ft x 150 ft
- 2.12.4 PCN: 65 F/A/W/T
- 2.12.5 Coordinates: 26-31-35.3489N / 81-46-12.0692W
- 2.12.6 Threshold Elevation: 26.6 ft
- 2.12.6 Touchdown Zone Elevation: 27 ft

**AD 2.13 Declared Distances**

- 2.13.1 Designation: 24
- 2.13.2 Take-off Run Available:
- 2.13.3 Take-off Distance Available:
- 2.13.4 Accelerate-Stop Distance Available:
- 2.13.5 Landing Distance Available:

- 2.13.1 Designation: 06
- 2.13.2 Take-off Run Available:
- 2.13.3 Take-off Distance Available:
- 2.13.4 Accelerate-Stop Distance Available:
- 2.13.5 Landing Distance Available:

**AD 2.14 Approach and Runway Lighting**

- 2.14.1 Designation: 24
- 2.14.2 Approach Lighting System:
- 2.14.4 Visual Approach Slope Indicator System: P4L

- 2.14.1 Designation: 06
- 2.14.2 Approach Lighting System: MALSR
- 2.14.4 Visual Approach Slope Indicator System: P4L

**AD 2.18 Air Traffic Services Communication Facilities**

- 2.18.1 Service Designation: ALICO DP (RWY 06)
- 2.18.3 Channel: 126.8
- 2.18.5 Hours of Operation: 0600-0000

- 2.18.1 Service Designation: ALICO DP (RWY 24)
- 2.18.3 Channel: 134.425
- 2.18.5 Hours of Operation: 0600-0000

- 2.18.1 Service Designation: ALICO DP (RWY 06/24)
- 2.18.3 Channel: 306.2
- 2.18.5 Hours of Operation: 0600-0000

- 2.18.1 Service Designation: APCH/P DEP/P (121-240)
- 2.18.3 Channel: 124.125
- 2.18.5 Hours of Operation: 0600-0000

- 2.18.1 Service Designation: APCH/P DEP/P (001-120)
- 2.18.3 Channel: 126.8
- 2.18.5 Hours of Operation: 0600-0000

- 2.18.1 Service Designation: APCH/P DEP/P (301-360)
- 2.18.3 Channel: 127.05
- 2.18.5 Hours of Operation: 0600-0000

- 2.18.1 Service Designation: APCH/P DEP/P (241-300)
- 2.18.3 Channel: 134.425
- 2.18.5 Hours of Operation: 0600-0000

- 2.18.1 Service Designation: APCH/P DEP/P (241-120)
- 2.18.3 Channel: 306.2
- 2.18.5 Hours of Operation: 0600-0000

2.18.1 Service Designation: APCH/P DEP/P (121-240)  
2.18.3 Channel: 371.85  
2.18.5 Hours of Operation: 0600-0000

2.18.1 Service Designation: APCH/P DEP/P IC  
2.18.3 Channel: 306.2  
2.18.5 Hours of Operation: 0600-0000

2.18.1 Service Designation: APCH/P IC (RWY 06)  
2.18.3 Channel: 125.15  
2.18.5 Hours of Operation: 0600-0000

2.18.1 Service Designation: APCH/P IC (RWY 24)  
2.18.3 Channel: 126.8  
2.18.5 Hours of Operation: 0600-0000

2.18.1 Service Designation: CD/P  
2.18.3 Channel: 132.075  
2.18.5 Hours of Operation: 0600-0000

2.18.1 Service Designation: CLASS C (121-240)  
2.18.3 Channel: 124.125  
2.18.5 Hours of Operation: 0600-0000

2.18.1 Service Designation: CLASS C (001-120)  
2.18.3 Channel: 126.8  
2.18.5 Hours of Operation: 0600-0000

2.18.1 Service Designation: CLASS C (301-360)  
2.18.3 Channel: 127.05  
2.18.5 Hours of Operation: 0600-0000

2.18.1 Service Designation: CLASS C (241-300)  
2.18.3 Channel: 134.425  
2.18.5 Hours of Operation: 0600-0000

2.18.1 Service Designation: CLASS C (241-120)  
2.18.3 Channel: 306.2  
2.18.5 Hours of Operation: 0600-0000

2.18.1 Service Designation: CLASS C (121-240)  
2.18.3 Channel: 371.85  
2.18.5 Hours of Operation: 0600-0000

2.18.1 Service Designation: CSHEL DP (RWY 06)  
2.18.3 Channel: 126.8  
2.18.5 Hours of Operation: 0600-0000

2.18.1 Service Designation: CSHEL DP (RWY 24)  
2.18.3 Channel: 134.425  
2.18.5 Hours of Operation: 0600-0000

2.18.1 Service Designation: CSHEL DP (RWY 06/24)  
2.18.3 Channel: 306.2  
2.18.5 Hours of Operation: 0600-0000

2.18.1 Service Designation: D-ATIS  
2.18.3 Channel: 124.65  
2.18.5 Hours of Operation: 24

2.18.1 Service Designation: GND/P  
2.18.3 Channel: 121.9  
2.18.5 Hours of Operation: 0600-0000

2.18.1 Service Designation: GND/P  
2.18.3 Channel: 257.8  
2.18.5 Hours of Operation: 0600-0000

2.18.1 Service Designation: JOSFF STAR  
2.18.3 Channel: 134.425  
2.18.5 Hours of Operation: 0600-0000

2.18.1 Service Designation: JOSFF STAR  
2.18.3 Channel: 306.2  
2.18.5 Hours of Operation: 0600-0000

2.18.1 Service Designation: LCL/P  
2.18.3 Channel: 128.75  
2.18.5 Hours of Operation: 0600-0000

2.18.1 Service Designation: LCL/P  
2.18.3 Channel: 257.8  
2.18.5 Hours of Operation: 0600-0000

2.18.1 Service Designation: MOOKY DP (RWY 06)  
2.18.3 Channel: 124.125  
2.18.5 Hours of Operation: 0600-0000

2.18.1 Service Designation: MOOKY DP (RWY 24)  
2.18.3 Channel: 134.425  
2.18.5 Hours of Operation: 0600-0000

2.18.1 Service Designation: MOOKY DP (RWY 24)  
2.18.3 Channel: 306.2  
2.18.5 Hours of Operation: 0600-0000

2.18.1 Service Designation: MOOKY DP (RWY 06)  
2.18.3 Channel: 371.85  
2.18.5 Hours of Operation: 0600-0000

2.18.1 Service Designation: SCUBY DP  
2.18.3 Channel: 124.125

2.18.5 Hours of Operation: 0600-0000

2.18.1 Service Designation: SCUBY DP

2.18.3 Channel: 371.85

2.18.5 Hours of Operation: 0600-0000

2.18.1 Service Designation: SHFTY STAR

2.18.3 Channel: 126.8

2.18.5 Hours of Operation: 0600-0000

2.18.1 Service Designation: TYNEE STAR

2.18.3 Channel: 134.425

2.18.5 Hours of Operation: 0600-0000

2.18.1 Service Designation: TYNEE STAR

2.18.3 Channel: 306.2

2.18.5 Hours of Operation: 0600-0000

#### **AD 2.19 Radio Navigation and Landing Aids**

2.19.1 ILS Type: DME for runway 06. Magnetic variation: 4W

2.19.2 ILS Identification: RSW

2.19.5 Coordinates: 26-32-53.339N / 81-44-17.5144W

2.19.6 Site Elevation: 38 ft

2.19.1 ILS Type: Glide Slope for runway 06. Magnetic variation: 4W

2.19.2 ILS Identification: RSW

2.19.5 Coordinates: 26-31-43.5444N / 81-46-4.4222W

2.19.6 Site Elevation: 25.2 ft

2.19.1 ILS Type: Localizer for runway 06. Magnetic variation: 4W

2.19.2 ILS Identification: RSW

2.19.5 Coordinates: 26-32-51.1355N / 81-44-15.6428W

2.19.6 Site Elevation: 27.6 ft

2.19.1 Navigation Aid Type: VORTAC. Magnetic variation: 2W

2.19.2 Navigation Aid Identification: RSW

2.19.5 Coordinates: 26-31-47.5921N / 81-46-32.7666W

2.19.6 Site Elevation: 24.8 ft

#### **General Remarks:**

ACR USE RAMP PROC PRESCRIBED BY ARPT OPS.

CAUTION: OPEN BAGGAGE BAYS & CONST WITHIN TERMINAL RAMP AREA. AIRCREWS USE MINIMUM THRUST SETTINGS IN THESE AREAS, SPCLY DURG SINGLE ENG TAXI. CROSS-BLEED STARTS ONLY ALLOWED AFT REACHING THE TUG RELEASE POINT.

TWY A5 BTN FBO RAMP AND TWY A CLSD TO ACFT WINGSPAN MORE THAN 118 FT.

FOR CD IFUN TO CTC ON MIAMI CTR FREQ, CTC MIAMI ARTCC AT 305-716-1731 (0100-0700).

GND CLNC RQRD PRIOR TO ENTERING TWY G.



OPERATE TRANSPONDERS WITH ALTITUDE REPORTING MODE AND ADS-B (IF EQUIPPED) ENABLED ON ALL AIRPORT SURFACES.

DEP ACFT OBTAIN APVL FM GND CTL PRIOR TO PUSHBACK FM GATES B7, B9, C8, C9 & D10A. PILOTS ADVISE TUG OPR OF OBTAINED CLNC FM GND CTL PRIOR TO ENTERING TWY G. DEP CTC GND CTL PRIOR TO LEAVING THE COMMUTER RAMP FROM GATES D9A & D9B.

GATES B7 & B9 EXP CALL SPOT #7. GATES C8 & C9 EXP CALL SPOT #4. GATE D10A EXP CALL SPOT #2.

LGTS ON PARALLEL ROAD & PARKING LOT NW OF RWY 06/24 CAN BE MISTAKEN FOR RWY & APCH ENVIRONMENT.

ALL ACFT ON RAMP EXP CLOCKWISE FLOW. OUTBOUND TRAFFIC FROM GATES D2, D4, D6, D8 & D10 PROCEED TO CALL SPOT 1; OUTBOUND TRAFFIC FROM GATES C2, C4, C6, D1, D3, D5 & D7 PROCEED TO CALL SPOT 3; OUTBOUND TRAFFIC FROM GATES B2, B4, B6, B8, C1, C3, C5 & C7 PROCEED TO CALL SPOT 5; OUTBOUND TRAFFIC FROM GATES B1, B3 & B5 PROCEED TO CALL SPOT 9; ALL OUTBOUND TRAFFIC REQUEST TAXI INSTRUCTIONS.

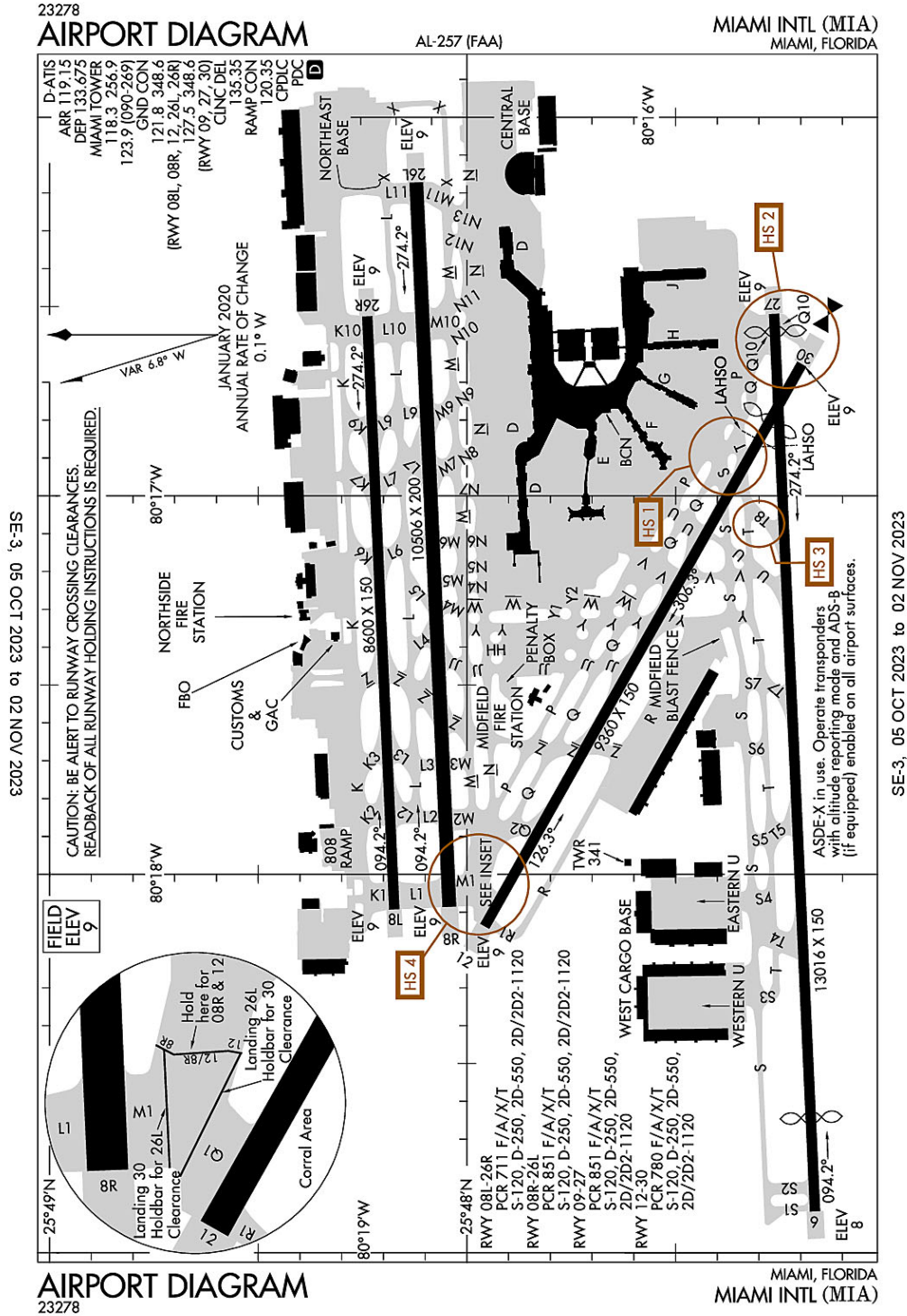
NO HELI OPS PERMITTED ON TRML APRON.

TFC PROCD DRCTLY TO GATE UNLESS DRCTD BY ATC; ADVISE ATC IF GATE IS NOT AVBL.

CAUTION: GS ANT 130 FT SW OF TWY A CNTRLN BTN TWY A1 & TWY A2.

RWY USE PROGRAM IN EFFECT; USE DISTANT NOISE ABATEMENT DEP PROFILE. VISUAL APCH TO RWY 06 W OF FORT MYERS BEACH MAINTAIN 3000 FT UNTIL CROSSING SHORELINE 12 NM SW OF ARPT. RWY 24 PREFERRED BTN 2200-0600. FOR NOISE ABATEMENT PROC CTC AMGR.

**Miami, Florida**  
**Miami International**  
**ICAO Identifier KMIA**



SE-3, 05 OCT 2023 to 02 NOV 2023

SE-3, 05 OCT 2023 to 02 NOV 2023

**Miami, FL**  
**Miami Intl**  
**ICAO Identifier KMIA**

**AD 2.2 Aerodrome geographical and administrative data**

- 2.2.1 Reference Point: 25-47-43.3N / 80-17-24.417W
- 2.2.2 From City: 8 miles NW of MIAMI, FL
- 2.2.3 Elevation: 9.3 ft
- 2.2.5 Magnetic Variation: 5W (2000)
- 2.2.6 Airport Contact: RALPH CUTIE  
MIAMI-DADE AVIATION DEPARTMENT  
MIAMI, FL 33102 (305-876-7038)
- 2.2.7 Traffic: IFR/VFR

**AD 2.3 Attendance Schedule**

- 2.3.1 All Months, All Days, All Hours

**AD 2.4 Handling Services and Facilities**

- 2.4.1 Cargo Handling Facilities: YES
- 2.4.2 Fuel Types: 100,A
- 2.4.5 Hangar Space: YES
- 2.4.6 Repair Facilities: MAJOR

**AD 2.6 Rescue and Firefighting Services**

- 2.6.1 Aerodrome Category: Class-I certified on 5/1/1973
- 2.6.2 Rescue and Firefighting Services: ARFF Index-E

**AD 2.12 Runway Physical Characteristics**

- 2.12.1 Designation: 26R
- 2.12.2 True Bearing: 267
- 2.12.3 Dimensions: 8600 ft x 150 ft
- 2.12.4 PCN:
- 2.12.5 Coordinates: 25-48-14.3204N / 80-16-31.5499W
- 2.12.6 Threshold Elevation: 8.8 ft
- 2.12.6 Touchdown Zone Elevation: 9 ft

- 2.12.1 Designation: 08L
- 2.12.2 True Bearing: 87
- 2.12.3 Dimensions: 8600 ft x 150 ft
- 2.12.4 PCN:
- 2.12.5 Coordinates: 25-48-10.432N / 80-18-5.5508W
- 2.12.6 Threshold Elevation: 8.9 ft
- 2.12.6 Touchdown Zone Elevation: 9.1 ft

- 2.12.1 Designation: 08R
- 2.12.2 True Bearing: 87
- 2.12.3 Dimensions: 10506 ft x 200 ft
- 2.12.4 PCN:
- 2.12.5 Coordinates: 25-48-2.5177N / 80-18-5.1588W
- 2.12.6 Threshold Elevation: 8.5 ft
- 2.12.6 Touchdown Zone Elevation: 9.1 ft

2.12.1 Designation: 26L  
2.12.2 True Bearing: 267  
2.12.3 Dimensions: 10506 ft x 200 ft  
2.12.4 PCN:  
2.12.5 Coordinates: 25-48-7.2652N / 80-16-10.3282W  
2.12.6 Threshold Elevation: 8.9 ft  
2.12.6 Touchdown Zone Elevation: 9 ft

2.12.1 Designation: 09  
2.12.2 True Bearing: 87  
2.12.3 Dimensions: 13016 ft x 150 ft  
2.12.4 PCN:  
2.12.5 Coordinates: 25-47-9.9421N / 80-18-53.4173W  
2.12.6 Threshold Elevation: 8.1 ft  
2.12.6 Touchdown Zone Elevation: 8.2 ft

2.12.1 Designation: 27  
2.12.2 True Bearing: 267  
2.12.3 Dimensions: 13016 ft x 150 ft  
2.12.4 PCN:  
2.12.5 Coordinates: 25-47-15.8328N / 80-16-31.1711W  
2.12.6 Threshold Elevation: 9 ft  
2.12.6 Touchdown Zone Elevation: 9.1 ft

2.12.1 Designation: 30  
2.12.2 True Bearing: 299  
2.12.3 Dimensions: 9360 ft x 150 ft  
2.12.4 PCN:  
2.12.5 Coordinates: 25-47-11.8224N / 80-16-39.0805W  
2.12.6 Threshold Elevation: 8.7 ft  
2.12.6 Touchdown Zone Elevation: 9.3 ft

2.12.1 Designation: 12  
2.12.2 True Bearing: 119  
2.12.3 Dimensions: 9360 ft x 150 ft  
2.12.4 PCN:  
2.12.5 Coordinates: 25-47-57.4262N / 80-18-8.2439W  
2.12.6 Threshold Elevation: 9.1 ft  
2.12.6 Touchdown Zone Elevation: 9.2 ft

**AD 2.13 Declared Distances**

2.13.1 Designation: 26R  
2.13.2 Take-off Run Available: 8600  
2.13.3 Take-off Distance Available: 8600  
2.13.4 Accelerate-Stop Distance Available: 8600  
2.13.5 Landing Distance Available: 8600

2.13.1 Designation: 08L  
2.13.2 Take-off Run Available: 8600

2.13.3 Take-off Distance Available: 8600  
2.13.4 Accelerate-Stop Distance Available: 8600  
2.13.5 Landing Distance Available: 8600

2.13.1 Designation: 08R  
2.13.2 Take-off Run Available: 10506  
2.13.3 Take-off Distance Available: 10506  
2.13.4 Accelerate-Stop Distance Available: 10506  
2.13.5 Landing Distance Available: 10506

2.13.1 Designation: 26L  
2.13.2 Take-off Run Available: 10506  
2.13.3 Take-off Distance Available: 10506  
2.13.4 Accelerate-Stop Distance Available: 10220  
2.13.5 Landing Distance Available: 10220

2.13.1 Designation: 09  
2.13.2 Take-off Run Available: 13016  
2.13.3 Take-off Distance Available: 13016  
2.13.4 Accelerate-Stop Distance Available: 12755  
2.13.5 Landing Distance Available: 11397

2.13.1 Designation: 27  
2.13.2 Take-off Run Available: 13016  
2.13.3 Take-off Distance Available: 13016  
2.13.4 Accelerate-Stop Distance Available: 13016  
2.13.5 Landing Distance Available: 12755

2.13.1 Designation: 30  
2.13.2 Take-off Run Available: 9355  
2.13.3 Take-off Distance Available: 9355  
2.13.4 Accelerate-Stop Distance Available: 8853  
2.13.5 Landing Distance Available: 7913

2.13.1 Designation: 12  
2.13.2 Take-off Run Available: 9355  
2.13.3 Take-off Distance Available: 9355  
2.13.4 Accelerate-Stop Distance Available: 8579  
2.13.5 Landing Distance Available: 8579

**AD 2.14 Approach and Runway Lighting**

2.14.1 Designation: 26R  
2.14.2 Approach Lighting System:  
2.14.4 Visual Approach Slope Indicator System: P4L

2.14.1 Designation: 08L  
2.14.2 Approach Lighting System:  
2.14.4 Visual Approach Slope Indicator System: P4L

2.14.1 Designation: 08R

2.14.2 Approach Lighting System: MALSR  
2.14.4 Visual Approach Slope Indicator System: P4L

2.14.1 Designation: 26L  
2.14.2 Approach Lighting System: MALSF  
2.14.4 Visual Approach Slope Indicator System: P4L

2.14.1 Designation: 09  
2.14.2 Approach Lighting System: MALSR  
2.14.4 Visual Approach Slope Indicator System: P4L

2.14.1 Designation: 27  
2.14.2 Approach Lighting System: MALSR  
2.14.4 Visual Approach Slope Indicator System: P4L

2.14.1 Designation: 30  
2.14.2 Approach Lighting System: MALS  
2.14.4 Visual Approach Slope Indicator System: P4L

2.14.1 Designation: 12  
2.14.2 Approach Lighting System: MALSR  
2.14.4 Visual Approach Slope Indicator System: P4R

**AD 2.18 Air Traffic Services Communication Facilities**

2.18.1 Service Designation: ALTNN DP  
2.18.3 Channel: 119.45  
2.18.5 Hours of Operation: 24

2.18.1 Service Designation: ALTNN DP  
2.18.3 Channel: 119.45  
2.18.5 Hours of Operation: 24

2.18.1 Service Designation: ALTNN DP  
2.18.3 Channel: 290.325  
2.18.5 Hours of Operation: 24

2.18.1 Service Designation: ALTNN DP  
2.18.3 Channel: 290.325  
2.18.5 Hours of Operation: 24

2.18.1 Service Designation: ANNEY STAR  
2.18.3 Channel: 125.75  
2.18.5 Hours of Operation: 24

2.18.1 Service Designation: ANNEY STAR  
2.18.3 Channel: 125.75  
2.18.5 Hours of Operation: 24

2.18.1 Service Designation: ANNEY STAR  
2.18.3 Channel: 322.3

2.18.5 Hours of Operation: 24

2.18.1 Service Designation: ANNEY STAR

2.18.3 Channel: 322.3

2.18.5 Hours of Operation: 24

2.18.1 Service Designation: APCH/P DEP/P (090-269)

2.18.3 Channel: 120.5

2.18.5 Hours of Operation: 24

2.18.1 Service Designation: APCH/P DEP/P (090-269)

2.18.3 Channel: 120.5

2.18.5 Hours of Operation: 24

2.18.1 Service Designation: APCH/P DEP/P (270-089)

2.18.3 Channel: 125.75

2.18.5 Hours of Operation: 24

2.18.1 Service Designation: APCH/P DEP/P (270-089)

2.18.3 Channel: 125.75

2.18.5 Hours of Operation: 24

2.18.1 Service Designation: APCH/P DEP/P (090-269)

2.18.3 Channel: 379.9

2.18.5 Hours of Operation: 24

2.18.1 Service Designation: APCH/P DEP/P (090-269)

2.18.3 Channel: 379.9

2.18.5 Hours of Operation: 24

2.18.1 Service Designation: APCH/P IC (270-089)

2.18.3 Channel: 124.85

2.18.5 Hours of Operation: 24

2.18.1 Service Designation: APCH/P IC (270-089)

2.18.3 Channel: 124.85

2.18.5 Hours of Operation: 24

2.18.1 Service Designation: APCH/P IC (270-089)

2.18.3 Channel: 322.3

2.18.5 Hours of Operation: 24

2.18.1 Service Designation: APCH/P IC (270-089)

2.18.3 Channel: 322.3

2.18.5 Hours of Operation: 24

2.18.1 Service Designation: APCH/S

2.18.3 Channel: 125.75

2.18.5 Hours of Operation: 24

2.18.1 Service Designation: APCH/S

2.18.3 Channel: 125.75  
2.18.5 Hours of Operation: 24

2.18.1 Service Designation: APCH/S (270-089)  
2.18.3 Channel: 263.025  
2.18.5 Hours of Operation: 24

2.18.1 Service Designation: APCH/S (270-089)  
2.18.3 Channel: 263.025  
2.18.5 Hours of Operation: 24

2.18.1 Service Designation: BLUFI STAR  
2.18.3 Channel: 125.75  
2.18.5 Hours of Operation: 24

2.18.1 Service Designation: BLUFI STAR  
2.18.3 Channel: 125.75  
2.18.5 Hours of Operation: 24

2.18.1 Service Designation: BLUFI STAR  
2.18.3 Channel: 322.3  
2.18.5 Hours of Operation: 24

2.18.1 Service Designation: BLUFI STAR  
2.18.3 Channel: 322.3  
2.18.5 Hours of Operation: 24

2.18.1 Service Designation: BNFSH STAR  
2.18.3 Channel: 124.85  
2.18.5 Hours of Operation: 24

2.18.1 Service Designation: BNFSH STAR  
2.18.3 Channel: 124.85  
2.18.5 Hours of Operation: 24

2.18.1 Service Designation: BNFSH STAR  
2.18.3 Channel: 263.025  
2.18.5 Hours of Operation: 24

2.18.1 Service Designation: BNFSH STAR  
2.18.3 Channel: 263.025  
2.18.5 Hours of Operation: 24

2.18.1 Service Designation: BNGOS DP  
2.18.3 Channel: 119.45  
2.18.5 Hours of Operation: 24

2.18.1 Service Designation: BNGOS DP  
2.18.3 Channel: 119.45  
2.18.5 Hours of Operation: 24



2.18.1 Service Designation: BNGOS DP  
2.18.3 Channel: 290.325  
2.18.5 Hours of Operation: 24

2.18.1 Service Designation: BNGOS DP  
2.18.3 Channel: 290.325  
2.18.5 Hours of Operation: 24

2.18.1 Service Designation: CD/P  
2.18.3 Channel: 135.35  
2.18.5 Hours of Operation: 24

2.18.1 Service Designation: CD/P  
2.18.3 Channel: 135.35  
2.18.5 Hours of Operation: 24

2.18.1 Service Designation: CLASS B (090-269)  
2.18.3 Channel: 120.5  
2.18.5 Hours of Operation: 24

2.18.1 Service Designation: CLASS B (090-269)  
2.18.3 Channel: 120.5  
2.18.5 Hours of Operation: 24

2.18.1 Service Designation: CLASS B (270-089)  
2.18.3 Channel: 125.75  
2.18.5 Hours of Operation: 24

2.18.1 Service Designation: CLASS B (270-089)  
2.18.3 Channel: 125.75  
2.18.5 Hours of Operation: 24

2.18.1 Service Designation: CLASS B (270-089)  
2.18.3 Channel: 322.3  
2.18.5 Hours of Operation: 24

2.18.1 Service Designation: CLASS B (270-089)  
2.18.3 Channel: 322.3  
2.18.5 Hours of Operation: 24

2.18.1 Service Designation: CLASS B (090-269)  
2.18.3 Channel: 379.9  
2.18.5 Hours of Operation: 24

2.18.1 Service Designation: CLASS B (090-269)  
2.18.3 Channel: 379.9  
2.18.5 Hours of Operation: 24

2.18.1 Service Designation: CSTAL STAR  
2.18.3 Channel: 124.85  
2.18.5 Hours of Operation: 24

2.18.1 Service Designation: CSTAL STAR  
2.18.3 Channel: 124.85  
2.18.5 Hours of Operation: 24

2.18.1 Service Designation: CSTAL STAR  
2.18.3 Channel: 263.025  
2.18.5 Hours of Operation: 24

2.18.1 Service Designation: CSTAL STAR  
2.18.3 Channel: 263.025  
2.18.5 Hours of Operation: 24

2.18.1 Service Designation: D-ATIS (ARRIVAL)  
2.18.3 Channel: 119.15  
2.18.5 Hours of Operation: 24

2.18.1 Service Designation: D-ATIS (ARRIVAL)  
2.18.3 Channel: 119.15  
2.18.5 Hours of Operation: 24

2.18.1 Service Designation: D-ATIS (DEPART)  
2.18.3 Channel: 133.675  
2.18.5 Hours of Operation: 24

2.18.1 Service Designation: D-ATIS (DEPART)  
2.18.3 Channel: 133.675  
2.18.5 Hours of Operation: 24

2.18.1 Service Designation: DEP/P (090-269)  
2.18.3 Channel: 125.5  
2.18.5 Hours of Operation: 24

2.18.1 Service Designation: DEP/P (090-269)  
2.18.3 Channel: 125.5  
2.18.5 Hours of Operation: 24

2.18.1 Service Designation: DEP/P (270-089)  
2.18.3 Channel: 290.325  
2.18.5 Hours of Operation: 24

2.18.1 Service Designation: DEP/P (270-089)  
2.18.3 Channel: 290.325  
2.18.5 Hours of Operation: 24

2.18.1 Service Designation: DEP/P (090-269)  
2.18.3 Channel: 354.1  
2.18.5 Hours of Operation: 24

2.18.1 Service Designation: DEP/P (090-269)  
2.18.3 Channel: 354.1

2.18.5 Hours of Operation: 24

2.18.1 Service Designation: DEP/P IC (270-089)

2.18.3 Channel: 119.45

2.18.5 Hours of Operation: 24

2.18.1 Service Designation: DEP/P IC (270-089)

2.18.3 Channel: 119.45

2.18.5 Hours of Operation: 24

2.18.1 Service Designation: DORRL DP

2.18.3 Channel: 119.45

2.18.5 Hours of Operation: 24

2.18.1 Service Designation: DORRL DP

2.18.3 Channel: 119.45

2.18.5 Hours of Operation: 24

2.18.1 Service Designation: DORRL DP

2.18.3 Channel: 290.325

2.18.5 Hours of Operation: 24

2.18.1 Service Designation: DORRL DP

2.18.3 Channel: 290.325

2.18.5 Hours of Operation: 24

2.18.1 Service Designation: DVALL STAR

2.18.3 Channel: 120.5

2.18.5 Hours of Operation: 24

2.18.1 Service Designation: DVALL STAR

2.18.3 Channel: 120.5

2.18.5 Hours of Operation: 24

2.18.1 Service Designation: DVALL STAR

2.18.3 Channel: 350.225

2.18.5 Hours of Operation: 24

2.18.1 Service Designation: DVALL STAR

2.18.3 Channel: 350.225

2.18.5 Hours of Operation: 24

2.18.1 Service Designation: EMERG

2.18.3 Channel: 121.5

2.18.5 Hours of Operation:

2.18.1 Service Designation: EMERG

2.18.3 Channel: 121.5

2.18.5 Hours of Operation:

2.18.1 Service Designation: FLMGO DP

2.18.3 Channel: 119.45  
2.18.5 Hours of Operation: 24

2.18.1 Service Designation: FLMGO DP  
2.18.3 Channel: 119.45  
2.18.5 Hours of Operation: 24

2.18.1 Service Designation: FLMGO DP  
2.18.3 Channel: 290.325  
2.18.5 Hours of Operation: 24

2.18.1 Service Designation: FLMGO DP  
2.18.3 Channel: 290.325  
2.18.5 Hours of Operation: 24

2.18.1 Service Designation: FOLZZ DP  
2.18.3 Channel: 119.45  
2.18.5 Hours of Operation: 24

2.18.1 Service Designation: FOLZZ DP  
2.18.3 Channel: 119.45  
2.18.5 Hours of Operation: 24

2.18.1 Service Designation: FOLZZ DP  
2.18.3 Channel: 290.325  
2.18.5 Hours of Operation: 24

2.18.1 Service Designation: FOLZZ DP  
2.18.3 Channel: 290.325  
2.18.5 Hours of Operation: 24

2.18.1 Service Designation: FOWEE STAR  
2.18.3 Channel: 120.5  
2.18.5 Hours of Operation: 24

2.18.1 Service Designation: FOWEE STAR  
2.18.3 Channel: 120.5  
2.18.5 Hours of Operation: 24

2.18.1 Service Designation: FOWEE STAR  
2.18.3 Channel: 124.85  
2.18.5 Hours of Operation: 24

2.18.1 Service Designation: FOWEE STAR  
2.18.3 Channel: 124.85  
2.18.5 Hours of Operation: 24

2.18.1 Service Designation: FOWEE STAR  
2.18.3 Channel: 350.225  
2.18.5 Hours of Operation: 24

2.18.1 Service Designation: FOWEE STAR  
2.18.3 Channel: 350.225  
2.18.5 Hours of Operation: 24

2.18.1 Service Designation: FROGZ STAR  
2.18.3 Channel: 120.5  
2.18.5 Hours of Operation: 24

2.18.1 Service Designation: FROGZ STAR  
2.18.3 Channel: 120.5  
2.18.5 Hours of Operation: 24

2.18.1 Service Designation: FROGZ STAR  
2.18.3 Channel: 350.225  
2.18.5 Hours of Operation: 24

2.18.1 Service Designation: FROGZ STAR  
2.18.3 Channel: 350.225  
2.18.5 Hours of Operation: 24

2.18.1 Service Designation: GLADZ DP  
2.18.3 Channel: 119.45  
2.18.5 Hours of Operation: 24

2.18.1 Service Designation: GLADZ DP  
2.18.3 Channel: 119.45  
2.18.5 Hours of Operation: 24

2.18.1 Service Designation: GLADZ DP  
2.18.3 Channel: 290.325  
2.18.5 Hours of Operation: 24

2.18.1 Service Designation: GLADZ DP  
2.18.3 Channel: 290.325  
2.18.5 Hours of Operation: 24

2.18.1 Service Designation: GND/P IC (RWY 08L/26R, 08R/26L, 12)  
2.18.3 Channel: 121.8  
2.18.5 Hours of Operation: 24

2.18.1 Service Designation: GND/P IC (RWY 08L/26R, 08R/26L, 12)  
2.18.3 Channel: 121.8  
2.18.5 Hours of Operation: 24

2.18.1 Service Designation: GND/P IC (RWY 09/27, 30)  
2.18.3 Channel: 127.5  
2.18.5 Hours of Operation: 24

2.18.1 Service Designation: GND/P IC (RWY 09/27, 30)  
2.18.3 Channel: 127.5  
2.18.5 Hours of Operation: 24

2.18.1 Service Designation: GND/P IC  
2.18.3 Channel: 348.6  
2.18.5 Hours of Operation: 24

2.18.1 Service Designation: GND/P IC  
2.18.3 Channel: 348.6  
2.18.5 Hours of Operation: 24

2.18.1 Service Designation: GWAVA DP  
2.18.3 Channel: 125.5  
2.18.5 Hours of Operation: 24

2.18.1 Service Designation: GWAVA DP  
2.18.3 Channel: 125.5  
2.18.5 Hours of Operation: 24

2.18.1 Service Designation: GWAVA DP  
2.18.3 Channel: 354.1  
2.18.5 Hours of Operation: 24

2.18.1 Service Designation: GWAVA DP  
2.18.3 Channel: 354.1  
2.18.5 Hours of Operation: 24

2.18.1 Service Designation: HURCN DP  
2.18.3 Channel: 119.45  
2.18.5 Hours of Operation: 24

2.18.1 Service Designation: HURCN DP  
2.18.3 Channel: 119.45  
2.18.5 Hours of Operation: 24

2.18.1 Service Designation: HURCN DP  
2.18.3 Channel: 290.325  
2.18.5 Hours of Operation: 24

2.18.1 Service Designation: HURCN DP  
2.18.3 Channel: 290.325  
2.18.5 Hours of Operation: 24

2.18.1 Service Designation: HUSIL DP  
2.18.3 Channel: 119.45  
2.18.5 Hours of Operation: 24

2.18.1 Service Designation: HUSIL DP  
2.18.3 Channel: 119.45  
2.18.5 Hours of Operation: 24

2.18.1 Service Designation: HUSIL DP  
2.18.3 Channel: 290.325

2.18.5 Hours of Operation: 24

2.18.1 Service Designation: HUSIL DP

2.18.3 Channel: 290.325

2.18.5 Hours of Operation: 24

2.18.1 Service Designation: KLADA DP

2.18.3 Channel: 125.5

2.18.5 Hours of Operation: 24

2.18.1 Service Designation: KLADA DP

2.18.3 Channel: 125.5

2.18.5 Hours of Operation: 24

2.18.1 Service Designation: KLADA DP

2.18.3 Channel: 354.1

2.18.5 Hours of Operation: 24

2.18.1 Service Designation: KLADA DP

2.18.3 Channel: 354.1

2.18.5 Hours of Operation: 24

2.18.1 Service Designation: LCL/P (090-269)

2.18.3 Channel: 123.9

2.18.5 Hours of Operation: 24

2.18.1 Service Designation: LCL/P (090-269)

2.18.3 Channel: 123.9

2.18.5 Hours of Operation: 24

2.18.1 Service Designation: LCL/P IC (270-089)

2.18.3 Channel: 118.3

2.18.5 Hours of Operation: 24

2.18.1 Service Designation: LCL/P IC (270-089)

2.18.3 Channel: 118.3

2.18.5 Hours of Operation: 24

2.18.1 Service Designation: LCL/P IC

2.18.3 Channel: 256.9

2.18.5 Hours of Operation: 24

2.18.1 Service Designation: LCL/P IC

2.18.3 Channel: 256.9

2.18.5 Hours of Operation: 24

2.18.1 Service Designation: LIFRR DP

2.18.3 Channel: 119.45

2.18.5 Hours of Operation: 24

2.18.1 Service Designation: LIFRR DP

2.18.3 Channel: 119.45  
2.18.5 Hours of Operation: 24

2.18.1 Service Designation: LIFRR DP  
2.18.3 Channel: 290.325  
2.18.5 Hours of Operation: 24

2.18.1 Service Designation: LIFRR DP  
2.18.3 Channel: 290.325  
2.18.5 Hours of Operation: 24

2.18.1 Service Designation: LUUCE STAR (9000 FT)  
2.18.3 Channel: 126.05  
2.18.5 Hours of Operation: 24

2.18.1 Service Designation: LUUCE STAR (9000 FT)  
2.18.3 Channel: 126.05  
2.18.5 Hours of Operation: 24

2.18.1 Service Designation: LUUCE STAR (7000 FT)  
2.18.3 Channel: 133.775  
2.18.5 Hours of Operation: 24

2.18.1 Service Designation: LUUCE STAR (7000 FT)  
2.18.3 Channel: 133.775  
2.18.5 Hours of Operation: 24

2.18.1 Service Designation: LUUCE STAR (9000 FT)  
2.18.3 Channel: 251.1  
2.18.5 Hours of Operation: 24

2.18.1 Service Designation: LUUCE STAR (9000 FT)  
2.18.3 Channel: 251.1  
2.18.5 Hours of Operation: 24

2.18.1 Service Designation: LUUCE STAR (7000 FT)  
2.18.3 Channel: 371.9  
2.18.5 Hours of Operation: 24

2.18.1 Service Designation: LUUCE STAR (7000 FT)  
2.18.3 Channel: 371.9  
2.18.5 Hours of Operation: 24

2.18.1 Service Designation: MAYNR DP  
2.18.3 Channel: 125.5  
2.18.5 Hours of Operation: 24

2.18.1 Service Designation: MAYNR DP  
2.18.3 Channel: 125.5  
2.18.5 Hours of Operation: 24



2.18.1 Service Designation: MAYNR DP  
2.18.3 Channel: 354.1  
2.18.5 Hours of Operation: 24

2.18.1 Service Designation: MAYNR DP  
2.18.3 Channel: 354.1  
2.18.5 Hours of Operation: 24

2.18.1 Service Designation: MIAMI DP (ALTNN,BEECH,BNGOS,DORRL,FLMGO,HURCN,FOLZZ,ZFP)  
2.18.3 Channel: 119.45  
2.18.5 Hours of Operation: 24

2.18.1 Service Designation: MIAMI DP (ALTNN,BEECH,BNGOS,DORRL,FLMGO,HURCN,FOLZZ,ZFP)  
2.18.3 Channel: 119.45  
2.18.5 Hours of Operation: 24

2.18.1 Service Designation: MIAMI DP (GWAVA, KETLL, MAYNR TRANSITIONS)  
2.18.3 Channel: 125.5  
2.18.5 Hours of Operation: 24

2.18.1 Service Designation: MIAMI DP (GWAVA, KETLL, MAYNR TRANSITIONS)  
2.18.3 Channel: 125.5  
2.18.5 Hours of Operation: 24

2.18.1 Service Designation: MIAMI DP (ALTNN,BEECH,BNGOS,DORRL,FLMGO,HURCN,FOLZZ,ZFP)  
2.18.3 Channel: 290.325  
2.18.5 Hours of Operation: 24

2.18.1 Service Designation: MIAMI DP (ALTNN,BEECH,BNGOS,DORRL,FLMGO,HURCN,FOLZZ,ZFP)  
2.18.3 Channel: 290.325  
2.18.5 Hours of Operation: 24

2.18.1 Service Designation: MIAMI DP (GWAVA, KETLL, MAYNR TRANSITIONS)  
2.18.3 Channel: 354.1  
2.18.5 Hours of Operation: 24

2.18.1 Service Designation: MIAMI DP (GWAVA, KETLL, MAYNR TRANSITIONS)  
2.18.3 Channel: 354.1  
2.18.5 Hours of Operation: 24

2.18.1 Service Designation: NNOCE DP  
2.18.3 Channel: 125.5  
2.18.5 Hours of Operation: 24

2.18.1 Service Designation: NNOCE DP  
2.18.3 Channel: 125.5  
2.18.5 Hours of Operation: 24

2.18.1 Service Designation: NNOCE DP  
2.18.3 Channel: 354.1  
2.18.5 Hours of Operation: 24

2.18.1 Service Designation: NNOCE DP  
2.18.3 Channel: 354.1  
2.18.5 Hours of Operation: 24

2.18.1 Service Designation: PALMZ STAR  
2.18.3 Channel: 120.5  
2.18.5 Hours of Operation: 24

2.18.1 Service Designation: PALMZ STAR  
2.18.3 Channel: 120.5  
2.18.5 Hours of Operation: 24

2.18.1 Service Designation: PALMZ STAR  
2.18.3 Channel: 350.225  
2.18.5 Hours of Operation: 24

2.18.1 Service Designation: PALMZ STAR  
2.18.3 Channel: 350.225  
2.18.5 Hours of Operation: 24

2.18.1 Service Designation: RAMP CTL  
2.18.3 Channel: 120.35  
2.18.5 Hours of Operation: 24

2.18.1 Service Designation: RAMP CTL  
2.18.3 Channel: 120.35  
2.18.5 Hours of Operation: 24

2.18.1 Service Designation: RTIS (120-300 WITHIN 25 NM)  
2.18.3 Channel: 125.25  
2.18.5 Hours of Operation: 24

2.18.1 Service Designation: RTIS (120-300 WITHIN 25 NM)  
2.18.3 Channel: 125.25  
2.18.5 Hours of Operation: 24

2.18.1 Service Designation: SNDBR STAR  
2.18.3 Channel: 120.5  
2.18.5 Hours of Operation: 24

2.18.1 Service Designation: SNDBR STAR  
2.18.3 Channel: 120.5  
2.18.5 Hours of Operation: 24

2.18.1 Service Designation: SNDBR STAR  
2.18.3 Channel: 350.225  
2.18.5 Hours of Operation: 24

2.18.1 Service Designation: SNDBR STAR  
2.18.3 Channel: 350.225

2.18.5 Hours of Operation: 24

2.18.1 Service Designation: TARPEN STAR (9000 FT)

2.18.3 Channel: 126.05

2.18.5 Hours of Operation: 24

2.18.1 Service Designation: TARPEN STAR (9000 FT)

2.18.3 Channel: 126.05

2.18.5 Hours of Operation: 24

2.18.1 Service Designation: TARPEN STAR (7000 FT)

2.18.3 Channel: 133.775

2.18.5 Hours of Operation: 24

2.18.1 Service Designation: TARPEN STAR (7000 FT)

2.18.3 Channel: 133.775

2.18.5 Hours of Operation: 24

2.18.1 Service Designation: TARPEN STAR (9000 FT)

2.18.3 Channel: 251.1

2.18.5 Hours of Operation: 24

2.18.1 Service Designation: TARPEN STAR (9000 FT)

2.18.3 Channel: 251.1

2.18.5 Hours of Operation: 24

2.18.1 Service Designation: TARPEN STAR (7000 FT)

2.18.3 Channel: 371.9

2.18.5 Hours of Operation: 24

2.18.1 Service Designation: TARPEN STAR (7000 FT)

2.18.3 Channel: 371.9

2.18.5 Hours of Operation: 24

2.18.1 Service Designation: VIICE STAR

2.18.3 Channel: 120.5

2.18.5 Hours of Operation: 24

2.18.1 Service Designation: VIICE STAR

2.18.3 Channel: 120.5

2.18.5 Hours of Operation: 24

2.18.1 Service Designation: VIICE STAR

2.18.3 Channel: 350.225

2.18.5 Hours of Operation: 24

2.18.1 Service Designation: VIICE STAR

2.18.3 Channel: 350.225

2.18.5 Hours of Operation: 24

**AD 2.19 Radio Navigation and Landing Aids**

2.19.1 ILS Type: DME for runway 08L. Magnetic variation: 5W

2.19.2 ILS Identification: ROY

2.19.5 Coordinates: 25-48-16.3597N / 80-16-18.3104W

2.19.6 Site Elevation: 20.1 ft

2.19.1 ILS Type: Localizer for runway 08L. Magnetic variation: 5W

2.19.2 ILS Identification: ROY

2.19.5 Coordinates: 25-48-14.865N / 80-16-18.3941W

2.19.6 Site Elevation: 6.8 ft

2.19.1 ILS Type: DME for runway 26R. Magnetic variation: 5W

2.19.2 ILS Identification: CNV

2.19.5 Coordinates: 25-48-7.1241N / 80-18-16.4684W

2.19.6 Site Elevation: 20.3 ft

2.19.1 ILS Type: Localizer for runway 26R. Magnetic variation: 5W

2.19.2 ILS Identification: CNV

2.19.5 Coordinates: 25-48-9.969N / 80-18-16.6983W

2.19.6 Site Elevation: 7.4 ft

2.19.1 ILS Type: DME for runway 08R. Magnetic variation: 5W

2.19.2 ILS Identification: MFA

2.19.5 Coordinates: 25-48-5.0878N / 80-16-0.575W

2.19.6 Site Elevation: 15.6 ft

2.19.1 ILS Type: Glide Slope for runway 08R. Magnetic variation: 5W

2.19.2 ILS Identification: MFA

2.19.5 Coordinates: 25-48-6.1715N / 80-17-54.807W

2.19.6 Site Elevation: 5 ft

2.19.1 ILS Type: Localizer for runway 08R. Magnetic variation: 5W

2.19.2 ILS Identification: MFA

2.19.5 Coordinates: 25-48-7.688N / 80-16-0.0426W

2.19.6 Site Elevation: 6.3 ft

2.19.1 ILS Type: DME for runway 26L. Magnetic variation: 5W

2.19.2 ILS Identification: VIN

2.19.5 Coordinates: 25-48-5.8074N / 80-18-14.9415W

2.19.6 Site Elevation: 14.3 ft

2.19.1 ILS Type: Glide Slope for runway 26L. Magnetic variation: 5W

2.19.2 ILS Identification: VIN

2.19.5 Coordinates: 25-48-9.7347N / 80-16-22.5043W

2.19.6 Site Elevation: 5.9 ft

2.19.1 ILS Type: Localizer for runway 26L. Magnetic variation: 5W

2.19.2 ILS Identification: VIN

2.19.5 Coordinates: 25-48-2.1576N / 80-18-13.7966W

2.19.6 Site Elevation: 7.6 ft

2.19.1 ILS Type: DME for runway 09. Magnetic variation: 5W  
2.19.2 ILS Identification: BUL  
2.19.5 Coordinates: 25-47-15.8249N / 80-16-17.2451W  
2.19.6 Site Elevation: 20.1 ft

2.19.1 ILS Type: Glide Slope for runway 09. Magnetic variation: 5W  
2.19.2 ILS Identification: BUL  
2.19.5 Coordinates: 25-47-7.8388N / 80-18-26.7053W  
2.19.6 Site Elevation: 7.5 ft

2.19.1 ILS Type: Localizer for runway 09. Magnetic variation: 5W  
2.19.2 ILS Identification: BUL  
2.19.5 Coordinates: 25-47-16.4165N / 80-16-17.1006W  
2.19.6 Site Elevation: 18.4 ft

2.19.1 ILS Type: Glide Slope for runway 27. Magnetic variation: 5W  
2.19.2 ILS Identification: MIA  
2.19.5 Coordinates: 25-47-11.7269N / 80-16-45.3981W  
2.19.6 Site Elevation: 4.7 ft

2.19.1 ILS Type: Localizer for runway 27. Magnetic variation: 5W  
2.19.2 ILS Identification: MIA  
2.19.5 Coordinates: 25-47-9.3891N / 80-19-6.6406W  
2.19.6 Site Elevation: 7.1 ft

2.19.1 ILS Type: DME for runway 12. Magnetic variation: 5W  
2.19.2 ILS Identification: GEM  
2.19.5 Coordinates: 25-47-11.2767N / 80-16-32.4152W  
2.19.6 Site Elevation: 15.9 ft

2.19.1 ILS Type: Glide Slope for runway 12. Magnetic variation: 5W  
2.19.2 ILS Identification: GEM  
2.19.5 Coordinates: 25-47-50.78N / 80-17-58.58W  
2.19.6 Site Elevation: 7 ft

2.19.1 ILS Type: Localizer for runway 12. Magnetic variation: 5W  
2.19.2 ILS Identification: GEM  
2.19.5 Coordinates: 25-47-9.6403N / 80-16-34.8108W  
2.19.6 Site Elevation: 8.3 ft

2.19.1 ILS Type: DME for runway 30. Magnetic variation: 5W  
2.19.2 ILS Identification: DCX  
2.19.5 Coordinates: 25-47-57.7789N / 80-18-14.5127W  
2.19.6 Site Elevation: 14.7 ft

2.19.1 ILS Type: Glide Slope for runway 30. Magnetic variation: 5W  
2.19.2 ILS Identification: DCX  
2.19.5 Coordinates: 25-47-17.643N / 80-16-59.572W  
2.19.6 Site Elevation: 7.1 ft

2.19.1 ILS Type: Localizer for runway 30. Magnetic variation: 5W

2.19.2 ILS Identification: DCX  
2.19.5 Coordinates: 25-47-59.8764N / 80-18-13.0372W  
2.19.6 Site Elevation: 8.9 ft

**General Remarks:**

ACFT WITH A WINGSPAN GTR THAN 171 FT ARE PROHIBITED FM TXG ON TWY P EAST OF TWY U.

ALL MEDICAL EMERGENCIES ARRIVALS, WITH THE EXCEPTION OF AIR AMBULANCE FLIGHTS, MUST SECURE DOORS UNTIL ARFF IS ON SCENE.

ASDE-X IN USE. OPERATE TRANSPONDERS WITH ALTITUDE REPORTING MODE AND ADS-B (IF EQUIPPED) ENABLED ON ALL AIRPORT SURFACES.

AIRPORT MANAGER: 305-876-7038.

US CBP AND EAPIS AVBL.

ALL DIVERSION CTC FREQ 130.5 UPON ARR.

ALL TURBOJET ACFT USE DSNT NOISE ABATEMENT DEP PROFILE FROM ALL RYS EXC A320, B727, B737-800, B767-400, AND DC9 WHICH SHOULD USE CLOSE-IN NOISE ABATEMENT ABATEMENT PROFILE.

PPR 3 HRS PRIOR TO ALL ARRIVALS ON THE GENERAL AVIATION CENTER (GAC) RAMP 305-876-7550 CTC RAMP CONTROL UPON ARRIVAL ON FREQUENCY 131.600. ACFT WITH WINGSPAN GREATER THAN 78 FT ARE PROHIBITED FROM ENTERING THE GAC RAMP.

NO INT DEP AUTH WO PPR FM AMGR.

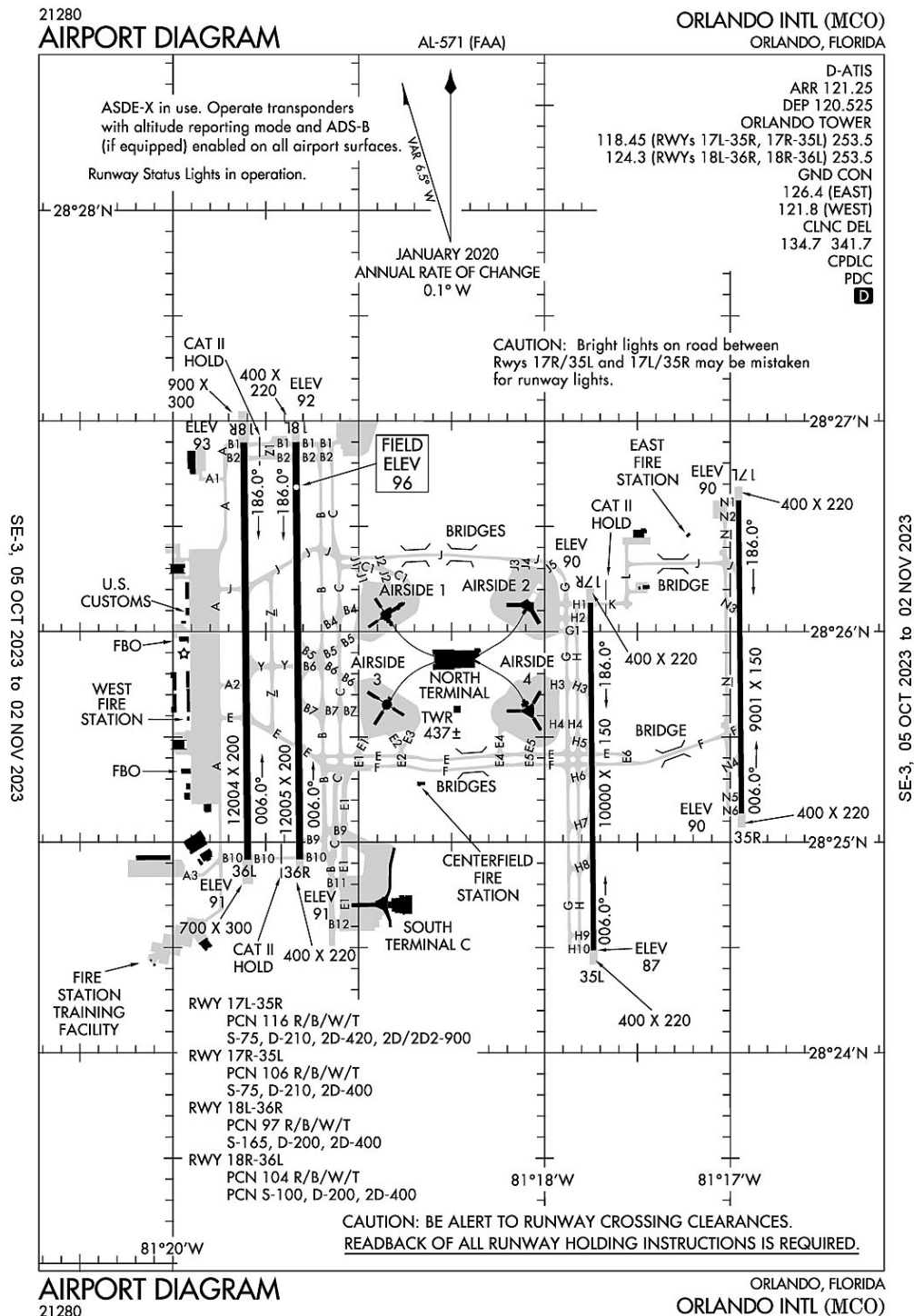
AIRPORT OPS 305-876-7550.

CLSD NON ENG ACFT.

BIRDS ON & INVOF ARPT.

PPR FOR INBOUND MILITARY FLIGHTS 100 NM ON FREQ 130.5.

**Orlando, Florida**  
**Orlando International**  
**ICAO Identifier KMCO**



**Orlando, FL**  
**Orlando Intl**  
**ICAO Identifier KMCO**

**AD 2.2 Aerodrome geographical and administrative data**

- 2.2.1 Reference Point: 28-25-45.8N / 81-18-32.4W
- 2.2.2 From City: 6 miles SE of ORLANDO, FL
- 2.2.3 Elevation: 96.4 ft
- 2.2.5 Magnetic Variation: 6W (2015)
- 2.2.6 Airport Contact: KEVIN J. THIBAUT, P.E.  
1 JEFF FUQUA BLVD  
ORLANDO, FL 32827 (407-825-7445)
- 2.2.7 Traffic: IFR/VFR

**AD 2.3 Attendance Schedule**

- 2.3.1 All Months, All Days, All Hours

**AD 2.4 Handling Services and Facilities**

- 2.4.1 Cargo Handling Facilities: YES
- 2.4.2 Fuel Types: 100LL,A
- 2.4.5 Hangar Space: YES
- 2.4.6 Repair Facilities: MINOR

**AD 2.6 Rescue and Firefighting Services**

- 2.6.1 Aerodrome Category: Class-I certified on 5/21/1973
- 2.6.2 Rescue and Firefighting Services: ARFF Index-E

**AD 2.12 Runway Physical Characteristics**

- 2.12.1 Designation: 17L
- 2.12.2 True Bearing: 179
- 2.12.3 Dimensions: 9001 ft x 150 ft
- 2.12.4 PCN: 116 R/B/W/T
- 2.12.5 Coordinates: 28-26-37.308N / 81-16-57.2924W
- 2.12.6 Threshold Elevation: 89.7 ft
- 2.12.6 Touchdown Zone Elevation: 89.9 ft

- 2.12.1 Designation: 35R
- 2.12.2 True Bearing: 359
- 2.12.3 Dimensions: 9001 ft x 150 ft
- 2.12.4 PCN: 116 R/B/W/T
- 2.12.5 Coordinates: 28-25-8.1974N / 81-16-56.3802W
- 2.12.6 Threshold Elevation: 89.7 ft
- 2.12.6 Touchdown Zone Elevation: 89.8 ft

- 2.12.1 Designation: 17R
- 2.12.2 True Bearing: 179
- 2.12.3 Dimensions: 10000 ft x 150 ft
- 2.12.4 PCN: 106 R/B/W/T
- 2.12.5 Coordinates: 28-26-8.2029N / 81-17-45.1656W
- 2.12.6 Threshold Elevation: 90.1 ft
- 2.12.6 Touchdown Zone Elevation: 90.2 ft



2.12.1 Designation: 35L  
2.12.2 True Bearing: 359  
2.12.3 Dimensions: 10000 ft x 150 ft  
2.12.4 PCN: 106 R/B/W/T  
2.12.5 Coordinates: 28-24-29.1952N / 81-17-44.1335W  
2.12.6 Threshold Elevation: 86.7 ft  
2.12.6 Touchdown Zone Elevation: 88.3 ft

2.12.1 Designation: 36R  
2.12.2 True Bearing: 359  
2.12.3 Dimensions: 12005 ft x 200 ft  
2.12.4 PCN: 97 R/B/W/T  
2.12.5 Coordinates: 28-24-55.1469N / 81-19-19.0358W  
2.12.6 Threshold Elevation: 91 ft  
2.12.6 Touchdown Zone Elevation: 92.3 ft

2.12.1 Designation: 18L  
2.12.2 True Bearing: 179  
2.12.3 Dimensions: 12005 ft x 200 ft  
2.12.4 PCN: 97 R/B/W/T  
2.12.5 Coordinates: 28-26-54.0038N / 81-19-20.3022W  
2.12.6 Threshold Elevation: 92.4 ft  
2.12.6 Touchdown Zone Elevation: 96.4 ft

2.12.1 Designation: 18R  
2.12.2 True Bearing: 179  
2.12.3 Dimensions: 12004 ft x 200 ft  
2.12.4 PCN: 104 R/B/W/T  
2.12.5 Coordinates: 28-26-53.8569N / 81-19-37.1091W  
2.12.6 Threshold Elevation: 92.5 ft  
2.12.6 Touchdown Zone Elevation: 93.5 ft

2.12.1 Designation: 36L  
2.12.2 True Bearing: 359  
2.12.3 Dimensions: 12004 ft x 200 ft  
2.12.4 PCN: 104 R/B/W/T  
2.12.5 Coordinates: 28-24-55.007N / 81-19-35.8294W  
2.12.6 Threshold Elevation: 91.1 ft  
2.12.6 Touchdown Zone Elevation: 92.6 ft

**AD 2.13 Declared Distances**

2.13.1 Designation: 17L  
2.13.2 Take-off Run Available: 9001  
2.13.3 Take-off Distance Available: 9001  
2.13.4 Accelerate-Stop Distance Available: 9001  
2.13.5 Landing Distance Available: 9001

2.13.1 Designation: 35R  
2.13.2 Take-off Run Available: 9001

2.13.3 Take-off Distance Available: 9001  
2.13.4 Accelerate-Stop Distance Available: 9001  
2.13.5 Landing Distance Available: 9001

2.13.1 Designation: 17R  
2.13.2 Take-off Run Available: 10000  
2.13.3 Take-off Distance Available: 10000  
2.13.4 Accelerate-Stop Distance Available: 10000  
2.13.5 Landing Distance Available: 10000

2.13.1 Designation: 35L  
2.13.2 Take-off Run Available: 10000  
2.13.3 Take-off Distance Available: 10000  
2.13.4 Accelerate-Stop Distance Available: 10000  
2.13.5 Landing Distance Available: 10000

2.13.1 Designation: 36R  
2.13.2 Take-off Run Available: 12005  
2.13.3 Take-off Distance Available: 12005  
2.13.4 Accelerate-Stop Distance Available: 11601  
2.13.5 Landing Distance Available: 11601

2.13.1 Designation: 18L  
2.13.2 Take-off Run Available: 12005  
2.13.3 Take-off Distance Available: 12005  
2.13.4 Accelerate-Stop Distance Available: 12005  
2.13.5 Landing Distance Available: 12005

2.13.1 Designation: 18R  
2.13.2 Take-off Run Available: 12004  
2.13.3 Take-off Distance Available: 12004  
2.13.4 Accelerate-Stop Distance Available: 12004  
2.13.5 Landing Distance Available: 12004

2.13.1 Designation: 36L  
2.13.2 Take-off Run Available: 12004  
2.13.3 Take-off Distance Available: 12004  
2.13.4 Accelerate-Stop Distance Available: 11621  
2.13.5 Landing Distance Available: 11621

#### **AD 2.14 Approach and Runway Lighting**

2.14.1 Designation: 17L  
2.14.2 Approach Lighting System: ALSF2  
2.14.4 Visual Approach Slope Indicator System: P4L

2.14.1 Designation: 35R  
2.14.2 Approach Lighting System: ALSF2  
2.14.4 Visual Approach Slope Indicator System: P4R

2.14.1 Designation: 17R

2.14.2 Approach Lighting System: ALSF2  
2.14.4 Visual Approach Slope Indicator System: P4L

2.14.1 Designation: 35L  
2.14.2 Approach Lighting System: ALSF2  
2.14.4 Visual Approach Slope Indicator System: P4R

2.14.1 Designation: 36R  
2.14.2 Approach Lighting System: ALSF2  
2.14.4 Visual Approach Slope Indicator System: P4L

2.14.1 Designation: 18L  
2.14.2 Approach Lighting System:  
2.14.4 Visual Approach Slope Indicator System: P4L

2.14.1 Designation: 18R  
2.14.2 Approach Lighting System: MALSR  
2.14.4 Visual Approach Slope Indicator System: P4L

2.14.1 Designation: 36L  
2.14.2 Approach Lighting System:  
2.14.4 Visual Approach Slope Indicator System: P4L

#### **AD 2.18 Air Traffic Services Communication Facilities**

2.18.1 Service Designation: AR OPS  
2.18.3 Channel: 41.5  
2.18.5 Hours of Operation:

2.18.1 Service Designation: AR OPS  
2.18.3 Channel: 148.8  
2.18.5 Hours of Operation:

2.18.1 Service Designation: CD/P  
2.18.3 Channel: 134.7  
2.18.5 Hours of Operation: 24

2.18.1 Service Designation: CD/P  
2.18.3 Channel: 341.7  
2.18.5 Hours of Operation: 24

2.18.1 Service Designation: D-ATIS (DEP)  
2.18.3 Channel: 120.525  
2.18.5 Hours of Operation: 24

2.18.1 Service Designation: D-ATIS (ARR)  
2.18.3 Channel: 121.25  
2.18.5 Hours of Operation: 24

2.18.1 Service Designation: EMERG  
2.18.3 Channel: 121.5

2.18.5 Hours of Operation:

2.18.1 Service Designation: EMERG

2.18.3 Channel: 243

2.18.5 Hours of Operation:

2.18.1 Service Designation: GND/P (WEST)

2.18.3 Channel: 121.8

2.18.5 Hours of Operation: 24

2.18.1 Service Designation: GND/P (EAST)

2.18.3 Channel: 126.4

2.18.5 Hours of Operation: 24

2.18.1 Service Designation: LCL/P (RWY 17L/35R, 17R/35L)

2.18.3 Channel: 118.45

2.18.5 Hours of Operation: 24

2.18.1 Service Designation: LCL/P (RWY 18L/36R, 18R/36L)

2.18.3 Channel: 124.3

2.18.5 Hours of Operation: 24

2.18.1 Service Designation: LCL/P

2.18.3 Channel: 253.5

2.18.5 Hours of Operation: 24

### **AD 2.19 Radio Navigation and Landing Aids**

2.19.1 ILS Type: DME for runway 17L. Magnetic variation: 6W

2.19.2 ILS Identification: ARK

2.19.5 Coordinates: 28-24-57.9921N / 81-16-51.737W

2.19.6 Site Elevation: 97 ft

2.19.1 ILS Type: Glide Slope for runway 17L. Magnetic variation: 6W

2.19.2 ILS Identification: ARK

2.19.5 Coordinates: 28-26-27.0479N / 81-16-52.5933W

2.19.6 Site Elevation: 94.4 ft

2.19.1 ILS Type: Localizer for runway 17L. Magnetic variation: 6W

2.19.2 ILS Identification: ARK

2.19.5 Coordinates: 28-24-57.8892N / 81-16-56.2728W

2.19.6 Site Elevation: 89.1 ft

2.19.1 ILS Type: DME for runway 35R. Magnetic variation: 6W

2.19.2 ILS Identification: CER

2.19.5 Coordinates: 28-26-48.2377N / 81-16-52.8447W

2.19.6 Site Elevation: 98.3 ft

2.19.1 ILS Type: Glide Slope for runway 35R. Magnetic variation: 6W

2.19.2 ILS Identification: CER

2.19.5 Coordinates: 28-25-18.6301N / 81-16-51.8726W

2.19.6 Site Elevation: 87.3 ft

2.19.1 ILS Type: Localizer for runway 35R. Magnetic variation: 6W  
2.19.2 ILS Identification: CER  
2.19.5 Coordinates: 28-26-47.6103N / 81-16-57.3979W  
2.19.6 Site Elevation: 89.6 ft

2.19.1 ILS Type: DME for runway 17R. Magnetic variation: 6W  
2.19.2 ILS Identification: DIZ  
2.19.5 Coordinates: 28-24-18.9549N / 81-17-47.0755W  
2.19.6 Site Elevation: 86.4 ft

2.19.1 ILS Type: Glide Slope for runway 17R. Magnetic variation: 6W  
2.19.2 ILS Identification: DIZ  
2.19.5 Coordinates: 28-25-57.8375N / 81-17-40.5783W  
2.19.6 Site Elevation: 92.7 ft

2.19.1 ILS Type: Localizer for runway 17R. Magnetic variation: 6W  
2.19.2 ILS Identification: DIZ  
2.19.5 Coordinates: 28-24-18.7729N / 81-17-44.0255W  
2.19.6 Site Elevation: 81.6 ft

2.19.1 ILS Type: DME for runway 35L. Magnetic variation: 6W  
2.19.2 ILS Identification: DDO  
2.19.5 Coordinates: 28-26-18.3948N / 81-17-48.1528W  
2.19.6 Site Elevation: 95.5 ft

2.19.1 ILS Type: Glide Slope for runway 35L. Magnetic variation: 6W  
2.19.2 ILS Identification: DDO  
2.19.5 Coordinates: 28-24-39.5307N / 81-17-39.7618W  
2.19.6 Site Elevation: 83.7 ft

2.19.1 ILS Type: Localizer for runway 35L. Magnetic variation: 6W  
2.19.2 ILS Identification: DDO  
2.19.5 Coordinates: 28-26-18.5959N / 81-17-45.2712W  
2.19.6 Site Elevation: 87.7 ft

2.19.1 ILS Type: DME for runway 36R. Magnetic variation: 6W  
2.19.2 ILS Identification: OJP  
2.19.5 Coordinates: 28-27-0.7626N / 81-19-18.0064W  
2.19.6 Site Elevation: 96.2 ft

2.19.1 ILS Type: Glide Slope for runway 36R. Magnetic variation: 6W  
2.19.2 ILS Identification: OJP  
2.19.5 Coordinates: 28-25-5.5139N / 81-19-23.6289W  
2.19.6 Site Elevation: 87.7 ft

2.19.1 ILS Type: Localizer for runway 36R. Magnetic variation: 6W  
2.19.2 ILS Identification: OJP  
2.19.5 Coordinates: 28-27-1.4488N / 81-19-20.3839W  
2.19.6 Site Elevation: 90.8 ft

2.19.1 ILS Type: DME for runway 18R. Magnetic variation: 6W  
2.19.2 ILS Identification: TFE  
2.19.5 Coordinates: 28-24-42.2043N / 81-19-38.5819W  
2.19.6 Site Elevation: 94.7 ft

2.19.1 ILS Type: Glide Slope for runway 18R. Magnetic variation: 6W  
2.19.2 ILS Identification: TFE  
2.19.5 Coordinates: 28-26-43.5N / 81-19-32.21W  
2.19.6 Site Elevation: 89 ft

2.19.1 ILS Type: Localizer for runway 18R. Magnetic variation: 6W  
2.19.2 ILS Identification: TFE  
2.19.5 Coordinates: 28-24-41.97N / 81-19-35.69W  
2.19.6 Site Elevation: 86 ft

**General Remarks:**

WHEN ORL ILS RY 7 AND MCO ILS RYS 17 & 18R SIMULTANEOUS OPERATIONS ARE CONDUCTED, ATC RADAR REQUIRED.

WEST RAMP CUSTOMS INSPECTION PRKG AREA RSTD TO ACFT WINGSPAN LESS THAN 118'

ASDE-X IN USE. OPERATE TRANSPONDERS WITH ALTITUDE REPORTING MODE AND ADS-B (IF EQUIPPED) ENABLED ON ALL AIRPORT SURFACES.

UNLESS ADV BY ATIS, DEP FLTS ON INITIAL CTC WITH GND CTL: ACFT ON WEST RAMP, AIRSIDE 1 & 3 (GATES 1-59) USE GND CTL 121.8. ACFT AT AIRSIDE 2 & 4 (GATES 60 AND HIGHER), USE GND CTL 126.4.

TWY A, BTN W RAMP S END AND TWY B10, RSTRD TO ACFT WINGSPAN LESS THAN 171 FT. PPR FOR ACFT WINGSPAN 171 FT OR GTR.

TWY J3 AND TWY J4 RSTD TO WINGSPAN OF LESS THAN 118 FT.

RUNWAY STATUS LIGHTS ARE IN OPERATION.

BRIGHT LGTS ON ROAD BTN RY 17R/35L AND RY 17L/35R MAY BE MISTAKEN FOR RY LGTS.

AVOID CONTACT WITH TAXIWAY EDGE LIGHTS; ALL AIRCRAFT DETERMINED TO BE FAA DESIGN GROUP IV AND ABOVE MUST PERFORM JUDGEMENTAL OVERSTEERING INSTEAD OF COCKPIT CENTERLINE STEERING WHEN TAXIING.

TWY A, SOUTH OF TWY A3 RSTD TO WINGSPAN OF LESS THAN 118 FT. PPR REQUIRED FOR WINGSPAN 118 FT OR GREATER.

RY 17L-35R UNLIT 0400-1100Z.

USE CAUTION IN VCNTY OF TWY "A" ALONG WEST RAMP.

BIRDS & DEER ON & INVOF ARPT.

ACFT WITH WINGSPAN GREATER THAN 214 FT MUST ADHERE TO SPECIFIC RY AND TAXI ROUTES. CONTACT AIRFIELD OPS AT 407-825-2036 FOR DETAILS.



**Tampa, FL**  
**Tampa Intl**  
**ICAO Identifier KTPA**

**AD 2.2 Aerodrome geographical and administrative data**

- 2.2.1 Reference Point: 27-58-31.7N / 82-31-59.7W
- 2.2.2 From City: 6 miles W of TAMPA, FL
- 2.2.3 Elevation: 26.4 ft
- 2.2.5 Magnetic Variation: 5W (2010)
- 2.2.6 Airport Contact: JOHN TILIACOS  
PO BOX 22287  
TAMPA, FL 33622 (813-870-8700)
- 2.2.7 Traffic: IFR/VFR

**AD 2.3 Attendance Schedule**

- 2.3.1 All Months, All Days, All Hours

**AD 2.4 Handling Services and Facilities**

- 2.4.1 Cargo Handling Facilities: YES
- 2.4.2 Fuel Types: 100LL,A
- 2.4.5 Hangar Space: YES
- 2.4.6 Repair Facilities: MAJOR

**AD 2.6 Rescue and Firefighting Services**

- 2.6.1 Aerodrome Category: Class-I certified on 5/1/1973
- 2.6.2 Rescue and Firefighting Services: ARFF Index-D

**AD 2.12 Runway Physical Characteristics**

- 2.12.1 Designation: 19R
- 2.12.2 True Bearing: 182
- 2.12.3 Dimensions: 11002 ft x 150 ft
- 2.12.4 PCN: 85 R/B/W/T
- 2.12.5 Coordinates: 27-59-36.7423N / 82-32-28.7801W
- 2.12.6 Threshold Elevation: 21 ft
- 2.12.6 Touchdown Zone Elevation: 21 ft

- 2.12.1 Designation: 01L
- 2.12.2 True Bearing: 2
- 2.12.3 Dimensions: 11002 ft x 150 ft
- 2.12.4 PCN: 85 R/B/W/T
- 2.12.5 Coordinates: 27-57-47.8596N / 82-32-32.4793W
- 2.12.6 Threshold Elevation: 10.7 ft
- 2.12.6 Touchdown Zone Elevation: 10.8 ft

- 2.12.1 Designation: 19L
- 2.12.2 True Bearing: 182
- 2.12.3 Dimensions: 8300 ft x 150 ft
- 2.12.4 PCN: 76 R/B/W/T
- 2.12.5 Coordinates: 27-59-13.6607N / 82-31-41.5739W
- 2.12.6 Threshold Elevation: 26 ft
- 2.12.6 Touchdown Zone Elevation: 26.1 ft



2.12.1 Designation: 01R  
2.12.2 True Bearing: 2  
2.12.3 Dimensions: 8300 ft x 150 ft  
2.12.4 PCN: 76 R/B/W/T  
2.12.5 Coordinates: 27-57-51.5169N / 82-31-44.3687W  
2.12.6 Threshold Elevation: 17.7 ft  
2.12.6 Touchdown Zone Elevation: 20.5 ft

2.12.1 Designation: 10  
2.12.2 True Bearing: 92  
2.12.3 Dimensions: 6999 ft x 150 ft  
2.12.4 PCN: 61 F/A/W/T  
2.12.5 Coordinates: 27-58-14.9917N / 82-32-9.9027W  
2.12.6 Threshold Elevation: 14.5 ft  
2.12.6 Touchdown Zone Elevation: 21.8 ft

2.12.1 Designation: 28  
2.12.2 True Bearing: 272  
2.12.3 Dimensions: 6999 ft x 150 ft  
2.12.4 PCN: 61 F/A/W/T  
2.12.5 Coordinates: 27-58-12.8902N / 82-30-51.8781W  
2.12.6 Threshold Elevation: 26.4 ft  
2.12.6 Touchdown Zone Elevation: 26.4 ft

#### **AD 2.13 Declared Distances**

2.13.1 Designation: 19R  
2.13.2 Take-off Run Available: 11002  
2.13.3 Take-off Distance Available: 11002  
2.13.4 Accelerate-Stop Distance Available: 11002  
2.13.5 Landing Distance Available: 11002

2.13.1 Designation: 01L  
2.13.2 Take-off Run Available: 11002  
2.13.3 Take-off Distance Available: 11002  
2.13.4 Accelerate-Stop Distance Available: 10800  
2.13.5 Landing Distance Available: 10800

2.13.1 Designation: 19L  
2.13.2 Take-off Run Available: 8300  
2.13.3 Take-off Distance Available: 8300  
2.13.4 Accelerate-Stop Distance Available: 8300  
2.13.5 Landing Distance Available: 8300

2.13.1 Designation: 01R  
2.13.2 Take-off Run Available: 8300  
2.13.3 Take-off Distance Available: 8300  
2.13.4 Accelerate-Stop Distance Available: 8300  
2.13.5 Landing Distance Available: 8300

2.13.1 Designation: 10  
2.13.2 Take-off Run Available: 6999  
2.13.3 Take-off Distance Available: 6999  
2.13.4 Accelerate-Stop Distance Available: 6999  
2.13.5 Landing Distance Available: 6501

2.13.1 Designation: 28  
2.13.2 Take-off Run Available: 6999  
2.13.3 Take-off Distance Available: 6999  
2.13.4 Accelerate-Stop Distance Available: 6501  
2.13.5 Landing Distance Available: 6501

#### **AD 2.14 Approach and Runway Lighting**

2.14.1 Designation: 19R  
2.14.2 Approach Lighting System: MALSR  
2.14.4 Visual Approach Slope Indicator System: P4L

2.14.1 Designation: 01L  
2.14.2 Approach Lighting System: ALSF2  
2.14.4 Visual Approach Slope Indicator System: P4L

2.14.1 Designation: 19L  
2.14.2 Approach Lighting System: ALSF2  
2.14.4 Visual Approach Slope Indicator System: P4L

2.14.1 Designation: 01R  
2.14.2 Approach Lighting System:  
2.14.4 Visual Approach Slope Indicator System: P4L

2.14.1 Designation: 10  
2.14.2 Approach Lighting System:  
2.14.4 Visual Approach Slope Indicator System: P4L

2.14.1 Designation: 28  
2.14.2 Approach Lighting System:  
2.14.4 Visual Approach Slope Indicator System: P4L

#### **AD 2.18 Air Traffic Services Communication Facilities**

2.18.1 Service Designation: APCH/DEP/P (151-219)  
2.18.3 Channel: 134.25  
2.18.5 Hours of Operation: 24

2.18.1 Service Designation: APCH/P DEP/P (001-150)  
2.18.3 Channel: 118.15  
2.18.5 Hours of Operation: 24

2.18.1 Service Designation: APCH/P DEP/P (220-360)  
2.18.3 Channel: 239.3  
2.18.5 Hours of Operation: 24

2.18.1 Service Designation: APCH/P DEP/P (001-150)  
2.18.3 Channel: 279.6  
2.18.5 Hours of Operation: 24

2.18.1 Service Designation: APCH/P DEP/P (151-219)  
2.18.3 Channel: 353.575  
2.18.5 Hours of Operation: 24

2.18.1 Service Designation: APCH/P DEP/P IC  
2.18.3 Channel: 307.175  
2.18.5 Hours of Operation: 24

2.18.1 Service Designation: APCH/P IC  
2.18.3 Channel: 118.5  
2.18.5 Hours of Operation: 24

2.18.1 Service Designation: APCH/S DEP/S  
2.18.3 Channel: 353.75  
2.18.5 Hours of Operation: 24

2.18.1 Service Designation: BAYPO DP  
2.18.3 Channel: 118.8  
2.18.5 Hours of Operation: 24

2.18.1 Service Designation: BAYPO DP  
2.18.3 Channel: 239.3  
2.18.5 Hours of Operation: 24

2.18.1 Service Designation: BLFRG STAR  
2.18.3 Channel: 119.65  
2.18.5 Hours of Operation: 24

2.18.1 Service Designation: BLFRG STAR  
2.18.3 Channel: 353.575  
2.18.5 Hours of Operation: 24

2.18.1 Service Designation: BRDGE STAR  
2.18.3 Channel: 119.65  
2.18.5 Hours of Operation: 24

2.18.1 Service Designation: BRDGE STAR  
2.18.3 Channel: 353.575  
2.18.5 Hours of Operation: 24

2.18.1 Service Designation: CD/P  
2.18.3 Channel: 133.6  
2.18.5 Hours of Operation: 24

2.18.1 Service Designation: CLASS B (151-219)  
2.18.3 Channel: 119.65

2.18.5 Hours of Operation: 24

2.18.1 Service Designation: CLASS B (001-150)

2.18.3 Channel: 119.9

2.18.5 Hours of Operation: 24

2.18.1 Service Designation: CLASS B (220-360)

2.18.3 Channel: 125.3

2.18.5 Hours of Operation: 24

2.18.1 Service Designation: CLASS B (001-150)

2.18.3 Channel: 290.3

2.18.5 Hours of Operation: 24

2.18.1 Service Designation: CLASS B (220-360)

2.18.3 Channel: 316.05

2.18.5 Hours of Operation: 24

2.18.1 Service Designation: CLASS B (151-219)

2.18.3 Channel: 353.575

2.18.5 Hours of Operation: 24

2.18.1 Service Designation: CROWD DP

2.18.3 Channel: 135.5

2.18.5 Hours of Operation: 24

2.18.1 Service Designation: CROWD DP

2.18.3 Channel: 279.6

2.18.5 Hours of Operation: 24

2.18.1 Service Designation: D-ATIS (ARR)

2.18.3 Channel: 126.45

2.18.5 Hours of Operation: 24

2.18.1 Service Designation: D-ATIS (DEP)

2.18.3 Channel: 128.475

2.18.5 Hours of Operation: 24

2.18.1 Service Designation: DADES STAR

2.18.3 Channel: 135.5

2.18.5 Hours of Operation: 24

2.18.1 Service Designation: DADES STAR

2.18.3 Channel: 279.6

2.18.5 Hours of Operation: 24

2.18.1 Service Designation: DEP/P IC (220-360)

2.18.3 Channel: 118.8

2.18.5 Hours of Operation: 24

2.18.1 Service Designation: DORMR DP

2.18.3 Channel: 118.8  
2.18.5 Hours of Operation: 24

2.18.1 Service Designation: DORMR DP  
2.18.3 Channel: 239.3  
2.18.5 Hours of Operation: 24

2.18.1 Service Designation: EMERG  
2.18.3 Channel: 121.5  
2.18.5 Hours of Operation:

2.18.1 Service Designation: EMERG  
2.18.3 Channel: 243  
2.18.5 Hours of Operation:

2.18.1 Service Designation: ENDED DP  
2.18.3 Channel: 118.8  
2.18.5 Hours of Operation: 24

2.18.1 Service Designation: ENDED DP  
2.18.3 Channel: 239.3  
2.18.5 Hours of Operation: 24

2.18.1 Service Designation: GANDY DP  
2.18.3 Channel: 119.65  
2.18.5 Hours of Operation: 24

2.18.1 Service Designation: GANDY DP  
2.18.3 Channel: 353.575  
2.18.5 Hours of Operation: 24

2.18.1 Service Designation: GND/P  
2.18.3 Channel: 121.7  
2.18.5 Hours of Operation: 24

2.18.1 Service Designation: GND/P  
2.18.3 Channel: 269.4  
2.18.5 Hours of Operation: 24

2.18.1 Service Designation: GND/S  
2.18.3 Channel: 121.35  
2.18.5 Hours of Operation: 24

2.18.1 Service Designation: KNOST DP  
2.18.3 Channel: 118.8  
2.18.5 Hours of Operation: 24

2.18.1 Service Designation: KNOST DP  
2.18.3 Channel: 239.3  
2.18.5 Hours of Operation: 24

2.18.1 Service Designation: LCL/P  
2.18.3 Channel: 119.5  
2.18.5 Hours of Operation: 24

2.18.1 Service Designation: LCL/P  
2.18.3 Channel: 269.4  
2.18.5 Hours of Operation: 24

2.18.1 Service Designation: LCL/S  
2.18.3 Channel: 119.05  
2.18.5 Hours of Operation: 24

2.18.1 Service Designation: LGTNG DP  
2.18.3 Channel: 118.8  
2.18.5 Hours of Operation: 24

2.18.1 Service Designation: LGTNG DP  
2.18.3 Channel: 239.3  
2.18.5 Hours of Operation: 24

2.18.1 Service Designation: MAATY STAR  
2.18.3 Channel: 118.8  
2.18.5 Hours of Operation: 24

2.18.1 Service Designation: MAATY STAR  
2.18.3 Channel: 239.3  
2.18.5 Hours of Operation: 24

2.18.1 Service Designation: RAYZZ STAR  
2.18.3 Channel: 118.8  
2.18.5 Hours of Operation: 24

2.18.1 Service Designation: RAYZZ STAR  
2.18.3 Channel: 239.3  
2.18.5 Hours of Operation: 24

2.18.1 Service Designation: TAMPA DP  
2.18.3 Channel: 134.25  
2.18.5 Hours of Operation: 24

2.18.1 Service Designation: TAMPA DP  
2.18.3 Channel: 279.6  
2.18.5 Hours of Operation: 24

**AD 2.19 Radio Navigation and Landing Aids**

2.19.1 ILS Type: DME for runway 01L. Magnetic variation: 5W  
2.19.2 ILS Identification: AMP  
2.19.5 Coordinates: 27-59-43.4N / 82-32-25.65W  
2.19.6 Site Elevation: 20 ft

2.19.1 ILS Type: Glide Slope for runway 01L. Magnetic variation: 5W  
2.19.2 ILS Identification: AMP  
2.19.5 Coordinates: 27-57-58.2392N / 82-32-36.5897W  
2.19.6 Site Elevation: 7.6 ft

2.19.1 ILS Type: Inner Marker for runway 01L. Magnetic variation: 5W  
2.19.2 ILS Identification: AMP  
2.19.5 Coordinates: 27-57-39.6244N / 82-32-32.7564W  
2.19.6 Site Elevation: 6.4 ft

2.19.1 ILS Type: Localizer for runway 01L. Magnetic variation: 5W  
2.19.2 ILS Identification: AMP  
2.19.5 Coordinates: 27-59-44.7869N / 82-32-28.5048W  
2.19.6 Site Elevation: 20.6 ft

2.19.1 ILS Type: DME for runway 19R. Magnetic variation: 5W  
2.19.2 ILS Identification: JRT  
2.19.5 Coordinates: 27-57-37.34N / 82-32-31.94W  
2.19.6 Site Elevation: 5 ft

2.19.1 ILS Type: Glide Slope for runway 19R. Magnetic variation: 5W  
2.19.2 ILS Identification: JRT  
2.19.5 Coordinates: 27-59-26.4582N / 82-32-33.5927W  
2.19.6 Site Elevation: 17.2 ft

2.19.1 ILS Type: Localizer for runway 19R. Magnetic variation: 5W  
2.19.2 ILS Identification: JRT  
2.19.5 Coordinates: 27-57-37.46N / 82-32-32.84W  
2.19.6 Site Elevation: 5 ft

2.19.1 ILS Type: DME for runway 01R. Magnetic variation: 5W  
2.19.2 ILS Identification: TWJ  
2.19.5 Coordinates: 27-59-22.9831N / 82-31-38.4291W  
2.19.6 Site Elevation: 35.9 ft

2.19.1 ILS Type: Localizer for runway 01R. Magnetic variation: 5W  
2.19.2 ILS Identification: TWJ  
2.19.5 Coordinates: 27-59-23.9328N / 82-31-41.2197W  
2.19.6 Site Elevation: 25.6 ft

2.19.1 ILS Type: DME for runway 19L. Magnetic variation: 5W  
2.19.2 ILS Identification: TPA  
2.19.5 Coordinates: 27-57-40.42N / 82-31-40.5W  
2.19.6 Site Elevation: 10 ft

2.19.1 ILS Type: Glide Slope for runway 19L. Magnetic variation: 5W  
2.19.2 ILS Identification: TPA  
2.19.5 Coordinates: 27-59-3.1644N / 82-31-37.4636W  
2.19.6 Site Elevation: 23.8 ft

2.19.1 ILS Type: Inner Marker for runway 19L. Magnetic variation: 5W

2.19.2 ILS Identification: TPA  
2.19.5 Coordinates: 27-59-23.6601N / 82-31-41.2251W  
2.19.6 Site Elevation: 25.7 ft

2.19.1 ILS Type: Localizer for runway 19L. Magnetic variation: 5W  
2.19.2 ILS Identification: TPA  
2.19.5 Coordinates: 27-57-40.972N / 82-31-44.7284W  
2.19.6 Site Elevation: 13.7 ft

**General Remarks:**

TAXILANE G WEST OF TWY B1 CLSD TO WINGSPAN GTR THAN 118 FT – PPR APT OPS.

RWY 19L IS NOISE SENSITIVE TO TBJT DEPARTURES. RWY 01R IS NOISE SENSITIVE TO TBJT ARRIVALS. PUBLD NOISE ABATEMENT PROCS IN EFCT.

BIRD ACT ON AND INVOF ARPT.

TWY F AND TWY R ARE NON-MOVEMENT AREAS. BOTH LOCATIONS ARE UNAVBL FOR GROUP IV ACFT WITH A WINGSPAN GTR THAN 117 FT WO PPR FM ARPT OPS. TWY T PPR FROM ARPT OPS RQRD FOR ACFT WITH A WINGSPAN GTR THAN 90 FT.

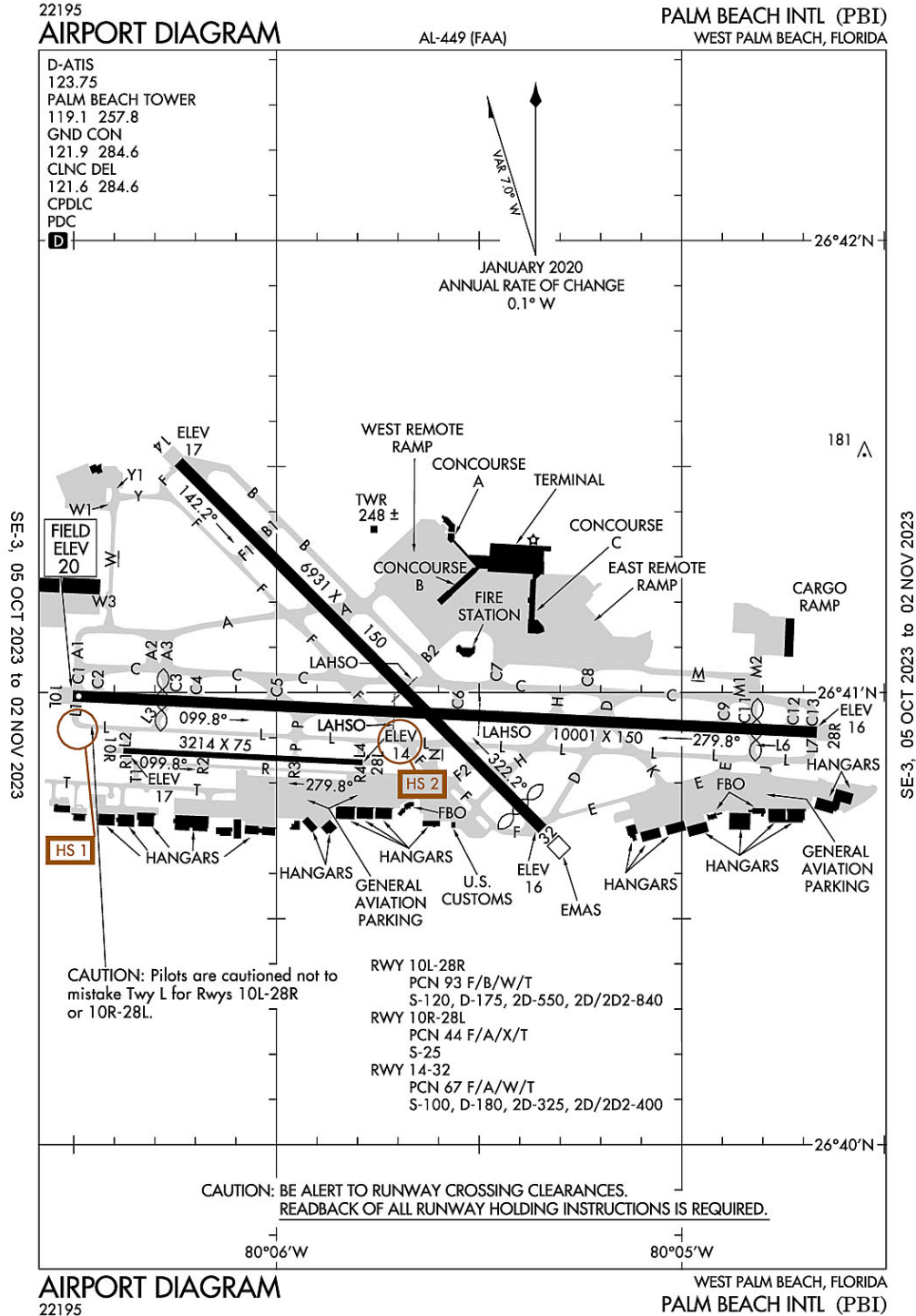
ONLY ACFT WITH PRIOR PMSN MAY USE TRML APN; ALL OTRS USE GA APN.

RSTRS TO ADG IV OR LGR: TWY E1.

RSTRS TO DESIGN GROUP V OR LGR; TWY J BTN TWY J1 AND TWY J2; TWY N WEST OF TWY L AND TWY E NORTH OF TWY J UNAVBL; TAXILANE Z CLSD TO WINGSPAN GTR THAN 171 FT – PPR ARPT OPS.



### West Palm Beach, Florida Palm Beach International ICAO Identifier KPBI



**West Palm Beach, FL**  
**Palm Beach Intl**  
**ICAO Identifier KPBI**

**AD 2.2 Aerodrome geographical and administrative data**

- 2.2.1 Reference Point: 26-40-59.382N / 80-5-44.131W
- 2.2.2 From City: 3 miles W of WEST PALM BEACH, FL
- 2.2.3 Elevation: 19.6 ft
- 2.2.5 Magnetic Variation: 6W (2010)
- 2.2.6 Airport Contact: LAURA BEEBE  
846 PALM BEACH INTL AIRPORT  
WEST PALM BEACH, FL 33406 (561-471-7420)
- 2.2.7 Traffic: IFR/VFR

**AD 2.3 Attendance Schedule**

- 2.3.1 All Months, All Days, All Hours

**AD 2.4 Handling Services and Facilities**

- 2.4.1 Cargo Handling Facilities: YES
- 2.4.2 Fuel Types: 100LL,A
- 2.4.5 Hangar Space:
- 2.4.6 Repair Facilities: MAJOR

**AD 2.6 Rescue and Firefighting Services**

- 2.6.1 Aerodrome Category: Class-I certified on 5/21/1973
- 2.6.2 Rescue and Firefighting Services: ARFF Index-C

**AD 2.12 Runway Physical Characteristics**

- 2.12.1 Designation: 10L
- 2.12.2 True Bearing: 93
- 2.12.3 Dimensions: 10001 ft x 150 ft
- 2.12.4 PCN: 93 F/B/W/T
- 2.12.5 Coordinates: 26-40-59.5493N / 80-6-30.1296W
- 2.12.6 Threshold Elevation: 19.6 ft
- 2.12.6 Touchdown Zone Elevation: 16.3 ft

- 2.12.1 Designation: 28R
- 2.12.2 True Bearing: 273
- 2.12.3 Dimensions: 10001 ft x 150 ft
- 2.12.4 PCN: 93 F/B/W/T
- 2.12.5 Coordinates: 26-40-54.7438N / 80-4-40.0137W
- 2.12.6 Threshold Elevation: 16.4 ft
- 2.12.6 Touchdown Zone Elevation: 18.3 ft

- 2.12.1 Designation: 10R
- 2.12.2 True Bearing: 93
- 2.12.3 Dimensions: 3214 ft x 75 ft
- 2.12.4 PCN: 44 F/A/X/T
- 2.12.5 Coordinates: 26-40-52.282N / 80-6-22.6416W
- 2.12.6 Threshold Elevation: 17.1 ft
- 2.12.6 Touchdown Zone Elevation: 17.2 ft

2.12.1 Designation: 28L  
2.12.2 True Bearing: 273  
2.12.3 Dimensions: 3214 ft x 75 ft  
2.12.4 PCN: 44 F/A/X/T  
2.12.5 Coordinates: 26-40-50.7327N / 80-5-47.2501W  
2.12.6 Threshold Elevation: 13.6 ft  
2.12.6 Touchdown Zone Elevation: 16.9 ft

2.12.1 Designation: 14  
2.12.2 True Bearing: 135  
2.12.3 Dimensions: 6931 ft x 150 ft  
2.12.4 PCN: 67 F/A/W/T  
2.12.5 Coordinates: 26-41-30.596N / 80-6-14.482W  
2.12.6 Threshold Elevation: 17 ft  
2.12.6 Touchdown Zone Elevation: 17.3 ft

2.12.1 Designation: 32  
2.12.2 True Bearing: 315  
2.12.3 Dimensions: 6931 ft x 150 ft  
2.12.4 PCN: 67 F/A/W/T  
2.12.5 Coordinates: 26-40-41.913N / 80-5-20.622W  
2.12.6 Threshold Elevation: 15.8 ft  
2.12.6 Touchdown Zone Elevation: 15.9 ft

#### **AD 2.13 Declared Distances**

2.13.1 Designation: 10L  
2.13.2 Take-off Run Available: 10001  
2.13.3 Take-off Distance Available: 10001  
2.13.4 Accelerate-Stop Distance Available: 10001  
2.13.5 Landing Distance Available: 8800

2.13.1 Designation: 28R  
2.13.2 Take-off Run Available: 10001  
2.13.3 Take-off Distance Available: 10001  
2.13.4 Accelerate-Stop Distance Available: 10001  
2.13.5 Landing Distance Available: 9189

2.13.1 Designation: 10R  
2.13.2 Take-off Run Available: 3214  
2.13.3 Take-off Distance Available: 3214  
2.13.4 Accelerate-Stop Distance Available: 3214  
2.13.5 Landing Distance Available: 3214

2.13.1 Designation: 28L  
2.13.2 Take-off Run Available: 3214  
2.13.3 Take-off Distance Available: 3214  
2.13.4 Accelerate-Stop Distance Available: 3214  
2.13.5 Landing Distance Available: 3214

2.13.1 Designation: 14  
2.13.2 Take-off Run Available: 6926  
2.13.3 Take-off Distance Available: 6926  
2.13.4 Accelerate-Stop Distance Available: 6000  
2.13.5 Landing Distance Available: 6000

2.13.1 Designation: 32  
2.13.2 Take-off Run Available: 6926  
2.13.3 Take-off Distance Available: 6926  
2.13.4 Accelerate-Stop Distance Available: 6926  
2.13.5 Landing Distance Available: 6513

**AD 2.14 Approach and Runway Lighting**

2.14.1 Designation: 10L  
2.14.2 Approach Lighting System: MALSR  
2.14.4 Visual Approach Slope Indicator System: P4R

2.14.1 Designation: 28R  
2.14.2 Approach Lighting System:  
2.14.4 Visual Approach Slope Indicator System: P4L

2.14.1 Designation: 10R  
2.14.2 Approach Lighting System:  
2.14.4 Visual Approach Slope Indicator System:

2.14.1 Designation: 28L  
2.14.2 Approach Lighting System:  
2.14.4 Visual Approach Slope Indicator System:

2.14.1 Designation: 14  
2.14.2 Approach Lighting System:  
2.14.4 Visual Approach Slope Indicator System: P4R

2.14.1 Designation: 32  
2.14.2 Approach Lighting System:  
2.14.4 Visual Approach Slope Indicator System: P4L

**AD 2.18 Air Traffic Services Communication Facilities**

2.18.1 Service Designation: APCH/P DEP/P (SOUTH)  
2.18.3 Channel: 125.2  
2.18.5 Hours of Operation: 24

2.18.1 Service Designation: APCH/P DEP/P (SOUTH)  
2.18.3 Channel: 343.6  
2.18.5 Hours of Operation: 24

2.18.1 Service Designation: APCH/P DEP/P IC  
2.18.3 Channel: 128.3  
2.18.5 Hours of Operation: 24

2.18.1 Service Designation: APCH/P DEP/P IC  
2.18.3 Channel: 317.4  
2.18.5 Hours of Operation: 24

2.18.1 Service Designation: CD/P  
2.18.3 Channel: 121.6  
2.18.5 Hours of Operation: 24

2.18.1 Service Designation: CD/P  
2.18.3 Channel: 284.6  
2.18.5 Hours of Operation: 24

2.18.1 Service Designation: CLASS C (SOUTH)  
2.18.3 Channel: 125.2  
2.18.5 Hours of Operation: 24

2.18.1 Service Designation: CLASS C (NORTH)  
2.18.3 Channel: 128.3  
2.18.5 Hours of Operation: 24

2.18.1 Service Designation: CLASS C (NORTH)  
2.18.3 Channel: 317.4  
2.18.5 Hours of Operation: 24

2.18.1 Service Designation: CLASS C (SOUTH)  
2.18.3 Channel: 343.6  
2.18.5 Hours of Operation: 24

2.18.1 Service Designation: CLMNT STAR  
2.18.3 Channel: 124.6  
2.18.5 Hours of Operation: 24

2.18.1 Service Designation: CLMNT STAR  
2.18.3 Channel: 317.4  
2.18.5 Hours of Operation: 24

2.18.1 Service Designation: CPTAN STAR  
2.18.3 Channel: 124.6  
2.18.5 Hours of Operation: 24

2.18.1 Service Designation: CPTAN STAR  
2.18.3 Channel: 317.4  
2.18.5 Hours of Operation: 24

2.18.1 Service Designation: D-ATIS  
2.18.3 Channel: 123.75  
2.18.5 Hours of Operation: 24

2.18.1 Service Designation: EMERG  
2.18.3 Channel: 121.5

2.18.5 Hours of Operation:

2.18.1 Service Designation: EMERG

2.18.3 Channel: 243

2.18.5 Hours of Operation:

2.18.1 Service Designation: GND/P

2.18.3 Channel: 121.9

2.18.5 Hours of Operation: 24

2.18.1 Service Designation: GND/P

2.18.3 Channel: 284.6

2.18.5 Hours of Operation: 24

2.18.1 Service Designation: JESTR STAR

2.18.3 Channel: 124.6

2.18.5 Hours of Operation: 24

2.18.1 Service Designation: JESTR STAR

2.18.3 Channel: 317.4

2.18.5 Hours of Operation: 24

2.18.1 Service Designation: LCL/P

2.18.3 Channel: 119.1

2.18.5 Hours of Operation: 24

2.18.1 Service Designation: LCL/P

2.18.3 Channel: 257.8

2.18.5 Hours of Operation: 24

2.18.1 Service Designation: LCL/S

2.18.3 Channel: 118.75

2.18.5 Hours of Operation: 24

2.18.1 Service Designation: LCL/S

2.18.3 Channel: 384.6

2.18.5 Hours of Operation: 24

2.18.1 Service Designation: MAHHI STAR

2.18.3 Channel: 127.35

2.18.5 Hours of Operation: 24

2.18.1 Service Designation: MAHHI STAR

2.18.3 Channel: 343.6

2.18.5 Hours of Operation: 24

2.18.1 Service Designation: MELBOURNE STAR

2.18.3 Channel: 124.6

2.18.5 Hours of Operation: 24

2.18.1 Service Designation: MELBOURNE STAR

2.18.3 Channel: 317.4

2.18.5 Hours of Operation: 24

2.18.1 Service Designation: MIXAE DP (RWY 10L, 14)

2.18.3 Channel: 127.35

2.18.5 Hours of Operation: 24

2.18.1 Service Designation: MIXAE DP (RWY 28R, 32)

2.18.3 Channel: 128.3

2.18.5 Hours of Operation: 24

2.18.1 Service Designation: MIXAE DP (RWY 28R, 32)

2.18.3 Channel: 317.4

2.18.5 Hours of Operation: 24

2.18.1 Service Designation: MIXAE DP (RWY 10L, 14)

2.18.3 Channel: 343.6

2.18.5 Hours of Operation: 24

2.18.1 Service Designation: OLAKE DP

2.18.3 Channel: 128.3

2.18.5 Hours of Operation: 24

2.18.1 Service Designation: OLAKE DP

2.18.3 Channel: 317.4

2.18.5 Hours of Operation: 24

2.18.1 Service Designation: PALM BEACH DP (SOUTH)

2.18.3 Channel: 127.35

2.18.5 Hours of Operation: 24

2.18.1 Service Designation: PALM BEACH DP (NORTH)

2.18.3 Channel: 128.3

2.18.5 Hours of Operation: 24

2.18.1 Service Designation: PALM BEACH DP (NORTH)

2.18.3 Channel: 317.4

2.18.5 Hours of Operation: 24

2.18.1 Service Designation: PALM BEACH DP (SOUTH)

2.18.3 Channel: 343.6

2.18.5 Hours of Operation: 24

2.18.1 Service Designation: SLIDZ DP

2.18.3 Channel: 128.3

2.18.5 Hours of Operation: 24

2.18.1 Service Designation: SLIDZ DP

2.18.3 Channel: 317.4

2.18.5 Hours of Operation: 24

2.18.1 Service Designation: STOOB STAR  
2.18.3 Channel: 124.6  
2.18.5 Hours of Operation: 24

2.18.1 Service Designation: STOOB STAR  
2.18.3 Channel: 317.4  
2.18.5 Hours of Operation: 24

2.18.1 Service Designation: TBIRD DP  
2.18.3 Channel: 128.3  
2.18.5 Hours of Operation: 24

2.18.1 Service Designation: TBIRD DP  
2.18.3 Channel: 317.4  
2.18.5 Hours of Operation: 24

2.18.1 Service Designation: TTYLR STAR  
2.18.3 Channel: 125.2  
2.18.5 Hours of Operation: 24

2.18.1 Service Designation: TTYLR STAR  
2.18.3 Channel: 317.4  
2.18.5 Hours of Operation: 24

2.18.1 Service Designation: VUUDU STAR  
2.18.3 Channel: 127.35  
2.18.5 Hours of Operation: 24

2.18.1 Service Designation: VUUDU STAR  
2.18.3 Channel: 317.4  
2.18.5 Hours of Operation: 24

2.18.1 Service Designation: WELLY DP  
2.18.3 Channel: 127.35  
2.18.5 Hours of Operation: 24

2.18.1 Service Designation: WELLY DP  
2.18.3 Channel: 343.6  
2.18.5 Hours of Operation: 24

**AD 2.19 Radio Navigation and Landing Aids**

2.19.1 ILS Type: DME for runway 10L. Magnetic variation: 6W  
2.19.2 ILS Identification: PBI  
2.19.5 Coordinates: 26-40-51.4319N / 80-4-29.0092W  
2.19.6 Site Elevation: 23.3 ft

2.19.1 ILS Type: Glide Slope for runway 10L. Magnetic variation: 6W  
2.19.2 ILS Identification: PBI  
2.19.5 Coordinates: 26-40-55.9795N / 80-6-6.0748W  
2.19.6 Site Elevation: 14.5 ft



2.19.1 ILS Type: Localizer for runway 10L. Magnetic variation: 6W  
2.19.2 ILS Identification: PBI  
2.19.5 Coordinates: 26-40-54.2434N / 80-4-28.6079W  
2.19.6 Site Elevation: 13 ft

2.19.1 ILS Type: Glide Slope for runway 28R. Magnetic variation: 6W  
2.19.2 ILS Identification: PWB  
2.19.5 Coordinates: 26-40-53.0853N / 80-5-1.7298W  
2.19.6 Site Elevation: 13.5 ft

2.19.1 ILS Type: Localizer for runway 28R. Magnetic variation: 6W  
2.19.2 ILS Identification: PWB  
2.19.5 Coordinates: 26-40-59.9773N / 80-6-39.9822W  
2.19.6 Site Elevation: 18.5 ft

2.19.1 Navigation Aid Type: VORTAC. Magnetic variation: 3W  
2.19.2 Navigation Aid Identification: PBI  
2.19.5 Coordinates: 26-40-48.198N / 80-5-11.3586W  
2.19.6 Site Elevation: 15.7 ft

**General Remarks:**

BE ALERT: TWY L IS LCTD BTWN RYS 10L/28R & 10R/28L. TWY L IS WIDER AND LONGER THAN RY 10R/28L - DO NOT CONFUSE TWY L FOR RY. AIRCRAFT WITH WINGSPAN OF 118 FT OR GREATER IS PROHIBITED ON TWY L.

ACFT WITH WINGSPANS GTR THAN 118 FT MAY NOT OPR ON TWY E, TWY W, TWY Y AND TWY F NW OF TWY A.

ACFT WITH WINGSPANS GTR THAN 49 MAY NOT OPER SIMUL ON RWY 10R/28L AND TWY R.

24 HR PPR FOR ACFT WITH WINGSPANS GTR THAN 171 FT.

RWY 10R/28L NOT AVBL FOR SKED ACR OPS WITH MORE THAN 9 PAX SEATS OR UNSKED ACR AT LEAST 31 PAX SEATS.

RWY 10L/28R SAFETY AREA NOT STD SFC VARNS.

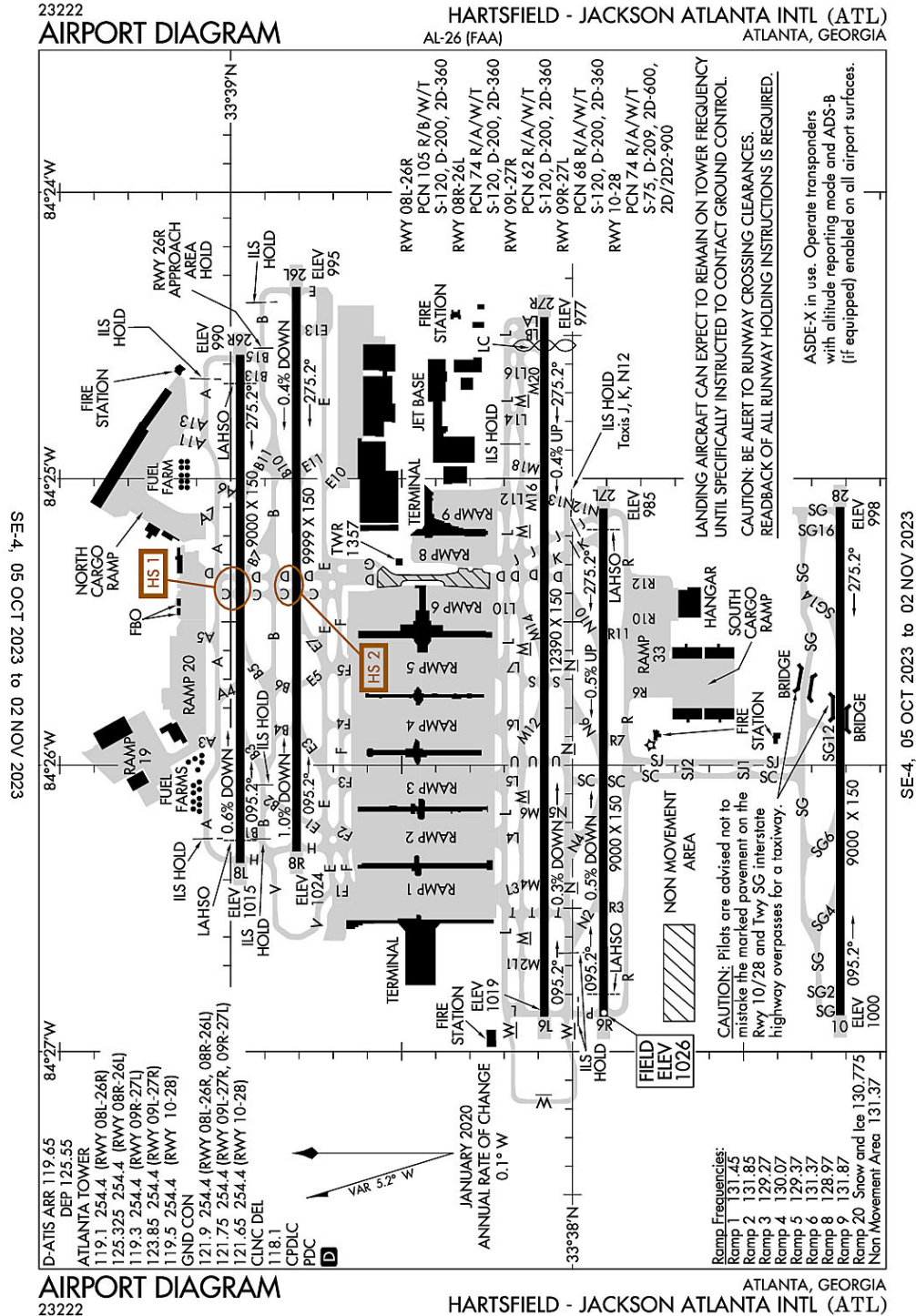
NOISE ABATEMENT PROCEDURES IN EFFECT. MULTIENGINE FLIGHT TRAINING PROHIBITED SS TO SR SUN AND HOLIDAY; STRICT ENVIRONMENTAL OPERATING STAGE 2 ACFT 0300-1200Z CALL NOISE ABATEMENT OFFICER 561-471-7467.

BE ALERT; RYS 28L & 28R THLDS STAGGERED BY 5400 FT.

RWY 14/32 SAFETY AREA NOT STD SFC VARNS.

MIGRATORY BIRDS ON AND INVOF ARPT.

Atlanta, Georgia  
Hartsfield-Jackson Atlanta International  
ICAO Identifier KATL



**Atlanta, GA**  
**Hartsfield – Jackson Atlanta Intl**  
**ICAO Identifier KATL**

**AD 2.2 Aerodrome geographical and administrative data**

- 2.2.1 Reference Point: 33-38-12.1186N / 84-25-40.3104W
- 2.2.2 From City: 7 miles S of ATLANTA, GA
- 2.2.3 Elevation: 1026.2 ft
- 2.2.5 Magnetic Variation: 5W (2015)
- 2.2.6 Airport Contact: BALRAM BHEODARI  
PO BOX 20509  
ATLANTA, GA 30320 (404-530-6600)
- 2.2.7 Traffic: IFR/VFR

**AD 2.3 Attendance Schedule**

- 2.3.1 All Months, All Days, All Hours

**AD 2.4 Handling Services and Facilities**

- 2.4.1 Cargo Handling Facilities: YES
- 2.4.2 Fuel Types: 100,100LL,A
- 2.4.5 Hangar Space: YES
- 2.4.6 Repair Facilities: MAJOR

**AD 2.6 Rescue and Firefighting Services**

- 2.6.1 Aerodrome Category: Class-I certified on 5/1/1973
- 2.6.2 Rescue and Firefighting Services: ARFF Index-E

**AD 2.12 Runway Physical Characteristics**

- 2.12.1 Designation: 08L
- 2.12.2 True Bearing: 90
- 2.12.3 Dimensions: 9000 ft x 150 ft
- 2.12.4 PCN: 105 R/B/W/T
- 2.12.5 Coordinates: 33-38-58.3238N / 84-26-20.4923W
- 2.12.6 Threshold Elevation: 1014.6 ft
- 2.12.6 Touchdown Zone Elevation: 1014.6 ft

- 2.12.1 Designation: 26R
- 2.12.2 True Bearing: 270
- 2.12.3 Dimensions: 9000 ft x 150 ft
- 2.12.4 PCN: 105 R/B/W/T
- 2.12.5 Coordinates: 33-38-58.3515N / 84-24-34.0341W
- 2.12.6 Threshold Elevation: 990 ft
- 2.12.6 Touchdown Zone Elevation: 990 ft

- 2.12.1 Designation: 08R

2.12.2 True Bearing: 90  
2.12.3 Dimensions: 9999 ft x 150 ft  
2.12.4 PCN: 74 R/A/W/T  
2.12.5 Coordinates: 33-38-48.432N / 84-26-18.1035W  
2.12.6 Threshold Elevation: 1023.7 ft  
2.12.6 Touchdown Zone Elevation: 1023.8 ft

2.12.1 Designation: 26L  
2.12.2 True Bearing: 270  
2.12.3 Dimensions: 9999 ft x 150 ft  
2.12.4 PCN: 74 R/A/W/T  
2.12.5 Coordinates: 33-38-48.4612N / 84-24-19.8313W  
2.12.6 Threshold Elevation: 995.4 ft  
2.12.6 Touchdown Zone Elevation: 995.5 ft

2.12.1 Designation: 27R  
2.12.2 True Bearing: 270  
2.12.3 Dimensions: 12390 ft x 150 ft  
2.12.4 PCN: 62 R/A/W/T  
2.12.5 Coordinates: 33-38-4.929N / 84-24-26.158W  
2.12.6 Threshold Elevation: 977.2 ft  
2.12.6 Touchdown Zone Elevation: 984.6 ft

2.12.1 Designation: 09L  
2.12.2 True Bearing: 90  
2.12.3 Dimensions: 12390 ft x 150 ft  
2.12.4 PCN: 62 R/A/W/T  
2.12.5 Coordinates: 33-38-4.936N / 84-26-52.6807W  
2.12.6 Threshold Elevation: 1018.7 ft  
2.12.6 Touchdown Zone Elevation: 1018.7 ft

2.12.1 Designation: 09R  
2.12.2 True Bearing: 90  
2.12.3 Dimensions: 9000 ft x 150 ft  
2.12.4 PCN: 68 R/A/W/T  
2.12.5 Coordinates: 33-37-54.5282N / 84-26-52.6768W  
2.12.6 Threshold Elevation: 1026.1 ft  
2.12.6 Touchdown Zone Elevation: 1026.2 ft

2.12.1 Designation: 27L  
2.12.2 True Bearing: 270  
2.12.3 Dimensions: 9000 ft x 150 ft  
2.12.4 PCN: 68 R/A/W/T  
2.12.5 Coordinates: 33-37-54.5649N / 84-25-6.243W

2.12.6 Threshold Elevation: 984.7 ft  
2.12.6 Touchdown Zone Elevation: 998.9 ft

2.12.1 Designation: 28  
2.12.2 True Bearing: 270  
2.12.3 Dimensions: 9000 ft x 150 ft  
2.12.4 PCN: 74 R/A/W/T  
2.12.5 Coordinates: 33-37-13.0275N / 84-25-5.9358W  
2.12.6 Threshold Elevation: 997.5 ft  
2.12.6 Touchdown Zone Elevation: 997.5 ft

2.12.1 Designation: 10  
2.12.2 True Bearing: 90  
2.12.3 Dimensions: 9000 ft x 150 ft  
2.12.4 PCN: 74 R/A/W/T  
2.12.5 Coordinates: 33-37-12.9808N / 84-26-52.3574W  
2.12.6 Threshold Elevation: 1000.3 ft  
2.12.6 Touchdown Zone Elevation: 1000.3 ft

#### **AD 2.13 Declared Distances**

2.13.1 Designation: 08L  
2.13.2 Take-off Run Available: 9000  
2.13.3 Take-off Distance Available: 9000  
2.13.4 Accelerate-Stop Distance Available: 8800  
2.13.5 Landing Distance Available: 8800

2.13.1 Designation: 26R  
2.13.2 Take-off Run Available: 9000  
2.13.3 Take-off Distance Available: 9000  
2.13.4 Accelerate-Stop Distance Available: 8500  
2.13.5 Landing Distance Available: 8500

2.13.1 Designation: 08R  
2.13.2 Take-off Run Available: 9999  
2.13.3 Take-off Distance Available: 10999  
2.13.4 Accelerate-Stop Distance Available: 9999  
2.13.5 Landing Distance Available: 9999

2.13.1 Designation: 26L  
2.13.2 Take-off Run Available: 9999  
2.13.3 Take-off Distance Available: 9999  
2.13.4 Accelerate-Stop Distance Available: 9999  
2.13.5 Landing Distance Available: 9999

2.13.1 Designation: 27R  
2.13.2 Take-off Run Available: 12390  
2.13.3 Take-off Distance Available: 12390  
2.13.4 Accelerate-Stop Distance Available: 12390  
2.13.5 Landing Distance Available: 11890

2.13.1 Designation: 09L  
2.13.2 Take-off Run Available: 12390  
2.13.3 Take-off Distance Available: 12390  
2.13.4 Accelerate-Stop Distance Available: 11730  
2.13.5 Landing Distance Available: 11730

2.13.1 Designation: 09R  
2.13.2 Take-off Run Available: 9000  
2.13.3 Take-off Distance Available: 9000  
2.13.4 Accelerate-Stop Distance Available: 9000  
2.13.5 Landing Distance Available: 9000

2.13.1 Designation: 27L  
2.13.2 Take-off Run Available: 9000  
2.13.3 Take-off Distance Available: 9000  
2.13.4 Accelerate-Stop Distance Available: 8865  
2.13.5 Landing Distance Available: 8865

2.13.1 Designation: 28  
2.13.2 Take-off Run Available: 9000  
2.13.3 Take-off Distance Available: 9000  
2.13.4 Accelerate-Stop Distance Available: 9000  
2.13.5 Landing Distance Available: 9000

2.13.1 Designation: 10  
2.13.2 Take-off Run Available: 9000  
2.13.3 Take-off Distance Available: 9000  
2.13.4 Accelerate-Stop Distance Available: 9000  
2.13.5 Landing Distance Available: 9000

**AD 2.14 Approach and Runway Lighting**

2.14.1 Designation: 08L  
2.14.2 Approach Lighting System: ALSF2  
2.14.4 Visual Approach Slope Indicator System: P4L

2.14.1 Designation: 26R

2.14.2 Approach Lighting System: MALSR  
2.14.4 Visual Approach Slope Indicator System: P4L

2.14.1 Designation: 08R  
2.14.2 Approach Lighting System:  
2.14.4 Visual Approach Slope Indicator System: P4L

2.14.1 Designation: 26L  
2.14.2 Approach Lighting System: MALSR  
2.14.4 Visual Approach Slope Indicator System: P4L

2.14.1 Designation: 27R  
2.14.2 Approach Lighting System: MALS  
2.14.4 Visual Approach Slope Indicator System: P4R

2.14.1 Designation: 09L  
2.14.2 Approach Lighting System:  
2.14.4 Visual Approach Slope Indicator System: P4R

2.14.1 Designation: 09R  
2.14.2 Approach Lighting System: ALSF2  
2.14.4 Visual Approach Slope Indicator System: P4L

2.14.1 Designation: 27L  
2.14.2 Approach Lighting System: ALSF2  
2.14.4 Visual Approach Slope Indicator System: P4R

2.14.1 Designation: 28  
2.14.2 Approach Lighting System: ALSF2  
2.14.4 Visual Approach Slope Indicator System: P4R

2.14.1 Designation: 10  
2.14.2 Approach Lighting System: ALSF2  
2.14.4 Visual Approach Slope Indicator System: P4R

### **AD 2.18 Air Traffic Services Communication Facilities**

2.18.1 Service Designation: CD/P  
2.18.3 Channel: 118.1  
2.18.5 Hours of Operation: 24

2.18.1 Service Designation: D-ATIS (ARR)  
2.18.3 Channel: 119.65  
2.18.5 Hours of Operation: 24

2.18.1 Service Designation: D-ATIS (DEP)

2.18.3 Channel: 125.55

2.18.5 Hours of Operation: 24

2.18.1 Service Designation: EMERG

2.18.3 Channel: 121.5

2.18.5 Hours of Operation:

2.18.1 Service Designation: EMERG

2.18.3 Channel: 243

2.18.5 Hours of Operation:

2.18.1 Service Designation: GND/P (RWY 10/28)

2.18.3 Channel: 121.65

2.18.5 Hours of Operation: 24

2.18.1 Service Designation: GND/P (RWY 09L/27R, 09R/27L)

2.18.3 Channel: 121.75

2.18.5 Hours of Operation: 24

2.18.1 Service Designation: GND/P (RWY 08L/26R, 08R/26L)

2.18.3 Channel: 121.9

2.18.5 Hours of Operation: 24

2.18.1 Service Designation: GND/P

2.18.3 Channel: 254.4

2.18.5 Hours of Operation: 24

2.18.1 Service Designation: LCL/P (RWY 08L/26R)

2.18.3 Channel: 119.1

2.18.5 Hours of Operation: 24

2.18.1 Service Designation: LCL/P (RWY 09R/27L)

2.18.3 Channel: 119.3

2.18.5 Hours of Operation: 24

2.18.1 Service Designation: LCL/P (RWY 10/28)

2.18.3 Channel: 119.5

2.18.5 Hours of Operation: 24

2.18.1 Service Designation: LCL/P (RWY 09L/27R)

2.18.3 Channel: 123.85

2.18.5 Hours of Operation: 24



2.18.1 Service Designation: LCL/P (RWY 08R/26L)

2.18.3 Channel: 125.325

2.18.5 Hours of Operation: 24

2.18.1 Service Designation: LCL/P

2.18.3 Channel: 254.4

2.18.5 Hours of Operation: 24

2.18.1 Service Designation: PRM (RWY 08L/26R, 08R/26L)

2.18.3 Channel: 126.9

2.18.5 Hours of Operation: 24

2.18.1 Service Designation: PRM (RWY 09L/27R, 09R/27L)

2.18.3 Channel: 132.55

2.18.5 Hours of Operation: 24

2.18.1 Service Designation: PRM (RWY 10/28)

2.18.3 Channel: 133.425

2.18.5 Hours of Operation: 24

#### **AD 2.19 Radio Navigation and Landing Aids**

2.19.1 ILS Type: DME for runway 08L. Magnetic variation: 5W

2.19.2 ILS Identification: HFW

2.19.5 Coordinates: 33-39-1.782N / 84-24-24.7032W

2.19.6 Site Elevation: 977.2 ft

2.19.1 ILS Type: Glide Slope for runway 08L. Magnetic variation: 5W

2.19.2 ILS Identification: HFW

2.19.5 Coordinates: 33-39-2.288N / 84-26-6.3042W

2.19.6 Site Elevation: 1001.7 ft

2.19.1 ILS Type: Inner Marker for runway 08L. Magnetic variation: 5W

2.19.2 ILS Identification: HFW

2.19.5 Coordinates: 33-38-58.3145N / 84-26-30.5173W

2.19.6 Site Elevation: 1017.7 ft

2.19.1 ILS Type: Localizer for runway 08L. Magnetic variation: 5W

2.19.2 ILS Identification: HFW

2.19.5 Coordinates: 33-38-58.3506N / 84-24-23.3901W

2.19.6 Site Elevation: 985.2 ft

2.19.1 ILS Type: DME for runway 26R. Magnetic variation: 5W

2.19.2 ILS Identification: GXZ

2.19.5 Coordinates: 33-38-53.87N / 84-26-32.61W

2.19.6 Site Elevation: 1008 ft

2.19.1 ILS Type: Glide Slope for runway 26R. Magnetic variation: 5W

2.19.2 ILS Identification: GXZ

2.19.5 Coordinates: 33-39-2.3139N / 84-24-47.6304W

2.19.6 Site Elevation: 983.8 ft

2.19.1 ILS Type: Localizer for runway 26R. Magnetic variation: 5W

2.19.2 ILS Identification: GXZ

2.19.5 Coordinates: 33-38-58.32N / 84-26-30.19W

2.19.6 Site Elevation: 1016 ft

2.19.1 ILS Type: DME for runway 08R. Magnetic variation: 5W

2.19.2 ILS Identification: ATL

2.19.5 Coordinates: 33-38-45.7727N / 84-24-7.5608W

2.19.6 Site Elevation: 992.1 ft

2.19.1 ILS Type: Glide Slope for runway 08R. Magnetic variation: 5W

2.19.2 ILS Identification: ATL

2.19.5 Coordinates: 33-38-52.4042N / 84-26-3.334W

2.19.6 Site Elevation: 1005 ft

2.19.1 ILS Type: Localizer for runway 08R. Magnetic variation: 5W

2.19.2 ILS Identification: ATL

2.19.5 Coordinates: 33-38-48.4575N / 84-24-7.5394W

2.19.6 Site Elevation: 986.8 ft

2.19.1 ILS Type: DME for runway 26L. Magnetic variation: 5W

2.19.2 ILS Identification: BRU

2.19.5 Coordinates: 33-38-49.0988N / 84-26-30.1749W

2.19.6 Site Elevation: 1030.3 ft

2.19.1 ILS Type: Glide Slope for runway 26L. Magnetic variation: 5W

2.19.2 ILS Identification: BRU

2.19.5 Coordinates: 33-38-52.4111N / 84-24-32.8404W

2.19.6 Site Elevation: 993.7 ft

2.19.1 ILS Type: Localizer for runway 26L. Magnetic variation: 5W

2.19.2 ILS Identification: BRU

2.19.5 Coordinates: 33-38-48.4526N / 84-26-30.1664W

2.19.6 Site Elevation: 1021 ft

2.19.1 ILS Type: DME for runway 09L. Magnetic variation: 5W

2.19.2 ILS Identification: HZK

2.19.5 Coordinates: 33-38-7.48N / 84-24-44.38W

2.19.6 Site Elevation: 978 ft

2.19.1 ILS Type: Glide Slope for runway 09L. Magnetic variation: 5W

2.19.2 ILS Identification: HZK

2.19.5 Coordinates: 33-38-2.42N / 84-26-39.67W

2.19.6 Site Elevation: 1014.6 ft

2.19.1 ILS Type: Localizer for runway 09L. Magnetic variation: 5W

2.19.2 ILS Identification: HZK

2.19.5 Coordinates: 33-38-4.94N / 84-24-19.08W

2.19.6 Site Elevation: 949.5 ft

2.19.1 ILS Type: Outer Marker for runway 09L. Magnetic variation: 5W

2.19.2 ILS Identification: HZK

2.19.5 Coordinates: 33-37-57.073N / 84-32-3.073W

2.19.6 Site Elevation:

2.19.1 ILS Type: Glide Slope for runway 27R. Magnetic variation: 5W

2.19.2 ILS Identification: AFA

2.19.5 Coordinates: 33-38-7.45N / 84-24-44.13W

2.19.6 Site Elevation: 977.7 ft

2.19.1 ILS Type: Localizer for runway 27R. Magnetic variation: 5W

2.19.2 ILS Identification: AFA

2.19.5 Coordinates: 33-38-4.931N / 84-27-2.2719W

2.19.6 Site Elevation: 1019.5 ft

2.19.1 ILS Type: DME for runway 09R. Magnetic variation: 5W

2.19.2 ILS Identification: FUN

2.19.5 Coordinates: 33-37-56.6292N / 84-24-54.2376W

2.19.6 Site Elevation: 995.5 ft

2.19.1 ILS Type: Glide Slope for runway 09R. Magnetic variation: 5W

2.19.2 ILS Identification: FUN

2.19.5 Coordinates: 33-37-58.482N / 84-26-39.0507W

2.19.6 Site Elevation: 1019.1 ft

2.19.1 ILS Type: Inner Marker for runway 09R. Magnetic variation: 5W

2.19.2 ILS Identification: FUN

2.19.5 Coordinates: 33-37-54.5222N / 84-27-2.5364W

2.19.6 Site Elevation: 1029.2 ft

2.19.1 ILS Type: Localizer for runway 09R. Magnetic variation: 5W

2.19.2 ILS Identification: FUN

2.19.5 Coordinates: 33-37-54.5664N / 84-24-52.6064W

2.19.6 Site Elevation: 976.2 ft

2.19.1 ILS Type: DME for runway 27L. Magnetic variation: 5W

2.19.2 ILS Identification: FSQ

2.19.5 Coordinates: 33-37-53.7N / 84-27-3.53W

2.19.6 Site Elevation: 1003.8 ft

2.19.1 ILS Type: Glide Slope for runway 27L. Magnetic variation: 5W

2.19.2 ILS Identification: FSQ

2.19.5 Coordinates: 33-37-58.5048N / 84-25-18.9643W

2.19.6 Site Elevation: 986.7 ft

2.19.1 ILS Type: Inner Marker for runway 27L. Magnetic variation: 5W

2.19.2 ILS Identification: FSQ

2.19.5 Coordinates: 33-37-54.59N / 84-24-52.99W

2.19.6 Site Elevation: 983 ft

2.19.1 ILS Type: Localizer for runway 27L. Magnetic variation: 5W

2.19.2 ILS Identification: FSQ

2.19.5 Coordinates: 33-37-54.53N / 84-27-3.03W

2.19.6 Site Elevation: 1015.7 ft

2.19.1 ILS Type: DME for runway 10. Magnetic variation: 5W

2.19.2 ILS Identification: OMO

2.19.5 Coordinates: 33-37-12.4476N / 84-24-53.9549W

2.19.6 Site Elevation: 999.7 ft

2.19.1 ILS Type: Glide Slope for runway 10. Magnetic variation: 5W

2.19.2 ILS Identification: OMO

2.19.5 Coordinates: 33-37-8.9408N / 84-26-38.7669W

2.19.6 Site Elevation: 985.4 ft

2.19.1 ILS Type: Inner Marker for runway 10. Magnetic variation: 5W

2.19.2 ILS Identification: OMO

2.19.5 Coordinates: 33-37-12.9816N / 84-27-2.5224W

2.19.6 Site Elevation: 1001 ft

2.19.1 ILS Type: Localizer for runway 10. Magnetic variation: 5W

2.19.2 ILS Identification: OMO

2.19.5 Coordinates: 33-37-13.0192N / 84-24-53.9594W

2.19.6 Site Elevation: 991.1 ft

2.19.1 ILS Type: DME for runway 28. Magnetic variation: 5W

2.19.2 ILS Identification: PKU

2.19.5 Coordinates: 33-37-12.4016N / 84-27-5.3143W

2.19.6 Site Elevation: 1003.5 ft

2.19.1 ILS Type: Glide Slope for runway 28. Magnetic variation: 5W

2.19.2 ILS Identification: PKU

2.19.5 Coordinates: 33-37-17.0569N / 84-25-18.9449W

2.19.6 Site Elevation: 989.2 ft

2.19.1 ILS Type: Inner Marker for runway 28. Magnetic variation: 5W

2.19.2 ILS Identification: PKU

2.19.5 Coordinates: 33-37-13.0151N / 84-24-55.769W

2.19.6 Site Elevation: 982.2 ft

2.19.1 ILS Type: Localizer for runway 28. Magnetic variation: 5W

2.19.2 ILS Identification: PKU

2.19.5 Coordinates: 33-37-12.9761N / 84-27-5.3149W

2.19.6 Site Elevation: 994.5 ft

**General Remarks:**

ALL RWYS, TOUCH AND GO OPERATIONS, LOW APPROACHES, AND PRACTICE INSTRUMENT APPROACHES NOT PERMITTED.

ACFT WITH WINGSPAN GREATER THAN 214 FT SHOULD EXPECT TO USE RWYS 09L/27R AND 9R/27L.

NO ACFT WITH WINGSPAN GEATER THAN OR EQUAL TO 225 FT MAY TAXI ON TWY M BETWEEN L14 AND L16, TWY N BETWEEN P AND SC, AND TWY N BETWEEN U AND K.

ALL ACFT WITH WINGSPANS GREATER THAN 214 FT ARE REQUIRED TO USE TAXI SPEEDS NOT GREATER THAN 15 MPH ON TWYS A, L, M, AND SJ.

WHEN ACFT WITH WINGSPANS GREATER THAN 214 FT ARE PRESENT ON THE FIELD, ALL OTHER ACFT MUST ADHERE TO THE TWY CENTERLINE ON TWYS L AND M, TWYS E AND F, AND TWYS SC AND SJ BETWEEN SG AND R DUE TO SEPARATION BETWEEN THE PARALLEL TWYS.

RUNUPS ARE PERMITTED AT VARIOUS SITES; COORD USE OF CITY FACS, MOVEMENT AREAS, ALLOWABLE NON-MOVEMENT AREAS WITH DEPT OF AVN OPNS, 404-787-6095; AND COORD THE USE OF THE AIRLINES FACS WITH THEM.

NOISE & OPNS MONITORING SYSTEM (NOMS) PROGRAM IN EFFECT; CALL THE ATLANTA DEPT OF AVIATION 770-43-NOISE OR 770-436-6473 FOR MORE INFO.

BE ALERT TO RWY CROSSING CLEARANCES. READBACK OF ALL RWY HOLDING INSTRUCTIONS IS REQUIRED.

ACFT WITH WINGSPAN GTR THAN 171 FT AND/OR TAIL HGT GTR THAN 45 FT ARE RSTD FROM USING TWY W. DURG TWY W OPNS RWY 27R INTXN DEPS FROM TWY LB OR TWY LC CAN EXPC THE FLWG DSTCS

WITH RWY RMNG: FROM TWY LB 11,040 FT (TORA/TODA) AND 12,140 FT (ASDA); FROM TWY LC 10,810 FT (TODA/TODA) AND 11,910 FT (ASDA). ACFT MAY REQ THE FULL LEN OF RWY 27R FOR DEP UPON INITIAL CTC WITH ATC.

GROUP VI ACFT (LOCKHEED GALAXY C-5; ANTONOV AN-124 & AN-125) WITH A WINGSPAN OF GREATER THAN 214 FT ARE RESTRICTED FM USING TWY F EAST OF RAMP 5 NORTH AND WEST OF TWY D.

RWY 9L DEPARTURES CAN EXPECT INTERSECTION DEPARTURE FM M2 WITH RWY REMAINING 11,440 FT (TORA/TODA) AND 10,780 (ASDA).

TWO ACFT WITH WINGSPANS GREATER THAN OR EQUAL TO 225 FT MAY NOT TAXISIMULTANEOUSLY ON ADJACENT PARALLEL TWYS L/M EXCEPT WEST OF L7 AT SPEEDS LESS THAN 15 MPH.

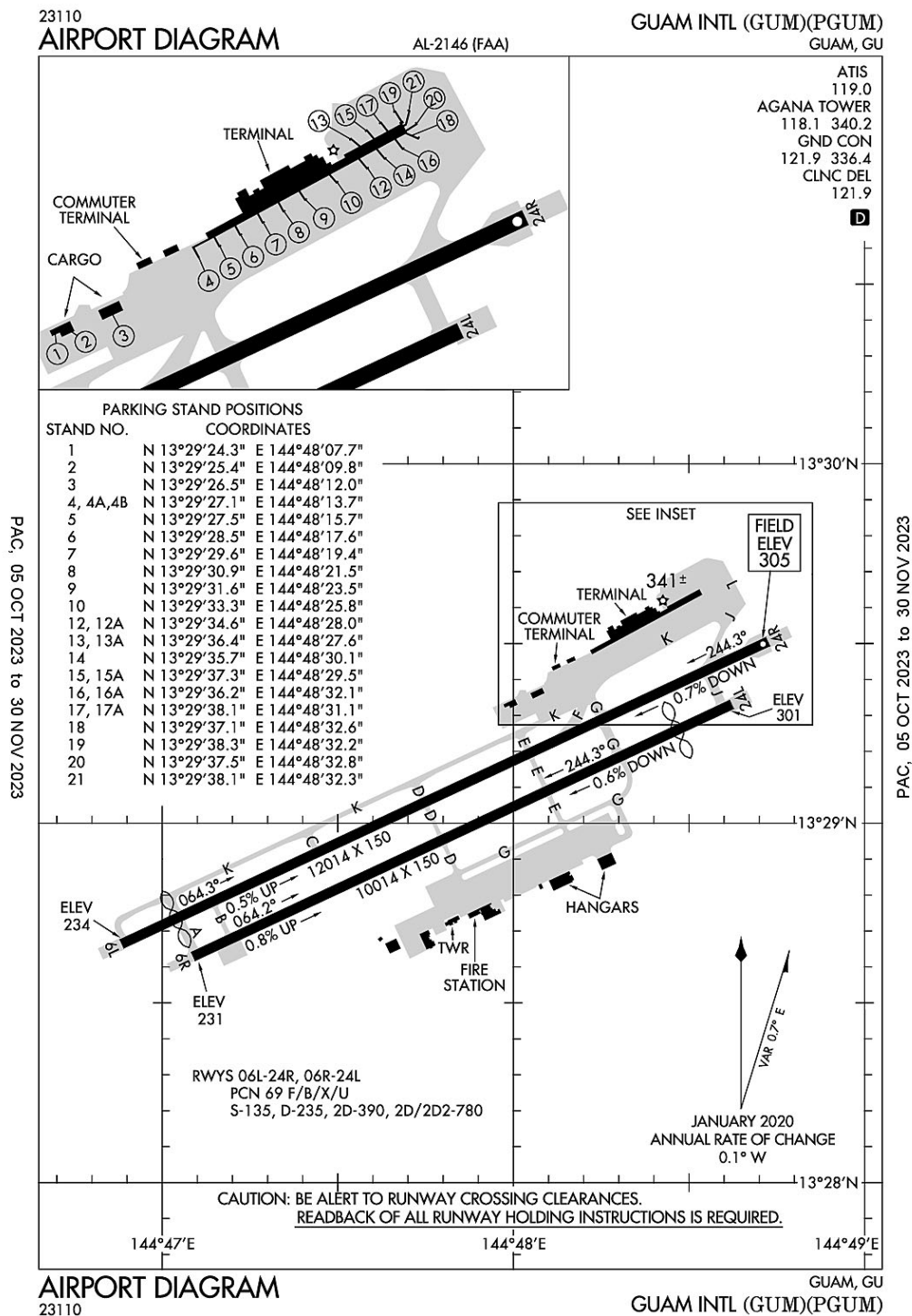
PREFERENTIAL RWY USE IN EFFECT, EXPECT TO USE RWYS 08R/26L, 09L/27R FOR DEPS; RWYS 08L/26R, 09R/27L ARE USED PRIMARILY FOR ARRIVALS.

NO ACFT WITH WINGSPAN GREATER THAN 213 FT MAY PASS ANOTHER ACFT WITH WINGSPAN GREATER THAN OR EQUAL TO 225 FT ON TWY L/M EAST OF L7.

ACFT WITH WINGSPAN GREATER THAN 171 FT ARE RSTRD FROM USING TWY V. ACFT WITH WINGSPAN GREATER THAN 171 FT ARE REQUIRED TO USE TAXI SPEEDS LESS THAN 15 MPH WHEN PASSING ACFT WITH WINGSPAN GREATER THAN 214FT ON TXWY L/M (EAST OF L7).

ASDE-X IN USE. OPERATE TRANSPONDERS WITH ALTITUDE REPORTING MODE AND ADS-B (IF EQUIPPED) ENABLED ON ALL AIRPORT SURFACES.

**Agana, Guam**  
**Guam International**  
**ICAO Identifier PGUM**



PAC: 05 OCT 2023 to 30 NOV 2023

PAC: 05 OCT 2023 to 30 NOV 2023

**Agana, GU**  
**Guam Intl**  
**ICAO Identifier PGUM**

**AD 2.2 Aerodrome geographical and administrative data**

- 2.2.1 Reference Point: 13-29-2.227N / 144-47-49.666E
- 2.2.2 From City: 3 miles NE of GUAM, GU
- 2.2.3 Elevation: 305 ft
- 2.2.5 Magnetic Variation: 2E (2000)
- 2.2.6 Airport Contact: JOHN QUINATA  
P.O. BOX 8770  
TAMUNING, GU 96931 (671-646-0300)
- 2.2.7 Traffic: IFR/VFR

**AD 2.3 Attendance Schedule**

- 2.3.1 All Months, All Days, All Hours

**AD 2.4 Handling Services and Facilities**

- 2.4.1 Cargo Handling Facilities: YES
- 2.4.2 Fuel Types: 100LL,A1
- 2.4.5 Hangar Space: YES
- 2.4.6 Repair Facilities: MINOR

**AD 2.6 Rescue and Firefighting Services**

- 2.6.1 Aerodrome Category: Class-I certified on 4/1/1995
- 2.6.2 Rescue and Firefighting Services: ARFF Index-E

**AD 2.12 Runway Physical Characteristics**

- 2.12.1 Designation: 06L
- 2.12.2 True Bearing: 65
- 2.12.3 Dimensions: 12014 ft x 150 ft
- 2.12.4 PCN: 69 F/B/X/U
- 2.12.5 Coordinates: 13-28-39.8644N / 144-46-53.1529E
- 2.12.6 Threshold Elevation: 233.7 ft
- 2.12.6 Touchdown Zone Elevation: 256.1 ft

- 2.12.1 Designation: 24R
- 2.12.2 True Bearing: 245
- 2.12.3 Dimensions: 12014 ft x 150 ft
- 2.12.4 PCN: 69 F/B/X/U
- 2.12.5 Coordinates: 13-29-30.3045N / 144-48-43.4542E
- 2.12.6 Threshold Elevation: 305 ft
- 2.12.6 Touchdown Zone Elevation: 305 ft

- 2.12.1 Designation: 06R
- 2.12.2 True Bearing: 65
- 2.12.3 Dimensions: 10014 ft x 150 ft
- 2.12.4 PCN: 69 F/B/X/U
- 2.12.5 Coordinates: 13-28-37.7705N / 144-47-5.333E
- 2.12.6 Threshold Elevation: 231 ft
- 2.12.6 Touchdown Zone Elevation: 257.9 ft



- 2.12.1 Designation: 24L
- 2.12.2 True Bearing: 245
- 2.12.3 Dimensions: 10014 ft x 150 ft
- 2.12.4 PCN: 69 F/B/X/U
- 2.12.5 Coordinates: 13-29-19.8209N / 144-48-37.2751E
- 2.12.6 Threshold Elevation: 301 ft
- 2.12.6 Touchdown Zone Elevation: 293 ft

**AD 2.13 Declared Distances**

- 2.13.1 Designation: 06L
- 2.13.2 Take-off Run Available: 12014
- 2.13.3 Take-off Distance Available: 12014
- 2.13.4 Accelerate-Stop Distance Available: 12014
- 2.13.5 Landing Distance Available: 11014

- 2.13.1 Designation: 24R
- 2.13.2 Take-off Run Available: 12014
- 2.13.3 Take-off Distance Available: 12014
- 2.13.4 Accelerate-Stop Distance Available: 12014
- 2.13.5 Landing Distance Available: 12014

- 2.13.1 Designation: 06R
- 2.13.2 Take-off Run Available: 10014
- 2.13.3 Take-off Distance Available: 10014
- 2.13.4 Accelerate-Stop Distance Available: 10014
- 2.13.5 Landing Distance Available: 10014

- 2.13.1 Designation: 24L
- 2.13.2 Take-off Run Available: 9714
- 2.13.3 Take-off Distance Available: 9714
- 2.13.4 Accelerate-Stop Distance Available: 9714
- 2.13.5 Landing Distance Available: 8710

**AD 2.14 Approach and Runway Lighting**

- 2.14.1 Designation: 06L
- 2.14.2 Approach Lighting System: MALSR
- 2.14.4 Visual Approach Slope Indicator System: P4L

- 2.14.1 Designation: 24R
- 2.14.2 Approach Lighting System:
- 2.14.4 Visual Approach Slope Indicator System: P4L

- 2.14.1 Designation: 06R
- 2.14.2 Approach Lighting System: MALSR
- 2.14.4 Visual Approach Slope Indicator System: P4R

- 2.14.1 Designation: 24L
- 2.14.2 Approach Lighting System:

2.14.4 Visual Approach Slope Indicator System: P4L

**AD 2.18 Air Traffic Services Communication Facilities**

2.18.1 Service Designation: ATIS

2.18.3 Channel: 119

2.18.5 Hours of Operation:

2.18.1 Service Designation: CD/P

2.18.3 Channel: 121.9

2.18.5 Hours of Operation: 24

2.18.1 Service Designation: EMERG

2.18.3 Channel: 121.5

2.18.5 Hours of Operation:

2.18.1 Service Designation: EMERG

2.18.3 Channel: 243

2.18.5 Hours of Operation:

2.18.1 Service Designation: GND/P

2.18.3 Channel: 121.9

2.18.5 Hours of Operation: 24

2.18.1 Service Designation: GND/P

2.18.3 Channel: 336.4

2.18.5 Hours of Operation: 24

2.18.1 Service Designation: LCL/P

2.18.3 Channel: 118.1

2.18.5 Hours of Operation: 24

2.18.1 Service Designation: LCL/P

2.18.3 Channel: 340.2

2.18.5 Hours of Operation: 24

2.18.1 Service Designation: RAMP CTL

2.18.3 Channel: 121.6

2.18.5 Hours of Operation: 24

**AD 2.19 Radio Navigation and Landing Aids**

2.19.1 ILS Type: DME for runway 06L. Magnetic variation: 2E

2.19.2 ILS Identification: GUM

2.19.5 Coordinates: 13-29-38.0751N / 144-48-51.492E

2.19.6 Site Elevation: 345.6 ft

2.19.1 ILS Type: Glide Slope for runway 06L. Magnetic variation: 2E

2.19.2 ILS Identification: GUM

2.19.5 Coordinates: 13-28-53.074N / 144-47-8.5127E

2.19.6 Site Elevation: 245.8 ft

2.19.1 ILS Type: Localizer for runway 06L. Magnetic variation: 2E  
2.19.2 ILS Identification: GUM  
2.19.5 Coordinates: 13-29-34.711N / 144-48-53.0959E  
2.19.6 Site Elevation: 312.4 ft

2.19.1 ILS Type: DME for runway 06R. Magnetic variation: 2E  
2.19.2 ILS Identification: AWD  
2.19.5 Coordinates: 13-29-21.7429N / 144-48-48.0979E  
2.19.6 Site Elevation: 329.8 ft

2.19.1 ILS Type: Glide Slope for runway 06R. Magnetic variation: 2E  
2.19.2 ILS Identification: AWD  
2.19.5 Coordinates: 13-28-37.9922N / 144-47-15.3932E  
2.19.6 Site Elevation: 236.5 ft

2.19.1 ILS Type: Localizer for runway 06R. Magnetic variation: 2E  
2.19.2 ILS Identification: AWD  
2.19.5 Coordinates: 13-29-24.2258N / 144-48-46.9153E  
2.19.6 Site Elevation: 310.5 ft

**General Remarks:**

TSNT ACFT PRVD 24 HRS ADVN INFO TO EXEC MGR GUAM INTL ARPT AUTHORITY; 1-671-642-4455  
MON-FRI 0800-1700 OR FAX 1-671-646-8567.

<1000' OVRN S END & 450' OVRN N END RWY 6L-24R.

CLASS III ACFT ARE PROHIBITED FROM MAKING ANY TURNS ONTO OR OFF TWY GOLF (SOUTH) WHILE UTILIZING TWY ECHO.

THE FIRST 500 FT OF THE LEFT SHOULDER OF RWY 24L IS NOT VISIBLE FROM THE TWR. PILOTS ARE ADVISED TO CAUTION FOR ANY PRESENCE OF WILDLIFE IN THAT AREA.

FOR PARKING INFORMATION ALL ACFT CTC RAMP CTL. ALL ACFT DEP TERMINAL PARKING CTC RAMP CTL FOR ENGINE START AND PUSHBACK.

ADG-VI AIRPLANES MAY DEPART ON RWY 6L AND RWY 24R WITH ACFT ON PARL TWY K AS LONG AS NO ADG-VI ACFT OCCUPIES THE PARL TWY BYD 1500 FT OF THE POINT OF TKOF ROLL.

FOR TAXG B747-8 ACFT ON TWY K FRONTING THE ACFT PRKG APN FROM GATES 5 - 16 AT THE MAIN TRML, MAX TAXG SPEED SHALL BE NO MORE THAN 15 MPH.

DRG TAXG OF THE B747-8 BTN GATES 5 - 16, ALL VEHICLES SHALL YIELD AND RMN CLEAR OF THE VEHICLE TFC PAT AND ARE RSTRD TO A MAX HGT OF 14 FT.

RWY 06 AND RWY 24 WIND CONE NSTD.

EFFECTIVE RY GRADIENT RY 06L 0.46% UP NE; RY 24R 0.70% DOWN SW; RY 06R 0.80 % UP NE; RY 24L 0.52% DOWN SW.

RISING TERRAIN 75 FT FM RY 24L THLD 140 FT EAST OF CNTRLN EXTENDED +8 FT.

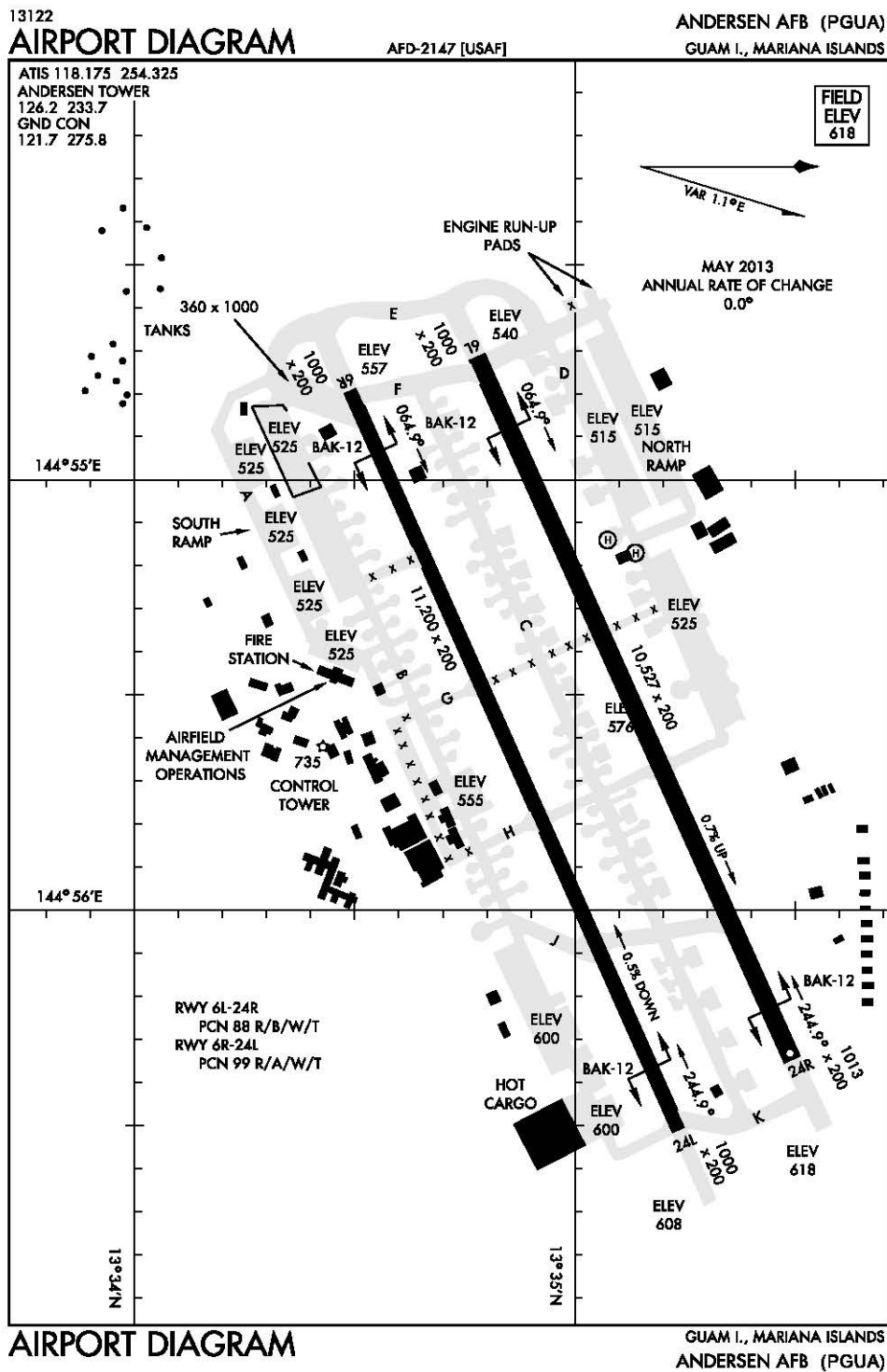
DEP VFR ACFT MAINT RY HDG TIL PAST DEP END OF RY AND REACHING 1000 FT AGL; RGT PAT 24L/R DO NOT EXCEED 1500 FT AGL IN TFC PAT.

FOR ALL ARRS, THE B747-8 AIRLINE WILL TOW THE ACFT INTO GATES 4 OR 18 FROM TWY K AND AIRLINE TO PRVD WING-WALKERS AS THE ACFT IS BEING TOWED INTO GATES 4 OR 18.

LGTD TWR 780 FT 1.3 NM ENE OF RY 24L THLD .

FOR THE B747-8, DRG RWY 24L & 24R OPS AND DUE TO JET BLAST EFCTS AT GATES 14, 16 & 18, THE B747-8 WILL BE TOWED FROM GATE 4 ON TWY K TO TWY J WITH THE ACFT PSND ON TWY J FACING TWD RWY 24R.

Andersen, Mariana Island, GU  
Andersen AFB  
ICAO Identifier PGUA



**Andersen, Mariana Island, GU**  
**Andersen AFB**  
**ICAO Identifier PGUA**

**AD 2.2 Aerodrome geographical and administrative data**

- 2.2.1 Reference Point: 13-35-1.99N / 144-55-48.2E
- 2.2.2 From City: 0 miles N of YIGO, GU
- 2.2.3 Elevation: 617.4 ft
- 2.2.5 Magnetic Variation: 2E (1980)
- 2.2.6 Airport Contact: MAJOR BILLY G TOWLES  
3 AD  
ANDERSEN AFB, GUAM, 69912 ()
- 2.2.7 Traffic: IFR/VFR

**AD 2.3 Attendance Schedule**

- 2.3.1 All Months, All Days, All Hours

**AD 2.4 Handling Services and Facilities**

- 2.4.1 Cargo Handling Facilities: YES
- 2.4.2 Fuel Types:
- 2.4.5 Hangar Space: YES
- 2.4.6 Repair Facilities: NONE

**AD 2.6 Rescue and Firefighting Services**

- 2.6.1 Aerodrome Category: None
- 2.6.2 Rescue and Firefighting Services: None

**AD 2.12 Runway Physical Characteristics**

- 2.12.1 Designation: 06L
- 2.12.2 True Bearing:
- 2.12.3 Dimensions: 10528 ft x 200 ft
- 2.12.4 PCN: 98 R/A/W/T
- 2.12.5 Coordinates: 13-34-49.281N / 144-54-56.32E
- 2.12.6 Threshold Elevation: 539.1 ft
- 2.12.6 Touchdown Zone Elevation: 539.3 ft

- 2.12.1 Designation: 24R
- 2.12.2 True Bearing:
- 2.12.3 Dimensions: 10528 ft x 200 ft
- 2.12.4 PCN: 98 R/A/W/T
- 2.12.5 Coordinates: 13-35-31.93N / 144-56-33.74E
- 2.12.6 Threshold Elevation: 617.4 ft
- 2.12.6 Touchdown Zone Elevation: 617.4 ft

- 2.12.1 Designation: 06R
- 2.12.2 True Bearing:
- 2.12.3 Dimensions: 11200 ft x 200 ft
- 2.12.4 PCN: 98 R/A/W/T
- 2.12.5 Coordinates: 13-34-31.18N / 144-54-59.38E
- 2.12.6 Threshold Elevation: 556.8 ft
- 2.12.6 Touchdown Zone Elevation: 556.8 ft

- 2.12.1 Designation: 24L
- 2.12.2 True Bearing:
- 2.12.3 Dimensions: 11200 ft x 200 ft
- 2.12.4 PCN: 98 R/A/W/T
- 2.12.5 Coordinates: 13-35-16.59N / 144-56-43E
- 2.12.6 Threshold Elevation: 607.2 ft
- 2.12.6 Touchdown Zone Elevation: 607.2 ft

**AD 2.13 Declared Distances**

- 2.13.1 Designation: 06L
- 2.13.2 Take-off Run Available:
- 2.13.3 Take-off Distance Available:
- 2.13.4 Accelerate-Stop Distance Available:
- 2.13.5 Landing Distance Available:

- 2.13.1 Designation: 24R
- 2.13.2 Take-off Run Available:
- 2.13.3 Take-off Distance Available:
- 2.13.4 Accelerate-Stop Distance Available:
- 2.13.5 Landing Distance Available:

- 2.13.1 Designation: 06R
- 2.13.2 Take-off Run Available:
- 2.13.3 Take-off Distance Available:
- 2.13.4 Accelerate-Stop Distance Available:
- 2.13.5 Landing Distance Available:

- 2.13.1 Designation: 24L
- 2.13.2 Take-off Run Available:
- 2.13.3 Take-off Distance Available:
- 2.13.4 Accelerate-Stop Distance Available:
- 2.13.5 Landing Distance Available:

**AD 2.14 Approach and Runway Lighting**

- 2.14.1 Designation: 06L
- 2.14.2 Approach Lighting System: SALS
- 2.14.4 Visual Approach Slope Indicator System: P4L

- 2.14.1 Designation: 24R
- 2.14.2 Approach Lighting System: ALSF1
- 2.14.4 Visual Approach Slope Indicator System: P4L

- 2.14.1 Designation: 06R
- 2.14.2 Approach Lighting System: ALSF1
- 2.14.4 Visual Approach Slope Indicator System: P4L

- 2.14.1 Designation: 24L
- 2.14.2 Approach Lighting System: SALS

2.14.4 Visual Approach Slope Indicator System: P4L

**AD 2.18 Air Traffic Services Communication Facilities**

2.18.1 Service Designation: ATIS

2.18.3 Channel: 118.175

2.18.5 Hours of Operation:

2.18.1 Service Designation: ATIS

2.18.3 Channel: 254.325

2.18.5 Hours of Operation:

2.18.1 Service Designation: CD/P

2.18.3 Channel: 126.725

2.18.5 Hours of Operation: 24

2.18.1 Service Designation: CD/P

2.18.3 Channel: 256.7

2.18.5 Hours of Operation: 24

2.18.1 Service Designation: COMD POST (36 WG BOONIE OPS)

2.18.3 Channel: 321

2.18.5 Hours of Operation:

2.18.1 Service Designation: COMD POST (36 WG BOONIE OPS)

2.18.3 Channel: 349.4

2.18.5 Hours of Operation:

2.18.1 Service Designation: EMERG

2.18.3 Channel: 121.5

2.18.5 Hours of Operation:

2.18.1 Service Designation: EMERG

2.18.3 Channel: 243

2.18.5 Hours of Operation:

2.18.1 Service Designation: GND/P

2.18.3 Channel: 121.7

2.18.5 Hours of Operation: 24

2.18.1 Service Designation: GND/P

2.18.3 Channel: 275.8

2.18.5 Hours of Operation: 24

2.18.1 Service Designation: LCL/P

2.18.3 Channel: 126.2

2.18.5 Hours of Operation: 24

2.18.1 Service Designation: LCL/P

2.18.3 Channel: 233.7

2.18.5 Hours of Operation: 24



2.18.1 Service Designation: PMSV METRO  
2.18.3 Channel: 346.6  
2.18.5 Hours of Operation:

2.18.1 Service Designation: PTD  
2.18.3 Channel: 372.2  
2.18.5 Hours of Operation:

2.18.1 Service Designation: SFA  
2.18.3 Channel: 281.4  
2.18.5 Hours of Operation:

**AD 2.19 Radio Navigation and Landing Aids**

2.19.1 ILS Type: Glide Slope for runway 24R. Magnetic variation: 2E  
2.19.2 ILS Identification: YIG  
2.19.5 Coordinates: 13-35-30.26N / 144-56-17.53E  
2.19.6 Site Elevation: 593.6 ft

2.19.1 ILS Type: Localizer for runway 24R. Magnetic variation: 2E  
2.19.2 ILS Identification: YIG  
2.19.5 Coordinates: 13-34-43.23N / 144-54-42.5E  
2.19.6 Site Elevation: 533.6 ft

2.19.1 ILS Type: Glide Slope for runway 06R. Magnetic variation: 2E  
2.19.2 ILS Identification: UAM  
2.19.5 Coordinates: 13-34-40.04N / 144-55-7.21E  
2.19.6 Site Elevation: 544.6 ft

2.19.1 ILS Type: Localizer for runway 06R. Magnetic variation: 2E  
2.19.2 ILS Identification: UAM  
2.19.5 Coordinates: 13-35-21.67N / 144-56-54.64E  
2.19.6 Site Elevation: 606.6 ft

2.19.1 ILS Type: Glide Slope for runway 24L. Magnetic variation: 2E  
2.19.2 ILS Identification: PMY  
2.19.5 Coordinates: 13-35-15.55N / 144-56-29.18E  
2.19.6 Site Elevation: 596.1 ft

2.19.1 ILS Type: Localizer for runway 24L. Magnetic variation: 2E  
2.19.2 ILS Identification: PMY  
2.19.5 Coordinates: 13-34-25.7N / 144-54-46.9E  
2.19.6 Site Elevation: 568.8 ft

2.19.1 Navigation Aid Type: TACAN. Magnetic variation: 2E  
2.19.2 Navigation Aid Identification: UAM  
2.19.5 Coordinates: 13-35-28.39N / 144-56-47.68E  
2.19.6 Site Elevation: 614.8 ft

**General Remarks:**

FREQUENT RAIN SHOWERS OF SHORT DURATION, EXPECT WET RWY BRAKEING ACTION.

RSTD: ALL ACFT CTC 36 WG COMD POST 90 MIN OUT AND AT 30 MIN OUT PRIOR TO ARR.

MISC: AIRCRAFT EXCEEDING AFLD WEIGHTS MUST REQUEST WEIGHT BEARING CAPACITY WAIVER WITH 24 HR NOTICE TO AIRFIELD OPS TO PROCESS ANY APPROVALS NEEDED. IF REQUESTS ARE NOT MADE WITHIN 24 HRS EXPECT DELAYS.

RSTD: ACFT MUST ADHERE TO PPR ARR +/- 30 MIN. ACFT WITH WINGSPANS GREATER THAN 261' NOT AUTHORIZED.

HAZUS AIR TURB FINAL APCH RWYS 24L/24R. NO VSBY REF AVBL ON NGT TKOF BYD END RWY 6.

MISC: RWY 06L/24R CLSD SECOND WED EACH MONTH 2000-2300Z(0600-0900L THU). RWY 06R/24L CLSD FOURTH WED EACH MONTH 2000-2300Z (0600-0900L THU).

ILS/RADAR-ILS: ILS CRITICAL AREAS NOT PROTECTED.

RSTD: ALL AEROMEDICAL EVAC MSN ARE RQRD TO CTC COMD POST (DSN 366-2961, C671-366-2961) BY ANY MEANS AVAIL 3 HRS PRIOR TO ARR. ALL ACFT RQRD TO MAKE CALL 30 MIN PRIOR TO ARR.

RSTD: ALL OPR MUST OBTAIN APVL FR GND AND AMOPS PRIOR TO ENG RUNUP.

MISC: ANDERSEN AFB DOES NOT HAVE CAPABILITY TO STORE REFRIGERATED CARGO.

RSTD: RESTRICTIONS TO FLT OPNS DUR EA BWC. MOD: NO TOUCH AND GO LDG. RSTD LOW APPCH NO LOWER THAN 200' OR AS DETERMINED BY SOF. SEVERE: RSTD LOW APPCH NO LOWER THAN 200' OR AS DETERMINED BY SOF. EMERG LDG AND 36 OG/CC APV DEP ONLY. PHASE I: PHASE I:1 APR - 31 JUL. PHASE II: 1 AUG - 31 MAR.

SERVICE-LGT: ARPT BCN 763 FT MSL LCTD 1.4 NM SSW OF AFLD.

MISC: "NO VHF CAPABILITIES WITH AFLD MGMT."

ALL INBD ACFT TO INCL TACC/GDSS MSNS MUST COORD PPR REQ WITH AFLD MGMT AND HAVE VALID PPR NUMBER APV PRIOR TO ARR. PPR REQ MUST BE MADE MORE THAN 24 HR IN ADVANCE AND NO EARLIER THAN 14 DAYS PRIOR TO ARR/DEP. PPR REQ GIVEN WITHIN 24 HR WILL NOT BE APV.

A-GEAR BAK-12 RWYS 06L & 06R 30 MIN NTC RQR.

TWY B AND C BTN TWY J AND K CLSD DUE TO CONSTRUCTION.

SERVICE-A-GEAR: CONTACT CONTROL TOWER 30 MIN PRIOR FOR DEPARTURE END BAK12 CABLE CONFIGURATION. 60 MIN PN FOR CHG IN CONFIGURATION. BAK12 HOUSING LCTD 317' FROM RY CENTERLINE, 217' FROM RY EDGE, MAX HEIGHT 8'. NO ARRESTING-GEAR MARKER LCTD ON LEFT SIDE OF ALL APPROACH END BARRIERS.

MISC: RWY 06L AND 06R UNDERRUNS 1000' AVBL FOR TWY/TKOF. RWY 24R UNDERRUN AVBL 500' FOR TAXI/TKOF.

BASE OPS V366-4188; FAX V366-6217.

CAUTION: USE EXTREME CAUTION FOR EXTV UAS OPS IN VCNTY OF ANDERSEN AFB.

SERVICE-FLUID: C-5 NITROGEN SVC CAPABILITY UNAVBL.

MAINT AVBL 0100-0400 WEEKDAY ONLY; CLOSED WEEKEND & HOL.

RSTD: PPR REQ DSN: AFLD MGMT 315-366-4188.

NO ARRESTING GEAR MARKERS LOCATED ON THE LEFT SIDE OF ALL APPROACH END BARRIERS.

MISC: ALL AIRCREWS TO RON MUST CK INTO AFLD MGT OPS AND PROVIDE POC INFO UPON ARR.

MISC: PAVEMENT PRIOR TO RY 06R AND RY 06L THLDS AVBL FOR TKOF RUN WHEN NECESSARY FOR MSN ACCOMPLISHMENT.

MISC: ATTN: ALL DRY ICE REQ MUST BE MADE THRU 734TH MS/ATOC DSN 315-366-3125/3137/3162 OR C671-366-3125/3137/3162. REQ MUST BE MADE AT LEAST 24 HR IN ADVANCE FOR ACFT LDG TUE-FRI AND 72 HR IN ADVANCE FOR ACFT LDG SAT-MON. DUR HOL, ADD 2 HR TO COORD TIME.

NS ABTMT: QUIET HR 1200-2000Z (2200-0600L) DLY. NO AFTERBURNER, OR OVR FLT OF BASE AND LCL POPULATED AREAS. OTHER RESTRICTIONS BY NOTAM.

CAUTION: 47' TACAN ANTENNAE LCTD 1,300 FT NE OF RY 24L & 1,300 FT SE OF RY 24R THLDS.

MISC: AFLD MGT HAS NO COMSEC STORAGE AVBL FOR TRAN AIRCREWS. TRANS AIRCREWS CAN STORE COMSEC UP TO TOP-SECRET AT 36 WG CP.

MISC: WX OPR H24, DSN 315-366-5230. AUTOMATED SENSOR PRVDS OBSN; AUGMENTED DUR HAZ WX & SENSOR OUTAGES. HUMAN WX OBSN VIEW OBSTD BY BLDG N-SSE. WX STN PRVDS LTD WX BRIEF SUPPORT. REMOTE WX BRIEF AVBL H24 FR 17 OWS AT DSN 315-449-8333/7950, C808-448-3809; 2 HR NTC RQRD FOR TIMELY BRIEF.

RSTD 1 OF 2: THERE WILL BE NO OVFT OF MARIANA CROW TERRITORIES BLW 1,000 FT AGL FROM SEP-MAY. OVFT BLW 1,000 FT AGL IS ALLOWED BTN JUNE AND AUG, THE CROW NON-BREEDING SEASON.

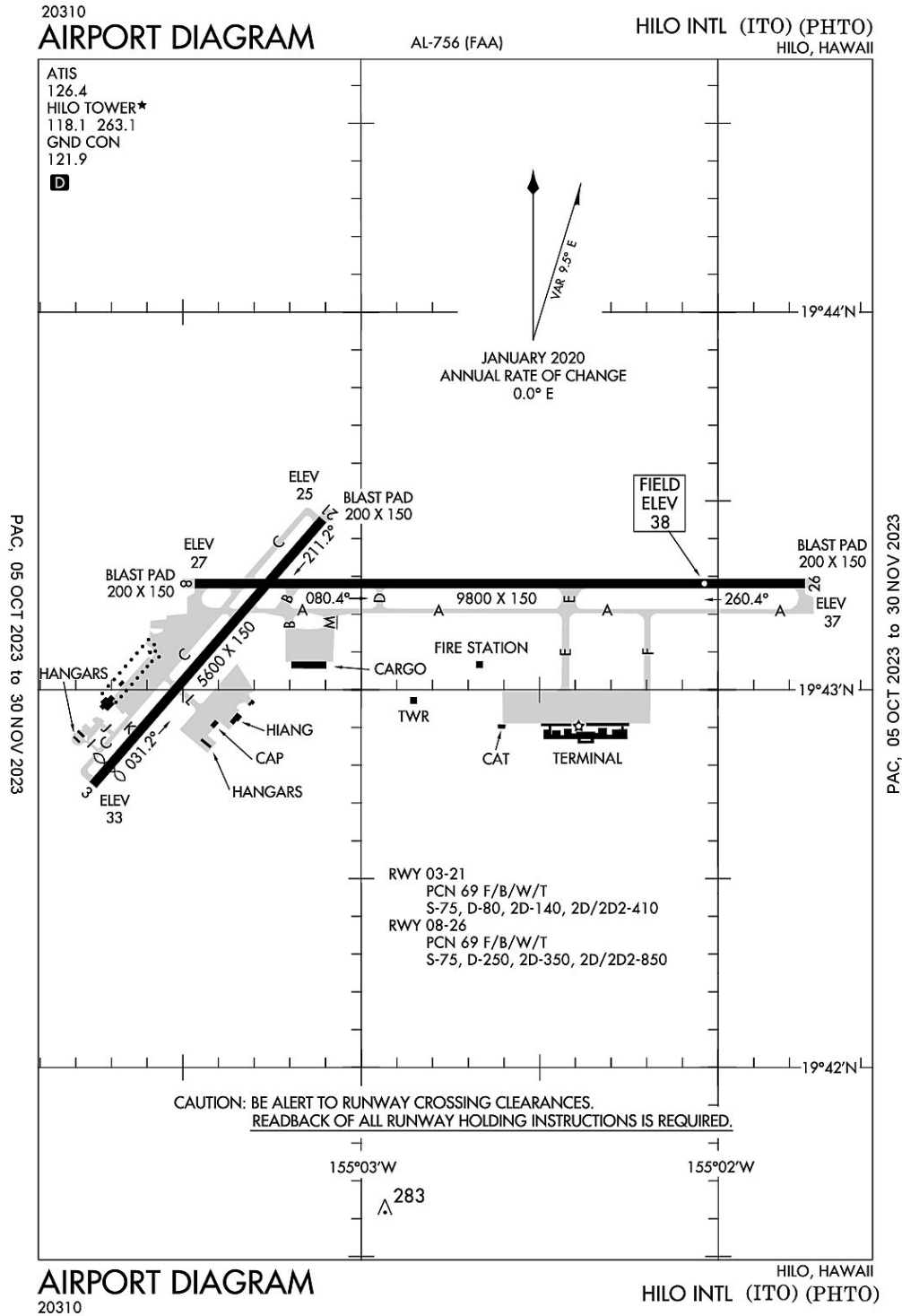
AREA BTN 1000' ROLL BAR AND THU LGT RWY 06R AND 06L UNLGTD. LAST 642' PRIOR TO THU LGT 24R UNLGTD.

ANY CREW RQRG ASSISTANCE FR AGENCIES OUTSIDE OF AFLD SUPPORT, CTC WING RECEPTIONS DSN 315-366-3464, C671-366-3464.

SERVICE-LGT: RAMP LGT UNAVBL FOR NGT TIME OPS, AND UNSAFE ACFT MVMT COND EXIST ON NORTH RAMP 3; ACFT TAXI AT THEIR OWN RISK. ALL AFLD ILS STOP LGT UNSVC. VEGETATION OBST RWY 06R AND RWY 24R APCH LGT SYS.

RSTD: BA ON BOTH RWYS MAY BE LESS THAN EXP DUE TO RUBBER BUILD-UP; PROBABILITY OF HYDROPLANING EXISTS.

### Hilo, Hawaii Hilo International ICAO Identifier PHTO



**Hilo, HI**  
**Hilo Intl**  
**ICAO Identifier PHTO**

**AD 2.2 Aerodrome geographical and administrative data**

- 2.2.1 Reference Point: 19-43-12.9468N / 155-2-54.4925W
- 2.2.2 From City: 2 miles E of HILO, HI
- 2.2.3 Elevation: 37.6 ft
- 2.2.5 Magnetic Variation: 11E (1985)
- 2.2.6 Airport Contact: CHAUNCEY WONG YUEN  
HAWAII AIRPORTS DISTRICT MANAGER  
HILO, HI 96720 (808-961-9300)
- 2.2.7 Traffic: IFR/VFR

**AD 2.3 Attendance Schedule**

- 2.3.1 All Months, All Days, 0700-2030 Hours

**AD 2.4 Handling Services and Facilities**

- 2.4.1 Cargo Handling Facilities: YES
- 2.4.2 Fuel Types: 100LL,A
- 2.4.5 Hangar Space:
- 2.4.6 Repair Facilities: MINOR

**AD 2.6 Rescue and Firefighting Services**

- 2.6.1 Aerodrome Category: Class-I certified on 5/1/1973
- 2.6.2 Rescue and Firefighting Services: ARFF Index-C

**AD 2.12 Runway Physical Characteristics**

- 2.12.1 Designation: 03
- 2.12.2 True Bearing: 41
- 2.12.3 Dimensions: 5600 ft x 150 ft
- 2.12.4 PCN: 69 F/B/W/T
- 2.12.5 Coordinates: 19-42-44.9639N / 155-3-44.7803W
- 2.12.6 Threshold Elevation: 33.3 ft
- 2.12.6 Touchdown Zone Elevation: 33.7 ft

- 2.12.1 Designation: 21
- 2.12.2 True Bearing: 221
- 2.12.3 Dimensions: 5600 ft x 150 ft
- 2.12.4 PCN: 69 F/B/W/T
- 2.12.5 Coordinates: 19-43-26.9946N / 155-3-6.4865W
- 2.12.6 Threshold Elevation: 25.4 ft
- 2.12.6 Touchdown Zone Elevation: 31.4 ft

- 2.12.1 Designation: 08
- 2.12.2 True Bearing: 90
- 2.12.3 Dimensions: 9800 ft x 150 ft
- 2.12.4 PCN: 69 F/B/W/T
- 2.12.5 Coordinates: 19-43-16.9328N / 155-3-27.9882W
- 2.12.6 Threshold Elevation: 27.3 ft
- 2.12.6 Touchdown Zone Elevation: 30.1 ft

- 2.12.1 Designation: 26
- 2.12.2 True Bearing: 270
- 2.12.3 Dimensions: 9800 ft x 150 ft
- 2.12.4 PCN: 69 F/B/W/T
- 2.12.5 Coordinates: 19–43–16.9196N / 155–1–45.4051W
- 2.12.6 Threshold Elevation: 37 ft
- 2.12.6 Touchdown Zone Elevation: 37.6 ft

#### **AD 2.13 Declared Distances**

- 2.13.1 Designation: 03
- 2.13.2 Take–off Run Available: 5600
- 2.13.3 Take–off Distance Available: 5600
- 2.13.4 Accelerate–Stop Distance Available: 5600
- 2.13.5 Landing Distance Available: 5251

- 2.13.1 Designation: 21
- 2.13.2 Take–off Run Available: 5251
- 2.13.3 Take–off Distance Available: 5251
- 2.13.4 Accelerate–Stop Distance Available: 5510
- 2.13.5 Landing Distance Available: 5510

- 2.13.1 Designation: 08
- 2.13.2 Take–off Run Available: 9800
- 2.13.3 Take–off Distance Available: 9800
- 2.13.4 Accelerate–Stop Distance Available: 9800
- 2.13.5 Landing Distance Available: 9800

- 2.13.1 Designation: 26
- 2.13.2 Take–off Run Available: 9800
- 2.13.3 Take–off Distance Available: 9800
- 2.13.4 Accelerate–Stop Distance Available: 9800
- 2.13.5 Landing Distance Available: 9800

#### **AD 2.14 Approach and Runway Lighting**

- 2.14.1 Designation: 03
- 2.14.2 Approach Lighting System:
- 2.14.4 Visual Approach Slope Indicator System: V4L

- 2.14.1 Designation: 21
- 2.14.2 Approach Lighting System:
- 2.14.4 Visual Approach Slope Indicator System:

- 2.14.1 Designation: 08
- 2.14.2 Approach Lighting System: ODALS
- 2.14.4 Visual Approach Slope Indicator System: P4R

- 2.14.1 Designation: 26
- 2.14.2 Approach Lighting System: MALSR

2.14.4 Visual Approach Slope Indicator System: P4L

**AD 2.18 Air Traffic Services Communication Facilities**

2.18.1 Service Designation: APCH/P DEP/P

2.18.3 Channel: 119.7

2.18.5 Hours of Operation: 0600-2200

2.18.1 Service Designation: APCH/P DEP/P

2.18.3 Channel: 269.2

2.18.5 Hours of Operation: 0600-2200

2.18.1 Service Designation: APCH/S DEP/S

2.18.3 Channel: 120.25

2.18.5 Hours of Operation: 0600-2200

2.18.1 Service Designation: APCH/S DEP/S

2.18.3 Channel: 323

2.18.5 Hours of Operation: 0600-2200

2.18.1 Service Designation: ATIS

2.18.3 Channel: 126.4

2.18.5 Hours of Operation: 24

2.18.1 Service Designation: EMERG

2.18.3 Channel: 121.5

2.18.5 Hours of Operation:

2.18.1 Service Designation: EMERG

2.18.3 Channel: 243

2.18.5 Hours of Operation:

2.18.1 Service Designation: GND/P

2.18.3 Channel: 121.9

2.18.5 Hours of Operation: 0600-2200

2.18.1 Service Designation: LCL/P

2.18.3 Channel: 118.1

2.18.5 Hours of Operation: 0600-2200

2.18.1 Service Designation: LCL/P

2.18.3 Channel: 263.1

2.18.5 Hours of Operation: 0600-2200

**AD 2.19 Radio Navigation and Landing Aids**

2.19.1 ILS Type: DME for runway 26. Magnetic variation: 11E

2.19.2 ILS Identification: ITO

2.19.5 Coordinates: 19-43-13.742N / 155-3-39.505W

2.19.6 Site Elevation: 39 ft

2.19.1 ILS Type: Glide Slope for runway 26. Magnetic variation: 11E  
2.19.2 ILS Identification: ITO  
2.19.5 Coordinates: 19-43-20.887N / 155-1-58.099W  
2.19.6 Site Elevation: 32.5 ft

2.19.1 ILS Type: Localizer for runway 26. Magnetic variation: 11E  
2.19.2 ILS Identification: ITO  
2.19.5 Coordinates: 19-43-16.933N / 155-3-38.784W  
2.19.6 Site Elevation: 25.8 ft

2.19.1 Navigation Aid Type: VORTAC. Magnetic variation: 11E  
2.19.2 Navigation Aid Identification: ITO  
2.19.5 Coordinates: 19-43-16.862N / 155-0-39.435W  
2.19.6 Site Elevation: 23 ft

**General Remarks:**

ATCT CTLS ENTRY/EXIT TFC ON TWYS F&E TO EAST TRML RAMP.

BE ALERT OCNL BIRD FLOCKS ON ARPT AND IN FLT ACROSS RWY 08/26 AND 03/21.

PPR FROM ARPT MGR FOR TRANSIENT PARKING.

FOR CD WHEN ATCT IS CLSD CTC HONOLULU CONTROL FACILITY AT 808-840-6262.

181' LGTD SMOKE STACK 1/2 SM SOUTH OF FLD.

RY 08/26 SINGLE-BELLY TWIN TANDEM (SBTT) GWT 450,000 LBS.

RY 03/21 SINGLE-BELLY TWIN TANDEM (SBTT) GWT 230,000 LBS.

NOISE ABATEMENT: AVOID OVERFLIGHT OF NOISE SENSITIVE RESIDENTIAL AREAS N, W AND SW OF AIRPORT.

RY 3/21 CLSD TO TURBINE ACFT 1800-0600.

TWY E BTN TWY A AND RWY 08/26 PONDING DRG HVY RAINS.

RWY 08 PVD 1325' MKD BY CHEVRONS, UNUSBL FOR LNDG/TKOF/OVRN/STY; CANNOT BE USED IN COMPUTING TKOF DATA.

DIVISION 1.1, 1.2, 1.3 EXPLOSIVES PROHIBITED.

RWYS 8, 21 AND 26 WIND CONES ARE LCTD IN THE ROFA.

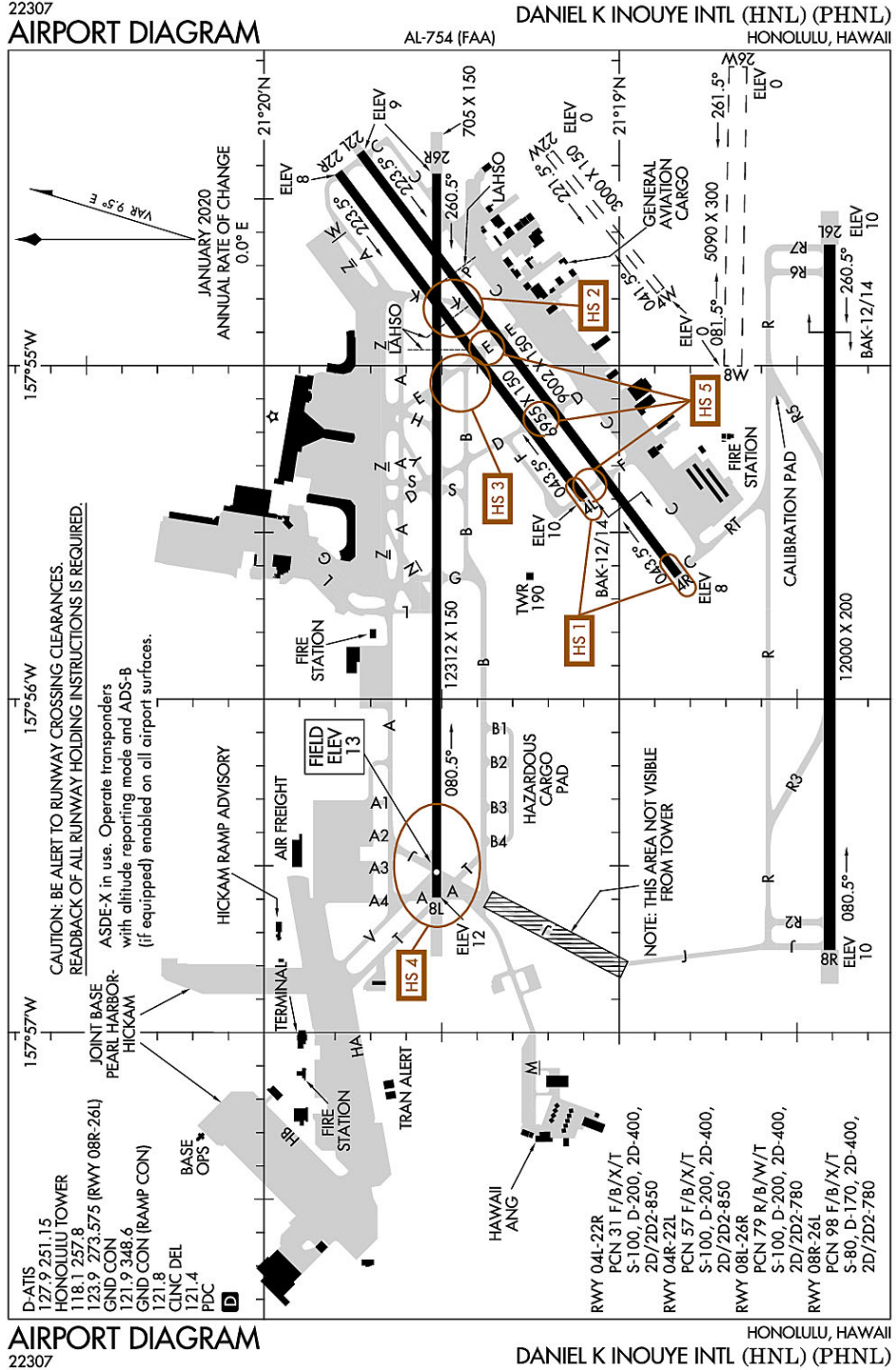
(A70A) JET FUEL AVBL MON-SAT 0800-1700 CALL (808) 935-6881/6122 OR 961-6601.

(E93) NO MKD PAD, HEL OPER FM FBO HANGER AREA.

PPR FROM AIRPORT MANAGER FOR TRANSPORTATION OF DIVISION 1.4 EXPLOSIVES AND HAZARDOUS MATERIAL IN OR OUT OF AIRPORT.



### Honolulu, Hawaii Honolulu International ICAO Identifier PHNL



**Honolulu, HI**  
**Honolulu Intl**  
**ICAO Identifier PHNL**

**AD 2.2 Aerodrome geographical and administrative data**

- 2.2.1 Reference Point: 21-19-4.142N / 157-55-12.819W
- 2.2.2 From City: 3 miles NW of HONOLULU, HI
- 2.2.3 Elevation: 12.6 ft
- 2.2.5 Magnetic Variation: 11E (1990)
- 2.2.6 Airport Contact: MALCOM SMITH  
300 RODGERS BLVD. #12  
HONOLULU, HI 96819 (808-836-6434)
- 2.2.7 Traffic: IFR/VFR

**AD 2.3 Attendance Schedule**

- 2.3.1 All Months, All Days, All Hours

**AD 2.4 Handling Services and Facilities**

- 2.4.1 Cargo Handling Facilities: YES
- 2.4.2 Fuel Types: 100,A,A1+
- 2.4.5 Hangar Space:
- 2.4.6 Repair Facilities: MAJOR

**AD 2.6 Rescue and Firefighting Services**

- 2.6.1 Aerodrome Category: Class-I certified on 5/1/1973
- 2.6.2 Rescue and Firefighting Services: ARFF Index-E

**AD 2.12 Runway Physical Characteristics**

- 2.12.1 Designation: 04L
- 2.12.2 True Bearing: 53
- 2.12.3 Dimensions: 6955 ft x 150 ft
- 2.12.4 PCN: 31 F/B/X/T
- 2.12.5 Coordinates: 21-19-5.9954N / 157-55-23.9541W
- 2.12.6 Threshold Elevation: 9.8 ft
- 2.12.6 Touchdown Zone Elevation: 10.2 ft
  
- 2.12.1 Designation: 22R
- 2.12.2 True Bearing: 233
- 2.12.3 Dimensions: 6955 ft x 150 ft
- 2.12.4 PCN: 31 F/B/X/T
- 2.12.5 Coordinates: 21-19-47.4694N / 157-54-25.1972W
- 2.12.6 Threshold Elevation: 7.5 ft
- 2.12.6 Touchdown Zone Elevation: 9.6 ft
  
- 2.12.1 Designation: 04R
- 2.12.2 True Bearing: 53
- 2.12.3 Dimensions: 9002 ft x 150 ft
- 2.12.4 PCN: 57 F/B/X/T
- 2.12.5 Coordinates: 21-18-50.1044N / 157-55-37.685W
- 2.12.6 Threshold Elevation: 8.1 ft
- 2.12.6 Touchdown Zone Elevation: 8.4 ft

2.12.1 Designation: 22L  
2.12.2 True Bearing: 233  
2.12.3 Dimensions: 9002 ft x 150 ft  
2.12.4 PCN: 57 F/B/X/T  
2.12.5 Coordinates: 21-19-43.7762N / 157-54-21.6299W  
2.12.6 Threshold Elevation: 8.5 ft  
2.12.6 Touchdown Zone Elevation: 8.6 ft

2.12.1 Designation: 04W  
2.12.2 True Bearing: 51  
2.12.3 Dimensions: 3000 ft x 150 ft  
2.12.4 PCN:  
2.12.5 Coordinates: 21-18-53.09N / 157-54-46.44W  
2.12.6 Threshold Elevation: 0 ft  
2.12.6 Touchdown Zone Elevation: ft

2.12.1 Designation: 22W  
2.12.2 True Bearing: 231  
2.12.3 Dimensions: 3000 ft x 150 ft  
2.12.4 PCN:  
2.12.5 Coordinates: 21-19-11.7999N / 157-54-21.78W  
2.12.6 Threshold Elevation: 0 ft  
2.12.6 Touchdown Zone Elevation: ft

2.12.1 Designation: 08L  
2.12.2 True Bearing: 89  
2.12.3 Dimensions: 12312 ft x 150 ft  
2.12.4 PCN: 79 R/B/W/T  
2.12.5 Coordinates: 21-19-30.8826N / 157-56-35.6573W  
2.12.6 Threshold Elevation: 11.8 ft  
2.12.6 Touchdown Zone Elevation: 12.6 ft

2.12.1 Designation: 26R  
2.12.2 True Bearing: 270  
2.12.3 Dimensions: 12312 ft x 150 ft  
2.12.4 PCN: 79 R/B/W/T  
2.12.5 Coordinates: 21-19-30.884N / 157-54-25.4326W  
2.12.6 Threshold Elevation: 8.4 ft  
2.12.6 Touchdown Zone Elevation: 8.8 ft

2.12.1 Designation: 08R  
2.12.2 True Bearing: 90  
2.12.3 Dimensions: 12000 ft x 200 ft  
2.12.4 PCN: 98 F/B/X/T  
2.12.5 Coordinates: 21-18-24.4938N / 157-56-45.061W  
2.12.6 Threshold Elevation: 9.9 ft  
2.12.6 Touchdown Zone Elevation: 10 ft

2.12.1 Designation: 26L  
2.12.2 True Bearing: 270

2.12.3 Dimensions: 12000 ft x 200 ft  
2.12.4 PCN: 98 F/B/X/T  
2.12.5 Coordinates: 21-18-24.4867N / 157-54-38.152W  
2.12.6 Threshold Elevation: 9.8 ft  
2.12.6 Touchdown Zone Elevation: 9.8 ft

2.12.1 Designation: 08W  
2.12.2 True Bearing: 91  
2.12.3 Dimensions: 5090 ft x 300 ft  
2.12.4 PCN:  
2.12.5 Coordinates: 21-18-40.85N / 157-55-0W  
2.12.6 Threshold Elevation: 0 ft  
2.12.6 Touchdown Zone Elevation: ft

2.12.1 Designation: 26W  
2.12.2 True Bearing: 271  
2.12.3 Dimensions: 5090 ft x 300 ft  
2.12.4 PCN:  
2.12.5 Coordinates: 21-18-39.9794N / 157-54-6.1782W  
2.12.6 Threshold Elevation: 0 ft  
2.12.6 Touchdown Zone Elevation: ft

#### **AD 2.13 Declared Distances**

2.13.1 Designation: 04L  
2.13.2 Take-off Run Available: 6952  
2.13.3 Take-off Distance Available: 6952  
2.13.4 Accelerate-Stop Distance Available: 6952  
2.13.5 Landing Distance Available: 6952

2.13.1 Designation: 22R  
2.13.2 Take-off Run Available: 6952  
2.13.3 Take-off Distance Available: 6952  
2.13.4 Accelerate-Stop Distance Available: 6952  
2.13.5 Landing Distance Available: 6952

2.13.1 Designation: 04R  
2.13.2 Take-off Run Available: 9000  
2.13.3 Take-off Distance Available: 9000  
2.13.4 Accelerate-Stop Distance Available: 8950  
2.13.5 Landing Distance Available: 8950

2.13.1 Designation: 22L  
2.13.2 Take-off Run Available: 9000  
2.13.3 Take-off Distance Available: 9000  
2.13.4 Accelerate-Stop Distance Available: 8937  
2.13.5 Landing Distance Available: 8937

2.13.1 Designation: 04W  
2.13.2 Take-off Run Available:  
2.13.3 Take-off Distance Available:

2.13.4 Accelerate-Stop Distance Available:  
2.13.5 Landing Distance Available:

2.13.1 Designation: 22W  
2.13.2 Take-off Run Available:  
2.13.3 Take-off Distance Available:  
2.13.4 Accelerate-Stop Distance Available:  
2.13.5 Landing Distance Available:

2.13.1 Designation: 08L  
2.13.2 Take-off Run Available: 12312  
2.13.3 Take-off Distance Available: 12312  
2.13.4 Accelerate-Stop Distance Available: 12312  
2.13.5 Landing Distance Available: 12312

2.13.1 Designation: 26R  
2.13.2 Take-off Run Available: 12300  
2.13.3 Take-off Distance Available: 12300  
2.13.4 Accelerate-Stop Distance Available: 12300  
2.13.5 Landing Distance Available: 12300

2.13.1 Designation: 08R  
2.13.2 Take-off Run Available: 12000  
2.13.3 Take-off Distance Available: 12000  
2.13.4 Accelerate-Stop Distance Available: 12000  
2.13.5 Landing Distance Available: 12000

2.13.1 Designation: 26L  
2.13.2 Take-off Run Available: 12000  
2.13.3 Take-off Distance Available: 12000  
2.13.4 Accelerate-Stop Distance Available: 12000  
2.13.5 Landing Distance Available: 12000

2.13.1 Designation: 08W  
2.13.2 Take-off Run Available:  
2.13.3 Take-off Distance Available:  
2.13.4 Accelerate-Stop Distance Available:  
2.13.5 Landing Distance Available:

2.13.1 Designation: 26W  
2.13.2 Take-off Run Available:  
2.13.3 Take-off Distance Available:  
2.13.4 Accelerate-Stop Distance Available:  
2.13.5 Landing Distance Available:

**AD 2.14 Approach and Runway Lighting**

2.14.1 Designation: 04L  
2.14.2 Approach Lighting System:  
2.14.4 Visual Approach Slope Indicator System: P4L

2.14.1 Designation: 22R  
2.14.2 Approach Lighting System:  
2.14.4 Visual Approach Slope Indicator System:

2.14.1 Designation: 04R  
2.14.2 Approach Lighting System: MALSR  
2.14.4 Visual Approach Slope Indicator System: P4L

2.14.1 Designation: 22L  
2.14.2 Approach Lighting System:  
2.14.4 Visual Approach Slope Indicator System: P4L

2.14.1 Designation: 04W  
2.14.2 Approach Lighting System:  
2.14.4 Visual Approach Slope Indicator System:

2.14.1 Designation: 22W  
2.14.2 Approach Lighting System:  
2.14.4 Visual Approach Slope Indicator System:

2.14.1 Designation: 08L  
2.14.2 Approach Lighting System: MALSR  
2.14.4 Visual Approach Slope Indicator System: P4L

2.14.1 Designation: 26R  
2.14.2 Approach Lighting System:  
2.14.4 Visual Approach Slope Indicator System: P4L

2.14.1 Designation: 08R  
2.14.2 Approach Lighting System:  
2.14.4 Visual Approach Slope Indicator System: P4L

2.14.1 Designation: 26L  
2.14.2 Approach Lighting System: MALSF  
2.14.4 Visual Approach Slope Indicator System: P4L

2.14.1 Designation: 08W  
2.14.2 Approach Lighting System:  
2.14.4 Visual Approach Slope Indicator System:

2.14.1 Designation: 26W  
2.14.2 Approach Lighting System:  
2.14.4 Visual Approach Slope Indicator System:

**AD 2.18 Air Traffic Services Communication Facilities**

2.18.1 Service Designation: ADZY (HONOLULU RAMP ADZY)  
2.18.3 Channel: 121.8  
2.18.5 Hours of Operation:

2.18.1 Service Designation: ADZY (HICKAM RAMP ADZY)

2.18.3 Channel: 133.6

2.18.5 Hours of Operation:

2.18.1 Service Designation: ADZY (HICKAM RAMP ADZY)

2.18.3 Channel: 254.4

2.18.5 Hours of Operation:

2.18.1 Service Designation: ANG OPS

2.18.3 Channel: 293.7

2.18.5 Hours of Operation:

2.18.1 Service Designation: APCH/P

2.18.3 Channel: 317.6

2.18.5 Hours of Operation: 24

2.18.1 Service Designation: APCH/P DEP/P IC (WEST)

2.18.3 Channel: 118.3

2.18.5 Hours of Operation: 24

2.18.1 Service Designation: APCH/P DEP/P IC (WEST)

2.18.3 Channel: 269

2.18.5 Hours of Operation: 24

2.18.1 Service Designation: BANZI RNAV DP

2.18.3 Channel: 118.3

2.18.5 Hours of Operation: 24

2.18.1 Service Designation: BANZI RNAV DP

2.18.3 Channel: 269

2.18.5 Hours of Operation: 24

2.18.1 Service Designation: CD/P

2.18.3 Channel: 121.4

2.18.5 Hours of Operation: 24

2.18.1 Service Designation: CD/P

2.18.3 Channel: 281.4

2.18.5 Hours of Operation: 24

2.18.1 Service Designation: CLASS B (ARR E/NW DEP NW)

2.18.3 Channel: 119.1

2.18.5 Hours of Operation: 24

2.18.1 Service Designation: CLASS B (EAST)

2.18.3 Channel: 124.8

2.18.5 Hours of Operation: 24

2.18.1 Service Designation: CLASS B (ARR E/NW DEP NW)

2.18.3 Channel: 239.05

2.18.5 Hours of Operation: 24

2.18.1 Service Designation: COMD POST  
2.18.3 Channel: 141.8  
2.18.5 Hours of Operation:

2.18.1 Service Designation: COMD POST (15 AW COMD POST)  
2.18.3 Channel: 168  
2.18.5 Hours of Operation:

2.18.1 Service Designation: COMD POST  
2.18.3 Channel: 292.5  
2.18.5 Hours of Operation:

2.18.1 Service Designation: COMD POST (15 AW COMD POST)  
2.18.3 Channel: 295.5  
2.18.5 Hours of Operation:

2.18.1 Service Designation: D-ATIS  
2.18.3 Channel: 127.9  
2.18.5 Hours of Operation: 24

2.18.1 Service Designation: D-ATIS  
2.18.3 Channel: 251.15  
2.18.5 Hours of Operation: 24

2.18.1 Service Designation: DEP/P (EAST)  
2.18.3 Channel: 124.8  
2.18.5 Hours of Operation: 24

2.18.1 Service Designation: DEP/P CLASS B (EAST)  
2.18.3 Channel: 317.6  
2.18.5 Hours of Operation: 24

2.18.1 Service Designation: EMERG  
2.18.3 Channel: 121.5  
2.18.5 Hours of Operation:

2.18.1 Service Designation: EMERG  
2.18.3 Channel: 243  
2.18.5 Hours of Operation:

2.18.1 Service Designation: GND/P  
2.18.3 Channel: 121.9  
2.18.5 Hours of Operation: 24

2.18.1 Service Designation: GND/P  
2.18.3 Channel: 348.6  
2.18.5 Hours of Operation: 24

2.18.1 Service Designation: KEAHI DP (JORDA, LANAI, UPOLU TRNS.)  
2.18.3 Channel: 124.8  
2.18.5 Hours of Operation: 24



2.18.1 Service Designation: KEAHI DP (JORDA, LANAI, UPOLU TRNS.)  
2.18.3 Channel: 317.6  
2.18.5 Hours of Operation: 24

2.18.1 Service Designation: KEOLA DP (KATHS,LIHUE,LILIA,NONNI,PUPPI, SOUTH KAUAI TRNS.)  
2.18.3 Channel: 118.3  
2.18.5 Hours of Operation: 24

2.18.1 Service Designation: KEOLA DP (KATHS,LIHUE,LILIA,PUPPI,SOUTH KAUAI TRNS.)  
2.18.3 Channel: 269  
2.18.5 Hours of Operation: 24

2.18.1 Service Designation: LCL/P  
2.18.3 Channel: 118.1  
2.18.5 Hours of Operation: 24

2.18.1 Service Designation: LCL/P (RWY 08R/26L)  
2.18.3 Channel: 123.9  
2.18.5 Hours of Operation: 24

2.18.1 Service Designation: LCL/P  
2.18.3 Channel: 257.8  
2.18.5 Hours of Operation: 24

2.18.1 Service Designation: LCL/P (RWY 08R/26L)  
2.18.3 Channel: 273.575  
2.18.5 Hours of Operation: 24

2.18.1 Service Designation: MOLOKAI DP (APACK, CLUTS ,EBBER, FITES, PULPS, ZIGIE TRNS.)  
2.18.3 Channel: 124.8  
2.18.5 Hours of Operation: 24

2.18.1 Service Designation: MOLOKAI DP (APACK, CLUTS, EBBER, FITIES, PULPS, ZIGIE TRNS.)  
2.18.3 Channel: 317.6  
2.18.5 Hours of Operation: 24

2.18.1 Service Designation: OPS (SHAKA OPS)  
2.18.3 Channel: 125.3  
2.18.5 Hours of Operation:

2.18.1 Service Designation: OPS (SAC OPS)  
2.18.3 Channel: 311  
2.18.5 Hours of Operation:

2.18.1 Service Designation: OPS (SHAKA OPS)  
2.18.3 Channel: 349.4  
2.18.5 Hours of Operation:

2.18.1 Service Designation: PALAY DP (LANAI, MOLOKAI TRNS.)  
2.18.3 Channel: 124.8

2.18.5 Hours of Operation: 24

2.18.1 Service Designation: PALAY DP (LANAI, MOLOKAI TRNS.)

2.18.3 Channel: 317.6

2.18.5 Hours of Operation: 24

2.18.1 Service Designation: PIPLN RNAV DP

2.18.3 Channel: 124.8

2.18.5 Hours of Operation: 24

2.18.1 Service Designation: PIPLN RNAV DP

2.18.3 Channel: 317.6

2.18.5 Hours of Operation: 24

2.18.1 Service Designation: PTD (HICKAM)

2.18.3 Channel: 133.6

2.18.5 Hours of Operation:

2.18.1 Service Designation: PTD

2.18.3 Channel: 372.2

2.18.5 Hours of Operation:

#### **AD 2.19 Radio Navigation and Landing Aids**

2.19.1 ILS Type: DME for runway 04R. Magnetic variation: 11E

2.19.2 ILS Identification: IUM

2.19.5 Coordinates: 21-19-47.9018N / 157-54-10.9794W

2.19.6 Site Elevation: 19.5 ft

2.19.1 ILS Type: Glide Slope for runway 04R. Magnetic variation: 11E

2.19.2 ILS Identification: IUM

2.19.5 Coordinates: 21-18-53.9933N / 157-55-26.9028W

2.19.6 Site Elevation: 5.6 ft

2.19.1 ILS Type: Localizer for runway 04R. Magnetic variation: 11E

2.19.2 ILS Identification: IUM

2.19.5 Coordinates: 21-19-49.8152N / 157-54-13.0662W

2.19.6 Site Elevation: 5.1 ft

2.19.1 ILS Type: DME for runway 08L. Magnetic variation: 11E

2.19.2 ILS Identification: HNL

2.19.5 Coordinates: 21-19-27.8674N / 157-54-17.1566W

2.19.6 Site Elevation: 21.2 ft

2.19.1 ILS Type: Glide Slope for runway 08L. Magnetic variation: 11E

2.19.2 ILS Identification: HNL

2.19.5 Coordinates: 21-19-26.6745N / 157-56-24.533W

2.19.6 Site Elevation: 6.7 ft

2.19.1 ILS Type: Localizer for runway 08L. Magnetic variation: 11E

2.19.2 ILS Identification: HNL

2.19.5 Coordinates: 21-19-30.8788N / 157-54-14.7214W  
2.19.6 Site Elevation: 5.4 ft

2.19.1 ILS Type: Outer Marker for runway 08L. Magnetic variation: 11E  
2.19.2 ILS Identification: HNL  
2.19.5 Coordinates: 21-19-28.9934N / 158-2-56.1122W  
2.19.6 Site Elevation: 43.5 ft

2.19.1 ILS Type: DME for runway 26L. Magnetic variation: 11E  
2.19.2 ILS Identification: EPC  
2.19.5 Coordinates: 21-19-37.0011N / 157-54-25.9888W  
2.19.6 Site Elevation: 24 ft

2.19.1 ILS Type: Localizer for runway 26L. Magnetic variation: 11E  
2.19.2 ILS Identification: EPC  
2.19.5 Coordinates: 21-19-35.0845N / 157-54-28.3182W  
2.19.6 Site Elevation: 6.5 ft

2.19.1 Navigation Aid Type: VORTAC. Magnetic variation: 11E  
2.19.2 Navigation Aid Identification: HNL  
2.19.5 Coordinates: 21-18-29.9581N / 157-55-49.4801W  
2.19.6 Site Elevation: 5.1 ft

**General Remarks:**

MILITARY RSTD: JBPH-H IS PPR TO ALL NON-TFWC MSN, AMC TRNG MSN AND KC-135 8 UN & 8 EN MSN CALL 735TH MOC AT DSN (315) 499-6970 FOR PPR. ALL AMC PPR WILL BE COORD MON-FRI 1700-0400Z ONLY. ALL NON-AMC ACFT SUCH AS FOREIGN, SISTER SVC, TSNT ACFT, AND OTR MSN MUST CTC 15 OSS/OSA (AMOPS) AT DSN (315) 449-0046/0048 FOR PPR COORD. ALL PPR WILL BE APVD NO EARLIER THAN 72 HR BUT NO LATER THAN 24 HR PRIOR.

CAUTION: DURING PERIODS OF REPEATED PRECIPITATION ANTICIPATE WET RY CONDITONS, IF CURRENT CONDITIONS RQR CONFIRMATION CTC HONOLULU TWR ON INITIAL CONTACT.

CAUTION: RECREATIONAL BOATING ACTIVITIES ON AND INVOF WATERWAYS.

MILITARY: ALL MIL ACFT RQR CSTMS/AG/IMG INSPECTION MUST CTC 15WG COMMAND POST OR IF AMC CTC HICKAM AMCC, NLT 3 HRS PRIOR TO ARR WITH DEPARTURE LOCATION, EST BLOCK TIME, NR OF AIRCREW, CIV/MIL PAX, FOREIGN NATIONALS, AND DV CODES.\*

ALL JET ACFT CTC RAMP CONTROL PRIOR TO ENGINE START AT GATE OR HARD STAND.

MILITARY MISC: ALL FPL MUST BE FILED WITH PHNL AS DESTN. IF MIL SIDE OF ARPT IS FINAL DESTN, PLACE "DESTINATION HIK" IN RMKS OF FPL. FOR NOTAM USE PHNL IDENT.

MILITARY CAUTION: NO FIGHTER TRANSIENT SUPPORT AVAILABLE IN ACCORDANCE WITH ACC LSET FLASH SAFETY 06-02. TRANSIENT FIGHTER UNITS SHOULD PROVIDE THEIR OWN MAINTENANCE SUPPORT.

BIRD STRIKE HAZARD ALL RUNWAYS.

MILITARY/COMMUNICATIONS: BEDTIME (ALL CORONET W TANKERS USE 311.0 FOR TANKER-FTR INTER-PLANE ON LAUNCH DAY. AFT DUTY HR DSN 448-8888 613AOC/AMD, FLT MGMT).

MILITARY MISC: WX OPR H24, DSN 449-2251, C808-658-9961.

PPR FM AMGR FOR TRANSPORTATION OF CLASS A OR B EXPLOS IN AND/OR OUT OF HNL.

TFC PAT OVHD ALT 2000 FT, RESTRICTED TO HIANG AND SENTRY ALOHA ACFT.

APRON TAXILANE 2 EAST END 360 FT CLSD.

MILITARY MISC: ANG - HI ANG AFLD OPS OPR 1500-0300Z MON-FRI AND UTA WKENDS; CLSD SAT, SUN AND HOL.

MILITARY CAUTION: FOD HAZARD EXISTS ON ALL MOVEMENT AREAS E OF TWY S. FIGHTER AIRCRAFT EXERCISE EXTREME CTN WHEN TAXIING.

MILITARY MISC 2 OF 2: WAIVERS WILL BE GRANTED ON EXTREME NEC. IF SHORT NOTICE MSN ESSENTIAL WAIVERS ARE NEC, CTC 15OG/CC BY FONE THRU 15 WG COMD POST(15 WG/CP) OR 154 OG/CC FOR HIANG AIRCRAFT. 15 WG COMMAND POST WILL PASS APVL TO HICKAM FLT SVC AND HICKAM RAMP ADZY.

MILITARY RSTD: MIL ACFT OPR DUR BIRD WATCH COND MODERATE (INITIAL TKOF OR FULL STOP LDG ONLY, NO MULTIPLE IFR/VFR APCH) AND SEVERE (TKOF AND LDG PROH WO 15 OG/CC APVL OR 154 OG/CC APVL FOR HIANG ACFT) CTC HIK RAMP, PTD, 15 WG COMD POST, 735 AMC COMD POST, 154 WG COMD POST FOR CURRENT COND.

MILITARY A-GEAR: HOOK MB100(B) LCTD 200 FT FM THLD RY 26R.

MILITARY TRAN ALERT: 15 WG CAN PROVIDE EQPT BUT CREWS MUST PROVIDE OWN PERS WHEN NEEDED.

TWYS G ADG V AND BELOW POWER IN W/PPR.

MILITARY CAUTION: A FOD HAZARD EXISTS ON ALL TAXIWAYS AND RUNWAYS BUT ESPECIALLY ON RUNWAY 4L/22R AND TAXIWAYS NORTH OF RUNWAY 8L/26R.

MILITARY RSTD: UPON ARR, CREWS WILL PRVD CREW ORDER/EAL TO 647 SFS PATROL AND PROCD DRCTLY TO COMMAND POST (BLDG 2050) AND CMPLT AN OUBD SETUP SHEET TO FACILITATE DEP RQMNTS.

DUE TO NON-VISIBILITY TWR UNA TO DTRM IF THE FLWG AREAS ARE CLEAR OF OBSTNS AND/OR TFC: PTNS OF TWY J BTN TWY B & RWY 08R; PTNS OF INTER-ISLAND ACFT PRKG RAMP.

MILITARY MISC: AFLD OPS DSN 449-0046/0048 FAX DSN 449-7624.

RYS 04W/22W AND 08W/26W RECREATIONAL BOATING ACTIVITIES ON AND INVOF WATERWAYS.

MILITARY MISC 1 OF 2: DUE TO SENSITIVITIES OF CITIZENS, FTR ACFT DEP ONLY AUTHORIZED FR 1700-0700Z MON-SAT, AND 1800-0700Z SUN AND HOL. ALL REQ FOR WAIVERS WILL BE SENT TO THE 15/OG/CC OR 154 OG/CC FOR HIANG AIRCRAFT AT LEAST 5 WORKING DAYS IN ADVANCE.

MILITARY MISC: NO COMSEC MATERIAL AVBL THRU HICKAM AIRFIELD OPS.

RMN AT LEAST 1 MILE OFF SHORE OF WAIKIKI DIAMOND HEAD KOKO HEAD & EWA BEACH. ARR RWY 08L; FLY ILS APCH PROC OR A CLOSE-IN BASE LEG RMNG OVER CNTR OF PEARL HARBOR CHNL. ARR 26L/R; RNM AT TFC PAT ALTS AS LONG AS PSBL BFR BGNG DSCNT FOR LNDG.

MILITARY RSTD: ALL TRAN ACFT NOT ON AN AMC/TWCF MSN AND HOME STN ACFT TERMINATING AT JBPH-H, WILL PROVIDE A 3 HR OUT CALL (COMM 808-448-6900) AS WELL AS A 20-30 MIN OUT CALL ON

292.5 TO THE 15 WG/CP (KOA CONTROL).

DUE TO LOCATION OF ATCT, CONTROLLERS UNABLE TO DETERMINE WHETHER ACFT ARE ON CORRECT FINAL APCH TO RYS 04L-04R AND 22L-22R.

MILITARY RSTD: IF ACFT IS CARRYING HAZ CARGO, CARGO MANIFEST IS ALSO RQRD. AVBL TIMES TO ACCEPT HAZ CARGO ARE 0400-1600Z; ALL HAZ CARGO MUST COORDINATE WITH AMOPS 449-0046/48 48 HRS PRIOR TO MSN.

MILITARY SERVICE-A-GEAR: RWY 4R/22L AND 8R/26L SFC GROOVED WITHIN 10 FT OF A-G SYSTEM. POTENTIAL FOR FTR ACFT TAIL HOOK SKIP EXISTS.

MILITARY SERVICE-FUEL: A++ (MIL; AVBL H24).

WIDE BODY AND 4 ENGINE TBJS LDG ON RY 04R ROLL TO END OF RY, NO LEFT TURN AT TWY K WO APVL.

ASDE-X IN USE. OPERATE TRANSPONDERS WITH ALTITUDE REPORTING MODE AND ADS-B (IF EQUIPPED) ENABLED ON ALL AIRPORT SURFACES.

MILITARY: ALL MIL ACFT WITH VIP CODE 7 OR ABV CTC 15WG COMMAND POST OR RELAY THRU HF/SSB AWY 1 HR OUT TO CFM BLOCKTIME.

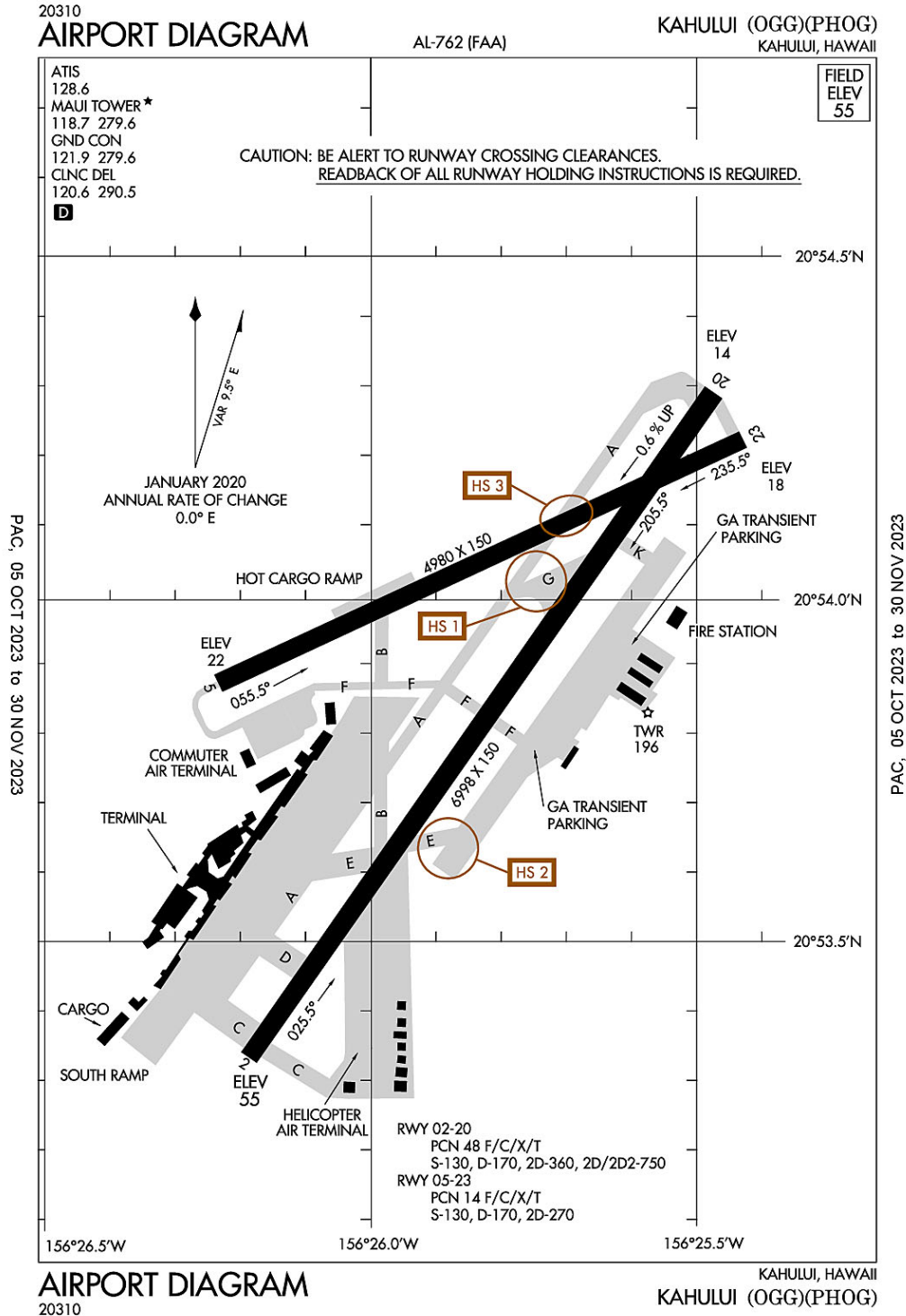
MILITARY REMARKS: SEE FLIP AP/3 SUPPLEMENTARY APRT INFO, RTE AND AREA RSTD, AND OAKLAND FIR FLT HAZ.

MILITARY MISC (2 OF 2 CONT'D): LTD WX BRIEF SUPPORT.REMOTE FLT WX BRIEFINGS CTC 17TH WX SQ H24, DSN 315-449-7950/8333, FAX DSN 315-449-8336; 2 HR PN RQR FOR TIMELY BRIEF.OFFICIAL OBSN TAKEN BY FAA. COOPERATIVE WX WATCH PROCEDURES DO NOT EXIST BTW WX AND ATC.

MILITARY RSTD: TWR APVL RQRD TO USE TWY KILO FROM RWY 4R. HOLD LINE IN EFCT FOR TWY R7 BTN PTN OF TWY XNG APCH ZONE FOR RWY 04L/R. TWY P CLSD TO ACFT OVER 12500 LBS.

APRON TAXILANE 6 BTWN TWY C AND SOUTH RAMP CLSD EXCEPT GA/FIXED WING LOADING/UNLOADING ONLY.

**Kahului, Hawaii**  
**Kahului**  
**ICAO Identifier PHOG**



**Kahului, HI**  
**Kahului**  
**ICAO Identifier PHOG**

**AD 2.2 Aerodrome geographical and administrative data**

- 2.2.1 Reference Point: 20-53-55.135N / 156-25-49.651W
- 2.2.2 From City: 3 miles E of KAHULUI, HI
- 2.2.3 Elevation: 55.4 ft
- 2.2.5 Magnetic Variation: 11E (1990)
- 2.2.6 Airport Contact: MARVIN MONIZ  
1 KAHULUI AIRPORT ROAD, UNIT 5  
KAHULUI, HI 96732 (808-872-3808)
- 2.2.7 Traffic: IFR/VFR

**AD 2.3 Attendance Schedule**

- 2.3.1 All Months, All Days, All Hours

**AD 2.4 Handling Services and Facilities**

- 2.4.1 Cargo Handling Facilities: YES
- 2.4.2 Fuel Types: 100,A
- 2.4.5 Hangar Space:
- 2.4.6 Repair Facilities: MINOR

**AD 2.6 Rescue and Firefighting Services**

- 2.6.1 Aerodrome Category: Class-I certified on 5/1/1973
- 2.6.2 Rescue and Firefighting Services: ARFF Index-D

**AD 2.12 Runway Physical Characteristics**

- 2.12.1 Designation: 02
- 2.12.2 True Bearing: 35
- 2.12.3 Dimensions: 6998 ft x 150 ft
- 2.12.4 PCN: 48 F/C/X/T
- 2.12.5 Coordinates: 20-53-20.9058N / 156-26-10.7497W
- 2.12.6 Threshold Elevation: 55.3 ft
- 2.12.6 Touchdown Zone Elevation: 55.4 ft

- 2.12.1 Designation: 20
- 2.12.2 True Bearing: 215
- 2.12.3 Dimensions: 6998 ft x 150 ft
- 2.12.4 PCN: 48 F/C/X/T
- 2.12.5 Coordinates: 20-54-17.7389N / 156-25-28.4443W
- 2.12.6 Threshold Elevation: 14.3 ft
- 2.12.6 Touchdown Zone Elevation: 27 ft

- 2.12.1 Designation: 05
- 2.12.2 True Bearing: 65
- 2.12.3 Dimensions: 4980 ft x 150 ft
- 2.12.4 PCN: 14 F/C/X/T
- 2.12.5 Coordinates: 20-53-52.8965N / 156-26-13.521W
- 2.12.6 Threshold Elevation: 22.1 ft
- 2.12.6 Touchdown Zone Elevation: 22.2 ft

2.12.1 Designation: 23  
2.12.2 True Bearing: 245  
2.12.3 Dimensions: 4980 ft x 150 ft  
2.12.4 PCN: 14 F/C/X/T  
2.12.5 Coordinates: 20-54-13.7155N / 156-25-25.928W  
2.12.6 Threshold Elevation: 17.6 ft  
2.12.6 Touchdown Zone Elevation: 18.9 ft

2.12.1 Designation: H1  
2.12.2 True Bearing:  
2.12.3 Dimensions: 125 ft x 125 ft  
2.12.4 PCN:  
2.12.5 Coordinates: -- / --  
2.12.6 Threshold Elevation: ft  
2.12.6 Touchdown Zone Elevation: ft

### **AD 2.13 Declared Distances**

2.13.1 Designation: 02  
2.13.2 Take-off Run Available: 6995  
2.13.3 Take-off Distance Available: 6995  
2.13.4 Accelerate-Stop Distance Available: 6995  
2.13.5 Landing Distance Available: 6995

2.13.1 Designation: 20  
2.13.2 Take-off Run Available: 6995  
2.13.3 Take-off Distance Available: 6995  
2.13.4 Accelerate-Stop Distance Available: 6995  
2.13.5 Landing Distance Available: 6995

2.13.1 Designation: 05  
2.13.2 Take-off Run Available: 4990  
2.13.3 Take-off Distance Available: 4990  
2.13.4 Accelerate-Stop Distance Available: 4990  
2.13.5 Landing Distance Available: 4990

2.13.1 Designation: 23  
2.13.2 Take-off Run Available: 4990  
2.13.3 Take-off Distance Available: 4990  
2.13.4 Accelerate-Stop Distance Available: 4990  
2.13.5 Landing Distance Available: 4990

2.13.1 Designation: H1  
2.13.2 Take-off Run Available:  
2.13.3 Take-off Distance Available:  
2.13.4 Accelerate-Stop Distance Available:  
2.13.5 Landing Distance Available:

### **AD 2.14 Approach and Runway Lighting**



2.14.1 Designation: 02  
2.14.2 Approach Lighting System: MALSR  
2.14.4 Visual Approach Slope Indicator System: P4R

2.14.1 Designation: 20  
2.14.2 Approach Lighting System:  
2.14.4 Visual Approach Slope Indicator System: P4L

2.14.1 Designation: 05  
2.14.2 Approach Lighting System:  
2.14.4 Visual Approach Slope Indicator System: P4L

2.14.1 Designation: 23  
2.14.2 Approach Lighting System:  
2.14.4 Visual Approach Slope Indicator System:

2.14.1 Designation: H1  
2.14.2 Approach Lighting System:  
2.14.4 Visual Approach Slope Indicator System:

**AD 2.18 Air Traffic Services Communication Facilities**

2.18.1 Service Designation: APCH/P DEP/P IC (SOUTH)  
2.18.3 Channel: 119.5  
2.18.5 Hours of Operation: 0600–2300 (MAR–NOV)  
0600–2400 (NOV–MAR)

2.18.1 Service Designation: APCH/P DEP/P IC (NORTH)  
2.18.3 Channel: 120.2  
2.18.5 Hours of Operation: 0600–2300 (MAR–NOV)  
0600–2400 (NOV–MAR)

2.18.1 Service Designation: APCH/P DEP/P IC (SOUTH)  
2.18.3 Channel: 225.4  
2.18.5 Hours of Operation: 0600–2300 (MAR–NOV)  
0600–2400 (NOV–MAR)

2.18.1 Service Designation: APCH/P DEP/P IC (NORTH)  
2.18.3 Channel: 322.4  
2.18.5 Hours of Operation: 0600–2300 (MAR–NOV)  
0600–2400 (NOV–MAR)

2.18.1 Service Designation: ATIS  
2.18.3 Channel: 128.6  
2.18.5 Hours of Operation: 24

2.18.1 Service Designation: CD/P  
2.18.3 Channel: 120.6  
2.18.5 Hours of Operation: 0600–2300 (MAR–NOV)  
0600–2400 (NOV–MAR)

2.18.1 Service Designation: CD/P  
2.18.3 Channel: 290.5  
2.18.5 Hours of Operation: 0600-2300 (MAR-NOV)  
0600-2400 (NOV-MAR)

2.18.1 Service Designation: CLASS C (SOUTH)  
2.18.3 Channel: 119.5  
2.18.5 Hours of Operation: 0600-2300 (MAR-NOV)  
0600-2400 (NOV-MAR)

2.18.1 Service Designation: CLASS C (NORTH)  
2.18.3 Channel: 120.2  
2.18.5 Hours of Operation: 0600-2300 (MAR-NOV)  
0600-2400 (NOV-MAR)

2.18.1 Service Designation: CLASS C (SOUTH)  
2.18.3 Channel: 225.4  
2.18.5 Hours of Operation: 0600-2300 (MAR-NOV)  
0600-2400 (NOV-MAR)

2.18.1 Service Designation: CLASS C (NORTH)  
2.18.3 Channel: 322.4  
2.18.5 Hours of Operation: 0600-2300 (MAR-NOV)  
0600-2400 (NOV-MAR)

2.18.1 Service Designation: EMERG  
2.18.3 Channel: 121.5  
2.18.5 Hours of Operation:

2.18.1 Service Designation: EMERG  
2.18.3 Channel: 243  
2.18.5 Hours of Operation:

2.18.1 Service Designation: GND/P  
2.18.3 Channel: 121.9  
2.18.5 Hours of Operation: 0600-2300 (MAR-NOV)  
0600-2400 (NOV-MAR)

2.18.1 Service Designation: GND/P  
2.18.3 Channel: 279.6  
2.18.5 Hours of Operation: 0600-2300 (MAR-NOV)  
0600-2400 (NOV-MAR)

2.18.1 Service Designation: LCL/P  
2.18.3 Channel: 118.7  
2.18.5 Hours of Operation: 0600-2300 (MAR-NOV)  
0600-2400 (NOV-MAR)

2.18.1 Service Designation: LCL/P  
2.18.3 Channel: 279.6  
2.18.5 Hours of Operation: 0600-2300 (MAR-NOV)

0600-2400 (NOV-MAR)

**AD 2.19 Radio Navigation and Landing Aids**

2.19.1 ILS Type: DME for runway 02. Magnetic variation: 11E

2.19.2 ILS Identification: OGG

2.19.5 Coordinates: 20-54-27.3859N / 156-25-23.7568W

2.19.6 Site Elevation: 22 ft

2.19.1 ILS Type: Glide Slope for runway 02. Magnetic variation: 11E

2.19.2 ILS Identification: OGG

2.19.5 Coordinates: 20-53-29.5489N / 156-25-59.2238W

2.19.6 Site Elevation: 49.5 ft

2.19.1 ILS Type: Localizer for runway 02. Magnetic variation: 11E

2.19.2 ILS Identification: OGG

2.19.5 Coordinates: 20-54-25.9395N / 156-25-22.344W

2.19.6 Site Elevation: 11.1 ft

2.19.1 Navigation Aid Type: VORTAC. Magnetic variation: 11E

2.19.2 Navigation Aid Identification: OGG

2.19.5 Coordinates: 20-54-23.2995N / 156-25-15.4249W

2.19.6 Site Elevation: 24.3 ft

**General Remarks:**

ACCESS TO HELIPAD FM TWY C ONLY.

ACFT OVR 30,000 LB LDG ON RY 02/20 UNA TO TURN OFF ONTO RY 05/23 DUE TO PAVEMENT COND.

MIGRATORY BIRD ACTIVITY BLO 1500 FT WI 5 NM RADIUS OF ARPT DURG AUG-MAY.

570' LGTD TWR APRX 3 MI. W.

COMMUTER AIR TRML RSTRD TO PART 121 AND PART 135 OPRS ONLY. ACFT AT THE TRML SHALL CALL THE TWR ON 121.9 PRIOR TO PUSHBACK.

FOR CD WHEN ATCT IS CLSD CTC HONOLULU CONTROL FACILITY AT 808-840-6262.

RY 02/20 SINGLE-BELLY TWIN TANDEM (SBTT) GWT 460,000 LBS.

TSNT PARKING LCTD ON NE SECTION OF E RAMP.

PPR FOR FIXED WING ACFT OPNS ON HELIPAD DURG NON-OPERATIONAL HRS CALL (808) 872-3880 5:15A-10:00P.

COMMUTER TERMINAL RAMP RESTRICTED TO ACFT 140000 LBS OR LESS.

DUE TO NONVISIBILITY ATCT UNABLE TO DETERMINE IF FLWG AREA IS CLEAR OF OBSTNS AND/OR TFC: PORTION OF TWY F BTN THE COMMUTER AIR TERMINAL & APCH END RY 05.

DUE TO NONVISIBILITY ATCT UNABLE TO PROVIDE ATC SVC BTN ACFT & GROUND VEHICLES ON THE COMMUTER AIR TERMINAL S OF TWY F AND THE HELICOPTER AIR TERMINAL E OF APCH END RY 02.

AREA E OF APCH END RY 02 DESIGNATED AS HELICOPTER OPER AREA. NO FIXED WING ACFT MAY OPER

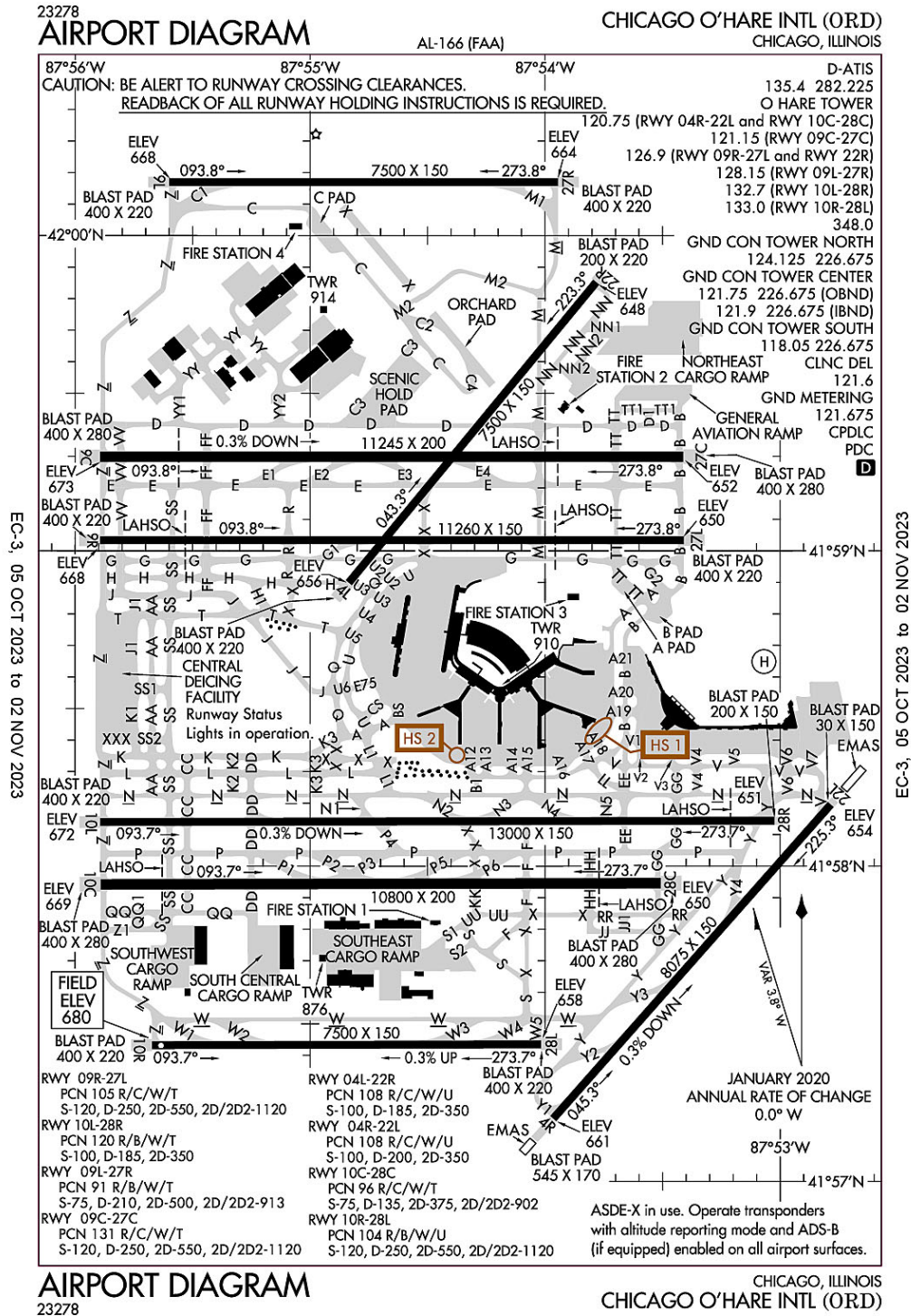
ON HELIPAD DURG OPNL HRS SR-SS.

RAMP AREA E SIDE RY 02 UNDER STATE AUTHORITY. FAA NOT RESPONSIBLE FOR DIRECTION & CTL GND TFC IN AREA.

MIL HEL OPS WITH PPR RSTRD TO THE SW CORNER OF HOT CARGO APRON (HAZMAT) N OF RWY 05/23.

24 HRS PPR FOR DIVISION 1.1,1.2,1.3 EXPLOSIVES AND 4 HRS PPR FOR OTHER HAZARDOUS CARGO IN/OUT OF ARPT; CTC (808) 872-3830 0745-1630 OTHER TIMES (808) 872-3888.

### Chicago, Illinois Chicago-O'Hare International ICAO Identifier KORD



**Chicago, IL**  
**Chicago O'Hare Intl**  
**ICAO Identifier KORD**

**AD 2.2 Aerodrome geographical and administrative data**

- 2.2.1 Reference Point: 41-58-36.985N / 87-54-29.339W
- 2.2.2 From City: 14 miles NW of CHICAGO, IL
- 2.2.3 Elevation: 680 ft
- 2.2.5 Magnetic Variation: 3W (2010)
- 2.2.6 Airport Contact: JAMIE RHEE  
10510 WEST ZEMKE RO  
CHICAGO, IL 60666 (773-686-8060)
- 2.2.7 Traffic: IFR/VFR

**AD 2.3 Attendance Schedule**

- 2.3.1 All Months, All Days, All Hours

**AD 2.4 Handling Services and Facilities**

- 2.4.1 Cargo Handling Facilities: NO
- 2.4.2 Fuel Types: 100LL,A
- 2.4.5 Hangar Space:
- 2.4.6 Repair Facilities: MAJOR

**AD 2.6 Rescue and Firefighting Services**

- 2.6.1 Aerodrome Category: Class-I certified on 5/1/1973
- 2.6.2 Rescue and Firefighting Services: ARFF Index-E

**AD 2.12 Runway Physical Characteristics**

- 2.12.1 Designation: 04L
- 2.12.2 True Bearing: 39
- 2.12.3 Dimensions: 7500 ft x 150 ft
- 2.12.4 PCN: 108 R/C/W/U
- 2.12.5 Coordinates: 41-58-53.9601N / 87-54-50.1039W
- 2.12.6 Threshold Elevation: 655.7 ft
- 2.12.6 Touchdown Zone Elevation: 658.2 ft

- 2.12.1 Designation: 22R
- 2.12.2 True Bearing: 219
- 2.12.3 Dimensions: 7500 ft x 150 ft
- 2.12.4 PCN: 108 R/C/W/U
- 2.12.5 Coordinates: 41-59-51.1336N / 87-53-46.9364W
- 2.12.6 Threshold Elevation: 647.7 ft
- 2.12.6 Touchdown Zone Elevation: 651.5 ft

- 2.12.1 Designation: 04R
- 2.12.2 True Bearing: 42
- 2.12.3 Dimensions: 8075 ft x 150 ft
- 2.12.4 PCN: 108 R/C/W/U
- 2.12.5 Coordinates: 41-57-11.9778N / 87-53-57.9066W
- 2.12.6 Threshold Elevation: 661.4 ft
- 2.12.6 Touchdown Zone Elevation: 661.4 ft

2.12.1 Designation: 22L  
2.12.2 True Bearing: 222  
2.12.3 Dimensions: 8075 ft x 150 ft  
2.12.4 PCN: 108 R/C/W/U  
2.12.5 Coordinates: 41-58-11.718N / 87-52-47.0759W  
2.12.6 Threshold Elevation: 654.4 ft  
2.12.6 Touchdown Zone Elevation: 654.4 ft

2.12.1 Designation: 09C  
2.12.2 True Bearing: 90  
2.12.3 Dimensions: 11245 ft x 200 ft  
2.12.4 PCN: 131 R/C/W/T  
2.12.5 Coordinates: 41-59-17.8916N / 87-55-53.6564W  
2.12.6 Threshold Elevation: 673.3 ft  
2.12.6 Touchdown Zone Elevation: 673.3 ft

2.12.1 Designation: 27C  
2.12.2 True Bearing: 270  
2.12.3 Dimensions: 11245 ft x 200 ft  
2.12.4 PCN: 131 R/C/W/T  
2.12.5 Coordinates: 41-59-17.9172N / 87-53-24.7562W  
2.12.6 Threshold Elevation: 652.4 ft  
2.12.6 Touchdown Zone Elevation: 652.8 ft

2.12.1 Designation: 27R  
2.12.2 True Bearing: 270  
2.12.3 Dimensions: 7500 ft x 150 ft  
2.12.4 PCN: 91 R/B/W/T  
2.12.5 Coordinates: 42-0-10.1909N / 87-53-56.6997W  
2.12.6 Threshold Elevation: 663.6 ft  
2.12.6 Touchdown Zone Elevation: 663.6 ft

2.12.1 Designation: 09L  
2.12.2 True Bearing: 90  
2.12.3 Dimensions: 7500 ft x 150 ft  
2.12.4 PCN: 91 R/B/W/T  
2.12.5 Coordinates: 42-0-10.1954N / 87-55-36.0339W  
2.12.6 Threshold Elevation: 668 ft  
2.12.6 Touchdown Zone Elevation: 668 ft

2.12.1 Designation: 09R  
2.12.2 True Bearing: 90  
2.12.3 Dimensions: 11260 ft x 150 ft  
2.12.4 PCN: 105 R/C/W/T  
2.12.5 Coordinates: 41-59-2.0171N / 87-55-53.6481W  
2.12.6 Threshold Elevation: 668.2 ft  
2.12.6 Touchdown Zone Elevation: 668.2 ft

2.12.1 Designation: 27L  
2.12.2 True Bearing: 270

2.12.3 Dimensions: 11260 ft x 150 ft  
2.12.4 PCN: 105 R/C/W/T  
2.12.5 Coordinates: 41-59-2.0417N / 87-53-24.5558W  
2.12.6 Threshold Elevation: 650.3 ft  
2.12.6 Touchdown Zone Elevation: 653.9 ft

2.12.1 Designation: 10C  
2.12.2 True Bearing: 90  
2.12.3 Dimensions: 10800 ft x 200 ft  
2.12.4 PCN: 96 R/C/W/T  
2.12.5 Coordinates: 41-57-56.5251N / 87-55-53.4778W  
2.12.6 Threshold Elevation: 669.4 ft  
2.12.6 Touchdown Zone Elevation: 669.4 ft

2.12.1 Designation: 28C  
2.12.2 True Bearing: 270  
2.12.3 Dimensions: 10800 ft x 200 ft  
2.12.4 PCN: 96 R/C/W/T  
2.12.5 Coordinates: 41-57-56.7568N / 87-53-30.5171W  
2.12.6 Threshold Elevation: 650.1 ft  
2.12.6 Touchdown Zone Elevation: 651.1 ft

2.12.1 Designation: 28R  
2.12.2 True Bearing: 270  
2.12.3 Dimensions: 13000 ft x 150 ft  
2.12.4 PCN: 120 R/B/W/T  
2.12.5 Coordinates: 41-58-8.6529N / 87-53-1.4244W  
2.12.6 Threshold Elevation: 651.4 ft  
2.12.6 Touchdown Zone Elevation: 651.4 ft

2.12.1 Designation: 10L  
2.12.2 True Bearing: 90  
2.12.3 Dimensions: 13000 ft x 150 ft  
2.12.4 PCN: 120 R/B/W/T  
2.12.5 Coordinates: 41-58-8.3816N / 87-55-53.5142W  
2.12.6 Threshold Elevation: 672.1 ft  
2.12.6 Touchdown Zone Elevation: 672.1 ft

2.12.1 Designation: 28L  
2.12.2 True Bearing: 270  
2.12.3 Dimensions: 7500 ft x 150 ft  
2.12.4 PCN: 104 R/B/W/U  
2.12.5 Coordinates: 41-57-26.0865N / 87-54-1.0355W  
2.12.6 Threshold Elevation: 658 ft  
2.12.6 Touchdown Zone Elevation: 666.8 ft

2.12.1 Designation: 10R  
2.12.2 True Bearing: 90  
2.12.3 Dimensions: 7500 ft x 150 ft  
2.12.4 PCN: 104 R/B/W/U  
2.12.5 Coordinates: 41-57-25.924N / 87-55-40.3004W



2.12.6 Threshold Elevation: 680 ft  
2.12.6 Touchdown Zone Elevation: 680 ft

2.12.1 Designation: 10X  
2.12.2 True Bearing:  
2.12.3 Dimensions: 0 ft x 0 ft  
2.12.4 PCN:  
2.12.5 Coordinates: -- / --  
2.12.6 Threshold Elevation: ft  
2.12.6 Touchdown Zone Elevation: ft

2.12.1 Designation: H1  
2.12.2 True Bearing:  
2.12.3 Dimensions: 200 ft x 100 ft  
2.12.4 PCN:  
2.12.5 Coordinates: 41-58-39.0644N / 87-53-4.0081W  
2.12.6 Threshold Elevation: 649.7 ft  
2.12.6 Touchdown Zone Elevation: ft

#### **AD 2.13 Declared Distances**

2.13.1 Designation: 04L  
2.13.2 Take-off Run Available: 7500  
2.13.3 Take-off Distance Available: 7500  
2.13.4 Accelerate-Stop Distance Available: 7500  
2.13.5 Landing Distance Available:

2.13.1 Designation: 22R  
2.13.2 Take-off Run Available:  
2.13.3 Take-off Distance Available:  
2.13.4 Accelerate-Stop Distance Available:  
2.13.5 Landing Distance Available: 7300

2.13.1 Designation: 04R  
2.13.2 Take-off Run Available: 8075  
2.13.3 Take-off Distance Available: 8075  
2.13.4 Accelerate-Stop Distance Available: 8075  
2.13.5 Landing Distance Available: 8075

2.13.1 Designation: 22L  
2.13.2 Take-off Run Available: 8075  
2.13.3 Take-off Distance Available: 8075  
2.13.4 Accelerate-Stop Distance Available: 8075  
2.13.5 Landing Distance Available: 8075

2.13.1 Designation: 09C  
2.13.2 Take-off Run Available: 11245  
2.13.3 Take-off Distance Available: 11245  
2.13.4 Accelerate-Stop Distance Available: 11245  
2.13.5 Landing Distance Available: 11245

2.13.1 Designation: 27C  
2.13.2 Take-off Run Available: 11245  
2.13.3 Take-off Distance Available: 11245  
2.13.4 Accelerate-Stop Distance Available: 11245  
2.13.5 Landing Distance Available: 11245

2.13.1 Designation: 27R  
2.13.2 Take-off Run Available: 7500  
2.13.3 Take-off Distance Available: 7500  
2.13.4 Accelerate-Stop Distance Available: 7500  
2.13.5 Landing Distance Available: 7500

2.13.1 Designation: 09L  
2.13.2 Take-off Run Available: 7500  
2.13.3 Take-off Distance Available: 7500  
2.13.4 Accelerate-Stop Distance Available: 7500  
2.13.5 Landing Distance Available: 7500

2.13.1 Designation: 09R  
2.13.2 Take-off Run Available: 11260  
2.13.3 Take-off Distance Available: 11260  
2.13.4 Accelerate-Stop Distance Available: 11260  
2.13.5 Landing Distance Available: 11260

2.13.1 Designation: 27L  
2.13.2 Take-off Run Available: 11260  
2.13.3 Take-off Distance Available: 11260  
2.13.4 Accelerate-Stop Distance Available: 11260  
2.13.5 Landing Distance Available: 11260

2.13.1 Designation: 10C  
2.13.2 Take-off Run Available: 10800  
2.13.3 Take-off Distance Available: 10800  
2.13.4 Accelerate-Stop Distance Available: 10540  
2.13.5 Landing Distance Available: 10540

2.13.1 Designation: 28C  
2.13.2 Take-off Run Available: 10800  
2.13.3 Take-off Distance Available: 10800  
2.13.4 Accelerate-Stop Distance Available: 10800  
2.13.5 Landing Distance Available: 10800

2.13.1 Designation: 28R  
2.13.2 Take-off Run Available: 13000  
2.13.3 Take-off Distance Available: 13000  
2.13.4 Accelerate-Stop Distance Available: 13000  
2.13.5 Landing Distance Available: 13000

2.13.1 Designation: 10L  
2.13.2 Take-off Run Available: 13000  
2.13.3 Take-off Distance Available: 13000

2.13.4 Accelerate-Stop Distance Available: 13000  
2.13.5 Landing Distance Available: 12246

2.13.1 Designation: 28L  
2.13.2 Take-off Run Available: 7500  
2.13.3 Take-off Distance Available: 7500  
2.13.4 Accelerate-Stop Distance Available: 7500  
2.13.5 Landing Distance Available: 7500

2.13.1 Designation: 10R  
2.13.2 Take-off Run Available: 7500  
2.13.3 Take-off Distance Available: 7500  
2.13.4 Accelerate-Stop Distance Available: 7500  
2.13.5 Landing Distance Available: 7500

2.13.1 Designation: 10X  
2.13.2 Take-off Run Available:  
2.13.3 Take-off Distance Available:  
2.13.4 Accelerate-Stop Distance Available:  
2.13.5 Landing Distance Available:

2.13.1 Designation: H1  
2.13.2 Take-off Run Available:  
2.13.3 Take-off Distance Available:  
2.13.4 Accelerate-Stop Distance Available:  
2.13.5 Landing Distance Available:

#### **AD 2.14 Approach and Runway Lighting**

2.14.1 Designation: 04L  
2.14.2 Approach Lighting System:  
2.14.4 Visual Approach Slope Indicator System:

2.14.1 Designation: 22R  
2.14.2 Approach Lighting System: MALSR  
2.14.4 Visual Approach Slope Indicator System: P4L

2.14.1 Designation: 04R  
2.14.2 Approach Lighting System: MALSR  
2.14.4 Visual Approach Slope Indicator System: P4R

2.14.1 Designation: 22L  
2.14.2 Approach Lighting System: MALSR  
2.14.4 Visual Approach Slope Indicator System: P4L

2.14.1 Designation: 09C  
2.14.2 Approach Lighting System: ALSF2  
2.14.4 Visual Approach Slope Indicator System: P4L

2.14.1 Designation: 27C  
2.14.2 Approach Lighting System: ALSF2

2.14.4 Visual Approach Slope Indicator System: P4L

2.14.1 Designation: 27R

2.14.2 Approach Lighting System: ALSF2

2.14.4 Visual Approach Slope Indicator System:

2.14.1 Designation: 09L

2.14.2 Approach Lighting System: ALSF2

2.14.4 Visual Approach Slope Indicator System:

2.14.1 Designation: 09R

2.14.2 Approach Lighting System: ALSF2

2.14.4 Visual Approach Slope Indicator System: P4L

2.14.1 Designation: 27L

2.14.2 Approach Lighting System: ALSF2

2.14.4 Visual Approach Slope Indicator System: P4R

2.14.1 Designation: 10C

2.14.2 Approach Lighting System: ALSF2

2.14.4 Visual Approach Slope Indicator System: P4L

2.14.1 Designation: 28C

2.14.2 Approach Lighting System: ALSF2

2.14.4 Visual Approach Slope Indicator System: P4L

2.14.1 Designation: 28R

2.14.2 Approach Lighting System: ALSF2

2.14.4 Visual Approach Slope Indicator System: P4L

2.14.1 Designation: 10L

2.14.2 Approach Lighting System: ALSF2

2.14.4 Visual Approach Slope Indicator System: P4L

2.14.1 Designation: 28L

2.14.2 Approach Lighting System: ALSF2

2.14.4 Visual Approach Slope Indicator System:

2.14.1 Designation: 10R

2.14.2 Approach Lighting System: ALSF2

2.14.4 Visual Approach Slope Indicator System:

2.14.1 Designation: 10X

2.14.2 Approach Lighting System:

2.14.4 Visual Approach Slope Indicator System:

2.14.1 Designation: H1

2.14.2 Approach Lighting System:

2.14.4 Visual Approach Slope Indicator System:

**AD 2.18 Air Traffic Services Communication Facilities**

2.18.1 Service Designation: ALCP

2.18.3 Channel: 252.1

2.18.5 Hours of Operation:

2.18.1 Service Designation: CD PRE TAXI CLNC

2.18.3 Channel: 121.6

2.18.5 Hours of Operation: 24

2.18.1 Service Designation: CD/P

2.18.3 Channel: 121.6

2.18.5 Hours of Operation: 24

2.18.1 Service Designation: CD/S

2.18.3 Channel: 119.25

2.18.5 Hours of Operation: 24

2.18.1 Service Designation: D-ATIS

2.18.3 Channel: 135.4

2.18.5 Hours of Operation: 24

2.18.1 Service Designation: D-ATIS

2.18.3 Channel: 282.225

2.18.5 Hours of Operation: 24

2.18.1 Service Designation: EMERG

2.18.3 Channel: 121.5

2.18.5 Hours of Operation:

2.18.1 Service Designation: EMERG

2.18.3 Channel: 243

2.18.5 Hours of Operation:

2.18.1 Service Designation: GND METERING

2.18.3 Channel: 121.675

2.18.5 Hours of Operation: 24

2.18.1 Service Designation: GND/P (TWR SOUTH)

2.18.3 Channel: 118.05

2.18.5 Hours of Operation: 24

2.18.1 Service Designation: GND/P (TWR CENTER OUTBOUND)

2.18.3 Channel: 121.75

2.18.5 Hours of Operation: 24

2.18.1 Service Designation: GND/P (TWR CENTER INBOUND)

2.18.3 Channel: 121.9

2.18.5 Hours of Operation: 24

2.18.1 Service Designation: GND/P (TWR NORTH)

2.18.3 Channel: 124.125

2.18.5 Hours of Operation: 24

2.18.1 Service Designation: GND/P

2.18.3 Channel: 226.675

2.18.5 Hours of Operation: 24

2.18.1 Service Designation: GND/S (TWR CENTER)

2.18.3 Channel: 134.15

2.18.5 Hours of Operation: 24

2.18.1 Service Designation: LCL/P (RWY 04R/22L)

2.18.3 Channel: 120.75

2.18.5 Hours of Operation: 24

2.18.1 Service Designation: LCL/P (RWY 10C/28C)

2.18.3 Channel: 120.75

2.18.5 Hours of Operation: 24

2.18.1 Service Designation: LCL/P (RWY 09C/27C)

2.18.3 Channel: 121.15

2.18.5 Hours of Operation: 24

2.18.1 Service Designation: LCL/P (RWY 09R/27L)

2.18.3 Channel: 126.9

2.18.5 Hours of Operation: 24

2.18.1 Service Designation: LCL/P (RWY 22R)

2.18.3 Channel: 126.9

2.18.5 Hours of Operation: 24

2.18.1 Service Designation: LCL/P (RWY 09L/27R)

2.18.3 Channel: 128.15

2.18.5 Hours of Operation: 24

2.18.1 Service Designation: LCL/P (RWY 10L/28R)

2.18.3 Channel: 132.7

2.18.5 Hours of Operation: 24

2.18.1 Service Designation: LCL/P (RWY 10R/28L)

2.18.3 Channel: 133

2.18.5 Hours of Operation: 24

2.18.1 Service Designation: LCL/P

2.18.3 Channel: 348

2.18.5 Hours of Operation: 24

2.18.1 Service Designation: PRM (RWY 10C/28C)

2.18.3 Channel: 119.625

2.18.5 Hours of Operation: 24

2.18.1 Service Designation: PRM (RWY 10R/28L)

2.18.3 Channel: 128.05  
2.18.5 Hours of Operation: 24

2.18.1 Service Designation: VFR ADZY  
2.18.3 Channel: 126.8  
2.18.5 Hours of Operation:

**AD 2.19 Radio Navigation and Landing Aids**

2.19.1 ILS Type: Glide Slope for runway 22R. Magnetic variation: 3W  
2.19.2 ILS Identification: RXZ  
2.19.5 Coordinates: 41-59-46.5114N / 87-53-59.027W  
2.19.6 Site Elevation: 645.1 ft

2.19.1 ILS Type: Localizer for runway 22R. Magnetic variation: 3W  
2.19.2 ILS Identification: RXZ  
2.19.5 Coordinates: 41-58-47.729N / 87-54-56.987W  
2.19.6 Site Elevation: 656.5 ft

2.19.1 ILS Type: Glide Slope for runway 04R. Magnetic variation: 3W  
2.19.2 ILS Identification: FJU  
2.19.5 Coordinates: 41-57-16.8552N / 87-53-44.3489W  
2.19.6 Site Elevation: 654.1 ft

2.19.1 ILS Type: Localizer for runway 04R. Magnetic variation: 3W  
2.19.2 ILS Identification: FJU  
2.19.5 Coordinates: 41-58-16.1967N / 87-52-41.7631W  
2.19.6 Site Elevation: 646.6 ft

2.19.1 ILS Type: Glide Slope for runway 22L. Magnetic variation: 3W  
2.19.2 ILS Identification: LQQ  
2.19.5 Coordinates: 41-58-0.7989N / 87-52-52.6077W  
2.19.6 Site Elevation: 645.9 ft

2.19.1 ILS Type: Localizer for runway 22L. Magnetic variation: 3W  
2.19.2 ILS Identification: LQQ  
2.19.5 Coordinates: 41-57-5.6133N / 87-54-5.4506W  
2.19.6 Site Elevation: 653 ft

2.19.1 ILS Type: DME for runway 09C. Magnetic variation: 3W  
2.19.2 ILS Identification: OYG  
2.19.5 Coordinates: 41-59-22.1969N / 87-56-7.1574W  
2.19.6 Site Elevation: 688.1 ft

2.19.1 ILS Type: Glide Slope for runway 09C. Magnetic variation: 3W  
2.19.2 ILS Identification: OYG  
2.19.5 Coordinates: 41-59-21.8824N / 87-55-38.9074W  
2.19.6 Site Elevation: 667.2 ft

2.19.1 ILS Type: Inner Marker for runway 09C. Magnetic variation: 3W  
2.19.2 ILS Identification: OYG

2.19.5 Coordinates: 41-59-17.8812N / 87-56-5.0452W

2.19.6 Site Elevation: 680.4 ft

2.19.1 ILS Type: Localizer for runway 09C. Magnetic variation: 3W

2.19.2 ILS Identification: OYG

2.19.5 Coordinates: 41-59-17.9161N / 87-53-10.9443W

2.19.6 Site Elevation: 656.3 ft

2.19.1 ILS Type: DME for runway 27C. Magnetic variation: 3W

2.19.2 ILS Identification: UYJ

2.19.5 Coordinates: 41-59-22.1969N / 87-56-7.1574W

2.19.6 Site Elevation: 688.1 ft

2.19.1 ILS Type: Glide Slope for runway 27C. Magnetic variation: 3W

2.19.2 ILS Identification: UYJ

2.19.5 Coordinates: 41-59-21.9024N / 87-53-38.9227W

2.19.6 Site Elevation: 646.1 ft

2.19.1 ILS Type: Inner Marker for runway 27C. Magnetic variation: 3W

2.19.2 ILS Identification: UYJ

2.19.5 Coordinates: 41-59-17.9169N / 87-53-13.3671W

2.19.6 Site Elevation: 656.3 ft

2.19.1 ILS Type: Localizer for runway 27C. Magnetic variation: 3W

2.19.2 ILS Identification: UYJ

2.19.5 Coordinates: 41-59-17.8863N / 87-56-7.0691W

2.19.6 Site Elevation: 681.9 ft

2.19.1 ILS Type: DME for runway 09L. Magnetic variation: 3W

2.19.2 ILS Identification: SAJ

2.19.5 Coordinates: 42-0-14.0985N / 87-55-48.2323W

2.19.6 Site Elevation: 669.5 ft

2.19.1 ILS Type: Glide Slope for runway 09L. Magnetic variation: 3W

2.19.2 ILS Identification: SAJ

2.19.5 Coordinates: 42-0-14.2182N / 87-55-20.6714W

2.19.6 Site Elevation: 651.3 ft

2.19.1 ILS Type: Inner Marker for runway 09L. Magnetic variation: 3W

2.19.2 ILS Identification: SAJ

2.19.5 Coordinates: 42-0-10.1934N / 87-55-47.4231W

2.19.6 Site Elevation: 668.8 ft

2.19.1 ILS Type: Localizer for runway 09L. Magnetic variation: 3W

2.19.2 ILS Identification: SAJ

2.19.5 Coordinates: 42-0-10.1874N / 87-53-43.3254W

2.19.6 Site Elevation: 660.9 ft

2.19.1 ILS Type: DME for runway 27R. Magnetic variation: 3W

2.19.2 ILS Identification: ABU

2.19.5 Coordinates: 42-0-14.0985N / 87-55-48.2323W



2.19.6 Site Elevation: 669.5 ft

2.19.1 ILS Type: Glide Slope for runway 27R. Magnetic variation: 3W  
2.19.2 ILS Identification: ABU  
2.19.5 Coordinates: 42-0-14.2137N / 87-54-11.7412W  
2.19.6 Site Elevation: 648.4 ft

2.19.1 ILS Type: Inner Marker for runway 27R. Magnetic variation: 3W  
2.19.2 ILS Identification: ABU  
2.19.5 Coordinates: 42-0-9.9864N / 87-53-45.3008W  
2.19.6 Site Elevation: 663.1 ft

2.19.1 ILS Type: Localizer for runway 27R. Magnetic variation: 3W  
2.19.2 ILS Identification: ABU  
2.19.5 Coordinates: 42-0-10.1939N / 87-55-50.1994W  
2.19.6 Site Elevation: 668.1 ft

2.19.1 ILS Type: DME for runway 09R. Magnetic variation: 3W  
2.19.2 ILS Identification: JAV  
2.19.5 Coordinates: 41-58-57.74N / 87-53-13.65W  
2.19.6 Site Elevation: 673 ft

2.19.1 ILS Type: Glide Slope for runway 09R. Magnetic variation: 3W  
2.19.2 ILS Identification: JAV  
2.19.5 Coordinates: 41-59-6.96N / 87-55-38.39W  
2.19.6 Site Elevation: 661.9 ft

2.19.1 ILS Type: Inner Marker for runway 09R. Magnetic variation: 3W  
2.19.2 ILS Identification: JAV  
2.19.5 Coordinates: 41-59-2.01N / 87-56-4.01W  
2.19.6 Site Elevation: 669.1 ft

2.19.1 ILS Type: Localizer for runway 09R. Magnetic variation: 3W  
2.19.2 ILS Identification: JAV  
2.19.5 Coordinates: 41-59-2.04N / 87-53-10.79W  
2.19.6 Site Elevation: 642 ft

2.19.1 ILS Type: DME for runway 27L. Magnetic variation: 3W  
2.19.2 ILS Identification: IAC  
2.19.5 Coordinates: 41-58-57.74N / 87-53-13.65W  
2.19.6 Site Elevation: 673 ft

2.19.1 ILS Type: Glide Slope for runway 27L. Magnetic variation: 3W  
2.19.2 ILS Identification: IAC  
2.19.5 Coordinates: 41-59-6.98N / 87-53-38.67W  
2.19.6 Site Elevation: 647.3 ft

2.19.1 ILS Type: Inner Marker for runway 27L. Magnetic variation: 3W  
2.19.2 ILS Identification: IAC  
2.19.5 Coordinates: 41-59-2.04N / 87-53-13.53W  
2.19.6 Site Elevation: 645 ft

2.19.1 ILS Type: Localizer for runway 27L. Magnetic variation: 3W  
2.19.2 ILS Identification: IAC  
2.19.5 Coordinates: 41-59-2.01N / 87-56-7.22W  
2.19.6 Site Elevation: 673 ft

2.19.1 ILS Type: DME for runway 10C. Magnetic variation: 3W  
2.19.2 ILS Identification: SXH  
2.19.5 Coordinates: 41-58-0.9714N / 87-56-9.15W  
2.19.6 Site Elevation: 689.3 ft

2.19.1 ILS Type: Glide Slope for runway 10C. Magnetic variation: 3W  
2.19.2 ILS Identification: SXH  
2.19.5 Coordinates: 41-57-52.8465N / 87-55-39.0226W  
2.19.6 Site Elevation: 663 ft

2.19.1 ILS Type: Inner Marker for runway 10C. Magnetic variation: 3W  
2.19.2 ILS Identification: SXH  
2.19.5 Coordinates: 41-57-56.5015N / 87-56-4.8681W  
2.19.6 Site Elevation: 674.3 ft

2.19.1 ILS Type: Localizer for runway 10C. Magnetic variation: 3W  
2.19.2 ILS Identification: SXH  
2.19.5 Coordinates: 41-57-56.803N / 87-52-57.2925W  
2.19.6 Site Elevation: 646.3 ft

2.19.1 ILS Type: DME for runway 28C. Magnetic variation: 3W  
2.19.2 ILS Identification: VZE  
2.19.5 Coordinates: 41-58-0.9714N / 87-56-9.15W  
2.19.6 Site Elevation: 689.3 ft

2.19.1 ILS Type: Glide Slope for runway 28C. Magnetic variation: 3W  
2.19.2 ILS Identification: VZE  
2.19.5 Coordinates: 41-57-53.0321N / 87-53-44.3196W  
2.19.6 Site Elevation: 642.4 ft

2.19.1 ILS Type: Inner Marker for runway 28C. Magnetic variation: 3W  
2.19.2 ILS Identification: VZE  
2.19.5 Coordinates: 41-57-58.7451N / 87-53-19.1677W  
2.19.6 Site Elevation: 648 ft

2.19.1 ILS Type: Localizer for runway 28C. Magnetic variation: 3W  
2.19.2 ILS Identification: VZE  
2.19.5 Coordinates: 41-57-56.5013N / 87-56-6.8848W  
2.19.6 Site Elevation: 676.4 ft

2.19.1 ILS Type: DME for runway 10L. Magnetic variation: 3W  
2.19.2 ILS Identification: MED  
2.19.5 Coordinates: 41-58-5.6721N / 87-52-41.6845W  
2.19.6 Site Elevation: 656 ft

2.19.1 ILS Type: Glide Slope for runway 10L. Magnetic variation: 3W  
2.19.2 ILS Identification: MED  
2.19.5 Coordinates: 41-58-4.3877N / 87-55-38.7659W  
2.19.6 Site Elevation: 665.3 ft

2.19.1 ILS Type: Inner Marker for runway 10L. Magnetic variation: 3W  
2.19.2 ILS Identification: MED  
2.19.5 Coordinates: 41-58-8.5523N / 87-56-4.8866W  
2.19.6 Site Elevation: 676.8 ft

2.19.1 ILS Type: Localizer for runway 10L. Magnetic variation: 3W  
2.19.2 ILS Identification: MED  
2.19.5 Coordinates: 41-58-8.6818N / 87-52-39.6951W  
2.19.6 Site Elevation: 644.9 ft

2.19.1 ILS Type: DME for runway 28R. Magnetic variation: 3W  
2.19.2 ILS Identification: TSL  
2.19.5 Coordinates: 41-58-5.6721N / 87-52-41.6845W  
2.19.6 Site Elevation: 656 ft

2.19.1 ILS Type: Glide Slope for runway 28R. Magnetic variation: 3W  
2.19.2 ILS Identification: TSL  
2.19.5 Coordinates: 41-58-4.4701N / 87-53-15.0487W  
2.19.6 Site Elevation: 648.2 ft

2.19.1 ILS Type: Inner Marker for runway 28R. Magnetic variation: 3W  
2.19.2 ILS Identification: TSL  
2.19.5 Coordinates: 41-58-6.1128N / 87-52-49.1235W  
2.19.6 Site Elevation: 649.5 ft

2.19.1 ILS Type: Localizer for runway 28R. Magnetic variation: 3W  
2.19.2 ILS Identification: TSL  
2.19.5 Coordinates: 41-58-8.356N / 87-56-6.8801W  
2.19.6 Site Elevation: 679.1 ft

2.19.1 ILS Type: DME for runway 10R. Magnetic variation: 4W  
2.19.2 ILS Identification: BYW  
2.19.5 Coordinates: 41-57-28.3399N / 87-53-27.4609W  
2.19.6 Site Elevation: 669.6 ft

2.19.1 ILS Type: Glide Slope for runway 10R. Magnetic variation: 4W  
2.19.2 ILS Identification: BYW  
2.19.5 Coordinates: 41-57-21.909N / 87-55-25.5702W  
2.19.6 Site Elevation: 671.7 ft

2.19.1 ILS Type: Localizer for runway 10R. Magnetic variation: 4W  
2.19.2 ILS Identification: BYW  
2.19.5 Coordinates: 41-57-31.6045N / 87-53-26.3741W  
2.19.6 Site Elevation: 649.9 ft

2.19.1 ILS Type: DME for runway 28L. Magnetic variation: 4W

2.19.2 ILS Identification: VQX  
2.19.5 Coordinates: 41-57-22.2251N / 87-53-34.2417W  
2.19.6 Site Elevation: 656.1 ft

2.19.1 ILS Type: Glide Slope for runway 28L. Magnetic variation: 4W  
2.19.2 ILS Identification: VQX  
2.19.5 Coordinates: 41-57-22.0258N / 87-54-14.1801W  
2.19.6 Site Elevation: 654 ft

2.19.1 ILS Type: Inner Marker for runway 28L. Magnetic variation: 4W  
2.19.2 ILS Identification: VQX  
2.19.5 Coordinates: 41-57-26.9517N / 87-53-47.4584W  
2.19.6 Site Elevation: 650.4 ft

2.19.1 ILS Type: Localizer for runway 28L. Magnetic variation: 4W  
2.19.2 ILS Identification: VQX  
2.19.5 Coordinates: 41-57-25.8994N / 87-55-53.7065W  
2.19.6 Site Elevation: 680.2 ft

2.19.1 ILS Type: DME for runway 10X. Magnetic variation: 4W  
2.19.2 ILS Identification: IZJ  
2.19.5 Coordinates: 41-57-22.2251N / 87-53-34.2417W  
2.19.6 Site Elevation: 656.1 ft

2.19.1 ILS Type: Glide Slope for runway 10X. Magnetic variation: 4W  
2.19.2 ILS Identification: IZJ  
2.19.5 Coordinates: 41-57-22.1087N / 87-55-25.5572W  
2.19.6 Site Elevation: 671.8 ft

2.19.1 ILS Type: Inner Marker for runway 10X. Magnetic variation: 4W  
2.19.2 ILS Identification: IZJ  
2.19.5 Coordinates: 41-57-25.9088N / 87-55-51.6695W  
2.19.6 Site Elevation: 680 ft

2.19.1 ILS Type: Localizer for runway 10X. Magnetic variation: 4W  
2.19.2 ILS Identification: IZJ  
2.19.5 Coordinates: 41-57-26.1287N / 87-53-32.5409W  
2.19.6 Site Elevation: 652.2 ft

**General Remarks:**

A380-800 OPR CONSTRAINTS EXIST ON RWYS, TWYS, & RAMPS – CTC ARPT OPS FOR INFO 773-686-2255.

BIRDS ON & INVOF ARPT; PYROTECHNICS & BIRD CANNONS IN USE.

BE ALERT: THE NORTHEAST/SOUTHWEST PORTION OF TWY YY IS NOT VSBL FM THE CENTER ATCT.

RWY STATUS LGTS ARE IN OPN.

MAG DEVIATION PSBL IMT W OF TWY Y & RWY 22L APCH ON TWY N.

EAST AND WEST GATES ARE MANNED 24 HRS A DAY.

ACFT ARE NOT PMTD TO STOP ON EITHER TWY A OR B BRIDGES.

BE ALERT: TWY S1 OBND OR EB ONLY, TWY S2 INBD OR WB ONLY, TWY P1, P2, P3, P5, AND P6 NB ONLY, TWY E1, E2, E3 & E4 SB ONLY. TWY E3 WB ONLY FM RWY 09C/27C.

ALERT: DUPE ALPHA-NUMERIC TWY DESIGNATORS & TRML GATE DESIGNATIONS INVOLVING THE LTRS B, C, G, H, K, L & M.

SEE LND & HOLD SHORT OPS SECTION.

PAEW NEAR VARIOUS TWYS.

ACFT WITH WINGSPAN GREATER THAN 214 FT RQR 48 HRS PPR – 773-686-2255.

LINE UP AND WAIT AUTHORIZATION IN EFF BTWN SS AND SR AT THE FLWG INTS: RWY 28R AT TWY GG, TWY EE AND TWY N5; RWY 10L AT TWY DD AND TWY CC AND TWY SS; RWY 27C AT TWY TT; RWY 9C AT TWY FF; RWY 27L AT TWY TT; RWY 9R AT TWY SS AND FF. THESE RWYS WILL BE USED FOR DEPS ONLY WHEN EXERCISING THE PROVISIONS OF THIS AUTHORIZATION.

ATCT IS AUTH TO CONDUCT SIMUL DEPS FM RWY 04L/04R, RWY 22L/22R, RWY 09R WITH RWY 09L OR RWY 10L, RWY 09C WITH RWY 09L OR RWY 10L, RWY 10C WITH RWY 09R OR RWY 09C, RWY 27L WITH RWY 27R OR RWY 28R, RWY 27C WITH RWY 27R OR RWY 28R, RWY 28C WITH RWY 27L OR RWY 27C WITH CRS DIVERGENCE BEGINNING NO LATER THAN 4 MILES FM RWY END.

B747-8 OPS NOT AUTHORIZED ON RWY 09R/27L, 09L/27R & 10R/28L.

PERIODIC FIRE DEPT TRNG AT N SECTOR OF THE ARPT.

NOISE ABATEMENT PROC IN EFFECT FM 2200 TO 0700; CTC AMGR – 773-686-2255.

TWY NN1 INBD/EB ONLY; TWY NN2 OUBD/WB ONLY.

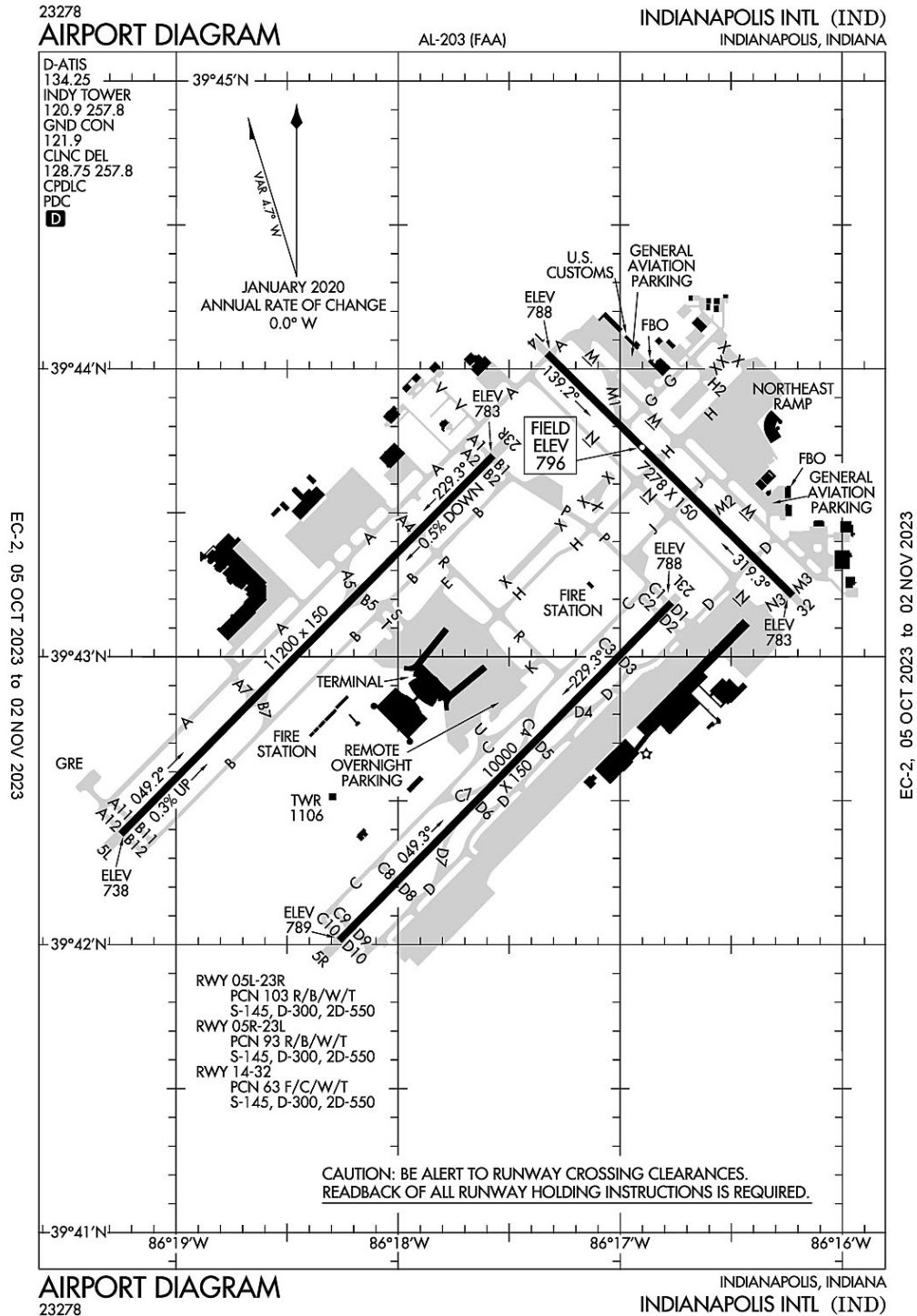
DVRSN ACRS WO A PRESENCE AT ORD SHOULD CTC ARPT OPNS 773-686-2255 PRIOR TO DIVERTING TO THE EXTENT PRACTICAL AND PRVD: CO, FLIGHT OPS CTC INFO, ACFT TYPE, PERSONS OB, INTL OR DOMESTIC, ANY GND HANDLER AGRMTS IN PLACE.

PRIM RUN-UP LOCATION GROUND RUN UP ENCLOSURE; SECONDARY RUN UP LOCATIONS AVBL UPON REQ – CTC CITY OPS 773-686-2255.

ALL PART 91 & UNSKED PART 125, 133 & 135 CHARTER OPERATORS CTC SIGNATURE FLIGHT SUPPORT AT 773-686-7000 REGARDING NEW SECURITY REGULATIONS PRIOR TO DEP.

ASDE-X IN USE. OPERATE TRANSPONDERS WITH ALTITUDE REPORTING MODE AND ADS-B (IF EQUIPPED) ENABLED ON ALL AIRPORT SURFACES.

### Indianapolis, Indiana Indianapolis International ICAO Identifier KIND



**Indianapolis, IN**  
**Indianapolis Intl**  
**ICAO Identifier KIND**

**AD 2.2 Aerodrome geographical and administrative data**

- 2.2.1 Reference Point: 39-43-2.3N / 86-17-40.7W
- 2.2.2 From City: 7 miles SW of INDIANAPOLIS, IN
- 2.2.3 Elevation: 796.2 ft
- 2.2.5 Magnetic Variation: 5W (2015)
- 2.2.6 Airport Contact: MARIO RODRIGUEZ  
7800 COL. H. WEIR COOK MEMORIAL DR.  
INDIANAPOLIS, IN 46241 (317-487-9594)
- 2.2.7 Traffic: IFR/VFR

**AD 2.3 Attendance Schedule**

- 2.3.1 All Months, All Days, All Hours

**AD 2.4 Handling Services and Facilities**

- 2.4.1 Cargo Handling Facilities: YES
- 2.4.2 Fuel Types: 100LL,A,A1+
- 2.4.5 Hangar Space:
- 2.4.6 Repair Facilities: MAJOR

**AD 2.6 Rescue and Firefighting Services**

- 2.6.1 Aerodrome Category: Class-I certified on 5/1/1973
- 2.6.2 Rescue and Firefighting Services: ARFF Index-D

**AD 2.12 Runway Physical Characteristics**

- 2.12.1 Designation: 05L
- 2.12.2 True Bearing: 45
- 2.12.3 Dimensions: 11200 ft x 150 ft
- 2.12.4 PCN: 103 R/B/W/T
- 2.12.5 Coordinates: 39-42-23.0337N / 86-19-14.9025W
- 2.12.6 Threshold Elevation: 738 ft
- 2.12.6 Touchdown Zone Elevation: 747.3 ft

- 2.12.1 Designation: 23R
- 2.12.2 True Bearing: 225
- 2.12.3 Dimensions: 11200 ft x 150 ft
- 2.12.4 PCN: 103 R/B/W/T
- 2.12.5 Coordinates: 39-43-41.9101N / 86-17-34.3591W
- 2.12.6 Threshold Elevation: 782.9 ft
- 2.12.6 Touchdown Zone Elevation: 782.9 ft

- 2.12.1 Designation: 05R
- 2.12.2 True Bearing: 45
- 2.12.3 Dimensions: 10000 ft x 150 ft
- 2.12.4 PCN: 93 R/B/W/T
- 2.12.5 Coordinates: 39-42-0.873N / 86-18-15.906W
- 2.12.6 Threshold Elevation: 788.8 ft
- 2.12.6 Touchdown Zone Elevation: 790.7 ft

2.12.1 Designation: 23L  
2.12.2 True Bearing: 225  
2.12.3 Dimensions: 10000 ft x 150 ft  
2.12.4 PCN: 93 R/B/W/T  
2.12.5 Coordinates: 39-43-11.2875N / 86-16-46.1248W  
2.12.6 Threshold Elevation: 787.6 ft  
2.12.6 Touchdown Zone Elevation: 790.1 ft

2.12.1 Designation: 14  
2.12.2 True Bearing: 135  
2.12.3 Dimensions: 7278 ft x 150 ft  
2.12.4 PCN: 63 F/C/W/T  
2.12.5 Coordinates: 39-44-3.2059N / 86-17-19.7638W  
2.12.6 Threshold Elevation: 787.5 ft  
2.12.6 Touchdown Zone Elevation: 796.2 ft

2.12.1 Designation: 32  
2.12.2 True Bearing: 315  
2.12.3 Dimensions: 7278 ft x 150 ft  
2.12.4 PCN: 63 F/C/W/T  
2.12.5 Coordinates: 39-43-12.7458N / 86-16-13.3895W  
2.12.6 Threshold Elevation: 782.6 ft  
2.12.6 Touchdown Zone Elevation: 792.9 ft

#### **AD 2.13 Declared Distances**

2.13.1 Designation: 05L  
2.13.2 Take-off Run Available: 11200  
2.13.3 Take-off Distance Available: 11200  
2.13.4 Accelerate-Stop Distance Available: 11200  
2.13.5 Landing Distance Available: 11200

2.13.1 Designation: 23R  
2.13.2 Take-off Run Available: 11200  
2.13.3 Take-off Distance Available: 11200  
2.13.4 Accelerate-Stop Distance Available: 11200  
2.13.5 Landing Distance Available: 11200

2.13.1 Designation: 05R  
2.13.2 Take-off Run Available: 10000  
2.13.3 Take-off Distance Available: 10000  
2.13.4 Accelerate-Stop Distance Available: 10000  
2.13.5 Landing Distance Available: 10000

2.13.1 Designation: 23L  
2.13.2 Take-off Run Available: 10000  
2.13.3 Take-off Distance Available: 10000  
2.13.4 Accelerate-Stop Distance Available: 10000  
2.13.5 Landing Distance Available: 10000



2.13.1 Designation: 14  
2.13.2 Take-off Run Available: 7278  
2.13.3 Take-off Distance Available: 7278  
2.13.4 Accelerate-Stop Distance Available: 7278  
2.13.5 Landing Distance Available: 7278

2.13.1 Designation: 32  
2.13.2 Take-off Run Available: 7278  
2.13.3 Take-off Distance Available: 7278  
2.13.4 Accelerate-Stop Distance Available: 7278  
2.13.5 Landing Distance Available: 7278

#### **AD 2.14 Approach and Runway Lighting**

2.14.1 Designation: 05L  
2.14.2 Approach Lighting System: ALSF2  
2.14.4 Visual Approach Slope Indicator System: P4L

2.14.1 Designation: 23R  
2.14.2 Approach Lighting System: MALSR  
2.14.4 Visual Approach Slope Indicator System: P4L

2.14.1 Designation: 05R  
2.14.2 Approach Lighting System: ALSF2  
2.14.4 Visual Approach Slope Indicator System: P4L

2.14.1 Designation: 23L  
2.14.2 Approach Lighting System: MALSR  
2.14.4 Visual Approach Slope Indicator System: P4L

2.14.1 Designation: 14  
2.14.2 Approach Lighting System: MALSR  
2.14.4 Visual Approach Slope Indicator System: P4L

2.14.1 Designation: 32  
2.14.2 Approach Lighting System: MALSR  
2.14.4 Visual Approach Slope Indicator System: P4R

#### **AD 2.18 Air Traffic Services Communication Facilities**

2.18.1 Service Designation: APCH/P (WEST OF ACTIVE RWY)  
2.18.3 Channel: 124.65  
2.18.5 Hours of Operation: 24

2.18.1 Service Designation: APCH/P (EAST OF ACTIVE RWY)  
2.18.3 Channel: 127.15  
2.18.5 Hours of Operation: 24

2.18.1 Service Designation: APCH/P DEP/P  
2.18.3 Channel: 317.8  
2.18.5 Hours of Operation: 24

2.18.1 Service Designation: APCH/P IC  
2.18.3 Channel: 128.175  
2.18.5 Hours of Operation: 24

2.18.1 Service Designation: CD PRE TAXI CLNC  
2.18.3 Channel: 128.75  
2.18.5 Hours of Operation: 24

2.18.1 Service Designation: CD/P  
2.18.3 Channel: 257.8  
2.18.5 Hours of Operation: 24

2.18.1 Service Designation: CLANG STAR  
2.18.3 Channel: 128.175  
2.18.5 Hours of Operation: 24

2.18.1 Service Designation: CLANG STAR  
2.18.3 Channel: 317.8  
2.18.5 Hours of Operation: 24

2.18.1 Service Designation: CLASS C (WEST OF ACTIVE RWY)  
2.18.3 Channel: 124.65  
2.18.5 Hours of Operation: 24

2.18.1 Service Designation: CLASS C (EAST)  
2.18.3 Channel: 124.95  
2.18.5 Hours of Operation: 24

2.18.1 Service Designation: CLASS C (EAST OF ACTIVE RWY)  
2.18.3 Channel: 127.15  
2.18.5 Hours of Operation: 24

2.18.1 Service Designation: CLASS C  
2.18.3 Channel: 317.8  
2.18.5 Hours of Operation: 24

2.18.1 Service Designation: D-ATIS  
2.18.3 Channel: 134.25  
2.18.5 Hours of Operation: 24

2.18.1 Service Designation: DEP/P (WEST)  
2.18.3 Channel: 119.05  
2.18.5 Hours of Operation: 24

2.18.1 Service Designation: DEP/P (EAST)  
2.18.3 Channel: 124.95  
2.18.5 Hours of Operation: 24

2.18.1 Service Designation: EMERG  
2.18.3 Channel: 121.5

2.18.5 Hours of Operation:

2.18.1 Service Designation: EMERG

2.18.3 Channel: 243

2.18.5 Hours of Operation:

2.18.1 Service Designation: GND/P

2.18.3 Channel: 121.9

2.18.5 Hours of Operation: 24

2.18.1 Service Designation: GND/S

2.18.3 Channel: 121.8

2.18.5 Hours of Operation: 24

2.18.1 Service Designation: LCL/P

2.18.3 Channel: 120.9

2.18.5 Hours of Operation: 24

2.18.1 Service Designation: LCL/P

2.18.3 Channel: 257.8

2.18.5 Hours of Operation: 24

2.18.1 Service Designation: RACYR STAR

2.18.3 Channel: 128.175

2.18.5 Hours of Operation: 24

2.18.1 Service Designation: RACYR STAR

2.18.3 Channel: 317.8

2.18.5 Hours of Operation: 24

### **AD 2.19 Radio Navigation and Landing Aids**

2.19.1 ILS Type: DME for runway 05L. Magnetic variation: 5W

2.19.2 ILS Identification: IND

2.19.5 Coordinates: 39-43-51.3513N / 86-17-27.5671W

2.19.6 Site Elevation: 797.6 ft

2.19.1 ILS Type: Glide Slope for runway 05L. Magnetic variation: 5W

2.19.2 ILS Identification: IND

2.19.5 Coordinates: 39-42-32.7741N / 86-19-9.6768W

2.19.6 Site Elevation: 735.4 ft

2.19.1 ILS Type: Inner Marker for runway 05L. Magnetic variation: 5W

2.19.2 ILS Identification: IND

2.19.5 Coordinates: 39-42-15.7098N / 86-19-24.4367W

2.19.6 Site Elevation: 735.9 ft

2.19.1 ILS Type: Localizer for runway 05L. Magnetic variation: 5W

2.19.2 ILS Identification: IND

2.19.5 Coordinates: 39-43-49.0283N / 86-17-25.2797W

2.19.6 Site Elevation: 787.8 ft

2.19.1 ILS Type: DME for runway 23R. Magnetic variation: 5W  
2.19.2 ILS Identification: UZK  
2.19.5 Coordinates: 39-43-51.3513N / 86-17-27.5671W  
2.19.6 Site Elevation: 797.6 ft

2.19.1 ILS Type: Glide Slope for runway 23R. Magnetic variation: 5W  
2.19.2 ILS Identification: UZK  
2.19.5 Coordinates: 39-43-36.5113N / 86-17-48.4342W  
2.19.6 Site Elevation: 772.4 ft

2.19.1 ILS Type: Localizer for runway 23R. Magnetic variation: 5W  
2.19.2 ILS Identification: UZK  
2.19.5 Coordinates: 39-42-15.9186N / 86-19-23.9666W  
2.19.6 Site Elevation: 736.6 ft

2.19.1 ILS Type: DME for runway 05R. Magnetic variation: 5W  
2.19.2 ILS Identification: OQV  
2.19.5 Coordinates: 39-43-20.1868N / 86-16-39.5353W  
2.19.6 Site Elevation: 802 ft

2.19.1 ILS Type: Glide Slope for runway 05R. Magnetic variation: 5W  
2.19.2 ILS Identification: OQV  
2.19.5 Coordinates: 39-42-5.3627N / 86-18-2.9983W  
2.19.6 Site Elevation: 788.5 ft

2.19.1 ILS Type: Inner Marker for runway 05R. Magnetic variation: 5W  
2.19.2 ILS Identification: OQV  
2.19.5 Coordinates: 39-41-52.07N / 86-18-27.12W  
2.19.6 Site Elevation: 784.4 ft

2.19.1 ILS Type: Localizer for runway 05R. Magnetic variation: 5W  
2.19.2 ILS Identification: OQV  
2.19.5 Coordinates: 39-43-18.3778N / 86-16-37.0825W  
2.19.6 Site Elevation: 785.5 ft

2.19.1 ILS Type: DME for runway 23L. Magnetic variation: 5W  
2.19.2 ILS Identification: FVJ  
2.19.5 Coordinates: 39-43-20.1868N / 86-16-39.5353W  
2.19.6 Site Elevation: 802 ft

2.19.1 ILS Type: Glide Slope for runway 23L. Magnetic variation: 5W  
2.19.2 ILS Identification: FVJ  
2.19.5 Coordinates: 39-43-2.4585N / 86-16-54.2858W  
2.19.6 Site Elevation: 785 ft

2.19.1 ILS Type: Localizer for runway 23L. Magnetic variation: 5W  
2.19.2 ILS Identification: FVJ  
2.19.5 Coordinates: 39-41-53.5322N / 86-18-25.2565W  
2.19.6 Site Elevation: 777.3 ft

2.19.1 ILS Type: Glide Slope for runway 14. Magnetic variation: 5W  
2.19.2 ILS Identification: BJP  
2.19.5 Coordinates: 39-43-59.3065N / 86-17-7.3342W  
2.19.6 Site Elevation: 790 ft

2.19.1 ILS Type: Localizer for runway 14. Magnetic variation: 5W  
2.19.2 ILS Identification: BJP  
2.19.5 Coordinates: 39-43-5.64N / 86-16-4.06W  
2.19.6 Site Elevation: 768.5 ft

2.19.1 ILS Type: Glide Slope for runway 32. Magnetic variation: 5W  
2.19.2 ILS Identification: COA  
2.19.5 Coordinates: 39-43-16.2751N / 86-16-25.5096W  
2.19.6 Site Elevation: 781.7 ft

2.19.1 ILS Type: Localizer for runway 32. Magnetic variation: 5W  
2.19.2 ILS Identification: COA  
2.19.5 Coordinates: 39-44-10.3487N / 86-17-29.1696W  
2.19.6 Site Elevation: 782.3 ft

**General Remarks:**

TWY V IS NOT AVBL FOR ACR OPS.

TWY H RUNS CONTIGUOUS AT NORTHEAST RAMP.

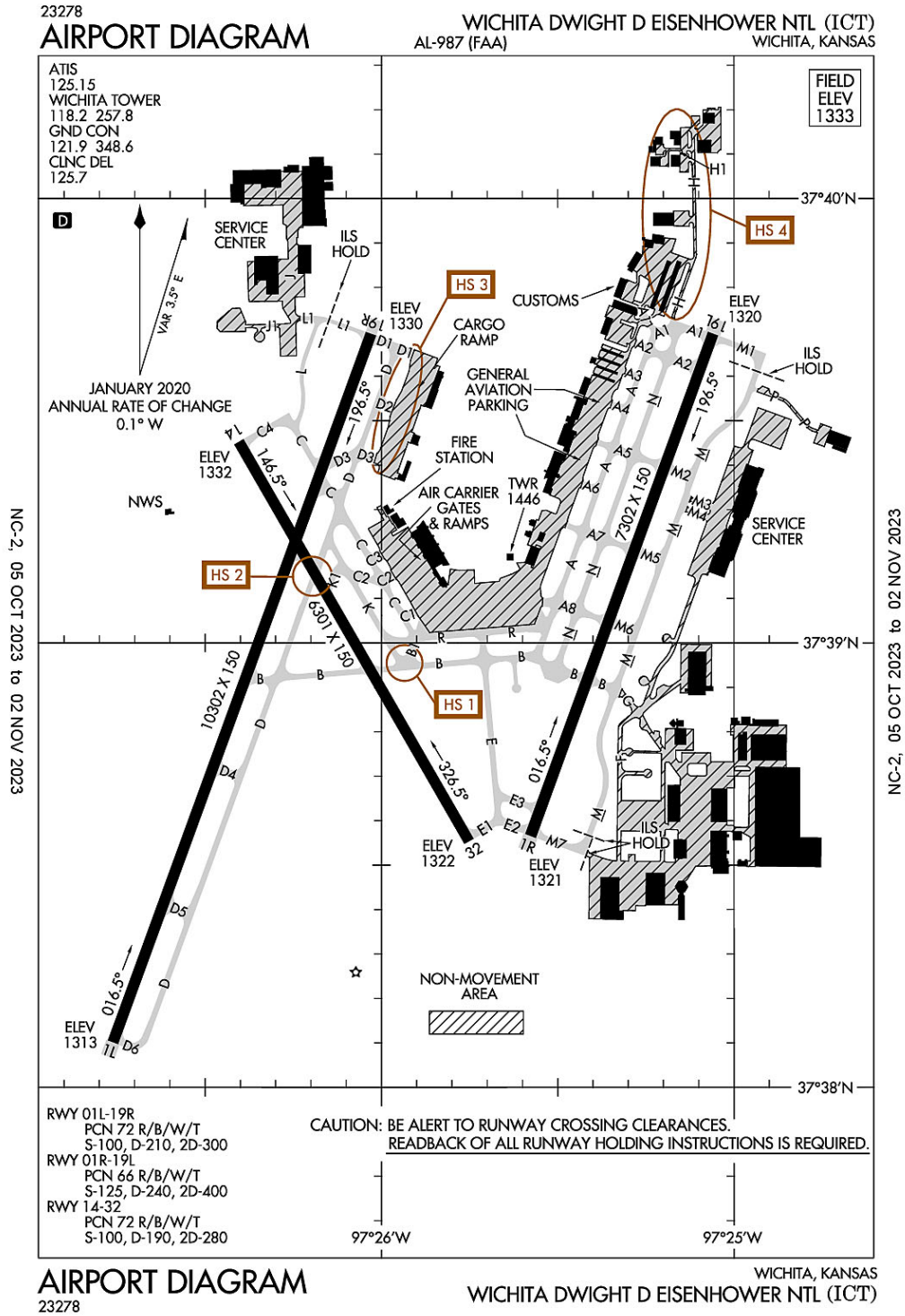
LARGE FLOCKS OF BIRDS ON & INVOF ARPT.

NOISE ABATEMENT PROCEDURES IN EFFECT CTC ARPT MGR.

PRIM STUDENT TGL NOT PMTD.

BE ALERT TO CLOSE PROXIMITY OF RWY 14/32 TO NORTHEAST RAMP.

**Wichita, Kansas**  
**Wichita Mid-Continent**  
**ICAO Identifier KICT**



**Wichita, KS**  
**Wichita Mid-Continent**  
**ICAO Identifier KICT**

**AD 2.2 Aerodrome geographical and administrative data**

- 2.2.1 Reference Point: 37-38-59.829N / 97-25-58.954W
- 2.2.2 From City: 5 miles SW of WICHITA, KS
- 2.2.3 Elevation: 1332.6 ft
- 2.2.5 Magnetic Variation: 4E (2015)
- 2.2.6 Airport Contact: MR. JESSE ROMO, A.A.E.  
2173 AIR CARGO ROAD  
WICHITA, KS 67209 (316-946-4700)
- 2.2.7 Traffic: IFR/VFR

**AD 2.3 Attendance Schedule**

- 2.3.1 All Months, All Days, All Hours

**AD 2.4 Handling Services and Facilities**

- 2.4.1 Cargo Handling Facilities: YES
- 2.4.2 Fuel Types: 100LL,A
- 2.4.5 Hangar Space: YES
- 2.4.6 Repair Facilities: MAJOR

**AD 2.6 Rescue and Firefighting Services**

- 2.6.1 Aerodrome Category: Class-I certified on 5/1/1973
- 2.6.2 Rescue and Firefighting Services: ARFF Index-C

**AD 2.12 Runway Physical Characteristics**

- 2.12.1 Designation: 01L
- 2.12.2 True Bearing: 20
- 2.12.3 Dimensions: 10302 ft x 150 ft
- 2.12.4 PCN: 72 R/B/W/T
- 2.12.5 Coordinates: 37-38-6.0645N / 97-26-45.5906W
- 2.12.6 Threshold Elevation: 1312.5 ft
- 2.12.6 Touchdown Zone Elevation: 1314.1 ft

- 2.12.1 Designation: 19R
- 2.12.2 True Bearing: 200
- 2.12.3 Dimensions: 10302 ft x 150 ft
- 2.12.4 PCN: 72 R/B/W/T
- 2.12.5 Coordinates: 37-39-41.7663N / 97-26-1.7916W
- 2.12.6 Threshold Elevation: 1329.6 ft
- 2.12.6 Touchdown Zone Elevation: 1329.7 ft

- 2.12.1 Designation: 19L
- 2.12.2 True Bearing: 200
- 2.12.3 Dimensions: 7302 ft x 150 ft
- 2.12.4 PCN: 66 R/B/W/T
- 2.12.5 Coordinates: 37-39-41.7709N / 97-25-3.5648W
- 2.12.6 Threshold Elevation: 1319.8 ft
- 2.12.6 Touchdown Zone Elevation: 1320.1 ft

2.12.1 Designation: 01R  
2.12.2 True Bearing: 20  
2.12.3 Dimensions: 7302 ft x 150 ft  
2.12.4 PCN: 66 R/B/W/T  
2.12.5 Coordinates: 37-38-33.9441N / 97-25-34.6296W  
2.12.6 Threshold Elevation: 1321 ft  
2.12.6 Touchdown Zone Elevation: 1321.1 ft

2.12.1 Designation: 32  
2.12.2 True Bearing: 330  
2.12.3 Dimensions: 6301 ft x 150 ft  
2.12.4 PCN: 72 R/B/W/T  
2.12.5 Coordinates: 37-38-33.2136N / 97-25-45.1001W  
2.12.6 Threshold Elevation: 1321.6 ft  
2.12.6 Touchdown Zone Elevation: 1321.8 ft

2.12.1 Designation: 14  
2.12.2 True Bearing: 150  
2.12.3 Dimensions: 6301 ft x 150 ft  
2.12.4 PCN: 72 R/B/W/T  
2.12.5 Coordinates: 37-39-27.162N / 97-26-24.273W  
2.12.6 Threshold Elevation: 1332.1 ft  
2.12.6 Touchdown Zone Elevation: 1332.6 ft

**AD 2.13 Declared Distances**

2.13.1 Designation: 01L  
2.13.2 Take-off Run Available: 10301  
2.13.3 Take-off Distance Available: 10301  
2.13.4 Accelerate-Stop Distance Available: 10301  
2.13.5 Landing Distance Available: 10301

2.13.1 Designation: 19R  
2.13.2 Take-off Run Available: 10301  
2.13.3 Take-off Distance Available: 10301  
2.13.4 Accelerate-Stop Distance Available: 10301  
2.13.5 Landing Distance Available: 10301

2.13.1 Designation: 19L  
2.13.2 Take-off Run Available: 7302  
2.13.3 Take-off Distance Available: 7302  
2.13.4 Accelerate-Stop Distance Available: 7302  
2.13.5 Landing Distance Available: 7302

2.13.1 Designation: 01R  
2.13.2 Take-off Run Available: 7302  
2.13.3 Take-off Distance Available: 7302  
2.13.4 Accelerate-Stop Distance Available: 7302  
2.13.5 Landing Distance Available: 7302



2.13.1 Designation: 32  
2.13.2 Take-off Run Available: 6301  
2.13.3 Take-off Distance Available: 6301  
2.13.4 Accelerate-Stop Distance Available: 6301  
2.13.5 Landing Distance Available: 6301

2.13.1 Designation: 14  
2.13.2 Take-off Run Available: 6301  
2.13.3 Take-off Distance Available: 6301  
2.13.4 Accelerate-Stop Distance Available: 6301  
2.13.5 Landing Distance Available: 6301

#### **AD 2.14 Approach and Runway Lighting**

2.14.1 Designation: 01L  
2.14.2 Approach Lighting System: ALSF2  
2.14.4 Visual Approach Slope Indicator System:

2.14.1 Designation: 19R  
2.14.2 Approach Lighting System: MALSR  
2.14.4 Visual Approach Slope Indicator System:

2.14.1 Designation: 19L  
2.14.2 Approach Lighting System: MALSR  
2.14.4 Visual Approach Slope Indicator System: P4L

2.14.1 Designation: 01R  
2.14.2 Approach Lighting System: MALSR  
2.14.4 Visual Approach Slope Indicator System:

2.14.1 Designation: 32  
2.14.2 Approach Lighting System:  
2.14.4 Visual Approach Slope Indicator System: P4L

2.14.1 Designation: 14  
2.14.2 Approach Lighting System:  
2.14.4 Visual Approach Slope Indicator System: P4L

#### **AD 2.18 Air Traffic Services Communication Facilities**

2.18.1 Service Designation: APCH/P (270-009 BLW 5000 FT & BYD 20 NM)  
2.18.3 Channel: 125.5  
2.18.5 Hours of Operation: 24

2.18.1 Service Designation: APCH/P (E IAB BLW 5000 FT)  
2.18.3 Channel: 269.1  
2.18.5 Hours of Operation: 24

2.18.1 Service Designation: APCH/P (270-009 BLW 5000 FT & BYD 20 NM)  
2.18.3 Channel: 325.8  
2.18.5 Hours of Operation: 24

2.18.1 Service Designation: APCH/P DEP/P (010-190)  
2.18.3 Channel: 134.85  
2.18.5 Hours of Operation: 24

2.18.1 Service Designation: APCH/P DEP/P (010-190)  
2.18.3 Channel: 290.275  
2.18.5 Hours of Operation: 24

2.18.1 Service Designation: APCH/P DEP/P IC (191-009)  
2.18.3 Channel: 126.7  
2.18.5 Hours of Operation: 24

2.18.1 Service Designation: APCH/P DEP/P IC (191-009)  
2.18.3 Channel: 353.5  
2.18.5 Hours of Operation: 24

2.18.1 Service Designation: APCH/S DEP/S  
2.18.3 Channel: 327.1  
2.18.5 Hours of Operation: 24

2.18.1 Service Designation: ATIS  
2.18.3 Channel: 125.15  
2.18.5 Hours of Operation: 24

2.18.1 Service Designation: CD/P  
2.18.3 Channel: 125.7  
2.18.5 Hours of Operation: 24

2.18.1 Service Designation: CLASS C (191-009)  
2.18.3 Channel: 126.7  
2.18.5 Hours of Operation: 24

2.18.1 Service Designation: CLASS C (010-190 4000 FT & BLW)  
2.18.3 Channel: 134.8  
2.18.5 Hours of Operation: 24

2.18.1 Service Designation: CLASS C (010-190 ABV 4000 FT)  
2.18.3 Channel: 134.85  
2.18.5 Hours of Operation: 24

2.18.1 Service Designation: CLASS C (010-190 ABV 4000 FT)  
2.18.3 Channel: 290.275  
2.18.5 Hours of Operation: 24

2.18.1 Service Designation: CLASS C (191-009)  
2.18.3 Channel: 353.5  
2.18.5 Hours of Operation: 24

2.18.1 Service Designation: EMERG  
2.18.3 Channel: 121.5

2.18.5 Hours of Operation:

2.18.1 Service Designation: EMERG

2.18.3 Channel: 243

2.18.5 Hours of Operation:

2.18.1 Service Designation: GND/P

2.18.3 Channel: 121.9

2.18.5 Hours of Operation: 24

2.18.1 Service Designation: GND/P

2.18.3 Channel: 348.6

2.18.5 Hours of Operation: 24

2.18.1 Service Designation: LCL/P

2.18.3 Channel: 118.2

2.18.5 Hours of Operation: 24

2.18.1 Service Designation: LCL/P

2.18.3 Channel: 257.8

2.18.5 Hours of Operation: 24

#### **AD 2.19 Radio Navigation and Landing Aids**

2.19.1 ILS Type: Glide Slope for runway 01L. Magnetic variation: 4E

2.19.2 ILS Identification: TWI

2.19.5 Coordinates: 37-38-16.7093N / 97-26-46.0091W

2.19.6 Site Elevation: 1310.5 ft

2.19.1 ILS Type: Inner Marker for runway 01L. Magnetic variation: 4E

2.19.2 ILS Identification: TWI

2.19.5 Coordinates: 37-37-57.139N / 97-26-49.6801W

2.19.6 Site Elevation: 1317.9 ft

2.19.1 ILS Type: Localizer for runway 01L. Magnetic variation: 4E

2.19.2 ILS Identification: TWI

2.19.5 Coordinates: 37-39-51.3411N / 97-25-57.406W

2.19.6 Site Elevation: 1319.7 ft

2.19.1 ILS Type: Outer Marker for runway 01L. Magnetic variation: 4E

2.19.2 ILS Identification: TWI

2.19.5 Coordinates: 37-33-33.9381N / 97-28-51.7772W

2.19.6 Site Elevation: 1311.2 ft

2.19.1 ILS Type: Glide Slope for runway 19R. Magnetic variation: 4E

2.19.2 ILS Identification: HOV

2.19.5 Coordinates: 37-39-33.8636N / 97-26-10.8356W

2.19.6 Site Elevation: 1327.4 ft

2.19.1 ILS Type: Localizer for runway 19R. Magnetic variation: 4E

2.19.2 ILS Identification: HOV

2.19.5 Coordinates: 37-37-54.7075N / 97-26-50.7862W

2.19.6 Site Elevation: 1320.8 ft

2.19.1 ILS Type: Outer Marker for runway 19R. Magnetic variation: 4E

2.19.2 ILS Identification: HOV

2.19.5 Coordinates: 37-44-16.6003N / 97-24-0.9982W

2.19.6 Site Elevation: 1325.3 ft

2.19.1 ILS Type: DME for runway 01R. Magnetic variation: 4E

2.19.2 ILS Identification: ICT

2.19.5 Coordinates: 37-39-52.0431N / 97-25-2.8236W

2.19.6 Site Elevation: 1327.1 ft

2.19.1 ILS Type: Glide Slope for runway 01R. Magnetic variation: 4E

2.19.2 ILS Identification: ICT

2.19.5 Coordinates: 37-38-42.6366N / 97-25-24.6949W

2.19.6 Site Elevation: 1314.7 ft

2.19.1 ILS Type: Localizer for runway 01R. Magnetic variation: 4E

2.19.2 ILS Identification: ICT

2.19.5 Coordinates: 37-39-52.0134N / 97-24-58.8717W

2.19.6 Site Elevation: 1309.6 ft

2.19.1 ILS Type: Outer Marker for runway 01R. Magnetic variation: 4E

2.19.2 ILS Identification: ICT

2.19.5 Coordinates: 37-34-41.4784N / 97-27-21.1454W

2.19.6 Site Elevation: 1315.2 ft

2.19.1 ILS Type: DME for runway 19L. Magnetic variation: 4E

2.19.2 ILS Identification: MVP

2.19.5 Coordinates: 37-38-21.5439N / 97-25-43.3444W

2.19.6 Site Elevation: 1320 ft

2.19.1 ILS Type: Glide Slope for runway 19L. Magnetic variation: 4E

2.19.2 ILS Identification: MVP

2.19.5 Coordinates: 37-39-30.7714N / 97-25-3.1731W

2.19.6 Site Elevation: 1313.6 ft

2.19.1 ILS Type: Localizer for runway 19L. Magnetic variation: 4E

2.19.2 ILS Identification: MVP

2.19.5 Coordinates: 37-38-21.2844N / 97-25-40.4224W

2.19.6 Site Elevation: 1319.3 ft

2.19.1 Navigation Aid Type: VORTAC. Magnetic variation: 7E

2.19.2 Navigation Aid Identification: ICT

2.19.5 Coordinates: 37-44-42.9259N / 97-35-1.782W

2.19.6 Site Elevation: 1472 ft

**General Remarks:**

TWY L AND L1 CLSD TO ACFT WITH WINGSPAN MORE THAN 118.

AIR CARGO RAMP CLSD TO ACFT WINGSPAN MORE THAN 148 FT.

AIRCRAFT ENGINE RUNS ABOVE IDLE NOT APPROVED ON AIRCRAFT PARKING RAMPS.

PPR REQUIRED FOR ACFT CARRYING CLASS 1 DIVISION 1.1, 1.2 OR 1.3 EXPLOSIVES AS DEFINED BY 49 CFR 173.50 OR AS AMENDED.

ACFT PARKING BAS CONTACT 132.00 FOR PARKING INSTRUCTIONS PRIOR TO EXITING TWY L1.

TWYS F, G, H, J, P AND ALL ACFT PARKING RAMPS ARE NONMOVEMENT AREAS.

ATCT HAS LTD VIS OF TRML GATES 1 THRU 8, TWY H, AND CUSTOMS PRKG RAMP.

ATTENDED CONTINUOUSLY.

CALL FOR GATE PUSHBACK NOT REQUIRED.

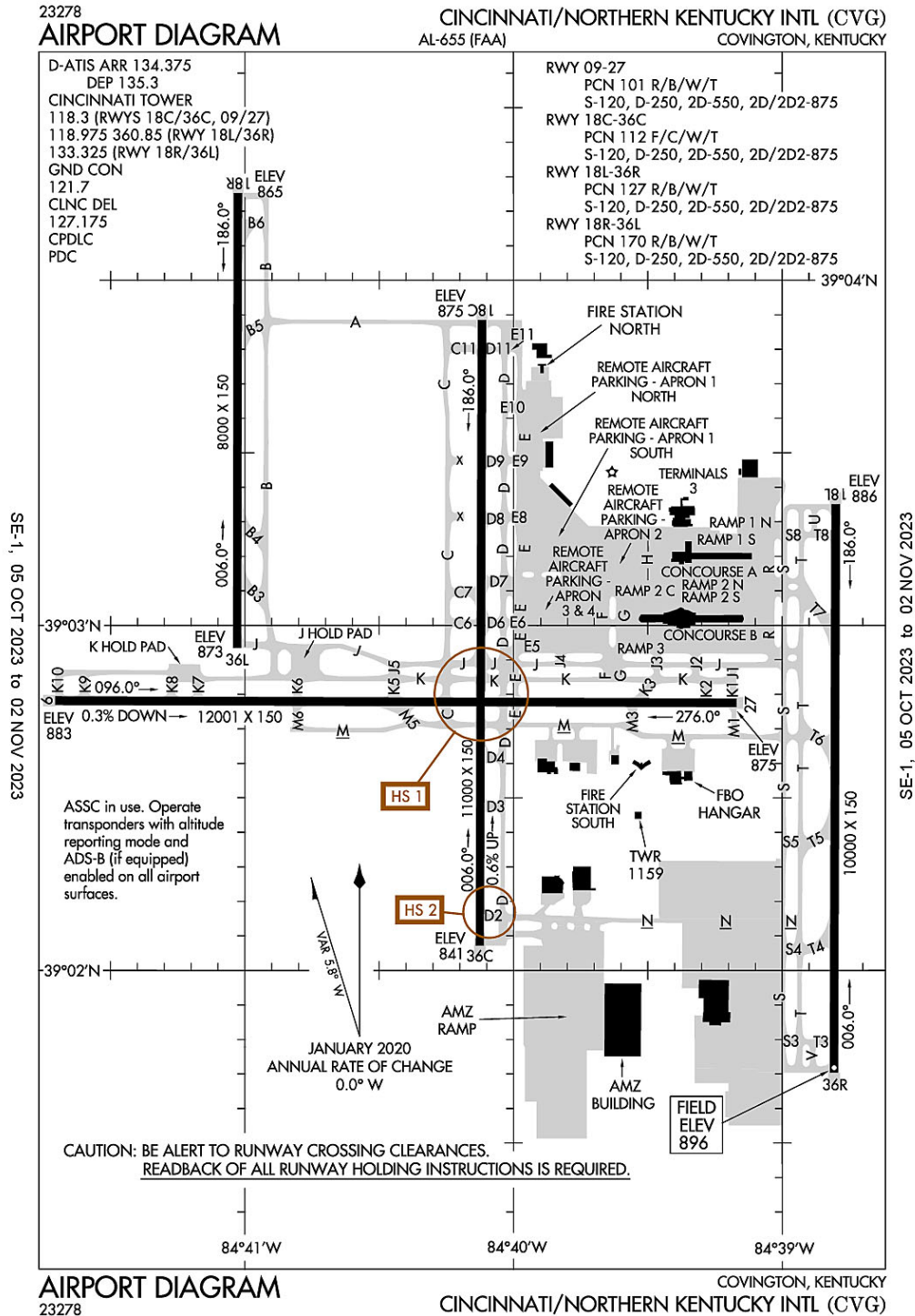
TWY P CLSD TO ACFT WITH WINGSPAN MORE THAN 79.

TWY H CLSD TO ACFT WITH WINGSPAN MORE THAN 79.

MIGRATORY BIRDS ON AND IN VICINITY OF ARPT, ALL QUADS.

FLIGHT NOTIFICATION SERVICE (ADCUS) AVBL.

### Covington, Kentucky Cincinnati/Northern Kentucky International ICAO Identifier KCVG



**Covington, KY**  
**Cincinnati/Northern Kentucky Intl**  
**ICAO Identifier KCVG**

**AD 2.2 Aerodrome geographical and administrative data**

- 2.2.1 Reference Point: 39-2-55.815N / 84-40-4.155W
- 2.2.2 From City: 8 miles SW of COVINGTON, KY
- 2.2.3 Elevation: 896.1 ft
- 2.2.5 Magnetic Variation: 6W (2025)
- 2.2.6 Airport Contact: CANDACE MCGRAW  
PO BOX 752000  
CINCINNATI, OH 45275 (859-767-3151)
- 2.2.7 Traffic: IFR/VFR

**AD 2.3 Attendance Schedule**

- 2.3.1 All Months, All Days, All Hours

**AD 2.4 Handling Services and Facilities**

- 2.4.1 Cargo Handling Facilities: YES
- 2.4.2 Fuel Types: 100LL,A
- 2.4.5 Hangar Space: YES
- 2.4.6 Repair Facilities: MAJOR

**AD 2.6 Rescue and Firefighting Services**

- 2.6.1 Aerodrome Category: Class-I certified on 5/1/1973
- 2.6.2 Rescue and Firefighting Services: ARFF Index-C

**AD 2.12 Runway Physical Characteristics**

- 2.12.1 Designation: 09
- 2.12.2 True Bearing: 90
- 2.12.3 Dimensions: 12001 ft x 150 ft
- 2.12.4 PCN: 101 R/B/W/T
- 2.12.5 Coordinates: 39-2-46.9049N / 84-41-42.3528W
- 2.12.6 Threshold Elevation: 883.1 ft
- 2.12.6 Touchdown Zone Elevation: 883.2 ft

- 2.12.1 Designation: 27
- 2.12.2 True Bearing: 270
- 2.12.3 Dimensions: 12001 ft x 150 ft
- 2.12.4 PCN: 101 R/B/W/T
- 2.12.5 Coordinates: 39-2-46.5417N / 84-39-10.2436W
- 2.12.6 Threshold Elevation: 874.8 ft
- 2.12.6 Touchdown Zone Elevation: 874.8 ft

- 2.12.1 Designation: 36C
- 2.12.2 True Bearing: 0
- 2.12.3 Dimensions: 11000 ft x 150 ft
- 2.12.4 PCN: 112 F/C/W/T
- 2.12.5 Coordinates: 39-2-4.3552N / 84-40-7.4709W
- 2.12.6 Threshold Elevation: 840.7 ft
- 2.12.6 Touchdown Zone Elevation: 850.3 ft

2.12.1 Designation: 18C  
2.12.2 True Bearing: 180  
2.12.3 Dimensions: 11000 ft x 150 ft  
2.12.4 PCN: 112 F/C/W/T  
2.12.5 Coordinates: 39-3-53.0734N / 84-40-7.0233W  
2.12.6 Threshold Elevation: 874.6 ft  
2.12.6 Touchdown Zone Elevation: 874.6 ft

2.12.1 Designation: 18L  
2.12.2 True Bearing: 180  
2.12.3 Dimensions: 10000 ft x 150 ft  
2.12.4 PCN: 127 R/B/W/T  
2.12.5 Coordinates: 39-3-21.0781N / 84-38-48.0048W  
2.12.6 Threshold Elevation: 886.3 ft  
2.12.6 Touchdown Zone Elevation: 889.1 ft

2.12.1 Designation: 36R  
2.12.2 True Bearing: 0  
2.12.3 Dimensions: 10000 ft x 150 ft  
2.12.4 PCN: 127 R/B/W/T  
2.12.5 Coordinates: 39-1-42.2406N / 84-38-48.4562W  
2.12.6 Threshold Elevation: 896.1 ft  
2.12.6 Touchdown Zone Elevation: 896.1 ft

2.12.1 Designation: 36L  
2.12.2 True Bearing: 0  
2.12.3 Dimensions: 8000 ft x 150 ft  
2.12.4 PCN: 170 R/B/W/T  
2.12.5 Coordinates: 39-2-56.1037N / 84-41-1.7608W  
2.12.6 Threshold Elevation: 872.6 ft  
2.12.6 Touchdown Zone Elevation: 872.7 ft

2.12.1 Designation: 18R  
2.12.2 True Bearing: 180  
2.12.3 Dimensions: 8000 ft x 150 ft  
2.12.4 PCN: 170 R/B/W/T  
2.12.5 Coordinates: 39-4-15.1736N / 84-41-1.4552W  
2.12.6 Threshold Elevation: 864.7 ft  
2.12.6 Touchdown Zone Elevation: 867.8 ft

#### **AD 2.13 Declared Distances**

2.13.1 Designation: 09  
2.13.2 Take-off Run Available:  
2.13.3 Take-off Distance Available:  
2.13.4 Accelerate-Stop Distance Available:  
2.13.5 Landing Distance Available:

2.13.1 Designation: 27  
2.13.2 Take-off Run Available:



2.13.3 Take-off Distance Available:  
2.13.4 Accelerate-Stop Distance Available:  
2.13.5 Landing Distance Available:

2.13.1 Designation: 36C  
2.13.2 Take-off Run Available:  
2.13.3 Take-off Distance Available:  
2.13.4 Accelerate-Stop Distance Available:  
2.13.5 Landing Distance Available:

2.13.1 Designation: 18C  
2.13.2 Take-off Run Available:  
2.13.3 Take-off Distance Available:  
2.13.4 Accelerate-Stop Distance Available:  
2.13.5 Landing Distance Available:

2.13.1 Designation: 18L  
2.13.2 Take-off Run Available:  
2.13.3 Take-off Distance Available:  
2.13.4 Accelerate-Stop Distance Available:  
2.13.5 Landing Distance Available:

2.13.1 Designation: 36R  
2.13.2 Take-off Run Available:  
2.13.3 Take-off Distance Available:  
2.13.4 Accelerate-Stop Distance Available:  
2.13.5 Landing Distance Available:

2.13.1 Designation: 36L  
2.13.2 Take-off Run Available:  
2.13.3 Take-off Distance Available:  
2.13.4 Accelerate-Stop Distance Available:  
2.13.5 Landing Distance Available:

2.13.1 Designation: 18R  
2.13.2 Take-off Run Available:  
2.13.3 Take-off Distance Available:  
2.13.4 Accelerate-Stop Distance Available:  
2.13.5 Landing Distance Available:

**AD 2.14 Approach and Runway Lighting**

2.14.1 Designation: 09  
2.14.2 Approach Lighting System: MALSR  
2.14.4 Visual Approach Slope Indicator System: P4L

2.14.1 Designation: 27  
2.14.2 Approach Lighting System: MALSR  
2.14.4 Visual Approach Slope Indicator System: P4L

2.14.1 Designation: 36C

2.14.2 Approach Lighting System: ALSF2  
2.14.4 Visual Approach Slope Indicator System: P4L

2.14.1 Designation: 18C  
2.14.2 Approach Lighting System: MALSR  
2.14.4 Visual Approach Slope Indicator System: P4R

2.14.1 Designation: 18L  
2.14.2 Approach Lighting System: MALSR  
2.14.4 Visual Approach Slope Indicator System: P4L

2.14.1 Designation: 36R  
2.14.2 Approach Lighting System: ALSF2  
2.14.4 Visual Approach Slope Indicator System: P4R

2.14.1 Designation: 36L  
2.14.2 Approach Lighting System: ALSF2  
2.14.4 Visual Approach Slope Indicator System:

2.14.1 Designation: 18R  
2.14.2 Approach Lighting System: ALSF2  
2.14.4 Visual Approach Slope Indicator System:

**AD 2.18 Air Traffic Services Communication Facilities**

2.18.1 Service Designation: APCH/P (090-269)  
2.18.3 Channel: 119.7  
2.18.5 Hours of Operation: 24

2.18.1 Service Designation: APCH/P (270-089)  
2.18.3 Channel: 123.875  
2.18.5 Hours of Operation: 24

2.18.1 Service Designation: APCH/P  
2.18.3 Channel: 363.15  
2.18.5 Hours of Operation: 24

2.18.1 Service Designation: CD/P  
2.18.3 Channel: 127.175  
2.18.5 Hours of Operation: 24

2.18.1 Service Designation: CINCE STAR  
2.18.3 Channel: 123.875  
2.18.5 Hours of Operation: 24

2.18.1 Service Designation: CINCE STAR  
2.18.3 Channel: 254.25  
2.18.5 Hours of Operation: 24

2.18.1 Service Designation: CLASS B (001-180)  
2.18.3 Channel: 121

2.18.5 Hours of Operation: 24

2.18.1 Service Designation: CLASS B (181-360)

2.18.3 Channel: 128.7

2.18.5 Hours of Operation: 24

2.18.1 Service Designation: CLASS B

2.18.3 Channel: 254.25

2.18.5 Hours of Operation: 24

2.18.1 Service Designation: D-ATIS (ARR)

2.18.3 Channel: 134.375

2.18.5 Hours of Operation: 24

2.18.1 Service Designation: D-ATIS (DEP)

2.18.3 Channel: 135.3

2.18.5 Hours of Operation: 24

2.18.1 Service Designation: DEP/P (001-180)

2.18.3 Channel: 126.65

2.18.5 Hours of Operation: 24

2.18.1 Service Designation: DEP/P (181-360)

2.18.3 Channel: 128.7

2.18.5 Hours of Operation: 24

2.18.1 Service Designation: DEP/P

2.18.3 Channel: 254.25

2.18.5 Hours of Operation: 24

2.18.1 Service Designation: EMERG

2.18.3 Channel: 121.5

2.18.5 Hours of Operation:

2.18.1 Service Designation: EMERG

2.18.3 Channel: 243

2.18.5 Hours of Operation:

2.18.1 Service Designation: GND/P

2.18.3 Channel: 121.7

2.18.5 Hours of Operation: 24

2.18.1 Service Designation: HARDU STAR (090-269)

2.18.3 Channel: 119.7

2.18.5 Hours of Operation: 24

2.18.1 Service Designation: HARDU STAR (270-089)

2.18.3 Channel: 123.875

2.18.5 Hours of Operation: 24

2.18.1 Service Designation: HARDU STAR

2.18.3 Channel: 363.15  
2.18.5 Hours of Operation: 24

2.18.1 Service Designation: JAKIE STAR  
2.18.3 Channel: 119.7  
2.18.5 Hours of Operation: 24

2.18.1 Service Designation: JAKIE STAR  
2.18.3 Channel: 254.25  
2.18.5 Hours of Operation: 24

2.18.1 Service Designation: LCL/P (RWY 09/27, 18C/36C)  
2.18.3 Channel: 118.3  
2.18.5 Hours of Operation: 24

2.18.1 Service Designation: LCL/P (RWY 18L/36R)  
2.18.3 Channel: 118.975  
2.18.5 Hours of Operation: 24

2.18.1 Service Designation: LCL/P (RWY 18R/36L)  
2.18.3 Channel: 133.325  
2.18.5 Hours of Operation: 24

2.18.1 Service Designation: LCL/P (RWY 18L/36R)  
2.18.3 Channel: 360.85  
2.18.5 Hours of Operation: 24

2.18.1 Service Designation: SHELBYVILLE STAR (090-269)  
2.18.3 Channel: 119.7  
2.18.5 Hours of Operation: 24

2.18.1 Service Designation: SHELBYVILLE STAR (270-089)  
2.18.3 Channel: 123.875  
2.18.5 Hours of Operation: 24

2.18.1 Service Designation: SHELBYVILLE STAR  
2.18.3 Channel: 363.15  
2.18.5 Hours of Operation: 24

**AD 2.19 Radio Navigation and Landing Aids**

2.19.1 ILS Type: DME for runway 09. Magnetic variation: 6W  
2.19.2 ILS Identification: URN  
2.19.5 Coordinates: 39-2-42.9147N / 84-39-2.0835W  
2.19.6 Site Elevation: 886.8 ft

2.19.1 ILS Type: Glide Slope for runway 09. Magnetic variation: 6W  
2.19.2 ILS Identification: URN  
2.19.5 Coordinates: 39-2-42.9226N / 84-41-28.2646W  
2.19.6 Site Elevation: 873.4 ft

2.19.1 ILS Type: Localizer for runway 09. Magnetic variation: 6W  
2.19.2 ILS Identification: URN  
2.19.5 Coordinates: 39-2-46.5213N / 84-39-2.0181W  
2.19.6 Site Elevation: 877.4 ft

2.19.1 ILS Type: Glide Slope for runway 27. Magnetic variation: 6W  
2.19.2 ILS Identification: JDP  
2.19.5 Coordinates: 39-2-42.6295N / 84-39-25.1643W  
2.19.6 Site Elevation: 866.4 ft

2.19.1 ILS Type: Localizer for runway 27. Magnetic variation: 6W  
2.19.2 ILS Identification: JDP  
2.19.5 Coordinates: 39-2-46.9321N / 84-41-55.3805W  
2.19.6 Site Elevation: 883.3 ft

2.19.1 ILS Type: DME for runway 18C. Magnetic variation: 6W  
2.19.2 ILS Identification: SIC  
2.19.5 Coordinates: 39-1-54.1461N / 84-40-8.213W  
2.19.6 Site Elevation: 843.6 ft

2.19.1 ILS Type: Glide Slope for runway 18C. Magnetic variation: 6W  
2.19.2 ILS Identification: SIC  
2.19.5 Coordinates: 39-3-42.6496N / 84-40-12.1363W  
2.19.6 Site Elevation: 868 ft

2.19.1 ILS Type: Localizer for runway 18C. Magnetic variation: 6W  
2.19.2 ILS Identification: SIC  
2.19.5 Coordinates: 39-1-54.1433N / 84-40-7.5139W  
2.19.6 Site Elevation: 838.2 ft

2.19.1 ILS Type: DME for runway 36C. Magnetic variation: 6W  
2.19.2 ILS Identification: CVG  
2.19.5 Coordinates: 39-4-3.9117N / 84-40-10.1702W  
2.19.6 Site Elevation: 883 ft

2.19.1 ILS Type: Glide Slope for runway 36C. Magnetic variation: 6W  
2.19.2 ILS Identification: CVG  
2.19.5 Coordinates: 39-2-15.4827N / 84-40-12.493W  
2.19.6 Site Elevation: 834.2 ft

2.19.1 ILS Type: Inner Marker for runway 36C. Magnetic variation: 6W  
2.19.2 ILS Identification: CVG  
2.19.5 Coordinates: 39-1-53.9241N / 84-40-7.5094W  
2.19.6 Site Elevation: 818.2 ft

2.19.1 ILS Type: Localizer for runway 36C. Magnetic variation: 6W  
2.19.2 ILS Identification: CVG  
2.19.5 Coordinates: 39-4-3.6949N / 84-40-6.9785W  
2.19.6 Site Elevation: 882.1 ft

2.19.1 ILS Type: DME for runway 18L. Magnetic variation: 6W

2.19.2 ILS Identification: CIZ  
2.19.5 Coordinates: 39-1-31.5713N / 84-38-45.4036W  
2.19.6 Site Elevation: 910.4 ft

2.19.1 ILS Type: Glide Slope for runway 18L. Magnetic variation: 6W  
2.19.2 ILS Identification: CIZ  
2.19.5 Coordinates: 39-3-10.8831N / 84-38-42.976W  
2.19.6 Site Elevation: 881.2 ft

2.19.1 ILS Type: Localizer for runway 18L. Magnetic variation: 6W  
2.19.2 ILS Identification: CIZ  
2.19.5 Coordinates: 39-1-31.787N / 84-38-48.5019W  
2.19.6 Site Elevation: 899 ft

2.19.1 ILS Type: DME for runway 36R. Magnetic variation: 6W  
2.19.2 ILS Identification: EEI  
2.19.5 Coordinates: 39-3-30.8826N / 84-38-51.18W  
2.19.6 Site Elevation: 900.1 ft

2.19.1 ILS Type: Glide Slope for runway 36R. Magnetic variation: 6W  
2.19.2 ILS Identification: EEI  
2.19.5 Coordinates: 39-1-52.8044N / 84-38-43.3385W  
2.19.6 Site Elevation: 889.9 ft

2.19.1 ILS Type: Inner Marker for runway 36R. Magnetic variation: 6W  
2.19.2 ILS Identification: EEI  
2.19.5 Coordinates: 39-1-33.5681N / 84-38-48.5005W  
2.19.6 Site Elevation: 898.7 ft

2.19.1 ILS Type: Localizer for runway 36R. Magnetic variation: 6W  
2.19.2 ILS Identification: EEI  
2.19.5 Coordinates: 39-3-31.4843N / 84-38-47.9544W  
2.19.6 Site Elevation: 892.1 ft

2.19.1 ILS Type: DME for runway 18R. Magnetic variation: 6W  
2.19.2 ILS Identification: CJN  
2.19.5 Coordinates: 39-2-41.52N / 84-41-5.2W  
2.19.6 Site Elevation: 869 ft

2.19.1 ILS Type: Glide Slope for runway 18R. Magnetic variation: 6W  
2.19.2 ILS Identification: CJN  
2.19.5 Coordinates: 39-4-3.91N / 84-41-6.57W  
2.19.6 Site Elevation: 860.5 ft

2.19.1 ILS Type: Inner Marker for runway 18R. Magnetic variation: 6W  
2.19.2 ILS Identification: CJN  
2.19.5 Coordinates: 39-4-23.57N / 84-41-1.42W  
2.19.6 Site Elevation: 856 ft

2.19.1 ILS Type: Localizer for runway 18R. Magnetic variation: 6W  
2.19.2 ILS Identification: CJN

2.19.5 Coordinates: 39-2-41.27N / 84-41-1.83W

2.19.6 Site Elevation: 871 ft

2.19.1 ILS Type: DME for runway 36L. Magnetic variation: 6W

2.19.2 ILS Identification: VAC

2.19.5 Coordinates: 39-4-25.0237N / 84-41-4.7924W

2.19.6 Site Elevation: 854.5 ft

2.19.1 ILS Type: Glide Slope for runway 36L. Magnetic variation: 6W

2.19.2 ILS Identification: VAC

2.19.5 Coordinates: 39-3-6.5542N / 84-41-6.7898W

2.19.6 Site Elevation: 865.8 ft

2.19.1 ILS Type: Inner Marker for runway 36L. Magnetic variation: 6W

2.19.2 ILS Identification: VAC

2.19.5 Coordinates: 39-2-44.323N / 84-41-1.8019W

2.19.6 Site Elevation: 868.2 ft

2.19.1 ILS Type: Localizer for runway 36L. Magnetic variation: 6W

2.19.2 ILS Identification: VAC

2.19.5 Coordinates: 39-4-25.5032N / 84-41-1.4165W

2.19.6 Site Elevation: 860.3 ft

2.19.1 Navigation Aid Type: VORTAC. Magnetic variation: 4W

2.19.2 Navigation Aid Identification: CVG

2.19.5 Coordinates: 39-0-57.5308N / 84-42-12.0468W

2.19.6 Site Elevation: 878 ft

**General Remarks:**

SUCCESSIVE OR SIMUL DEP FM RWY 18L, 18C, 36L, 36C & 36R APVD WITH COURSE DVRG BGN NO FURTHER THAN 2 MI FM EOR DUE TO NOISE ABATEMENT.

NOISE SENS AREA N & S OF ARPT; RWY ASGN 2200-0700 BASED ON NOISE ABATEMENT.

TWYS RSTRD TO 15 MPH OR LESS WITH WINGSPAN 214 FT OR MORE.

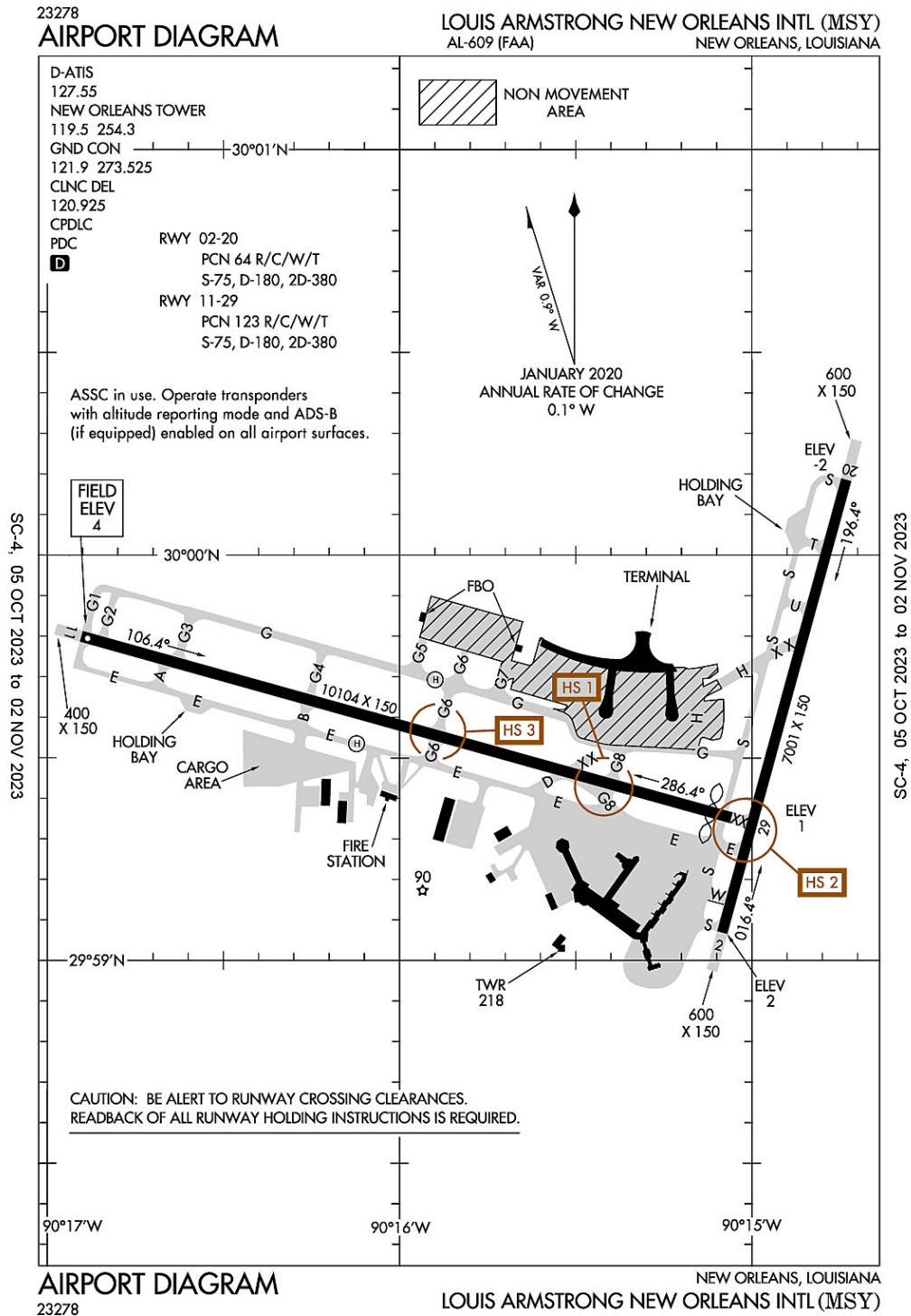
RWY 18R/36L CLSD TO AIR CARRIER ACFT WINGSPAN MORE THAN 140FT

OPR PARROT WITH ALT RPRTG MODE & ADS-B ENABLED ON ARPT SFCS.

BIRDS ON & INVOF THE ARPT.

RAMP CTL: RAMP 1N / 1S TXL & RAMP 2N / 2S TXL - 130.90, RAMP 3 TXL & N TXL - 130.375; DHL RAMP CTL: 129.475; AMZ RAMP CTL: 130.5.

**New Orleans, Louisiana**  
**Louis Armstrong New Orleans International**  
**ICAO Identifier KMSY**





**New Orleans, LA**  
**Louis Armstrong New Orleans Intl**  
**ICAO Identifier KMSY**

**AD 2.2 Aerodrome geographical and administrative data**

- 2.2.1 Reference Point: 29-59-35.8N / 90-15-32.5W
- 2.2.2 From City: 10 miles W of NEW ORLEANS, LA
- 2.2.3 Elevation: 3.7 ft
- 2.2.5 Magnetic Variation: 1W (2020)
- 2.2.6 Airport Contact: KEVIN DOLLIOLE  
PO BOX 20007  
NEW ORLEANS, LA 70141 ((504) 303-7652)
- 2.2.7 Traffic: IFR/VFR

**AD 2.3 Attendance Schedule**

- 2.3.1 All Months, All Days, All Hours

**AD 2.4 Handling Services and Facilities**

- 2.4.1 Cargo Handling Facilities: YES
- 2.4.2 Fuel Types: 100LL,A
- 2.4.5 Hangar Space:
- 2.4.6 Repair Facilities: NONE

**AD 2.6 Rescue and Firefighting Services**

- 2.6.1 Aerodrome Category: Class-I certified on 5/1/1973
- 2.6.2 Rescue and Firefighting Services: ARFF Index-D

**AD 2.12 Runway Physical Characteristics**

- 2.12.1 Designation: 02
- 2.12.2 True Bearing: 15
- 2.12.3 Dimensions: 7001 ft x 150 ft
- 2.12.4 PCN: 64 R/C/W/T
- 2.12.5 Coordinates: 29-59-4.2055N / 90-15-5.094W
- 2.12.6 Threshold Elevation: 1.8 ft
- 2.12.6 Touchdown Zone Elevation: 2.1 ft
  
- 2.12.1 Designation: 20
- 2.12.2 True Bearing: 195
- 2.12.3 Dimensions: 7001 ft x 150 ft
- 2.12.4 PCN: 64 R/C/W/T
- 2.12.5 Coordinates: 30-0-10.9924N / 90-14-43.8363W
- 2.12.6 Threshold Elevation: -2.4 ft
- 2.12.6 Touchdown Zone Elevation: -0.6 ft
  
- 2.12.1 Designation: 11
- 2.12.2 True Bearing: 105
- 2.12.3 Dimensions: 10104 ft x 150 ft
- 2.12.4 PCN: 123 R/C/W/T
- 2.12.5 Coordinates: 29-59-47.8556N / 90-16-54.2241W
- 2.12.6 Threshold Elevation: 3.7 ft
- 2.12.6 Touchdown Zone Elevation: 3.7 ft

- 2.12.1 Designation: 29
- 2.12.2 True Bearing: 285
- 2.12.3 Dimensions: 10104 ft x 150 ft
- 2.12.4 PCN: 123 R/C/W/T
- 2.12.5 Coordinates: 29-59-21.1654N / 90-15-3.4894W
- 2.12.6 Threshold Elevation: 1.3 ft
- 2.12.6 Touchdown Zone Elevation: 2 ft

**AD 2.13 Declared Distances**

- 2.13.1 Designation: 02
- 2.13.2 Take-off Run Available: 7001
- 2.13.3 Take-off Distance Available: 7001
- 2.13.4 Accelerate-Stop Distance Available: 7001
- 2.13.5 Landing Distance Available: 7001

- 2.13.1 Designation: 20
- 2.13.2 Take-off Run Available: 7001
- 2.13.3 Take-off Distance Available: 7001
- 2.13.4 Accelerate-Stop Distance Available: 7001
- 2.13.5 Landing Distance Available: 7001

- 2.13.1 Designation: 11
- 2.13.2 Take-off Run Available: 10104
- 2.13.3 Take-off Distance Available: 10104
- 2.13.4 Accelerate-Stop Distance Available: 9800
- 2.13.5 Landing Distance Available: 9800

- 2.13.1 Designation: 29
- 2.13.2 Take-off Run Available: 10104
- 2.13.3 Take-off Distance Available: 10104
- 2.13.4 Accelerate-Stop Distance Available: 10104
- 2.13.5 Landing Distance Available: 9800

**AD 2.14 Approach and Runway Lighting**

- 2.14.1 Designation: 02
- 2.14.2 Approach Lighting System: RLLS
- 2.14.4 Visual Approach Slope Indicator System: P4L

- 2.14.1 Designation: 20
- 2.14.2 Approach Lighting System: MALS
- 2.14.4 Visual Approach Slope Indicator System: P4L

- 2.14.1 Designation: 11
- 2.14.2 Approach Lighting System: ALSF2
- 2.14.4 Visual Approach Slope Indicator System: P4R

- 2.14.1 Designation: 29
- 2.14.2 Approach Lighting System: MALSR

2.14.4 Visual Approach Slope Indicator System: P4R

**AD 2.18 Air Traffic Services Communication Facilities**

2.18.1 Service Designation: APCH/P DEP/P (WEST)

2.18.3 Channel: 125.5

2.18.5 Hours of Operation: 24

2.18.1 Service Designation: APCH/P DEP/P (EAST)

2.18.3 Channel: 133.15

2.18.5 Hours of Operation: 24

2.18.1 Service Designation: APCH/P DEP/P (EAST)

2.18.3 Channel: 290.3

2.18.5 Hours of Operation: 24

2.18.1 Service Designation: APCH/P DEP/P (WEST)

2.18.3 Channel: 350.35

2.18.5 Hours of Operation: 24

2.18.1 Service Designation: APCH/S

2.18.3 Channel: 269.2

2.18.5 Hours of Operation: 24

2.18.1 Service Designation: AWDAD STAR (WEST)

2.18.3 Channel: 125.5

2.18.5 Hours of Operation: 24

2.18.1 Service Designation: AWDAD STAR (WEST)

2.18.3 Channel: 350.35

2.18.5 Hours of Operation: 24

2.18.1 Service Designation: CD PRE TAXI CLNC

2.18.3 Channel: 120.925

2.18.5 Hours of Operation: 24

2.18.1 Service Designation: CD/P

2.18.3 Channel: 120.925

2.18.5 Hours of Operation: 24

2.18.1 Service Designation: CLASS B (SE & SOUTH)

2.18.3 Channel: 123.85

2.18.5 Hours of Operation: 24

2.18.1 Service Designation: CLASS B (WEST)

2.18.3 Channel: 125.5

2.18.5 Hours of Operation: 24

2.18.1 Service Designation: CLASS B (NORTH & EAST)

2.18.3 Channel: 133.15

2.18.5 Hours of Operation: 24

2.18.1 Service Designation: CLASS B (SE & SOUTH)  
2.18.3 Channel: 256.9  
2.18.5 Hours of Operation: 24

2.18.1 Service Designation: CLASS B (NORTH & EAST)  
2.18.3 Channel: 290.3  
2.18.5 Hours of Operation: 24

2.18.1 Service Designation: CLASS B (WEST)  
2.18.3 Channel: 350.35  
2.18.5 Hours of Operation: 24

2.18.1 Service Designation: D-ATIS  
2.18.3 Channel: 127.55  
2.18.5 Hours of Operation: 24

2.18.1 Service Designation: EMERG  
2.18.3 Channel: 121.5  
2.18.5 Hours of Operation:

2.18.1 Service Designation: EMERG  
2.18.3 Channel: 243  
2.18.5 Hours of Operation:

2.18.1 Service Designation: GND/P  
2.18.3 Channel: 121.9  
2.18.5 Hours of Operation: 24

2.18.1 Service Designation: GND/P  
2.18.3 Channel: 273.525  
2.18.5 Hours of Operation: 24

2.18.1 Service Designation: LCL/P  
2.18.3 Channel: 119.5  
2.18.5 Hours of Operation: 24

2.18.1 Service Designation: LCL/P  
2.18.3 Channel: 254.3  
2.18.5 Hours of Operation: 24

2.18.1 Service Designation: MNSTR STAR (EAST)  
2.18.3 Channel: 133.15  
2.18.5 Hours of Operation: 24

2.18.1 Service Designation: MNSTR STAR (EAST)  
2.18.3 Channel: 290.3  
2.18.5 Hours of Operation: 24

2.18.1 Service Designation: OLEDD STAR (WEST)  
2.18.3 Channel: 125.5

2.18.5 Hours of Operation: 24

2.18.1 Service Designation: OLEDD STAR (WEST)

2.18.3 Channel: 350.35

2.18.5 Hours of Operation: 24

**AD 2.19 Radio Navigation and Landing Aids**

2.19.1 ILS Type: DME for runway 02. Magnetic variation: 1W

2.19.2 ILS Identification: JFI

2.19.5 Coordinates: 30-0-21.6577N / 90-14-43.2465W

2.19.6 Site Elevation: 1.3 ft

2.19.1 ILS Type: Glide Slope for runway 02. Magnetic variation: 1W

2.19.2 ILS Identification: JFI

2.19.5 Coordinates: 29-59-13.6093N / 90-14-58.5588W

2.19.6 Site Elevation: -0.9 ft

2.19.1 ILS Type: Localizer for runway 02. Magnetic variation: 1W

2.19.2 ILS Identification: JFI

2.19.5 Coordinates: 30-0-20.5102N / 90-14-40.8078W

2.19.6 Site Elevation: -4.2 ft

2.19.1 ILS Type: DME for runway 20. Magnetic variation: 1W

2.19.2 ILS Identification: ONW

2.19.5 Coordinates: 30-0-21.6577N / 90-14-43.2465W

2.19.6 Site Elevation: 1.3 ft

2.19.1 ILS Type: Localizer for runway 20. Magnetic variation: 1W

2.19.2 ILS Identification: ONW

2.19.5 Coordinates: 29-58-55.148N / 90-15-7.973W

2.19.6 Site Elevation: 2.3 ft

2.19.1 ILS Type: DME for runway 11. Magnetic variation: 1W

2.19.2 ILS Identification: MSY

2.19.5 Coordinates: 29-59-17.2127N / 90-14-55.7209W

2.19.6 Site Elevation: 12.4 ft

2.19.1 ILS Type: Glide Slope for runway 11. Magnetic variation: 1W

2.19.2 ILS Identification: MSY

2.19.5 Coordinates: 29-59-48.6197N / 90-16-39.2497W

2.19.6 Site Elevation: -3.1 ft

2.19.1 ILS Type: Inner Marker for runway 11. Magnetic variation: 1W

2.19.2 ILS Identification: MSY

2.19.5 Coordinates: 29-59-50.256N / 90-17-4.1742W

2.19.6 Site Elevation: 4.4 ft

2.19.1 ILS Type: Localizer for runway 11. Magnetic variation: 1W

2.19.2 ILS Identification: MSY

2.19.5 Coordinates: 29-59-19.3211N / 90-14-55.8537W

2.19.6 Site Elevation: -0.5 ft

2.19.1 ILS Type: DME for runway 29. Magnetic variation: 1W  
2.19.2 ILS Identification: HOX  
2.19.5 Coordinates: 29-59-17.2127N / 90-14-55.7209W  
2.19.6 Site Elevation: 12.4 ft

2.19.1 ILS Type: Glide Slope for runway 29. Magnetic variation: 1W  
2.19.2 ILS Identification: HOX  
2.19.5 Coordinates: 29-59-27.9656N / 90-15-16.7865W  
2.19.6 Site Elevation: 0.1 ft

2.19.1 ILS Type: Localizer for runway 29. Magnetic variation: 1W  
2.19.2 ILS Identification: HOX  
2.19.5 Coordinates: 29-59-50.5168N / 90-17-5.2703W  
2.19.6 Site Elevation: 4.4 ft

**General Remarks:**

180 DEG & LOCKED WHEEL TURNS PROHIBITED ON ASPH SFC ACFT 12500 LBS & OVER.

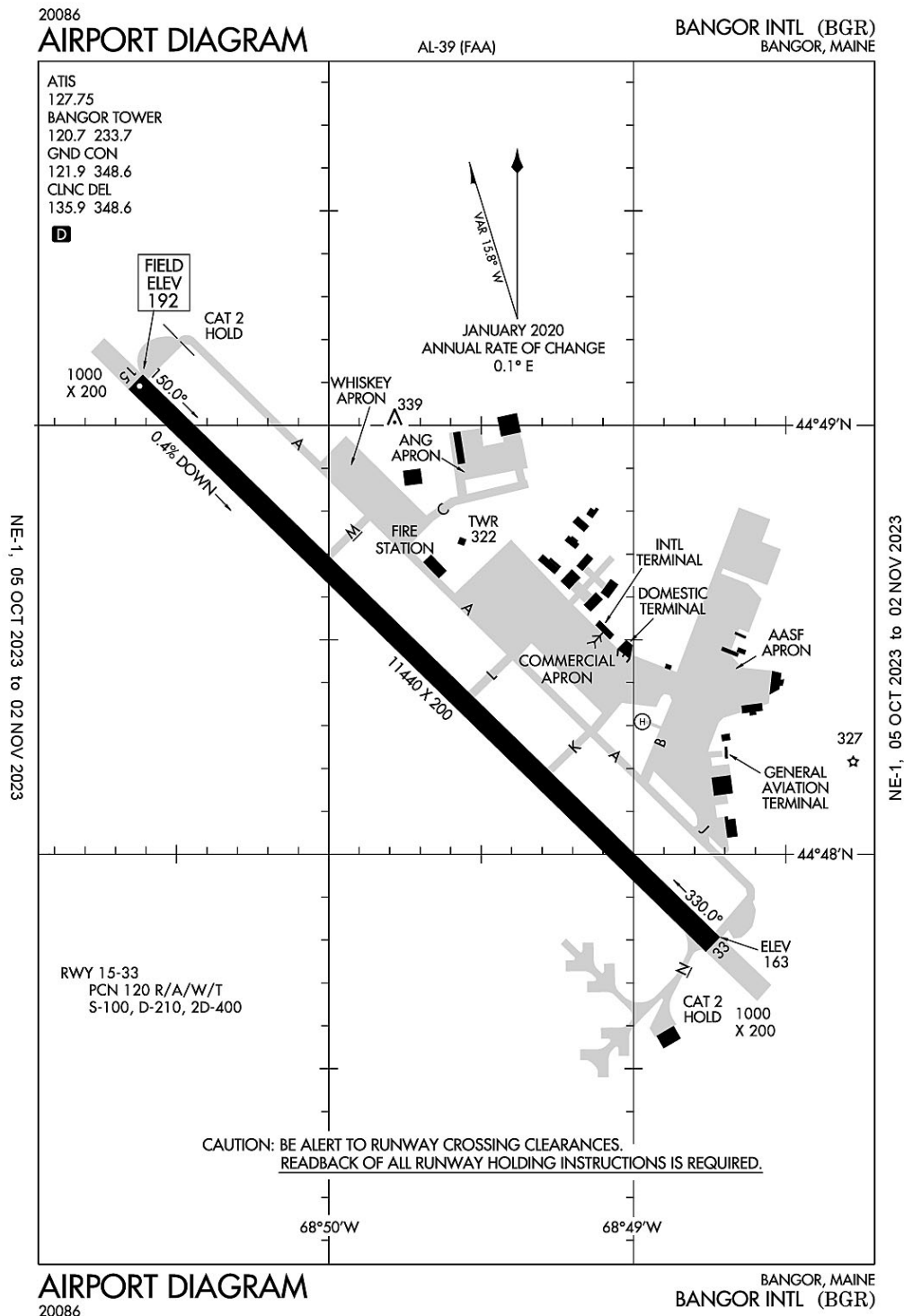
FLOCKS OF BIRDS ON & IN VICINITY OF ARPT.

ASSC IN USE. OPERATE TRANSPONDERS WITH ALTITUDE REPORTING MODE AND ADS-B (IF EQUIPPED) ENABLED ON ALL AIRPORT SURFACES.

TWY G BTN RWY 11/29 AND TWY S SFC MOV GUIDANCE AND CTL SYSTEM U/S PERM

RY 11 NOISE SENSITIVE FOR DEP; AVBL FOR OPNL NECESSITY. ALL RYS NOISE SENSITIVE FOR ARR. ARRIVING TURBOJETS MUST MAKE 5 MILE FINAL APCH TO MINIMIZE NOISE.

### Bangor, Maine Bangor International ICAO Identifier KBGR



**Bangor, ME**  
**Bangor Intl**  
**ICAO Identifier KBGR**

**AD 2.2 Aerodrome geographical and administrative data**

- 2.2.1 Reference Point: 44-48-26.8N / 68-49-41.3W
- 2.2.2 From City: 3 miles W of BANGOR, ME
- 2.2.3 Elevation: 192.1 ft
- 2.2.5 Magnetic Variation: 16W (2020)
- 2.2.6 Airport Contact: TONY CARUSO  
BANGOR INTERNATIONAL ARPT  
BANGOR, ME 4401 (207-992-4600)
- 2.2.7 Traffic: IFR/VFR

**AD 2.3 Attendance Schedule**

- 2.3.1 All Months, All Days, All Hours

**AD 2.4 Handling Services and Facilities**

- 2.4.1 Cargo Handling Facilities: YES
- 2.4.2 Fuel Types: 100LL,A
- 2.4.5 Hangar Space: YES
- 2.4.6 Repair Facilities: MAJOR

**AD 2.6 Rescue and Firefighting Services**

- 2.6.1 Aerodrome Category: Class-I certified on 5/1/1973
- 2.6.2 Rescue and Firefighting Services: ARFF Index-B

**AD 2.12 Runway Physical Characteristics**

- 2.12.1 Designation: 15
- 2.12.2 True Bearing: 134
- 2.12.3 Dimensions: 11440 ft x 200 ft
- 2.12.4 PCN: 120 R/A/W/T
- 2.12.5 Coordinates: 44-49-6.1369N / 68-50-38.1522W
- 2.12.6 Threshold Elevation: 192.1 ft
- 2.12.6 Touchdown Zone Elevation: 192.1 ft
  
- 2.12.1 Designation: 33
- 2.12.2 True Bearing: 314
- 2.12.3 Dimensions: 11440 ft x 200 ft
- 2.12.4 PCN: 120 R/A/W/T
- 2.12.5 Coordinates: 44-47-47.4136N / 68-48-44.3618W
- 2.12.6 Threshold Elevation: 162.9 ft
- 2.12.6 Touchdown Zone Elevation: 162.9 ft
  
- 2.12.1 Designation: H1
- 2.12.2 True Bearing:
- 2.12.3 Dimensions: 100 ft x 100 ft
- 2.12.4 PCN:
- 2.12.5 Coordinates: -- / --
- 2.12.6 Threshold Elevation: ft
- 2.12.6 Touchdown Zone Elevation: ft



**AD 2.13 Declared Distances**

2.13.1 Designation: 15  
2.13.2 Take-off Run Available: 11440  
2.13.3 Take-off Distance Available: 11440  
2.13.4 Accelerate-Stop Distance Available: 11440  
2.13.5 Landing Distance Available: 11440

2.13.1 Designation: 33  
2.13.2 Take-off Run Available: 11440  
2.13.3 Take-off Distance Available: 11440  
2.13.4 Accelerate-Stop Distance Available: 11440  
2.13.5 Landing Distance Available: 11440

2.13.1 Designation: H1  
2.13.2 Take-off Run Available:  
2.13.3 Take-off Distance Available:  
2.13.4 Accelerate-Stop Distance Available:  
2.13.5 Landing Distance Available:

**AD 2.14 Approach and Runway Lighting**

2.14.1 Designation: 15  
2.14.2 Approach Lighting System: ALSF2  
2.14.4 Visual Approach Slope Indicator System: P4L

2.14.1 Designation: 33  
2.14.2 Approach Lighting System: MALSR  
2.14.4 Visual Approach Slope Indicator System: P4L

2.14.1 Designation: H1  
2.14.2 Approach Lighting System:  
2.14.4 Visual Approach Slope Indicator System:

**AD 2.18 Air Traffic Services Communication Facilities**

2.18.1 Service Designation: APCH/P DEP/P IC  
2.18.3 Channel: 118.925  
2.18.5 Hours of Operation: 24

2.18.1 Service Designation: APCH/P DEP/P IC  
2.18.3 Channel: 239.3  
2.18.5 Hours of Operation: 24

2.18.1 Service Designation: APCH/S DEP/S  
2.18.3 Channel: 124.5  
2.18.5 Hours of Operation: 24

2.18.1 Service Designation: ATIS  
2.18.3 Channel: 127.75

2.18.5 Hours of Operation: 24

2.18.1 Service Designation: CD/P

2.18.3 Channel: 135.9

2.18.5 Hours of Operation: 24

2.18.1 Service Designation: CD/P

2.18.3 Channel: 348.6

2.18.5 Hours of Operation: 24

2.18.1 Service Designation: CLASS C

2.18.3 Channel: 118.925

2.18.5 Hours of Operation: 24

2.18.1 Service Designation: CLASS C

2.18.3 Channel: 239.3

2.18.5 Hours of Operation: 24

2.18.1 Service Designation: CLASS C/S

2.18.3 Channel: 124.5

2.18.5 Hours of Operation: 24

2.18.1 Service Designation: EMERG

2.18.3 Channel: 121.5

2.18.5 Hours of Operation:

2.18.1 Service Designation: EMERG

2.18.3 Channel: 243

2.18.5 Hours of Operation:

2.18.1 Service Designation: GND/P

2.18.3 Channel: 121.9

2.18.5 Hours of Operation: 24

2.18.1 Service Designation: GND/P

2.18.3 Channel: 348.6

2.18.5 Hours of Operation: 24

2.18.1 Service Designation: LCL/P

2.18.3 Channel: 120.7

2.18.5 Hours of Operation: 24

2.18.1 Service Designation: LCL/P

2.18.3 Channel: 233.7

2.18.5 Hours of Operation: 24

2.18.1 Service Designation: NG OPS

2.18.3 Channel: 41.2

2.18.5 Hours of Operation:

**AD 2.19 Radio Navigation and Landing Aids**

2.19.1 ILS Type: DME for runway 15. Magnetic variation: 16W

2.19.2 ILS Identification: JVH

2.19.5 Coordinates: 44-47-42.4986N / 68-48-31.8082W

2.19.6 Site Elevation: 166.2 ft

2.19.1 ILS Type: Glide Slope for runway 15. Magnetic variation: 16W

2.19.2 ILS Identification: JVH

2.19.5 Coordinates: 44-49-2.1756N / 68-50-22.4761W

2.19.6 Site Elevation: 187.7 ft

2.19.1 ILS Type: Inner Marker for runway 15. Magnetic variation: 16W

2.19.2 ILS Identification: JVH

2.19.5 Coordinates: 44-49-12.0633N / 68-50-46.7197W

2.19.6 Site Elevation: 184 ft

2.19.1 ILS Type: Localizer for runway 15. Magnetic variation: 16W

2.19.2 ILS Identification: JVH

2.19.5 Coordinates: 44-47-40.3704N / 68-48-34.1931W

2.19.6 Site Elevation: 161.7 ft

2.19.1 ILS Type: Middle Marker for runway 15. Magnetic variation: 16W

2.19.2 ILS Identification: JVH

2.19.5 Coordinates: 44-49-23.6858N / 68-51-3.4639W

2.19.6 Site Elevation: 158 ft

2.19.1 ILS Type: DME for runway 33. Magnetic variation: 16W

2.19.2 ILS Identification: BGR

2.19.5 Coordinates: 44-47-42.4986N / 68-48-31.8082W

2.19.6 Site Elevation: 166.2 ft

2.19.1 ILS Type: Glide Slope for runway 33. Magnetic variation: 16W

2.19.2 ILS Identification: BGR

2.19.5 Coordinates: 44-47-53.7039N / 68-48-59.7081W

2.19.6 Site Elevation: 148.8 ft

2.19.1 ILS Type: Localizer for runway 33. Magnetic variation: 16W

2.19.2 ILS Identification: BGR

2.19.5 Coordinates: 44-49-13.6222N / 68-50-48.9786W

2.19.6 Site Elevation: 181.7 ft

2.19.1 Navigation Aid Type: VORTAC. Magnetic variation: 19W

2.19.2 Navigation Aid Identification: BGR

2.19.5 Coordinates: 44-50-30.4619N / 68-52-26.2752W

2.19.6 Site Elevation: 360.1 ft

**General Remarks:**

ANG: PPR VALID +/- 1 HR UNLESS PRIOR CDN. 3 HR OUT CALL, 30 MIN OUT CALL 311.0 TO CFM CSTMS/AG AND TRAN SVC. COMMAND POST C207-404-7788 H24.

FUEL: A++ (MIL).

TWY L CLSD.

ANG: CAUTION: BASH PHASE II PERIOD SEP-NOV, APR-MAY. EXPECT INCREASED BIRD ACTIVITY. CONTACT BASE OPS/COMMAND POST/SOF FOR CURRENT BIRDWATCH COND.

ANG: OPR 1100-1930Z++ MON-FRI, CLSD WKEND AND HOL. PPR RQRD FOR ANG RAMP. CTC AFLD MGMT DSN 698-7232, C207-404-7232 FOR PPR DURG OPR HRS. PRE-COORD ALL TRNSPN RQMNTS AND HAZ CARGO WITH PPR REQ.

ARNG: OPR 1230-2100Z++ MON-FRI EXC HOL. LTD MAINT. J8. PPR MAY-OCT SVC DSN 626-1100.

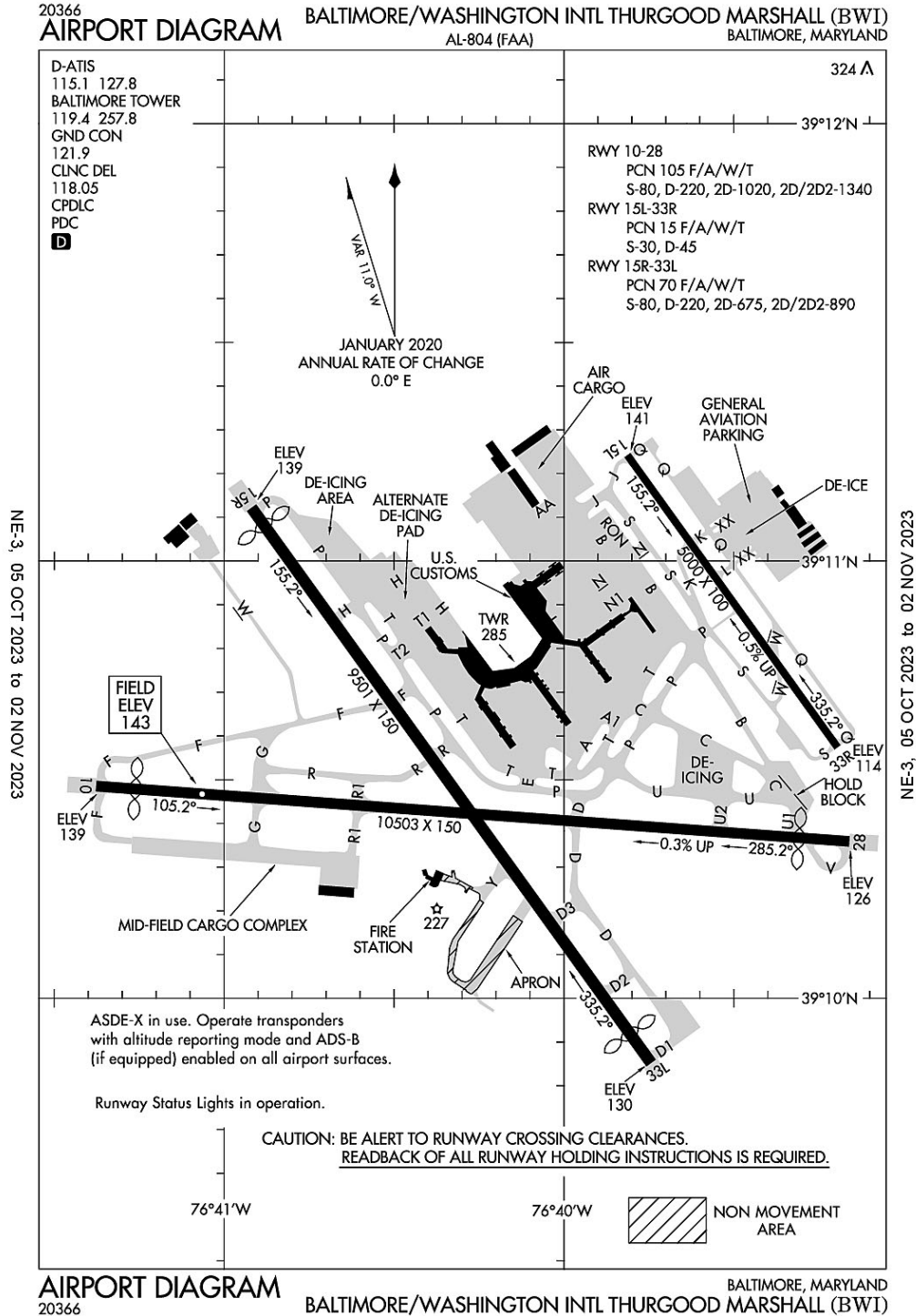
MISC: RWY 15-33 GROOVED.

SVC MIL-FLUID: OFF-BASE CONTRACTED LOX AVBL H24-RQR 24 HR NOTICE.

ANG: TRANSIENT ACFT MAY BE DIVERTED TO CIVILIAN SIDE DURING NON-DUTY HRS & WEEKENDS. FEE REQUIRED; NO ANG TRANSIENT ALERT.

TFC PAT: RWY 33 LEFT TFC, TURBO JET TFC 2000' MSL UNLESS OTHERWISE INSTR.

**Baltimore, Maryland**  
**Baltimore–Washington International Thurgood Marshall**  
**ICAO Identifier KBWI**



**Baltimore, MD**  
**Baltimore/Washington Intl Thurgood Marshal**  
**ICAO Identifier KBWI**

**AD 2.2 Aerodrome geographical and administrative data**

- 2.2.1 Reference Point: 39-10-32.622N / 76-40-8.368W
- 2.2.2 From City: 9 miles S of BALTIMORE, MD
- 2.2.3 Elevation: 143.4 ft
- 2.2.5 Magnetic Variation: 11W (2000)
- 2.2.6 Airport Contact: GREGORY SOLEK  
PO BOX 8766  
BWI AIRPORT, MD 21240 (410-859-7024)
- 2.2.7 Traffic: IFR/VFR

**AD 2.3 Attendance Schedule**

- 2.3.1 All Months, All Days, All Hours

**AD 2.4 Handling Services and Facilities**

- 2.4.1 Cargo Handling Facilities: YES
- 2.4.2 Fuel Types: 100LL,A
- 2.4.5 Hangar Space: YES
- 2.4.6 Repair Facilities: MAJOR

**AD 2.6 Rescue and Firefighting Services**

- 2.6.1 Aerodrome Category: Class-I certified on 5/1/1973
- 2.6.2 Rescue and Firefighting Services: ARFF Index-D

**AD 2.12 Runway Physical Characteristics**

- 2.12.1 Designation: 10
- 2.12.2 True Bearing: 94
- 2.12.3 Dimensions: 10503 ft x 150 ft
- 2.12.4 PCN: 105 F/A/W/T
- 2.12.5 Coordinates: 39-10-29.0895N / 76-41-22.6248W
- 2.12.6 Threshold Elevation: 139 ft
- 2.12.6 Touchdown Zone Elevation: 143.4 ft
  
- 2.12.1 Designation: 28
- 2.12.2 True Bearing: 274
- 2.12.3 Dimensions: 10503 ft x 150 ft
- 2.12.4 PCN: 105 F/A/W/T
- 2.12.5 Coordinates: 39-10-21.4754N / 76-39-9.6234W
- 2.12.6 Threshold Elevation: 126.4 ft
- 2.12.6 Touchdown Zone Elevation: 142.7 ft
  
- 2.12.1 Designation: 33R
- 2.12.2 True Bearing: 324
- 2.12.3 Dimensions: 5000 ft x 100 ft
- 2.12.4 PCN: 15 F/A/W/T
- 2.12.5 Coordinates: 39-10-34.4468N / 76-39-11.6307W
- 2.12.6 Threshold Elevation: 114 ft
- 2.12.6 Touchdown Zone Elevation: 124.4 ft

2.12.1 Designation: 15L  
2.12.2 True Bearing: 144  
2.12.3 Dimensions: 5000 ft x 100 ft  
2.12.4 PCN: 15 F/A/W/T  
2.12.5 Coordinates: 39-11-14.5431N / 76-39-48.7441W  
2.12.6 Threshold Elevation: 141.4 ft  
2.12.6 Touchdown Zone Elevation: 141.5 ft

2.12.1 Designation: 33L  
2.12.2 True Bearing: 324  
2.12.3 Dimensions: 9501 ft x 150 ft  
2.12.4 PCN: 70 F/A/W/T  
2.12.5 Coordinates: 39-9-51.1311N / 76-39-44.6134W  
2.12.6 Threshold Elevation: 129.6 ft  
2.12.6 Touchdown Zone Elevation: 142.7 ft

2.12.1 Designation: 15R  
2.12.2 True Bearing: 144  
2.12.3 Dimensions: 9501 ft x 150 ft  
2.12.4 PCN: 70 F/A/W/T  
2.12.5 Coordinates: 39-11-7.3007N / 76-40-55.1704W  
2.12.6 Threshold Elevation: 139 ft  
2.12.6 Touchdown Zone Elevation: 138.3 ft

#### **AD 2.13 Declared Distances**

2.13.1 Designation: 10  
2.13.2 Take-off Run Available: 10503  
2.13.3 Take-off Distance Available: 10503  
2.13.4 Accelerate-Stop Distance Available: 10503  
2.13.5 Landing Distance Available: 9953

2.13.1 Designation: 28  
2.13.2 Take-off Run Available: 10503  
2.13.3 Take-off Distance Available: 10503  
2.13.4 Accelerate-Stop Distance Available: 10503  
2.13.5 Landing Distance Available: 9803

2.13.1 Designation: 33R  
2.13.2 Take-off Run Available: 5000  
2.13.3 Take-off Distance Available: 5000  
2.13.4 Accelerate-Stop Distance Available: 5000  
2.13.5 Landing Distance Available: 5000

2.13.1 Designation: 15L  
2.13.2 Take-off Run Available: 5000  
2.13.3 Take-off Distance Available: 5000  
2.13.4 Accelerate-Stop Distance Available: 5000  
2.13.5 Landing Distance Available: 5000

2.13.1 Designation: 33L  
2.13.2 Take-off Run Available: 9501  
2.13.3 Take-off Distance Available: 9501  
2.13.4 Accelerate-Stop Distance Available: 8801  
2.13.5 Landing Distance Available: 8301

2.13.1 Designation: 15R  
2.13.2 Take-off Run Available: 9501  
2.13.3 Take-off Distance Available: 9501  
2.13.4 Accelerate-Stop Distance Available: 8601  
2.13.5 Landing Distance Available: 8301

#### **AD 2.14 Approach and Runway Lighting**

2.14.1 Designation: 10  
2.14.2 Approach Lighting System: ALSF2  
2.14.4 Visual Approach Slope Indicator System: P4R

2.14.1 Designation: 28  
2.14.2 Approach Lighting System: MALSR  
2.14.4 Visual Approach Slope Indicator System: P4L

2.14.1 Designation: 33R  
2.14.2 Approach Lighting System: MALSR  
2.14.4 Visual Approach Slope Indicator System: P4L

2.14.1 Designation: 15L  
2.14.2 Approach Lighting System:  
2.14.4 Visual Approach Slope Indicator System: P4L

2.14.1 Designation: 33L  
2.14.2 Approach Lighting System: MALSR  
2.14.4 Visual Approach Slope Indicator System: P4L

2.14.1 Designation: 15R  
2.14.2 Approach Lighting System: MALSR  
2.14.4 Visual Approach Slope Indicator System: P4R

#### **AD 2.18 Air Traffic Services Communication Facilities**

2.18.1 Service Designation: CD/P  
2.18.3 Channel: 118.05  
2.18.5 Hours of Operation: 24

2.18.1 Service Designation: D-ATIS  
2.18.3 Channel: 115.1  
2.18.5 Hours of Operation: 24

2.18.1 Service Designation: D-ATIS  
2.18.3 Channel: 127.8  
2.18.5 Hours of Operation: 24



2.18.1 Service Designation: EMERG  
2.18.3 Channel: 121.5  
2.18.5 Hours of Operation:

2.18.1 Service Designation: EMERG  
2.18.3 Channel: 243  
2.18.5 Hours of Operation:

2.18.1 Service Designation: GND/P  
2.18.3 Channel: 121.9  
2.18.5 Hours of Operation: 24

2.18.1 Service Designation: LCL/P  
2.18.3 Channel: 119.4  
2.18.5 Hours of Operation: 24

2.18.1 Service Designation: LCL/P  
2.18.3 Channel: 257.8  
2.18.5 Hours of Operation: 24

#### **AD 2.19 Radio Navigation and Landing Aids**

2.19.1 ILS Type: Glide Slope for runway 10. Magnetic variation: 11W  
2.19.2 ILS Identification: BAL  
2.19.5 Coordinates: 39-10-23.557N / 76-41-3.233W  
2.19.6 Site Elevation: 137.6 ft

2.19.1 ILS Type: Localizer for runway 10. Magnetic variation: 11W  
2.19.2 ILS Identification: BAL  
2.19.5 Coordinates: 39-10-20.5919N / 76-38-54.2857W  
2.19.6 Site Elevation: 137.5 ft

2.19.1 ILS Type: Glide Slope for runway 28. Magnetic variation: 11W  
2.19.2 ILS Identification: OEH  
2.19.5 Coordinates: 39-10-18.64N / 76-39-31.024W  
2.19.6 Site Elevation: 129.2 ft

2.19.1 ILS Type: Localizer for runway 28. Magnetic variation: 11W  
2.19.2 ILS Identification: OEH  
2.19.5 Coordinates: 39-10-29.8183N / 76-41-35.4222W  
2.19.6 Site Elevation: 134 ft

2.19.1 ILS Type: Glide Slope for runway 15L. Magnetic variation: 11W  
2.19.2 ILS Identification: UQC  
2.19.5 Coordinates: 39-11-3.67N / 76-39-44.24W  
2.19.6 Site Elevation: 138.1 ft

2.19.1 ILS Type: Localizer for runway 15L. Magnetic variation: 11W  
2.19.2 ILS Identification: UQC  
2.19.5 Coordinates: 39-10-29.3978N / 76-39-6.9539W

2.19.6 Site Elevation: 94 ft

2.19.1 ILS Type: Glide Slope for runway 33R. Magnetic variation: 11W

2.19.2 ILS Identification: BWI

2.19.5 Coordinates: 39-10-40.05N / 76-39-21.19W

2.19.6 Site Elevation: 110.3 ft

2.19.1 ILS Type: Localizer for runway 33R. Magnetic variation: 11W

2.19.2 ILS Identification: BWI

2.19.5 Coordinates: 39-11-19.7555N / 76-39-53.5728W

2.19.6 Site Elevation: 133 ft

2.19.1 ILS Type: Glide Slope for runway 15R. Magnetic variation: 11W

2.19.2 ILS Identification: FND

2.19.5 Coordinates: 39-10-53.6029N / 76-40-48.8976W

2.19.6 Site Elevation: 130.2 ft

2.19.1 ILS Type: Localizer for runway 15R. Magnetic variation: 11W

2.19.2 ILS Identification: FND

2.19.5 Coordinates: 39-9-39.0861N / 76-39-33.4607W

2.19.6 Site Elevation: 115.9 ft

2.19.1 ILS Type: Glide Slope for runway 33L. Magnetic variation: 11W

2.19.2 ILS Identification: RUX

2.19.5 Coordinates: 39-10-0.5283N / 76-39-59.734W

2.19.6 Site Elevation: 125.6 ft

2.19.1 ILS Type: Localizer for runway 33L. Magnetic variation: 11W

2.19.2 ILS Identification: RUX

2.19.5 Coordinates: 39-11-12.2145N / 76-40-59.7239W

2.19.6 Site Elevation: 133 ft

**General Remarks:**

NO APRON PARKING FOR UNSKED ACR.

GENERAL AVIATION ACFT CTC UNICOM PRIOR TO ARRIVING AT GENERAL AVIATION RAMP FOR SECURITY PURPOSES.

ASDE-X IN USE. OPERATE TRANSPONDERS WITH ALT REPORTING MODE AND ADS-B (IF EQUIPPED) ENABLED ON ALL ARPT SURFACES.

TWY 'A' IS RSTRD TO GROUP IV ACFT WINGSPAN 171 FT OR LESS.

RWY STATUS LGTS IN OPN.

DISTRACTING LGTS (GOLF DRIVING RANGE) RIGHT SIDE EXTDD CNTRLN RWY 33L FM AER TO 1/4 MI FINAL.

ACFT DEPARTING RWY 28 EXP DEP FM TWY U1.

DURING ATC ZERO EVENTS, UNICOM 119.4.

ACFT ON VISUAL APCHS EXPECT TO MAINTAIN 3000 FT UNTIL 10 DME FM BAL VORTAC; DEP ACFT

SHOULD EXPECT TURNS BASED ON BALTIMORE DME.

DEER & BIRDS OCNNLY ON & INVOF ARPT.

PRACTICE LNDG & APCH BY TURBO-PWRD ACFT PROHIBITED 2200-0600; PRACTICE LNDG & TKOF BY B-747 ACFT PROHIBITED RWY 15R/33L.

RWY 28 DE-ICE PAD LANE 1 RSTRD TO ACFT WITH WINGSPAN 171 FT OR LESS, LANE 2 RSTRD TO ACFT WITH WINGSPAN 135 FT OR LESS, LANE 3 IS USED BY LARGE ACFT MAX WINGSPAN 215 FT AND WHEN IN USE- LANES 2 AND 4 ARE UNAVBL. LANES 4, 5 & 6 ARE RSTRD TO ACFT WINGSPAN 135 FT OR LESS.

RWY 15R DEICE PAD, POSITION # 1, RSTRD TO ACFT WITH WINGSPAN OF 156 FT 1 INCH OR LESS & LENGTH OF 180 FT 3 INCHES OR LESS. PSN'S #2 & #3 ARE RSTD TO ACFT WITH A WINGSPAN OF 156 FT 1 INCH OR LESS, POSITION #3 IS RSTRD TO ACFT WITH A WINGSPAN OF 156 FT 1 INCH OR LESS & LENGTH OF 180 FT 3 INCHES OR LESS; POSITION 4 RSTRD TO ACFT WITH WINGSPAN OF 213 FT OR LESS & LENGTH OF 229 FT 2 INCHES OR LESS.

RWY LEN AVBL FOR RWY 28 DEPS FM TWY U1 IS 9802 FT.

MAJOR CONSTR ON ARPT DLY; ACFT MOV & PRKG AREAS SUBJECT TO SHORT NOTICE CHANGE/CLOSURE. FOR CURRENT INFO PHONE BWI OPNS CNTR 410-859-7018.

CONCOURSE A ALT DEICING AREA IS RSTRD TO B737-800 SIZE ACFT WITH WINGLETS OR SMLR ON SPOTS 6, 7 AND 8.

TAXIING PROHIBITED BTN CONCOURSE C & ADJ BLDG STRUCTURE SW OF CONCOURSE C. ACCESS TO GATE C12 MUST BE VIA TWY A.

TWY T BTN TWY H AND TWY E RSTD TO GROUP IV ACFT WITH WINGSPAN LESS THAN 171 FT. TWY T BTN TWY E AND TWY B RSTRD TO GROUP V ACFT WITH WINGSPAN LESS THAN 214 FT; WHEN GROUP V ACFT ARE ON TWY T, TWY A IS RSTRD TO MAX WINGSPANS OF 110 FT.

TWY "S", SOUTH OF TWY "P", RSTRD TO ACFT 60000 LBS & LESS.

TAXILANES 'T-1' & "H" RSTRD TO GROUP III ACFT WITH MAX WINGSPAN OF 118 FEET.

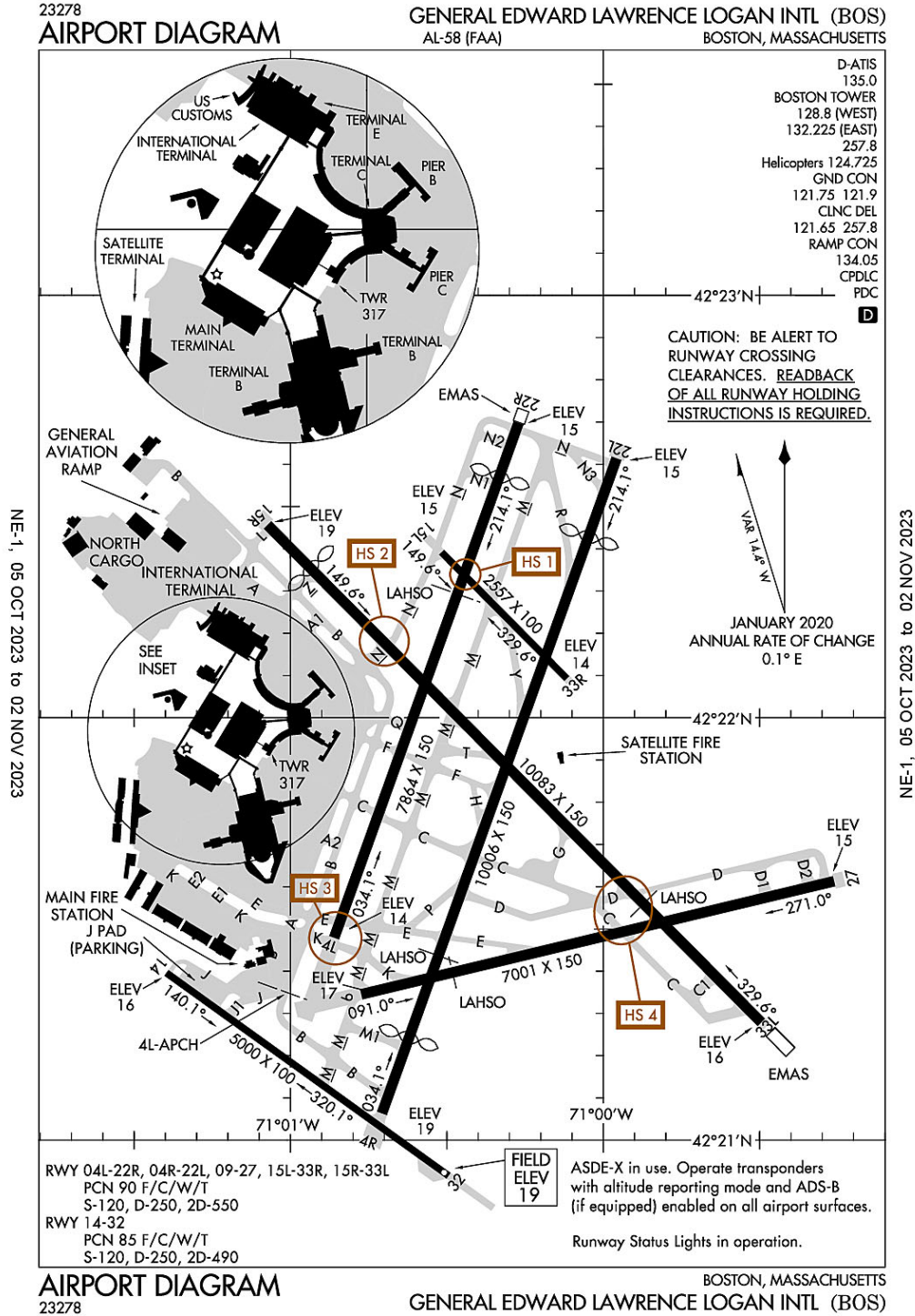
NOISE ABATEMENT PROCEDURES IN EFFECT - RSTRN FOR RWY 15L/33R EXCEPT FOR EMERG OR MERCY FLIGHTS CTC AMGR FOR INFO.

CONT MOWING OPERATIONS ADJ ALL RWYS & TWYS - APR THRU NOV.

UNICOM 119.4.

DUAL PARALLEL TAXILANES HAVE BEEN ADDED TO THE 'D'/'E' ALLEYWAY; TAXILANE 'N' AND TAXILANE 'N1'. TAXILANE 'N' IS DESIGNATED A "GROUP V" TAXILANE WITH MAX WINGSPAN OF 213 FT. TAXILANE 'N1' IS DESIGNATED A "GROUP IV" TAXILANE WITH MAX WINGSPAN OF 170 FT.

### Boston, Massachusetts General Edward Lawrence Logan International ICAO Identifier KBOS



**Boston, MA**  
**General Edward Lawrence Logan Intl**  
**ICAO Identifier KBOS**

**AD 2.2 Aerodrome geographical and administrative data**

- 2.2.1 Reference Point: 42-21-46.6N / 71-0-23W
- 2.2.2 From City: 1 miles E of BOSTON, MA
- 2.2.3 Elevation: 19.1 ft
- 2.2.5 Magnetic Variation: 15W (2020)
- 2.2.6 Airport Contact: EDWARD FRENI  
LOGAN INTERNATIONAL AIRPORT  
EAST BOSTON, MA 2128 (617-567-5400)
- 2.2.7 Traffic: IFR/VFR

**AD 2.3 Attendance Schedule**

- 2.3.1 All Months, All Days, All Hours

**AD 2.4 Handling Services and Facilities**

- 2.4.1 Cargo Handling Facilities: YES
- 2.4.2 Fuel Types: 100LL,A
- 2.4.5 Hangar Space:
- 2.4.6 Repair Facilities: MAJOR

**AD 2.6 Rescue and Firefighting Services**

- 2.6.1 Aerodrome Category: Class-I certified on 9/1/1972
- 2.6.2 Rescue and Firefighting Services: ARFF Index-E

**AD 2.12 Runway Physical Characteristics**

- 2.12.1 Designation: 04L
- 2.12.2 True Bearing: 20
- 2.12.3 Dimensions: 7864 ft x 150 ft
- 2.12.4 PCN: 90 F/C/W/T
- 2.12.5 Coordinates: 42-21-28.7577N / 71-0-51.6187W
- 2.12.6 Threshold Elevation: 13.9 ft
- 2.12.6 Touchdown Zone Elevation: 13.9 ft

- 2.12.1 Designation: 22R
- 2.12.2 True Bearing: 200
- 2.12.3 Dimensions: 7864 ft x 150 ft
- 2.12.4 PCN: 90 F/C/W/T
- 2.12.5 Coordinates: 42-22-41.8759N / 71-0-16.2499W
- 2.12.6 Threshold Elevation: 14.9 ft
- 2.12.6 Touchdown Zone Elevation: 15.2 ft

- 2.12.1 Designation: 04R
- 2.12.2 True Bearing: 20
- 2.12.3 Dimensions: 10006 ft x 150 ft
- 2.12.4 PCN: 90 F/C/W/T
- 2.12.5 Coordinates: 42-21-3.8094N / 71-0-42.458W
- 2.12.6 Threshold Elevation: 18.8 ft
- 2.12.6 Touchdown Zone Elevation: 17.6 ft

2.12.1 Designation: 22L  
2.12.2 True Bearing: 200  
2.12.3 Dimensions: 10006 ft x 150 ft  
2.12.4 PCN: 90 F/C/W/T  
2.12.5 Coordinates: 42-22-36.8399N / 70-59-57.4473W  
2.12.6 Threshold Elevation: 14.5 ft  
2.12.6 Touchdown Zone Elevation: 15.6 ft

2.12.1 Designation: 09  
2.12.2 True Bearing: 77  
2.12.3 Dimensions: 7001 ft x 150 ft  
2.12.4 PCN: 90 F/C/W/T  
2.12.5 Coordinates: 42-21-20.715N / 71-0-46.4187W  
2.12.6 Threshold Elevation: 16.7 ft  
2.12.6 Touchdown Zone Elevation: 16.8 ft

2.12.1 Designation: 27  
2.12.2 True Bearing: 257  
2.12.3 Dimensions: 7001 ft x 150 ft  
2.12.4 PCN: 90 F/C/W/T  
2.12.5 Coordinates: 42-21-36.7767N / 70-59-15.7276W  
2.12.6 Threshold Elevation: 14.8 ft  
2.12.6 Touchdown Zone Elevation: 17.2 ft

2.12.1 Designation: 14  
2.12.2 True Bearing: 125  
2.12.3 Dimensions: 5000 ft x 100 ft  
2.12.4 PCN: 85 F/C/W/T  
2.12.5 Coordinates: 42-21-23.7521N / 71-1-23.7886W  
2.12.6 Threshold Elevation: 16 ft  
2.12.6 Touchdown Zone Elevation: 19.1 ft

2.12.1 Designation: 32  
2.12.2 True Bearing: 305  
2.12.3 Dimensions: 5000 ft x 100 ft  
2.12.4 PCN: 85 F/C/W/T  
2.12.5 Coordinates: 42-20-54.9565N / 71-0-29.6841W  
2.12.6 Threshold Elevation: 19.1 ft  
2.12.6 Touchdown Zone Elevation: 19.1 ft

2.12.1 Designation: 15L  
2.12.2 True Bearing: 135  
2.12.3 Dimensions: 2557 ft x 100 ft  
2.12.4 PCN: 90 F/C/W/T  
2.12.5 Coordinates: 42-22-23.5008N / 71-0-31.0047W  
2.12.6 Threshold Elevation: 14.8 ft  
2.12.6 Touchdown Zone Elevation: 15.8 ft

2.12.1 Designation: 33R  
2.12.2 True Bearing: 315

2.12.3 Dimensions: 2557 ft x 100 ft  
2.12.4 PCN: 90 F/C/W/T  
2.12.5 Coordinates: 42-22-5.5791N / 71-0-7.0008W  
2.12.6 Threshold Elevation: 14 ft  
2.12.6 Touchdown Zone Elevation: 15.8 ft

2.12.1 Designation: 15R  
2.12.2 True Bearing: 135  
2.12.3 Dimensions: 10083 ft x 150 ft  
2.12.4 PCN: 90 F/C/W/T  
2.12.5 Coordinates: 42-22-27.3749N / 71-1-4.4117W  
2.12.6 Threshold Elevation: 18.9 ft  
2.12.6 Touchdown Zone Elevation: 17 ft

2.12.1 Designation: 33L  
2.12.2 True Bearing: 315  
2.12.3 Dimensions: 10083 ft x 150 ft  
2.12.4 PCN: 90 F/C/W/T  
2.12.5 Coordinates: 42-21-16.7428N / 70-59-29.7098W  
2.12.6 Threshold Elevation: 15.7 ft  
2.12.6 Touchdown Zone Elevation: 16.2 ft

#### **AD 2.13 Declared Distances**

2.13.1 Designation: 04L  
2.13.2 Take-off Run Available: 7864  
2.13.3 Take-off Distance Available: 7864  
2.13.4 Accelerate-Stop Distance Available: 7864  
2.13.5 Landing Distance Available: 7864

2.13.1 Designation: 22R  
2.13.2 Take-off Run Available: 7864  
2.13.3 Take-off Distance Available: 7864  
2.13.4 Accelerate-Stop Distance Available: 7864  
2.13.5 Landing Distance Available: 7046

2.13.1 Designation: 04R  
2.13.2 Take-off Run Available: 10006  
2.13.3 Take-off Distance Available: 10006  
2.13.4 Accelerate-Stop Distance Available: 10006  
2.13.5 Landing Distance Available: 8851

2.13.1 Designation: 22L  
2.13.2 Take-off Run Available: 10006  
2.13.3 Take-off Distance Available: 10006  
2.13.4 Accelerate-Stop Distance Available: 10006  
2.13.5 Landing Distance Available: 8806

2.13.1 Designation: 09  
2.13.2 Take-off Run Available: 7001  
2.13.3 Take-off Distance Available: 7001

2.13.4 Accelerate-Stop Distance Available: 7001  
2.13.5 Landing Distance Available: 7001

2.13.1 Designation: 27  
2.13.2 Take-off Run Available: 7001  
2.13.3 Take-off Distance Available: 7001  
2.13.4 Accelerate-Stop Distance Available: 7001  
2.13.5 Landing Distance Available: 7001

2.13.1 Designation: 14  
2.13.2 Take-off Run Available: 5000  
2.13.3 Take-off Distance Available: 5000  
2.13.4 Accelerate-Stop Distance Available: 5000  
2.13.5 Landing Distance Available: 5000

2.13.1 Designation: 32  
2.13.2 Take-off Run Available: 5000  
2.13.3 Take-off Distance Available: 5000  
2.13.4 Accelerate-Stop Distance Available: 5000  
2.13.5 Landing Distance Available: 5000

2.13.1 Designation: 15L  
2.13.2 Take-off Run Available: 2557  
2.13.3 Take-off Distance Available: 2557  
2.13.4 Accelerate-Stop Distance Available: 2557  
2.13.5 Landing Distance Available: 2557

2.13.1 Designation: 33R  
2.13.2 Take-off Run Available: 2557  
2.13.3 Take-off Distance Available: 2557  
2.13.4 Accelerate-Stop Distance Available: 2557  
2.13.5 Landing Distance Available: 2557

2.13.1 Designation: 15R  
2.13.2 Take-off Run Available: 10083  
2.13.3 Take-off Distance Available: 10083  
2.13.4 Accelerate-Stop Distance Available: 10083  
2.13.5 Landing Distance Available: 9202

2.13.1 Designation: 33L  
2.13.2 Take-off Run Available: 10083  
2.13.3 Take-off Distance Available: 10083  
2.13.4 Accelerate-Stop Distance Available: 10083  
2.13.5 Landing Distance Available: 10083

#### **AD 2.14 Approach and Runway Lighting**

2.14.1 Designation: 04L  
2.14.2 Approach Lighting System:  
2.14.4 Visual Approach Slope Indicator System: P4L



2.14.1 Designation: 22R  
2.14.2 Approach Lighting System:  
2.14.4 Visual Approach Slope Indicator System: P4L

2.14.1 Designation: 04R  
2.14.2 Approach Lighting System: ALSF2  
2.14.4 Visual Approach Slope Indicator System: P4L

2.14.1 Designation: 22L  
2.14.2 Approach Lighting System: MALSF  
2.14.4 Visual Approach Slope Indicator System: P4R

2.14.1 Designation: 09  
2.14.2 Approach Lighting System:  
2.14.4 Visual Approach Slope Indicator System:

2.14.1 Designation: 27  
2.14.2 Approach Lighting System:  
2.14.4 Visual Approach Slope Indicator System: P4L

2.14.1 Designation: 14  
2.14.2 Approach Lighting System:  
2.14.4 Visual Approach Slope Indicator System:

2.14.1 Designation: 32  
2.14.2 Approach Lighting System:  
2.14.4 Visual Approach Slope Indicator System: P4L

2.14.1 Designation: 15L  
2.14.2 Approach Lighting System:  
2.14.4 Visual Approach Slope Indicator System:

2.14.1 Designation: 33R  
2.14.2 Approach Lighting System:  
2.14.4 Visual Approach Slope Indicator System: P4R

2.14.1 Designation: 15R  
2.14.2 Approach Lighting System: MALSR  
2.14.4 Visual Approach Slope Indicator System: P4L

2.14.1 Designation: 33L  
2.14.2 Approach Lighting System: ALSF2  
2.14.4 Visual Approach Slope Indicator System: P4R

**AD 2.18 Air Traffic Services Communication Facilities**

2.18.1 Service Designation: CD PRE TAXI CLNC  
2.18.3 Channel: 121.65  
2.18.5 Hours of Operation: 24

2.18.1 Service Designation: CD/P

2.18.3 Channel: 257.8  
2.18.5 Hours of Operation: 24

2.18.1 Service Designation: D-ATIS (DEP)  
2.18.3 Channel: 135  
2.18.5 Hours of Operation: 24

2.18.1 Service Designation: D-ATIS (ARR)  
2.18.3 Channel: 135  
2.18.5 Hours of Operation: 24

2.18.1 Service Designation: EMERG  
2.18.3 Channel: 121.5  
2.18.5 Hours of Operation:

2.18.1 Service Designation: EMERG  
2.18.3 Channel: 243  
2.18.5 Hours of Operation:

2.18.1 Service Designation: GND/P  
2.18.3 Channel: 121.75  
2.18.5 Hours of Operation: 24

2.18.1 Service Designation: GND/P  
2.18.3 Channel: 121.9  
2.18.5 Hours of Operation: 24

2.18.1 Service Designation: LCL/P (HELICOPTERS)  
2.18.3 Channel: 124.725  
2.18.5 Hours of Operation: 24

2.18.1 Service Designation: LCL/P (WEST)  
2.18.3 Channel: 128.8  
2.18.5 Hours of Operation: 24

2.18.1 Service Designation: LCL/P (EAST)  
2.18.3 Channel: 132.225  
2.18.5 Hours of Operation: 24

2.18.1 Service Designation: LCL/P  
2.18.3 Channel: 257.8  
2.18.5 Hours of Operation: 24

2.18.1 Service Designation: RAMP CTL  
2.18.3 Channel: 134.05  
2.18.5 Hours of Operation: 24

### **AD 2.19 Radio Navigation and Landing Aids**

2.19.1 ILS Type: DME for runway 04R. Magnetic variation: 15W  
2.19.2 ILS Identification: BOS

2.19.5 Coordinates: 42-22-57.4695N / 70-59-50.8873W  
2.19.6 Site Elevation: 34.5 ft

2.19.1 ILS Type: Glide Slope for runway 04R. Magnetic variation: 15W  
2.19.2 ILS Identification: BOS  
2.19.5 Coordinates: 42-21-21.8231N / 71-0-24.5483W  
2.19.6 Site Elevation: 10.1 ft

2.19.1 ILS Type: Localizer for runway 04R. Magnetic variation: 15W  
2.19.2 ILS Identification: BOS  
2.19.5 Coordinates: 42-22-55.9736N / 70-59-48.1884W  
2.19.6 Site Elevation: 17.6 ft

2.19.1 ILS Type: DME for runway 22L. Magnetic variation: 15W  
2.19.2 ILS Identification: LQN  
2.19.5 Coordinates: 42-22-57.4695N / 70-59-50.8873W  
2.19.6 Site Elevation: 34.5 ft

2.19.1 ILS Type: Glide Slope for runway 22L. Magnetic variation: 15W  
2.19.2 ILS Identification: LQN  
2.19.5 Coordinates: 42-22-17.0026N / 71-0-11.9878W  
2.19.6 Site Elevation: 11.1 ft

2.19.1 ILS Type: Localizer for runway 22L. Magnetic variation: 15W  
2.19.2 ILS Identification: LQN  
2.19.5 Coordinates: 42-21-0.0409N / 71-0-44.2844W  
2.19.6 Site Elevation: 14.6 ft

2.19.1 ILS Type: DME for runway 27. Magnetic variation: 15W  
2.19.2 ILS Identification: DGU  
2.19.5 Coordinates: 42-21-15.6955N / 71-0-55.7791W  
2.19.6 Site Elevation: 30.5 ft

2.19.1 ILS Type: Glide Slope for runway 27. Magnetic variation: 15W  
2.19.2 ILS Identification: DGU  
2.19.5 Coordinates: 42-21-31.2953N / 70-59-28.3545W  
2.19.6 Site Elevation: 12.3 ft

2.19.1 ILS Type: Localizer for runway 27. Magnetic variation: 15W  
2.19.2 ILS Identification: DGU  
2.19.5 Coordinates: 42-21-18.4751N / 71-0-59.0489W  
2.19.6 Site Elevation: 16.5 ft

2.19.1 ILS Type: DME for runway 15R. Magnetic variation: 15W  
2.19.2 ILS Identification: MDC  
2.19.5 Coordinates: 42-21-26.5111N / 70-59-35.0574W  
2.19.6 Site Elevation: 26.4 ft

2.19.1 ILS Type: Glide Slope for runway 15R. Magnetic variation: 15W  
2.19.2 ILS Identification: MDC  
2.19.5 Coordinates: 42-22-14.6947N / 71-0-42.4209W

2.19.6 Site Elevation: 11.2 ft

2.19.1 ILS Type: Localizer for runway 15R. Magnetic variation: 15W  
2.19.2 ILS Identification: MDC  
2.19.5 Coordinates: 42-21-26.3592N / 70-59-37.052W  
2.19.6 Site Elevation: 11.1 ft

2.19.1 ILS Type: DME for runway 33L. Magnetic variation: 15W  
2.19.2 ILS Identification: LIP  
2.19.5 Coordinates: 42-21-26.5111N / 70-59-35.0574W  
2.19.6 Site Elevation: 26.4 ft

2.19.1 ILS Type: Glide Slope for runway 33L. Magnetic variation: 15W  
2.19.2 ILS Identification: LIP  
2.19.5 Coordinates: 42-21-26.6446N / 70-59-34.7132W  
2.19.6 Site Elevation: 11.3 ft

2.19.1 ILS Type: Localizer for runway 33L. Magnetic variation: 15W  
2.19.2 ILS Identification: LIP  
2.19.5 Coordinates: 42-22-37.5624N / 71-1-18.0895W  
2.19.6 Site Elevation: 15.9 ft

2.19.1 Navigation Aid Type: VOR/DME. Magnetic variation: 16W  
2.19.2 Navigation Aid Identification: BOS  
2.19.5 Coordinates: 42-21-26.8197N / 70-59-22.3742W  
2.19.6 Site Elevation: 18.4 ft

**General Remarks:**

RWY STATUS LGTS IN OPN.

NOISE SENSITIVE AREA – HELS OPNG WITHIN THE CTZL ARE REQD TO MAINT THE HIGHEST POSSIBLE ALT.

NO RON PARKING FOR NON-TENANT CHARTER AIRCRAFT WITHOUT PRIOR MASSPORT PERMISSION.

PILOTS SHOULD COMPLETE ALL CALCULATIONS PRIOR TO PUSHBACK FROM GATE.

BTN 0000-0600 LCL – RY 15R IS PREFERENTIAL NGT RY FOR TKOF & RY 33L IS PREFERENTIAL NGT RY FOR LNDG.

RWY 14/32 UNIDIRECTIONAL; NO LDGS RWY 14; NO TKOFS RWY 32.

NMRS CRANES ON AND INVOF ARPT.

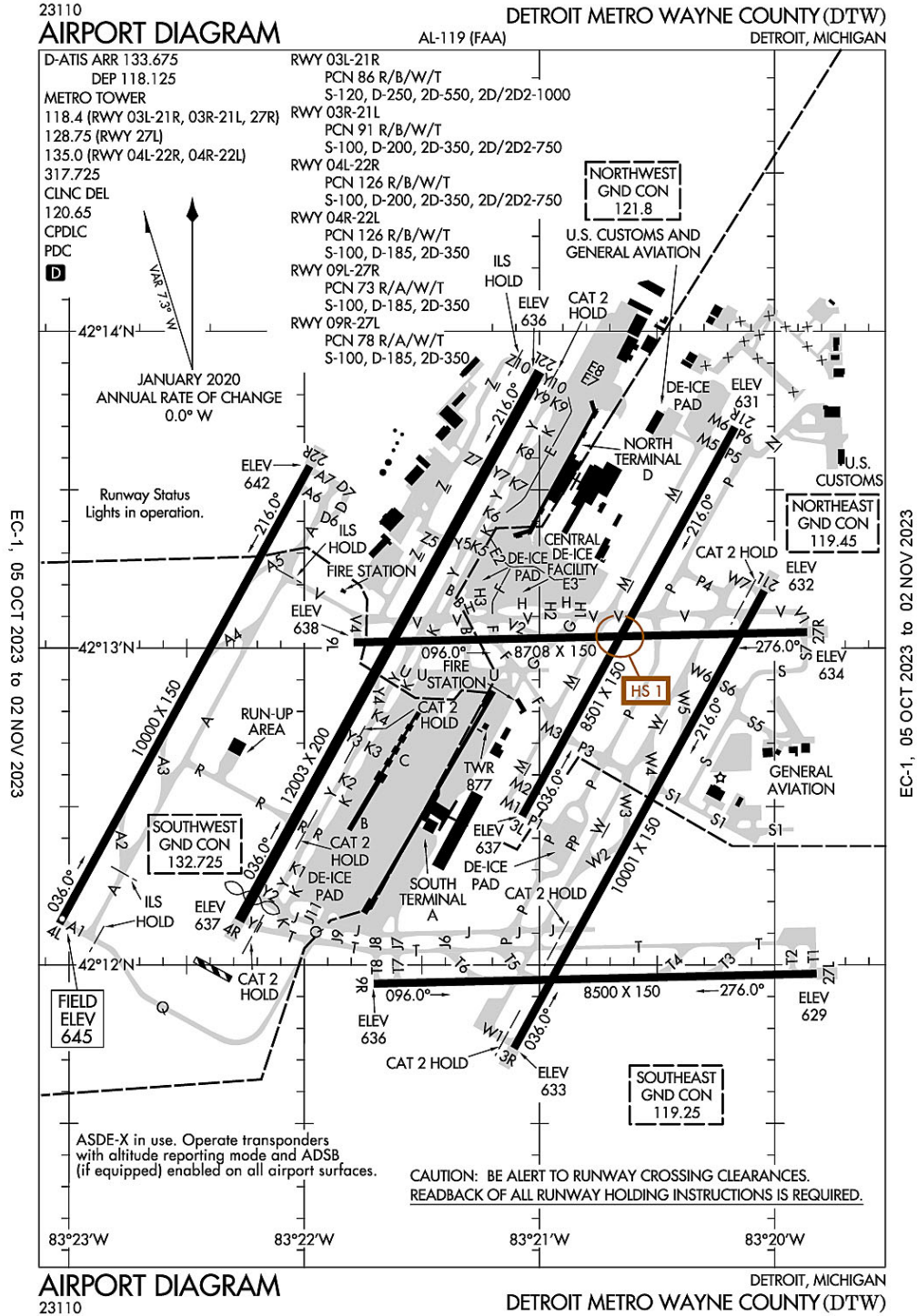
TERMINAL E; NORTH & SOUTH CARGO ARRIVALS CTC MASSPORT GATE CONTROL ON FREQ 131.1 BEFORE ENTERING/DEPARTING RAMP AREA.

FOR NOISE ABATEMENT PROCEDURES CALL 617-561-1636 0900-1700 MON-FRI.

BIRDS ON & INVOF ARPT.

ASDE-X IN USE. OPERATE TRANSPONDERS WITH ALTITUDE REPORTING MODE AND ADS-B (IF EQUIPPED) ENABLED ON ALL AIRPORT SURFACES.

### Detroit, Michigan Detroit Metropolitan Wayne County ICAO Identifier KDTW



**Detroit, MI**  
**Detroit Metropolitan Wayne County**  
**ICAO Identifier KDTW**

**AD 2.2 Aerodrome geographical and administrative data**

- 2.2.1 Reference Point: 42-12-44.752N / 83-21-12.216W
- 2.2.2 From City: 15 miles S of DETROIT, MI
- 2.2.3 Elevation: 645.2 ft
- 2.2.5 Magnetic Variation: 7W (2020)
- 2.2.6 Airport Contact: CHAD NEWTON  
11050 ROGELL DR #602  
DETROIT, MI 48242 (734-942-3685)
- 2.2.7 Traffic: IFR/VFR

**AD 2.3 Attendance Schedule**

- 2.3.1 All Months, All Days, All Hours

**AD 2.4 Handling Services and Facilities**

- 2.4.1 Cargo Handling Facilities: YES
- 2.4.2 Fuel Types: 100LL,A
- 2.4.5 Hangar Space: YES
- 2.4.6 Repair Facilities: NONE

**AD 2.6 Rescue and Firefighting Services**

- 2.6.1 Aerodrome Category: Class-I certified on 5/1/1973
- 2.6.2 Rescue and Firefighting Services: ARFF Index-E

**AD 2.12 Runway Physical Characteristics**

- 2.12.1 Designation: 03L
- 2.12.2 True Bearing: 29
- 2.12.3 Dimensions: 8501 ft x 150 ft
- 2.12.4 PCN: 86 R/B/W/T
- 2.12.5 Coordinates: 42-12-28.2081N / 83-21-4.3881W
- 2.12.6 Threshold Elevation: 636.5 ft
- 2.12.6 Touchdown Zone Elevation: 636.9 ft

- 2.12.1 Designation: 21R
- 2.12.2 True Bearing: 209
- 2.12.3 Dimensions: 8501 ft x 150 ft
- 2.12.4 PCN: 86 R/B/W/T
- 2.12.5 Coordinates: 42-13-41.8586N / 83-20-10.107W
- 2.12.6 Threshold Elevation: 631.4 ft
- 2.12.6 Touchdown Zone Elevation: 634.5 ft

- 2.12.1 Designation: 03R
- 2.12.2 True Bearing: 29
- 2.12.3 Dimensions: 10001 ft x 150 ft
- 2.12.4 PCN: 91 R/B/W/T
- 2.12.5 Coordinates: 42-11-44.2115N / 83-21-6.4868W
- 2.12.6 Threshold Elevation: 632.8 ft
- 2.12.6 Touchdown Zone Elevation: 633.1 ft

2.12.1 Designation: 21L  
2.12.2 True Bearing: 209  
2.12.3 Dimensions: 10001 ft x 150 ft  
2.12.4 PCN: 91 R/B/W/T  
2.12.5 Coordinates: 42-13-10.8552N / 83-20-2.6517W  
2.12.6 Threshold Elevation: 631.8 ft  
2.12.6 Touchdown Zone Elevation: 632.3 ft

2.12.1 Designation: 04L  
2.12.2 True Bearing: 29  
2.12.3 Dimensions: 10000 ft x 150 ft  
2.12.4 PCN: 126 R/B/W/T  
2.12.5 Coordinates: 42-12-7.8216N / 83-23-2.4003W  
2.12.6 Threshold Elevation: 645.2 ft  
2.12.6 Touchdown Zone Elevation: 645.2 ft

2.12.1 Designation: 22R  
2.12.2 True Bearing: 209  
2.12.3 Dimensions: 10000 ft x 150 ft  
2.12.4 PCN: 126 R/B/W/T  
2.12.5 Coordinates: 42-13-34.4821N / 83-21-58.6115W  
2.12.6 Threshold Elevation: 642.1 ft  
2.12.6 Touchdown Zone Elevation: 642.1 ft

2.12.1 Designation: 22L  
2.12.2 True Bearing: 209  
2.12.3 Dimensions: 12003 ft x 200 ft  
2.12.4 PCN: 126 R/B/W/T  
2.12.5 Coordinates: 42-13-52.3644N / 83-20-59.9655W  
2.12.6 Threshold Elevation: 635.8 ft  
2.12.6 Touchdown Zone Elevation: 637.4 ft

2.12.1 Designation: 04R  
2.12.2 True Bearing: 29  
2.12.3 Dimensions: 12003 ft x 200 ft  
2.12.4 PCN: 126 R/B/W/T  
2.12.5 Coordinates: 42-12-8.3656N / 83-22-16.5697W  
2.12.6 Threshold Elevation: 637 ft  
2.12.6 Touchdown Zone Elevation: 639.5 ft

2.12.1 Designation: 22X  
2.12.2 True Bearing: 209  
2.12.3 Dimensions: 0 ft x 0 ft  
2.12.4 PCN:  
2.12.5 Coordinates: -- / --  
2.12.6 Threshold Elevation: ft  
2.12.6 Touchdown Zone Elevation: ft

2.12.1 Designation: 04X  
2.12.2 True Bearing: 29

2.12.3 Dimensions: 0 ft x 0 ft  
2.12.4 PCN:  
2.12.5 Coordinates: -- / --  
2.12.6 Threshold Elevation: ft  
2.12.6 Touchdown Zone Elevation: ft

2.12.1 Designation: 09L  
2.12.2 True Bearing: 89  
2.12.3 Dimensions: 8708 ft x 150 ft  
2.12.4 PCN: 73 R/A/W/T  
2.12.5 Coordinates: 42-13-1.0821N / 83-21-47.4044W  
2.12.6 Threshold Elevation: 638 ft  
2.12.6 Touchdown Zone Elevation: 639.6 ft

2.12.1 Designation: 27R  
2.12.2 True Bearing: 269  
2.12.3 Dimensions: 8708 ft x 150 ft  
2.12.4 PCN: 73 R/A/W/T  
2.12.5 Coordinates: 42-13-3.0219N / 83-19-51.7146W  
2.12.6 Threshold Elevation: 634.3 ft  
2.12.6 Touchdown Zone Elevation: 634.7 ft

2.12.1 Designation: 09R  
2.12.2 True Bearing: 89  
2.12.3 Dimensions: 8500 ft x 150 ft  
2.12.4 PCN: 78 R/A/W/T  
2.12.5 Coordinates: 42-11-56.4542N / 83-21-42.2248W  
2.12.6 Threshold Elevation: 636 ft  
2.12.6 Touchdown Zone Elevation: 636.1 ft

2.12.1 Designation: 27L  
2.12.2 True Bearing: 269  
2.12.3 Dimensions: 8500 ft x 150 ft  
2.12.4 PCN: 78 R/A/W/T  
2.12.5 Coordinates: 42-11-58.3372N / 83-19-49.3276W  
2.12.6 Threshold Elevation: 629 ft  
2.12.6 Touchdown Zone Elevation: 630.1 ft

### **AD 2.13 Declared Distances**

2.13.1 Designation: 03L  
2.13.2 Take-off Run Available: 8501  
2.13.3 Take-off Distance Available: 8501  
2.13.4 Accelerate-Stop Distance Available: 8501  
2.13.5 Landing Distance Available: 8501

2.13.1 Designation: 21R  
2.13.2 Take-off Run Available: 8501  
2.13.3 Take-off Distance Available: 8501  
2.13.4 Accelerate-Stop Distance Available: 8501  
2.13.5 Landing Distance Available: 8501



2.13.1 Designation: 03R  
2.13.2 Take-off Run Available: 10001  
2.13.3 Take-off Distance Available: 10001  
2.13.4 Accelerate-Stop Distance Available: 10001  
2.13.5 Landing Distance Available: 10001

2.13.1 Designation: 21L  
2.13.2 Take-off Run Available: 10001  
2.13.3 Take-off Distance Available: 10001  
2.13.4 Accelerate-Stop Distance Available: 10001  
2.13.5 Landing Distance Available: 10001

2.13.1 Designation: 04L  
2.13.2 Take-off Run Available: 10000  
2.13.3 Take-off Distance Available: 10000  
2.13.4 Accelerate-Stop Distance Available: 10000  
2.13.5 Landing Distance Available: 10000

2.13.1 Designation: 22R  
2.13.2 Take-off Run Available: 10000  
2.13.3 Take-off Distance Available: 10000  
2.13.4 Accelerate-Stop Distance Available: 10000  
2.13.5 Landing Distance Available: 10000

2.13.1 Designation: 22L  
2.13.2 Take-off Run Available: 12003  
2.13.3 Take-off Distance Available: 12003  
2.13.4 Accelerate-Stop Distance Available: 12003  
2.13.5 Landing Distance Available: 12003

2.13.1 Designation: 04R  
2.13.2 Take-off Run Available: 12003  
2.13.3 Take-off Distance Available: 12003  
2.13.4 Accelerate-Stop Distance Available: 12003  
2.13.5 Landing Distance Available: 11494

2.13.1 Designation: 22X  
2.13.2 Take-off Run Available:  
2.13.3 Take-off Distance Available:  
2.13.4 Accelerate-Stop Distance Available:  
2.13.5 Landing Distance Available:

2.13.1 Designation: 04X  
2.13.2 Take-off Run Available:  
2.13.3 Take-off Distance Available:  
2.13.4 Accelerate-Stop Distance Available:  
2.13.5 Landing Distance Available:

2.13.1 Designation: 09L  
2.13.2 Take-off Run Available: 8708

2.13.3 Take-off Distance Available: 8708  
2.13.4 Accelerate-Stop Distance Available: 8618  
2.13.5 Landing Distance Available: 8618

2.13.1 Designation: 27R  
2.13.2 Take-off Run Available: 8708  
2.13.3 Take-off Distance Available: 8708  
2.13.4 Accelerate-Stop Distance Available: 8708  
2.13.5 Landing Distance Available: 8708

2.13.1 Designation: 09R  
2.13.2 Take-off Run Available: 8500  
2.13.3 Take-off Distance Available: 8500  
2.13.4 Accelerate-Stop Distance Available: 8500  
2.13.5 Landing Distance Available: 8500

2.13.1 Designation: 27L  
2.13.2 Take-off Run Available: 8500  
2.13.3 Take-off Distance Available: 8500  
2.13.4 Accelerate-Stop Distance Available: 8500  
2.13.5 Landing Distance Available: 8500

**AD 2.14 Approach and Runway Lighting**

2.14.1 Designation: 03L  
2.14.2 Approach Lighting System:  
2.14.4 Visual Approach Slope Indicator System: P4R

2.14.1 Designation: 21R  
2.14.2 Approach Lighting System:  
2.14.4 Visual Approach Slope Indicator System: P4L

2.14.1 Designation: 03R  
2.14.2 Approach Lighting System: ALSF2  
2.14.4 Visual Approach Slope Indicator System: P4R

2.14.1 Designation: 21L  
2.14.2 Approach Lighting System: MALSR  
2.14.4 Visual Approach Slope Indicator System: P4L

2.14.1 Designation: 04L  
2.14.2 Approach Lighting System: ALSF2  
2.14.4 Visual Approach Slope Indicator System: P4L

2.14.1 Designation: 22R  
2.14.2 Approach Lighting System: MALSR  
2.14.4 Visual Approach Slope Indicator System: P4R

2.14.1 Designation: 22L  
2.14.2 Approach Lighting System: MALSR  
2.14.4 Visual Approach Slope Indicator System:

2.14.1 Designation: 04R  
2.14.2 Approach Lighting System: ALSF2  
2.14.4 Visual Approach Slope Indicator System:

2.14.1 Designation: 22X  
2.14.2 Approach Lighting System:  
2.14.4 Visual Approach Slope Indicator System:

2.14.1 Designation: 04X  
2.14.2 Approach Lighting System:  
2.14.4 Visual Approach Slope Indicator System:

2.14.1 Designation: 09L  
2.14.2 Approach Lighting System:  
2.14.4 Visual Approach Slope Indicator System:

2.14.1 Designation: 27R  
2.14.2 Approach Lighting System: MALSR  
2.14.4 Visual Approach Slope Indicator System: P4L

2.14.1 Designation: 09R  
2.14.2 Approach Lighting System:  
2.14.4 Visual Approach Slope Indicator System:

2.14.1 Designation: 27L  
2.14.2 Approach Lighting System: MALSR  
2.14.4 Visual Approach Slope Indicator System: P4L

### **AD 2.18 Air Traffic Services Communication Facilities**

2.18.1 Service Designation: CD PRE TAXI CLNC  
2.18.3 Channel: 120.65  
2.18.5 Hours of Operation: 24

2.18.1 Service Designation: D-ATIS (DEP)  
2.18.3 Channel: 118.125  
2.18.5 Hours of Operation: 24

2.18.1 Service Designation: D-ATIS (ARR)  
2.18.3 Channel: 133.675  
2.18.5 Hours of Operation: 24

2.18.1 Service Designation: EMERG  
2.18.3 Channel: 121.5  
2.18.5 Hours of Operation:

2.18.1 Service Designation: EMERG  
2.18.3 Channel: 243  
2.18.5 Hours of Operation:

2.18.1 Service Designation: GND/P (SOUTHEAST)  
2.18.3 Channel: 119.25  
2.18.5 Hours of Operation: 24

2.18.1 Service Designation: GND/P (NORTHEAST)  
2.18.3 Channel: 119.45  
2.18.5 Hours of Operation: 24

2.18.1 Service Designation: GND/P (NORTHWEST)  
2.18.3 Channel: 121.8  
2.18.5 Hours of Operation: 24

2.18.1 Service Designation: GND/P (SOUTHWEST)  
2.18.3 Channel: 132.725  
2.18.5 Hours of Operation: 24

2.18.1 Service Designation: LCL/P (ARRIVAL RWY 03R/21L, 27R)  
2.18.3 Channel: 118.4  
2.18.5 Hours of Operation: 24

2.18.1 Service Designation: LCL/P (DEP, ARPT DIAG RWY 03L/21R, 03R/21L, 27R)  
2.18.3 Channel: 118.4  
2.18.5 Hours of Operation: 24

2.18.1 Service Designation: LCL/P (ARRIVAL RWY 04R/22L)  
2.18.3 Channel: 128.125  
2.18.5 Hours of Operation: 24

2.18.1 Service Designation: LCL/P (DEP, ARPT DIAG RWY 27L)  
2.18.3 Channel: 128.75  
2.18.5 Hours of Operation: 24

2.18.1 Service Designation: LCL/P (ARRIVAL RWY 03L/21R, 27L)  
2.18.3 Channel: 128.75  
2.18.5 Hours of Operation: 24

2.18.1 Service Designation: LCL/P (ARRIVAL RWY 04L/22R)  
2.18.3 Channel: 135  
2.18.5 Hours of Operation: 24

2.18.1 Service Designation: LCL/P (DEP, ARPT DIAG RWY 04L/22R, 04R/22L)  
2.18.3 Channel: 135  
2.18.5 Hours of Operation: 24

2.18.1 Service Designation: LCL/P  
2.18.3 Channel: 317.725  
2.18.5 Hours of Operation: 24

2.18.1 Service Designation: MEDEVAC  
2.18.3 Channel: 259.6  
2.18.5 Hours of Operation:

**AD 2.19 Radio Navigation and Landing Aids**

2.19.1 ILS Type: DME for runway 03R. Magnetic variation: 7W

2.19.2 ILS Identification: HUU

2.19.5 Coordinates: 42-11-34.2185N / 83-21-9.5792W

2.19.6 Site Elevation: 638.7 ft

2.19.1 ILS Type: Glide Slope for runway 03R. Magnetic variation: 7W

2.19.2 ILS Identification: HUU

2.19.5 Coordinates: 42-11-51.1266N / 83-20-54.979W

2.19.6 Site Elevation: 630.1 ft

2.19.1 ILS Type: Inner Marker for runway 03R. Magnetic variation: 7W

2.19.2 ILS Identification: HUU

2.19.5 Coordinates: 42-11-36.5551N / 83-21-12.137W

2.19.6 Site Elevation: 631.1 ft

2.19.1 ILS Type: Localizer for runway 03R. Magnetic variation: 7W

2.19.2 ILS Identification: HUU

2.19.5 Coordinates: 42-13-20.4082N / 83-19-55.609W

2.19.6 Site Elevation: 634 ft

2.19.1 ILS Type: DME for runway 21L. Magnetic variation: 7W

2.19.2 ILS Identification: EJR

2.19.5 Coordinates: 42-11-34.2185N / 83-21-9.5792W

2.19.6 Site Elevation: 638.7 ft

2.19.1 ILS Type: Glide Slope for runway 21L. Magnetic variation: 7W

2.19.2 ILS Identification: EJR

2.19.5 Coordinates: 42-12-58.4945N / 83-20-5.1867W

2.19.6 Site Elevation: 628.9 ft

2.19.1 ILS Type: Localizer for runway 21L. Magnetic variation: 7W

2.19.2 ILS Identification: EJR

2.19.5 Coordinates: 42-11-34.9459N / 83-21-13.3158W

2.19.6 Site Elevation: 631.1 ft

2.19.1 ILS Type: DME for runway 04L. Magnetic variation: 7W

2.19.2 ILS Identification: HJT

2.19.5 Coordinates: 42-13-41.8988N / 83-21-48.7254W

2.19.6 Site Elevation: 649.7 ft

2.19.1 ILS Type: Glide Slope for runway 04L. Magnetic variation: 7W

2.19.2 ILS Identification: HJT

2.19.5 Coordinates: 42-12-18.9498N / 83-23-0.2665W

2.19.6 Site Elevation: 640.6 ft

2.19.1 ILS Type: Inner Marker for runway 04L. Magnetic variation: 7W

2.19.2 ILS Identification: HJT

2.19.5 Coordinates: 42-12-0.3838N / 83-23-7.8811W

2.19.6 Site Elevation: 645.2 ft

2.19.1 ILS Type: Localizer for runway 04L. Magnetic variation: 7W  
2.19.2 ILS Identification: HJT  
2.19.5 Coordinates: 42-13-43.2279N / 83-21-52.161W  
2.19.6 Site Elevation: 642 ft

2.19.1 ILS Type: DME for runway 22R. Magnetic variation: 7W  
2.19.2 ILS Identification: JKI  
2.19.5 Coordinates: 42-13-41.8988N / 83-21-48.7254W  
2.19.6 Site Elevation: 649.7 ft

2.19.1 ILS Type: Glide Slope for runway 22R. Magnetic variation: 7W  
2.19.2 ILS Identification: JKI  
2.19.5 Coordinates: 42-13-27.2272N / 83-22-10.0062W  
2.19.6 Site Elevation: 636.7 ft

2.19.1 ILS Type: Localizer for runway 22R. Magnetic variation: 7W  
2.19.2 ILS Identification: JKI  
2.19.5 Coordinates: 42-11-59.0707N / 83-23-8.842W  
2.19.6 Site Elevation: 644.6 ft

2.19.1 ILS Type: DME for runway 04R. Magnetic variation: 7W  
2.19.2 ILS Identification: DTW  
2.19.5 Coordinates: 42-13-59.7252N / 83-20-50.3339W  
2.19.6 Site Elevation: 645.3 ft

2.19.1 ILS Type: Glide Slope for runway 04R. Magnetic variation: 7W  
2.19.2 ILS Identification: DTW  
2.19.5 Coordinates: 42-12-23.21N / 83-22-11.85W  
2.19.6 Site Elevation: 633.1 ft

2.19.1 ILS Type: Inner Marker for runway 04R. Magnetic variation: 7W  
2.19.2 ILS Identification: DTW  
2.19.5 Coordinates: 42-12-4.547N / 83-22-19.3737W  
2.19.6 Site Elevation: 637.1 ft

2.19.1 ILS Type: Localizer for runway 04R. Magnetic variation: 7W  
2.19.2 ILS Identification: DTW  
2.19.5 Coordinates: 42-14-1.3028N / 83-20-53.3772W  
2.19.6 Site Elevation: 636.5 ft

2.19.1 ILS Type: DME for runway 22L. Magnetic variation: 7W  
2.19.2 ILS Identification: DWC  
2.19.5 Coordinates: 42-13-59.7252N / 83-20-50.3339W  
2.19.6 Site Elevation: 645.3 ft

2.19.1 ILS Type: Glide Slope for runway 22L. Magnetic variation: 7W  
2.19.2 ILS Identification: DWC  
2.19.5 Coordinates: 42-13-43.8552N / 83-21-12.2894W  
2.19.6 Site Elevation: 635.6 ft

2.19.1 ILS Type: Localizer for runway 22L. Magnetic variation: 7W  
2.19.2 ILS Identification: DWC  
2.19.5 Coordinates: 42-11-59.5406N / 83-22-23.0644W  
2.19.6 Site Elevation: 636.1 ft

2.19.1 ILS Type: DME for runway 04X. Magnetic variation: 7W  
2.19.2 ILS Identification: ALA  
2.19.5 Coordinates: 42-11-57.1056N / 83-23-6.1821W  
2.19.6 Site Elevation: 656.6 ft

2.19.1 ILS Type: Glide Slope for runway 04X. Magnetic variation: 7W  
2.19.2 ILS Identification: ALA  
2.19.5 Coordinates: 42-12-19.0378N / 83-23-0.5079W  
2.19.6 Site Elevation: 640.7 ft

2.19.1 ILS Type: Localizer for runway 04X. Magnetic variation: 7W  
2.19.2 ILS Identification: ALA  
2.19.5 Coordinates: 42-13-33.4002N / 83-21-50.9401W  
2.19.6 Site Elevation: 638.5 ft

2.19.1 ILS Type: DME for runway 22X. Magnetic variation: 7W  
2.19.2 ILS Identification: BZB  
2.19.5 Coordinates: 42-11-57.1056N / 83-23-6.1821W  
2.19.6 Site Elevation: 656.6 ft

2.19.1 ILS Type: Glide Slope for runway 22X. Magnetic variation: 7W  
2.19.2 ILS Identification: BZB  
2.19.5 Coordinates: 42-13-27.3517N / 83-22-10.3013W  
2.19.6 Site Elevation: 636.8 ft

2.19.1 ILS Type: Localizer for runway 22X. Magnetic variation: 7W  
2.19.2 ILS Identification: BZB  
2.19.5 Coordinates: 42-11-56.2259N / 83-23-1.9618W  
2.19.6 Site Elevation: 646.3 ft

2.19.1 ILS Type: Glide Slope for runway 27R. Magnetic variation: 7W  
2.19.2 ILS Identification: DMI  
2.19.5 Coordinates: 42-12-58.3552N / 83-20-4.8574W  
2.19.6 Site Elevation: 629 ft

2.19.1 ILS Type: Localizer for runway 27R. Magnetic variation: 7W  
2.19.2 ILS Identification: DMI  
2.19.5 Coordinates: 42-13-0.7158N / 83-22-9.2988W  
2.19.6 Site Elevation: 639.3 ft

2.19.1 ILS Type: DME for runway 27L. Magnetic variation: 7W  
2.19.2 ILS Identification: EPA  
2.19.5 Coordinates: 42-11-53.6723N / 83-21-55.0763W  
2.19.6 Site Elevation: 645.8 ft

2.19.1 ILS Type: Glide Slope for runway 27L. Magnetic variation: 7W  
2.19.2 ILS Identification: EPA  
2.19.5 Coordinates: 42-11-54.6653N / 83-20-2.5117W  
2.19.6 Site Elevation: 625.9 ft

2.19.1 ILS Type: Localizer for runway 27L. Magnetic variation: 7W  
2.19.2 ILS Identification: EPA  
2.19.5 Coordinates: 42-11-56.2294N / 83-21-55.6348W  
2.19.6 Site Elevation: 634.1 ft

**General Remarks:**

BRIGHTLY LIGHTED PARKING LOT 2.6 NM SW OF ARPT.

RWY VISUAL SCREEN 20 FT AGL 1150 FT S. AER 04R

TURNING RESTRICTION TWY B TO TWY K RESTRICTED TO AIRCRAFT WITH WINGSPAN 171 FT OR LESS.

ASDE-X IN USE. OPERATE TRANSPONDERS WITH ALTITUDE REPORTING MODE AND ADS-B (IF EQUIPPED) ENABLED ON ALL AIRPORT SURFACES.

PPR FOR B747-8 OPRS DUE TO CONSTRAINTS ON RWYS, TWYS AND RAMPS CTC AIRFIELD OPRS AT 734-942-3685.

TAXI ON RWY 09L/27R LTD TO: EXITING FM RWY 04R/22L, 03L/21R, & 03R/21L EXC NO TAXI BTN RWY 03L/21R & TWY W; TWO-WAY TAXI BTN TWY Y & TWY M WHEN RED STOP BAR LGTS ARE LGTD AT RWY 04R/22L & 03L/21R OR WHEN BARRICADES ARE USED INSTEAD AT THE RESPECTIVE INTS. TAXI BTN SS-SR OR IN CONDS WITH VIS LESS THAN 1 SM RQRS GREEN CNTRLN LGT TO BE OPR.

BE ALERT BIRDS, WATERFOWL, ON & INVOF ARPT.

RY STATUS LGTS ARE IN OPN.

ACFT WITH WINGSPAN GTR THAN 171 FT ARE RSTRD FM USING TWY P BTN TWY J & TWY P3.

TURNING RSTRD TO WINGSPAN 135 FT OR LESS TWY G NORTH TO TWY V EAST.

ACFT WITH WINGSPAN GTR THAN 171 FT ARE RSTRD FM USING TWY H BTN TWY B & TWY F.

AIRCRAFT WITH WINGSPAN GREATER THAN 171 FT CANNOT PASS EACH OTHER ON TWYS Y AND K BETWEEN TWYS U AND K6 INSUFFICIENT WINGTIP CLEARANCE.

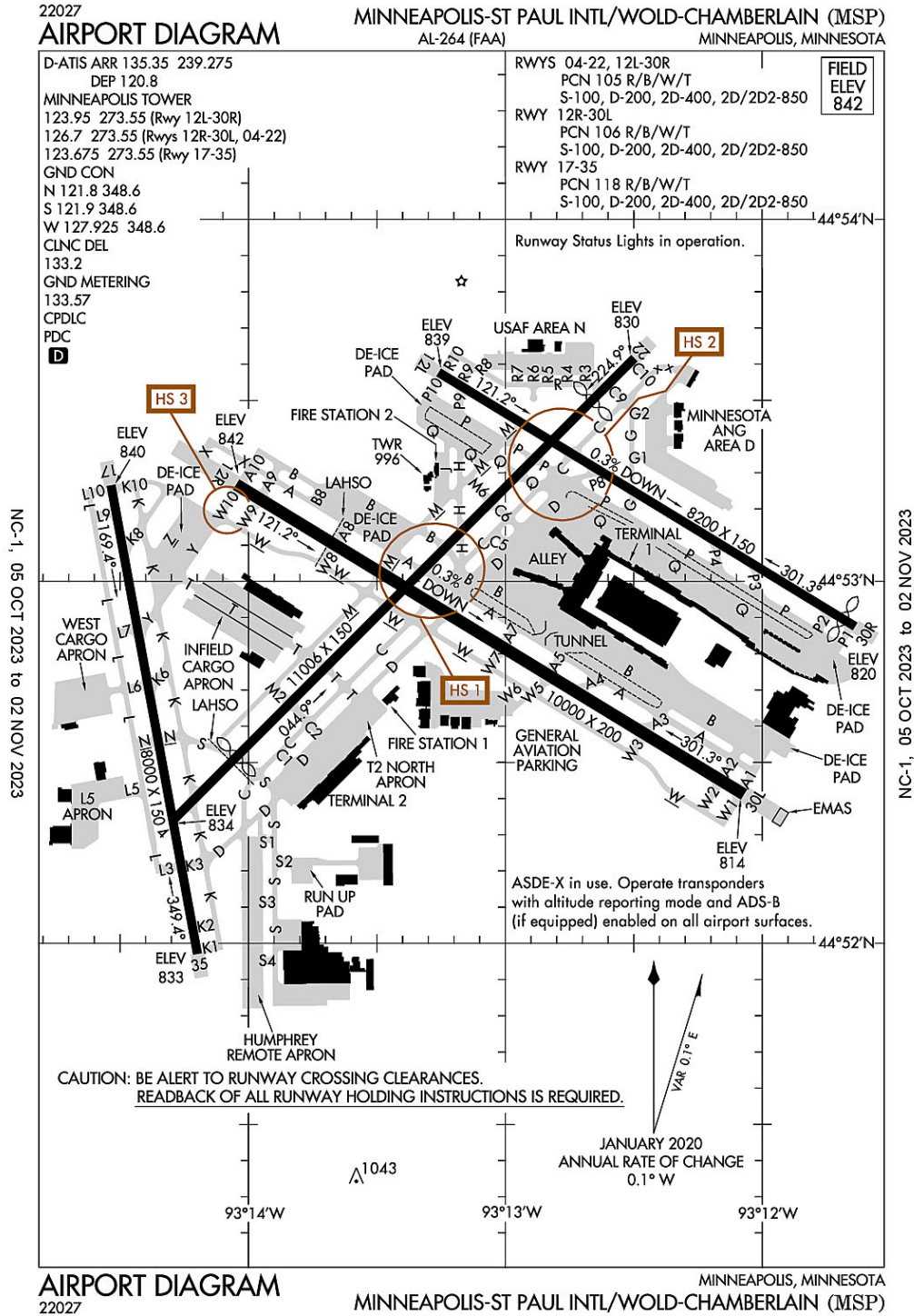
ACFT ON TWY 'F' AND TWY 'V' DO NOT BLOCK FIRE STATION EXITS.

DIVERSIONAIR CARRIERS WITHOUT A PRESENCE AT DTW SHOULD CTC AIRFIELD OPRS 734-942-3685 PRIOR TO DIVERTING TO THE EXTENT PRACTICAL AND PROVIDE COMPANY, FLT OPRS, CTC INFO, AIRCRAFT TYPE, PERSONS ONBOARD, INTERNATIONAL OR DOMESTIC, ANY GRND HANDLER AGREEMENTS IN PLACE.

AUTH TO CONDUCT SIMUL INDEPENDENT INSTR APCHS TO PARL RWY 04L/22R & 03R/21L WO FINAL MONITORS, RWY CNTRLNS SEPARATED BY 8800 FT.



**Minneapolis, Minnesota**  
**Minneapolis-St. Paul International (Wold-Chamberlain)**  
**ICAO Identifier KMSP**



**Minneapolis, MN**  
**Minneapolis–St Paul Intl/Wold–Chamberlain**  
**ICAO Identifier KMSP**

**AD 2.2 Aerodrome geographical and administrative data**

- 2.2.1 Reference Point: 44–52–55.1N / 93–13–18.4W
- 2.2.2 From City: 6 miles S of MINNEAPOLIS, MN
- 2.2.3 Elevation: 841.8 ft
- 2.2.5 Magnetic Variation: 0E (2015)
- 2.2.6 Airport Contact: BRIAN RYKS  
6040 28TH AVE S  
MINNEAPOLIS, MN 55450 (612–726–8100)
- 2.2.7 Traffic: IFR/VFR

**AD 2.3 Attendance Schedule**

- 2.3.1 All Months, All Days, All Hours

**AD 2.4 Handling Services and Facilities**

- 2.4.1 Cargo Handling Facilities: YES
- 2.4.2 Fuel Types: 100LL,A,A++
- 2.4.5 Hangar Space: YES
- 2.4.6 Repair Facilities: MAJOR

**AD 2.6 Rescue and Firefighting Services**

- 2.6.1 Aerodrome Category: Class–I certified on 5/1/1973
- 2.6.2 Rescue and Firefighting Services: ARFF Index–E

**AD 2.12 Runway Physical Characteristics**

- 2.12.1 Designation: 04
- 2.12.2 True Bearing: 45
- 2.12.3 Dimensions: 11006 ft x 150 ft
- 2.12.4 PCN: 105 R/B/W/T
- 2.12.5 Coordinates: 44–52–20.158N / 93–14–17.9427W
- 2.12.6 Threshold Elevation: 833.5 ft
- 2.12.6 Touchdown Zone Elevation: 831.7 ft
  
- 2.12.1 Designation: 22
- 2.12.2 True Bearing: 225
- 2.12.3 Dimensions: 11006 ft x 150 ft
- 2.12.4 PCN: 105 R/B/W/T
- 2.12.5 Coordinates: 44–53–36.9917N / 93–12–29.8434W
- 2.12.6 Threshold Elevation: 830.3 ft
- 2.12.6 Touchdown Zone Elevation: 828.3 ft
  
- 2.12.1 Designation: 30R
- 2.12.2 True Bearing: 301
- 2.12.3 Dimensions: 8200 ft x 150 ft
- 2.12.4 PCN: 105 R/B/W/T
- 2.12.5 Coordinates: 44–52–52.5152N / 93–11–38.296W
- 2.12.6 Threshold Elevation: 819.5 ft
- 2.12.6 Touchdown Zone Elevation: 822.4 ft

2.12.1 Designation: 12L  
2.12.2 True Bearing: 121  
2.12.3 Dimensions: 8200 ft x 150 ft  
2.12.4 PCN: 105 R/B/W/T  
2.12.5 Coordinates: 44-53-34.6287N / 93-13-15.5666W  
2.12.6 Threshold Elevation: 838.6 ft  
2.12.6 Touchdown Zone Elevation: 840.7 ft

2.12.1 Designation: 12R  
2.12.2 True Bearing: 121  
2.12.3 Dimensions: 10000 ft x 200 ft  
2.12.4 PCN: 106 R/B/W/T  
2.12.5 Coordinates: 44-53-16.0438N / 93-14-2.8731W  
2.12.6 Threshold Elevation: 841.8 ft  
2.12.6 Touchdown Zone Elevation: 841.8 ft

2.12.1 Designation: 30L  
2.12.2 True Bearing: 301  
2.12.3 Dimensions: 10000 ft x 200 ft  
2.12.4 PCN: 106 R/B/W/T  
2.12.5 Coordinates: 44-52-24.68N / 93-12-4.2689W  
2.12.6 Threshold Elevation: 814.4 ft  
2.12.6 Touchdown Zone Elevation: 823 ft

2.12.1 Designation: 17  
2.12.2 True Bearing: 170  
2.12.3 Dimensions: 8000 ft x 150 ft  
2.12.4 PCN: 118 R/B/W/T  
2.12.5 Coordinates: 44-53-15.9127N / 93-14-32.1137W  
2.12.6 Threshold Elevation: 840.4 ft  
2.12.6 Touchdown Zone Elevation: 840.4 ft

2.12.1 Designation: 35  
2.12.2 True Bearing: 350  
2.12.3 Dimensions: 8000 ft x 150 ft  
2.12.4 PCN: 118 R/B/W/T  
2.12.5 Coordinates: 44-51-58.2366N / 93-14-11.9205W  
2.12.6 Threshold Elevation: 833.3 ft  
2.12.6 Touchdown Zone Elevation: 834.4 ft

#### **AD 2.13 Declared Distances**

2.13.1 Designation: 04  
2.13.2 Take-off Run Available: 11006  
2.13.3 Take-off Distance Available: 11006  
2.13.4 Accelerate-Stop Distance Available: 11006  
2.13.5 Landing Distance Available: 9456

2.13.1 Designation: 22  
2.13.2 Take-off Run Available: 11006

2.13.3 Take-off Distance Available: 11006  
2.13.4 Accelerate-Stop Distance Available: 11006  
2.13.5 Landing Distance Available: 10006

2.13.1 Designation: 30R  
2.13.2 Take-off Run Available: 8200  
2.13.3 Take-off Distance Available: 8200  
2.13.4 Accelerate-Stop Distance Available: 8200  
2.13.5 Landing Distance Available: 8000

2.13.1 Designation: 12L  
2.13.2 Take-off Run Available: 8200  
2.13.3 Take-off Distance Available: 8200  
2.13.4 Accelerate-Stop Distance Available: 7620  
2.13.5 Landing Distance Available: 7620

2.13.1 Designation: 12R  
2.13.2 Take-off Run Available: 10000  
2.13.3 Take-off Distance Available: 10000  
2.13.4 Accelerate-Stop Distance Available: 10000  
2.13.5 Landing Distance Available: 10000

2.13.1 Designation: 30L  
2.13.2 Take-off Run Available: 10000  
2.13.3 Take-off Distance Available: 10000  
2.13.4 Accelerate-Stop Distance Available: 10000  
2.13.5 Landing Distance Available: 10000

2.13.1 Designation: 17  
2.13.2 Take-off Run Available: 8000  
2.13.3 Take-off Distance Available: 8000  
2.13.4 Accelerate-Stop Distance Available: 8000  
2.13.5 Landing Distance Available: 8000

2.13.1 Designation: 35  
2.13.2 Take-off Run Available: 8000  
2.13.3 Take-off Distance Available: 8000  
2.13.4 Accelerate-Stop Distance Available: 8000  
2.13.5 Landing Distance Available: 8000

#### **AD 2.14 Approach and Runway Lighting**

2.14.1 Designation: 04  
2.14.2 Approach Lighting System: MALSR  
2.14.4 Visual Approach Slope Indicator System: P4L

2.14.1 Designation: 22  
2.14.2 Approach Lighting System: MALSR  
2.14.4 Visual Approach Slope Indicator System: P4L

2.14.1 Designation: 30R

2.14.2 Approach Lighting System: MALSF  
2.14.4 Visual Approach Slope Indicator System: P4L

2.14.1 Designation: 12L  
2.14.2 Approach Lighting System: ALSF2  
2.14.4 Visual Approach Slope Indicator System: P4L

2.14.1 Designation: 12R  
2.14.2 Approach Lighting System: ALSF2  
2.14.4 Visual Approach Slope Indicator System: P4L

2.14.1 Designation: 30L  
2.14.2 Approach Lighting System: ALSF2  
2.14.4 Visual Approach Slope Indicator System: P4L

2.14.1 Designation: 17  
2.14.2 Approach Lighting System:  
2.14.4 Visual Approach Slope Indicator System: P4R

2.14.1 Designation: 35  
2.14.2 Approach Lighting System: ALSF2  
2.14.4 Visual Approach Slope Indicator System: P4L

**AD 2.18 Air Traffic Services Communication Facilities**

2.18.1 Service Designation: CD PRE TAXI CLNC  
2.18.3 Channel: 133.2  
2.18.5 Hours of Operation: 24

2.18.1 Service Designation: D-ATIS (DEP)  
2.18.3 Channel: 120.8  
2.18.5 Hours of Operation: 24

2.18.1 Service Designation: D-ATIS (ARR)  
2.18.3 Channel: 135.35  
2.18.5 Hours of Operation: 24

2.18.1 Service Designation: D-ATIS (ARR)  
2.18.3 Channel: 239.275  
2.18.5 Hours of Operation: 24

2.18.1 Service Designation: EMERG  
2.18.3 Channel: 121.5  
2.18.5 Hours of Operation:

2.18.1 Service Designation: EMERG  
2.18.3 Channel: 243  
2.18.5 Hours of Operation:

2.18.1 Service Designation: GND METERING  
2.18.3 Channel: 133.575

2.18.5 Hours of Operation: 24

2.18.1 Service Designation: GND/P (N)

2.18.3 Channel: 121.8

2.18.5 Hours of Operation: 24

2.18.1 Service Designation: GND/P (S)

2.18.3 Channel: 121.9

2.18.5 Hours of Operation: 24

2.18.1 Service Designation: GND/P (W)

2.18.3 Channel: 127.925

2.18.5 Hours of Operation: 24

2.18.1 Service Designation: GND/P

2.18.3 Channel: 348.6

2.18.5 Hours of Operation: 24

2.18.1 Service Designation: LCL/P (RWY 17/35)

2.18.3 Channel: 123.675

2.18.5 Hours of Operation: 24

2.18.1 Service Designation: LCL/P (RWY 12L/30R)

2.18.3 Channel: 123.95

2.18.5 Hours of Operation: 24

2.18.1 Service Designation: LCL/P (RWY 04/22, 12R/30L)

2.18.3 Channel: 126.7

2.18.5 Hours of Operation: 24

2.18.1 Service Designation: LCL/P

2.18.3 Channel: 273.55

2.18.5 Hours of Operation: 24

2.18.1 Service Designation: PTD

2.18.3 Channel: 282.675

2.18.5 Hours of Operation:

2.18.1 Service Designation: PTD

2.18.3 Channel: 324.1

2.18.5 Hours of Operation:

### **AD 2.19 Radio Navigation and Landing Aids**

2.19.1 ILS Type: Localizer for runway 04. Magnetic variation: 0E

2.19.2 ILS Identification: APL

2.19.5 Coordinates: 44-53-44.0038N / 93-12-19.9688W

2.19.6 Site Elevation: 832.1 ft

2.19.1 ILS Type: Localizer for runway 22. Magnetic variation: 0E

2.19.2 ILS Identification: SIJ

2.19.5 Coordinates: 44-52-12.792N / 93-14-28.3006W

2.19.6 Site Elevation: 831.4 ft

2.19.1 ILS Type: DME for runway 12L. Magnetic variation: 0E

2.19.2 ILS Identification: PJJ

2.19.5 Coordinates: 44-53-3.674N / 93-11-48.8687W

2.19.6 Site Elevation: 824 ft

2.19.1 ILS Type: Glide Slope for runway 12L. Magnetic variation: 0E

2.19.2 ILS Identification: PJJ

2.19.5 Coordinates: 44-53-31.1153N / 93-12-56.6941W

2.19.6 Site Elevation: 831 ft

2.19.1 ILS Type: Inner Marker for runway 12L. Magnetic variation: 0E

2.19.2 ILS Identification: PJJ

2.19.5 Coordinates: 44-53-39.694N / 93-13-25.8963W

2.19.6 Site Elevation: 845.3 ft

2.19.1 ILS Type: Localizer for runway 12L. Magnetic variation: 0E

2.19.2 ILS Identification: PJJ

2.19.5 Coordinates: 44-52-50.3312N / 93-11-33.2418W

2.19.6 Site Elevation: 813 ft

2.19.1 ILS Type: DME for runway 30R. Magnetic variation: 0E

2.19.2 ILS Identification: INN

2.19.5 Coordinates: 44-53-3.674N / 93-11-48.8687W

2.19.6 Site Elevation: 824 ft

2.19.1 ILS Type: Glide Slope for runway 30R. Magnetic variation: 0E

2.19.2 ILS Identification: INN

2.19.5 Coordinates: 44-53-3.4471N / 93-11-48.8472W

2.19.6 Site Elevation: 813.2 ft

2.19.1 ILS Type: Localizer for runway 30R. Magnetic variation: 0E

2.19.2 ILS Identification: INN

2.19.5 Coordinates: 44-53-40.841N / 93-13-29.92W

2.19.6 Site Elevation: 843.1 ft

2.19.1 ILS Type: DME for runway 12R. Magnetic variation: 0E

2.19.2 ILS Identification: HKZ

2.19.5 Coordinates: 44-52-26.9244N / 93-12-20.5476W

2.19.6 Site Elevation: 825.4 ft

2.19.1 ILS Type: Glide Slope for runway 12R. Magnetic variation: 0E

2.19.2 ILS Identification: HKZ

2.19.5 Coordinates: 44-53-7.28N / 93-13-53.62W

2.19.6 Site Elevation: 835.1 ft

2.19.1 ILS Type: Inner Marker for runway 12R. Magnetic variation: 0E

2.19.2 ILS Identification: HKZ

2.19.5 Coordinates: 44-53-20.8698N / 93-14-12.7019W

2.19.6 Site Elevation: 840 ft

2.19.1 ILS Type: Localizer for runway 12R. Magnetic variation: 0E  
2.19.2 ILS Identification: HKZ  
2.19.5 Coordinates: 44-52-20.3796N / 93-11-54.3455W  
2.19.6 Site Elevation: 812.8 ft

2.19.1 ILS Type: DME for runway 30L. Magnetic variation: 0E  
2.19.2 ILS Identification: MSP  
2.19.5 Coordinates: 44-52-26.9244N / 93-12-20.5476W  
2.19.6 Site Elevation: 825.4 ft

2.19.1 ILS Type: Glide Slope for runway 30L. Magnetic variation: 0E  
2.19.2 ILS Identification: MSP  
2.19.5 Coordinates: 44-52-27.0021N / 93-12-20.2067W  
2.19.6 Site Elevation: 812.1 ft

2.19.1 ILS Type: Inner Marker for runway 30L. Magnetic variation: 0E  
2.19.2 ILS Identification: MSP  
2.19.5 Coordinates: 44-52-19.4377N / 93-11-52.1826W  
2.19.6 Site Elevation: 808.1 ft

2.19.1 ILS Type: Localizer for runway 30L. Magnetic variation: 0E  
2.19.2 ILS Identification: MSP  
2.19.5 Coordinates: 44-53-22.4589N / 93-14-17.688W  
2.19.6 Site Elevation: 840 ft

2.19.1 ILS Type: DME for runway 17. Magnetic variation: 0E  
2.19.2 ILS Identification: TJZ  
2.19.5 Coordinates: 44-53-24.6166N / 93-14-38.0356W  
2.19.6 Site Elevation: 832.5 ft

2.19.1 ILS Type: Localizer for runway 17. Magnetic variation: 0E  
2.19.2 ILS Identification: TJZ  
2.19.5 Coordinates: 44-51-48.4327N / 93-14-9.3727W  
2.19.6 Site Elevation: 830.4 ft

2.19.1 ILS Type: DME for runway 35. Magnetic variation: 0E  
2.19.2 ILS Identification: BMA  
2.19.5 Coordinates: 44-53-24.6166N / 93-14-38.0356W  
2.19.6 Site Elevation: 832.5 ft

2.19.1 ILS Type: Glide Slope for runway 35. Magnetic variation: 0E  
2.19.2 ILS Identification: BMA  
2.19.5 Coordinates: 44-52-7.7086N / 93-14-20.1127W  
2.19.6 Site Elevation: 829.9 ft

2.19.1 ILS Type: Inner Marker for runway 35. Magnetic variation: 0E  
2.19.2 ILS Identification: BMA  
2.19.5 Coordinates: 44-51-49.9075N / 93-14-9.7433W  
2.19.6 Site Elevation: 832.6 ft



2.19.1 ILS Type: Localizer for runway 35. Magnetic variation: 0E  
2.19.2 ILS Identification: BMA  
2.19.5 Coordinates: 44-53-25.7158N / 93-14-34.6512W  
2.19.6 Site Elevation: 845.3 ft

2.19.1 Navigation Aid Type: VOR/DME. Magnetic variation: 2E  
2.19.2 Navigation Aid Identification: MSP  
2.19.5 Coordinates: 44-53-47.3958N / 93-14-11.5137W  
2.19.6 Site Elevation: 831.6 ft

**General Remarks:**

NOISE ABATEMENT PROCEDURES – 612-726-9411. NO STAGE 1 CAT CIVIL ACFT. NIGHT HR 2230-0600.

TRNG FLTS PROHIBITED. GA FLTS MUST TRMT AT THE FBO OR US CUSTOMS UNLESS APVD BY AMGR.

MILITARY RSTD: NO HAZ CL/DIV1.1 OR 1.2 EXPLOSIVES PERMITTED. LOADING OR UNLOADING OF HAZ CL/DIV 1.3, 1.4, 1.5 OR 1.6 MUST BE APV BY ARPT DRCT PRIOR TO FLT.

ASDE-X IN USE; OPR TRANSPONDERS WITH ALT RPRT MODE & ADS-B ENABLED ON ALL ARPT SFCS.

RWY STATUS LGTS IN OPRN.

133 AW AFLD MGMT – 324.1 REMARKS: CALL LIGHTHOUSE.

REMARKS: ALL ACFT MUST CTC NORTHSTAR ON FREQ 252.1 20 MIN PRIOR ARR.

UNSKED ACFT AT TRML 2-HUMPHREY REQ TO CTC TRML 2 GATE CONTROL ON 122.95 OR CALL 612-726-5742 PRIOR TO ARR.

SIGNATURE FLIGHT SUPPORT 128.95

MILITARY: ARFC 934 AW OPS 1300-0400Z++ MON-THUR, 1300-2200Z++ FRI, CLSD WKEND AND FEDERAL HOL. UNIT TRNG ASSEMBLY (UTA) WKEND 1330-2200Z++. ALL TRANS ACFT MUST RECEIVE PPR 48 HR PRIOR TO ETA – CTC AIRFIELD MGMT.

COMMUNICATIONS: MINNEAPOLIS AIR RESERVE STATION JOINT COMD POST – 252.1 REMARKS: CALL NORTHSTAR.

ALL GROUP VI ACFT WITH WINGSPAN GREATER THAN 214 FT PPR REQ PRIOR TO ARR – CTC AIRSIDE OPS 612-726-5111.

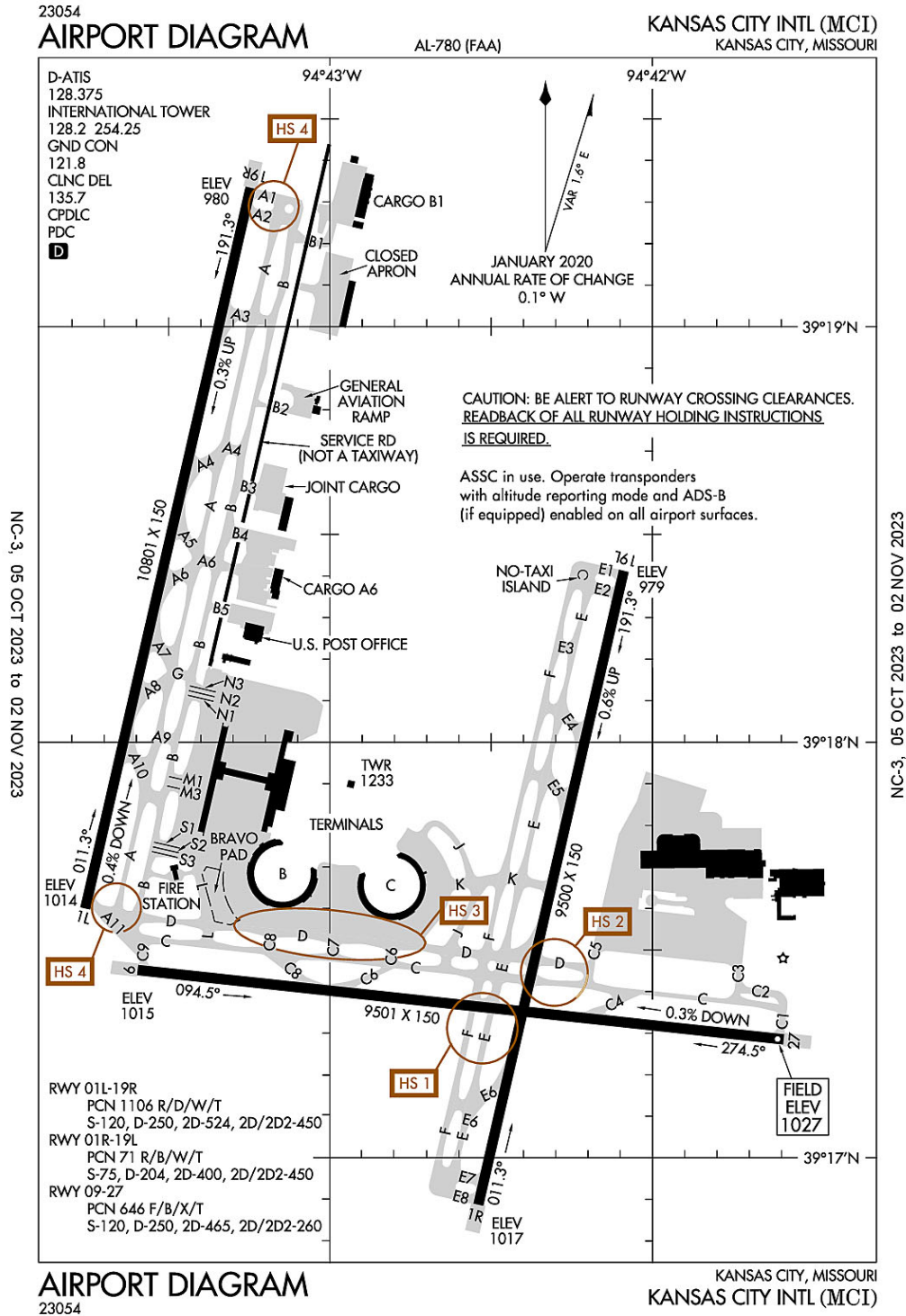
934 AW AFLD MGMT – PTD 282.675 REMARKS: CALL VIKING OPS.

BIRDS ON & INVOF ARPT.

ALL GROUP IV AND LRGR ACFT OPRG ON THE PTN OF TWY S ADJ TO DELTA BLDG C RQR THE USE OF WINGWALKERS AND THAT THE VEHICLE SVC ROAD BE CLEAR OF VEHICLES.

ALL GA ACFT WITH LESS THAN 20 PAX THAT NEED TO CLEAR US CUSTOMS SHOULD CTC SIGNATURE FLT SUPPORT 128.95 OR 612-726-5700 PRIOR TO ARR.

### Kansas City, Missouri Kansas City International ICAO Identifier KMCI



**Kansas City, MO**  
**Kansas City Intl**  
**ICAO Identifier KMCI**

**AD 2.2 Aerodrome geographical and administrative data**

- 2.2.1 Reference Point: 39-17-51.4N / 94-42-50W
- 2.2.2 From City: 15 miles NW of KANSAS CITY, MO
- 2.2.3 Elevation: 1026.9 ft
- 2.2.5 Magnetic Variation: 2E (2015)
- 2.2.6 Airport Contact: MR. LUKE MAWHIRTER  
P.O. BOX 20047  
KANSAS CITY, MO 64195 (816-243-5248)
- 2.2.7 Traffic: IFR/VFR

**AD 2.3 Attendance Schedule**

- 2.3.1 All Months, All Days, All Hours

**AD 2.4 Handling Services and Facilities**

- 2.4.1 Cargo Handling Facilities: YES
- 2.4.2 Fuel Types: 100LL,A
- 2.4.5 Hangar Space:
- 2.4.6 Repair Facilities: NONE

**AD 2.6 Rescue and Firefighting Services**

- 2.6.1 Aerodrome Category: Class-I certified on 5/1/1973
- 2.6.2 Rescue and Firefighting Services: ARFF Index-C

**AD 2.12 Runway Physical Characteristics**

- 2.12.1 Designation: 01L
- 2.12.2 True Bearing: 13
- 2.12.3 Dimensions: 10801 ft x 150 ft
- 2.12.4 PCN:
- 2.12.5 Coordinates: 39-17-36.0029N / 94-43-45.5433W
- 2.12.6 Threshold Elevation: 1014.4 ft
- 2.12.6 Touchdown Zone Elevation: 1014.4 ft

- 2.12.1 Designation: 19R
- 2.12.2 True Bearing: 193
- 2.12.3 Dimensions: 10801 ft x 150 ft
- 2.12.4 PCN:
- 2.12.5 Coordinates: 39-19-20.0396N / 94-43-14.7835W
- 2.12.6 Threshold Elevation: 979.6 ft
- 2.12.6 Touchdown Zone Elevation: 990.5 ft

- 2.12.1 Designation: 19L
- 2.12.2 True Bearing: 193
- 2.12.3 Dimensions: 9500 ft x 150 ft
- 2.12.4 PCN: 71 R/B/W/T
- 2.12.5 Coordinates: 39-18-24.7369N / 94-42-5.3226W
- 2.12.6 Threshold Elevation: 978.5 ft
- 2.12.6 Touchdown Zone Elevation: 995.2 ft

2.12.1 Designation: 01R  
2.12.2 True Bearing: 13  
2.12.3 Dimensions: 9500 ft x 150 ft  
2.12.4 PCN: 71 R/B/W/T  
2.12.5 Coordinates: 39-16-53.2341N / 94-42-32.3935W  
2.12.6 Threshold Elevation: 1017.2 ft  
2.12.6 Touchdown Zone Elevation: 1017.4 ft

2.12.1 Designation: 27  
2.12.2 True Bearing: 276  
2.12.3 Dimensions: 9501 ft x 150 ft  
2.12.4 PCN:  
2.12.5 Coordinates: 39-17-17.0716N / 94-41-35.5978W  
2.12.6 Threshold Elevation: 1026.9 ft  
2.12.6 Touchdown Zone Elevation: 1026.9 ft

2.12.1 Designation: 09  
2.12.2 True Bearing: 96  
2.12.3 Dimensions: 9501 ft x 150 ft  
2.12.4 PCN:  
2.12.5 Coordinates: 39-17-27.099N / 94-43-35.7371W  
2.12.6 Threshold Elevation: 1015.3 ft  
2.12.6 Touchdown Zone Elevation: 1015.7 ft

#### **AD 2.13 Declared Distances**

2.13.1 Designation: 01L  
2.13.2 Take-off Run Available: 10801  
2.13.3 Take-off Distance Available: 10801  
2.13.4 Accelerate-Stop Distance Available: 10801  
2.13.5 Landing Distance Available: 10801

2.13.1 Designation: 19R  
2.13.2 Take-off Run Available: 10801  
2.13.3 Take-off Distance Available: 10801  
2.13.4 Accelerate-Stop Distance Available: 10801  
2.13.5 Landing Distance Available: 10801

2.13.1 Designation: 19L  
2.13.2 Take-off Run Available: 9500  
2.13.3 Take-off Distance Available: 9500  
2.13.4 Accelerate-Stop Distance Available: 9500  
2.13.5 Landing Distance Available: 9500

2.13.1 Designation: 01R  
2.13.2 Take-off Run Available: 9500  
2.13.3 Take-off Distance Available: 9500  
2.13.4 Accelerate-Stop Distance Available: 9500  
2.13.5 Landing Distance Available: 9500

2.13.1 Designation: 27  
2.13.2 Take-off Run Available: 9501  
2.13.3 Take-off Distance Available: 9501  
2.13.4 Accelerate-Stop Distance Available: 9501  
2.13.5 Landing Distance Available: 9501

2.13.1 Designation: 09  
2.13.2 Take-off Run Available: 9501  
2.13.3 Take-off Distance Available: 9501  
2.13.4 Accelerate-Stop Distance Available: 9501  
2.13.5 Landing Distance Available: 9501

**AD 2.14 Approach and Runway Lighting**

2.14.1 Designation: 01L  
2.14.2 Approach Lighting System: MALSR  
2.14.4 Visual Approach Slope Indicator System: P4L

2.14.1 Designation: 19R  
2.14.2 Approach Lighting System: ALSF2  
2.14.4 Visual Approach Slope Indicator System: P4R

2.14.1 Designation: 19L  
2.14.2 Approach Lighting System: MALSR  
2.14.4 Visual Approach Slope Indicator System:

2.14.1 Designation: 01R  
2.14.2 Approach Lighting System: ALSF2  
2.14.4 Visual Approach Slope Indicator System: P4R

2.14.1 Designation: 27  
2.14.2 Approach Lighting System: MALSR  
2.14.4 Visual Approach Slope Indicator System: P4L

2.14.1 Designation: 09  
2.14.2 Approach Lighting System: MALSR  
2.14.4 Visual Approach Slope Indicator System:

**AD 2.18 Air Traffic Services Communication Facilities**

2.18.1 Service Designation: APCH/P  
2.18.3 Channel: 120.95  
2.18.5 Hours of Operation: 24

2.18.1 Service Designation: APCH/P  
2.18.3 Channel: 318.1  
2.18.5 Hours of Operation: 24

2.18.1 Service Designation: BRAYMER STAR  
2.18.3 Channel: 120.95  
2.18.5 Hours of Operation: 24

2.18.1 Service Designation: BRAYMER STAR  
2.18.3 Channel: 318.1  
2.18.5 Hours of Operation: 24

2.18.1 Service Designation: CD/P  
2.18.3 Channel: 135.7  
2.18.5 Hours of Operation: 24

2.18.1 Service Designation: CHIEF DP  
2.18.3 Channel: 124.7  
2.18.5 Hours of Operation: 24

2.18.1 Service Designation: CHIEF DP  
2.18.3 Channel: 284.7  
2.18.5 Hours of Operation: 24

2.18.1 Service Designation: CLASS B (EAST OF RWY 01/19)  
2.18.3 Channel: 118.4  
2.18.5 Hours of Operation: 24

2.18.1 Service Designation: CLASS B (S OF A LINE FROM LWC ARPT TO 3GV ARPT)  
2.18.3 Channel: 118.9  
2.18.5 Hours of Operation: 24

2.18.1 Service Designation: CLASS B (WEST OF RWY 01/19)  
2.18.3 Channel: 124.7  
2.18.5 Hours of Operation: 24

2.18.1 Service Designation: CLASS B (EAST OF RWY 01-19)  
2.18.3 Channel: 294.7  
2.18.5 Hours of Operation: 24

2.18.1 Service Designation: CLASS B (S OF A LINE FROM LWC ARPT TO 3GV ARPT)  
2.18.3 Channel: 294.7  
2.18.5 Hours of Operation: 24

2.18.1 Service Designation: CLASS B (WEST OF RWY 01/19)  
2.18.3 Channel: 318.1  
2.18.5 Hours of Operation: 24

2.18.1 Service Designation: D-ATIS  
2.18.3 Channel: 128.375  
2.18.5 Hours of Operation: 24

2.18.1 Service Designation: DEP/P (010-190)  
2.18.3 Channel: 123.95  
2.18.5 Hours of Operation: 24

2.18.1 Service Designation: DEP/P (191-009)  
2.18.3 Channel: 124.7

2.18.5 Hours of Operation: 24

2.18.1 Service Designation: DEP/P (191-009)

2.18.3 Channel: 284.7

2.18.5 Hours of Operation: 24

2.18.1 Service Designation: DEP/P (010-190)

2.18.3 Channel: 318.1

2.18.5 Hours of Operation: 24

2.18.1 Service Designation: EMERG

2.18.3 Channel: 121.5

2.18.5 Hours of Operation:

2.18.1 Service Designation: EMERG

2.18.3 Channel: 243

2.18.5 Hours of Operation:

2.18.1 Service Designation: GND/P

2.18.3 Channel: 121.8

2.18.5 Hours of Operation: 24

2.18.1 Service Designation: GND/S

2.18.3 Channel: 121.65

2.18.5 Hours of Operation: 24

2.18.1 Service Designation: JHAWK STAR

2.18.3 Channel: 120.95

2.18.5 Hours of Operation: 24

2.18.1 Service Designation: JHAWK STAR

2.18.3 Channel: 318.1

2.18.5 Hours of Operation: 24

2.18.1 Service Designation: LAKES DP

2.18.3 Channel: 123.95

2.18.5 Hours of Operation: 24

2.18.1 Service Designation: LAKES DP

2.18.3 Channel: 318.1

2.18.5 Hours of Operation: 24

2.18.1 Service Designation: LCL/P

2.18.3 Channel: 128.2

2.18.5 Hours of Operation: 24

2.18.1 Service Designation: LCL/P

2.18.3 Channel: 254.25

2.18.5 Hours of Operation: 24

2.18.1 Service Designation: LCL/S

2.18.3 Channel: 125.75

2.18.5 Hours of Operation: 24

2.18.1 Service Designation: RACER DP (BUTLER/SPRINGFIELD TRANSITION)

2.18.3 Channel: 123.95

2.18.5 Hours of Operation: 24

2.18.1 Service Designation: RACER DP (DOSOA TRANSITION)

2.18.3 Channel: 124.7

2.18.5 Hours of Operation: 24

2.18.1 Service Designation: RACER DP (DOSOA TRANSITION)

2.18.3 Channel: 284.7

2.18.5 Hours of Operation: 24

2.18.1 Service Designation: RACER DP (BUTLER/SPRINGFIELD TRANSITION)

2.18.3 Channel: 318.1

2.18.5 Hours of Operation: 24

2.18.1 Service Designation: ROYAL DP (ARENZ/BODYN TRANSITION)

2.18.3 Channel: 123.95

2.18.5 Hours of Operation: 24

2.18.1 Service Designation: ROYAL DP (TONCE TRANSITION)

2.18.3 Channel: 124.7

2.18.5 Hours of Operation: 24

2.18.1 Service Designation: ROYAL DP (TONCE TRANSITION)

2.18.3 Channel: 284.7

2.18.5 Hours of Operation: 24

2.18.1 Service Designation: ROYAL DP (ARENZ/BODYN TRANSITION)

2.18.3 Channel: 318.1

2.18.5 Hours of Operation: 24

2.18.1 Service Designation: TIFTO DP

2.18.3 Channel: 124.7

2.18.5 Hours of Operation: 24

2.18.1 Service Designation: TIFTO DP

2.18.3 Channel: 284.7

2.18.5 Hours of Operation: 24

2.18.1 Service Designation: TYGER STAR

2.18.3 Channel: 120.95

2.18.5 Hours of Operation: 24

2.18.1 Service Designation: TYGER STAR

2.18.3 Channel: 318.1

2.18.5 Hours of Operation: 24



2.18.1 Service Designation: WILDCAT DP  
2.18.3 Channel: 124.7  
2.18.5 Hours of Operation: 24

2.18.1 Service Designation: WILDCAT DP  
2.18.3 Channel: 284.7  
2.18.5 Hours of Operation: 24

**AD 2.19 Radio Navigation and Landing Aids**

2.19.1 ILS Type: DME for runway 01L. Magnetic variation: 2E  
2.19.2 ILS Identification: DOT  
2.19.5 Coordinates: 39-19-30.0746N / 94-43-8.2388W  
2.19.6 Site Elevation: 988.8 ft

2.19.1 ILS Type: Glide Slope for runway 01L. Magnetic variation: 2E  
2.19.2 ILS Identification: DOT  
2.19.5 Coordinates: 39-17-48.2654N / 94-43-47.1321W  
2.19.6 Site Elevation: 1002.8 ft

2.19.1 ILS Type: Localizer for runway 01L. Magnetic variation: 2E  
2.19.2 ILS Identification: DOT  
2.19.5 Coordinates: 39-19-31.1181N / 94-43-11.5232W  
2.19.6 Site Elevation: 972.3 ft

2.19.1 ILS Type: DME for runway 19R. Magnetic variation: 2E  
2.19.2 ILS Identification: PAJ  
2.19.5 Coordinates: 39-17-25.7846N / 94-43-51.9618W  
2.19.6 Site Elevation: 1026 ft

2.19.1 ILS Type: Glide Slope for runway 19R. Magnetic variation: 2E  
2.19.2 ILS Identification: PAJ  
2.19.5 Coordinates: 39-19-11.0536N / 94-43-22.6772W  
2.19.6 Site Elevation: 976.8 ft

2.19.1 ILS Type: Inner Marker for runway 19R. Magnetic variation: 2E  
2.19.2 ILS Identification: PAJ  
2.19.5 Coordinates: 39-19-30.1157N / 94-43-11.8201W  
2.19.6 Site Elevation: 972.4 ft

2.19.1 ILS Type: Localizer for runway 19R. Magnetic variation: 2E  
2.19.2 ILS Identification: PAJ  
2.19.5 Coordinates: 39-17-23.1222N / 94-43-49.3464W  
2.19.6 Site Elevation: 1017.6 ft

2.19.1 ILS Type: Middle Marker for runway 19R. Magnetic variation: 2E  
2.19.2 ILS Identification: PAJ  
2.19.5 Coordinates: 39-19-49.2587N / 94-43-6.2032W  
2.19.6 Site Elevation: 965.1 ft

2.19.1 ILS Type: DME for runway 01R. Magnetic variation: 2E

2.19.2 ILS Identification: PVL  
2.19.5 Coordinates: 39-18-35.6272N / 94-42-5.4664W  
2.19.6 Site Elevation: 960 ft

2.19.1 ILS Type: Glide Slope for runway 01R. Magnetic variation: 2E  
2.19.2 ILS Identification: PVL  
2.19.5 Coordinates: 39-17-3.1905N / 94-42-24.2292W  
2.19.6 Site Elevation: 1010.8 ft

2.19.1 ILS Type: Inner Marker for runway 01R. Magnetic variation: 2E  
2.19.2 ILS Identification: PVL  
2.19.5 Coordinates: 39-16-45.0995N / 94-42-34.8009W  
2.19.6 Site Elevation: 1011.1 ft

2.19.1 ILS Type: Localizer for runway 01R. Magnetic variation: 2E  
2.19.2 ILS Identification: PVL  
2.19.5 Coordinates: 39-18-34.4013N / 94-42-2.4648W  
2.19.6 Site Elevation: 963.3 ft

2.19.1 ILS Type: Middle Marker for runway 01R. Magnetic variation: 2E  
2.19.2 ILS Identification: PVL  
2.19.5 Coordinates: 39-16-27.6318N / 94-42-39.9693W  
2.19.6 Site Elevation: 994.9 ft

2.19.1 ILS Type: DME for runway 19L. Magnetic variation: 2E  
2.19.2 ILS Identification: DYH  
2.19.5 Coordinates: 39-16-43.6236N / 94-42-38.5532W  
2.19.6 Site Elevation: 1017.5 ft

2.19.1 ILS Type: Glide Slope for runway 19L. Magnetic variation: 2E  
2.19.2 ILS Identification: DYH  
2.19.5 Coordinates: 39-18-13.9534N / 94-42-3.2934W  
2.19.6 Site Elevation: 977.9 ft

2.19.1 ILS Type: Localizer for runway 19L. Magnetic variation: 2E  
2.19.2 ILS Identification: DYH  
2.19.5 Coordinates: 39-16-43.575N / 94-42-35.2495W  
2.19.6 Site Elevation: 1011.8 ft

2.19.1 ILS Type: DME for runway 09. Magnetic variation: 2E  
2.19.2 ILS Identification: RNI  
2.19.5 Coordinates: 39-17-18.904N / 94-41-21.7047W  
2.19.6 Site Elevation: 1032.1 ft

2.19.1 ILS Type: Glide Slope for runway 09. Magnetic variation: 2E  
2.19.2 ILS Identification: RNI  
2.19.5 Coordinates: 39-17-21.0763N / 94-43-22.949W  
2.19.6 Site Elevation: 1010.7 ft

2.19.1 ILS Type: Localizer for runway 09. Magnetic variation: 2E  
2.19.2 ILS Identification: RNI

2.19.5 Coordinates: 39-17-16.0109N / 94-41-22.9272W

2.19.6 Site Elevation: 1020.2 ft

2.19.1 ILS Type: DME for runway 27. Magnetic variation: 2E

2.19.2 ILS Identification: UQY

2.19.5 Coordinates: 39-17-25.6745N / 94-43-54.5943W

2.19.6 Site Elevation: 1024.3 ft

2.19.1 ILS Type: Glide Slope for runway 27. Magnetic variation: 2E

2.19.2 ILS Identification: UQY

2.19.5 Coordinates: 39-17-15.7129N / 94-41-50.2717W

2.19.6 Site Elevation: 1021.4 ft

2.19.1 ILS Type: Localizer for runway 27. Magnetic variation: 2E

2.19.2 ILS Identification: UQY

2.19.5 Coordinates: 39-17-28.6283N / 94-43-54.0717W

2.19.6 Site Elevation: 1015.3 ft

2.19.1 Navigation Aid Type: VORTAC. Magnetic variation: 5E

2.19.2 Navigation Aid Identification: MCI

2.19.5 Coordinates: 39-17-7.02N / 94-44-13.42W

2.19.6 Site Elevation: 1017 ft

**General Remarks:**

S RAMP CTL FREQ: 130.825

TXL W, N1, N3, M1, M3, S1, S3 WINGSPAN RESTRICTION OF 118 FT.

PPR TO PARK AT AIRLINE GATES CTC RESPECTIVE AIRLINE.

WHEN USING HIGH-SPEED EXITS C5 & C6 CONTINUE UNTIL FIRST PARALLEL TWY, THEN USE EXTREME CARE WHEN TURNING IN EXCESS OF 90 DEGREES.

NOISE ABATEMENT PROCEDURES IN EFFECT 2200-0600 WITH LANDING ON RYS 01L & 19L; TAKEOFFS ON RYS 01R & 19R.

ASSC IN USE. OPERATE TRANSPONDERS WITH ALTITUDE REPORTING MODE AND ADS-B (IF EQUIPPED) ENABLED ON ALL AIRPORT SURFACES.

DESIGN GROUP V AND VI ACFT RQR AN ARPT ESCORT ON TWY DELTA BTN TWYS JULIET AND LIMA.

NO ACFT PARKING ON POSTAL APRON.

MIL ACFT MAY BE CHARGED RAMP/PARKING FEES.

TWY B1 BTN TWY B AND FEDEX APN COCKPIT OVER CNTRLN STEERING RQRD

N RAMP CTL FREQ: 128.975

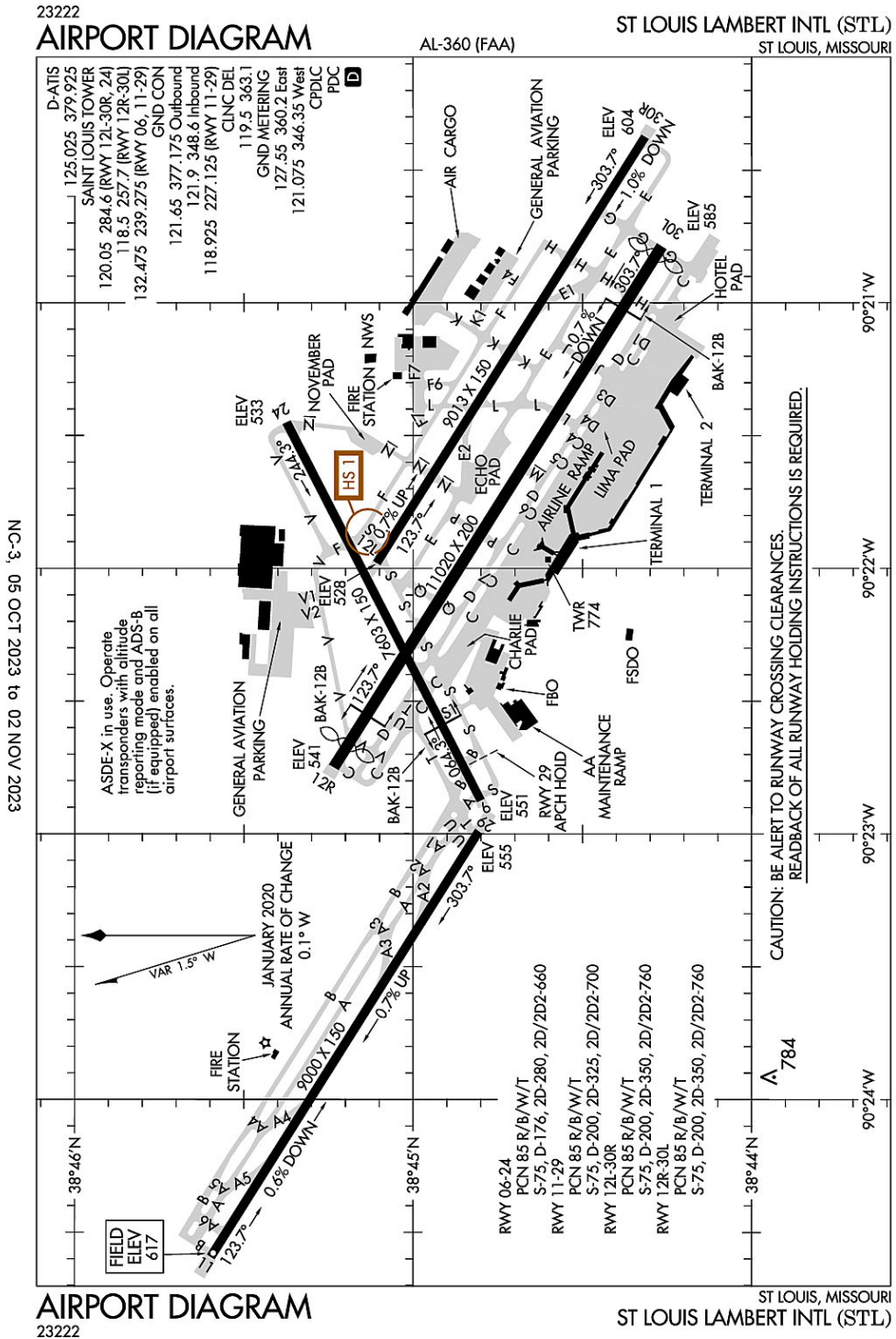
TWY L BTN TWY L1 AND TWY D WINGSPAN RESTRICTION OF 118 FT. TWY C2 BTN TWY C3 AND TWY C1 WINGSPAN RESTRICTION OF 118 FT.

WINDSHEAR ALERT SYSTEM ON ARPT.

WATERFOWL ON AND INVOF ARPT.

FLIGHT NOTIFICATION SVC (ADCUS) AVBL AT GATE 90.

St. Louis, Missouri  
Lambert-St. Louis International  
ICAO Identifier KSTL



**St Louis, MO**  
**Lambert–St Louis Intl**  
**ICAO Identifier KSTL**

**AD 2.2 Aerodrome geographical and administrative data**

- 2.2.1 Reference Point: 38-44-55.3136N / 90-22-12.0926W
- 2.2.2 From City: 10 miles NW of ST LOUIS, MO
- 2.2.3 Elevation: 617.3 ft
- 2.2.5 Magnetic Variation: 1W (2020)
- 2.2.6 Airport Contact: MS. RHONDA HAMM–NIEBRUEGGE  
BOX 10212  
ST LOUIS, MO 63145 (314-426-8000)
- 2.2.7 Traffic: IFR/VFR

**AD 2.3 Attendance Schedule**

- 2.3.1 All Months, All Days, All Hours

**AD 2.4 Handling Services and Facilities**

- 2.4.1 Cargo Handling Facilities: YES
- 2.4.2 Fuel Types: 100LL,A
- 2.4.5 Hangar Space: YES
- 2.4.6 Repair Facilities: MAJOR

**AD 2.6 Rescue and Firefighting Services**

- 2.6.1 Aerodrome Category: Class-I certified on 5/1/1973
- 2.6.2 Rescue and Firefighting Services: ARFF Index-D

**AD 2.12 Runway Physical Characteristics**

- 2.12.1 Designation: 06
- 2.12.2 True Bearing: 63
- 2.12.3 Dimensions: 7603 ft x 150 ft
- 2.12.4 PCN: 85 R/B/W/T
- 2.12.5 Coordinates: 38-44-48.0621N / 90-22-52.3834W
- 2.12.6 Threshold Elevation: 550.6 ft
- 2.12.6 Touchdown Zone Elevation: 550.9 ft
  
- 2.12.1 Designation: 24
- 2.12.2 True Bearing: 243
- 2.12.3 Dimensions: 7603 ft x 150 ft
- 2.12.4 PCN: 85 R/B/W/T
- 2.12.5 Coordinates: 38-45-22.3829N / 90-21-27.014W
- 2.12.6 Threshold Elevation: 533.2 ft
- 2.12.6 Touchdown Zone Elevation: 533.7 ft
  
- 2.12.1 Designation: 11
- 2.12.2 True Bearing: 122
- 2.12.3 Dimensions: 9000 ft x 150 ft
- 2.12.4 PCN: 85 R/B/W/T
- 2.12.5 Coordinates: 38-45-35.8282N / 90-24-35.5403W
- 2.12.6 Threshold Elevation: 616.8 ft
- 2.12.6 Touchdown Zone Elevation: 617.3 ft

2.12.1 Designation: 29  
2.12.2 True Bearing: 302  
2.12.3 Dimensions: 9000 ft x 150 ft  
2.12.4 PCN: 85 R/B/W/T  
2.12.5 Coordinates: 38-44-48.4521N / 90-22-59.3854W  
2.12.6 Threshold Elevation: 555.2 ft  
2.12.6 Touchdown Zone Elevation: 579.6 ft

2.12.1 Designation: 30R  
2.12.2 True Bearing: 302  
2.12.3 Dimensions: 9013 ft x 150 ft  
2.12.4 PCN: 85 R/B/W/T  
2.12.5 Coordinates: 38-44-18.9859N / 90-20-22.5077W  
2.12.6 Threshold Elevation: 604.3 ft  
2.12.6 Touchdown Zone Elevation: 604.5 ft

2.12.1 Designation: 12L  
2.12.2 True Bearing: 122  
2.12.3 Dimensions: 9013 ft x 150 ft  
2.12.4 PCN: 85 R/B/W/T  
2.12.5 Coordinates: 38-45-6.4559N / 90-21-58.7582W  
2.12.6 Threshold Elevation: 527.7 ft  
2.12.6 Touchdown Zone Elevation: 540.6 ft

2.12.1 Designation: 12R  
2.12.2 True Bearing: 122  
2.12.3 Dimensions: 11020 ft x 200 ft  
2.12.4 PCN: 85 R/B/W/T  
2.12.5 Coordinates: 38-45-14.0539N / 90-22-44.9719W  
2.12.6 Threshold Elevation: 541.3 ft  
2.12.6 Touchdown Zone Elevation: 539.7 ft

2.12.1 Designation: 30L  
2.12.2 True Bearing: 302  
2.12.3 Dimensions: 11020 ft x 200 ft  
2.12.4 PCN: 85 R/B/W/T  
2.12.5 Coordinates: 38-44-16.0145N / 90-20-47.272W  
2.12.6 Threshold Elevation: 585.3 ft  
2.12.6 Touchdown Zone Elevation: 582.5 ft

#### **AD 2.13 Declared Distances**

2.13.1 Designation: 06  
2.13.2 Take-off Run Available: 7603  
2.13.3 Take-off Distance Available: 7603  
2.13.4 Accelerate-Stop Distance Available: 7323  
2.13.5 Landing Distance Available: 7323

2.13.1 Designation: 24  
2.13.2 Take-off Run Available: 7603

2.13.3 Take-off Distance Available: 7603  
2.13.4 Accelerate-Stop Distance Available: 7603  
2.13.5 Landing Distance Available: 7603

2.13.1 Designation: 11  
2.13.2 Take-off Run Available: 9000  
2.13.3 Take-off Distance Available: 9000  
2.13.4 Accelerate-Stop Distance Available: 9000  
2.13.5 Landing Distance Available: 9000

2.13.1 Designation: 29  
2.13.2 Take-off Run Available: 9000  
2.13.3 Take-off Distance Available: 9000  
2.13.4 Accelerate-Stop Distance Available: 9000  
2.13.5 Landing Distance Available: 9000

2.13.1 Designation: 30R  
2.13.2 Take-off Run Available: 9013  
2.13.3 Take-off Distance Available: 9013  
2.13.4 Accelerate-Stop Distance Available: 9013  
2.13.5 Landing Distance Available: 9013

2.13.1 Designation: 12L  
2.13.2 Take-off Run Available: 9013  
2.13.3 Take-off Distance Available: 9013  
2.13.4 Accelerate-Stop Distance Available: 8956  
2.13.5 Landing Distance Available: 8956

2.13.1 Designation: 12R  
2.13.2 Take-off Run Available: 11020  
2.13.3 Take-off Distance Available: 11020  
2.13.4 Accelerate-Stop Distance Available: 11020  
2.13.5 Landing Distance Available: 10553

2.13.1 Designation: 30L  
2.13.2 Take-off Run Available: 11020  
2.13.3 Take-off Distance Available: 11020  
2.13.4 Accelerate-Stop Distance Available: 10880  
2.13.5 Landing Distance Available: 10679

**AD 2.14 Approach and Runway Lighting**

2.14.1 Designation: 06  
2.14.2 Approach Lighting System: MALSR  
2.14.4 Visual Approach Slope Indicator System: P4R

2.14.1 Designation: 24  
2.14.2 Approach Lighting System: MALS  
2.14.4 Visual Approach Slope Indicator System: P4L

2.14.1 Designation: 11



2.14.2 Approach Lighting System: ALSF2  
2.14.4 Visual Approach Slope Indicator System: P4R

2.14.1 Designation: 29  
2.14.2 Approach Lighting System: ALSF2  
2.14.4 Visual Approach Slope Indicator System: P4L

2.14.1 Designation: 30R  
2.14.2 Approach Lighting System: ALSF2  
2.14.4 Visual Approach Slope Indicator System: P4R

2.14.1 Designation: 12L  
2.14.2 Approach Lighting System: ALSF2  
2.14.4 Visual Approach Slope Indicator System: P4R

2.14.1 Designation: 12R  
2.14.2 Approach Lighting System: MALSR  
2.14.4 Visual Approach Slope Indicator System: P4L

2.14.1 Designation: 30L  
2.14.2 Approach Lighting System: MALSR  
2.14.4 Visual Approach Slope Indicator System: P4R

**AD 2.18 Air Traffic Services Communication Facilities**

2.18.1 Service Designation: CD/P  
2.18.3 Channel: 119.5  
2.18.5 Hours of Operation: 24

2.18.1 Service Designation: CD/P  
2.18.3 Channel: 363.1  
2.18.5 Hours of Operation: 24

2.18.1 Service Designation: D-ATIS  
2.18.3 Channel: 125.025  
2.18.5 Hours of Operation: 24

2.18.1 Service Designation: D-ATIS  
2.18.3 Channel: 379.925  
2.18.5 Hours of Operation: 24

2.18.1 Service Designation: EMERG  
2.18.3 Channel: 121.5  
2.18.5 Hours of Operation:

2.18.1 Service Designation: EMERG  
2.18.3 Channel: 243  
2.18.5 Hours of Operation:

2.18.1 Service Designation: GND METERING (WEST)  
2.18.3 Channel: 121.075

2.18.5 Hours of Operation: 24

2.18.1 Service Designation: GND METERING (EAST)

2.18.3 Channel: 127.55

2.18.5 Hours of Operation: 24

2.18.1 Service Designation: GND METERING (WEST)

2.18.3 Channel: 346.35

2.18.5 Hours of Operation: 24

2.18.1 Service Designation: GND METERING (EAST)

2.18.3 Channel: 360.2

2.18.5 Hours of Operation: 24

2.18.1 Service Designation: GND/P (RWY 11/29)

2.18.3 Channel: 118.925

2.18.5 Hours of Operation: 24

2.18.1 Service Designation: GND/P (OUTBOUND)

2.18.3 Channel: 121.65

2.18.5 Hours of Operation: 24

2.18.1 Service Designation: GND/P (INBOUND)

2.18.3 Channel: 121.9

2.18.5 Hours of Operation: 24

2.18.1 Service Designation: GND/P (RWY 11/29)

2.18.3 Channel: 227.125

2.18.5 Hours of Operation: 24

2.18.1 Service Designation: GND/P (INBOUND)

2.18.3 Channel: 348.6

2.18.5 Hours of Operation: 24

2.18.1 Service Designation: GND/P (OUTBOUND)

2.18.3 Channel: 377.175

2.18.5 Hours of Operation: 24

2.18.1 Service Designation: LCL/P (RWY 12R/30L)

2.18.3 Channel: 118.5

2.18.5 Hours of Operation: 24

2.18.1 Service Designation: LCL/P (RWY 12L/30R, 24)

2.18.3 Channel: 120.05

2.18.5 Hours of Operation: 24

2.18.1 Service Designation: LCL/P (RWY 06, 11/29)

2.18.3 Channel: 132.475

2.18.5 Hours of Operation: 24

2.18.1 Service Designation: LCL/P (RWY 06, 11/29)

2.18.3 Channel: 239.275  
2.18.5 Hours of Operation: 24

2.18.1 Service Designation: LCL/P (RWY 12R/30L)  
2.18.3 Channel: 257.7  
2.18.5 Hours of Operation: 24

2.18.1 Service Designation: LCL/P (RWY 12L/30R, 24)  
2.18.3 Channel: 284.6  
2.18.5 Hours of Operation: 24

2.18.1 Service Designation: PRM (RWY 30R)  
2.18.3 Channel: 278.3  
2.18.5 Hours of Operation: 24

2.18.1 Service Designation: PRM (RWY 30L)  
2.18.3 Channel: 351.9  
2.18.5 Hours of Operation: 24

#### **AD 2.19 Radio Navigation and Landing Aids**

2.19.1 ILS Type: DME for runway 06. Magnetic variation: 1W  
2.19.2 ILS Identification: JAK  
2.19.5 Coordinates: 38-44-40.533N / 90-22-58.4278W  
2.19.6 Site Elevation: 555.1 ft

2.19.1 ILS Type: Glide Slope for runway 06. Magnetic variation: 1W  
2.19.2 ILS Identification: JAK  
2.19.5 Coordinates: 38-44-54.582N / 90-22-40.1291W  
2.19.6 Site Elevation: 537.6 ft

2.19.1 ILS Type: Localizer for runway 06. Magnetic variation: 1W  
2.19.2 ILS Identification: JAK  
2.19.5 Coordinates: 38-45-27.2803N / 90-21-14.821W  
2.19.6 Site Elevation: 547.5 ft

2.19.1 ILS Type: DME for runway 24. Magnetic variation: 1W  
2.19.2 ILS Identification: STL  
2.19.5 Coordinates: 38-44-40.533N / 90-22-58.4278W  
2.19.6 Site Elevation: 555.1 ft

2.19.1 ILS Type: Glide Slope for runway 24. Magnetic variation: 1W  
2.19.2 ILS Identification: STL  
2.19.5 Coordinates: 38-45-13.5951N / 90-21-37.573W  
2.19.6 Site Elevation: 528.6 ft

2.19.1 ILS Type: Localizer for runway 24. Magnetic variation: 1W  
2.19.2 ILS Identification: STL  
2.19.5 Coordinates: 38-44-43.5036N / 90-23-3.7184W  
2.19.6 Site Elevation: 545.7 ft

2.19.1 ILS Type: DME for runway 11. Magnetic variation: 1W  
2.19.2 ILS Identification: OGZ  
2.19.5 Coordinates: 38-44-36.5929N / 90-22-41.4734W  
2.19.6 Site Elevation: 562.6 ft

2.19.1 ILS Type: Glide Slope for runway 11. Magnetic variation: 1W  
2.19.2 ILS Identification: OGZ  
2.19.5 Coordinates: 38-45-26.0348N / 90-24-25.3788W  
2.19.6 Site Elevation: 598.2 ft

2.19.1 ILS Type: Inner Marker for runway 11. Magnetic variation: 1W  
2.19.2 ILS Identification: OGZ  
2.19.5 Coordinates: 38-45-40.3474N / 90-24-44.7374W  
2.19.6 Site Elevation: 613.3 ft

2.19.1 ILS Type: Localizer for runway 11. Magnetic variation: 1W  
2.19.2 ILS Identification: OGZ  
2.19.5 Coordinates: 38-44-38.7168N / 90-22-39.6283W  
2.19.6 Site Elevation: 544.8 ft

2.19.1 ILS Type: DME for runway 29. Magnetic variation: 1W  
2.19.2 ILS Identification: RQN  
2.19.5 Coordinates: 38-45-43.8773N / 90-24-45.2373W  
2.19.6 Site Elevation: 628 ft

2.19.1 ILS Type: Glide Slope for runway 29. Magnetic variation: 1W  
2.19.2 ILS Identification: RQN  
2.19.5 Coordinates: 38-44-49.8126N / 90-23-11.853W  
2.19.6 Site Elevation: 555.6 ft

2.19.1 ILS Type: Localizer for runway 29. Magnetic variation: 1W  
2.19.2 ILS Identification: RQN  
2.19.5 Coordinates: 38-45-41.3528N / 90-24-46.7635W  
2.19.6 Site Elevation: 612.3 ft

2.19.1 ILS Type: DME for runway 12L. Magnetic variation: 1W  
2.19.2 ILS Identification: LDZ  
2.19.5 Coordinates: 38-44-10.3827N / 90-20-12.0493W  
2.19.6 Site Elevation: 614.1 ft

2.19.1 ILS Type: Glide Slope for runway 12L. Magnetic variation: 1W  
2.19.2 ILS Identification: LDZ  
2.19.5 Coordinates: 38-44-58.2183N / 90-21-50.3412W  
2.19.6 Site Elevation: 533.8 ft

2.19.1 ILS Type: Inner Marker for runway 12L. Magnetic variation: 1W  
2.19.2 ILS Identification: LDZ  
2.19.5 Coordinates: 38-45-11.9417N / 90-22-9.8845W  
2.19.6 Site Elevation: 531.1 ft

2.19.1 ILS Type: Localizer for runway 12L. Magnetic variation: 1W

2.19.2 ILS Identification: LDZ

2.19.5 Coordinates: 38-44-13.6664N / 90-20-11.7277W

2.19.6 Site Elevation: 601.7 ft

2.19.1 ILS Type: DME for runway 30R. Magnetic variation: 1W

2.19.2 ILS Identification: SJW

2.19.5 Coordinates: 38-45-14.1233N / 90-22-7.9077W

2.19.6 Site Elevation: 541 ft

2.19.1 ILS Type: Glide Slope for runway 30R. Magnetic variation: 1W

2.19.2 ILS Identification: SJW

2.19.5 Coordinates: 38-44-21.9637N / 90-20-38.0149W

2.19.6 Site Elevation: 592.5 ft

2.19.1 ILS Type: Inner Marker for runway 30R. Magnetic variation: 1W

2.19.2 ILS Identification: SJW

2.19.5 Coordinates: 38-44-14.6573N / 90-20-13.7268W

2.19.6 Site Elevation: 600.9 ft

2.19.1 ILS Type: Localizer for runway 30R. Magnetic variation: 1W

2.19.2 ILS Identification: SJW

2.19.5 Coordinates: 38-45-12.1188N / 90-22-10.2369W

2.19.6 Site Elevation: 531.7 ft

2.19.1 ILS Type: DME for runway 12R. Magnetic variation: 1W

2.19.2 ILS Identification: LMR

2.19.5 Coordinates: 38-44-7.6656N / 90-20-39.8597W

2.19.6 Site Elevation: 606.5 ft

2.19.1 ILS Type: Glide Slope for runway 12R. Magnetic variation: 1W

2.19.2 ILS Identification: LMR

2.19.5 Coordinates: 38-45-8.9361N / 90-22-24.8753W

2.19.6 Site Elevation: 532 ft

2.19.1 ILS Type: Localizer for runway 12R. Magnetic variation: 1W

2.19.2 ILS Identification: LMR

2.19.5 Coordinates: 38-44-10.2182N / 90-20-35.5392W

2.19.6 Site Elevation: 595.6 ft

2.19.1 ILS Type: Glide Slope for runway 30L. Magnetic variation: 1W

2.19.2 ILS Identification: BKY

2.19.5 Coordinates: 38-44-28.0656N / 90-21-1.7914W

2.19.6 Site Elevation: 564.5 ft

2.19.1 ILS Type: Localizer for runway 30L. Magnetic variation: 1W

2.19.2 ILS Identification: BKY

2.19.5 Coordinates: 38-45-19.3841N / 90-22-55.7958W

2.19.6 Site Elevation: 550.8 ft

2.19.1 Navigation Aid Type: VORTAC. Magnetic variation: 1E

2.19.2 Navigation Aid Identification: STL

2.19.5 Coordinates: 38-51-38.6039N / 90-28-56.456W

2.19.6 Site Elevation: 445.5 ft

**General Remarks:**

TWY DELTA OR TAXILANE CHARLIE FM TWY SIERRA TO TWY GOLF, B-747S ARE NOT AUTH TO PASS OR BE PASSED BY B767 OR OTR LRGR ACFT OPRG ON THE PARL TWY/TAXILANE.

TWY CHARLIE, FM TWY SIERRA TO TWY QUEBEC, RSTRD TO B-767 OR SMLR ACFT (156 FT AVBL) WHEN ACFT ARE PARKED IN THE CHARLIE PAD. RSTRN IS FOR TAX ACFT, LRGR ACFT MAY BE TOWED THRU THE AREA.

TWY CHARLIE, FROM TWY CHARLIE SIX TO TWY DELTA FOUR, RSTRD TO B757-300 SERIES OR SMLR WHEN PASSING BHND ACFT THAT HAVE MADE THE INITIAL 10 FT PUSHBACK.

TWY ALPHA EAST OF TWY TANGO, TWY SIERRA AND RWY 6/24 SOUTH OF TWY BRAVO, NO ACFT OR VEHICLE OPNS WHEN ARRIVING OR DEPG RWY 11 OR ARRIVING RWY 29.

TWY LIMA, NORTH OF RWY 12L/30R, ACFT LRGR THAN A GULFSTREAM VI TAX NBND ARE PROHIBITED FM MAKING A RIGHT TURN EBND ON TWY FOXTROT.

TWY KILO 1 IS UNAVBL TO B-767 OR LRGR ACFT (WINGSPAN 118 FT OR GTR).

TWY ECHO, BTN TWY NOVEMBER AND TWY LIMA RSTRD TO B-767 OR SMLR ACFT (WINGSPAN LESS THAN 171 FT) WHEN ACFT ARE PARKED ON THE ECHO PAD.

TWY CHARLIE, FROM TWY CHARLIE SEVEN TO TWY CHARLIE SIX, RSTRD TO A B757-300 SERIES OR SMLR.

ASDE-X IN USE. OPER TRANSPONDERS WITH ALT REPORTING MODE AND ADS-B (IF EQUIPPED) ENABLED ON ALL ARPT SURFACES.

TWY VICTOR 2 IS UNAVBL TO B-767 OR LRGR ACFT (WINGSPAN 118 FT OR GTR).

WAIVER TO CONDUCT SIMUL APCHS TO PARL RYS SEPARATED BY 1,300 FT IN EFCT.

WG TIP CLNC WITH GND VEH NOT ADQNT ALG N SIDE OF MAIN TRML APN.

TWY NOVEMBER BTN RWY 24 AND FOXTROT, RSTRD TO ACFT WITH A WINGSPAN OF LESS THAN 79 FT (CRJ-900 OR SMLR) WHEN ACFT ARE PARKED ON THE NOVEMBER PAD. THIS AREA IS RSTRD TO ALL OPNS WHEN ACFT ARE PERFORMING END RUN-UPS IN THE NOVEMBER PAD.

TWY VICTOR, UNDERLYING THE RWY 12L FNA CRS, IS RSTRD TO ACFT WITH A TAIL HGT OF 25 FT OR LESS (CRJ-700 OR SMLR) WHEN ACFT ARE LNDG ON RWY 12L.

TWY CHARLIE, FM TWY SIERRA TO TWY CHARLIE SEVEN, RSTRD TO B-767 OR SMLR ACFT (156 FT AVBL) WHEN ACFT ARE PARKED IN THE CHARLIE PAD. RSTRN IS FOR TAX ACFT, LRGR ACFT MAY BE TOWED THRU AREA.

TWY CHARLIE, EAST OF TWY DELTA ONE TO THE AER 30L, RSTRD TO B-737 OR SMLR ACFT (WINGSPAN LESS THAN 118 FT) WHEN ACFT ARE PARKED ON THE HOTEL PAD.

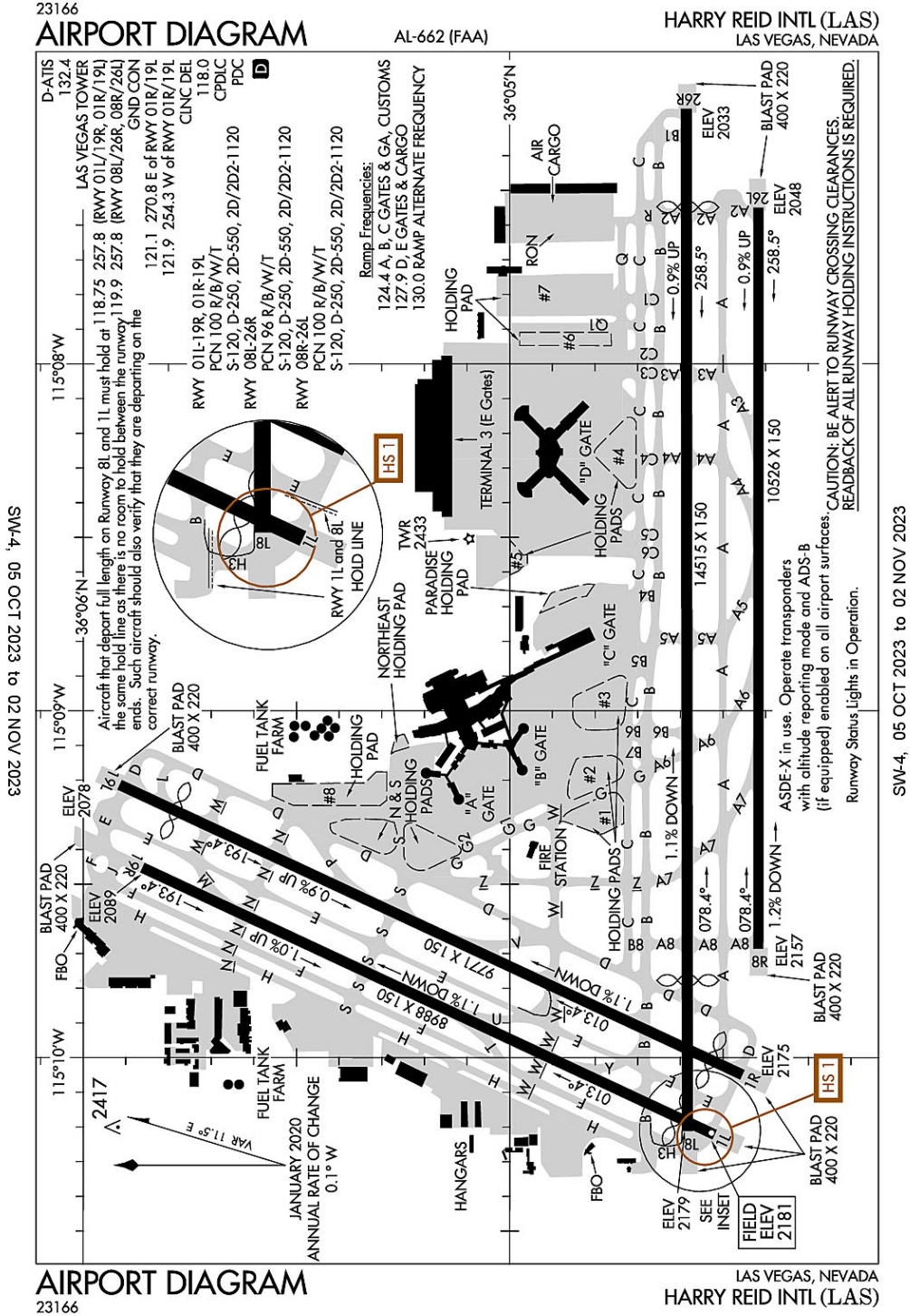
TWY CHARLIE, FROM TWY PAPA TO TWY CHARLIE SEVEN, RSTRD TO A B757-300 SERIES OR SMLR.

A-GEAR: A-G ARE KEPT IN RECESSED POSN TIL REQ FOR USE. TWR MUST BE NOTIFIED AT LEAST 5 SEC PRIOR TO ENGAGEMENT SO THAT CABLE MAY BE RAISED.

TWY ECHO, BTN TWY PAPA AND TWY LIMA, RSTRD TO B-767 OR SMLR ACFT (WINGSPAN LESS THAN 171 FT) WHEN ACFT ARE PARKED ON THE ECHO PAD.

TWY VICTOR 2, B-737 (WINGSPAN GTR THAN 79 FT BUT LESS THAN 118 FT) MUST PERFORM JUDGMENTAL OVERSTEERING INSTEAD OF COCKPIT OVR CNTRLN STEERING WHEN TAX.

Las Vegas, Nevada  
Harry Reid International  
ICAO Identifier KLAS





**Las Vegas, NV**  
**Mc Carran Intl**  
**ICAO Identifier KLAS**

**AD 2.2 Aerodrome geographical and administrative data**

- 2.2.1 Reference Point: 36-4-48.158N / 115-9-8.045W
- 2.2.2 From City: 5 miles S of LAS VEGAS, NV
- 2.2.3 Elevation: 2181.2 ft
- 2.2.5 Magnetic Variation: 11E (2020)
- 2.2.6 Airport Contact: ROSEMARY A. VASSILIADIS  
5757 WAYNE NEWTON BLVD  
LAS VEGAS, NV 89119 (702-261-5211)
- 2.2.7 Traffic: IFR/VFR

**AD 2.3 Attendance Schedule**

- 2.3.1 All Months, All Days, All Hours

**AD 2.4 Handling Services and Facilities**

- 2.4.1 Cargo Handling Facilities: YES
- 2.4.2 Fuel Types: 100,100LL,A1+
- 2.4.5 Hangar Space: YES
- 2.4.6 Repair Facilities: MAJOR

**AD 2.6 Rescue and Firefighting Services**

- 2.6.1 Aerodrome Category: Class-I certified on 5/1/1973
- 2.6.2 Rescue and Firefighting Services: ARFF Index-E

**AD 2.12 Runway Physical Characteristics**

- 2.12.1 Designation: 01L
- 2.12.2 True Bearing: 25
- 2.12.3 Dimensions: 8988 ft x 150 ft
- 2.12.4 PCN: 100 R/B/W/T
- 2.12.5 Coordinates: 36-4-31.1684N / 115-10-13.3148W
- 2.12.6 Threshold Elevation: 2181.2 ft
- 2.12.6 Touchdown Zone Elevation: 2176.1 ft

- 2.12.1 Designation: 19R
- 2.12.2 True Bearing: 205
- 2.12.3 Dimensions: 8988 ft x 150 ft
- 2.12.4 PCN: 100 R/B/W/T
- 2.12.5 Coordinates: 36-5-51.7658N / 115-9-27.1851W
- 2.12.6 Threshold Elevation: 2088.5 ft
- 2.12.6 Touchdown Zone Elevation: 2116.6 ft

- 2.12.1 Designation: 01R
- 2.12.2 True Bearing: 25
- 2.12.3 Dimensions: 9771 ft x 150 ft
- 2.12.4 PCN: 100 R/B/W/T
- 2.12.5 Coordinates: 36-4-27.264N / 115-10-2.9581W
- 2.12.6 Threshold Elevation: 2175.1 ft
- 2.12.6 Touchdown Zone Elevation: 2169.8 ft

2.12.1 Designation: 19L  
2.12.2 True Bearing: 205  
2.12.3 Dimensions: 9771 ft x 150 ft  
2.12.4 PCN: 100 R/B/W/T  
2.12.5 Coordinates: 36-5-54.8814N / 115-9-12.8055W  
2.12.6 Threshold Elevation: 2077.6 ft  
2.12.6 Touchdown Zone Elevation: 2112.1 ft

2.12.1 Designation: 08L  
2.12.2 True Bearing: 90  
2.12.3 Dimensions: 14515 ft x 150 ft  
2.12.4 PCN: 96 R/B/W/T  
2.12.5 Coordinates: 36-4-34.9211N / 115-10-12.6889W  
2.12.6 Threshold Elevation: 2179.2 ft  
2.12.6 Touchdown Zone Elevation: 2154.9 ft

2.12.1 Designation: 26R  
2.12.2 True Bearing: 270  
2.12.3 Dimensions: 14515 ft x 150 ft  
2.12.4 PCN: 96 R/B/W/T  
2.12.5 Coordinates: 36-4-35.0633N / 115-7-15.8989W  
2.12.6 Threshold Elevation: 2033 ft  
2.12.6 Touchdown Zone Elevation: 2067.1 ft

2.12.1 Designation: 08R  
2.12.2 True Bearing: 90  
2.12.3 Dimensions: 10526 ft x 150 ft  
2.12.4 PCN: 100 R/B/W/T  
2.12.5 Coordinates: 36-4-25.0637N / 115-9-41.1617W  
2.12.6 Threshold Elevation: 2156.9 ft  
2.12.6 Touchdown Zone Elevation: 2156.9 ft

2.12.1 Designation: 26L  
2.12.2 True Bearing: 270  
2.12.3 Dimensions: 10526 ft x 150 ft  
2.12.4 PCN: 100 R/B/W/T  
2.12.5 Coordinates: 36-4-25.1671N / 115-7-32.9665W  
2.12.6 Threshold Elevation: 2048.4 ft  
2.12.6 Touchdown Zone Elevation: 2069 ft

**AD 2.13 Declared Distances**

2.13.1 Designation: 01L  
2.13.2 Take-off Run Available: 8988  
2.13.3 Take-off Distance Available: 8988  
2.13.4 Accelerate-Stop Distance Available: 8988  
2.13.5 Landing Distance Available: 8401

2.13.1 Designation: 19R  
2.13.2 Take-off Run Available: 8988

2.13.3 Take-off Distance Available: 9400  
2.13.4 Accelerate-Stop Distance Available: 8417  
2.13.5 Landing Distance Available: 8417

2.13.1 Designation: 01R  
2.13.2 Take-off Run Available: 9771  
2.13.3 Take-off Distance Available: 10168  
2.13.4 Accelerate-Stop Distance Available: 9276  
2.13.5 Landing Distance Available: 8785

2.13.1 Designation: 19L  
2.13.2 Take-off Run Available: 9771  
2.13.3 Take-off Distance Available: 10171  
2.13.4 Accelerate-Stop Distance Available: 9686  
2.13.5 Landing Distance Available: 8808

2.13.1 Designation: 08L  
2.13.2 Take-off Run Available: 14515  
2.13.3 Take-off Distance Available: 15099  
2.13.4 Accelerate-Stop Distance Available: 14099  
2.13.5 Landing Distance Available: 11960

2.13.1 Designation: 26R  
2.13.2 Take-off Run Available: 14515  
2.13.3 Take-off Distance Available: 15037  
2.13.4 Accelerate-Stop Distance Available: 14037  
2.13.5 Landing Distance Available: 12638

2.13.1 Designation: 08R  
2.13.2 Take-off Run Available: 10526  
2.13.3 Take-off Distance Available: 10526  
2.13.4 Accelerate-Stop Distance Available: 10526  
2.13.5 Landing Distance Available: 10526

2.13.1 Designation: 26L  
2.13.2 Take-off Run Available: 10526  
2.13.3 Take-off Distance Available: 10526  
2.13.4 Accelerate-Stop Distance Available: 10526  
2.13.5 Landing Distance Available: 10526

**AD 2.14 Approach and Runway Lighting**

2.14.1 Designation: 01L  
2.14.2 Approach Lighting System: MALSF  
2.14.4 Visual Approach Slope Indicator System: P4L

2.14.1 Designation: 19R  
2.14.2 Approach Lighting System:  
2.14.4 Visual Approach Slope Indicator System: P4L

2.14.1 Designation: 01R

2.14.2 Approach Lighting System:  
2.14.4 Visual Approach Slope Indicator System: P4L

2.14.1 Designation: 19L  
2.14.2 Approach Lighting System:  
2.14.4 Visual Approach Slope Indicator System: P4L

2.14.1 Designation: 08L  
2.14.2 Approach Lighting System:  
2.14.4 Visual Approach Slope Indicator System: P4L

2.14.1 Designation: 26R  
2.14.2 Approach Lighting System: MALS  
2.14.4 Visual Approach Slope Indicator System: P4L

2.14.1 Designation: 08R  
2.14.2 Approach Lighting System:  
2.14.4 Visual Approach Slope Indicator System: P4L

2.14.1 Designation: 26L  
2.14.2 Approach Lighting System: MALSF  
2.14.4 Visual Approach Slope Indicator System: P4L

#### **AD 2.18 Air Traffic Services Communication Facilities**

2.18.1 Service Designation: CD/P  
2.18.3 Channel: 118  
2.18.5 Hours of Operation: 24

2.18.1 Service Designation: D-ATIS (ARR/DEP)  
2.18.3 Channel: 132.4  
2.18.5 Hours of Operation: 24

2.18.1 Service Designation: EMERG  
2.18.3 Channel: 121.5  
2.18.5 Hours of Operation:

2.18.1 Service Designation: EMERG  
2.18.3 Channel: 243  
2.18.5 Hours of Operation:

2.18.1 Service Designation: GND/P (E OF RWY 01R/19L)  
2.18.3 Channel: 121.1  
2.18.5 Hours of Operation: 24

2.18.1 Service Designation: GND/P (W OF RWY 01R/19L)  
2.18.3 Channel: 121.9  
2.18.5 Hours of Operation: 24

2.18.1 Service Designation: GND/P (W OF RWY 01L/19R)  
2.18.3 Channel: 254.3

2.18.5 Hours of Operation: 24

2.18.1 Service Designation: GND/P (E OF RWY 01R/19L)

2.18.3 Channel: 270.8

2.18.5 Hours of Operation: 24

2.18.1 Service Designation: LCL/P (RWY 01L/19R, 01R/19L)

2.18.3 Channel: 118.75

2.18.5 Hours of Operation: 24

2.18.1 Service Designation: LCL/P (RWY 08L/26R, 08R/26L)

2.18.3 Channel: 119.9

2.18.5 Hours of Operation: 24

2.18.1 Service Designation: LCL/P

2.18.3 Channel: 257.8

2.18.5 Hours of Operation: 24

2.18.1 Service Designation: RAMP CTL (A, B, C GATES & GA, CUSTOMS.)

2.18.3 Channel: 124.4

2.18.5 Hours of Operation: 24

2.18.1 Service Designation: RAMP CTL (D, E GATES & CARGO.)

2.18.3 Channel: 127.9

2.18.5 Hours of Operation: 24

2.18.1 Service Designation: RAMP CTL (RAMP ALTERNATE FREQUENCY)

2.18.3 Channel: 130

2.18.5 Hours of Operation: 24

### **AD 2.19 Radio Navigation and Landing Aids**

2.19.1 ILS Type: DME for runway 01L. Magnetic variation: 11E

2.19.2 ILS Identification: CUA

2.19.5 Coordinates: 36-6-1.7244N / 115-9-25.0625W

2.19.6 Site Elevation: 2089.4 ft

2.19.1 ILS Type: Glide Slope for runway 01L. Magnetic variation: 11E

2.19.2 ILS Identification: CUA

2.19.5 Coordinates: 36-4-49.142N / 115-10-6.5151W

2.19.6 Site Elevation: 2158.4 ft

2.19.1 ILS Type: Localizer for runway 01L. Magnetic variation: 11E

2.19.2 ILS Identification: CUA

2.19.5 Coordinates: 36-6-0.8259N / 115-9-22W

2.19.6 Site Elevation: 2078.9 ft

2.19.1 ILS Type: DME for runway 26R. Magnetic variation: 11E

2.19.2 ILS Identification: LAS

2.19.5 Coordinates: 36-4-30.5228N / 115-10-19.1659W

2.19.6 Site Elevation: 2201.5 ft

2.19.1 ILS Type: Glide Slope for runway 26R. Magnetic variation: 11E  
2.19.2 ILS Identification: LAS  
2.19.5 Coordinates: 36-4-32.0826N / 115-7-46.6759W  
2.19.6 Site Elevation: 2046.5 ft

2.19.1 ILS Type: Localizer for runway 26R. Magnetic variation: 11E  
2.19.2 ILS Identification: LAS  
2.19.5 Coordinates: 36-4-34.9114N / 115-10-19.1797W  
2.19.6 Site Elevation: 2186.3 ft

2.19.1 ILS Type: DME for runway 26L. Magnetic variation: 11E  
2.19.2 ILS Identification: RLE  
2.19.5 Coordinates: 36-4-22.2517N / 115-9-53.2672W  
2.19.6 Site Elevation: 2182.2 ft

2.19.1 ILS Type: Glide Slope for runway 26L. Magnetic variation: 11E  
2.19.2 ILS Identification: RLE  
2.19.5 Coordinates: 36-4-21.996N / 115-7-46.6672W  
2.19.6 Site Elevation: 2050.4 ft

2.19.1 ILS Type: Localizer for runway 26L. Magnetic variation: 11E  
2.19.2 ILS Identification: RLE  
2.19.5 Coordinates: 36-4-25.0515N / 115-9-53.3413W  
2.19.6 Site Elevation: 2168.2 ft

2.19.1 Navigation Aid Type: VORTAC. Magnetic variation: 15E  
2.19.2 Navigation Aid Identification: LAS  
2.19.5 Coordinates: 36-4-46.9253N / 115-9-35.2725W  
2.19.6 Site Elevation: 2136 ft

**General Remarks:**

ACFT OPER NEAR THE INT OF TWYS S, D, G AND THE N END OF TWY Z SHOULD BE ALERT AS THERE ARE CLOSELY ALIGNED TWY CNTRLN AND RADIUS TURNS.

ACFT WITH WINGSPAN GTR THAN 135 FT PPR FM DEPT OF AVN TO USE TWY H.

ACFT THAT DEP FULL LENGTH OF RWYS 01L AND 08L MUST HOLD AT THE SAME HOLD LINE AS THERE IS NO ROOM TO HOLD BTN THE RWY ENDS AND SUCH ACFT SHOULD VERIFY THAT THEY ARE ON THE CORRECT RWY.

WHEN SPL EVENT PRKG PPR PROGRAM NOTAM IS ACTV, TSNT ACFT OPERS NOT PERM BASED NEED TO OBTAIN A PPR NR FM AN FBO FOR EA LDG. PPR APPVL & CONFIRMATION NRS CAN BE OBTAINED FM THE SEL FBO AT 702-261-7775. PPR CONFIRMATION NRS SHOULD BE ENTERED IN THE RMKS SECTION OF EACH FLT PLAN.

GA CUST AND IMG LCTD WEST SIDE OF AFLD BTWN FBO'S.

ACFT TAX WB ON TWY B NEAR TWY E USE CARE NOT TO ENTER THE RWY ON TWY Y, ACFT TAX WB ON TWY W NEAR TWY E USE CARE NOT TO ENTER THE RWY ON TWY U.

ACFT MAY EXPERIENCE REFLECTION OF SUN FM GLASS HOTELS LCTD NW OF ARPT. REFLECTION MAY OCCUR AT VARIOUS ALTS, HDGS, & DSTCS FM ARPT.

ALL NON-STD RWY OPNS PPR FM DEPT OF AVN.

RWY STS LGTS ARE IN OPN.

ACFT DEPG RWY 19R USE MINIMAL PWR UNTIL PASSING THE RWY THLD. RWY 19R THLD HAS STD RWY MARKINGS AND IS 780 FT S OF THE BLAST PAD.

PLA AUZD BTN 0200 & 0600.

LGTD GOLF RANGE 1400 FT S OF RWYS 01L/19R AND 01R/19L.

RWY 08L 589 FT CWY; RWY 26R 645 FT CWY.

ALL ACFT CTC RAMP CTL ON FREQ 124.4 FOR OPS AT A, B, C GATES, AND GA, CUSTOMS; CTC RAMP CTL FREQ 127.9 FOR OPNS AT D AND E GATES AND CARGO RAMP PRIOR TO ENTERING RAMP OR PUSHING BACK FM GATE OR PRKG SPOT. RAMP CTL OPR HRS 0530-0100. CTC ATC FM 0100-0530 FOR RAMP OPS.

GA CBP RSVNS ARE RQRD TO BE SMTD A MIN OF 12 HOURS IN ADVN (OTHER CONDS APPLY). RSVNS MUST BE MADE ONLINE AT [WWW.MCCARRAN.COM/GACBP](http://WWW.MCCARRAN.COM/GACBP). QNS CAN BE DCTD TO [CBP559@MCCARRAN.COM](mailto:CBP559@MCCARRAN.COM).

LRG NR OF BIRDS AND BATS INVOF OF ARPT BTWN SS AND SR.

TBJT DEPS NOT PMTD ON RWY 01R/19L OR RWY 01L/19R 2000-0800. XCPNS FOR WX OR OPNL NECESSITY.

EXTSV GLDR/SOARING OPNS WKENDS & HOLS; SR-SS; LAS R187/020; ALTS UP TO BUT NOT INCLG FL180. GLDRS RMN CLEAR OF THE TCA BUT OTHERWISE OPR WI THE ENTIRE SW QUAD OF THE TCA VEIL.

(E98) PLUS 64 SHELTERS & 24 SHEDS.

TIEDOWN FEE.

GA PRKG VERY LTD. FOR PRKG AVAILABILITY CTC EITHER FBO (702) 736-1830 OR (702) 739-1100.

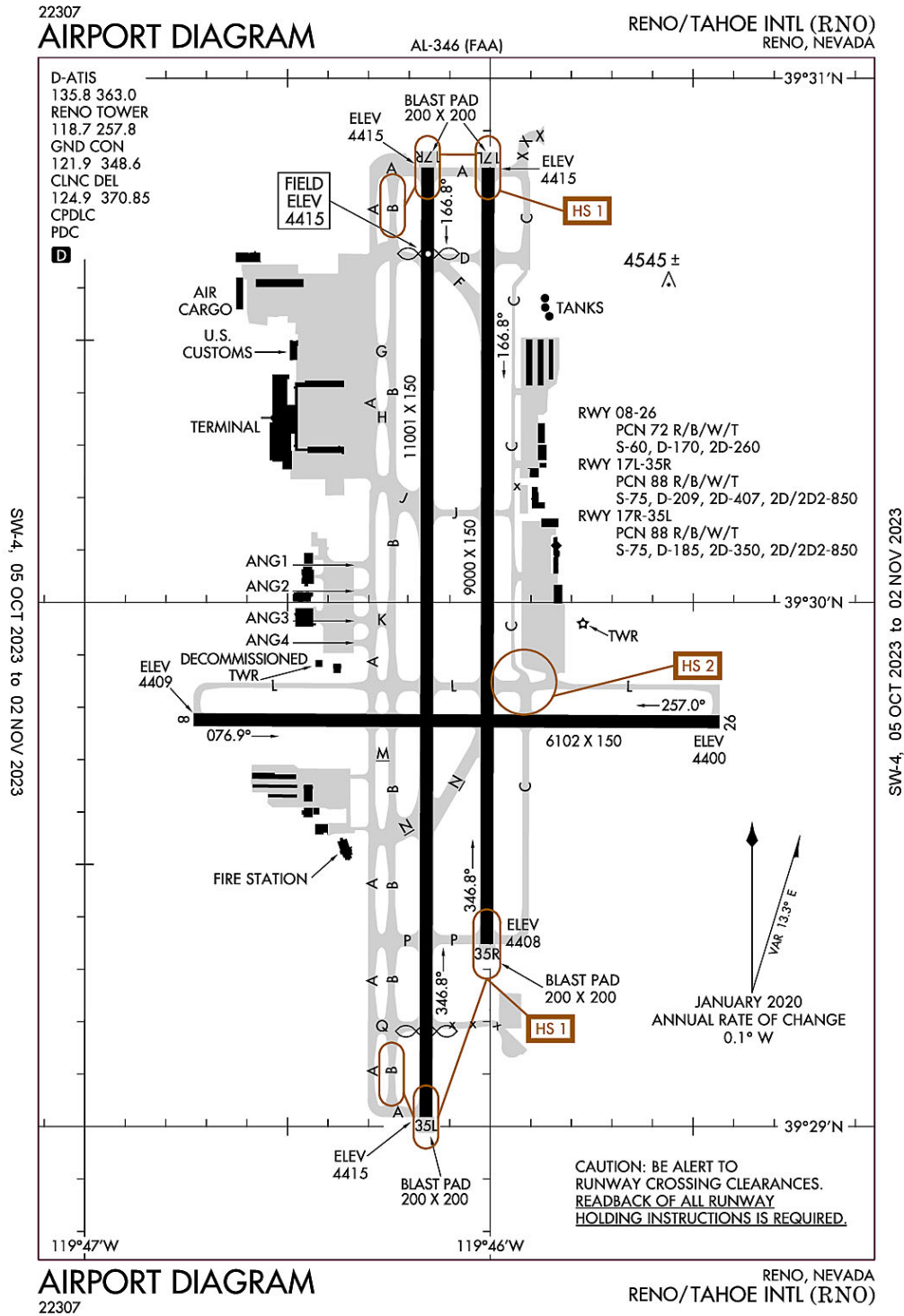
ACFT USING FULL LEN DEP ON RWY 08L USE MINIMAL PWR TIL PASSING THE PWR-UP POINT ON RWY. PWR-UP POINT IS 348 FT EAST OF BLAST PAD AND MKD WITH SIGN AND STD MARKINGS FOR BGNG OF RWY.

ASDE-X IN USE. OPERATE TRANSPONDERS WITH ALTITUDE REPORTING MODE AND ADS-B (IF EQUIPPED) ENABLED ON ALL AIRPORT SURFACES.

NMRS HOP ON WEST SIDE OF ARPT.

CTN PAJA INVOF ARPT.

**Reno, Nevada**  
**Reno/Tahoe International**  
**ICAO Identifier KRNO**





**Reno, NV**  
**Reno/Tahoe Intl**  
**ICAO Identifier KRNO**

**AD 2.2 Aerodrome geographical and administrative data**

- 2.2.1 Reference Point: 39-29-56.8N / 119-46-5.2W
- 2.2.2 From City: 3 miles SE of RENO, NV
- 2.2.3 Elevation: 4414.9 ft
- 2.2.5 Magnetic Variation: 13E (2020)
- 2.2.6 Airport Contact: DAREN GRIFFIN, A.A.E.  
P O BOX 12490  
RENO, NV 89510 (775-328-6550)
- 2.2.7 Traffic: IFR/VFR

**AD 2.3 Attendance Schedule**

- 2.3.1 All Months, All Days, All Hours

**AD 2.4 Handling Services and Facilities**

- 2.4.1 Cargo Handling Facilities: YES
- 2.4.2 Fuel Types: 100LL,A1+
- 2.4.5 Hangar Space:
- 2.4.6 Repair Facilities: MAJOR

**AD 2.6 Rescue and Firefighting Services**

- 2.6.1 Aerodrome Category: Class-I certified on 5/1/1973
- 2.6.2 Rescue and Firefighting Services: ARFF Index-C

**AD 2.12 Runway Physical Characteristics**

- 2.12.1 Designation: 08
- 2.12.2 True Bearing: 90
- 2.12.3 Dimensions: 6102 ft x 150 ft
- 2.12.4 PCN: 72 R/B/W/T
- 2.12.5 Coordinates: 39-29-46.6299N / 119-46-43.822W
- 2.12.6 Threshold Elevation: 4409.2 ft
- 2.12.6 Touchdown Zone Elevation: 4409.3 ft
  
- 2.12.1 Designation: 26
- 2.12.2 True Bearing: 270
- 2.12.3 Dimensions: 6102 ft x 150 ft
- 2.12.4 PCN: 72 R/B/W/T
- 2.12.5 Coordinates: 39-29-46.3739N / 119-45-25.9978W
- 2.12.6 Threshold Elevation: 4399.6 ft
- 2.12.6 Touchdown Zone Elevation: 4401.8 ft
  
- 2.12.1 Designation: 17L
- 2.12.2 True Bearing: 180
- 2.12.3 Dimensions: 9000 ft x 150 ft
- 2.12.4 PCN: 88 R/B/W/T
- 2.12.5 Coordinates: 39-30-49.8258N / 119-46-0.266W
- 2.12.6 Threshold Elevation: 4414.8 ft
- 2.12.6 Touchdown Zone Elevation: 4414.8 ft

2.12.1 Designation: 35R  
2.12.2 True Bearing: 0  
2.12.3 Dimensions: 9000 ft x 150 ft  
2.12.4 PCN: 88 R/B/W/T  
2.12.5 Coordinates: 39-29-20.8949N / 119-46-0.4971W  
2.12.6 Threshold Elevation: 4408.3 ft  
2.12.6 Touchdown Zone Elevation: 4408.3 ft

2.12.1 Designation: 17R  
2.12.2 True Bearing: 180  
2.12.3 Dimensions: 11001 ft x 150 ft  
2.12.4 PCN: 88 R/B/W/T  
2.12.5 Coordinates: 39-30-49.8381N / 119-46-9.1937W  
2.12.6 Threshold Elevation: 4414.8 ft  
2.12.6 Touchdown Zone Elevation: 4414.8 ft

2.12.1 Designation: 35L  
2.12.2 True Bearing: 0  
2.12.3 Dimensions: 11001 ft x 150 ft  
2.12.4 PCN: 88 R/B/W/T  
2.12.5 Coordinates: 39-29-1.1337N / 119-46-9.475W  
2.12.6 Threshold Elevation: 4414.5 ft  
2.12.6 Touchdown Zone Elevation: 4410.2 ft

**AD 2.13 Declared Distances**

2.13.1 Designation: 08  
2.13.2 Take-off Run Available: 5854  
2.13.3 Take-off Distance Available: 5854  
2.13.4 Accelerate-Stop Distance Available: 6102  
2.13.5 Landing Distance Available: 5854

2.13.1 Designation: 26  
2.13.2 Take-off Run Available: 6102  
2.13.3 Take-off Distance Available: 6102  
2.13.4 Accelerate-Stop Distance Available: 6102  
2.13.5 Landing Distance Available: 6102

2.13.1 Designation: 17L  
2.13.2 Take-off Run Available: 9000  
2.13.3 Take-off Distance Available: 9000  
2.13.4 Accelerate-Stop Distance Available: 9000  
2.13.5 Landing Distance Available: 9000

2.13.1 Designation: 35R  
2.13.2 Take-off Run Available: 9000  
2.13.3 Take-off Distance Available: 9000  
2.13.4 Accelerate-Stop Distance Available: 9000  
2.13.5 Landing Distance Available: 9000

2.13.1 Designation: 17R  
2.13.2 Take-off Run Available: 11001  
2.13.3 Take-off Distance Available: 11001  
2.13.4 Accelerate-Stop Distance Available: 11001  
2.13.5 Landing Distance Available: 10001

2.13.1 Designation: 35L  
2.13.2 Take-off Run Available: 11001  
2.13.3 Take-off Distance Available: 11001  
2.13.4 Accelerate-Stop Distance Available: 11001  
2.13.5 Landing Distance Available: 10011

#### **AD 2.14 Approach and Runway Lighting**

2.14.1 Designation: 08  
2.14.2 Approach Lighting System:  
2.14.4 Visual Approach Slope Indicator System: P4L

2.14.1 Designation: 26  
2.14.2 Approach Lighting System:  
2.14.4 Visual Approach Slope Indicator System: P4L

2.14.1 Designation: 17L  
2.14.2 Approach Lighting System:  
2.14.4 Visual Approach Slope Indicator System: P4L

2.14.1 Designation: 35R  
2.14.2 Approach Lighting System:  
2.14.4 Visual Approach Slope Indicator System: P4L

2.14.1 Designation: 17R  
2.14.2 Approach Lighting System: MALSR  
2.14.4 Visual Approach Slope Indicator System: P4L

2.14.1 Designation: 35L  
2.14.2 Approach Lighting System: MALSR  
2.14.4 Visual Approach Slope Indicator System: P4L

#### **AD 2.18 Air Traffic Services Communication Facilities**

2.18.1 Service Designation: ANG COMD POST (CALLSIGN-ROLLER OPS.)  
2.18.3 Channel: 378.4  
2.18.5 Hours of Operation:

2.18.1 Service Designation: ANG COMD POST (CALLSIGN-ROLLER OPS.)  
2.18.3 Channel: 8780  
2.18.5 Hours of Operation:

2.18.1 Service Designation: ANG OPS  
2.18.3 Channel: 280  
2.18.5 Hours of Operation:

2.18.1 Service Designation: ANG OPS (CALLSIGN-ROLLER OPS.)  
2.18.3 Channel: 378.4  
2.18.5 Hours of Operation:

2.18.1 Service Designation: ANG OPS (CALLSIGN-ROLLER OPS.)  
2.18.3 Channel: 8780  
2.18.5 Hours of Operation:

2.18.1 Service Designation: CD/P  
2.18.3 Channel: 124.9  
2.18.5 Hours of Operation: 24

2.18.1 Service Designation: CD/P  
2.18.3 Channel: 370.85  
2.18.5 Hours of Operation: 24

2.18.1 Service Designation: D-ATIS  
2.18.3 Channel: 135.8  
2.18.5 Hours of Operation: 24

2.18.1 Service Designation: D-ATIS  
2.18.3 Channel: 363  
2.18.5 Hours of Operation: 24

2.18.1 Service Designation: EMERG  
2.18.3 Channel: 121.5  
2.18.5 Hours of Operation:

2.18.1 Service Designation: EMERG  
2.18.3 Channel: 243  
2.18.5 Hours of Operation:

2.18.1 Service Designation: GND/P  
2.18.3 Channel: 121.9  
2.18.5 Hours of Operation: 24

2.18.1 Service Designation: GND/P  
2.18.3 Channel: 348.6  
2.18.5 Hours of Operation: 24

2.18.1 Service Designation: LCL/P  
2.18.3 Channel: 118.7  
2.18.5 Hours of Operation: 24

2.18.1 Service Designation: LCL/P  
2.18.3 Channel: 257.8  
2.18.5 Hours of Operation: 24

## **AD 2.19 Radio Navigation and Landing Aids**

2.19.1 ILS Type: DME for runway 17R. Magnetic variation: 13E  
2.19.2 ILS Identification: RNO  
2.19.5 Coordinates: 39-28-48.3183N / 119-46-6.1675W  
2.19.6 Site Elevation: 4433.4 ft

2.19.1 ILS Type: Glide Slope for runway 17R. Magnetic variation: 13E  
2.19.2 ILS Identification: RNO  
2.19.5 Coordinates: 39-30-28.0958N / 119-46-5.6655W  
2.19.6 Site Elevation: 4408.4 ft

2.19.1 ILS Type: Localizer for runway 17R. Magnetic variation: 13E  
2.19.2 ILS Identification: RNO  
2.19.5 Coordinates: 39-28-49.5342N / 119-46-9.505W  
2.19.6 Site Elevation: 4419.7 ft

2.19.1 ILS Type: DME for runway 35L. Magnetic variation: 13E  
2.19.2 ILS Identification: AGY  
2.19.5 Coordinates: 39-31-0.2724N / 119-46-12.5676W  
2.19.6 Site Elevation: 4434.8 ft

2.19.1 ILS Type: Glide Slope for runway 35L. Magnetic variation: 13E  
2.19.2 ILS Identification: AGY  
2.19.5 Coordinates: 39-29-19.6039N / 119-46-5.3446W  
2.19.6 Site Elevation: 4403.3 ft

2.19.1 ILS Type: Localizer for runway 35L. Magnetic variation: 13E  
2.19.2 ILS Identification: AGY  
2.19.5 Coordinates: 39-30-59.9826N / 119-46-9.1647W  
2.19.6 Site Elevation: 4433.1 ft

**General Remarks:**

ANG: APN HAS 22 FT X 6 FT ACFT GND EQUIP (AGE) BOXES LCTD TO THE EAST OF EA PKG SPOT.

INTENSIVE GLIDER ACTIVITY INVOF ARPT AND SURROUNDING AREAS UP TO 18000 FT.

ACFT OVR 12500 LBS: WRITTEN PPR FOR TRNG FLIGHTS; FOR MORE INFO CTC ARPT OPS 1-775-328-6490.

MIL ACFT: TSNT ACFT EXECUTE STRAIGHT-IN FULL STOP APCH. OVERHEAD PAT NOT AUTH FOR TSNT ACFT.

ANG: PPR 24 HR PN RQRD.

NOISE SENSITIVE AREA ALL QUADS. PILOTS OF TBJT ACFT USE RCMDD NOISE ABATEMENT PROCS; AVBL ON REQ.

TWY C BTN TWY L & TWY D RSTRD TO ACFT 100000 LBS OR LESS.

PRESIDENT / CEO OF RENO-TAHOE ARPT AUTHORITY-DARREN GRIFFIN, CARRIE GUEDEA, AMGR (775) 328-6446.

TWY A BETWEEN NORTH TWY B AND TWY D CLSD TO ACFT WITH WINGSPAN GREATER THAN 149 FT.

MIL ACFT: NOISE ABTMT CRITICAL TERMINATE AFTERBURNER ASAP THEN CLIMB TO 6500 FT MSL ASAP.

TWY M CLSD TO AIR CARRIER ACFT.

ALL COMMERCIAL AIRCRAFT CONTACT GROUND CONTROL FOR ADVISORIES PRIOR TO PUSH BACK ON THE TERMINAL RAMP.

NOISE NOTE CONT: PILOTS OF NON-TBJT ACFT USE BEST ABATEMENT PROCS AND SETTINGS. AVOID AS MUCH AS FEASIBLE FLYING OVER POPULATED AREAS.

TWY J EAST OF RY 16L/34R CLSD TO AIR CARRIER ACFT.

ANG: COMSEC MTRL STORAGE AVBL WITH PRIOR CDN AT 152 CF/SCXS, DSN 830-4798.

24 HRS PPR FOR TSNT ACFT PARKING WITH WINGSPANS GREATER THAN 75 FT.

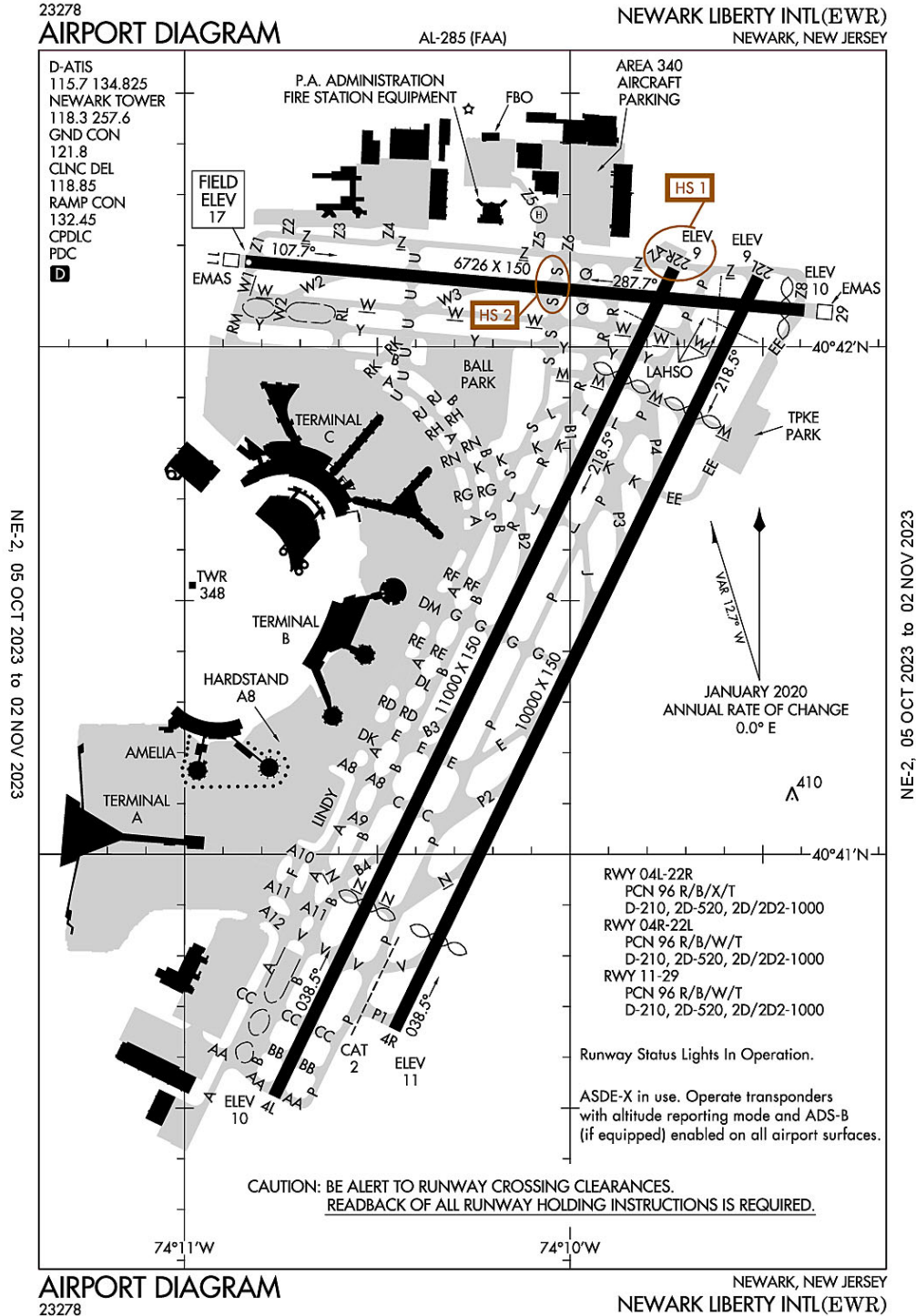
WATERFOWL ALL QUADRANTS ALL SEASONS. CONCENTRATED NW OF RWY 17R AND EAST OF RWY 17L.

GLIDER/SOARING OPER 30-50 MILES SOUTH OF ARPT DURING VFR WEATHER & MOUNTAIN WAVE WIND CONDITIONS 1100 TO SS.

ANG: ANG OPS 1430-2359Z++ MON-FRI EXC HOL AND SKED DAYS OFF; OTR TIMES BY NOTAM; DSN 830-4709 OR C775-788-4709.

TWY C BTN TWY L AND TWY D CLSD TO AIR CARRIER ACFT.

# Newark, New Jersey Newark Liberty International ICAO Identifier KEWR



**Newark, NJ**  
**Newark Liberty Intl**  
**ICAO Identifier KEWR**

**AD 2.2 Aerodrome geographical and administrative data**

- 2.2.1 Reference Point: 40-41-32.9274N / 74-10-7.2724W
- 2.2.2 From City: 3 miles S of NEWARK, NJ
- 2.2.3 Elevation: 17.4 ft
- 2.2.5 Magnetic Variation: 13W (1985)
- 2.2.6 Airport Contact: SARAH K. MCKEON  
BUILDING #1- CONRAD ROAD  
NEWARK, NJ 7114 (973-961-6161)
- 2.2.7 Traffic: IFR/VFR

**AD 2.3 Attendance Schedule**

- 2.3.1 All Months, All Days, All Hours

**AD 2.4 Handling Services and Facilities**

- 2.4.1 Cargo Handling Facilities: YES
- 2.4.2 Fuel Types: 100LL,A
- 2.4.5 Hangar Space: YES
- 2.4.6 Repair Facilities: MAJOR

**AD 2.6 Rescue and Firefighting Services**

- 2.6.1 Aerodrome Category: Class-I certified on 5/1/1973
- 2.6.2 Rescue and Firefighting Services: ARFF Index-E

**AD 2.12 Runway Physical Characteristics**

- 2.12.1 Designation: 04L
- 2.12.2 True Bearing: 26
- 2.12.3 Dimensions: 11000 ft x 150 ft
- 2.12.4 PCN: 96 R/B/X/T
- 2.12.5 Coordinates: 40-40-31.3716N / 74-10-46.0209W
- 2.12.6 Threshold Elevation: 10.1 ft
- 2.12.6 Touchdown Zone Elevation: 10.4 ft

- 2.12.1 Designation: 22R
- 2.12.2 True Bearing: 206
- 2.12.3 Dimensions: 11000 ft x 150 ft
- 2.12.4 PCN: 96 R/B/X/T
- 2.12.5 Coordinates: 40-42-9.2091N / 74-9-43.8255W
- 2.12.6 Threshold Elevation: 8.9 ft
- 2.12.6 Touchdown Zone Elevation: 10.4 ft

- 2.12.1 Designation: 22L



2.12.2 True Bearing: 206  
2.12.3 Dimensions: 10000 ft x 150 ft  
2.12.4 PCN: 96 R/B/W/T  
2.12.5 Coordinates: 40-42-8.2438N / 74-9-30.7308W  
2.12.6 Threshold Elevation: 9.4 ft  
2.12.6 Touchdown Zone Elevation: 10.7 ft

2.12.1 Designation: 04R  
2.12.2 True Bearing: 26  
2.12.3 Dimensions: 10000 ft x 150 ft  
2.12.4 PCN: 96 R/B/W/T  
2.12.5 Coordinates: 40-40-39.2984N / 74-10-27.2835W  
2.12.6 Threshold Elevation: 11.1 ft  
2.12.6 Touchdown Zone Elevation: 11.3 ft

2.12.1 Designation: 29  
2.12.2 True Bearing: 275  
2.12.3 Dimensions: 6726 ft x 150 ft  
2.12.4 PCN: 96 R/B/W/T  
2.12.5 Coordinates: 40-42-4.3181N / 74-9-23.5515W  
2.12.6 Threshold Elevation: 9.7 ft  
2.12.6 Touchdown Zone Elevation: 9.8 ft

2.12.1 Designation: 11  
2.12.2 True Bearing: 95  
2.12.3 Dimensions: 6726 ft x 150 ft  
2.12.4 PCN: 96 R/B/W/T  
2.12.5 Coordinates: 40-42-10.0955N / 74-10-50.5467W  
2.12.6 Threshold Elevation: 17.4 ft  
2.12.6 Touchdown Zone Elevation: 17.4 ft

2.12.1 Designation: H1  
2.12.2 True Bearing:  
2.12.3 Dimensions: 54 ft x 54 ft  
2.12.4 PCN:  
2.12.5 Coordinates: 40-42-15.85N / 74-10-5W  
2.12.6 Threshold Elevation: 8 ft  
2.12.6 Touchdown Zone Elevation: ft

### **AD 2.13 Declared Distances**

2.13.1 Designation: 04L  
2.13.2 Take-off Run Available: 11000  
2.13.3 Take-off Distance Available: 11000

2.13.4 Accelerate-Stop Distance Available: 11000  
2.13.5 Landing Distance Available: 8460

2.13.1 Designation: 22R  
2.13.2 Take-off Run Available: 11000  
2.13.3 Take-off Distance Available: 11000  
2.13.4 Accelerate-Stop Distance Available: 11000  
2.13.5 Landing Distance Available: 9560

2.13.1 Designation: 22L  
2.13.2 Take-off Run Available: 10000  
2.13.3 Take-off Distance Available: 10000  
2.13.4 Accelerate-Stop Distance Available: 10000  
2.13.5 Landing Distance Available: 8207

2.13.1 Designation: 04R  
2.13.2 Take-off Run Available: 10000  
2.13.3 Take-off Distance Available: 10000  
2.13.4 Accelerate-Stop Distance Available: 10000  
2.13.5 Landing Distance Available: 8810

2.13.1 Designation: 29  
2.13.2 Take-off Run Available: 6726  
2.13.3 Take-off Distance Available: 6726  
2.13.4 Accelerate-Stop Distance Available: 6726  
2.13.5 Landing Distance Available: 6502

2.13.1 Designation: 11  
2.13.2 Take-off Run Available: 6726  
2.13.3 Take-off Distance Available: 6726  
2.13.4 Accelerate-Stop Distance Available: 6726  
2.13.5 Landing Distance Available: 6726

2.13.1 Designation: H1  
2.13.2 Take-off Run Available:  
2.13.3 Take-off Distance Available:  
2.13.4 Accelerate-Stop Distance Available:  
2.13.5 Landing Distance Available:

#### **AD 2.14 Approach and Runway Lighting**

2.14.1 Designation: 04L  
2.14.2 Approach Lighting System: MALSR  
2.14.4 Visual Approach Slope Indicator System: P4L

2.14.1 Designation: 22R  
2.14.2 Approach Lighting System: MALSR  
2.14.4 Visual Approach Slope Indicator System: P4L

2.14.1 Designation: 22L  
2.14.2 Approach Lighting System: ALSF2  
2.14.4 Visual Approach Slope Indicator System: P4L

2.14.1 Designation: 04R  
2.14.2 Approach Lighting System: ALSF2  
2.14.4 Visual Approach Slope Indicator System: P4L

2.14.1 Designation: 29  
2.14.2 Approach Lighting System:  
2.14.4 Visual Approach Slope Indicator System: P4R

2.14.1 Designation: 11  
2.14.2 Approach Lighting System:  
2.14.4 Visual Approach Slope Indicator System: P4R

2.14.1 Designation: H1  
2.14.2 Approach Lighting System:  
2.14.4 Visual Approach Slope Indicator System:

**AD 2.18 Air Traffic Services Communication Facilities**

2.18.1 Service Designation: CD PRE TAXI CLNC  
2.18.3 Channel: 118.85  
2.18.5 Hours of Operation: 24

2.18.1 Service Designation: CLASS B (WITHIN 6.5 NM ARE TWR CONTROLLED FREQS)  
2.18.3 Channel: 127.85  
2.18.5 Hours of Operation:

2.18.1 Service Designation: CLASS B (WITHIN 6.5 NM ARE TWR CONTROLLED FREQS)  
2.18.3 Channel: 257.6  
2.18.5 Hours of Operation:

2.18.1 Service Designation: D-ATIS (ARR)  
2.18.3 Channel: 115.7  
2.18.5 Hours of Operation: 24

2.18.1 Service Designation: D-ATIS

2.18.3 Channel: 134.825  
2.18.5 Hours of Operation: 24

2.18.1 Service Designation: EMERG  
2.18.3 Channel: 121.5  
2.18.5 Hours of Operation:

2.18.1 Service Designation: EMERG  
2.18.3 Channel: 243  
2.18.5 Hours of Operation:

2.18.1 Service Designation: GND/P  
2.18.3 Channel: 121.8  
2.18.5 Hours of Operation: 24

2.18.1 Service Designation: GND/S  
2.18.3 Channel: 126.15  
2.18.5 Hours of Operation: 24

2.18.1 Service Designation: LCL/P  
2.18.3 Channel: 118.3  
2.18.5 Hours of Operation: 24

2.18.1 Service Designation: LCL/P (WITHIN 6.5 NM ARE TWR CONTROLLED FREQS)  
2.18.3 Channel: 257.6  
2.18.5 Hours of Operation: 24

2.18.1 Service Designation: LCL/S  
2.18.3 Channel: 134.05  
2.18.5 Hours of Operation: 24

2.18.1 Service Designation: RAMP CTL  
2.18.3 Channel: 132.45  
2.18.5 Hours of Operation: 24

### **AD 2.19 Radio Navigation and Landing Aids**

2.19.1 ILS Type: DME for runway 04L. Magnetic variation: 13W  
2.19.2 ILS Identification: EWR  
2.19.5 Coordinates: 40-42-15.686N / 74-9-33.736W  
2.19.6 Site Elevation: 34.3 ft

2.19.1 ILS Type: Glide Slope for runway 04L. Magnetic variation: 13W  
2.19.2 ILS Identification: EWR

2.19.5 Coordinates: 40-41-2.167N / 74-10-22.759W

2.19.6 Site Elevation: 7.4 ft

2.19.1 ILS Type: Localizer for runway 04L. Magnetic variation: 13W

2.19.2 ILS Identification: EWR

2.19.5 Coordinates: 40-42-18.192N / 74-9-38.112W

2.19.6 Site Elevation: 8.7 ft

2.19.1 ILS Type: DME for runway 22R. Magnetic variation: 13W

2.19.2 ILS Identification: JNN

2.19.5 Coordinates: 40-42-15.686N / 74-9-33.736W

2.19.6 Site Elevation: 34.3 ft

2.19.1 ILS Type: Glide Slope for runway 22R. Magnetic variation: 13W

2.19.2 ILS Identification: JNN

2.19.5 Coordinates: 40-41-47.5592N / 74-9-53.883W

2.19.6 Site Elevation: 8 ft

2.19.1 ILS Type: Localizer for runway 22R. Magnetic variation: 13W

2.19.2 ILS Identification: JNN

2.19.5 Coordinates: 40-40-22.392N / 74-10-51.726W

2.19.6 Site Elevation: 9.1 ft

2.19.1 ILS Type: DME for runway 04R. Magnetic variation: 13W

2.19.2 ILS Identification: EZA

2.19.5 Coordinates: 40-41-43.5471N / 74-9-41.6275W

2.19.6 Site Elevation: 33.5 ft

2.19.1 ILS Type: Glide Slope for runway 04R. Magnetic variation: 13W

2.19.2 ILS Identification: EZA

2.19.5 Coordinates: 40-40-57.598N / 74-10-9.8776W

2.19.6 Site Elevation: 6 ft

2.19.1 ILS Type: Localizer for runway 04R. Magnetic variation: 13W

2.19.2 ILS Identification: EZA

2.19.5 Coordinates: 40-42-15.9432N / 74-9-25.8352W

2.19.6 Site Elevation: 8.1 ft

2.19.1 ILS Type: DME for runway 22L. Magnetic variation: 13W

2.19.2 ILS Identification: LSQ

2.19.5 Coordinates: 40-41-43.5471N / 74-9-41.6275W

2.19.6 Site Elevation: 33.5 ft

2.19.1 ILS Type: Glide Slope for runway 22L. Magnetic variation: 13W

2.19.2 ILS Identification: LSQ  
2.19.5 Coordinates: 40-41-43.6732N / 74-9-41.7368W  
2.19.6 Site Elevation: 7.4 ft

2.19.1 ILS Type: Localizer for runway 22L. Magnetic variation: 13W  
2.19.2 ILS Identification: LSQ  
2.19.5 Coordinates: 40-40-28.9529N / 74-10-33.8654W  
2.19.6 Site Elevation: 9.4 ft

2.19.1 ILS Type: DME for runway 11. Magnetic variation: 13W  
2.19.2 ILS Identification: GPR  
2.19.5 Coordinates: 40-42-9.5406N / 74-10-4.0694W  
2.19.6 Site Elevation: 7.1 ft

2.19.1 ILS Type: Glide Slope for runway 11. Magnetic variation: 13W  
2.19.2 ILS Identification: GPR  
2.19.5 Coordinates: 40-42-10.837N / 74-10-35.03W  
2.19.6 Site Elevation: 9.5 ft

2.19.1 ILS Type: Localizer for runway 11. Magnetic variation: 13W  
2.19.2 ILS Identification: GPR  
2.19.5 Coordinates: 40-42-9.2938N / 74-10-4.9852W  
2.19.6 Site Elevation: 7 ft

2.19.1 Navigation Aid Type: DME. Magnetic variation:  
2.19.2 Navigation Aid Identification: EWR  
2.19.5 Coordinates: 40-40-27.64N / 74-10-40.68W  
2.19.6 Site Elevation: 9 ft

2.19.1 Navigation Aid Type: FAN MARKER. Magnetic variation: 11W  
2.19.2 Navigation Aid Identification: EWR  
2.19.5 Coordinates: 40-42-12.1824N / 74-11-14.7211W  
2.19.6 Site Elevation: 9.5 ft

**General Remarks:**

DURNG ATC ZERO EVENTS; ARPT OPS WILL MNT 118.3 AND PROVIDE EMERG NOTIFICATIONS TO ARFF

HIGH VOLUME OF LOW LEVEL HEL TFC ARR AND DEP HELO KEARNY HELI (65NJ) LCTD 3.5 MILES NE OF ARPT.

TWY Z5 CLSD TO ACFT WITH WINGSPANS IN EXCESS OF 118 FT.

TWY Z BTN TWY Z2 & Z4 CLSD TO ACFT WITH WINGSPANS IN EXCESS OF 171 FT.

TWY A11 W OF TWY A ACFT SPD RSTR OF 17 KTS/20 MPH MAX FOR ALL ACFT WITH WINGSPANS IN EXCESS OF 171 FT.

ADG IV ACFT RSTR FM PSG TWY Z3 ON Z

TWY EE BTN RWY 4R-22L AND RWY 11-29 CLSD TO AFCT WITH WINGSPANS IN EXCESS OF 171 FT.

NOISE RSTR CALL 212-435-3784 DRG NML BUS HRS.

FLOCKS OF BIRDS ON & INVOF ARPT.

TWY A BTN TWY AA AND RAMP CLSD TO ACFT WITH WINGSPANS IN EXCESS OF 171 FT.

RWY STATUS LIGHTS IN OPR

TWY Y BTN RM AND TWY U, SPEED RESTRICTION OF 17KT (20MPH).

PARA-SAIL & BANNER TOWING OPS 1000 FT & BLO IN UPPER & LOWER NY BAYS INCLUDING ROCKAWAY INLET INDEF.

CPDLC DEPARTURE CLEARANCE SERVICE AVAILABLE.

ACFT WITH WINGSPANS IN EXCESS OF 118 FEET PROHIBITED FROM TURNING S ON TWY R FROM TWY B1.

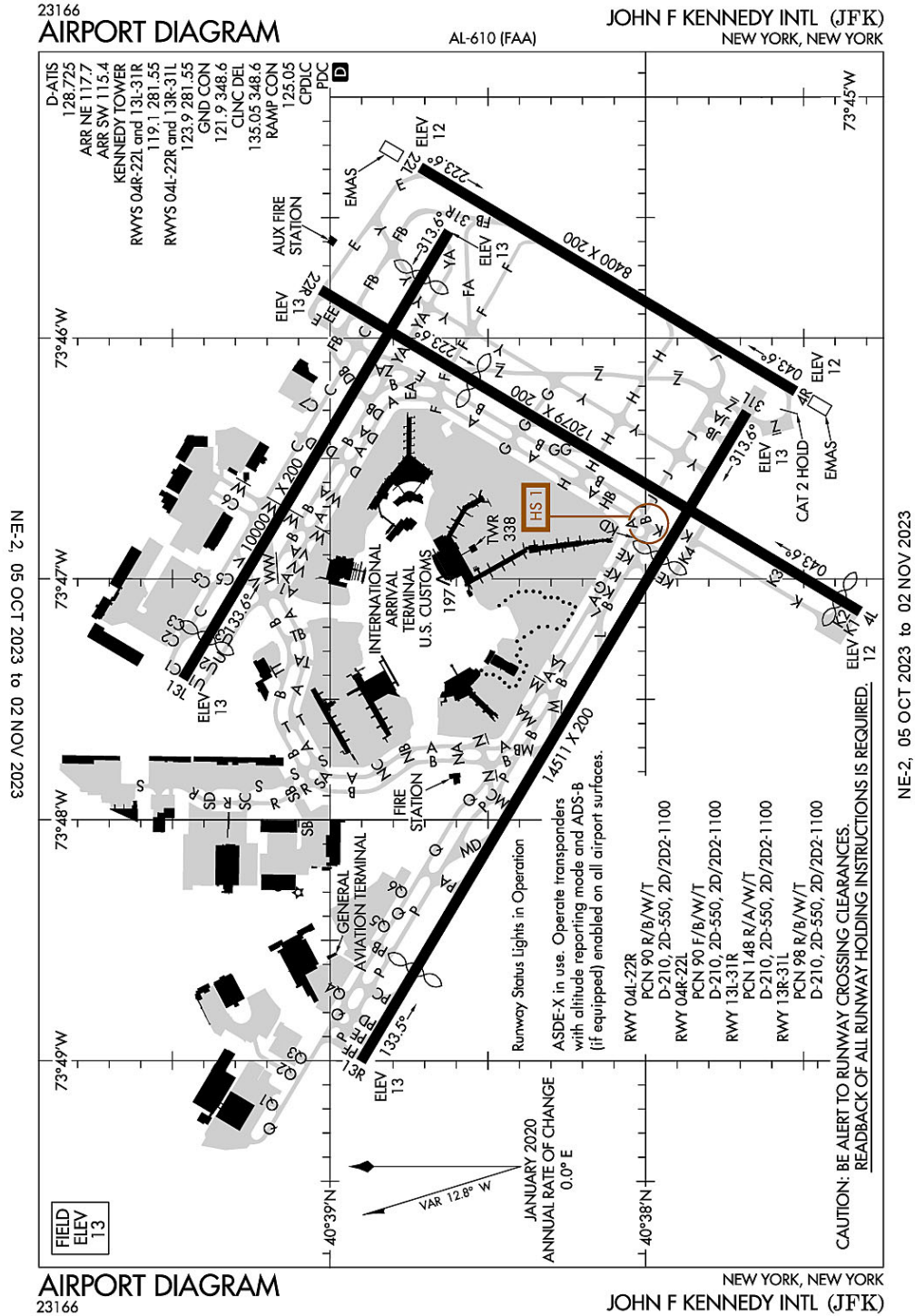
ALL TWYS SURROUNDING "BALLPARK" PRKG AREA (TWY Y BTN TWY S AND TWY U, TWY S BTN TWY Y AND TWY K, TWAY K BTN TWY S AND TWY B, TWY B BTN TWY K AND TWY U, AND TWY U BTN TWY B AND TWY Y) ACFT SPEED RSTR OF 17KTS/20MPH FOR ALL AFCT WITH WINGSPANS IN EXCESS OF 171 FT.

RWY 4R & 4L DEP USE UPPER ANT FOR ATC COM.

ASDE-X IN USE. OPER TRANSPONDER WITH ALT REPORTING MODE AND ADS-B (IF EQUIPPED) ENABLED ON ALL ARPT SFCS.

TWY Z EAST OF TWY U ACFT SPEED RSTR OF 17 KTS/20 MPH MAX FOR ALL ACFT WITH WINGSPANS IN EXCESS OF 171 FT.

New York, New York  
John F. Kennedy International  
ICAO Identifier KJFK





**New York, NY**  
**John F Kennedy Intl**  
**ICAO Identifier KJFK**

**AD 2.2 Aerodrome geographical and administrative data**

- 2.2.1 Reference Point: 40-38-23.741N / 73-46-43.292W
- 2.2.2 From City: 13 miles SE of NEW YORK, NY
- 2.2.3 Elevation: 13 ft
- 2.2.5 Magnetic Variation: 13W (2020)
- 2.2.6 Airport Contact: TERESA RIZZUTO  
BLDG 14  
JAMAICA, NY 11430 ((718) 244-3501)
- 2.2.7 Traffic: IFR/VFR

**AD 2.3 Attendance Schedule**

- 2.3.1 All Months, All Days, All Hours

**AD 2.4 Handling Services and Facilities**

- 2.4.1 Cargo Handling Facilities: YES
- 2.4.2 Fuel Types: 100LL,A
- 2.4.5 Hangar Space: YES
- 2.4.6 Repair Facilities: MAJOR

**AD 2.6 Rescue and Firefighting Services**

- 2.6.1 Aerodrome Category: Class-I certified on 5/1/1973
- 2.6.2 Rescue and Firefighting Services: ARFF Index-E

**AD 2.12 Runway Physical Characteristics**

- 2.12.1 Designation: 04L
- 2.12.2 True Bearing: 31
- 2.12.3 Dimensions: 12079 ft x 200 ft
- 2.12.4 PCN: 90 R/B/W/T
- 2.12.5 Coordinates: 40-37-19.2754N / 73-47-8.1029W
- 2.12.6 Threshold Elevation: 11.9 ft
- 2.12.6 Touchdown Zone Elevation: 12.7 ft

- 2.12.1 Designation: 22R
- 2.12.2 True Bearing: 211
- 2.12.3 Dimensions: 12079 ft x 200 ft
- 2.12.4 PCN: 90 R/B/W/T
- 2.12.5 Coordinates: 40-39-1.8338N / 73-45-47.9596W
- 2.12.6 Threshold Elevation: 12.5 ft
- 2.12.6 Touchdown Zone Elevation: 12.7 ft

- 2.12.1 Designation: 04R
- 2.12.2 True Bearing: 31
- 2.12.3 Dimensions: 8400 ft x 200 ft
- 2.12.4 PCN: 90 F/B/W/T
- 2.12.5 Coordinates: 40-37-31.5418N / 73-46-13.2441W
- 2.12.6 Threshold Elevation: 11.9 ft
- 2.12.6 Touchdown Zone Elevation: 12 ft

2.12.1 Designation: 22L  
2.12.2 True Bearing: 211  
2.12.3 Dimensions: 8400 ft x 200 ft  
2.12.4 PCN: 90 F/B/W/T  
2.12.5 Coordinates: 40-38-42.8531N / 73-45-17.5027W  
2.12.6 Threshold Elevation: 11.9 ft  
2.12.6 Touchdown Zone Elevation: 12 ft

2.12.1 Designation: 13L  
2.12.2 True Bearing: 121  
2.12.3 Dimensions: 10000 ft x 200 ft  
2.12.4 PCN: 148 R/A/W/T  
2.12.5 Coordinates: 40-39-27.952N / 73-47-24.8606W  
2.12.6 Threshold Elevation: 12.9 ft  
2.12.6 Touchdown Zone Elevation: 13 ft

2.12.1 Designation: 31R  
2.12.2 True Bearing: 301  
2.12.3 Dimensions: 10000 ft x 200 ft  
2.12.4 PCN: 148 R/A/W/T  
2.12.5 Coordinates: 40-38-37.4085N / 73-45-33.3818W  
2.12.6 Threshold Elevation: 12.6 ft  
2.12.6 Touchdown Zone Elevation: 13 ft

2.12.1 Designation: 13R  
2.12.2 True Bearing: 121  
2.12.3 Dimensions: 14511 ft x 200 ft  
2.12.4 PCN: 98 R/B/W/T  
2.12.5 Coordinates: 40-38-54.1008N / 73-49-0.173W  
2.12.6 Threshold Elevation: 12.5 ft  
2.12.6 Touchdown Zone Elevation: 12.6 ft

2.12.1 Designation: 31L  
2.12.2 True Bearing: 301  
2.12.3 Dimensions: 14511 ft x 200 ft  
2.12.4 PCN: 98 R/B/W/T  
2.12.5 Coordinates: 40-37-40.7799N / 73-46-18.4107W  
2.12.6 Threshold Elevation: 12.6 ft  
2.12.6 Touchdown Zone Elevation: 12.7 ft

#### **AD 2.13 Declared Distances**

2.13.1 Designation: 04L  
2.13.2 Take-off Run Available: 11351  
2.13.3 Take-off Distance Available: 11351  
2.13.4 Accelerate-Stop Distance Available: 11470  
2.13.5 Landing Distance Available: 11010

2.13.1 Designation: 22R  
2.13.2 Take-off Run Available: 12079

2.13.3 Take-off Distance Available: 12079  
2.13.4 Accelerate-Stop Distance Available: 11219  
2.13.5 Landing Distance Available: 7794

2.13.1 Designation: 04R  
2.13.2 Take-off Run Available: 8400  
2.13.3 Take-off Distance Available: 8400  
2.13.4 Accelerate-Stop Distance Available: 8400  
2.13.5 Landing Distance Available: 8400

2.13.1 Designation: 22L  
2.13.2 Take-off Run Available: 8400  
2.13.3 Take-off Distance Available: 8400  
2.13.4 Accelerate-Stop Distance Available: 8400  
2.13.5 Landing Distance Available: 8400

2.13.1 Designation: 13L  
2.13.2 Take-off Run Available: 10000  
2.13.3 Take-off Distance Available: 10000  
2.13.4 Accelerate-Stop Distance Available: 10000  
2.13.5 Landing Distance Available: 9093

2.13.1 Designation: 31R  
2.13.2 Take-off Run Available: 10000  
2.13.3 Take-off Distance Available: 10000  
2.13.4 Accelerate-Stop Distance Available: 9513  
2.13.5 Landing Distance Available: 8486

2.13.1 Designation: 13R  
2.13.2 Take-off Run Available: 14511  
2.13.3 Take-off Distance Available: 14511  
2.13.4 Accelerate-Stop Distance Available: 14511  
2.13.5 Landing Distance Available: 12468

2.13.1 Designation: 31L  
2.13.2 Take-off Run Available: 14511  
2.13.3 Take-off Distance Available: 14511  
2.13.4 Accelerate-Stop Distance Available: 14511  
2.13.5 Landing Distance Available: 11248

#### **AD 2.14 Approach and Runway Lighting**

2.14.1 Designation: 04L  
2.14.2 Approach Lighting System:  
2.14.4 Visual Approach Slope Indicator System: P4L

2.14.1 Designation: 22R  
2.14.2 Approach Lighting System:  
2.14.4 Visual Approach Slope Indicator System: P4L

2.14.1 Designation: 04R

2.14.2 Approach Lighting System: ALSF2  
2.14.4 Visual Approach Slope Indicator System: P4L

2.14.1 Designation: 22L  
2.14.2 Approach Lighting System: ALSF2  
2.14.4 Visual Approach Slope Indicator System: P4L

2.14.1 Designation: 13L  
2.14.2 Approach Lighting System: ALSF2  
2.14.4 Visual Approach Slope Indicator System: P4L

2.14.1 Designation: 31R  
2.14.2 Approach Lighting System: MALSR  
2.14.4 Visual Approach Slope Indicator System: P4R

2.14.1 Designation: 13R  
2.14.2 Approach Lighting System: RLLS  
2.14.4 Visual Approach Slope Indicator System: P4L

2.14.1 Designation: 31L  
2.14.2 Approach Lighting System:  
2.14.4 Visual Approach Slope Indicator System: P4L

**AD 2.18 Air Traffic Services Communication Facilities**

2.18.1 Service Designation: APCH/P  
2.18.3 Channel: 125.7  
2.18.5 Hours of Operation:

2.18.1 Service Designation: CD PRE TAXI CLNC  
2.18.3 Channel: 135.05  
2.18.5 Hours of Operation: 24

2.18.1 Service Designation: CD PRE TAXI CLNC (NORTH & SOUTH)  
2.18.3 Channel: 348.6  
2.18.5 Hours of Operation: 24

2.18.1 Service Designation: CLASS B (FREQS 2000 FT & BLW W/N 8 NM ARE TWR CNTRLD FREQS)  
2.18.3 Channel: 125.25  
2.18.5 Hours of Operation:

2.18.1 Service Designation: CLASS B (FREQS 2000 FT & BLW W/N 8 NM ARE TWR CNTRLD FREQS)  
2.18.3 Channel: 281.55  
2.18.5 Hours of Operation:

2.18.1 Service Designation: D-ATIS (ARR-SW)  
2.18.3 Channel: 115.4  
2.18.5 Hours of Operation: 24

2.18.1 Service Designation: D-ATIS (ARR-NE)  
2.18.3 Channel: 117.7

2.18.5 Hours of Operation: 24

2.18.1 Service Designation: D-ATIS (ARR/DEP)

2.18.3 Channel: 128.725

2.18.5 Hours of Operation: 24

2.18.1 Service Designation: EMERG

2.18.3 Channel: 121.5

2.18.5 Hours of Operation:

2.18.1 Service Designation: EMERG

2.18.3 Channel: 243

2.18.5 Hours of Operation:

2.18.1 Service Designation: GND/P

2.18.3 Channel: 121.9

2.18.5 Hours of Operation: 24

2.18.1 Service Designation: GND/P

2.18.3 Channel: 348.6

2.18.5 Hours of Operation: 24

2.18.1 Service Designation: GND/S

2.18.3 Channel: 121.65

2.18.5 Hours of Operation: 24

2.18.1 Service Designation: LCL/P (RWY 04R/22L, 13L/31R)

2.18.3 Channel: 119.1

2.18.5 Hours of Operation: 24

2.18.1 Service Designation: LCL/P (RWY 04L/22R, 13R/31L)

2.18.3 Channel: 123.9

2.18.5 Hours of Operation: 24

2.18.1 Service Designation: LCL/P (RWY 04L/22R, 13R/31L)

2.18.3 Channel: 281.55

2.18.5 Hours of Operation: 24

2.18.1 Service Designation: LCL/P (RWY 04R/22L, 13L/31R)

2.18.3 Channel: 281.55

2.18.5 Hours of Operation: 24

2.18.1 Service Designation: PARCH STAR

2.18.3 Channel: 125.7

2.18.5 Hours of Operation:

2.18.1 Service Designation: RAMP CTL

2.18.3 Channel: 125.05

2.18.5 Hours of Operation: 24

2.18.1 Service Designation: ROBER STAR

2.18.3 Channel: 125.7  
2.18.5 Hours of Operation:

**AD 2.19 Radio Navigation and Landing Aids**

2.19.1 ILS Type: DME for runway 04L. Magnetic variation: 13W

2.19.2 ILS Identification: HIQ

2.19.5 Coordinates: 40-37-43.8179N / 73-46-40.579W

2.19.6 Site Elevation: 22.6 ft

2.19.1 ILS Type: Glide Slope for runway 04L. Magnetic variation: 13W

2.19.2 ILS Identification: HIQ

2.19.5 Coordinates: 40-37-31.0909N / 73-46-54.8905W

2.19.6 Site Elevation: 9.9 ft

2.19.1 ILS Type: Localizer for runway 04L. Magnetic variation: 13W

2.19.2 ILS Identification: HIQ

2.19.5 Coordinates: 40-39-6.9661N / 73-45-43.9445W

2.19.6 Site Elevation: 10.9 ft

2.19.1 ILS Type: DME for runway 22R. Magnetic variation: 13W

2.19.2 ILS Identification: JOC

2.19.5 Coordinates: 40-38-53.285N / 73-45-13.1901W

2.19.6 Site Elevation: 27.4 ft

2.19.1 ILS Type: Glide Slope for runway 22R. Magnetic variation: 13W

2.19.2 ILS Identification: JOC

2.19.5 Coordinates: 40-38-21.2838N / 73-46-13.9271W

2.19.6 Site Elevation: 8.7 ft

2.19.1 ILS Type: Localizer for runway 22R. Magnetic variation: 13W

2.19.2 ILS Identification: JOC

2.19.5 Coordinates: 40-37-44.4774N / 73-46-43.1068W

2.19.6 Site Elevation: 8.3 ft

2.19.1 ILS Type: DME for runway 04R. Magnetic variation: 13W

2.19.2 ILS Identification: JFK

2.19.5 Coordinates: 40-38-53.285N / 73-45-13.1901W

2.19.6 Site Elevation: 27.4 ft

2.19.1 ILS Type: Glide Slope for runway 04R. Magnetic variation: 13W

2.19.2 ILS Identification: JFK

2.19.5 Coordinates: 40-37-42.101N / 73-46-11.0314W

2.19.6 Site Elevation: 12.6 ft

2.19.1 ILS Type: Inner Marker for runway 04R. Magnetic variation: 13W

2.19.2 ILS Identification: JFK

2.19.5 Coordinates: 40-37-23.8334N / 73-46-19.1548W

2.19.6 Site Elevation: 11.9 ft

2.19.1 ILS Type: Localizer for runway 04R. Magnetic variation: 13W

2.19.2 ILS Identification: JFK  
2.19.5 Coordinates: 40-38-51.5906N / 73-45-10.6721W  
2.19.6 Site Elevation: 11.3 ft

2.19.1 ILS Type: DME for runway 22L. Magnetic variation: 13W  
2.19.2 ILS Identification: IWY  
2.19.5 Coordinates: 40-37-43.8179N / 73-46-40.579W  
2.19.6 Site Elevation: 22.6 ft

2.19.1 ILS Type: Glide Slope for runway 22L. Magnetic variation: 13W  
2.19.2 ILS Identification: IWY  
2.19.5 Coordinates: 40-38-32.9341N / 73-45-19.9803W  
2.19.6 Site Elevation: 13 ft

2.19.1 ILS Type: Inner Marker for runway 22L. Magnetic variation: 13W  
2.19.2 ILS Identification: IWY  
2.19.5 Coordinates: 40-38-51.125N / 73-45-11.0314W  
2.19.6 Site Elevation: 9.4 ft

2.19.1 ILS Type: Localizer for runway 22L. Magnetic variation: 13W  
2.19.2 ILS Identification: IWY  
2.19.5 Coordinates: 40-37-27.4935N / 73-46-16.4069W  
2.19.6 Site Elevation: 9.4 ft

2.19.1 ILS Type: DME for runway 13L. Magnetic variation: 13W  
2.19.2 ILS Identification: TLK  
2.19.5 Coordinates: 40-38-33.5365N / 73-45-18.2409W  
2.19.6 Site Elevation: 29.5 ft

2.19.1 ILS Type: Glide Slope for runway 13L. Magnetic variation: 13W  
2.19.2 ILS Identification: TLK  
2.19.5 Coordinates: 40-39-14.7492N / 73-47-4.86W  
2.19.6 Site Elevation: 10 ft

2.19.1 ILS Type: Localizer for runway 13L. Magnetic variation: 13W  
2.19.2 ILS Identification: TLK  
2.19.5 Coordinates: 40-38-30.6889N / 73-45-18.5787W  
2.19.6 Site Elevation: 13.4 ft

2.19.1 ILS Type: DME for runway 31R. Magnetic variation: 13W  
2.19.2 ILS Identification: RTH  
2.19.5 Coordinates: 40-38-33.5365N / 73-45-18.2409W  
2.19.6 Site Elevation: 29.5 ft

2.19.1 ILS Type: Glide Slope for runway 31R. Magnetic variation: 13W  
2.19.2 ILS Identification: RTH  
2.19.5 Coordinates: 40-38-50.3296N / 73-45-51.0221W  
2.19.6 Site Elevation: 9.6 ft

2.19.1 ILS Type: Localizer for runway 31R. Magnetic variation: 13W  
2.19.2 ILS Identification: RTH

2.19.5 Coordinates: 40-39-30.7866N / 73-47-31.1174W  
2.19.6 Site Elevation: 11.5 ft

2.19.1 ILS Type: Glide Slope for runway 31L. Magnetic variation: 13W  
2.19.2 ILS Identification: MOH  
2.19.5 Coordinates: 40-37-59.8724N / 73-47-9.4083W  
2.19.6 Site Elevation: 8.6 ft

2.19.1 ILS Type: Localizer for runway 31L. Magnetic variation: 13W  
2.19.2 ILS Identification: MOH  
2.19.5 Coordinates: 40-38-59.6562N / 73-49-12.4887W  
2.19.6 Site Elevation: 12.4 ft

2.19.1 Navigation Aid Type: VOR/DME. Magnetic variation: 12W  
2.19.2 Navigation Aid Identification: JFK  
2.19.5 Coordinates: 40-37-58.3816N / 73-46-17.0103W  
2.19.6 Site Elevation: 9.5 ft

**General Remarks:**

TWY Z BTN RWY 04L & 22R AND TWY Y CLSD UFN.

PERIODIC FIRE DEPT TRNG ADJACENT APCH END OF RWYS 22L & 22R.

CONTINUOUS TAXIWAY MAINTENANCE ACTIVITIES AT NUMEROUS LOCATIONS

JFK APN BLDG 73 RAMP CLSD TO ACFT WINGSPAN MORE THAN 171FT EXC UNDER TOW.

RY 13R HAS TWO (2) PAPI - P4L SYSTEMS. ( RY 13R) OFFSET PAPI SUPPORTS VOR OR GPS RWY 13R & PARKWAY VISUAL RY 13R.

METERING PROCEDURES IN EFFECT- CONTACT RAMP CONTROL PRIOR TO PUSHBACK 1200Z-1500Z DAILY/1900Z-0300Z DAILY.

NON-STD MARKINGS IN GA APN, CTC FBO ON UNICOM OR 347-566-6620 FOR WING WALKERS.

TWY 'H' CL LGTS BTN TWY 'A' & RY 4L/22R OTS.

TWY Q3 CNTRLN LGTS OTS.

ACFT ARE NOT PMTD TO STOP ON EITHER TWY A OR B BRIDGES.

CONVERGING OPNS ON RYS 13R AND 22L CONDUCTED VIA ARRIVAL DISTANCE WINDOW.

PARA-SAIL & BANNER TOWING OPNS 1000 FT & BLO IN UPPER & LOWER NEW YORK BAYS INCLUDING ROCKAWAY INLET INDEFLY.

FLOCKS OF BIRDS ON & INVOF ARPT.

NON-STANDARD ENGINEERED MATERIALS ARRESTING SYSTEM (EMAS) 393 FT IN LENGTH BY 226 FT IN WIDTH LCTD AT THE DER 4R.

NON-STANDARD ENGINEERED MATERIALS ARRESTING SYSTEM (EMAS) 405 FT IN LENGTH BY 226 FT IN WIDTH LCTD AT THE DER 22L.



A380 AND B747-800 ACFT TAX SPD RESTRICTED TO MAX 17KTS/20MPH ON ALL TWYS.

GAT HELIPAD NON-STANDARD MARKINGS & LIGHTING.

HIGH VOLUME OF LOW LEVEL VFR TRAFFIC, 500 FT AND BLO, ALONG SHORELINE SOUTH OF JFK.

SPECIAL AIR TFC RULES-PART 93 HIGH DENSITY ARPT. PROR RESERVATION REQUIRED. SEE AERONAUTICAL INFORMATION MANUAL.

TWY 'H' CL LGTS BTN TERMINAL 4 RAMP AND TWY A OTS.

RY 31R HOLDING POSITION MARKINGS AT RY 4L/22R 'SE' SIDE OBSC.

TWY NB CLSD TO SB TURNS AT TWY A.

UFN TWY 'D' BTN TWY 'C' AND HANGAR 7 CLOSED.

OBST BLDG LGT OTS 6.3 NM ESE JFK 222 FT MSL (220 FT AGL).

FOR NOISE ABATEMENT RSTRNS CALL 212-435-3782 DURG NML BUS HRS.

OBST PARKED ACFT (ASN 2020-AEA-1302-NRA) 403933 N0734749W (1.4NM NW JFK) 74 (64FT AGL) U/S 1200-0100 DLY.

RWY 31R 1000 FT DIST REMAINING SIGN MISG.

RWY STATUS LGTS IN OPS.

RLLS RY 13L USES 1000 FT LGT STN OF THE ALS ONLY WITH CRI VOR APCHS & IS ANGLED TOWARD AQUEDUCT; ALSO 5 SFL FM 1200-2000 FT & A 5 SFL GROUPING APROXLY 1 MI FM RY +1 ADJ FORMING APCH. APCH GATE ANGLED 35 DEGS S OF RY 13L CNTRLN DESIGNED TO PRVD EARLIER IDENT OF RY ENVI.

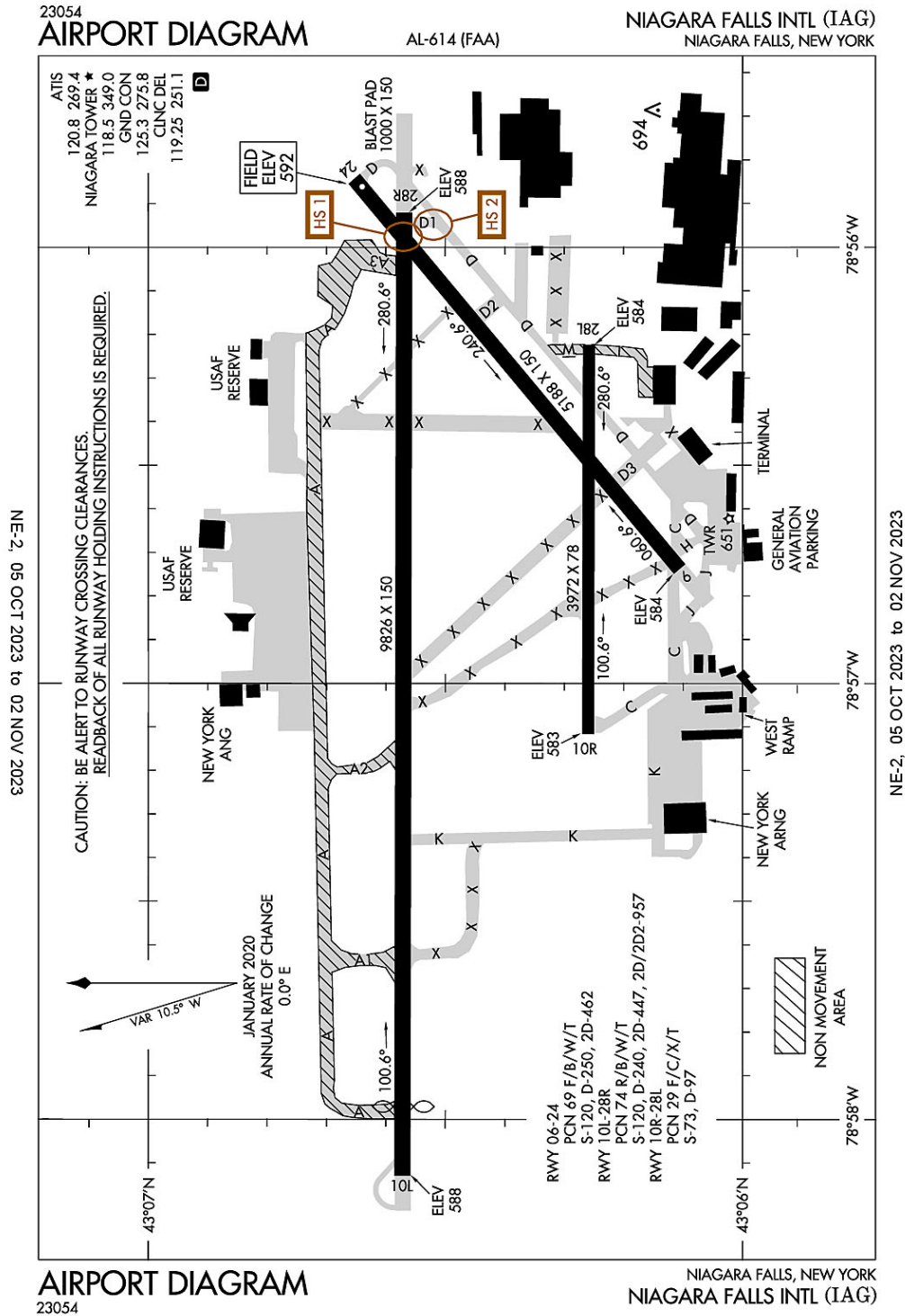
ACFT OPS & TWY RESTRICTIONS EXIST FOR A380, B747-800, B777-300ER, A340-600 AND A350-1000. PLEASE CTC JFK ARPT OPS FOR MORE INFO.

ASDE-X IN USE. OPERATE TRANSPONDERS WITH ALTITUDE REPORTING MODE AND ADS-B (IF EQUIPPED) ENABLED ON ALL AIRPORT SURFACES.

TWY 'A' BTN TWY 'NA' & TWY 'NB' ARCFT SPEED RESTRICTION OF 17KTS/20MPH MAXIMUM FOR A380, B747-800, B747-400, B777-300ER, B777-200, A340, A330, B787, AND A350

RY 13L HOLDING POSITION MARKINGS AT RY 4L/22R 'NW' SIDE OBSC.

### Niagara Falls, New York Niagara Falls International ICAO Identifier KIAG



**Niagara Falls, NY**  
**Niagara Falls Intl**  
**ICAO Identifier KIAG**

**AD 2.2 Aerodrome geographical and administrative data**

- 2.2.1 Reference Point: 43-6-27.2065N / 78-56-45.048W
- 2.2.2 From City: 4 miles E of NIAGARA FALLS, NY
- 2.2.3 Elevation: 592.3 ft
- 2.2.5 Magnetic Variation: 10W (1985)
- 2.2.6 Airport Contact: MR. ROBERT STONE  
2035 NIAGARA FALLS BLVD  
NIAGARA FALLS, NY 14304 ((716) 297-4494)
- 2.2.7 Traffic: IFR/VFR

**AD 2.3 Attendance Schedule**

- 2.3.1 All Months, All Days, All Hours

**AD 2.4 Handling Services and Facilities**

- 2.4.1 Cargo Handling Facilities: YES
- 2.4.2 Fuel Types: 100LL,A,A+
- 2.4.5 Hangar Space:
- 2.4.6 Repair Facilities: MINOR

**AD 2.6 Rescue and Firefighting Services**

- 2.6.1 Aerodrome Category: Class-I certified on 7/1/1974
- 2.6.2 Rescue and Firefighting Services: ARFF Index-B

**AD 2.12 Runway Physical Characteristics**

- 2.12.1 Designation: 06
- 2.12.2 True Bearing: 50
- 2.12.3 Dimensions: 5188 ft x 150 ft
- 2.12.4 PCN: 69 F/B/W/T
- 2.12.5 Coordinates: 43-6-6.3587N / 78-56-44.2955W
- 2.12.6 Threshold Elevation: 584.3 ft
- 2.12.6 Touchdown Zone Elevation: 585.8 ft
  
- 2.12.1 Designation: 24
- 2.12.2 True Bearing: 230
- 2.12.3 Dimensions: 5188 ft x 150 ft
- 2.12.4 PCN: 69 F/B/W/T
- 2.12.5 Coordinates: 43-6-39.1997N / 78-55-50.6072W
- 2.12.6 Threshold Elevation: 592.2 ft
- 2.12.6 Touchdown Zone Elevation: 592.3 ft
  
- 2.12.1 Designation: 10L

2.12.2 True Bearing: 90  
2.12.3 Dimensions: 9826 ft x 150 ft  
2.12.4 PCN: 74 R/B/W/T  
2.12.5 Coordinates: 43-6-34.3453N / 78-58-7.7703W  
2.12.6 Threshold Elevation: 588.2 ft  
2.12.6 Touchdown Zone Elevation: 588.8 ft

2.12.1 Designation: 28R  
2.12.2 True Bearing: 270  
2.12.3 Dimensions: 9826 ft x 150 ft  
2.12.4 PCN: 74 R/B/W/T  
2.12.5 Coordinates: 43-6-34.1594N / 78-55-55.3156W  
2.12.6 Threshold Elevation: 587.9 ft  
2.12.6 Touchdown Zone Elevation: 588.3 ft

2.12.1 Designation: 10R  
2.12.2 True Bearing: 90  
2.12.3 Dimensions: 3972 ft x 78 ft  
2.12.4 PCN: 29 F/C/X/T  
2.12.5 Coordinates: 43-6-15.6025N / 78-57-7.0063W  
2.12.6 Threshold Elevation: 582.6 ft  
2.12.6 Touchdown Zone Elevation: 584.1 ft

2.12.1 Designation: 28L  
2.12.2 True Bearing: 270  
2.12.3 Dimensions: 3972 ft x 78 ft  
2.12.4 PCN: 29 F/C/X/T  
2.12.5 Coordinates: 43-6-15.507N / 78-56-13.4609W  
2.12.6 Threshold Elevation: 584.2 ft  
2.12.6 Touchdown Zone Elevation: 584.8 ft

### **AD 2.13 Declared Distances**

2.13.1 Designation: 06  
2.13.2 Take-off Run Available: 5188  
2.13.3 Take-off Distance Available: 5188  
2.13.4 Accelerate-Stop Distance Available: 5188  
2.13.5 Landing Distance Available: 5188

2.13.1 Designation: 24  
2.13.2 Take-off Run Available: 5188  
2.13.3 Take-off Distance Available: 5188  
2.13.4 Accelerate-Stop Distance Available: 5108  
2.13.5 Landing Distance Available: 5108

- 2.13.1 Designation: 10L
- 2.13.2 Take-off Run Available: 9829
- 2.13.3 Take-off Distance Available: 10829
- 2.13.4 Accelerate-Stop Distance Available: 9829
- 2.13.5 Landing Distance Available: 9129

- 2.13.1 Designation: 28R
- 2.13.2 Take-off Run Available: 9829
- 2.13.3 Take-off Distance Available: 10529
- 2.13.4 Accelerate-Stop Distance Available: 9129
- 2.13.5 Landing Distance Available: 9129

- 2.13.1 Designation: 10R
- 2.13.2 Take-off Run Available: 3973
- 2.13.3 Take-off Distance Available: 3973
- 2.13.4 Accelerate-Stop Distance Available: 3973
- 2.13.5 Landing Distance Available: 3973

- 2.13.1 Designation: 28L
- 2.13.2 Take-off Run Available: 3973
- 2.13.3 Take-off Distance Available: 3973
- 2.13.4 Accelerate-Stop Distance Available: 3973
- 2.13.5 Landing Distance Available: 3973

#### **AD 2.14 Approach and Runway Lighting**

- 2.14.1 Designation: 06
- 2.14.2 Approach Lighting System:
- 2.14.4 Visual Approach Slope Indicator System: P4L

- 2.14.1 Designation: 24
- 2.14.2 Approach Lighting System:
- 2.14.4 Visual Approach Slope Indicator System: P4L

- 2.14.1 Designation: 10L
- 2.14.2 Approach Lighting System:
- 2.14.4 Visual Approach Slope Indicator System: V4L

- 2.14.1 Designation: 28R
- 2.14.2 Approach Lighting System: MALSR
- 2.14.4 Visual Approach Slope Indicator System: P4L

- 2.14.1 Designation: 10R

2.14.2 Approach Lighting System:  
2.14.4 Visual Approach Slope Indicator System: P2L

2.14.1 Designation: 28L  
2.14.2 Approach Lighting System:  
2.14.4 Visual Approach Slope Indicator System: P2L

**AD 2.18 Air Traffic Services Communication Facilities**

2.18.1 Service Designation: AFRC OPS  
2.18.3 Channel: 340.24  
2.18.5 Hours of Operation:

2.18.1 Service Designation: ATIS  
2.18.3 Channel: 120.8  
2.18.5 Hours of Operation: 24

2.18.1 Service Designation: ATIS  
2.18.3 Channel: 269.4  
2.18.5 Hours of Operation: 24

2.18.1 Service Designation: CD/P  
2.18.3 Channel: 119.25  
2.18.5 Hours of Operation: 0700-2300

2.18.1 Service Designation: CD/P  
2.18.3 Channel: 251.1  
2.18.5 Hours of Operation: 0700-2300

2.18.1 Service Designation: COMD POST (914 AW COMD POST/AFLD MGMT)  
2.18.3 Channel: 340.025  
2.18.5 Hours of Operation:

2.18.1 Service Designation: EMERG  
2.18.3 Channel: 121.5  
2.18.5 Hours of Operation:

2.18.1 Service Designation: EMERG  
2.18.3 Channel: 243  
2.18.5 Hours of Operation:

2.18.1 Service Designation: GND/P  
2.18.3 Channel: 125.3  
2.18.5 Hours of Operation: 0700-2300

2.18.1 Service Designation: GND/P  
2.18.3 Channel: 275.8  
2.18.5 Hours of Operation: 0700-2300

2.18.1 Service Designation: LCL/P  
2.18.3 Channel: 118.5  
2.18.5 Hours of Operation: 0700-2300

2.18.1 Service Designation: LCL/P  
2.18.3 Channel: 349  
2.18.5 Hours of Operation: 0700-2300

2.18.1 Service Designation: NG OPS  
2.18.3 Channel: 41  
2.18.5 Hours of Operation:

**AD 2.19 Radio Navigation and Landing Aids**

2.19.1 ILS Type: Glide Slope for runway 28R. Magnetic variation: 10W  
2.19.2 ILS Identification: IAG  
2.19.5 Coordinates: 43-6-30.0921N / 78-56-16.6451W  
2.19.6 Site Elevation: 582.8 ft

2.19.1 ILS Type: Localizer for runway 28R. Magnetic variation: 10W  
2.19.2 ILS Identification: IAG  
2.19.5 Coordinates: 43-6-34.3589N / 78-58-18.8146W  
2.19.6 Site Elevation: 585.1 ft

2.19.1 ILS Type: Outer Marker for runway 28R. Magnetic variation: 10W  
2.19.2 ILS Identification: IAG  
2.19.5 Coordinates: 43-6-32.5184N / 78-50-18.2195W  
2.19.6 Site Elevation: 614.9 ft

2.19.1 Navigation Aid Type: TACAN. Magnetic variation: 10W  
2.19.2 Navigation Aid Identification: IAG  
2.19.5 Coordinates: 43-6-45.1638N / 78-57-36.8623W  
2.19.6 Site Elevation: 591.5 ft

**General Remarks:**

CAUTION: HEAVY CONCENTRATIONS OF GULLS-BLACKBIRDS-STARLINGS UP TO 5000 AGL ON & INVOF ARPT. BASH PHASE II OPERATIONS AT KIAG MAR-MAY AND SEP-NOV.

FLUID: SP.

JASU: 2(A/M32A-86) 1(AM32A-60) 1(MA-1A).

FUEL: J8, A++ (MIL).

MISC: LOCAL MISSION AIRCRAFT HAVE PRIORITY FOR DEICING; FULL AIRCRAFT DEICING FOR C-17 AND C-5 AIRCRAFT NOT AVAILABLE.

INTXN DEPS RWY 24 AT TWY D1 ARE NA.

ALL MIL ACFT ONLY MINIMAL CLASSIFIED MATERIALS AVBL; AIRCREWS SHOULD ARRIVE WITH APPROPRIATE AMOUNT TO COMPLETE THEIR MISSION.

EXTSV ACFT ACTIVITY OPERATING INVOF US/CANADIAN FALLS ALL ALTS.

RWY 28R 1000 FT BY 150 FT BLAST PAD

AFLD MGMT DOES NOT ISSUE OR STORE COMSEC, FOR COMSEC STORAGE CTC COMMAND POST DSN 238-2150, C716-236-2150.

OIL: O-148(MIL).

BEARING STRENGTH RWY 06/24: ST110 TT145 SBTT281TDT415 TRT252.

PILOTS ARE REMINDED TO REVIEW ARPT HOTSPOT INFO BFR TXG FOR DEP & BFR LNDG. SEE TPP ARPT DIAGRAM AND CHART SUPPL SXN ON HOTSPOTS FOR ADDNL INFO.

REMARKS: SEE FLIP AP/1 SUPPLEMENTARY ARPT RMK.

AFRC/ANG: CSTMS/AG/IMG SVC NOT LCTD ON NIAGARA FALLS ARS. SVC AVBL H24.

AFRC/ANG: NSTD OPS APN MRKS IDENTIFYING PRKG ROW AND PRKG LCTN. NSTD MAIN APN MRKS PRKG STOP BAR AND ACFT GND EQPT (AGE) BOX.

ALL MIL ACFT ONLY OPNS RESTRICTED DURING BIRD WATCH CONDITIONS. MODERATE - TKOF & LDG PERMISSION ONLY WHEN DEP/ARR RTE AVOIDS IDENTIFIED BIRD ACTIVITY; NO LCL IFR/VFR TFC PAT ACTIVITY. SEVERE - TKOF & LDG PHOHIBITED WO OG/CC APPROVAL; CTC COMMAND POST FOR CURRENT BIRD WATCH CONDITIONS.

TWY D3 RSTRD TO 12500 LBS OR LESS.

MILITARY: MISC: FOR CURRENT MIL RWY CONDITION READING (RCR) CALL OR CTC 914 ARW COMD POST OR 914TH ARW AFLD MANAGEMENT.

RWY 10R/28L CLSD TO SKED ACR OPS MORE THAN 9 PAX SEATS AND NON SKED ACR OPS MORE THAN 30 PAX SEATS EXC TAX.

PPR CTC AFLD MGT DSN: 238-2176, C716-236-2176. AFLD MGMT RQR 48 HR ADVANCE NOTICE FOR PPR AND WILL ARRANGE U.S. CUSTOMS IF NEEDED. U.S. CUSTOMS NOT ON STATION.

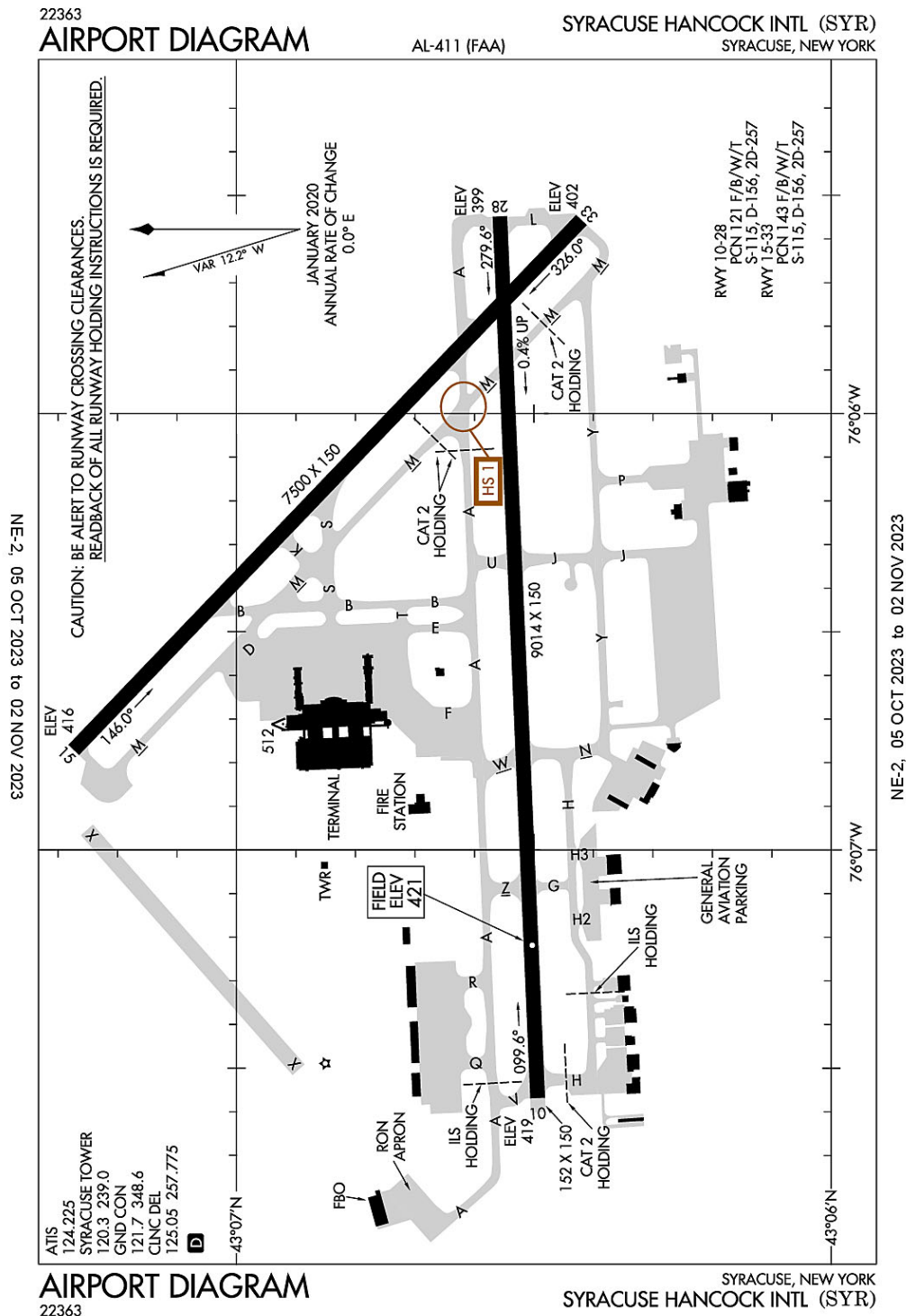
MILITARY: AFRC/ANG: AIRFIELD OPS SVC 1200-0400Z++ MON-FRI EXC HOL. TWYS A, A1, A2, AND A3 PAINTED MRK FADED AND RETRO-REFLECTIVITY INEFFECTIVE.

TWY A, A1, A2, A3, M & L NON-MOV AREAS.

FOR CD WHEN ATCT CLSD CTC BUFFALO ATCT ON FREQ OR 716-626-6920.



### Syracuse, New York Syracuse Hancock International ICAO Identifier KSYR



**Syracuse, NY**  
**Syracuse Hancock Intl**  
**ICAO Identifier KSYR**

**AD 2.2 Aerodrome geographical and administrative data**

- 2.2.1 Reference Point: 43-6-40.252N / 76-6-22.753W
- 2.2.2 From City: 4 miles NE of SYRACUSE, NY
- 2.2.3 Elevation: 421.4 ft
- 2.2.5 Magnetic Variation: 13W (2000)
- 2.2.6 Airport Contact: JASON TERRERI  
1000 COL EILEEN COLLINS BLVD  
SYRACUSE, NY 13212 (315-454-3263)
- 2.2.7 Traffic: IFR/VFR

**AD 2.3 Attendance Schedule**

- 2.3.1 All Months, All Days, All Hours

**AD 2.4 Handling Services and Facilities**

- 2.4.1 Cargo Handling Facilities: YES
- 2.4.2 Fuel Types: 100LL,A
- 2.4.5 Hangar Space: YES
- 2.4.6 Repair Facilities: MAJOR

**AD 2.6 Rescue and Firefighting Services**

- 2.6.1 Aerodrome Category: Class-I certified on 5/1/1973
- 2.6.2 Rescue and Firefighting Services: ARFF Index-C

**AD 2.12 Runway Physical Characteristics**

- 2.12.1 Designation: 10
- 2.12.2 True Bearing: 87
- 2.12.3 Dimensions: 9014 ft x 150 ft
- 2.12.4 PCN: 121 F/B/W/T
- 2.12.5 Coordinates: 43-6-29.5015N / 76-7-34.2763W
- 2.12.6 Threshold Elevation: 418.5 ft
- 2.12.6 Touchdown Zone Elevation: 421.4 ft
  
- 2.12.1 Designation: 28
- 2.12.2 True Bearing: 267
- 2.12.3 Dimensions: 9014 ft x 150 ft
- 2.12.4 PCN: 121 F/B/W/T
- 2.12.5 Coordinates: 43-6-33.4984N / 76-5-32.8925W
- 2.12.6 Threshold Elevation: 399 ft
- 2.12.6 Touchdown Zone Elevation: 412.3 ft
  
- 2.12.1 Designation: 15
- 2.12.2 True Bearing: 134
- 2.12.3 Dimensions: 7500 ft x 150 ft
- 2.12.4 PCN: 143 F/B/W/T
- 2.12.5 Coordinates: 43-7-16.4185N / 76-6-46.2005W
- 2.12.6 Threshold Elevation: 415.5 ft
- 2.12.6 Touchdown Zone Elevation: 416.8 ft

- 2.12.1 Designation: 33
- 2.12.2 True Bearing: 314
- 2.12.3 Dimensions: 7500 ft x 150 ft
- 2.12.4 PCN: 143 F/B/W/T
- 2.12.5 Coordinates: 43-6-25.1095N / 76-5-33.2753W
- 2.12.6 Threshold Elevation: 401.7 ft
- 2.12.6 Touchdown Zone Elevation: 409.4 ft

**AD 2.13 Declared Distances**

- 2.13.1 Designation: 10
- 2.13.2 Take-off Run Available: 9014
- 2.13.3 Take-off Distance Available: 9014
- 2.13.4 Accelerate-Stop Distance Available: 9014
- 2.13.5 Landing Distance Available: 9014

- 2.13.1 Designation: 28
- 2.13.2 Take-off Run Available: 9014
- 2.13.3 Take-off Distance Available: 9014
- 2.13.4 Accelerate-Stop Distance Available: 9014
- 2.13.5 Landing Distance Available: 9014

- 2.13.1 Designation: 15
- 2.13.2 Take-off Run Available: 7500
- 2.13.3 Take-off Distance Available: 7500
- 2.13.4 Accelerate-Stop Distance Available: 7500
- 2.13.5 Landing Distance Available: 7500

- 2.13.1 Designation: 33
- 2.13.2 Take-off Run Available: 7500
- 2.13.3 Take-off Distance Available: 7500
- 2.13.4 Accelerate-Stop Distance Available: 7500
- 2.13.5 Landing Distance Available: 7500

**AD 2.14 Approach and Runway Lighting**

- 2.14.1 Designation: 10
- 2.14.2 Approach Lighting System: MALSR
- 2.14.4 Visual Approach Slope Indicator System: V4L

- 2.14.1 Designation: 28
- 2.14.2 Approach Lighting System: ALSF2
- 2.14.4 Visual Approach Slope Indicator System: P4R

- 2.14.1 Designation: 15
- 2.14.2 Approach Lighting System: MALS
- 2.14.4 Visual Approach Slope Indicator System: V4L

- 2.14.1 Designation: 33
- 2.14.2 Approach Lighting System:

2.14.4 Visual Approach Slope Indicator System: P4L

**AD 2.18 Air Traffic Services Communication Facilities**

2.18.1 Service Designation: ANG OPS

2.18.3 Channel: 379.5

2.18.5 Hours of Operation:

2.18.1 Service Designation: APCH/P DEP/P

2.18.3 Channel: 134.275

2.18.5 Hours of Operation: 24

2.18.1 Service Designation: APCH/P DEP/P

2.18.3 Channel: 279.6

2.18.5 Hours of Operation: 24

2.18.1 Service Designation: APCH/P DEP/P IC

2.18.3 Channel: 126.125

2.18.5 Hours of Operation: 24

2.18.1 Service Designation: APCH/P DEP/P IC

2.18.3 Channel: 269.125

2.18.5 Hours of Operation: 24

2.18.1 Service Designation: AR OPS

2.18.3 Channel: 245.3

2.18.5 Hours of Operation:

2.18.1 Service Designation: ATIS

2.18.3 Channel: 124.225

2.18.5 Hours of Operation: 24

2.18.1 Service Designation: CD/P

2.18.3 Channel: 125.05

2.18.5 Hours of Operation: 24

2.18.1 Service Designation: CD/P

2.18.3 Channel: 257.775

2.18.5 Hours of Operation: 24

2.18.1 Service Designation: CLASS C

2.18.3 Channel: 126.125

2.18.5 Hours of Operation: 24

2.18.1 Service Designation: CLASS C

2.18.3 Channel: 269.125

2.18.5 Hours of Operation: 24

2.18.1 Service Designation: EMERG

2.18.3 Channel: 121.5

2.18.5 Hours of Operation:

2.18.1 Service Designation: EMERG  
2.18.3 Channel: 243  
2.18.5 Hours of Operation:

2.18.1 Service Designation: GND/P  
2.18.3 Channel: 121.7  
2.18.5 Hours of Operation: 24

2.18.1 Service Designation: GND/P  
2.18.3 Channel: 348.6  
2.18.5 Hours of Operation: 24

2.18.1 Service Designation: LCL/P  
2.18.3 Channel: 120.3  
2.18.5 Hours of Operation: 24

2.18.1 Service Designation: LCL/P  
2.18.3 Channel: 239  
2.18.5 Hours of Operation: 24

#### **AD 2.19 Radio Navigation and Landing Aids**

2.19.1 ILS Type: DME for runway 10. Magnetic variation: 13W  
2.19.2 ILS Identification: MRZ  
2.19.5 Coordinates: 43-6-31.27N / 76-5-20.92W  
2.19.6 Site Elevation: 390.5 ft

2.19.1 ILS Type: Glide Slope for runway 10. Magnetic variation: 13W  
2.19.2 ILS Identification: MRZ  
2.19.5 Coordinates: 43-6-26.02N / 76-7-20.146W  
2.19.6 Site Elevation: 422.6 ft

2.19.1 ILS Type: Localizer for runway 10. Magnetic variation: 13W  
2.19.2 ILS Identification: MRZ  
2.19.5 Coordinates: 43-6-33.96N / 76-5-19.01W  
2.19.6 Site Elevation: 395.6 ft

2.19.1 ILS Type: DME for runway 28. Magnetic variation: 13W  
2.19.2 ILS Identification: SYR  
2.19.5 Coordinates: 43-6-31.27N / 76-5-20.92W  
2.19.6 Site Elevation: 390.5 ft

2.19.1 ILS Type: Glide Slope for runway 28. Magnetic variation: 13W  
2.19.2 ILS Identification: SYR  
2.19.5 Coordinates: 43-6-39.474N / 76-5-46.433W  
2.19.6 Site Elevation: 404.1 ft

2.19.1 ILS Type: Inner Marker for runway 28. Magnetic variation: 13W  
2.19.2 ILS Identification: SYR  
2.19.5 Coordinates: 43-6-34.1N / 76-5-18.52W

2.19.6 Site Elevation: 395 ft

2.19.1 ILS Type: Localizer for runway 28. Magnetic variation: 13W

2.19.2 ILS Identification: SYR

2.19.5 Coordinates: 43-6-28.943N / 76-7-51.655W

2.19.6 Site Elevation: 416.8 ft

2.19.1 Navigation Aid Type: VORTAC. Magnetic variation: 11W

2.19.2 Navigation Aid Identification: SYR

2.19.5 Coordinates: 43-9-37.8684N / 76-12-16.4106W

2.19.6 Site Elevation: 453.2 ft

**General Remarks:**

DEER/COYOTE/BIRDS ON INVOF ARPT.

NON-STD MKG ON MIL RAMP.

ANG: HVY ACFT CTC ARPT COMMISSIONER FOR PRK AVBL AT C315-455-3666. ALL TRAN ACFT RQR NS ABTMT BRIEFING.

UAS OPS IN SYRACUSE APCH/DEP AIRSPACE WILL BE CONTROLLED BY SYR ATC AT ALL TIMES.

NO TSNT ACFT PARKING ON MAIN TERMINAL RAMP.

DIRECT CUSTOM NOTIFICATION IS REQUIRED. HOURS OF NOTIFICATION ARE MON-SAT 0800-1700. ARRIVALS OUTSIDE OF THESE HRS MUST MAKE ARRANGEMENTS DURING REGULAR WORK HRS; CALL 315-455-2271.

HVY ACFT CTC ARPT COMMISSIONER FOR PRK AVBL AT C315-455-3263. LIMITED METRO AVAIL AT DSN 243-2185. C315-233-2185 OR CTC OWS DSN 576-9755/9702. ALL TRAN ACFT REQ NOISE ABATEMENT BRIEFING.

NO CHARTER OPER THRU PASSENGER TERMINAL BLDG WITHOUT PRIOR PERMISSION.

RSTD: TWY J AND P SOUTH OF TWY Y CLSD TO CIV OPS.

NOISE ABATEMENT PROCEDURES IN EFFECT.

MILITARY: COMMUNICATIONS - ANG - OPS - 140.425 379.5 REMARKS: (COBRA OPS) CTC ANG OPS 15 MIN PRIOR TO ARR.

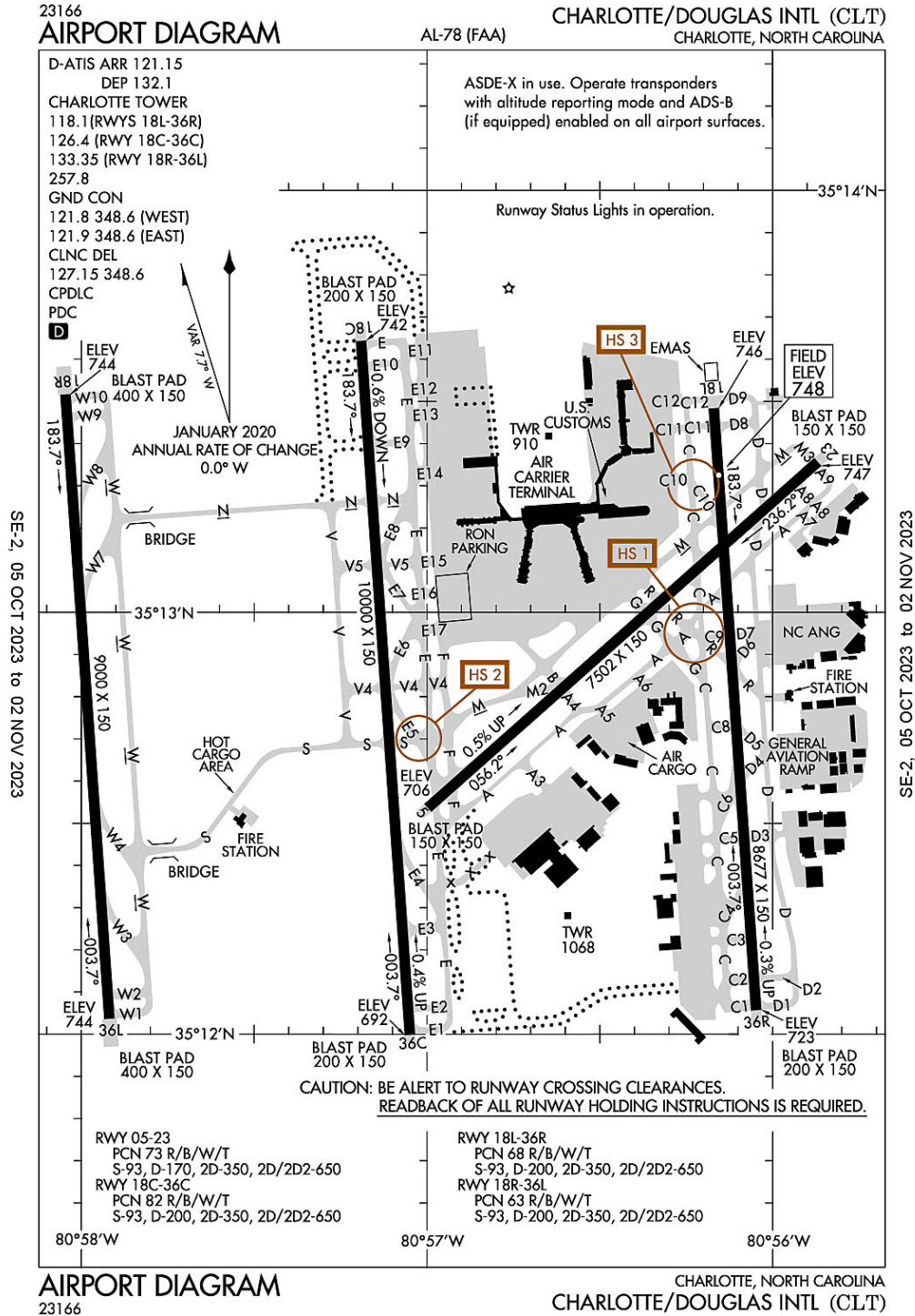
NO JET ENGINE MAINT RUNS ABOVE IDLE BTWN 2300-0600.

CAUTION: TWY J AND P SOUTH OF TWY Y AND ANG RAMP HAVE UNCTL VEH AND EQPT TFC.

UAS OPERATE WITHIN THE CONFINES OF THE SYRACUSE CLASS C, TIMES VARY.

MILITARY: ANG: OPR 1030-2100Z++ MON-THUR EXC HOL. PPR TRANS ACFT OFFL BUS ONLY. AFLD MGR DSN 243-2398, C315-233-2398, AFT DUTY HR CTC C315-233-2398. PPR REQ FOR ALL TRAN ACFT DUE LTD TRANS SVC. NTFY AFLD MGR OF ETA DELAY OVER 30 MIN OR MSN CNL IS RQR.

### Charlotte, North Carolina Charlotte/Douglas International ICAO Identifier KCLT



**Charlotte, NC**  
**Charlotte/Douglas Intl**  
**ICAO Identifier KCLT**

**AD 2.2 Aerodrome geographical and administrative data**

- 2.2.1 Reference Point: 35-12-49.5N / 80-56-56.6W
- 2.2.2 From City: 5 miles W of CHARLOTTE, NC
- 2.2.3 Elevation: 747.9 ft
- 2.2.5 Magnetic Variation: 7W (2000)
- 2.2.6 Airport Contact: HALEY GENTRY  
5601 WILKINSON BLVD.  
CHARLOTTE, NC 28208 (704-359-4000)
- 2.2.7 Traffic: IFR/VFR

**AD 2.3 Attendance Schedule**

- 2.3.1 All Months, All Days, All Hours

**AD 2.4 Handling Services and Facilities**

- 2.4.1 Cargo Handling Facilities: YES
- 2.4.2 Fuel Types: 100LL,A
- 2.4.5 Hangar Space:
- 2.4.6 Repair Facilities: MAJOR

**AD 2.6 Rescue and Firefighting Services**

- 2.6.1 Aerodrome Category: Class-I certified on 5/1/1973
- 2.6.2 Rescue and Firefighting Services: ARFF Index-E

**AD 2.12 Runway Physical Characteristics**

- 2.12.1 Designation: 23
- 2.12.2 True Bearing: 228
- 2.12.3 Dimensions: 7502 ft x 150 ft
- 2.12.4 PCN: 73 R/B/W/T
- 2.12.5 Coordinates: 35-13-21.4183N / 80-55-52.1235W
- 2.12.6 Threshold Elevation: 746.7 ft
- 2.12.6 Touchdown Zone Elevation: 746.7 ft

- 2.12.1 Designation: 05
- 2.12.2 True Bearing: 48
- 2.12.3 Dimensions: 7502 ft x 150 ft
- 2.12.4 PCN: 73 R/B/W/T
- 2.12.5 Coordinates: 35-12-32.2287N / 80-56-59.8045W
- 2.12.6 Threshold Elevation: 705.9 ft
- 2.12.6 Touchdown Zone Elevation: 715.6 ft

- 2.12.1 Designation: 18C
- 2.12.2 True Bearing: 176
- 2.12.3 Dimensions: 10000 ft x 150 ft
- 2.12.4 PCN: 82 R/B/W/T
- 2.12.5 Coordinates: 35-13-38.6269N / 80-57-11.4094W
- 2.12.6 Threshold Elevation: 742 ft
- 2.12.6 Touchdown Zone Elevation: 742 ft



2.12.1 Designation: 36C  
2.12.2 True Bearing: 356  
2.12.3 Dimensions: 10000 ft x 150 ft  
2.12.4 PCN: 82 R/B/W/T  
2.12.5 Coordinates: 35-11-59.9721N / 80-57-2.9217W  
2.12.6 Threshold Elevation: 692.2 ft  
2.12.6 Touchdown Zone Elevation: 706.7 ft

2.12.1 Designation: 18L  
2.12.2 True Bearing: 176  
2.12.3 Dimensions: 8677 ft x 150 ft  
2.12.4 PCN: 68 R/B/W/T  
2.12.5 Coordinates: 35-13-29.0474N / 80-56-10.1652W  
2.12.6 Threshold Elevation: 746 ft  
2.12.6 Touchdown Zone Elevation: 747.9 ft

2.12.1 Designation: 36R  
2.12.2 True Bearing: 356  
2.12.3 Dimensions: 8677 ft x 150 ft  
2.12.4 PCN: 68 R/B/W/T  
2.12.5 Coordinates: 35-12-3.4456N / 80-56-2.822W  
2.12.6 Threshold Elevation: 723.4 ft  
2.12.6 Touchdown Zone Elevation: 726.9 ft

2.12.1 Designation: 18R  
2.12.2 True Bearing: 176  
2.12.3 Dimensions: 9000 ft x 150 ft  
2.12.4 PCN: 63 R/B/W/T  
2.12.5 Coordinates: 35-13-31.0182N / 80-58-2.707W  
2.12.6 Threshold Elevation: 744 ft  
2.12.6 Touchdown Zone Elevation: 744 ft

2.12.1 Designation: 36L  
2.12.2 True Bearing: 356  
2.12.3 Dimensions: 9000 ft x 150 ft  
2.12.4 PCN: 63 R/B/W/T  
2.12.5 Coordinates: 35-12-2.2277N / 80-57-55.0671W  
2.12.6 Threshold Elevation: 743.9 ft  
2.12.6 Touchdown Zone Elevation: 743.9 ft

#### **AD 2.13 Declared Distances**

2.13.1 Designation: 23  
2.13.2 Take-off Run Available: 7502  
2.13.3 Take-off Distance Available: 7502  
2.13.4 Accelerate-Stop Distance Available: 7502  
2.13.5 Landing Distance Available: 7502

2.13.1 Designation: 05  
2.13.2 Take-off Run Available: 7502

2.13.3 Take-off Distance Available: 7502  
2.13.4 Accelerate-Stop Distance Available: 7092  
2.13.5 Landing Distance Available: 7092

2.13.1 Designation: 18C  
2.13.2 Take-off Run Available: 10000  
2.13.3 Take-off Distance Available: 10000  
2.13.4 Accelerate-Stop Distance Available: 10000  
2.13.5 Landing Distance Available: 10000

2.13.1 Designation: 36C  
2.13.2 Take-off Run Available: 10000  
2.13.3 Take-off Distance Available: 10000  
2.13.4 Accelerate-Stop Distance Available: 10000  
2.13.5 Landing Distance Available: 10000

2.13.1 Designation: 18L  
2.13.2 Take-off Run Available: 8676  
2.13.3 Take-off Distance Available: 8676  
2.13.4 Accelerate-Stop Distance Available: 8676  
2.13.5 Landing Distance Available: 8676

2.13.1 Designation: 36R  
2.13.2 Take-off Run Available: 8676  
2.13.3 Take-off Distance Available: 8676  
2.13.4 Accelerate-Stop Distance Available: 8390  
2.13.5 Landing Distance Available: 8390

2.13.1 Designation: 18R  
2.13.2 Take-off Run Available: 9000  
2.13.3 Take-off Distance Available: 9000  
2.13.4 Accelerate-Stop Distance Available: 9000  
2.13.5 Landing Distance Available: 9000

2.13.1 Designation: 36L  
2.13.2 Take-off Run Available: 9000  
2.13.3 Take-off Distance Available: 9000  
2.13.4 Accelerate-Stop Distance Available: 9000  
2.13.5 Landing Distance Available: 9000

#### **AD 2.14 Approach and Runway Lighting**

2.14.1 Designation: 23  
2.14.2 Approach Lighting System:  
2.14.4 Visual Approach Slope Indicator System: P4R

2.14.1 Designation: 05  
2.14.2 Approach Lighting System: MALSR  
2.14.4 Visual Approach Slope Indicator System: P4L

2.14.1 Designation: 18C

2.14.2 Approach Lighting System: MALSR  
2.14.4 Visual Approach Slope Indicator System: P4R

2.14.1 Designation: 36C  
2.14.2 Approach Lighting System: ALSF2  
2.14.4 Visual Approach Slope Indicator System: P4L

2.14.1 Designation: 18L  
2.14.2 Approach Lighting System:  
2.14.4 Visual Approach Slope Indicator System: P4L

2.14.1 Designation: 36R  
2.14.2 Approach Lighting System: ALSF2  
2.14.4 Visual Approach Slope Indicator System: P4R

2.14.1 Designation: 18R  
2.14.2 Approach Lighting System: ALSF2  
2.14.4 Visual Approach Slope Indicator System: P4R

2.14.1 Designation: 36L  
2.14.2 Approach Lighting System: ALSF2  
2.14.4 Visual Approach Slope Indicator System: P4L

**AD 2.18 Air Traffic Services Communication Facilities**

2.18.1 Service Designation: ALCP  
2.18.3 Channel: 292.25  
2.18.5 Hours of Operation:

2.18.1 Service Designation: APCH/P  
2.18.3 Channel: 126.15  
2.18.5 Hours of Operation: 24

2.18.1 Service Designation: APCH/P DEP/P IC (120-295 8000 FT & BLW)  
2.18.3 Channel: 120.05  
2.18.5 Hours of Operation: 24

2.18.1 Service Designation: APCH/P DEP/P IC (246-074 ABV 8000 FT)  
2.18.3 Channel: 120.5  
2.18.5 Hours of Operation: 24

2.18.1 Service Designation: APCH/P DEP/P IC (075-245 ABV 8000 FT)  
2.18.3 Channel: 124  
2.18.5 Hours of Operation: 24

2.18.1 Service Designation: APCH/P DEP/P IC (001-119 8000 FT & BLW)  
2.18.3 Channel: 128.325  
2.18.5 Hours of Operation: 24

2.18.1 Service Designation: APCH/P DEP/P IC (296-360 8000 FT & BLW)  
2.18.3 Channel: 134.75

2.18.5 Hours of Operation: 24

2.18.1 Service Designation: APCH/P DEP/P IC (180-359)

2.18.3 Channel: 257.2

2.18.5 Hours of Operation: 24

2.18.1 Service Designation: APCH/P DEP/P IC (360-179)

2.18.3 Channel: 307.8

2.18.5 Hours of Operation: 24

2.18.1 Service Designation: BANKR STAR

2.18.3 Channel: 135.6

2.18.5 Hours of Operation: 24

2.18.1 Service Designation: BANKR STAR

2.18.3 Channel: 377.15

2.18.5 Hours of Operation: 24

2.18.1 Service Designation: BARMY DP

2.18.3 Channel: 124

2.18.5 Hours of Operation: 24

2.18.1 Service Designation: BARMY DP

2.18.3 Channel: 307.8

2.18.5 Hours of Operation: 24

2.18.1 Service Designation: BEAVY DP (RWY 36L, 36C)

2.18.3 Channel: 120.5

2.18.5 Hours of Operation: 24

2.18.1 Service Designation: BEAVY DP (RWY 18L, 18R, 18C, 36R)

2.18.3 Channel: 124

2.18.5 Hours of Operation: 24

2.18.1 Service Designation: BEAVY DP (RWY 36L, 36C)

2.18.3 Channel: 257.2

2.18.5 Hours of Operation: 24

2.18.1 Service Designation: BEAVY DP (RWY 18R, 18L, 18C, 36R)

2.18.3 Channel: 307.8

2.18.5 Hours of Operation: 24

2.18.1 Service Designation: BOBZY DP

2.18.3 Channel: 120.5

2.18.5 Hours of Operation: 24

2.18.1 Service Designation: BOBZY DP

2.18.3 Channel: 257.2

2.18.5 Hours of Operation: 24

2.18.1 Service Designation: BTSEY STAR

2.18.3 Channel: 125.35

2.18.5 Hours of Operation: 24

2.18.1 Service Designation: CD/P

2.18.3 Channel: 127.15

2.18.5 Hours of Operation: 24

2.18.1 Service Designation: CD/P

2.18.3 Channel: 348.6

2.18.5 Hours of Operation: 24

2.18.1 Service Designation: CHARLOTTE DP (BUCKL TRANSITION, RWY 18L, 18R, 18C, 36R)

2.18.3 Channel: 307.8

2.18.5 Hours of Operation: 24

2.18.1 Service Designation: CHARLOTTE DP (HARAY & PITY TRANSITIONS. RWY 36L, 36C)

2.18.3 Channel: 120.5

2.18.5 Hours of Operation: 24

2.18.1 Service Designation: CHARLOTTE DP (RWY 18L, 18R, 18C, 36R)

2.18.3 Channel: 124

2.18.5 Hours of Operation: 24

2.18.1 Service Designation: CHARLOTTE DP (BUCKL, GANTS, LILLS & RUNIE TRANSITIONS.)

2.18.3 Channel: 124

2.18.5 Hours of Operation: 24

2.18.1 Service Designation: CHARLOTTE DP (HARAY & PITY TRANSITION. RWY 36L, 36C)

2.18.3 Channel: 257.2

2.18.5 Hours of Operation: 24

2.18.1 Service Designation: CHARLOTTE DP (GANTS, LILLS & RUNIE TRANSITIONS)

2.18.3 Channel: 307.8

2.18.5 Hours of Operation: 24

2.18.1 Service Designation: CHSLY STAR

2.18.3 Channel: 126.15

2.18.5 Hours of Operation: 24

2.18.1 Service Designation: CHSLY STAR

2.18.3 Channel: 282.325

2.18.5 Hours of Operation: 24

2.18.1 Service Designation: CLASS B (120-295 8000 FT & BLW)

2.18.3 Channel: 120.05

2.18.5 Hours of Operation: 24

2.18.1 Service Designation: CLASS B (246-074 ABV 8000 FT)

2.18.3 Channel: 120.5

2.18.5 Hours of Operation: 24

2.18.1 Service Designation: CLASS B (075-245 ABV 8000 FT)  
2.18.3 Channel: 124  
2.18.5 Hours of Operation: 24

2.18.1 Service Designation: CLASS B (001-119 8000 FT & BLW)  
2.18.3 Channel: 128.325  
2.18.5 Hours of Operation: 24

2.18.1 Service Designation: CLASS B (296-360 8000 FT & BLW)  
2.18.3 Channel: 134.75  
2.18.5 Hours of Operation: 24

2.18.1 Service Designation: CLASS B (180-359)  
2.18.3 Channel: 257.2  
2.18.5 Hours of Operation: 24

2.18.1 Service Designation: CLASS B (360-179)  
2.18.3 Channel: 307.8  
2.18.5 Hours of Operation: 24

2.18.1 Service Designation: D-ATIS (ARR)  
2.18.3 Channel: 121.15  
2.18.5 Hours of Operation: 24

2.18.1 Service Designation: D-ATIS (DEP)  
2.18.3 Channel: 132.1  
2.18.5 Hours of Operation: 24

2.18.1 Service Designation: EMERG  
2.18.3 Channel: 121.5  
2.18.5 Hours of Operation:

2.18.1 Service Designation: EMERG  
2.18.3 Channel: 243  
2.18.5 Hours of Operation:

2.18.1 Service Designation: ESTRR DP  
2.18.3 Channel: 120.5  
2.18.5 Hours of Operation: 24

2.18.1 Service Designation: ESTRR DP  
2.18.3 Channel: 257.2  
2.18.5 Hours of Operation: 24

2.18.1 Service Designation: FILPZ STAR  
2.18.3 Channel: 125.35  
2.18.5 Hours of Operation: 24

2.18.1 Service Designation: FILPZ STAR  
2.18.3 Channel: 257.2  
2.18.5 Hours of Operation: 24

2.18.1 Service Designation: GND/P (WEST)  
2.18.3 Channel: 121.8  
2.18.5 Hours of Operation: 24

2.18.1 Service Designation: GND/P (EAST)  
2.18.3 Channel: 121.9  
2.18.5 Hours of Operation: 24

2.18.1 Service Designation: GND/P  
2.18.3 Channel: 348.6  
2.18.5 Hours of Operation: 24

2.18.1 Service Designation: ICONS DP (RWY 36L, 36C)  
2.18.3 Channel: 120.5  
2.18.5 Hours of Operation: 24

2.18.1 Service Designation: ICONS DP (RWY 18L, 18R, 18C, 36R)  
2.18.3 Channel: 124  
2.18.5 Hours of Operation: 24

2.18.1 Service Designation: ICONS DP (RWY 36L, 36C)  
2.18.3 Channel: 257.2  
2.18.5 Hours of Operation: 24

2.18.1 Service Designation: ICONS DP (RWY 18R, 18L, 18C, 36R)  
2.18.3 Channel: 307.8  
2.18.5 Hours of Operation: 24

2.18.1 Service Designation: JOJJO DP  
2.18.3 Channel: 120.5  
2.18.5 Hours of Operation: 24

2.18.1 Service Designation: JOJJO DP  
2.18.3 Channel: 257.2  
2.18.5 Hours of Operation: 24

2.18.1 Service Designation: JONZE STAR  
2.18.3 Channel: 135.6  
2.18.5 Hours of Operation: 24

2.18.1 Service Designation: JONZE STAR  
2.18.3 Channel: 377.15  
2.18.5 Hours of Operation: 24

2.18.1 Service Designation: JOOLS STAR  
2.18.3 Channel: 135.6  
2.18.5 Hours of Operation: 24

2.18.1 Service Designation: JOOLS STAR  
2.18.3 Channel: 377.15

2.18.5 Hours of Operation: 24

2.18.1 Service Designation: KERMIT DP (235-055)

2.18.3 Channel: 120.5

2.18.5 Hours of Operation: 24

2.18.1 Service Designation: KERMIT DP (055-235)

2.18.3 Channel: 124

2.18.5 Hours of Operation: 24

2.18.1 Service Designation: KERMIT DP (235-055)

2.18.3 Channel: 257.2

2.18.5 Hours of Operation: 24

2.18.1 Service Designation: KERMIT DP (055-235)

2.18.3 Channel: 307.8

2.18.5 Hours of Operation: 24

2.18.1 Service Designation: KILNS DP

2.18.3 Channel: 124

2.18.5 Hours of Operation: 24

2.18.1 Service Designation: KILNS DP

2.18.3 Channel: 307.8

2.18.5 Hours of Operation: 24

2.18.1 Service Designation: KNIGHTS DP (DEBIE, NEANO TRANSITIONS)

2.18.3 Channel: 120.05

2.18.5 Hours of Operation: 24

2.18.1 Service Designation: KNIGHTS DP (FLYYN, CEGAL TRANSITIONS, 18L, 18C, 18R)

2.18.3 Channel: 120.05

2.18.5 Hours of Operation: 24

2.18.1 Service Designation: KNIGHTS DP (FLYYN, CEGAL TRANSITIONS RWY 36L, 36C, 36R)

2.18.3 Channel: 120.5

2.18.5 Hours of Operation: 24

2.18.1 Service Designation: KNIGHTS DP (055-235)

2.18.3 Channel: 128.325

2.18.5 Hours of Operation: 24

2.18.1 Service Designation: KNIGHTS DP (PEKNN, LILLS, HAMLN, ANDYS TRANSITIONS)

2.18.3 Channel: 128.325

2.18.5 Hours of Operation: 24

2.18.1 Service Designation: KNIGHTS DP (235-055)

2.18.3 Channel: 257.2

2.18.5 Hours of Operation: 24

2.18.1 Service Designation: KNIGHTS DP (055-235)



2.18.3 Channel: 307.8  
2.18.5 Hours of Operation: 24

2.18.1 Service Designation: KRITR DP  
2.18.3 Channel: 120.5  
2.18.5 Hours of Operation: 24

2.18.1 Service Designation: KRITR DP  
2.18.3 Channel: 257.2  
2.18.5 Hours of Operation: 24

2.18.1 Service Designation: KWEEN DP (RWY 36L, 36C)  
2.18.3 Channel: 120.5  
2.18.5 Hours of Operation: 24

2.18.1 Service Designation: KWEEN DP (RWY 18L, 18R, 18C, 36R)  
2.18.3 Channel: 124  
2.18.5 Hours of Operation: 24

2.18.1 Service Designation: KWEEN DP (RWY 36L, 36C)  
2.18.3 Channel: 257.2  
2.18.5 Hours of Operation: 24

2.18.1 Service Designation: KWEEN DP (RWY 18R, 18L, 18C, 36R)  
2.18.3 Channel: 307.8  
2.18.5 Hours of Operation: 24

2.18.1 Service Designation: LCL/P (RWY 18L/36R)  
2.18.3 Channel: 118.1  
2.18.5 Hours of Operation: 24

2.18.1 Service Designation: LCL/P (RWY 18C/36C)  
2.18.3 Channel: 126.4  
2.18.5 Hours of Operation: 24

2.18.1 Service Designation: LCL/P (RWY 18R/36L)  
2.18.3 Channel: 133.35  
2.18.5 Hours of Operation: 24

2.18.1 Service Designation: LCL/P  
2.18.3 Channel: 257.8  
2.18.5 Hours of Operation: 24

2.18.1 Service Designation: LIILS DP  
2.18.3 Channel: 124  
2.18.5 Hours of Operation: 24

2.18.1 Service Designation: LIINN STAR  
2.18.3 Channel: 125.35  
2.18.5 Hours of Operation: 24

2.18.1 Service Designation: LIINN STAR  
2.18.3 Channel: 257.2  
2.18.5 Hours of Operation: 24

2.18.1 Service Designation: LILLS DP  
2.18.3 Channel: 307.8  
2.18.5 Hours of Operation: 24

2.18.1 Service Designation: MAJIC STAR  
2.18.3 Channel: 126.15  
2.18.5 Hours of Operation: 24

2.18.1 Service Designation: MAJIC STAR  
2.18.3 Channel: 282.325  
2.18.5 Hours of Operation: 24

2.18.1 Service Designation: MLEET STAR  
2.18.3 Channel: 126.15  
2.18.5 Hours of Operation: 24

2.18.1 Service Designation: MLEET STAR  
2.18.3 Channel: 282.325  
2.18.5 Hours of Operation: 24

2.18.1 Service Designation: PARQR STAR  
2.18.3 Channel: 125.35  
2.18.5 Hours of Operation: 24

2.18.1 Service Designation: PARQR STAR  
2.18.3 Channel: 257.2  
2.18.5 Hours of Operation: 24

2.18.1 Service Designation: RASLN STAR  
2.18.3 Channel: 126.15  
2.18.5 Hours of Operation: 24

2.18.1 Service Designation: RASLN STAR  
2.18.3 Channel: 282.325  
2.18.5 Hours of Operation: 24

2.18.1 Service Designation: STOCR STAR  
2.18.3 Channel: 126.15  
2.18.5 Hours of Operation: 24

2.18.1 Service Designation: STOCR STAR  
2.18.3 Channel: 282.325  
2.18.5 Hours of Operation: 24

2.18.1 Service Designation: UNARM STAR  
2.18.3 Channel: 135.6  
2.18.5 Hours of Operation: 24

2.18.1 Service Designation: UNARM STAR  
2.18.3 Channel: 377.15  
2.18.5 Hours of Operation: 24

2.18.1 Service Designation: WEAZL DP  
2.18.3 Channel: 120.5  
2.18.5 Hours of Operation: 24

2.18.1 Service Designation: WEAZL DP  
2.18.3 Channel: 257.2  
2.18.5 Hours of Operation: 24

**AD 2.19 Radio Navigation and Landing Aids**

2.19.1 ILS Type: Glide Slope for runway 05. Magnetic variation: 7W  
2.19.2 ILS Identification: CLT  
2.19.5 Coordinates: 35-12-43.05N / 80-56-52.18W  
2.19.6 Site Elevation: 695.1 ft

2.19.1 ILS Type: Localizer for runway 05. Magnetic variation: 7W  
2.19.2 ILS Identification: CLT  
2.19.5 Coordinates: 35-13-26.34N / 80-55-45.36W  
2.19.6 Site Elevation: 738.2 ft

2.19.1 ILS Type: DME for runway 23. Magnetic variation: 7W  
2.19.2 ILS Identification: APU  
2.19.5 Coordinates: 35-12-21.2833N / 80-57-10.052W  
2.19.6 Site Elevation: 699.4 ft

2.19.1 ILS Type: Glide Slope for runway 23. Magnetic variation: 7W  
2.19.2 ILS Identification: APU  
2.19.5 Coordinates: 35-13-12.1531N / 80-56-0.0758W  
2.19.6 Site Elevation: 737.7 ft

2.19.1 ILS Type: Localizer for runway 23. Magnetic variation: 7W  
2.19.2 ILS Identification: APU  
2.19.5 Coordinates: 35-12-23.38N / 80-57-11.99W  
2.19.6 Site Elevation: 704 ft

2.19.1 ILS Type: DME for runway 18C. Magnetic variation: 7W  
2.19.2 ILS Identification: PEP  
2.19.5 Coordinates: 35-11-50.2369N / 80-56-58.6363W  
2.19.6 Site Elevation: 684.4 ft

2.19.1 ILS Type: Glide Slope for runway 18C. Magnetic variation: 7W  
2.19.2 ILS Identification: PEP  
2.19.5 Coordinates: 35-13-26.9102N / 80-57-15.2356W  
2.19.6 Site Elevation: 731.4 ft

2.19.1 ILS Type: Localizer for runway 18C. Magnetic variation: 7W

2.19.2 ILS Identification: PEP  
2.19.5 Coordinates: 35-11-48.5979N / 80-57-1.9439W  
2.19.6 Site Elevation: 683.3 ft

2.19.1 ILS Type: Glide Slope for runway 36C. Magnetic variation: 7W  
2.19.2 ILS Identification: DQG  
2.19.5 Coordinates: 35-12-9.1687N / 80-57-8.5431W  
2.19.6 Site Elevation: 691.1 ft

2.19.1 ILS Type: Inner Marker for runway 36C. Magnetic variation: 7W  
2.19.2 ILS Identification: DQG  
2.19.5 Coordinates: 35-11-48.7253N / 80-57-1.9507W  
2.19.6 Site Elevation: 682.9 ft

2.19.1 ILS Type: Localizer for runway 36C. Magnetic variation: 7W  
2.19.2 ILS Identification: DQG  
2.19.5 Coordinates: 35-13-49.83N / 80-57-12.38W  
2.19.6 Site Elevation: 748.3 ft

2.19.1 ILS Type: DME for runway 18L. Magnetic variation: 7W  
2.19.2 ILS Identification: VKQ  
2.19.5 Coordinates: 35-11-50.25N / 80-56-4.63W  
2.19.6 Site Elevation: 710 ft

2.19.1 ILS Type: Glide Slope for runway 18L. Magnetic variation: 7W  
2.19.2 ILS Identification: VKQ  
2.19.5 Coordinates: 35-13-19.2609N / 80-56-5.097W  
2.19.6 Site Elevation: 743.5 ft

2.19.1 ILS Type: Localizer for runway 18L. Magnetic variation: 7W  
2.19.2 ILS Identification: VKQ  
2.19.5 Coordinates: 35-11-50.5994N / 80-56-1.7186W  
2.19.6 Site Elevation: 719.2 ft

2.19.1 ILS Type: DME for runway 36R. Magnetic variation: 7W  
2.19.2 ILS Identification: BQC  
2.19.5 Coordinates: 35-13-33.1089N / 80-56-6.903W  
2.19.6 Site Elevation: 752.3 ft

2.19.1 ILS Type: Glide Slope for runway 36R. Magnetic variation: 7W  
2.19.2 ILS Identification: BQC  
2.19.5 Coordinates: 35-12-14.0034N / 80-55-58.8923W  
2.19.6 Site Elevation: 717.3 ft

2.19.1 ILS Type: Localizer for runway 36R. Magnetic variation: 7W  
2.19.2 ILS Identification: BQC  
2.19.5 Coordinates: 35-13-33.7034N / 80-56-10.5664W  
2.19.6 Site Elevation: 741.2 ft

2.19.1 ILS Type: DME for runway 18R. Magnetic variation: 7W  
2.19.2 ILS Identification: RGS

2.19.5 Coordinates: 35-12-13.2565N / 80-58-1.0908W

2.19.6 Site Elevation: 743.8 ft

2.19.1 ILS Type: Glide Slope for runway 18R. Magnetic variation: 7W

2.19.2 ILS Identification: RGS

2.19.5 Coordinates: 35-13-20.0955N / 80-58-6.7207W

2.19.6 Site Elevation: 733.9 ft

2.19.1 ILS Type: Inner Marker for runway 18R. Magnetic variation: 7W

2.19.2 ILS Identification: RGS

2.19.5 Coordinates: 35-13-38.8124N / 80-58-3.3825W

2.19.6 Site Elevation: 738.6 ft

2.19.1 ILS Type: Localizer for runway 18R. Magnetic variation: 7W

2.19.2 ILS Identification: RGS

2.19.5 Coordinates: 35-11-51.8431N / 80-57-54.1735W

2.19.6 Site Elevation: 738.1 ft

2.19.1 ILS Type: DME for runway 36L. Magnetic variation: 7W

2.19.2 ILS Identification: XUU

2.19.5 Coordinates: 35-13-19.8318N / 80-58-6.8193W

2.19.6 Site Elevation: 738.9 ft

2.19.1 ILS Type: Glide Slope for runway 36L. Magnetic variation: 7W

2.19.2 ILS Identification: XUU

2.19.5 Coordinates: 35-12-12.9817N / 80-58-0.9403W

2.19.6 Site Elevation: 732.3 ft

2.19.1 ILS Type: Inner Marker for runway 36L. Magnetic variation: 7W

2.19.2 ILS Identification: XUU

2.19.5 Coordinates: 35-11-54.4339N / 80-57-54.3965W

2.19.6 Site Elevation: 738.8 ft

2.19.1 ILS Type: Localizer for runway 36L. Magnetic variation: 7W

2.19.2 ILS Identification: XUU

2.19.5 Coordinates: 35-13-41.4048N / 80-58-3.6016W

2.19.6 Site Elevation: 737.3 ft

2.19.1 Navigation Aid Type: VOR/DME. Magnetic variation: 5W

2.19.2 Navigation Aid Identification: CLT

2.19.5 Coordinates: 35-11-25.0392N / 80-57-6.3124W

2.19.6 Site Elevation: 731.7 ft

**General Remarks:**

TWY C10 RSTRD TO ACFT WITH WINGSPAN LESS THAN 171 FT WHEN EXITING RWY.

CLT RAMP, NON-MOVMT AREA, IS CTLD RAMP; CTC RAMP CTL PRIOR TO ENTERING.

TWY C10 UNUSBL FOR TXG ONTO RWY 18L/36R.

MILITARY: ANG: CTC COMD POST 30 MIN PRIOR LDG. AMOPS/COMD POST - 292.25 (CALL NEWSREEL).

SUCCESSIVE OR SIMULTANEOUS DEPARTURES FROM RWY 18L AND RWY 18C ARE APPROVED WITH COURSE DIVERGENCE BEGINNING NO FURTHER THAN 4 MILES FROM END OF RWY.

TRML RAMP ORANGE TXL AT SPOT 28N BETWEEN CONCOURSE D & E ALLEY MAX WINGSPAN 94 FT.

DUAL TAXI BTN DEP CALL SPOTS 11/12 AND 13N/13S RSTRD TO ONE ACFT LESS THAN 214 FT AND ONE ACFT LESS THAN 118 FT OR TWO ACFT LESS THAN 171 FT.

RWY SFC COND INFO DURG DUTY HRS PHONE ANG OPS V583-9177/9144 OR AIRBORNE 292.2.

TWY M BETWEEN THE TERMINAL RAMP AND TWY C, AS WELL AS TWY C NORTH OF TWY M, ARE RESTRICTED TO GROUP V AIRCRAFT WITH A WINGSPAN LESS THAN 214 FT (65M).

TRML RAMP BLUE TXL AT SPOT 28S BTN CONCOURSE D & E ALLEY MAX WINGSPAN 118 FT.

DUAL TAXI BTN DEP CALL SPOTS 22/23 AND 24N/24S RSTRD TO ACFT WITH WINGSPANS LESS THAN 118 FT.

TRML RAMP BLUE TXL FROM SPOT 29W TO SPOT 34S MAX WINGSPAN 82 FT.

ALL ACFT ARE PROHIBITED FM EXITING RWY 36R SEBD AT TWY R.

RWY STATUS LGTS IN OPR.

TWY C4 AND C6: WHEN TAXIING AIRCRAFT WITH COCKPIT TO MAIN GEAR DISTANCE GREATER THAN 90 FT, PILOT MUST PERFORM JUDGEMENTAL OVERSTEERING INSTEAD OF COCKPIT OVER CENTERLINE STEERING.

TWY D, RESTRICTED TO 15 MPH OR LESS WITH WINGSPAN 171 FT AND GREATER.

AIRPLANE DESIGN GROUP-V AND ABV ACFT ARE PROHIBITED FM DEP RWY 18L.

TRML RAMP ORANGE TXL FROM SPOT 26S TO SPOT 27E MAX WINGSPAN 118 FT.

GROUP IV ACFT WITH A WINGSPAN GTR THAN 118 FT ARE PROHIBITED FM EXITING RWY 18L/36R AT TWY C10.

GROUP III ACFT WITH A WINGSPAN GTR THAN 79 FT ARE PROHIBITED FM MAKING A NBND TURN ONTO TWY C WHEN TAXIING WB ON TWY A.

15 MPH SPEED RESTRICTION ON TWY C FROM THE APPROACH OF RWY 18L TO RWY 05/23, AND TWY M FROM THE APRON TO RWY 18L/36R.

TRML RAMP BLUE TXL FROM SPOT 26N TO SPOT 27W MAX WINGSPAN 118 FT.

BE ALERT FOR FLOCKS OF MIGRATORY BIRDS ON & INVOF ARPT.

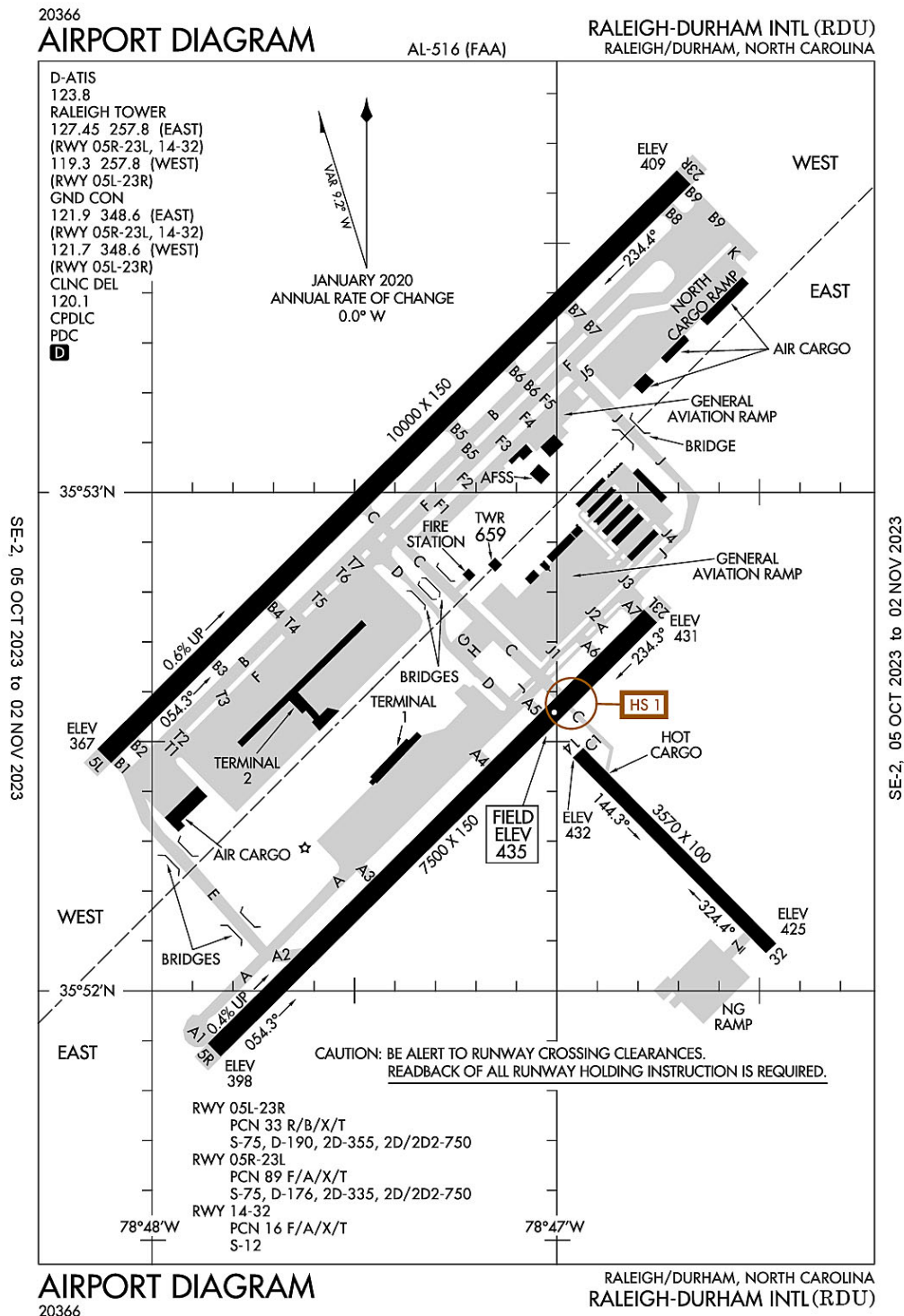
GROUP III ACFT WITH A WINGSPAN GTR THAN 79 FT ARE PROHIBITED FM MAKING A SBND TURN ONTO TWY C WHEN TAXIING NWBND ON TWY R.

ASDE-X IN USE. OPERATE TRANSPONDERS WITH ALTITUDE REPORTING MODE AND ADS-B (IF EQUIPPED) ENABLED ON ALL AIRPORT SURFACES.

TRML RAMP YELLOW TXL FROM SPOT 29C TO SPOT 33C MAX WINGSPAN 118 FT.

TRML RAMP ORANGE TXL FROM SPOT 29E TO SPOT 34N MAX WINGSPAN 82 FT.

**Raleigh-Durham, North Carolina**  
**Raleigh-Durham International**  
**ICAO Identifier KRDU**



**Raleigh/Durham, NC**  
**Raleigh-Durham Intl**  
**ICAO Identifier KRDU**

**AD 2.2 Aerodrome geographical and administrative data**

- 2.2.1 Reference Point: 35-52-39.5N / 78-47-14.9W
- 2.2.2 From City: 9 miles NW of RALEIGH/DURHAM, NC
- 2.2.3 Elevation: 435.2 ft
- 2.2.5 Magnetic Variation: 9W (2020)
- 2.2.6 Airport Contact: MICHAEL LANDGUTH  
RALEIGH-DURHAM ARPT AUTH  
RDU AIRPORT, NC 27623 ((919) 840-7701)
- 2.2.7 Traffic: IFR/VFR

**AD 2.3 Attendance Schedule**

- 2.3.1 All Months, All Days, All Hours

**AD 2.4 Handling Services and Facilities**

- 2.4.1 Cargo Handling Facilities: YES
- 2.4.2 Fuel Types: 100LL,A
- 2.4.5 Hangar Space: YES
- 2.4.6 Repair Facilities: MAJOR

**AD 2.6 Rescue and Firefighting Services**

- 2.6.1 Aerodrome Category: Class-I certified on 5/1/1973
- 2.6.2 Rescue and Firefighting Services: ARFF Index-D

**AD 2.12 Runway Physical Characteristics**

- 2.12.1 Designation: 05L
- 2.12.2 True Bearing: 45
- 2.12.3 Dimensions: 10000 ft x 150 ft
- 2.12.4 PCN: 33 R/B/X/T
- 2.12.5 Coordinates: 35-52-28.016N / 78-48-7.069W
- 2.12.6 Threshold Elevation: 366.8 ft
- 2.12.6 Touchdown Zone Elevation: 384.3 ft
  
- 2.12.1 Designation: 23R
- 2.12.2 True Bearing: 225
- 2.12.3 Dimensions: 10000 ft x 150 ft
- 2.12.4 PCN: 33 R/B/X/T
- 2.12.5 Coordinates: 35-53-37.7657N / 78-46-40.9198W
- 2.12.6 Threshold Elevation: 408.6 ft
- 2.12.6 Touchdown Zone Elevation: 408.6 ft
  
- 2.12.1 Designation: 05R
- 2.12.2 True Bearing: 45
- 2.12.3 Dimensions: 7500 ft x 150 ft
- 2.12.4 PCN: 89 F/A/X/T
- 2.12.5 Coordinates: 35-51-52.6684N / 78-47-50.4174W
- 2.12.6 Threshold Elevation: 397.5 ft
- 2.12.6 Touchdown Zone Elevation: 419.8 ft



2.12.1 Designation: 23L  
2.12.2 True Bearing: 225  
2.12.3 Dimensions: 7500 ft x 150 ft  
2.12.4 PCN: 89 F/A/X/T  
2.12.5 Coordinates: 35-52-44.9832N / 78-46-45.8171W  
2.12.6 Threshold Elevation: 430.7 ft  
2.12.6 Touchdown Zone Elevation: 435.2 ft

2.12.1 Designation: 14  
2.12.2 True Bearing: 135  
2.12.3 Dimensions: 3570 ft x 100 ft  
2.12.4 PCN: 16 F/A/X/T  
2.12.5 Coordinates: 35-52-30.1119N / 78-46-57.6427W  
2.12.6 Threshold Elevation: 432.1 ft  
2.12.6 Touchdown Zone Elevation: 432.1 ft

2.12.1 Designation: 32  
2.12.2 True Bearing: 315  
2.12.3 Dimensions: 3570 ft x 100 ft  
2.12.4 PCN: 16 F/A/X/T  
2.12.5 Coordinates: 35-52-5.0792N / 78-46-27.0499W  
2.12.6 Threshold Elevation: 424.7 ft  
2.12.6 Touchdown Zone Elevation: 428.7 ft

#### **AD 2.13 Declared Distances**

2.13.1 Designation: 05L  
2.13.2 Take-off Run Available: 10000  
2.13.3 Take-off Distance Available: 10000  
2.13.4 Accelerate-Stop Distance Available: 10000  
2.13.5 Landing Distance Available: 10000

2.13.1 Designation: 23R  
2.13.2 Take-off Run Available: 10000  
2.13.3 Take-off Distance Available: 10000  
2.13.4 Accelerate-Stop Distance Available: 10000  
2.13.5 Landing Distance Available: 10000

2.13.1 Designation: 05R  
2.13.2 Take-off Run Available: 7500  
2.13.3 Take-off Distance Available: 7500  
2.13.4 Accelerate-Stop Distance Available: 7500  
2.13.5 Landing Distance Available: 7500

2.13.1 Designation: 23L  
2.13.2 Take-off Run Available: 7500  
2.13.3 Take-off Distance Available: 7500  
2.13.4 Accelerate-Stop Distance Available: 7500  
2.13.5 Landing Distance Available: 7500

2.13.1 Designation: 14  
2.13.2 Take-off Run Available:  
2.13.3 Take-off Distance Available:  
2.13.4 Accelerate-Stop Distance Available:  
2.13.5 Landing Distance Available:

2.13.1 Designation: 32  
2.13.2 Take-off Run Available:  
2.13.3 Take-off Distance Available:  
2.13.4 Accelerate-Stop Distance Available:  
2.13.5 Landing Distance Available:

#### **AD 2.14 Approach and Runway Lighting**

2.14.1 Designation: 05L  
2.14.2 Approach Lighting System: MALSR  
2.14.4 Visual Approach Slope Indicator System: P4L

2.14.1 Designation: 23R  
2.14.2 Approach Lighting System: ALSF2  
2.14.4 Visual Approach Slope Indicator System: P4L

2.14.1 Designation: 05R  
2.14.2 Approach Lighting System: MALSR  
2.14.4 Visual Approach Slope Indicator System: P4L

2.14.1 Designation: 23L  
2.14.2 Approach Lighting System: MALSR  
2.14.4 Visual Approach Slope Indicator System: P4L

2.14.1 Designation: 14  
2.14.2 Approach Lighting System:  
2.14.4 Visual Approach Slope Indicator System:

2.14.1 Designation: 32  
2.14.2 Approach Lighting System:  
2.14.4 Visual Approach Slope Indicator System: P4L

#### **AD 2.18 Air Traffic Services Communication Facilities**

2.18.1 Service Designation: APCH/P (055-229)  
2.18.3 Channel: 124.95  
2.18.5 Hours of Operation: 24

2.18.1 Service Designation: APCH/P (055-229)  
2.18.3 Channel: 318.2  
2.18.5 Hours of Operation: 24

2.18.1 Service Designation: APCH/P IC (230-054)  
2.18.3 Channel: 127.675  
2.18.5 Hours of Operation: 24

2.18.1 Service Designation: APCH/P IC (230-054)  
2.18.3 Channel: 307.9  
2.18.5 Hours of Operation: 24

2.18.1 Service Designation: BEXGO DP  
2.18.3 Channel: 132.35  
2.18.5 Hours of Operation: 24

2.18.1 Service Designation: BEXGO DP  
2.18.3 Channel: 256.9  
2.18.5 Hours of Operation: 24

2.18.1 Service Designation: BLOGS STAR  
2.18.3 Channel: 124.95  
2.18.5 Hours of Operation: 24

2.18.1 Service Designation: BLOGS STAR  
2.18.3 Channel: 318.2  
2.18.5 Hours of Operation: 24

2.18.1 Service Designation: BRADE STAR  
2.18.3 Channel: 124.95  
2.18.5 Hours of Operation: 24

2.18.1 Service Designation: BRADE STAR  
2.18.3 Channel: 318.2  
2.18.5 Hours of Operation: 24

2.18.1 Service Designation: BUZZY STAR  
2.18.3 Channel: 127.675  
2.18.5 Hours of Operation: 24

2.18.1 Service Designation: BUZZY STAR  
2.18.3 Channel: 307.9  
2.18.5 Hours of Operation: 24

2.18.1 Service Designation: CD/P  
2.18.3 Channel: 120.1  
2.18.5 Hours of Operation: 24

2.18.1 Service Designation: CLASS C (055-229)  
2.18.3 Channel: 125.3  
2.18.5 Hours of Operation: 24

2.18.1 Service Designation: CLASS C (230-054)  
2.18.3 Channel: 132.35  
2.18.5 Hours of Operation: 24

2.18.1 Service Designation: CLASS C (230-054)  
2.18.3 Channel: 256.9

2.18.5 Hours of Operation: 24

2.18.1 Service Designation: CLASS C (055-229)

2.18.3 Channel: 353.675

2.18.5 Hours of Operation: 24

2.18.1 Service Designation: D-ATIS

2.18.3 Channel: 123.8

2.18.5 Hours of Operation: 24

2.18.1 Service Designation: DEP/P (055-229)

2.18.3 Channel: 125.3

2.18.5 Hours of Operation: 24

2.18.1 Service Designation: DEP/P (230-054)

2.18.3 Channel: 132.35

2.18.5 Hours of Operation: 24

2.18.1 Service Designation: DEP/P (230-054)

2.18.3 Channel: 256.9

2.18.5 Hours of Operation: 24

2.18.1 Service Designation: DEP/P (055-229)

2.18.3 Channel: 353.675

2.18.5 Hours of Operation: 24

2.18.1 Service Designation: DEP/P (SOUTH)

2.18.3 Channel: 353.675

2.18.5 Hours of Operation: 24

2.18.1 Service Designation: DMSTR STAR

2.18.3 Channel: 127.675

2.18.5 Hours of Operation: 24

2.18.1 Service Designation: DMSTR STAR

2.18.3 Channel: 307.9

2.18.5 Hours of Operation: 24

2.18.1 Service Designation: EMERG

2.18.3 Channel: 121.5

2.18.5 Hours of Operation:

2.18.1 Service Designation: FINAL (EAST)

2.18.3 Channel: 285.425

2.18.5 Hours of Operation: 24

2.18.1 Service Designation: FINAL CTL

2.18.3 Channel: 124.8

2.18.5 Hours of Operation: 24

2.18.1 Service Designation: GND/P (WEST, RWY 05L/23R)

2.18.3 Channel: 121.7

2.18.5 Hours of Operation: 24

2.18.1 Service Designation: GND/P (EAST, RWY 05R/23L, 14/32)

2.18.3 Channel: 121.9

2.18.5 Hours of Operation: 24

2.18.1 Service Designation: GND/P

2.18.3 Channel: 348.6

2.18.5 Hours of Operation: 24

2.18.1 Service Designation: HOOKZ DP

2.18.3 Channel: 125.3

2.18.5 Hours of Operation: 24

2.18.1 Service Designation: HOOKZ DP

2.18.3 Channel: 353.675

2.18.5 Hours of Operation: 24

2.18.1 Service Designation: HURIC DP

2.18.3 Channel: 125.3

2.18.5 Hours of Operation: 24

2.18.1 Service Designation: HURIC DP

2.18.3 Channel: 353.675

2.18.5 Hours of Operation: 24

2.18.1 Service Designation: LCL/P (WEST, RWY 05L/23R)

2.18.3 Channel: 119.3

2.18.5 Hours of Operation: 24

2.18.1 Service Designation: LCL/P (EAST, RWY 05R/23L, 14/32)

2.18.3 Channel: 127.45

2.18.5 Hours of Operation: 24

2.18.1 Service Designation: LCL/P

2.18.3 Channel: 257.8

2.18.5 Hours of Operation: 24

2.18.1 Service Designation: LWOOD DP

2.18.3 Channel: 132.35

2.18.5 Hours of Operation: 24

2.18.1 Service Designation: LWOOD DP

2.18.3 Channel: 256.9

2.18.5 Hours of Operation: 24

2.18.1 Service Designation: OXFRD DP

2.18.3 Channel: 132.35

2.18.5 Hours of Operation: 24

2.18.1 Service Designation: OXFRD DP  
2.18.3 Channel: 256.9  
2.18.5 Hours of Operation: 24

2.18.1 Service Designation: PACKK DP (055-229)  
2.18.3 Channel: 125.3  
2.18.5 Hours of Operation: 24

2.18.1 Service Designation: PACKK DP (230-054)  
2.18.3 Channel: 132.35  
2.18.5 Hours of Operation: 24

2.18.1 Service Designation: PACKK DP (230-054)  
2.18.3 Channel: 256.9  
2.18.5 Hours of Operation: 24

2.18.1 Service Designation: PACKK DP (055-229)  
2.18.3 Channel: 353.675  
2.18.5 Hours of Operation: 24

2.18.1 Service Designation: RALEIGH DP (055-229)  
2.18.3 Channel: 125.3  
2.18.5 Hours of Operation: 24

2.18.1 Service Designation: RALEIGH DP (230-054)  
2.18.3 Channel: 132.35  
2.18.5 Hours of Operation: 24

2.18.1 Service Designation: RALEIGH DP (230-054)  
2.18.3 Channel: 256.9  
2.18.5 Hours of Operation: 24

2.18.1 Service Designation: RALEIGH DP (055-229)  
2.18.3 Channel: 353.675  
2.18.5 Hours of Operation: 24

2.18.1 Service Designation: ROZBO DP  
2.18.3 Channel: 125.3  
2.18.5 Hours of Operation: 24

2.18.1 Service Designation: ROZBO DP  
2.18.3 Channel: 353.675  
2.18.5 Hours of Operation: 24

2.18.1 Service Designation: SHPRD DP  
2.18.3 Channel: 132.35  
2.18.5 Hours of Operation: 24

2.18.1 Service Designation: SHPRD DP  
2.18.3 Channel: 256.9  
2.18.5 Hours of Operation: 24

2.18.1 Service Designation: TAQLE STAR  
2.18.3 Channel: 124.95  
2.18.5 Hours of Operation: 24

2.18.1 Service Designation: TAQLE STAR  
2.18.3 Channel: 318.2  
2.18.5 Hours of Operation: 24

**AD 2.19 Radio Navigation and Landing Aids**

2.19.1 ILS Type: DME for runway 05L. Magnetic variation: 9W  
2.19.2 ILS Identification: GKK  
2.19.5 Coordinates: 35-53-46.25N / 78-46-25.87W  
2.19.6 Site Elevation: 403 ft

2.19.1 ILS Type: Glide Slope for runway 05L. Magnetic variation: 9W  
2.19.2 ILS Identification: GKK  
2.19.5 Coordinates: 35-52-37.7972N / 78-48-1.884W  
2.19.6 Site Elevation: 365.5 ft

2.19.1 ILS Type: Localizer for runway 05L. Magnetic variation: 9W  
2.19.2 ILS Identification: GKK  
2.19.5 Coordinates: 35-53-48.0693N / 78-46-28.1855W  
2.19.6 Site Elevation: 408.6 ft

2.19.1 ILS Type: DME for runway 23R. Magnetic variation: 9W  
2.19.2 ILS Identification: DMP  
2.19.5 Coordinates: 35-52-20.25N / 78-48-15.21W  
2.19.6 Site Elevation: 358 ft

2.19.1 ILS Type: Glide Slope for runway 23R. Magnetic variation: 9W  
2.19.2 ILS Identification: DMP  
2.19.5 Coordinates: 35-53-32.4744N / 78-46-54.3483W  
2.19.6 Site Elevation: 396.2 ft

2.19.1 ILS Type: Localizer for runway 23R. Magnetic variation: 9W  
2.19.2 ILS Identification: DMP  
2.19.5 Coordinates: 35-52-20.84N / 78-48-15.93W  
2.19.6 Site Elevation: 358.8 ft

2.19.1 ILS Type: DME for runway 05R. Magnetic variation: 9W  
2.19.2 ILS Identification: RDU  
2.19.5 Coordinates: 35-52-54.38N / 78-46-41.19W  
2.19.6 Site Elevation: 412 ft

2.19.1 ILS Type: Glide Slope for runway 05R. Magnetic variation: 9W  
2.19.2 ILS Identification: RDU  
2.19.5 Coordinates: 35-51-57.0189N / 78-47-38.1689W  
2.19.6 Site Elevation: 400.1 ft

2.19.1 ILS Type: Localizer for runway 05R. Magnetic variation: 9W  
2.19.2 ILS Identification: RDU  
2.19.5 Coordinates: 35-52-52.1055N / 78-46-37.0152W  
2.19.6 Site Elevation: 423.6 ft

2.19.1 ILS Type: DME for runway 23L. Magnetic variation: 9W  
2.19.2 ILS Identification: LEI  
2.19.5 Coordinates: 35-51-43.52N / 78-47-54.49W  
2.19.6 Site Elevation: 386 ft

2.19.1 ILS Type: Glide Slope for runway 23L. Magnetic variation: 9W  
2.19.2 ILS Identification: LEI  
2.19.5 Coordinates: 35-52-36.18N / 78-46-52.21W  
2.19.6 Site Elevation: 430.2 ft

2.19.1 ILS Type: Localizer for runway 23L. Magnetic variation: 9W  
2.19.2 ILS Identification: LEI  
2.19.5 Coordinates: 35-51-45.6108N / 78-47-59.1266W  
2.19.6 Site Elevation: 381 ft

2.19.1 Navigation Aid Type: VORTAC. Magnetic variation: 9W  
2.19.2 Navigation Aid Identification: RDU  
2.19.5 Coordinates: 35-52-21.0761N / 78-47-0.0316W  
2.19.6 Site Elevation: 429.2 ft

**General Remarks:**

NG 24 HR PPR FOR JET ACFT & TRANS MIL ACFT - 919-840-7510.

TWY E BEHIND SOUTH CARGO 4 & TWY J BEHIND CORPORATE HANGARS NOT VSBL FM ATCT.

TWY F5 IS CLSD UFN.

TRML 1 ACFT MUST CTC GC ON 121.9 PRIOR TO PUSH. TERMINAL 2 ACFT MUST CTC RAMP TWR ON 130.175 PRIOR TO PUSH.

NO JET ENGINE MAINTENANCE RUNS BETWEEN 0000-0600.

ARPT CLSD TO AIRSHIPS.

NG PPR FOR LDG CTC V582-9181 C(919)664-9181.

ARNG: LTD PRK. ARNG OPS C984-661-6200. CTC FORECAST BASE 10 MIN PRIOR LDG. RAMP CLSD TO ALL F/W EXCEPT ARMY & MIL TRANSPORT WITH PPR, FACILITY HRS 1300-2130Z++ MON-FRI EXC HOL. MAKE APPT FOR AFTER DUTY HRS. OSACOM FLT DET C984-661-6202.

TWY D CLSD TO ACFT WITH WINGSPAN MORE THAN 171 FT WHEN TWY G AND H ARE OCCUPIED.

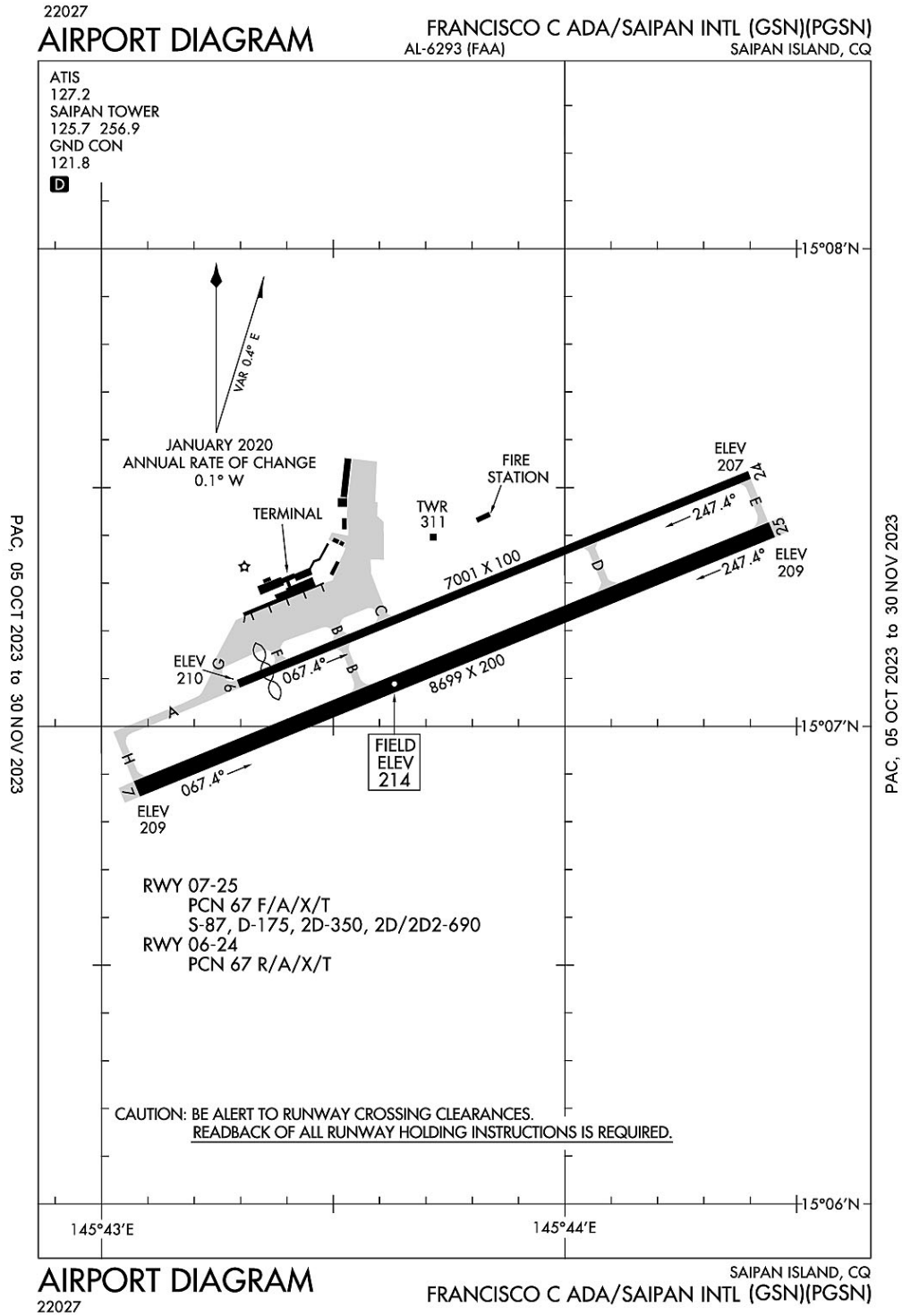
APN TXL F BTN TWY T1 AND TWY T7 CLSD TO ACFT WITH WINGSPAN MORE THAN 171 FT.

ALL TDG V AIRCRAFT TXG ON TWY A ARE RSTD TO TAXI SPD OF 15 MPH.



RSTD: PPR FOR ALL MILITARY AIRCRAFT F/W – R/W & UNSCHEDULED CHARTER FLIGHTS WITH 30 OR MORE PASSENGERS. 24 HR PN RQR FOR MIL PRACTICE APCH. CTC ARPT OPS 919-840-7510 OR RDU APP C919-380-3125. 24 HR PN RQR FOR PPR FOR ALL F/W AND R/W MIL ACFT GOING TO ARNG RAMP, POC C984-661-6200. OSACOM FLT DET C984-661-6202.

### North Mariana Islands, Saipan Island Francisco C. Ada/Saipan International ICAO Identifier PGSN



**Saipan Island, CQ**  
**Francisco C. Ada/Saipan Intl**  
**ICAO Identifier PGSN**

**AD 2.2 Aerodrome geographical and administrative data**

- 2.2.1 Reference Point: 15-7-12.895N / 145-43-47.951E
- 2.2.2 From City: 4 miles SW of SAIPAN ISLAND, MP
- 2.2.3 Elevation: 214 ft
- 2.2.5 Magnetic Variation: 2E (1985)
- 2.2.6 Airport Contact: CHRISTOPHER S. TENORIO  
PO BOX 501055  
SAIPAN, MP 96950 (670-285-2504)
- 2.2.7 Traffic: IFR/VFR

**AD 2.3 Attendance Schedule**

- 2.3.1 All Months, All Days, All Hours

**AD 2.4 Handling Services and Facilities**

- 2.4.1 Cargo Handling Facilities: YES
- 2.4.2 Fuel Types: 100,100LL,A1+
- 2.4.5 Hangar Space:
- 2.4.6 Repair Facilities: NONE

**AD 2.6 Rescue and Firefighting Services**

- 2.6.1 Aerodrome Category: Class-I certified on 1/1/1978
- 2.6.2 Rescue and Firefighting Services: ARFF Index-D

**AD 2.12 Runway Physical Characteristics**

- 2.12.1 Designation: 06
- 2.12.2 True Bearing: 68
- 2.12.3 Dimensions: 7001 ft x 100 ft
- 2.12.4 PCN: 67 R/A/X/T
- 2.12.5 Coordinates: 15-7-5.3655N / 145-43-17.7212E
- 2.12.6 Threshold Elevation: 209.8 ft
- 2.12.6 Touchdown Zone Elevation: 212.7 ft
  
- 2.12.1 Designation: 24
- 2.12.2 True Bearing: 248
- 2.12.3 Dimensions: 7001 ft x 100 ft
- 2.12.4 PCN: 67 R/A/X/T
- 2.12.5 Coordinates: 15-7-31.5859N / 145-44-23.8908E
- 2.12.6 Threshold Elevation: 206.5 ft
- 2.12.6 Touchdown Zone Elevation: 206.8 ft
  
- 2.12.1 Designation: 07

2.12.2 True Bearing: 68  
2.12.3 Dimensions: 8699 ft x 200 ft  
2.12.4 PCN: 67 F/A/X/T  
2.12.5 Coordinates: 15-6-52.1086N / 145-43-4.5454E  
2.12.6 Threshold Elevation: 209 ft  
2.12.6 Touchdown Zone Elevation: 214 ft

2.12.1 Designation: 25  
2.12.2 True Bearing: 248  
2.12.3 Dimensions: 8699 ft x 200 ft  
2.12.4 PCN: 67 F/A/X/T  
2.12.5 Coordinates: 15-7-24.6959N / 145-44-26.7638E  
2.12.6 Threshold Elevation: 209 ft  
2.12.6 Touchdown Zone Elevation: 209 ft

#### **AD 2.13 Declared Distances**

2.13.1 Designation: 06  
2.13.2 Take-off Run Available: 7001  
2.13.3 Take-off Distance Available: 6800  
2.13.4 Accelerate-Stop Distance Available: 6645  
2.13.5 Landing Distance Available: 6600

2.13.1 Designation: 24  
2.13.2 Take-off Run Available: 6400  
2.13.3 Take-off Distance Available: 7001  
2.13.4 Accelerate-Stop Distance Available: 6302  
2.13.5 Landing Distance Available: 7000

2.13.1 Designation: 07  
2.13.2 Take-off Run Available: 8699  
2.13.3 Take-off Distance Available: 8669  
2.13.4 Accelerate-Stop Distance Available: 8664  
2.13.5 Landing Distance Available: 8010

2.13.1 Designation: 25  
2.13.2 Take-off Run Available: 8699  
2.13.3 Take-off Distance Available: 8699  
2.13.4 Accelerate-Stop Distance Available: 8045  
2.13.5 Landing Distance Available: 8010

#### **AD 2.14 Approach and Runway Lighting**

2.14.1 Designation: 06

2.14.2 Approach Lighting System:  
2.14.4 Visual Approach Slope Indicator System:

2.14.1 Designation: 24  
2.14.2 Approach Lighting System:  
2.14.4 Visual Approach Slope Indicator System:

2.14.1 Designation: 07  
2.14.2 Approach Lighting System: MALSR  
2.14.4 Visual Approach Slope Indicator System:

2.14.1 Designation: 25  
2.14.2 Approach Lighting System:  
2.14.4 Visual Approach Slope Indicator System: P4L

#### **AD 2.18 Air Traffic Services Communication Facilities**

2.18.1 Service Designation: ATIS  
2.18.3 Channel: 127.2  
2.18.5 Hours of Operation: 24

2.18.1 Service Designation: GND/P  
2.18.3 Channel: 121.8  
2.18.5 Hours of Operation: 24

2.18.1 Service Designation: LCL/P  
2.18.3 Channel: 125.7  
2.18.5 Hours of Operation: 24

2.18.1 Service Designation: LCL/P  
2.18.3 Channel: 256.9  
2.18.5 Hours of Operation: 24

#### **AD 2.19 Radio Navigation and Landing Aids**

2.19.1 ILS Type: DME for runway 07. Magnetic variation: 2E  
2.19.2 ILS Identification: GSN  
2.19.5 Coordinates: 15-7-30.4581N / 145-44-34.0368E  
2.19.6 Site Elevation: 211.1 ft

2.19.1 ILS Type: Glide Slope for runway 07. Magnetic variation: 2E  
2.19.2 ILS Identification: GSN  
2.19.5 Coordinates: 15-6-58.6872N / 145-43-13.0288E  
2.19.6 Site Elevation: 206.5 ft

2.19.1 ILS Type: Localizer for runway 07. Magnetic variation: 2E

2.19.2 ILS Identification: GSN

2.19.5 Coordinates: 15-7-28.4649N / 145-44-36.3028E

2.19.6 Site Elevation: 205.8 ft

**General Remarks:**

FOR ARPT SECURITY CALL (670) 237-6529.

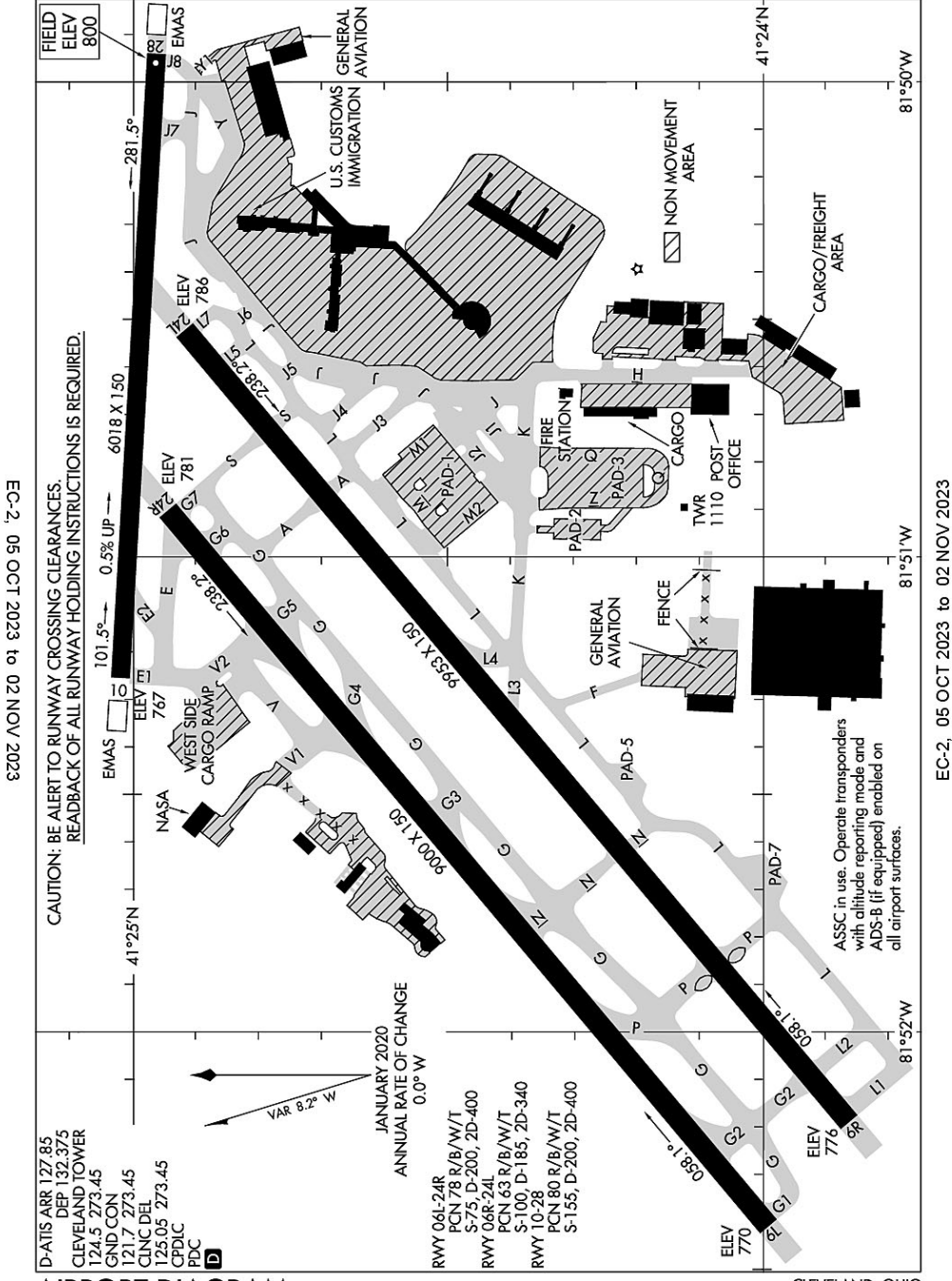
RWY 06/24 OPEN FOR TAXIING ONLY (NOT AVBL FOR LDG AND TKOF). OPEN FOR LDG AND TKOF WHEN RWY 7/25 CLSD.

PPR FM EXECUTIVE DIRECTOR COMMONWEALTH PORTS AUTHORITY SAIPAN CALL (670) 237-6500 MON-FRI 0730-1630 OTHER TIMES CALL (670) 237-6535.

IMMIGRATION & CUSTOMS AVBL DURG SCHEDULED OPNS. OTHER TIMES PRIOR ARRANGEMENTS MUST BE MADE WITH CBP PORT DIRECTOR CALL (670)288-0025/26.

# Cleveland, Ohio Cleveland-Hopkins International ICAO Identifier KCLE

22027 AIRPORT DIAGRAM AL-84 (FAA) CLEVELAND-HOPKINS INTL (CLE) CLEVELAND, OHIO



22027 AIRPORT DIAGRAM CLEVELAND, OHIO CLEVELAND-HOPKINS INTL (CLE)

**Cleveland, OH**  
**Cleveland–Hopkins Intl**  
**ICAO Identifier KCLE**

**AD 2.2 Aerodrome geographical and administrative data**

- 2.2.1 Reference Point: 41-24-33.865N / 81-51-16.888W
- 2.2.2 From City: 9 miles SW of CLEVELAND, OH
- 2.2.3 Elevation: 799.5 ft
- 2.2.5 Magnetic Variation: 8W (2020)
- 2.2.6 Airport Contact: DINA WILSON  
PO BOX 81009  
CLEVELAND, OH 44181 (216-265-6963)
- 2.2.7 Traffic: IFR/VFR

**AD 2.3 Attendance Schedule**

- 2.3.1 All Months, All Days, All Hours

**AD 2.4 Handling Services and Facilities**

- 2.4.1 Cargo Handling Facilities: NO
- 2.4.2 Fuel Types: 100LL,A1+
- 2.4.5 Hangar Space: YES
- 2.4.6 Repair Facilities: MAJOR

**AD 2.6 Rescue and Firefighting Services**

- 2.6.1 Aerodrome Category: Class-I certified on 5/1/1973
- 2.6.2 Rescue and Firefighting Services: ARFF Index-C

**AD 2.12 Runway Physical Characteristics**

- 2.12.1 Designation: 06L
- 2.12.2 True Bearing: 50
- 2.12.3 Dimensions: 9000 ft x 150 ft
- 2.12.4 PCN: 78 R/B/W/T
- 2.12.5 Coordinates: 41-23-59.5393N / 81-52-24.5622W
- 2.12.6 Threshold Elevation: 770.1 ft
- 2.12.6 Touchdown Zone Elevation: 772.6 ft

- 2.12.1 Designation: 24R
- 2.12.2 True Bearing: 230
- 2.12.3 Dimensions: 9000 ft x 150 ft
- 2.12.4 PCN: 78 R/B/W/T
- 2.12.5 Coordinates: 41-24-56.7503N / 81-50-54.1515W
- 2.12.6 Threshold Elevation: 781.1 ft
- 2.12.6 Touchdown Zone Elevation: 781.1 ft

- 2.12.1 Designation: 06R
- 2.12.2 True Bearing: 50
- 2.12.3 Dimensions: 9953 ft x 150 ft
- 2.12.4 PCN: 63 R/B/W/T
- 2.12.5 Coordinates: 41-23-51.8742N / 81-52-11.3519W
- 2.12.6 Threshold Elevation: 775.5 ft
- 2.12.6 Touchdown Zone Elevation: 776.5 ft



2.12.1 Designation: 24L  
2.12.2 True Bearing: 230  
2.12.3 Dimensions: 9953 ft x 150 ft  
2.12.4 PCN: 63 R/B/W/T  
2.12.5 Coordinates: 41-24-55.141N / 81-50-31.3701W  
2.12.6 Threshold Elevation: 785.7 ft  
2.12.6 Touchdown Zone Elevation: 785.8 ft

2.12.1 Designation: 10  
2.12.2 True Bearing: 93  
2.12.3 Dimensions: 6018 ft x 150 ft  
2.12.4 PCN: 80 R/B/W/T  
2.12.5 Coordinates: 41-25-1.2562N / 81-51-15.2842W  
2.12.6 Threshold Elevation: 767.1 ft  
2.12.6 Touchdown Zone Elevation: 782.8 ft

2.12.1 Designation: 28  
2.12.2 True Bearing: 273  
2.12.3 Dimensions: 6018 ft x 150 ft  
2.12.4 PCN: 80 R/B/W/T  
2.12.5 Coordinates: 41-24-57.8208N / 81-49-56.4392W  
2.12.6 Threshold Elevation: 799.5 ft  
2.12.6 Touchdown Zone Elevation: 799.5 ft

#### **AD 2.13 Declared Distances**

2.13.1 Designation: 06L  
2.13.2 Take-off Run Available: 9000  
2.13.3 Take-off Distance Available: 9000  
2.13.4 Accelerate-Stop Distance Available: 9000  
2.13.5 Landing Distance Available: 9000

2.13.1 Designation: 24R  
2.13.2 Take-off Run Available: 9000  
2.13.3 Take-off Distance Available: 9000  
2.13.4 Accelerate-Stop Distance Available: 9000  
2.13.5 Landing Distance Available: 9000

2.13.1 Designation: 06R  
2.13.2 Take-off Run Available: 9956  
2.13.3 Take-off Distance Available: 9956  
2.13.4 Accelerate-Stop Distance Available: 9956  
2.13.5 Landing Distance Available: 8029

2.13.1 Designation: 24L  
2.13.2 Take-off Run Available: 9956  
2.13.3 Take-off Distance Available: 9956  
2.13.4 Accelerate-Stop Distance Available: 9956  
2.13.5 Landing Distance Available: 9956

2.13.1 Designation: 10  
2.13.2 Take-off Run Available: 6018  
2.13.3 Take-off Distance Available: 6018  
2.13.4 Accelerate-Stop Distance Available: 6018  
2.13.5 Landing Distance Available: 6018

2.13.1 Designation: 28  
2.13.2 Take-off Run Available: 6018  
2.13.3 Take-off Distance Available: 6018  
2.13.4 Accelerate-Stop Distance Available: 6018  
2.13.5 Landing Distance Available: 6018

**AD 2.14 Approach and Runway Lighting**

2.14.1 Designation: 06L  
2.14.2 Approach Lighting System: ALSF2  
2.14.4 Visual Approach Slope Indicator System: P4L

2.14.1 Designation: 24R  
2.14.2 Approach Lighting System: ALSF2  
2.14.4 Visual Approach Slope Indicator System: P4R

2.14.1 Designation: 06R  
2.14.2 Approach Lighting System: MALSR  
2.14.4 Visual Approach Slope Indicator System: P4L

2.14.1 Designation: 24L  
2.14.2 Approach Lighting System: MALSR  
2.14.4 Visual Approach Slope Indicator System: P4R

2.14.1 Designation: 10  
2.14.2 Approach Lighting System:  
2.14.4 Visual Approach Slope Indicator System: P4L

2.14.1 Designation: 28  
2.14.2 Approach Lighting System: MALSF  
2.14.4 Visual Approach Slope Indicator System: P4R

**AD 2.18 Air Traffic Services Communication Facilities**

2.18.1 Service Designation: APCH/P  
2.18.3 Channel: 126.55  
2.18.5 Hours of Operation: 24

2.18.1 Service Designation: APCH/P DEP/P  
2.18.3 Channel: 346.325  
2.18.5 Hours of Operation: 24

2.18.1 Service Designation: CAVVS DP  
2.18.3 Channel: 135.875  
2.18.5 Hours of Operation: 24

2.18.1 Service Designation: CD/P  
2.18.3 Channel: 125.05  
2.18.5 Hours of Operation: 24

2.18.1 Service Designation: CD/P  
2.18.3 Channel: 273.45  
2.18.5 Hours of Operation: 24

2.18.1 Service Designation: CLASS B (340-200)  
2.18.3 Channel: 125.35  
2.18.5 Hours of Operation: 24

2.18.1 Service Designation: CLASS B (201-339)  
2.18.3 Channel: 126.35  
2.18.5 Hours of Operation: 24

2.18.1 Service Designation: D-ATIS (ARR)  
2.18.3 Channel: 127.85  
2.18.5 Hours of Operation: 24

2.18.1 Service Designation: D-ATIS (DEP)  
2.18.3 Channel: 132.375  
2.18.5 Hours of Operation: 24

2.18.1 Service Designation: DEP/P  
2.18.3 Channel: 128.25  
2.18.5 Hours of Operation: 24

2.18.1 Service Designation: DEP/P  
2.18.3 Channel: 135.875  
2.18.5 Hours of Operation: 24

2.18.1 Service Designation: EMERG  
2.18.3 Channel: 121.5  
2.18.5 Hours of Operation:

2.18.1 Service Designation: EMERG  
2.18.3 Channel: 243  
2.18.5 Hours of Operation:

2.18.1 Service Designation: GND/P  
2.18.3 Channel: 121.7  
2.18.5 Hours of Operation: 24

2.18.1 Service Designation: GND/P  
2.18.3 Channel: 273.45  
2.18.5 Hours of Operation: 24

2.18.1 Service Designation: GTLKE DP  
2.18.3 Channel: 128.25

2.18.5 Hours of Operation: 24

2.18.1 Service Designation: KKIDS DP

2.18.3 Channel: 135.875

2.18.5 Hours of Operation: 24

2.18.1 Service Designation: LCL/P

2.18.3 Channel: 124.5

2.18.5 Hours of Operation: 24

2.18.1 Service Designation: LCL/P

2.18.3 Channel: 273.45

2.18.5 Hours of Operation: 24

2.18.1 Service Designation: PFLYD DP

2.18.3 Channel: 128.25

2.18.5 Hours of Operation: 24

2.18.1 Service Designation: ZAAPA DP

2.18.3 Channel: 128.25

2.18.5 Hours of Operation: 24

#### **AD 2.19 Radio Navigation and Landing Aids**

2.19.1 ILS Type: DME for runway 06L. Magnetic variation: 8W

2.19.2 ILS Identification: LIZ

2.19.5 Coordinates: 41-25-11.9443N / 81-50-35.682W

2.19.6 Site Elevation: 783.4 ft

2.19.1 ILS Type: Glide Slope for runway 06L. Magnetic variation: 8W

2.19.2 ILS Identification: LIZ

2.19.5 Coordinates: 41-24-9.1461N / 81-52-17.5279W

2.19.6 Site Elevation: 764.3 ft

2.19.1 ILS Type: Inner Marker for runway 06L. Magnetic variation: 8W

2.19.2 ILS Identification: LIZ

2.19.5 Coordinates: 41-23-53.9363N / 81-52-33.3994W

2.19.6 Site Elevation: 761.5 ft

2.19.1 ILS Type: Localizer for runway 06L. Magnetic variation: 8W

2.19.2 ILS Identification: LIZ

2.19.5 Coordinates: 41-25-10.1943N / 81-50-32.8939W

2.19.6 Site Elevation: 778.7 ft

2.19.1 ILS Type: DME for runway 24R. Magnetic variation: 8W

2.19.2 ILS Identification: PVY

2.19.5 Coordinates: 41-25-11.9443N / 81-50-35.682W

2.19.6 Site Elevation: 783.4 ft

2.19.1 ILS Type: Glide Slope for runway 24R. Magnetic variation: 8W

2.19.2 ILS Identification: PVY

2.19.5 Coordinates: 41-24-53.0116N / 81-51-8.214W

2.19.6 Site Elevation: 768.4 ft

2.19.1 ILS Type: Inner Marker for runway 24R. Magnetic variation: 8W

2.19.2 ILS Identification: PVY

2.19.5 Coordinates: 41-25-3.7844N / 81-50-47.3046W

2.19.6 Site Elevation: 777.9 ft

2.19.1 ILS Type: Localizer for runway 24R. Magnetic variation: 8W

2.19.2 ILS Identification: PVY

2.19.5 Coordinates: 41-23-53.0789N / 81-52-34.7494W

2.19.6 Site Elevation: 760.6 ft

2.19.1 ILS Type: DME for runway 06R. Magnetic variation: 8W

2.19.2 ILS Identification: CLE

2.19.5 Coordinates: 41-25-4.0601N / 81-50-11.0982W

2.19.6 Site Elevation: 794.1 ft

2.19.1 ILS Type: Glide Slope for runway 06R. Magnetic variation: 8W

2.19.2 ILS Identification: CLE

2.19.5 Coordinates: 41-24-13.6551N / 81-51-45.2101W

2.19.6 Site Elevation: 766 ft

2.19.1 ILS Type: Localizer for runway 06R. Magnetic variation: 8W

2.19.2 ILS Identification: CLE

2.19.5 Coordinates: 41-25-5.1773N / 81-50-15.5025W

2.19.6 Site Elevation: 785.5 ft

2.19.1 ILS Type: DME for runway 24L. Magnetic variation: 8W

2.19.2 ILS Identification: HPI

2.19.5 Coordinates: 41-23-44.3404N / 81-52-18.0729W

2.19.6 Site Elevation: 778.9 ft

2.19.1 ILS Type: Glide Slope for runway 24L. Magnetic variation: 8W

2.19.2 ILS Identification: HPI

2.19.5 Coordinates: 41-24-51.9504N / 81-50-45.3186W

2.19.6 Site Elevation: 782.2 ft

2.19.1 ILS Type: Localizer for runway 24L. Magnetic variation: 8W

2.19.2 ILS Identification: HPI

2.19.5 Coordinates: 41-23-45.4329N / 81-52-21.5252W

2.19.6 Site Elevation: 771.7 ft

2.19.1 ILS Type: DME for runway 28. Magnetic variation: 8W

2.19.2 ILS Identification: PXP

2.19.5 Coordinates: 41-24-58.7198N / 81-51-23.8351W

2.19.6 Site Elevation: 766.3 ft

2.19.1 ILS Type: Glide Slope for runway 28. Magnetic variation: 8W

2.19.2 ILS Identification: PXP

2.19.5 Coordinates: 41-25-3.4337N / 81-50-9.415W

2.19.6 Site Elevation: 786.3 ft

2.19.1 ILS Type: Localizer for runway 28. Magnetic variation: 8W

2.19.2 ILS Identification: PXP

2.19.5 Coordinates: 41-25-1.5177N / 81-51-21.2475W

2.19.6 Site Elevation: 756.3 ft

**General Remarks:**

NASA GLENN RESEARCH CENTER; NASA RAMP PPR CALL 216-433-2031; 0800-1730 MON-FRI. CONTACT NASA OPNS ON FREQ 122.925 WITHIN 50 NM.

RAMP AREA CONCOURSE D BTN GATES D1, D28 CLSD EXC ACFT WINGSPAN LESS THAN 86 FT.

TXL H CLSD TO ACFT WITH WINGSPAN OVR 171 FT.

PAD 3 BAYS 1-5 CLOSED TO ACFT WITH WINGSPAN OVER 134 FT.

PAD 2 AND TAXILANE Y1 RSTRD TO GROUP II ACFT LESS THAN 79 FT WINGSPAN.

DEER, COYOTES, & BIRDS INCLG WATERFOWL ON & INVOF ARPT.

ASSC IN USE. OPERATE TRANSPONDERS WITH ALTITUDE REPORTING MODE AND ADS-B (IF EQUIPPED) ENABLED ON ALL AIRPORT SURFACES.

ADCUS AVBL DLY 0700-1900, LTD AVBLTY DURG OFF HRS; ALL REQS FOR SVC MUST BE MADE WITH THE US CUST SVC OFC LCTD AT GATE A-14, CALL 216-267-3600 DURG LISTED HRS.

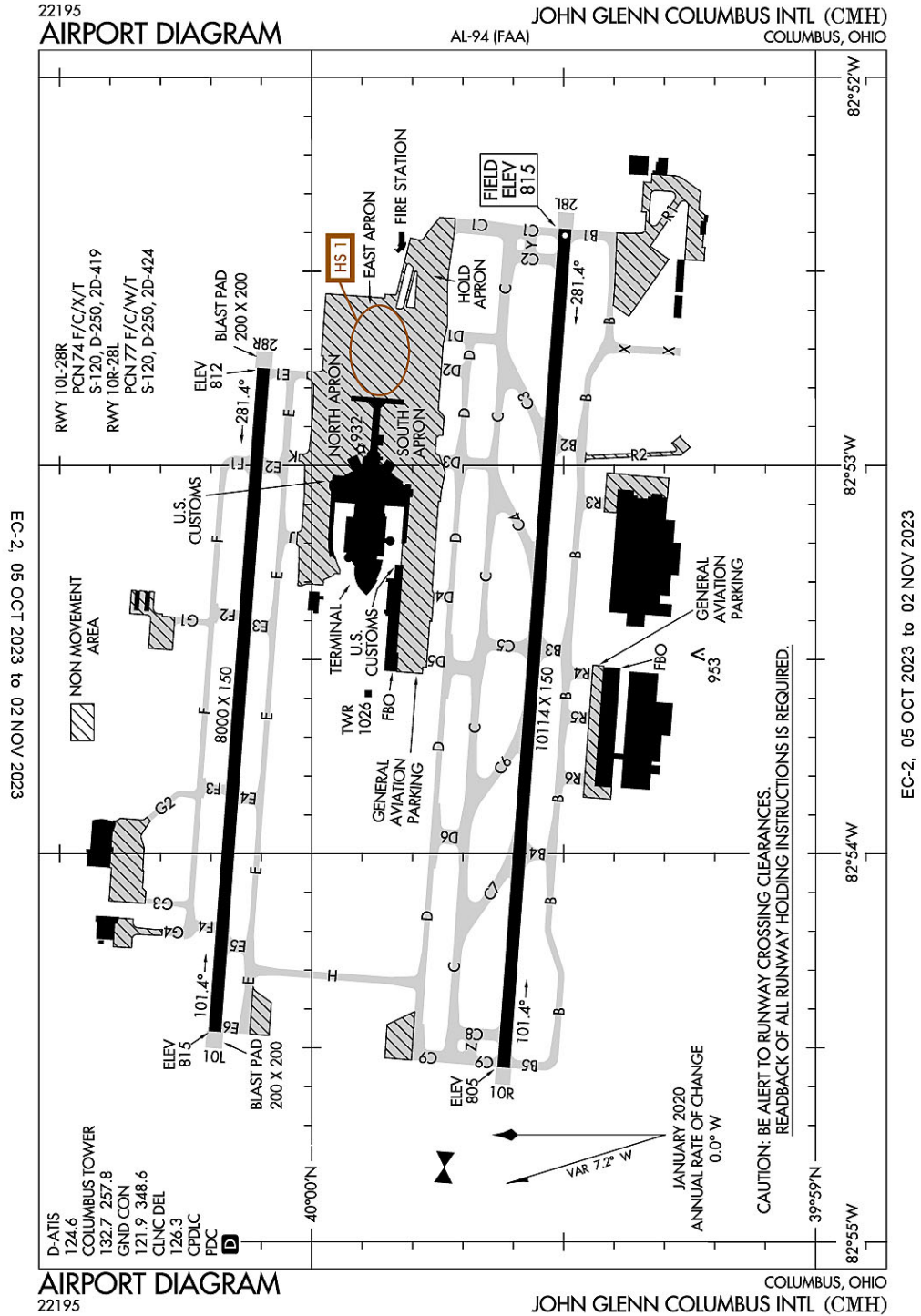
PAD 3 BAY 6 CLOSED TO ACFT WITH WINGSPAN OVER 94 FT.

ALL APCHS ARE OVR NOISE SENSITIVE AREAS. ARPT LATE NGT NOISE ABATEMENT PROCEDURES ARE IN EFFECT 2300-0600. ADDITIONAL NOISE ABATEMENT PROCEDURES ARE IN EFFECT CALL AMGR NORMAL BUSINESS HRS AT 216-265-6090.

TWY F CLSD TO ACFT WITH WINGSPAN OVR 118 FT.

TWYS CLSD OCT-APR TO SUPPORT DEICING OPS: TWY M; TWY J2; TWY M1 BTN TWY L & TWY J1; TWY M2 BTN TWY L & TWY J1.

**Columbus, Ohio**  
**Port Columbus International**  
**ICAO Identifier KCMH**



**Columbus, OH**  
**Port Columbus Intl**  
**ICAO Identifier KCMH**

**AD 2.2 Aerodrome geographical and administrative data**

- 2.2.1 Reference Point: 39-59-49.008N / 82-53-31.773W
- 2.2.2 From City: 6 miles E of COLUMBUS, OH
- 2.2.3 Elevation: 815 ft
- 2.2.5 Magnetic Variation: 7W (2015)
- 2.2.6 Airport Contact: JOE NARDONE  
COLUMBUS REGIONAL AIRPORT AUTHORITY  
COLUMBUS, OH 43219 (614-239-4004)
- 2.2.7 Traffic: IFR/VFR

**AD 2.3 Attendance Schedule**

- 2.3.1 All Months, All Days, All Hours

**AD 2.4 Handling Services and Facilities**

- 2.4.1 Cargo Handling Facilities: YES
- 2.4.2 Fuel Types: 100,A1+
- 2.4.5 Hangar Space: YES
- 2.4.6 Repair Facilities: MAJOR

**AD 2.6 Rescue and Firefighting Services**

- 2.6.1 Aerodrome Category: Class-I certified on 5/1/1973
- 2.6.2 Rescue and Firefighting Services: ARFF Index-C

**AD 2.12 Runway Physical Characteristics**

- 2.12.1 Designation: 10L
- 2.12.2 True Bearing: 94
- 2.12.3 Dimensions: 8000 ft x 150 ft
- 2.12.4 PCN: 74 F/C/X/T
- 2.12.5 Coordinates: 40-0-11.5307N / 82-54-27.4941W
- 2.12.6 Threshold Elevation: 814.7 ft
- 2.12.6 Touchdown Zone Elevation: 814.8 ft
  
- 2.12.1 Designation: 28R
- 2.12.2 True Bearing: 274
- 2.12.3 Dimensions: 8000 ft x 150 ft
- 2.12.4 PCN: 74 F/C/X/T
- 2.12.5 Coordinates: 40-0-5.7308N / 82-52-44.9692W
- 2.12.6 Threshold Elevation: 812.3 ft
- 2.12.6 Touchdown Zone Elevation: 813.1 ft
  
- 2.12.1 Designation: 10R
- 2.12.2 True Bearing: 94
- 2.12.3 Dimensions: 10114 ft x 150 ft
- 2.12.4 PCN: 77 F/C/W/T
- 2.12.5 Coordinates: 39-59-37.1453N / 82-54-33.0422W
- 2.12.6 Threshold Elevation: 804.9 ft
- 2.12.6 Touchdown Zone Elevation: 809.2 ft



- 2.12.1 Designation: 28L
- 2.12.2 True Bearing: 274
- 2.12.3 Dimensions: 10114 ft x 150 ft
- 2.12.4 PCN: 77 F/C/W/T
- 2.12.5 Coordinates: 39-59-29.8102N / 82-52-23.4543W
- 2.12.6 Threshold Elevation: 815 ft
- 2.12.6 Touchdown Zone Elevation: 815 ft

#### **AD 2.13 Declared Distances**

- 2.13.1 Designation: 10L
- 2.13.2 Take-off Run Available: 8000
- 2.13.3 Take-off Distance Available: 8000
- 2.13.4 Accelerate-Stop Distance Available: 8000
- 2.13.5 Landing Distance Available: 8000

- 2.13.1 Designation: 28R
- 2.13.2 Take-off Run Available: 8000
- 2.13.3 Take-off Distance Available: 8000
- 2.13.4 Accelerate-Stop Distance Available: 8000
- 2.13.5 Landing Distance Available: 8000

- 2.13.1 Designation: 10R
- 2.13.2 Take-off Run Available: 10113
- 2.13.3 Take-off Distance Available: 10113
- 2.13.4 Accelerate-Stop Distance Available: 10113
- 2.13.5 Landing Distance Available: 10113

- 2.13.1 Designation: 28L
- 2.13.2 Take-off Run Available: 10113
- 2.13.3 Take-off Distance Available: 10113
- 2.13.4 Accelerate-Stop Distance Available: 10113
- 2.13.5 Landing Distance Available: 10113

#### **AD 2.14 Approach and Runway Lighting**

- 2.14.1 Designation: 10L
- 2.14.2 Approach Lighting System: MALSR
- 2.14.4 Visual Approach Slope Indicator System: P4L

- 2.14.1 Designation: 28R
- 2.14.2 Approach Lighting System: MALSR
- 2.14.4 Visual Approach Slope Indicator System: P4R

- 2.14.1 Designation: 10R
- 2.14.2 Approach Lighting System: MALSR
- 2.14.4 Visual Approach Slope Indicator System: P4L

- 2.14.1 Designation: 28L
- 2.14.2 Approach Lighting System: MALSR

2.14.4 Visual Approach Slope Indicator System: P4L

**AD 2.18 Air Traffic Services Communication Facilities**

2.18.1 Service Designation: APCH/P DEP/P (100-279)

2.18.3 Channel: 134

2.18.5 Hours of Operation: 24

2.18.1 Service Designation: APCH/P DEP/P (100-279)

2.18.3 Channel: 279.6

2.18.5 Hours of Operation: 24

2.18.1 Service Designation: APCH/P DEP/P (280-099)

2.18.3 Channel: 317.775

2.18.5 Hours of Operation: 24

2.18.1 Service Designation: APCH/P DEP/P IC (280-099)

2.18.3 Channel: 125.95

2.18.5 Hours of Operation: 24

2.18.1 Service Designation: APCH/P DEP/P IC (280-099)

2.18.3 Channel: 371.975

2.18.5 Hours of Operation: 24

2.18.1 Service Designation: CBUSS STAR

2.18.3 Channel: 125.95

2.18.5 Hours of Operation: 24

2.18.1 Service Designation: CBUSS STAR

2.18.3 Channel: 371.975

2.18.5 Hours of Operation: 24

2.18.1 Service Designation: CD/P

2.18.3 Channel: 126.3

2.18.5 Hours of Operation: 24

2.18.1 Service Designation: CLASS C (280-099)

2.18.3 Channel: 125.95

2.18.5 Hours of Operation: 24

2.18.1 Service Designation: CLASS C (100-279)

2.18.3 Channel: 134

2.18.5 Hours of Operation: 24

2.18.1 Service Designation: CLASS C (100-279)

2.18.3 Channel: 279.6

2.18.5 Hours of Operation: 24

2.18.1 Service Designation: CLASS C (280-099)

2.18.3 Channel: 317.775

2.18.5 Hours of Operation: 24

2.18.1 Service Designation: CLPRR STAR  
2.18.3 Channel: 134  
2.18.5 Hours of Operation: 24

2.18.1 Service Designation: D-ATIS  
2.18.3 Channel: 124.6  
2.18.5 Hours of Operation: 24

2.18.1 Service Designation: DUBLN STAR  
2.18.3 Channel: 125.95  
2.18.5 Hours of Operation: 24

2.18.1 Service Designation: DUBLN STAR  
2.18.3 Channel: 371.975  
2.18.5 Hours of Operation: 24

2.18.1 Service Designation: EMERG  
2.18.3 Channel: 121.5  
2.18.5 Hours of Operation:

2.18.1 Service Designation: EMERG  
2.18.3 Channel: 243  
2.18.5 Hours of Operation:

2.18.1 Service Designation: GND/P  
2.18.3 Channel: 121.9  
2.18.5 Hours of Operation: 24

2.18.1 Service Designation: GND/P  
2.18.3 Channel: 348.6  
2.18.5 Hours of Operation: 24

2.18.1 Service Designation: JAKTZ STAR  
2.18.3 Channel: 134  
2.18.5 Hours of Operation: 24

2.18.1 Service Designation: LCL/P  
2.18.3 Channel: 132.7  
2.18.5 Hours of Operation: 24

2.18.1 Service Designation: LCL/P  
2.18.3 Channel: 257.8  
2.18.5 Hours of Operation: 24

2.18.1 Service Designation: OPS (DEICE PAD CONTROL)  
2.18.3 Channel: 122.775  
2.18.5 Hours of Operation:

2.18.1 Service Designation: SCRLT STAR  
2.18.3 Channel: 134

2.18.5 Hours of Operation: 24

**AD 2.19 Radio Navigation and Landing Aids**

2.19.1 ILS Type: DME for runway 10L. Magnetic variation: 7W

2.19.2 ILS Identification: CBP

2.19.5 Coordinates: 40-0-9.698N / 82-54-41.0247W

2.19.6 Site Elevation: 822.2 ft

2.19.1 ILS Type: Glide Slope for runway 10L. Magnetic variation: 7W

2.19.2 ILS Identification: CBP

2.19.5 Coordinates: 40-0-14.2837N / 82-54-14.862W

2.19.6 Site Elevation: 809.9 ft

2.19.1 ILS Type: Localizer for runway 10L. Magnetic variation: 7W

2.19.2 ILS Identification: CBP

2.19.5 Coordinates: 40-0-4.9978N / 82-52-32.0266W

2.19.6 Site Elevation: 799.2 ft

2.19.1 ILS Type: DME for runway 28R. Magnetic variation: 7W

2.19.2 ILS Identification: ONB

2.19.5 Coordinates: 40-0-9.698N / 82-54-41.0247W

2.19.6 Site Elevation: 822.2 ft

2.19.1 ILS Type: Glide Slope for runway 28R. Magnetic variation: 7W

2.19.2 ILS Identification: ONB

2.19.5 Coordinates: 40-0-9.1363N / 82-52-56.9903W

2.19.6 Site Elevation: 808.4 ft

2.19.1 ILS Type: Localizer for runway 28R. Magnetic variation: 7W

2.19.2 ILS Identification: ONB

2.19.5 Coordinates: 40-0-12.2661N / 82-54-40.558W

2.19.6 Site Elevation: 811.7 ft

2.19.1 ILS Type: DME for runway 10R. Magnetic variation: 7W

2.19.2 ILS Identification: AQI

2.19.5 Coordinates: 39-59-33.7337N / 82-54-45.9278W

2.19.6 Site Elevation: 814.8 ft

2.19.1 ILS Type: Glide Slope for runway 10R. Magnetic variation: 7W

2.19.2 ILS Identification: AQI

2.19.5 Coordinates: 39-59-32.3813N / 82-54-20.6176W

2.19.6 Site Elevation: 802.7 ft

2.19.1 ILS Type: Localizer for runway 10R. Magnetic variation: 7W

2.19.2 ILS Identification: AQI

2.19.5 Coordinates: 39-59-29.072N / 82-52-10.4143W

2.19.6 Site Elevation: 814.1 ft

2.19.1 ILS Type: DME for runway 28L. Magnetic variation: 7W

2.19.2 ILS Identification: CMH

2.19.5 Coordinates: 39-59-33.7337N / 82-54-45.9278W

2.19.6 Site Elevation: 814.8 ft

2.19.1 ILS Type: Glide Slope for runway 28L. Magnetic variation: 7W

2.19.2 ILS Identification: CMH

2.19.5 Coordinates: 39-59-26.4974N / 82-52-36.6536W

2.19.6 Site Elevation: 810.7 ft

2.19.1 ILS Type: Localizer for runway 28L. Magnetic variation: 7W

2.19.2 ILS Identification: CMH

2.19.5 Coordinates: 39-59-37.8812N / 82-54-46.0853W

2.19.6 Site Elevation: 806 ft

**General Remarks:**

TWY D-5 PAVEMENT (NORTH OF TWY D) IS RSTRD TO ACFT WITH WINGSPAN LESS THAN 79 FT.

TAXILANE CONCOURSE A BTN TWY D3 AND TWY D4 CLSD TO ACFT WINGSPAN MORE THAN 130 FT.

ALL SURFACES AROUND TERMINAL; NORTH OF TWY 'D' & SOUTH OF TWY 'E' ARE NON-MOVEMENT AREAS.

TO REQ LDG RIGHTS CTC US CUSTOMS BETWEEN 1230-0300Z, MON-FRI AT 614-497-1865.

BIRDS INVOF ARPT.

TWYS R2, R3, R4, R5 AND R6 RSTRD TO WINGSPAN LESS THAN 118 FT.

TWY F1 RSTRD TO AIRCRAFT WITH WINGSPAN LESS THAN 120 FT.

HOLD PAD FOR RWY 28L RSTRD TO ACFT WITH WINGSPAN LESS THAN 118 FT.

NOISE BARRIER LOCATED AT SE SIDE OF AIRFIELD RESTRICTED TO ACFT WITH WINGSPAN LESS THAN 79 FT.

BE ALERT: RY 10L/28R RESTRICTIONS ON STAGE I & II TURBOJET ACFT 2200-0800 & ON STAGE III TURBOJET ACFT 2200-0700. PRACTICE APCHS FOR HIGH NOISE LEVEL TYPE ACFT INCLUDING NON-STAGE III MIL JET ACFT SHALL NOT BE APPROVED UNLESS RY 10R/28L IS IN USE & THE APCH TERMINATES IN A FULL STOP TAXI-BACK OPN.

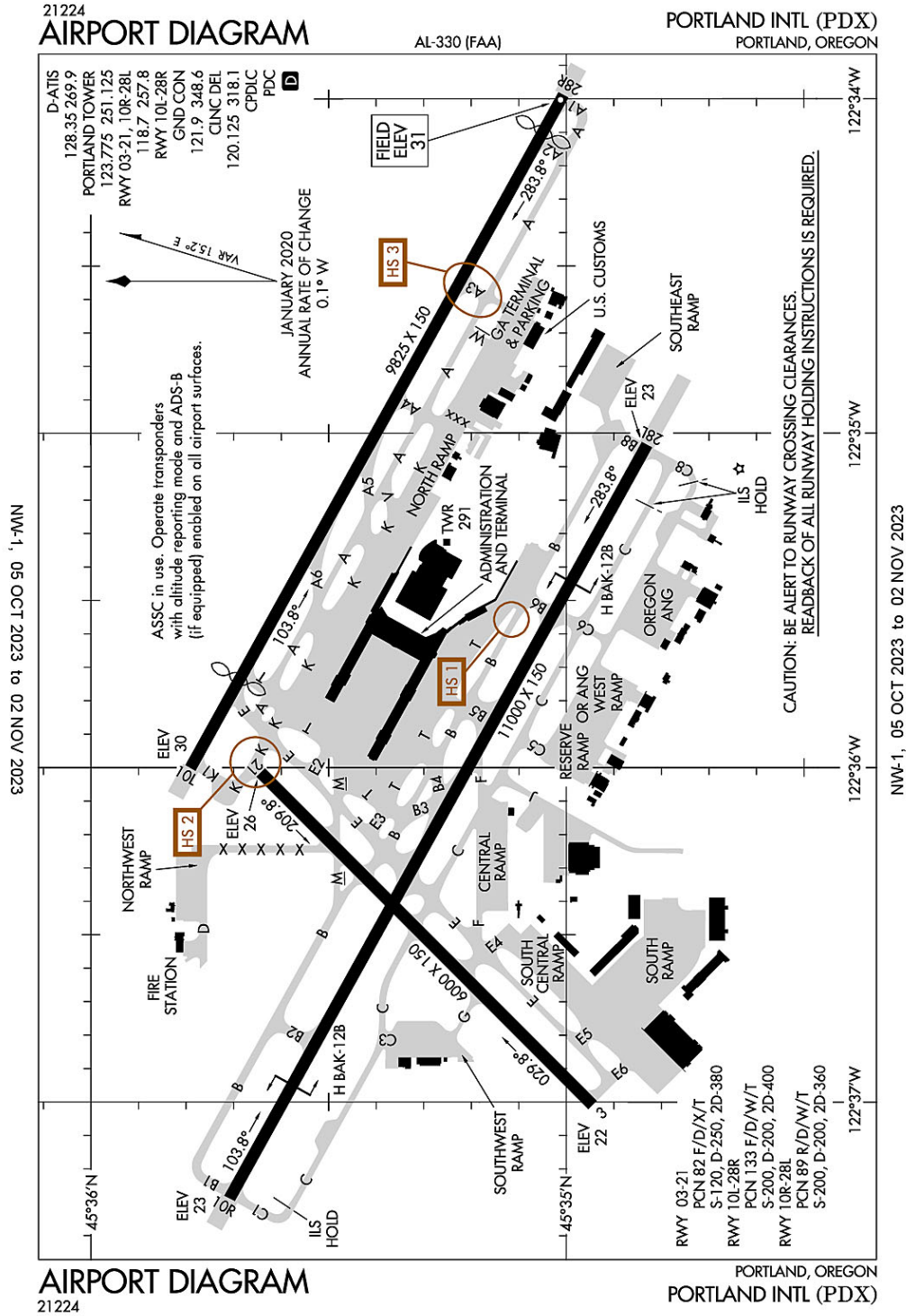
MODEL ACFT TFC WITHIN A 1 NM RDS OF A POINT 8 NM ON A 010 DEG BRG FM THE ARPT; SFC - 5000 FT AGL; SR-SS DLY.

TAXILANE CONCOURSE C BTN TWY J AND TWY K CLSD TO ACFT WINGSPAN MORE THAN 135 FT.

FLIGHT NOTIFICATION SERVICE (ADCUS) AVBL.

TWY R1 RSTRD TO ACFT WITH WINGSPAN LESS THAN 79 FT.

Portland, Oregon  
Portland International  
ICAO Identifier KPDX



**Portland, OR**  
**Portland Intl**  
**ICAO Identifier KPDX**

**AD 2.2 Aerodrome geographical and administrative data**

- 2.2.1 Reference Point: 45-35-19.3519N / 122-35-48.7299W
- 2.2.2 From City: 4 miles NE of PORTLAND, OR
- 2.2.3 Elevation: 30.8 ft
- 2.2.5 Magnetic Variation: 16E (2010)
- 2.2.6 Airport Contact: STEPHEN NAGY  
7200 NE AIRPORT WAY  
PORTLAND, OR 97218 (503-415-6195)
- 2.2.7 Traffic: IFR/VFR

**AD 2.3 Attendance Schedule**

- 2.3.1 All Months, All Days, All Hours

**AD 2.4 Handling Services and Facilities**

- 2.4.1 Cargo Handling Facilities: YES
- 2.4.2 Fuel Types: 100LL,A
- 2.4.5 Hangar Space: YES
- 2.4.6 Repair Facilities: MAJOR

**AD 2.6 Rescue and Firefighting Services**

- 2.6.1 Aerodrome Category: Class-I certified on 5/1/1973
- 2.6.2 Rescue and Firefighting Services: ARFF Index-E

**AD 2.12 Runway Physical Characteristics**

- 2.12.1 Designation: 03
- 2.12.2 True Bearing: 45
- 2.12.3 Dimensions: 6000 ft x 150 ft
- 2.12.4 PCN: 82 F/D/X/T
- 2.12.5 Coordinates: 45-34-56.73N / 122-37-0.5188W
- 2.12.6 Threshold Elevation: 22.2 ft
- 2.12.6 Touchdown Zone Elevation: 22.9 ft
  
- 2.12.1 Designation: 21
- 2.12.2 True Bearing: 225
- 2.12.3 Dimensions: 6000 ft x 150 ft
- 2.12.4 PCN: 82 F/D/X/T
- 2.12.5 Coordinates: 45-35-38.605N / 122-36-0.8463W
- 2.12.6 Threshold Elevation: 26.4 ft
- 2.12.6 Touchdown Zone Elevation: 26.4 ft
  
- 2.12.1 Designation: 10L
- 2.12.2 True Bearing: 119
- 2.12.3 Dimensions: 9825 ft x 150 ft
- 2.12.4 PCN: 133 F/D/W/T
- 2.12.5 Coordinates: 45-35-47.454N / 122-36-0.0581W
- 2.12.6 Threshold Elevation: 29.5 ft
- 2.12.6 Touchdown Zone Elevation: 30.2 ft

2.12.1 Designation: 28R  
2.12.2 True Bearing: 299  
2.12.3 Dimensions: 9825 ft x 150 ft  
2.12.4 PCN: 133 F/D/W/T  
2.12.5 Coordinates: 45-35-0.3785N / 122-33-59.2636W  
2.12.6 Threshold Elevation: 30.8 ft  
2.12.6 Touchdown Zone Elevation: 30.8 ft

2.12.1 Designation: 10R  
2.12.2 True Bearing: 119  
2.12.3 Dimensions: 11000 ft x 150 ft  
2.12.4 PCN: 89 R/D/W/T  
2.12.5 Coordinates: 45-35-42.5347N / 122-37-17.3022W  
2.12.6 Threshold Elevation: 22.7 ft  
2.12.6 Touchdown Zone Elevation: 23.7 ft

2.12.1 Designation: 28L  
2.12.2 True Bearing: 299  
2.12.3 Dimensions: 11000 ft x 150 ft  
2.12.4 PCN: 89 R/D/W/T  
2.12.5 Coordinates: 45-34-49.8531N / 122-35-2.0463W  
2.12.6 Threshold Elevation: 22.7 ft  
2.12.6 Touchdown Zone Elevation: 22.7 ft

#### **AD 2.13 Declared Distances**

2.13.1 Designation: 03  
2.13.2 Take-off Run Available: 6000  
2.13.3 Take-off Distance Available: 6000  
2.13.4 Accelerate-Stop Distance Available: 6000  
2.13.5 Landing Distance Available: 6000

2.13.1 Designation: 21  
2.13.2 Take-off Run Available: 6000  
2.13.3 Take-off Distance Available: 6000  
2.13.4 Accelerate-Stop Distance Available: 6000  
2.13.5 Landing Distance Available: 6000

2.13.1 Designation: 10L  
2.13.2 Take-off Run Available: 9825  
2.13.3 Take-off Distance Available: 9825  
2.13.4 Accelerate-Stop Distance Available: 9825  
2.13.5 Landing Distance Available: 8535

2.13.1 Designation: 28R  
2.13.2 Take-off Run Available: 9825  
2.13.3 Take-off Distance Available: 9825  
2.13.4 Accelerate-Stop Distance Available: 9825  
2.13.5 Landing Distance Available: 9290



2.13.1 Designation: 10R  
2.13.2 Take-off Run Available: 11000  
2.13.3 Take-off Distance Available: 11000  
2.13.4 Accelerate-Stop Distance Available: 11000  
2.13.5 Landing Distance Available: 11000

2.13.1 Designation: 28L  
2.13.2 Take-off Run Available: 11000  
2.13.3 Take-off Distance Available: 11000  
2.13.4 Accelerate-Stop Distance Available: 11000  
2.13.5 Landing Distance Available: 11000

**AD 2.14 Approach and Runway Lighting**

2.14.1 Designation: 03  
2.14.2 Approach Lighting System:  
2.14.4 Visual Approach Slope Indicator System: P4L

2.14.1 Designation: 21  
2.14.2 Approach Lighting System:  
2.14.4 Visual Approach Slope Indicator System: P4R

2.14.1 Designation: 10L  
2.14.2 Approach Lighting System: MALSR  
2.14.4 Visual Approach Slope Indicator System: P4L

2.14.1 Designation: 28R  
2.14.2 Approach Lighting System: MALSR  
2.14.4 Visual Approach Slope Indicator System: P4R

2.14.1 Designation: 10R  
2.14.2 Approach Lighting System: ALSF2  
2.14.4 Visual Approach Slope Indicator System: P4R

2.14.1 Designation: 28L  
2.14.2 Approach Lighting System: MALSR  
2.14.4 Visual Approach Slope Indicator System: P4L

**AD 2.18 Air Traffic Services Communication Facilities**

2.18.1 Service Designation: AFRC OPS  
2.18.3 Channel: 138.45  
2.18.5 Hours of Operation:

2.18.1 Service Designation: AFRC OPS  
2.18.3 Channel: 252.8  
2.18.5 Hours of Operation:

2.18.1 Service Designation: ANG COMD POST (CALL STUMP TOWN)  
2.18.3 Channel: 288.9  
2.18.5 Hours of Operation:

2.18.1 Service Designation: ANG OPS  
2.18.3 Channel: 280.5  
2.18.5 Hours of Operation:

2.18.1 Service Designation: ANG OPS  
2.18.3 Channel: 281.2  
2.18.5 Hours of Operation:

2.18.1 Service Designation: CD/P  
2.18.3 Channel: 120.125  
2.18.5 Hours of Operation: 24

2.18.1 Service Designation: CD/P  
2.18.3 Channel: 318.1  
2.18.5 Hours of Operation: 24

2.18.1 Service Designation: D-ATIS  
2.18.3 Channel: 128.35  
2.18.5 Hours of Operation: 24

2.18.1 Service Designation: D-ATIS  
2.18.3 Channel: 269.9  
2.18.5 Hours of Operation: 24

2.18.1 Service Designation: EMERG  
2.18.3 Channel: 121.5  
2.18.5 Hours of Operation:

2.18.1 Service Designation: EMERG  
2.18.3 Channel: 243  
2.18.5 Hours of Operation:

2.18.1 Service Designation: GND/P  
2.18.3 Channel: 121.9  
2.18.5 Hours of Operation: 24

2.18.1 Service Designation: GND/P  
2.18.3 Channel: 348.6  
2.18.5 Hours of Operation: 24

2.18.1 Service Designation: GND/S  
2.18.3 Channel: 132.275  
2.18.5 Hours of Operation: 24

2.18.1 Service Designation: LCL/P (RWY 10L/28R)  
2.18.3 Channel: 118.7  
2.18.5 Hours of Operation: 24

2.18.1 Service Designation: LCL/P (RWY 03/21, 10R/28L)  
2.18.3 Channel: 123.775

2.18.5 Hours of Operation: 24

2.18.1 Service Designation: LCL/P (RWY 03/21, 10R/28L)

2.18.3 Channel: 251.125

2.18.5 Hours of Operation: 24

2.18.1 Service Designation: LCL/P (RWY 10L/28R)

2.18.3 Channel: 257.8

2.18.5 Hours of Operation: 24

#### **AD 2.19 Radio Navigation and Landing Aids**

2.19.1 ILS Type: DME for runway 21. Magnetic variation: 16E

2.19.2 ILS Identification: GPO

2.19.5 Coordinates: 45-34-47.97N / 122-37-7.94W

2.19.6 Site Elevation: 31 ft

2.19.1 ILS Type: Localizer for runway 21. Magnetic variation: 16E

2.19.2 ILS Identification: GPO

2.19.5 Coordinates: 45-34-49.75N / 122-37-10.47W

2.19.6 Site Elevation: 11.4 ft

2.19.1 ILS Type: DME for runway 10L. Magnetic variation: 16E

2.19.2 ILS Identification: VDG

2.19.5 Coordinates: 45-35-47.9502N / 122-36-13.551W

2.19.6 Site Elevation: 25.5 ft

2.19.1 ILS Type: Glide Slope for runway 10L. Magnetic variation: 16E

2.19.2 ILS Identification: VDG

2.19.5 Coordinates: 45-35-39.7602N / 122-35-30.1707W

2.19.6 Site Elevation: 30.8 ft

2.19.1 ILS Type: Localizer for runway 10L. Magnetic variation: 16E

2.19.2 ILS Identification: VDG

2.19.5 Coordinates: 45-34-55.53N / 122-33-46.85W

2.19.6 Site Elevation: 28.9 ft

2.19.1 ILS Type: DME for runway 28R. Magnetic variation: 16E

2.19.2 ILS Identification: IAP

2.19.5 Coordinates: 45-35-47.95N / 122-36-13.551W

2.19.6 Site Elevation: 25.5 ft

2.19.1 ILS Type: Glide Slope for runway 28R. Magnetic variation: 16E

2.19.2 ILS Identification: IAP

2.19.5 Coordinates: 45-35-10.93N / 122-34-16.4W

2.19.6 Site Elevation: 30.1 ft

2.19.1 ILS Type: Localizer for runway 28R. Magnetic variation: 16E

2.19.2 ILS Identification: IAP

2.19.5 Coordinates: 45-35-52.3N / 122-36-12.47W

2.19.6 Site Elevation: 25.6 ft

2.19.1 ILS Type: DME for runway 10R. Magnetic variation: 16E  
2.19.2 ILS Identification: PDX  
2.19.5 Coordinates: 45-34-46.7386N / 122-34-45.2294W  
2.19.6 Site Elevation: 36 ft

2.19.1 ILS Type: Glide Slope for runway 10R. Magnetic variation: 16E  
2.19.2 ILS Identification: PDX  
2.19.5 Coordinates: 45-35-33.9026N / 122-37-7.2471W  
2.19.6 Site Elevation: 16.1 ft

2.19.1 ILS Type: Inner Marker for runway 10R. Magnetic variation: 16E  
2.19.2 ILS Identification: PDX  
2.19.5 Coordinates: 45-35-46.7091N / 122-37-28.0266W  
2.19.6 Site Elevation: 17 ft

2.19.1 ILS Type: Localizer for runway 10R. Magnetic variation: 16E  
2.19.2 ILS Identification: PDX  
2.19.5 Coordinates: 45-34-43.5268N / 122-34-45.8188W  
2.19.6 Site Elevation: 19.5 ft

2.19.1 ILS Type: DME for runway 28L. Magnetic variation: 16E  
2.19.2 ILS Identification: JMJ  
2.19.5 Coordinates: 45-34-46.7386N / 122-34-45.2294W  
2.19.6 Site Elevation: 36 ft

2.19.1 ILS Type: Glide Slope for runway 28L. Magnetic variation: 16E  
2.19.2 ILS Identification: JMJ  
2.19.5 Coordinates: 45-34-52.6331N / 122-35-16.7121W  
2.19.6 Site Elevation: 19.9 ft

2.19.1 ILS Type: Localizer for runway 28L. Magnetic variation: 16E  
2.19.2 ILS Identification: JMJ  
2.19.5 Coordinates: 45-35-50.5155N / 122-37-37.8096W  
2.19.6 Site Elevation: 24.8 ft

**General Remarks:**

FUEL - A (AIR BP - ATLANTIC AVIATION SVCS. C503-331-4220) J8(MIL) (NC-100LL, A)

BEARING STRENGTH: RWY 03-21 ST 175, RY 10L-28R ST175, RY 10R-28L ST175.

ACFT WITH WINGSPAN GREATER THAN 118 FEET ARE PROHIBITED FROM TURNING EASTBOUND ON TWY C FROM SOUTHWESTBOUND ON TWY F UNLESS UNDER TOW.

NOISE ABATEMENT PROCEDURES IN EFFECT; CALL NOISE OFFICE AT 503-460-4100. RY 28L ARRIVALS ARE NOISE SENSITIVE, EXPECT APCH TO 28R WITH TRANSITION TO 28L.

TWY T BTN EXITS B5 & B6 CLSD TO ACFT WITH WINGSPAN GTR THAN 118 FT.

OIL - O-128-133-148(MIL).

MISC: FLT NOTIFICATION SVC, ADCUS, AVBL.

AREA OF TWY T BTN M & E3 NOT VSB FM TWR.

MIGRATORY & WINTERING FLOCKS OF LRG WATERFOWL ON & INVOF APRT. HEAVY SEAGULL ACTIVITY SEP THRU APR; EXPECT HIGH NMBR OF BIRDS YEAR AROUND; CK LCL ADVISORIES.

ANG: SEE FLIP AP/1 FOR SUPPLEMENTARY ARPT INFO. HAZARDOUS BIRD COND EXIST. PHASE 1 MAY-OCT, PHASE II NOV-APR. CURRENT BIRD WATCH CONDITIONS ARE NOT REPORTED ON ATIS.

ACFT AUTHORIZED TO UTILIZE THE NORTHWEST RAMP WILL BE TOWED TO/FROM THIS RAMP.

ASSC IN USE. OPERATE TRANSPONDERS WITH ALTITUDE REPORTING MODE AND ADS-B (IF EQUIPPED) ENABLED ON ALL AIRPORT SURFACES.

TWY K BTN TWY V & TWY A4 CLSD TO ACFT WINGSPAN MORE THAN 118 FT.

180 DEGREE TURNS BY ACFT WEIGHING IN EXCESS OF 12500 LBS PROHIBITED ON RY 10L/28R, RY 03/21 AND ALL TWYS.

ANG : PPR/OFFL BUS ONLY. BASE OPS OPR 1500-2300Z++ MON-FRI EXC HOL.; DSN 638-4390, C503-335-4390. CTC BASE OPS 15 MIN PRIOR TO LDG AND AFTER DEP ON 281.2. TRAN QUARTERS NOT AVBL. CAUTION: OBST LIGHTING IS NOT NVD COMPATIBLE. NVD NOT AUTHORIZED WHILE AIRBORNE IN VCNTY OF AFLD.

TWY K BTN TWY A5 & TWY V CLSD TO ACFT WINGSPAN MORE THAN 168 FT.

JASU - 4(A/M32A-86) (MC-11) 1(MA-1A).

FLUID - LHOXRB.

(E94) WSFO/WSO/FW/RFC.

TWY V CLSD TO ACFT WITH WINGSPAN GREATER THAN 168 FT. ACFT WITH WINGSPAN GREATER THAN 118 FT PROHIBITED FM TURNING WB ONTO TWY A FM TWY V UNLESS UNDER TOW.

TWY C BTN TWY C6 AND TWY C8 CLSD TO ACFT WITH WINGSPAN GTR THAN 200 FT.

TWY A3 BTN TWY A & THE GA RAMP CLSD TO ACFT WITH WINGSPAN GTR THAN 135 FEET UNLESS UNDER TOW.

UNCONTROLLED TFC AT PEARSON FIELD VANCOUVER WA 3 NM W OF RY 10L THLD ON EXTDD CNTRLN.

ARPT CLSD TO NON-POWERED ACFT EXCP IN EMERG.

AT THE WEST END ARM/DEARM AREA ON TWY C NO ACFT OF ANY TYPE MAY TAXI PAST THE ARM/DEARM AREA WHILE IT IS BEING USED.

TWY C3 CLSD TO ACFT WITH WINGSPAN EQUAL TO OR GTR THAN 79 FT.

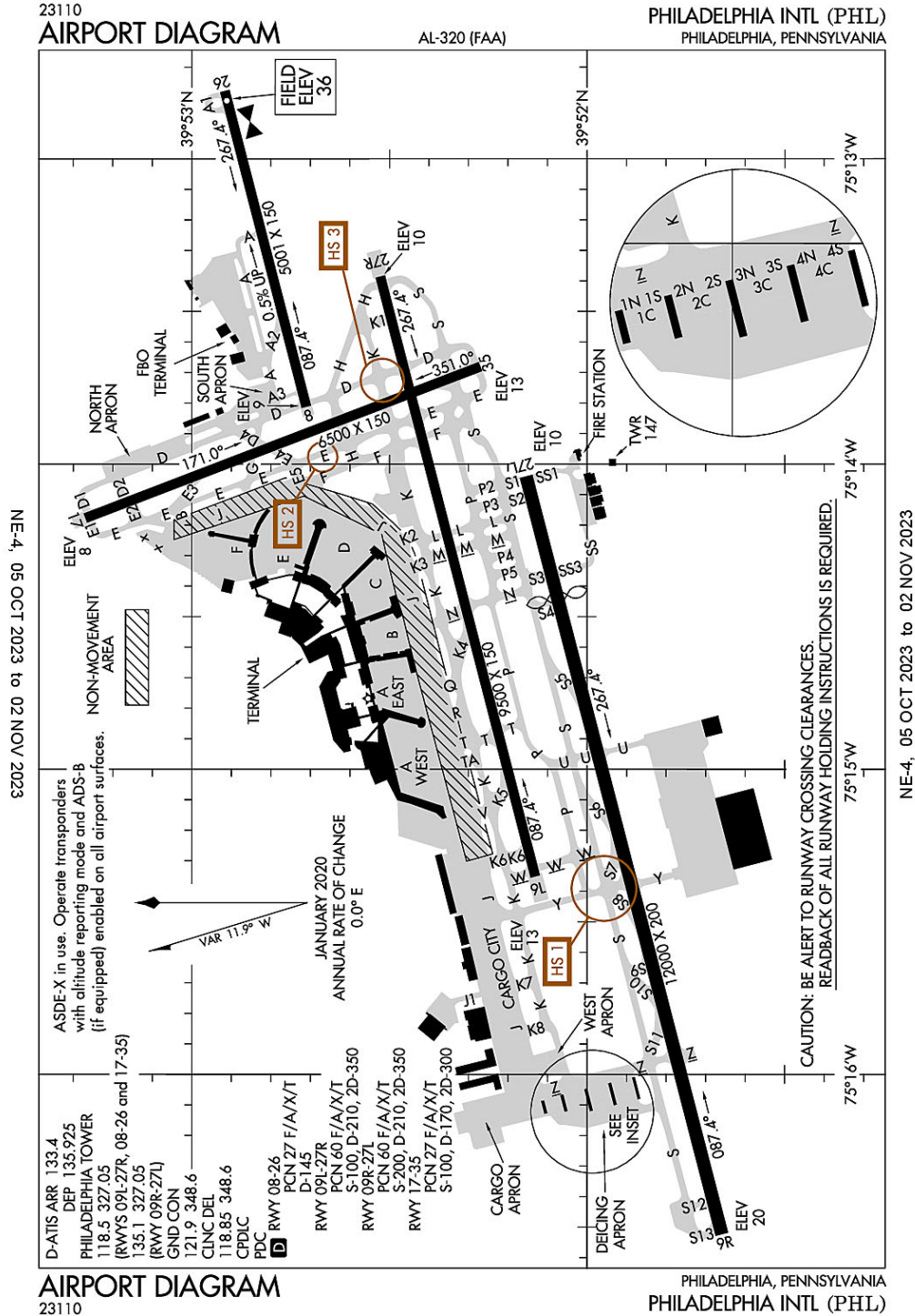
TWY W CLSD TO ACFT WITH WINGSPAN GTR THAN 118 FT UNLESS UNDER TOW.

PDX HAS FAC CONSTRAINTS THAT LMT ITS ABILITY TO ACCOMMODATE DIVD FLTS & MNTN THE ARPT SAFE OPN DUR IREG OPS. ACFT OPRS SHUD CTC THE ARPT DUTY MGR AT (503) 460-4236 TO COORD DIVD FLTS EXC IN THE CASE OF A DECLARED IN-FLT EMERG.

NSTD YELLOW PRK SPOT DESIGNATORS AND EQPT TOOL BOX LCTN PAINTED ON RAMP. PLEASE CTC BASE OPS OR REQ FOLLOW ME IF NOT FAMILIAR WITH PANGB PRK PROCEDURES.

MILITARY: ANG: OREGON ANG E RAMP SUN SHADE OBST LGTS O/S.

**Philadelphia, Pennsylvania  
Philadelphia International  
ICAO Identifier KPHL**



**Philadelphia, PA**  
**Philadelphia Intl**  
**ICAO Identifier KPHL**

**AD 2.2 Aerodrome geographical and administrative data**

- 2.2.1 Reference Point: 39-52-19.502N / 75-14-26.387W
- 2.2.2 From City: 5 miles SW of PHILADELPHIA, PA
- 2.2.3 Elevation: 35.9 ft
- 2.2.5 Magnetic Variation: 12W (2020)
- 2.2.6 Airport Contact: KEITH BRUNE  
DIV OF AVIATION TERMINAL E  
PHILADELPHIA, PA 19153 (215-937-6914)
- 2.2.7 Traffic: IFR/VFR

**AD 2.3 Attendance Schedule**

- 2.3.1 All Months, All Days, All Hours

**AD 2.4 Handling Services and Facilities**

- 2.4.1 Cargo Handling Facilities: YES
- 2.4.2 Fuel Types: 100LL,A
- 2.4.5 Hangar Space: YES
- 2.4.6 Repair Facilities: MAJOR

**AD 2.6 Rescue and Firefighting Services**

- 2.6.1 Aerodrome Category: Class-I certified on 5/1/1973
- 2.6.2 Rescue and Firefighting Services: ARFF Index-E

**AD 2.12 Runway Physical Characteristics**

- 2.12.1 Designation: 08
- 2.12.2 True Bearing: 75
- 2.12.3 Dimensions: 5001 ft x 150 ft
- 2.12.4 PCN: 27 F/A/X/T
- 2.12.5 Coordinates: 39-52-42.0147N / 75-13-48.05W
- 2.12.6 Threshold Elevation: 9.3 ft
- 2.12.6 Touchdown Zone Elevation: 20.3 ft
  
- 2.12.1 Designation: 26
- 2.12.2 True Bearing: 256
- 2.12.3 Dimensions: 5001 ft x 150 ft
- 2.12.4 PCN: 27 F/A/X/T
- 2.12.5 Coordinates: 39-52-54.3825N / 75-12-45.9478W
- 2.12.6 Threshold Elevation: 35.9 ft
- 2.12.6 Touchdown Zone Elevation: 35.9 ft
  
- 2.12.1 Designation: 27R
- 2.12.2 True Bearing: 255
- 2.12.3 Dimensions: 9500 ft x 150 ft
- 2.12.4 PCN: 60 F/A/X/T
- 2.12.5 Coordinates: 39-52-30.7933N / 75-13-22.4291W
- 2.12.6 Threshold Elevation: 10.4 ft
- 2.12.6 Touchdown Zone Elevation: 10.5 ft



2.12.1 Designation: 09L  
2.12.2 True Bearing: 75  
2.12.3 Dimensions: 9500 ft x 150 ft  
2.12.4 PCN: 60 F/A/X/T  
2.12.5 Coordinates: 39-52-7.2582N / 75-15-20.3809W  
2.12.6 Threshold Elevation: 13.2 ft  
2.12.6 Touchdown Zone Elevation: 13.3 ft

2.12.1 Designation: 09R  
2.12.2 True Bearing: 75  
2.12.3 Dimensions: 12000 ft x 200 ft  
2.12.4 PCN: 60 F/A/X/T  
2.12.5 Coordinates: 39-51-38.9137N / 75-16-30.7056W  
2.12.6 Threshold Elevation: 20.1 ft  
2.12.6 Touchdown Zone Elevation: 20.5 ft

2.12.1 Designation: 27L  
2.12.2 True Bearing: 255  
2.12.3 Dimensions: 12000 ft x 200 ft  
2.12.4 PCN: 60 F/A/X/T  
2.12.5 Coordinates: 39-52-8.651N / 75-14-1.719W  
2.12.6 Threshold Elevation: 10.2 ft  
2.12.6 Touchdown Zone Elevation: 10.1 ft

2.12.1 Designation: 17  
2.12.2 True Bearing: 159  
2.12.3 Dimensions: 6500 ft x 150 ft  
2.12.4 PCN: 27 F/A/X/T  
2.12.5 Coordinates: 39-53-15.5714N / 75-14-9.9268W  
2.12.6 Threshold Elevation: 8.2 ft  
2.12.6 Touchdown Zone Elevation: 10.5 ft

2.12.1 Designation: 35  
2.12.2 True Bearing: 339  
2.12.3 Dimensions: 6500 ft x 150 ft  
2.12.4 PCN: 27 F/A/X/T  
2.12.5 Coordinates: 39-52-15.5777N / 75-13-40.1314W  
2.12.6 Threshold Elevation: 12.9 ft  
2.12.6 Touchdown Zone Elevation: 12.9 ft

#### **AD 2.13 Declared Distances**

2.13.1 Designation: 08  
2.13.2 Take-off Run Available: 5001  
2.13.3 Take-off Distance Available: 5001  
2.13.4 Accelerate-Stop Distance Available: 5001  
2.13.5 Landing Distance Available: 5001

2.13.1 Designation: 26  
2.13.2 Take-off Run Available: 5001

2.13.3 Take-off Distance Available: 5001  
2.13.4 Accelerate-Stop Distance Available: 5001  
2.13.5 Landing Distance Available: 5001

2.13.1 Designation: 27R  
2.13.2 Take-off Run Available: 9500  
2.13.3 Take-off Distance Available: 9500  
2.13.4 Accelerate-Stop Distance Available: 9500  
2.13.5 Landing Distance Available: 8864

2.13.1 Designation: 09L  
2.13.2 Take-off Run Available: 9500  
2.13.3 Take-off Distance Available: 9500  
2.13.4 Accelerate-Stop Distance Available: 9500  
2.13.5 Landing Distance Available: 9500

2.13.1 Designation: 09R  
2.13.2 Take-off Run Available: 12000  
2.13.3 Take-off Distance Available: 12000  
2.13.4 Accelerate-Stop Distance Available: 12000  
2.13.5 Landing Distance Available: 12000

2.13.1 Designation: 27L  
2.13.2 Take-off Run Available: 12000  
2.13.3 Take-off Distance Available: 12000  
2.13.4 Accelerate-Stop Distance Available: 11825  
2.13.5 Landing Distance Available: 9912

2.13.1 Designation: 17  
2.13.2 Take-off Run Available: 6500  
2.13.3 Take-off Distance Available: 6500  
2.13.4 Accelerate-Stop Distance Available: 6500  
2.13.5 Landing Distance Available: 6500

2.13.1 Designation: 35  
2.13.2 Take-off Run Available: 6500  
2.13.3 Take-off Distance Available: 6500  
2.13.4 Accelerate-Stop Distance Available: 6500  
2.13.5 Landing Distance Available: 6500

#### **AD 2.14 Approach and Runway Lighting**

2.14.1 Designation: 08  
2.14.2 Approach Lighting System:  
2.14.4 Visual Approach Slope Indicator System:

2.14.1 Designation: 26  
2.14.2 Approach Lighting System: MALSR  
2.14.4 Visual Approach Slope Indicator System: P4R

2.14.1 Designation: 27R

2.14.2 Approach Lighting System: MALSR  
2.14.4 Visual Approach Slope Indicator System: P4L

2.14.1 Designation: 09L  
2.14.2 Approach Lighting System: MALSR  
2.14.4 Visual Approach Slope Indicator System:

2.14.1 Designation: 09R  
2.14.2 Approach Lighting System: ALSF2  
2.14.4 Visual Approach Slope Indicator System: P4R

2.14.1 Designation: 27L  
2.14.2 Approach Lighting System: MALSR  
2.14.4 Visual Approach Slope Indicator System: P4L

2.14.1 Designation: 17  
2.14.2 Approach Lighting System: MALSF  
2.14.4 Visual Approach Slope Indicator System: P4L

2.14.1 Designation: 35  
2.14.2 Approach Lighting System:  
2.14.4 Visual Approach Slope Indicator System: P4L

**AD 2.18 Air Traffic Services Communication Facilities**

2.18.1 Service Designation: 5500 & BLO (NORTH)  
2.18.3 Channel: 123.8  
2.18.5 Hours of Operation:

2.18.1 Service Designation: 5500 & BLO (NORTH)  
2.18.3 Channel: 291.7  
2.18.5 Hours of Operation:

2.18.1 Service Designation: APCH/P (001-089, 5000 FT & BLW)  
2.18.3 Channel: 123.8  
2.18.5 Hours of Operation: 24

2.18.1 Service Designation: APCH/P (270-360, 5000 FT & BLW)  
2.18.3 Channel: 126.85  
2.18.5 Hours of Operation: 24

2.18.1 Service Designation: APCH/P (090-269, 5000 FT & BLW)  
2.18.3 Channel: 127.35  
2.18.5 Hours of Operation: 24

2.18.1 Service Designation: APCH/P (270-089, ABV 5000 FT)  
2.18.3 Channel: 128.4  
2.18.5 Hours of Operation: 24

2.18.1 Service Designation: APCH/P (090-269, 6000-8000 FT)  
2.18.3 Channel: 133.875

2.18.5 Hours of Operation: 24

2.18.1 Service Designation: APCH/P (270-360, 5000 FT & BLW)

2.18.3 Channel: 263.125

2.18.5 Hours of Operation: 24

2.18.1 Service Designation: APCH/P (270-089, ABV 5000 FT)

2.18.3 Channel: 272.575

2.18.5 Hours of Operation: 24

2.18.1 Service Designation: APCH/P (270-089, ABV 5000 FT)

2.18.3 Channel: 273.575

2.18.5 Hours of Operation: 24

2.18.1 Service Designation: APCH/P (001-089, 5000 FT & BLW)

2.18.3 Channel: 291.7

2.18.5 Hours of Operation: 24

2.18.1 Service Designation: APCH/P (090-269 6000-8000 FT)

2.18.3 Channel: 317.55

2.18.5 Hours of Operation: 24

2.18.1 Service Designation: APCH/P (090-269, 5000 FT & BLW)

2.18.3 Channel: 317.55

2.18.5 Hours of Operation: 24

2.18.1 Service Designation: APCH/P DEP/P IC

2.18.3 Channel: 124.35

2.18.5 Hours of Operation: 24

2.18.1 Service Designation: APCH/P DEP/P IC

2.18.3 Channel: 319.15

2.18.5 Hours of Operation: 24

2.18.1 Service Designation: BUNTS STAR

2.18.3 Channel: 128.4

2.18.5 Hours of Operation: 24

2.18.1 Service Designation: BUNTS STAR

2.18.3 Channel: 272.575

2.18.5 Hours of Operation: 24

2.18.1 Service Designation: CD/P

2.18.3 Channel: 118.85

2.18.5 Hours of Operation: 24

2.18.1 Service Designation: CD/P

2.18.3 Channel: 348.6

2.18.5 Hours of Operation: 24

2.18.1 Service Designation: CEDAR LAKE STAR

2.18.3 Channel: 133.875

2.18.5 Hours of Operation: 24

2.18.1 Service Designation: CEDAR LAKE STAR

2.18.3 Channel: 317.55

2.18.5 Hours of Operation: 24

2.18.1 Service Designation: CLASS B (SW 6000 FT & BLW)

2.18.3 Channel: 118.35

2.18.5 Hours of Operation: 24

2.18.1 Service Designation: CLASS B (SE RWY 09 ACTIVE 10000 FT & BLW)

2.18.3 Channel: 119.75

2.18.5 Hours of Operation: 24

2.18.1 Service Designation: CLASS B (SE RWY 27 ACTIVE 8500-10000 FT)

2.18.3 Channel: 119.75

2.18.5 Hours of Operation: 24

2.18.1 Service Designation: CLASS B (SOUTH/SOUTHWEST RWY 27 8500-10000 FT)

2.18.3 Channel: 119.75

2.18.5 Hours of Operation: 24

2.18.1 Service Designation: CLASS B (NE 6500 FT & BLW)

2.18.3 Channel: 123.8

2.18.5 Hours of Operation: 24

2.18.1 Service Designation: CLASS B (W RWY 09 ACTIVE 8500-10000 FT)

2.18.3 Channel: 124.35

2.18.5 Hours of Operation: 24

2.18.1 Service Designation: CLASS B (W RWY 27 ACTIVE 10000 FT & BLW)

2.18.3 Channel: 124.35

2.18.5 Hours of Operation: 24

2.18.1 Service Designation: CLASS B (NW 8000-10000 FT)

2.18.3 Channel: 124.35

2.18.5 Hours of Operation: 24

2.18.1 Service Designation: CLASS B (NE 7000-10000 FT)

2.18.3 Channel: 124.35

2.18.5 Hours of Operation: 24

2.18.1 Service Designation: CLASS B (5500 FT & BLW)

2.18.3 Channel: 126.85

2.18.5 Hours of Operation: 24

2.18.1 Service Designation: CLASS B (SE-SW 5000 FT & BLW)

2.18.3 Channel: 127.35

2.18.5 Hours of Operation: 24

2.18.1 Service Designation: CLASS B (NORTH 6500-7500)  
2.18.3 Channel: 128.4  
2.18.5 Hours of Operation: 24

2.18.1 Service Designation: CLASS B (WEST RWY 09 ACTIVE 8000 FT & BLW)  
2.18.3 Channel: 128.4  
2.18.5 Hours of Operation: 24

2.18.1 Service Designation: CLASS B (6000-8000 FT)  
2.18.3 Channel: 133.875  
2.18.5 Hours of Operation: 24

2.18.1 Service Designation: CLASS B (SOUTHEAST RWY 27 5500-7500)  
2.18.3 Channel: 133.875  
2.18.5 Hours of Operation: 24

2.18.1 Service Designation: CLASS B (5500 FT & BLW)  
2.18.3 Channel: 263.125  
2.18.5 Hours of Operation: 24

2.18.1 Service Designation: CLASS B (SE RWY 27 ACTIVE 8500-10000 FT)  
2.18.3 Channel: 269.25  
2.18.5 Hours of Operation: 24

2.18.1 Service Designation: CLASS B (SE RWY 09 ACTIVE 10000 FT & BLW)  
2.18.3 Channel: 269.25  
2.18.5 Hours of Operation: 24

2.18.1 Service Designation: CLASS B (SOUTH/SOUTHWEST RWY 27 8500-10000 FT)  
2.18.3 Channel: 269.25  
2.18.5 Hours of Operation: 24

2.18.1 Service Designation: CLASS B (WEST RWY 09 ACTIVE 8000 FT & BLW)  
2.18.3 Channel: 272.575  
2.18.5 Hours of Operation: 24

2.18.1 Service Designation: CLASS B (NORTH 6500-7500)  
2.18.3 Channel: 272.575  
2.18.5 Hours of Operation: 24

2.18.1 Service Designation: CLASS B (N NE 6500-7500)  
2.18.3 Channel: 273.575  
2.18.5 Hours of Operation: 24

2.18.1 Service Designation: CLASS B (W RWY 09 ACTIVE 8000 FT & BLW)  
2.18.3 Channel: 273.575  
2.18.5 Hours of Operation: 24

2.18.1 Service Designation: CLASS B (NE RWY 27 ACTIVE 5000 FT & BLW)  
2.18.3 Channel: 291.7  
2.18.5 Hours of Operation: 24

2.18.1 Service Designation: CLASS B (RWY 27, 5500-7500 FT)  
2.18.3 Channel: 317.55  
2.18.5 Hours of Operation: 24

2.18.1 Service Designation: CLASS B (SE-SW 5000 FT & BLW)  
2.18.3 Channel: 317.55  
2.18.5 Hours of Operation: 24

2.18.1 Service Designation: CLASS B (6000-8000 FT)  
2.18.3 Channel: 317.55  
2.18.5 Hours of Operation: 24

2.18.1 Service Designation: CLASS B (NE 7000-10000 FT)  
2.18.3 Channel: 319.15  
2.18.5 Hours of Operation: 24

2.18.1 Service Designation: CLASS B (WEST RWY 09 ACTIVE 8500-10000 FT)  
2.18.3 Channel: 319.15  
2.18.5 Hours of Operation: 24

2.18.1 Service Designation: CLASS B (NW 8000-10000 FT)  
2.18.3 Channel: 319.15  
2.18.5 Hours of Operation: 24

2.18.1 Service Designation: CLASS B (SW 6000 FT & BLW)  
2.18.3 Channel: 323.1  
2.18.5 Hours of Operation: 24

2.18.1 Service Designation: D-ATIS (ARR)  
2.18.3 Channel: 133.4  
2.18.5 Hours of Operation: 24

2.18.1 Service Designation: D-ATIS (DEP)  
2.18.3 Channel: 135.925  
2.18.5 Hours of Operation: 24

2.18.1 Service Designation: DEP/P (090-269)  
2.18.3 Channel: 119.75  
2.18.5 Hours of Operation: 24

2.18.1 Service Designation: DEP/P (270-089)  
2.18.3 Channel: 124.35  
2.18.5 Hours of Operation: 24

2.18.1 Service Designation: DEP/P (090-269)  
2.18.3 Channel: 269.25  
2.18.5 Hours of Operation: 24

2.18.1 Service Designation: DEP/P (270-089)  
2.18.3 Channel: 319.15

2.18.5 Hours of Operation: 24

2.18.1 Service Designation: EMERG

2.18.3 Channel: 121.5

2.18.5 Hours of Operation:

2.18.1 Service Designation: EMERG

2.18.3 Channel: 243

2.18.5 Hours of Operation:

2.18.1 Service Designation: FINAL APCH

2.18.3 Channel: 125.4

2.18.5 Hours of Operation: 24

2.18.1 Service Designation: GND/P

2.18.3 Channel: 121.9

2.18.5 Hours of Operation: 24

2.18.1 Service Designation: GND/P

2.18.3 Channel: 348.6

2.18.5 Hours of Operation: 24

2.18.1 Service Designation: GND/S

2.18.3 Channel: 121.65

2.18.5 Hours of Operation: 24

2.18.1 Service Designation: JIIMS STAR

2.18.3 Channel: 133.875

2.18.5 Hours of Operation: 24

2.18.1 Service Designation: JIIMS STAR

2.18.3 Channel: 317.55

2.18.5 Hours of Operation: 24

2.18.1 Service Designation: LCL/P (RWY 08/26, 09L/27R, 17/35)

2.18.3 Channel: 118.5

2.18.5 Hours of Operation: 24

2.18.1 Service Designation: LCL/P (RWY 09R/27L)

2.18.3 Channel: 135.1

2.18.5 Hours of Operation: 24

2.18.1 Service Designation: LCL/P

2.18.3 Channel: 327.05

2.18.5 Hours of Operation: 24

2.18.1 Service Designation: PAATS STAR

2.18.3 Channel: 133.875

2.18.5 Hours of Operation: 24

2.18.1 Service Designation: PAATS STAR



2.18.3 Channel: 317.55  
2.18.5 Hours of Operation: 24

2.18.1 Service Designation: PHL ONE DP  
2.18.3 Channel: 124.35  
2.18.5 Hours of Operation: 24

2.18.1 Service Designation: PHL ONE DP  
2.18.3 Channel: 319.15  
2.18.5 Hours of Operation: 24

2.18.1 Service Designation: PRM (RWY 27L)  
2.18.3 Channel: 120.425  
2.18.5 Hours of Operation: 24

2.18.1 Service Designation: PRM (RWY 26)  
2.18.3 Channel: 123.6  
2.18.5 Hours of Operation: 24

2.18.1 Service Designation: SLATT STAR  
2.18.3 Channel: 128.4  
2.18.5 Hours of Operation: 24

2.18.1 Service Designation: SLATT STAR  
2.18.3 Channel: 273.575  
2.18.5 Hours of Operation: 24

2.18.1 Service Designation: SPUDS STAR  
2.18.3 Channel: 128.4  
2.18.5 Hours of Operation: 24

2.18.1 Service Designation: SPUDS STAR  
2.18.3 Channel: 272.575  
2.18.5 Hours of Operation: 24

#### **AD 2.19 Radio Navigation and Landing Aids**

2.19.1 ILS Type: DME for runway 26. Magnetic variation: 12W  
2.19.2 ILS Identification: LLH  
2.19.5 Coordinates: 39-52-42.2207N / 75-13-32.3765W  
2.19.6 Site Elevation: 28.9 ft

2.19.1 ILS Type: Glide Slope for runway 26. Magnetic variation: 12W  
2.19.2 ILS Identification: LLH  
2.19.5 Coordinates: 39-52-49.3706N / 75-12-58.3473W  
2.19.6 Site Elevation: 21.3 ft

2.19.1 ILS Type: Localizer for runway 26. Magnetic variation: 12W  
2.19.2 ILS Identification: LLH  
2.19.5 Coordinates: 39-52-42.383N / 75-13-31.8279W  
2.19.6 Site Elevation: 5.4 ft

2.19.1 ILS Type: DME for runway 09L. Magnetic variation: 12W  
2.19.2 ILS Identification: VII  
2.19.5 Coordinates: 39-52-37.1712N / 75-13-11.1396W  
2.19.6 Site Elevation: 20 ft

2.19.1 ILS Type: Glide Slope for runway 09L. Magnetic variation: 12W  
2.19.2 ILS Identification: VII  
2.19.5 Coordinates: 39-52-6.03N / 75-15-6.06W  
2.19.6 Site Elevation: 8.9 ft

2.19.1 ILS Type: Localizer for runway 09L. Magnetic variation: 12W  
2.19.2 ILS Identification: VII  
2.19.5 Coordinates: 39-52-33.52N / 75-13-8.777W  
2.19.6 Site Elevation: 7.2 ft

2.19.1 ILS Type: DME for runway 27R. Magnetic variation: 12W  
2.19.2 ILS Identification: PDP  
2.19.5 Coordinates: 39-52-37.1712N / 75-13-11.1396W  
2.19.6 Site Elevation: 20 ft

2.19.1 ILS Type: Glide Slope for runway 27R. Magnetic variation: 12W  
2.19.2 ILS Identification: PDP  
2.19.5 Coordinates: 39-52-24.0466N / 75-13-35.8144W  
2.19.6 Site Elevation: 7.5 ft

2.19.1 ILS Type: Localizer for runway 27R. Magnetic variation: 12W  
2.19.2 ILS Identification: PDP  
2.19.5 Coordinates: 39-52-4.7498N / 75-15-32.9263W  
2.19.6 Site Elevation: 8.8 ft

2.19.1 ILS Type: DME for runway 09R. Magnetic variation: 12W  
2.19.2 ILS Identification: PHL  
2.19.5 Coordinates: 39-52-7.3002N / 75-13-47.0459W  
2.19.6 Site Elevation: 23.5 ft

2.19.1 ILS Type: Glide Slope for runway 09R. Magnetic variation: 12W  
2.19.2 ILS Identification: PHL  
2.19.5 Coordinates: 39-51-37.8234N / 75-16-15.7274W  
2.19.6 Site Elevation: 13.3 ft

2.19.1 ILS Type: Inner Marker for runway 09R. Magnetic variation: 12W  
2.19.2 ILS Identification: PHL  
2.19.5 Coordinates: 39-51-36.7356N / 75-16-41.589W  
2.19.6 Site Elevation: 7.2 ft

2.19.1 ILS Type: Localizer for runway 09R. Magnetic variation: 12W  
2.19.2 ILS Identification: PHL  
2.19.5 Coordinates: 39-52-11.1577N / 75-13-49.1415W  
2.19.6 Site Elevation: 9.1 ft

2.19.1 ILS Type: DME for runway 27L. Magnetic variation: 12W  
2.19.2 ILS Identification: GLC  
2.19.5 Coordinates: 39-52-7.3002N / 75-13-47.0459W  
2.19.6 Site Elevation: 23.5 ft

2.19.1 ILS Type: Glide Slope for runway 27L. Magnetic variation: 12W  
2.19.2 ILS Identification: GLC  
2.19.5 Coordinates: 39-51-57.2838N / 75-14-37.7318W  
2.19.6 Site Elevation: 8.5 ft

2.19.1 ILS Type: Localizer for runway 27L. Magnetic variation: 12W  
2.19.2 ILS Identification: GLC  
2.19.5 Coordinates: 39-51-36.2572N / 75-16-43.9517W  
2.19.6 Site Elevation: 6.8 ft

2.19.1 ILS Type: DME for runway 17. Magnetic variation: 12W  
2.19.2 ILS Identification: MYY  
2.19.5 Coordinates: 39-52-6.7468N / 75-13-39.3372W  
2.19.6 Site Elevation: 24.5 ft

2.19.1 ILS Type: Glide Slope for runway 17. Magnetic variation: 12W  
2.19.2 ILS Identification: MYY  
2.19.5 Coordinates: 39-53-5.9004N / 75-14-8.6899W  
2.19.6 Site Elevation: 6.2 ft

2.19.1 ILS Type: Localizer for runway 17. Magnetic variation: 12W  
2.19.2 ILS Identification: MYY  
2.19.5 Coordinates: 39-52-6.3204N / 75-13-35.5323W  
2.19.6 Site Elevation: 12 ft

**General Remarks:**

ARPT IS LCTD IN A NOISE SENSITIVE AREA. AIRPORT NOISE ABATEMENT TAKEOFF PROCEDURES ARE TO BE USED.

ONLY NOSE-IN PRKG PERMITTED ON NORTH REMOTE APNS. PPR FM ARPT OPS FOR ALL ACFT PRKG ON REMOTE APNS; CTC 215-937-6914/6800.

RY 09R ROLLOUT RVR USED FOR RY 09L MIDPOINT RVR.

RYS 27L, 27R & 35 SHIP CHNL (DELAWARE RIVER) MAX HEIGHT OF SHIPS 189 FT. RY 26 SHIP CHNL (SCHUYLKILL) MAX HEIGHT OF SHIPS 149 FT.

ASDE-X IN USE. OPERATE TRANSPONDERS WITH ALTITUDE REPORTING MODE AND ADS-B (IF EQUIPPED) ENABLED ON ALL AIRPORT SURFACES.

ALL ACFT TRAVELING ON TWY J MUST USE MINIMUM POWER WHEN TURNING SOUTH DUE TO JETBLAST CONCERNS.

UNLGTD STACK 288 FT MSL (271 FT AGL) 2.3 NM SW OF ARPT.

TCAS EQUIPPED ACFT-TCAS ALERT MAY BE CAUSED BY TRANSPONDER EQUIPPED SHIPS LCTD PHL NAVAL BASE 3 NM E.

TWY J BTN TWYS K3 AND Q RESTRICTED TO ACFT WITH WINGSPANS 171 FT AND LESS.

ALL ENGINE RUNUPS REQUIRE PPR FM DUTY OPNS OFFICER AT 937-6914/6800; RUNUPS 20 MIN MAXIMUM.

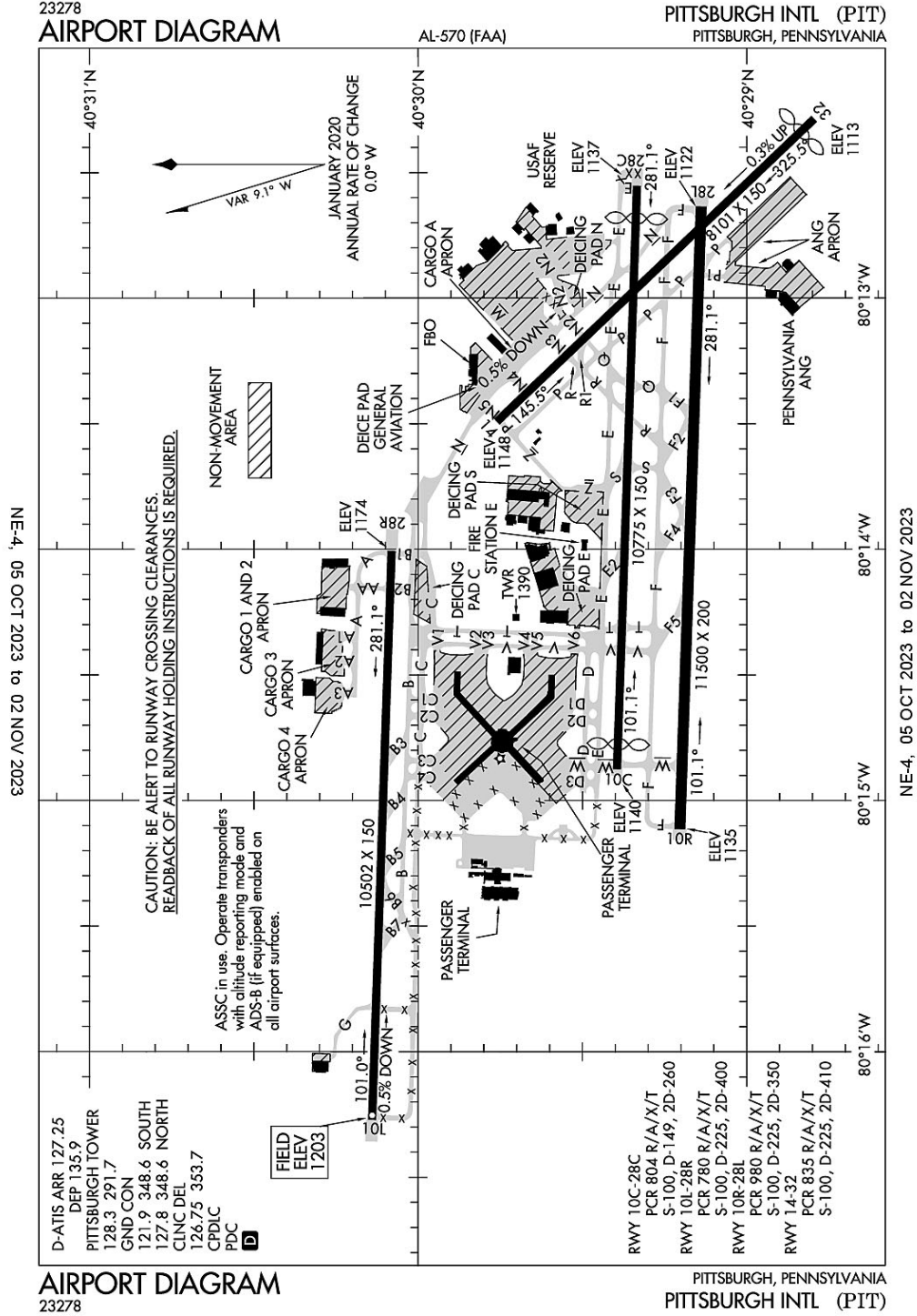
POSSIBLE UNMARKED SHIP OBSTRUCTION TRANSITING EAST OR WESTBOUND ALONG THE DELAWARE RIVER REACHING HEIGHTS OF 189' - BE ALERT WHEN APPROACHING PHL RUNWAY 35 AND WHENEVER CIRCLING OR VISUALLY APPROACHING ALL OTHER RUNWAYS.

BIRDS ON & INVOF ARPT.

# Pittsburgh, Pennsylvania

## Pittsburgh International

### ICAO Identifier KPIT



**Pittsburgh, PA**  
**Pittsburgh Intl**  
**ICAO Identifier KPIT**

**AD 2.2 Aerodrome geographical and administrative data**

- 2.2.1 Reference Point: 40-29-29.1N / 80-13-57.7W
- 2.2.2 From City: 12 miles NW of PITTSBURGH, PA
- 2.2.3 Elevation: 1202.9 ft
- 2.2.5 Magnetic Variation: 9W (2020)
- 2.2.6 Airport Contact: CHRISTINA A. CASSOTIS  
PO BOX 12370, SUITE 4000  
PITTSBURGH, PA 15231 ((412) 472-3509)
- 2.2.7 Traffic: IFR/VFR

**AD 2.3 Attendance Schedule**

- 2.3.1 All Months, All Days, All Hours

**AD 2.4 Handling Services and Facilities**

- 2.4.1 Cargo Handling Facilities: YES
- 2.4.2 Fuel Types: 100LL,A
- 2.4.5 Hangar Space: YES
- 2.4.6 Repair Facilities: MINOR

**AD 2.6 Rescue and Firefighting Services**

- 2.6.1 Aerodrome Category: Class-I certified on 5/1/1973
- 2.6.2 Rescue and Firefighting Services: ARFF Index-D

**AD 2.12 Runway Physical Characteristics**

- 2.12.1 Designation: 28C
- 2.12.2 True Bearing: 272
- 2.12.3 Dimensions: 10775 ft x 150 ft
- 2.12.4 PCN:
- 2.12.5 Coordinates: 40-29-20.0419N / 80-12-33.1754W
- 2.12.6 Threshold Elevation: 1136.6 ft
- 2.12.6 Touchdown Zone Elevation: 1133.5 ft

- 2.12.1 Designation: 10C
- 2.12.2 True Bearing: 92
- 2.12.3 Dimensions: 10775 ft x 150 ft
- 2.12.4 PCN:
- 2.12.5 Coordinates: 40-29-23.6989N / 80-14-52.5475W
- 2.12.6 Threshold Elevation: 1140.2 ft
- 2.12.6 Touchdown Zone Elevation: 1141.4 ft

- 2.12.1 Designation: 10L
- 2.12.2 True Bearing: 92
- 2.12.3 Dimensions: 10502 ft x 150 ft
- 2.12.4 PCN:
- 2.12.5 Coordinates: 40-30-8.4012N / 80-16-16.2687W
- 2.12.6 Threshold Elevation: 1202.9 ft
- 2.12.6 Touchdown Zone Elevation: 1202.9 ft

2.12.1 Designation: 28R  
2.12.2 True Bearing: 272  
2.12.3 Dimensions: 10502 ft x 150 ft  
2.12.4 PCN:  
2.12.5 Coordinates: 40-30-4.8667N / 80-14-0.4048W  
2.12.6 Threshold Elevation: 1174.1 ft  
2.12.6 Touchdown Zone Elevation: 1174.1 ft

2.12.1 Designation: 10R  
2.12.2 True Bearing: 92  
2.12.3 Dimensions: 11500 ft x 200 ft  
2.12.4 PCN:  
2.12.5 Coordinates: 40-29-12.2249N / 80-15-6.8568W  
2.12.6 Threshold Elevation: 1134.8 ft  
2.12.6 Touchdown Zone Elevation: 1134.8 ft

2.12.1 Designation: 28L  
2.12.2 True Bearing: 272  
2.12.3 Dimensions: 11500 ft x 200 ft  
2.12.4 PCN:  
2.12.5 Coordinates: 40-29-8.3238N / 80-12-38.1249W  
2.12.6 Threshold Elevation: 1121.9 ft  
2.12.6 Touchdown Zone Elevation: 1125 ft

2.12.1 Designation: 32  
2.12.2 True Bearing: 316  
2.12.3 Dimensions: 8101 ft x 150 ft  
2.12.4 PCN:  
2.12.5 Coordinates: 40-28-47.69N / 80-12-17.2183W  
2.12.6 Threshold Elevation: 1113.4 ft  
2.12.6 Touchdown Zone Elevation: 1123.6 ft

2.12.1 Designation: 14  
2.12.2 True Bearing: 136  
2.12.3 Dimensions: 8101 ft x 150 ft  
2.12.4 PCN:  
2.12.5 Coordinates: 40-29-45.6544N / 80-13-29.5187W  
2.12.6 Threshold Elevation: 1147.6 ft  
2.12.6 Touchdown Zone Elevation: 1147.6 ft

#### **AD 2.13 Declared Distances**

2.13.1 Designation: 28C  
2.13.2 Take-off Run Available: 10775  
2.13.3 Take-off Distance Available: 10775  
2.13.4 Accelerate-Stop Distance Available: 10310  
2.13.5 Landing Distance Available: 9708

2.13.1 Designation: 10C  
2.13.2 Take-off Run Available: 10775

2.13.3 Take-off Distance Available: 10775  
2.13.4 Accelerate-Stop Distance Available: 10173  
2.13.5 Landing Distance Available: 9708

2.13.1 Designation: 10L  
2.13.2 Take-off Run Available: 10502  
2.13.3 Take-off Distance Available: 10502  
2.13.4 Accelerate-Stop Distance Available: 10502  
2.13.5 Landing Distance Available: 10502

2.13.1 Designation: 28R  
2.13.2 Take-off Run Available: 10502  
2.13.3 Take-off Distance Available: 10502  
2.13.4 Accelerate-Stop Distance Available: 10102  
2.13.5 Landing Distance Available: 10102

2.13.1 Designation: 10R  
2.13.2 Take-off Run Available: 11500  
2.13.3 Take-off Distance Available: 11500  
2.13.4 Accelerate-Stop Distance Available: 11492  
2.13.5 Landing Distance Available: 11492

2.13.1 Designation: 28L  
2.13.2 Take-off Run Available: 11500  
2.13.3 Take-off Distance Available: 11500  
2.13.4 Accelerate-Stop Distance Available: 11500  
2.13.5 Landing Distance Available: 11500

2.13.1 Designation: 32  
2.13.2 Take-off Run Available: 8101  
2.13.3 Take-off Distance Available: 8101  
2.13.4 Accelerate-Stop Distance Available: 7801  
2.13.5 Landing Distance Available: 7466

2.13.1 Designation: 14  
2.13.2 Take-off Run Available: 8101  
2.13.3 Take-off Distance Available: 8101  
2.13.4 Accelerate-Stop Distance Available: 7366  
2.13.5 Landing Distance Available: 7366

**AD 2.14 Approach and Runway Lighting**

2.14.1 Designation: 28C  
2.14.2 Approach Lighting System:  
2.14.4 Visual Approach Slope Indicator System: P4L

2.14.1 Designation: 10C  
2.14.2 Approach Lighting System:  
2.14.4 Visual Approach Slope Indicator System: P4L

2.14.1 Designation: 10L



2.14.2 Approach Lighting System: ALSF2  
2.14.4 Visual Approach Slope Indicator System: P4L

2.14.1 Designation: 28R  
2.14.2 Approach Lighting System: MALSR  
2.14.4 Visual Approach Slope Indicator System: P4L

2.14.1 Designation: 10R  
2.14.2 Approach Lighting System: ALSF2  
2.14.4 Visual Approach Slope Indicator System: P4L

2.14.1 Designation: 28L  
2.14.2 Approach Lighting System: MALSR  
2.14.4 Visual Approach Slope Indicator System: P4L

2.14.1 Designation: 32  
2.14.2 Approach Lighting System: MALS  
2.14.4 Visual Approach Slope Indicator System: P4L

2.14.1 Designation: 14  
2.14.2 Approach Lighting System:  
2.14.4 Visual Approach Slope Indicator System: P4L

#### **AD 2.18 Air Traffic Services Communication Facilities**

2.18.1 Service Designation: ANG OPS  
2.18.3 Channel: 311  
2.18.5 Hours of Operation:

2.18.1 Service Designation: APCH/P (271-360)  
2.18.3 Channel: 121.25  
2.18.5 Hours of Operation: 24

2.18.1 Service Designation: APCH/P (001-090)  
2.18.3 Channel: 124.15  
2.18.5 Hours of Operation: 24

2.18.1 Service Designation: APCH/P (181-270)  
2.18.3 Channel: 133.7  
2.18.5 Hours of Operation: 24

2.18.1 Service Designation: APCH/P (270-089)  
2.18.3 Channel: 279.625  
2.18.5 Hours of Operation: 24

2.18.1 Service Designation: APCH/P (090-269)  
2.18.3 Channel: 360.8  
2.18.5 Hours of Operation: 24

2.18.1 Service Designation: APCH/P DEP/P  
2.18.3 Channel: 336.2

2.18.5 Hours of Operation: 24

2.18.1 Service Designation: APCH/P IC (091-180)

2.18.3 Channel: 123.95

2.18.5 Hours of Operation: 24

2.18.1 Service Designation: CD PRE TAXI CLNC

2.18.3 Channel: 126.75

2.18.5 Hours of Operation: 24

2.18.1 Service Designation: CD/P

2.18.3 Channel: 353.7

2.18.5 Hours of Operation: 24

2.18.1 Service Designation: CLASS B (271-360)

2.18.3 Channel: 121.25

2.18.5 Hours of Operation: 24

2.18.1 Service Designation: CLASS B (091-180)

2.18.3 Channel: 123.95

2.18.5 Hours of Operation: 24

2.18.1 Service Designation: CLASS B (001-090)

2.18.3 Channel: 124.15

2.18.5 Hours of Operation: 24

2.18.1 Service Designation: CLASS B (181-270)

2.18.3 Channel: 133.7

2.18.5 Hours of Operation: 24

2.18.1 Service Designation: CLASS B (270-089)

2.18.3 Channel: 279.625

2.18.5 Hours of Operation: 24

2.18.1 Service Designation: CLASS B (090-269)

2.18.3 Channel: 360.8

2.18.5 Hours of Operation: 24

2.18.1 Service Designation: COMD POST

2.18.3 Channel: 252.1

2.18.5 Hours of Operation:

2.18.1 Service Designation: D-ATIS (ARR)

2.18.3 Channel: 127.25

2.18.5 Hours of Operation: 24

2.18.1 Service Designation: D-ATIS (DEP)

2.18.3 Channel: 135.9

2.18.5 Hours of Operation: 24

2.18.1 Service Designation: DEP/P (SOUTH)

2.18.3 Channel: 119.35  
2.18.5 Hours of Operation: 24

2.18.1 Service Designation: DEP/P (NORTH)  
2.18.3 Channel: 124.75  
2.18.5 Hours of Operation: 24

2.18.1 Service Designation: DEP/P (090-269)  
2.18.3 Channel: 285.575  
2.18.5 Hours of Operation: 24

2.18.1 Service Designation: DEP/P (NORTH)  
2.18.3 Channel: 338.2  
2.18.5 Hours of Operation: 24

2.18.1 Service Designation: DEP/S  
2.18.3 Channel: 125.275  
2.18.5 Hours of Operation: 24

2.18.1 Service Designation: EMERG  
2.18.3 Channel: 121.5  
2.18.5 Hours of Operation:

2.18.1 Service Designation: EMERG  
2.18.3 Channel: 243  
2.18.5 Hours of Operation:

2.18.1 Service Designation: GND/P (SOUTH)  
2.18.3 Channel: 121.9  
2.18.5 Hours of Operation: 24

2.18.1 Service Designation: GND/P (NORTH)  
2.18.3 Channel: 127.8  
2.18.5 Hours of Operation: 24

2.18.1 Service Designation: GND/P  
2.18.3 Channel: 348.6  
2.18.5 Hours of Operation: 24

2.18.1 Service Designation: LCL/P  
2.18.3 Channel: 128.3  
2.18.5 Hours of Operation: 24

2.18.1 Service Designation: LCL/P  
2.18.3 Channel: 291.7  
2.18.5 Hours of Operation: 24

2.18.1 Service Designation: OPS  
2.18.3 Channel: 36.35  
2.18.5 Hours of Operation:

**AD 2.19 Radio Navigation and Landing Aids**

2.19.1 ILS Type: Glide Slope for runway 10L. Magnetic variation: 9W  
2.19.2 ILS Identification: LXB  
2.19.5 Coordinates: 40-30-11.9236N / 80-15-59.9044W  
2.19.6 Site Elevation: 1195 ft

2.19.1 ILS Type: Inner Marker for runway 10L. Magnetic variation: 9W  
2.19.2 ILS Identification: LXB  
2.19.5 Coordinates: 40-30-8.7927N / 80-16-27.004W  
2.19.6 Site Elevation: 1175.5 ft

2.19.1 ILS Type: Localizer for runway 10L. Magnetic variation: 9W  
2.19.2 ILS Identification: LXB  
2.19.5 Coordinates: 40-30-4.5231N / 80-13-47.1428W  
2.19.6 Site Elevation: 1160.8 ft

2.19.1 ILS Type: Glide Slope for runway 28R. Magnetic variation: 9W  
2.19.2 ILS Identification: HFE  
2.19.5 Coordinates: 40-30-8.7192N / 80-14-14.6252W  
2.19.6 Site Elevation: 1170.6 ft

2.19.1 ILS Type: Localizer for runway 28R. Magnetic variation: 9W  
2.19.2 ILS Identification: HFE  
2.19.5 Coordinates: 40-30-8.7888N / 80-16-31.3335W  
2.19.6 Site Elevation: 1214.2 ft

2.19.1 ILS Type: Glide Slope for runway 10R. Magnetic variation: 9W  
2.19.2 ILS Identification: GUT  
2.19.5 Coordinates: 40-29-15.3464N / 80-14-53.775W  
2.19.6 Site Elevation: 1129.2 ft

2.19.1 ILS Type: Inner Marker for runway 10R. Magnetic variation: 9W  
2.19.2 ILS Identification: GUT  
2.19.5 Coordinates: 40-29-12.5381N / 80-15-18.8824W  
2.19.6 Site Elevation: 1144.8 ft

2.19.1 ILS Type: Localizer for runway 10R. Magnetic variation: 9W  
2.19.2 ILS Identification: GUT  
2.19.5 Coordinates: 40-29-8.2188N / 80-12-34.1165W  
2.19.6 Site Elevation: 1116.6 ft

2.19.1 ILS Type: Glide Slope for runway 28L. Magnetic variation: 9W  
2.19.2 ILS Identification: PFS  
2.19.5 Coordinates: 40-29-4.7301N / 80-12-51.2688W  
2.19.6 Site Elevation: 1120.3 ft

2.19.1 ILS Type: Localizer for runway 28L. Magnetic variation: 9W  
2.19.2 ILS Identification: PFS  
2.19.5 Coordinates: 40-29-12.6437N / 80-15-23.0275W  
2.19.6 Site Elevation: 1141.2 ft

2.19.1 ILS Type: DME for runway 32. Magnetic variation: 9W  
2.19.2 ILS Identification: TQW  
2.19.5 Coordinates: 40-29-48.847N / 80-13-37.583W  
2.19.6 Site Elevation: 1134 ft

2.19.1 ILS Type: Glide Slope for runway 32. Magnetic variation: 9W  
2.19.2 ILS Identification: TQW  
2.19.5 Coordinates: 40-28-52.663N / 80-12-29.1403W  
2.19.6 Site Elevation: 1112.2 ft

2.19.1 ILS Type: Localizer for runway 32. Magnetic variation: 9W  
2.19.2 ILS Identification: TQW  
2.19.5 Coordinates: 40-29-50.4118N / 80-13-35.4629W  
2.19.6 Site Elevation: 1139.1 ft

**General Remarks:**

TWY AA NO TURN-OFF ONTO TWY A FOR ACFT WINGSPAN 171 FT OR GREATER EXC PPR (412) 472-5630.

[MILITARY]: CAUTION: BASH PHASE II OPS IN EFFECT 1 JUL - 31 AUG ANNUALLY. UNLESS MSN REQUIREMENTS DIRECT OTHERWISE, FLIGHTS SHOULD NOT BE SKED WITHIN +/-1HR OF SS/SR. TRAN AIRCREW SHOULD REQ BIRD WATCH COND FR AFRC (PITT OPS) ON 252.1 OR ANG OPS (STEEL CTL) ON 311.0. AIRCREW WILL BE INFORMED BY STEEL CONTROL OR PITT OPS (AS APPLICABLE) IF CURRENT BWC IS OTHER THAN LOW REGARDLESS OF BASH PHASE.

SERVICE-OIL: O-156.

TERML TAXILANES E OF CONCOURSES A & B RESTRD TO GROUP 3 ACFT & SMALLER.

ACFT USING TWY 'N' PROHIBITED TO STOP ON OVERPASS AREA DUE TO POSSIBLE EMERGENCY EVACUATION HAZARD.

DEER & BIRDS ON & INVOF ARPT.

ANG: OPR 1130-2030Z++MON-FRI EXCP HOL. (CLSD EV OTH MON.)

PPR/OFFL BUS MIN 48 HR CTC AFLD MGMT DSN 277 8163, C412 474 8163. LTD TRAN SVC. AFLD MGT NML DUTY HRS 1300 0100++ MON, WED, FRI, 1300-0500++ TUE, THU, EXC HOL. UNIT TRAINING ASSEMBLY 1300 2100Z++SAT. TRAN ACFT MUST HAVE APPVL OF 911OG/CC FOR PPR DUR OFF DUTY HR. NO SVC AVBL FOR SPACE AVBL PAX DUR OFF DUTY HR. CALL PITT COMD POST (IRON CITY) BY RDO 15 MIN PRIOR TO ARRIVAL. ALFD MGMT DOES NOT ISSUE OR STOR COMSEC. COMSEC STOR CTC COMD POST DSN 277 8146.

ANG ACFT MUST CTC TANKER 303.0/FTR OPNS 293.7 BEFORE CROSSING RWY 28L TO OBTAIN CLNC TO ENTER.

ASSC IN USE. OPERATE TRANSPONDERS WITH ALTITUDE REPORTING MODE AND ADS-B (IF EQUIPPED) ENABLED ON ALL AIRPORT SURFACES.

SERVICE-TRAN ALERT: NO PRIORITY BASIS.

FUEL: A++ PROVIDED BY ANG AND AFRC.(MIL).

LDG FEE.

TRML APN UNCONTROLLED. PUSHBACK PILOT DESCRETION. DO NOT EXIT TRML APN AT TWY C1, C4,

V3, V4, D1, W. CTC GC WHEN HLDG AT TWY C2, C3, V1, V2, V5, V6, D2, D3.

PUSHBACK CLNC REQUIRED FR GATES A100 AND A101 AT CARGO A. CTC GC. PUSHBACK FM THESE GATES ENTERS TWY N.

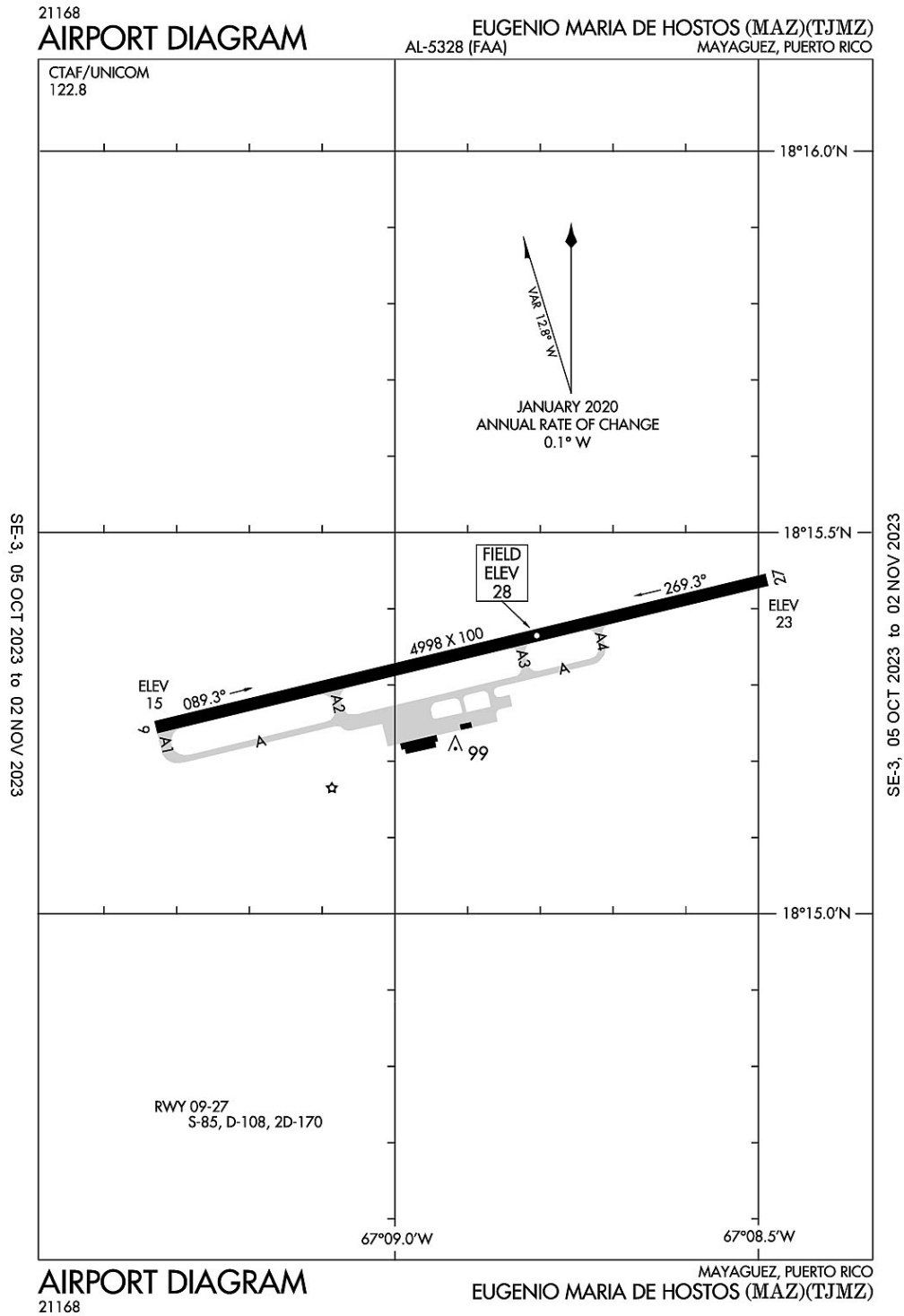
SERVICE-JASU: (ANG) (A/M32A-86) (AM 32-95; (AFRC - 2(A/M32-86 (AM32-95).

SERVICE-FLUID: LPOX LHNT.

ATCT IS AUTHORIZED TO HAVE ACFT LINE-UP & WAIT ON RYS 28L AT TWY 'P' DURG HRS OF DARKNESS. THE SPECIFIC RY SHALL BE USED ONLY FOR DEPARTURES & THE INTXN MUST BE VSB FM ATCT.

TWY G INTXN AT RY 10L/28R RIGHT TURN NA.

**Mayaguez, Puerto Rico**  
**Eugenio Maria De Hostos**  
**ICAO Identifier TJMZ**



**Mayaguez, PR**  
**Eugenio Maria De Hostos**  
**ICAO Identifier TJMZ**

**AD 2.2 Aerodrome geographical and administrative data**

- 2.2.1 Reference Point: 18-15-20.5N / 67-8-54.5W
- 2.2.2 From City: 3 miles N of MAYAGUEZ, PR
- 2.2.3 Elevation: 27.7 ft
- 2.2.5 Magnetic Variation: 10W (1985)
- 2.2.6 Airport Contact: EDGAR SIERRA  
BOX 710  
MAYAGUEZ, PR 681 (787-832-3390)
- 2.2.7 Traffic: IFR/VFR

**AD 2.3 Attendance Schedule**

- 2.3.1 All Months, MON-FRI Days, 0730-1600 Hours

**AD 2.4 Handling Services and Facilities**

- 2.4.1 Cargo Handling Facilities: NO
- 2.4.2 Fuel Types:
- 2.4.5 Hangar Space: NO
- 2.4.6 Repair Facilities: NONE

**AD 2.6 Rescue and Firefighting Services**

- 2.6.1 Aerodrome Category: None
- 2.6.2 Rescue and Firefighting Services: None

**AD 2.12 Runway Physical Characteristics**

- 2.12.1 Designation: 27
  - 2.12.2 True Bearing: 256
  - 2.12.3 Dimensions: 4998 ft x 100 ft
  - 2.12.4 PCN:
  - 2.12.5 Coordinates: 18-15-26.2517N / 67-8-29.2981W
  - 2.12.6 Threshold Elevation: 23.2 ft
  - 2.12.6 Touchdown Zone Elevation: 27.7 ft
- 
- 2.12.1 Designation: 09
  - 2.12.2 True Bearing: 76
  - 2.12.3 Dimensions: 4998 ft x 100 ft
  - 2.12.4 PCN:
  - 2.12.5 Coordinates: 18-15-14.6817N / 67-9-19.728W
  - 2.12.6 Threshold Elevation: 15.3 ft
  - 2.12.6 Touchdown Zone Elevation: 27.6 ft



**AD 2.13 Declared Distances**

- 2.13.1 Designation: 27
- 2.13.2 Take-off Run Available:
- 2.13.3 Take-off Distance Available:
- 2.13.4 Accelerate-Stop Distance Available:
- 2.13.5 Landing Distance Available:

- 2.13.1 Designation: 09
- 2.13.2 Take-off Run Available:
- 2.13.3 Take-off Distance Available:
- 2.13.4 Accelerate-Stop Distance Available:
- 2.13.5 Landing Distance Available:

**AD 2.14 Approach and Runway Lighting**

- 2.14.1 Designation: 27
- 2.14.2 Approach Lighting System:
- 2.14.4 Visual Approach Slope Indicator System: P4L

- 2.14.1 Designation: 09
- 2.14.2 Approach Lighting System:
- 2.14.4 Visual Approach Slope Indicator System: P4L

**AD 2.18 Air Traffic Services Communication Facilities**

**AD 2.19 Radio Navigation and Landing Aids**

- 2.19.1 Navigation Aid Type: NDB. Magnetic variation: 10W
- 2.19.2 Navigation Aid Identification: MAZ
- 2.19.5 Coordinates: 18-15-13.529N / 67-9-8.947W
- 2.19.6 Site Elevation:

- 2.19.1 Navigation Aid Type: VOR/DME. Magnetic variation: 10W
- 2.19.2 Navigation Aid Identification: MAZ
- 2.19.5 Coordinates: 18-15-23.2293N / 67-9-3.7215W
- 2.19.6 Site Elevation: 18 ft

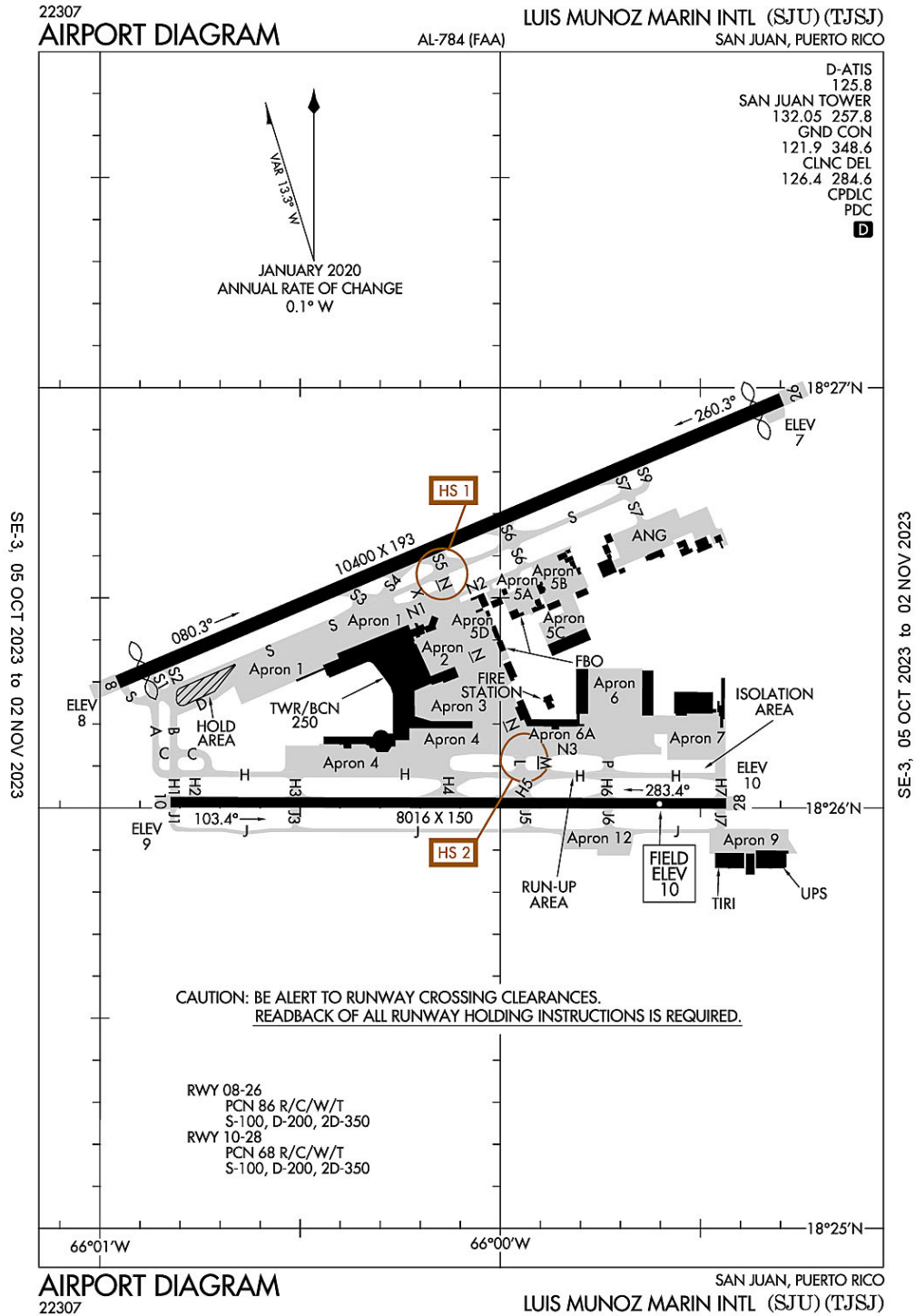
**General Remarks:**

FOR CD IF FREQ ARE OTS CTC SAN JUAN CERAP AT 787-253-8664/8667

ULTRALIGHT ACTIVITY.

BIRDS ON AND INVOF ARPT.

### San Juan, Puerto Rico Luis Munoz Marin International ICAO Identifier TJSJ



**San Juan, PR**  
**Luis Munoz Marin Intl**  
**ICAO Identifier TJSJ**

**AD 2.2 Aerodrome geographical and administrative data**

- 2.2.1 Reference Point: 18-26-21.837N / 66-0-7.68W
- 2.2.2 From City: 3 miles SE of SAN JUAN, PR
- 2.2.3 Elevation: 9.6 ft
- 2.2.5 Magnetic Variation: 11W (1985)
- 2.2.6 Airport Contact: MR. JORGE HERNANDEZ  
P. O. BOX 38085  
SAN JUAN, PR 937 ((787) 289-7240)
- 2.2.7 Traffic: IFR/VFR

**AD 2.3 Attendance Schedule**

- 2.3.1 All Months, All Days, All Hours

**AD 2.4 Handling Services and Facilities**

- 2.4.1 Cargo Handling Facilities: YES
- 2.4.2 Fuel Types: 100,A+,A++
- 2.4.5 Hangar Space: YES
- 2.4.6 Repair Facilities: MAJOR

**AD 2.6 Rescue and Firefighting Services**

- 2.6.1 Aerodrome Category: Class-I certified on 5/1/2005
- 2.6.2 Rescue and Firefighting Services: ARFF Index-D

**AD 2.12 Runway Physical Characteristics**

- 2.12.1 Designation: 08
- 2.12.2 True Bearing: 67
- 2.12.3 Dimensions: 10400 ft x 193 ft
- 2.12.4 PCN: 86 R/C/W/T
- 2.12.5 Coordinates: 18-26-17.9673N / 66-0-57.3115W
- 2.12.6 Threshold Elevation: 8.2 ft
- 2.12.6 Touchdown Zone Elevation: 9.3 ft
  
- 2.12.1 Designation: 26
- 2.12.2 True Bearing: 247
- 2.12.3 Dimensions: 10400 ft x 193 ft
- 2.12.4 PCN: 86 R/C/W/T
- 2.12.5 Coordinates: 18-26-58.2684N / 65-59-17.8783W
- 2.12.6 Threshold Elevation: 6.9 ft
- 2.12.6 Touchdown Zone Elevation: 7.4 ft
  
- 2.12.1 Designation: 10

2.12.2 True Bearing: 90  
2.12.3 Dimensions: 8016 ft x 150 ft  
2.12.4 PCN: 68 R/C/W/T  
2.12.5 Coordinates: 18-26-0.8092N / 66-0-49.4179W  
2.12.6 Threshold Elevation: 9.3 ft  
2.12.6 Touchdown Zone Elevation: 9.3 ft

2.12.1 Designation: 28  
2.12.2 True Bearing: 270  
2.12.3 Dimensions: 8016 ft x 150 ft  
2.12.4 PCN: 68 R/C/W/T  
2.12.5 Coordinates: 18-26-0.6107N / 65-59-26.159W  
2.12.6 Threshold Elevation: 9.5 ft  
2.12.6 Touchdown Zone Elevation: 9.6 ft

### **AD 2.13 Declared Distances**

2.13.1 Designation: 08  
2.13.2 Take-off Run Available: 10400  
2.13.3 Take-off Distance Available: 10400  
2.13.4 Accelerate-Stop Distance Available: 9784  
2.13.5 Landing Distance Available: 9384

2.13.1 Designation: 26  
2.13.2 Take-off Run Available: 10400  
2.13.3 Take-off Distance Available: 10400  
2.13.4 Accelerate-Stop Distance Available: 10308  
2.13.5 Landing Distance Available: 9908

2.13.1 Designation: 10  
2.13.2 Take-off Run Available: 8016  
2.13.3 Take-off Distance Available: 8016  
2.13.4 Accelerate-Stop Distance Available: 8016  
2.13.5 Landing Distance Available: 8016

2.13.1 Designation: 28  
2.13.2 Take-off Run Available: 8016  
2.13.3 Take-off Distance Available: 8016  
2.13.4 Accelerate-Stop Distance Available: 8016  
2.13.5 Landing Distance Available: 8016

### **AD 2.14 Approach and Runway Lighting**

2.14.1 Designation: 08

2.14.2 Approach Lighting System: MALSR  
2.14.4 Visual Approach Slope Indicator System: P4L

2.14.1 Designation: 26  
2.14.2 Approach Lighting System:  
2.14.4 Visual Approach Slope Indicator System:

2.14.1 Designation: 10  
2.14.2 Approach Lighting System: MALSR  
2.14.4 Visual Approach Slope Indicator System: P4L

2.14.1 Designation: 28  
2.14.2 Approach Lighting System:  
2.14.4 Visual Approach Slope Indicator System: P4L

**AD 2.18 Air Traffic Services Communication Facilities**

2.18.1 Service Designation: APCH/P DEP/P (WEST & SW)  
2.18.3 Channel: 119.4  
2.18.5 Hours of Operation: 24

2.18.1 Service Designation: APCH/P DEP/P (NORTH & EAST)  
2.18.3 Channel: 120.9  
2.18.5 Hours of Operation: 24

2.18.1 Service Designation: APCH/P DEP/P (WEST & SW)  
2.18.3 Channel: 269.2  
2.18.5 Hours of Operation: 24

2.18.1 Service Designation: APCH/P DEP/P (NORTH & EAST)  
2.18.3 Channel: 290.2  
2.18.5 Hours of Operation: 24

2.18.1 Service Designation: CD PRE TAXI CLNC  
2.18.3 Channel: 126.4  
2.18.5 Hours of Operation: 24

2.18.1 Service Designation: CD/P  
2.18.3 Channel: 284.6  
2.18.5 Hours of Operation: 24

2.18.1 Service Designation: CLASS C (WEST & SW)  
2.18.3 Channel: 119.4  
2.18.5 Hours of Operation: 24

2.18.1 Service Designation: CLASS C (NORTH & EAST)

2.18.3 Channel: 120.9

2.18.5 Hours of Operation: 24

2.18.1 Service Designation: CLASS C (WEST & SW)

2.18.3 Channel: 269.2

2.18.5 Hours of Operation: 24

2.18.1 Service Designation: CLASS C (NORTH & EAST)

2.18.3 Channel: 290.2

2.18.5 Hours of Operation: 24

2.18.1 Service Designation: COMD POST (PRANG COMD POST)

2.18.3 Channel: 235

2.18.5 Hours of Operation:

2.18.1 Service Designation: D-ATIS

2.18.3 Channel: 125.8

2.18.5 Hours of Operation: 24

2.18.1 Service Designation: EMERG

2.18.3 Channel: 121.5

2.18.5 Hours of Operation:

2.18.1 Service Designation: GND/P

2.18.3 Channel: 121.9

2.18.5 Hours of Operation: 24

2.18.1 Service Designation: GND/P

2.18.3 Channel: 348.6

2.18.5 Hours of Operation: 24

2.18.1 Service Designation: LCL/P

2.18.3 Channel: 132.05

2.18.5 Hours of Operation: 24

2.18.1 Service Designation: LCL/P

2.18.3 Channel: 257.8

2.18.5 Hours of Operation: 24

### **AD 2.19 Radio Navigation and Landing Aids**

2.19.1 ILS Type: Glide Slope for runway 08. Magnetic variation: 11W

2.19.2 ILS Identification: SJU  
2.19.5 Coordinates: 18-26-27.0397N / 66-0-45.5699W  
2.19.6 Site Elevation: 4.2 ft

2.19.1 ILS Type: Localizer for runway 08. Magnetic variation: 11W  
2.19.2 ILS Identification: SJU  
2.19.5 Coordinates: 18-26-59.7947N / 65-59-14.1228W  
2.19.6 Site Elevation: 5.6 ft

2.19.1 ILS Type: Outer Marker for runway 08. Magnetic variation: 11W  
2.19.2 ILS Identification: SJU  
2.19.5 Coordinates: 18-24-31.8227N / 66-5-21.8301W  
2.19.6 Site Elevation: 66.5 ft

2.19.1 ILS Type: DME for runway 10. Magnetic variation: 11W  
2.19.2 ILS Identification: CLA  
2.19.5 Coordinates: 18-26-2.5352N / 65-59-15.6282W  
2.19.6 Site Elevation: 18.2 ft

2.19.1 ILS Type: Glide Slope for runway 10. Magnetic variation: 11W  
2.19.2 ILS Identification: CLA  
2.19.5 Coordinates: 18-25-57.5628N / 66-0-39.041W  
2.19.6 Site Elevation: 4.5 ft

2.19.1 ILS Type: Localizer for runway 10. Magnetic variation: 11W  
2.19.2 ILS Identification: CLA  
2.19.5 Coordinates: 18-26-0.5899N / 65-59-15.5192W  
2.19.6 Site Elevation: 9 ft

2.19.1 Navigation Aid Type: VORTAC. Magnetic variation: 11W  
2.19.2 Navigation Aid Identification: SJU  
2.19.5 Coordinates: 18-26-46.6101N / 65-59-22.2272W  
2.19.6 Site Elevation: 5.7 ft

**General Remarks:**

TWY J BTN J1 AND J5 (NOT INCLUDING J5) CLSD TO ACFT WITH GREATER THAN 118 FT WINGSPAN.

ACFT 180 TURNS ON TWYS REQUIRES OPS COORDINATIONS.

FBO/GROUND HANDLER MUST SUBMIT 72 HRS PPR FOR ALL MIL ACFT TO: CCO@AEROSTARAIRPORTS.-COM OR BY PHONE TO: 787-253-0979

MILITARY: ANG: INBD ACFT ORIGINATING FR OCONUS WITH A PPR FOR MUNIZ ANGB APN MUST CLEAR CUSTOMS AND BORDER PROTECTION AT CIV SIDE. PRIOR COORD MUST BE MADE WITH ANG AMOPS, FONE 740-9629 AT LEAST ONE BUS DAY PRIOR TO ARRIVAL.

ALL PVT AND CORPORATE AIRCRAFT MUST CONTACT ARPT OPS, BEFORE ARRIVAL, FOR FBOS &

GROUND HANDLING INFO AT 787-253-0979.

ENGINE RUNUPS PROHIBITED ON GATES AREA.

APRON 12 AVBL FOR GA ACFT ONLY.

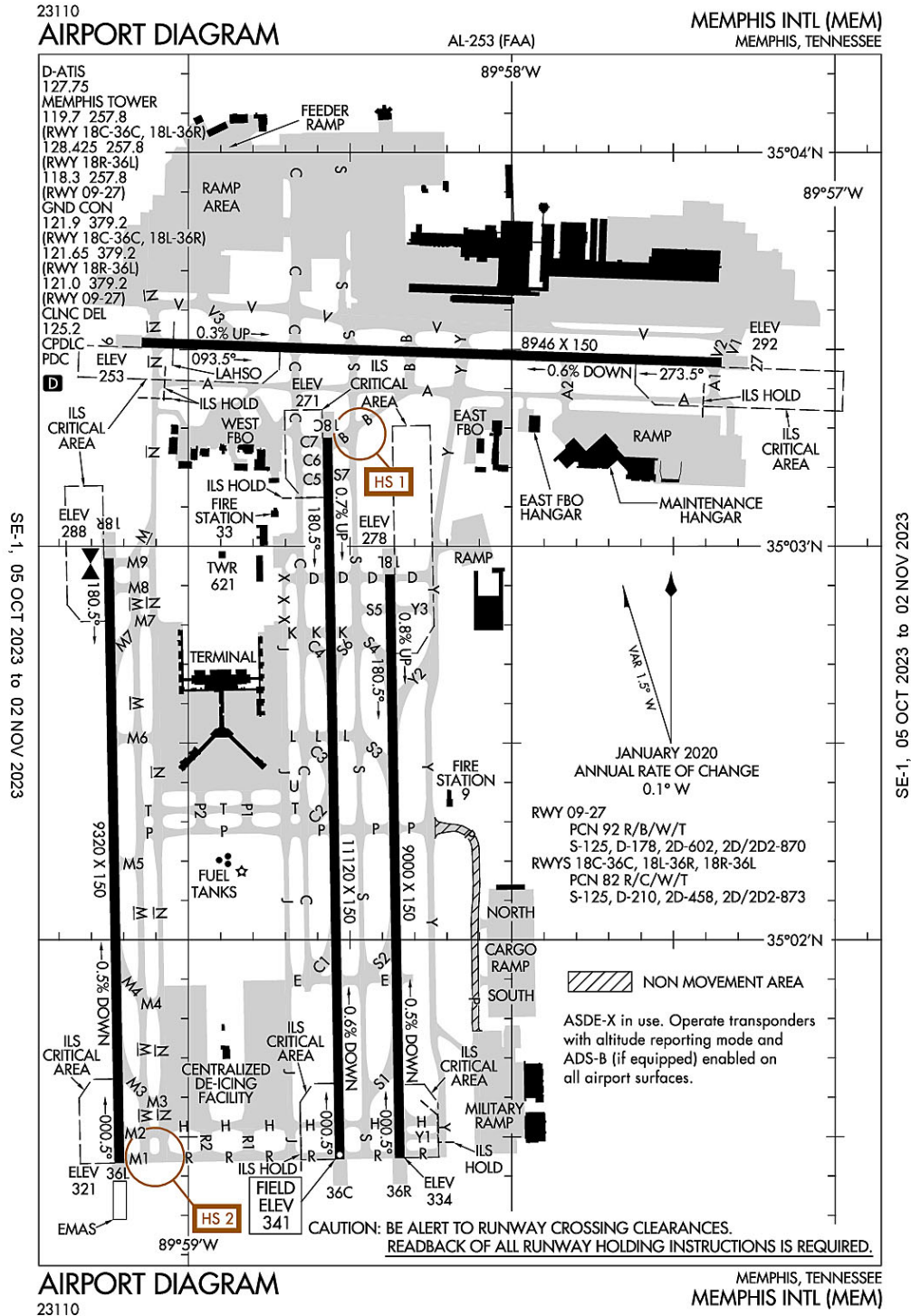
TWY H BTN TWY C AND TWY H3 CLSD. PLEASE, CONTACT ARPT OPS AT 787-253-0979 FOR FURTHER DETAILS AND RESTRICTIONS.

BASE OPS 1130-2000Z MON-FRI, CLSD WKEND AND HOL.

TWY S BTN TWY S2 AND TWY S5 CLSD LGTD AND BARRICADED.



Memphis, Tennessee  
Memphis International  
ICAO Identifier KMEM



**Memphis, TN**  
**Memphis Intl**  
**ICAO Identifier KMEM**

**AD 2.2 Aerodrome geographical and administrative data**

- 2.2.1 Reference Point: 35-2-32.681N / 89-58-36.045W
- 2.2.2 From City: 3 miles S of MEMPHIS, TN
- 2.2.3 Elevation: 340.9 ft
- 2.2.5 Magnetic Variation: 1W (2020)
- 2.2.6 Airport Contact: SCOTT A BROCKMAN  
2491 WINCHESTER RD.  
MEMPHIS, TN 38116 (901-922-8000)
- 2.2.7 Traffic: IFR/VFR

**AD 2.3 Attendance Schedule**

- 2.3.1 All Months, All Days, All Hours

**AD 2.4 Handling Services and Facilities**

- 2.4.1 Cargo Handling Facilities: YES
- 2.4.2 Fuel Types: 100LL,A,A+,A++
- 2.4.5 Hangar Space: YES
- 2.4.6 Repair Facilities: MAJOR

**AD 2.6 Rescue and Firefighting Services**

- 2.6.1 Aerodrome Category: Class-I certified on 5/21/1973
- 2.6.2 Rescue and Firefighting Services: ARFF Index-C

**AD 2.12 Runway Physical Characteristics**

- 2.12.1 Designation: 09
- 2.12.2 True Bearing: 92
- 2.12.3 Dimensions: 8946 ft x 150 ft
- 2.12.4 PCN: 92 R/B/W/T
- 2.12.5 Coordinates: 35-3-31.046N / 89-59-8.6536W
- 2.12.6 Threshold Elevation: 253.2 ft
- 2.12.6 Touchdown Zone Elevation: 258.7 ft
  
- 2.12.1 Designation: 27
- 2.12.2 True Bearing: 272
- 2.12.3 Dimensions: 8946 ft x 150 ft
- 2.12.4 PCN: 92 R/B/W/T
- 2.12.5 Coordinates: 35-3-28.0128N / 89-57-21.0816W
- 2.12.6 Threshold Elevation: 292 ft
- 2.12.6 Touchdown Zone Elevation: 292 ft
  
- 2.12.1 Designation: 18C
- 2.12.2 True Bearing: 179
- 2.12.3 Dimensions: 11120 ft x 150 ft
- 2.12.4 PCN: 82 R/C/W/T
- 2.12.5 Coordinates: 35-3-16.5411N / 89-58-34.2156W
- 2.12.6 Threshold Elevation: 270.6 ft
- 2.12.6 Touchdown Zone Elevation: 290.1 ft

2.12.1 Designation: 36C  
2.12.2 True Bearing: 359  
2.12.3 Dimensions: 11120 ft x 150 ft  
2.12.4 PCN: 82 R/C/W/T  
2.12.5 Coordinates: 35-1-26.5803N / 89-58-31.8977W  
2.12.6 Threshold Elevation: 340.9 ft  
2.12.6 Touchdown Zone Elevation: 340.9 ft

2.12.1 Designation: 36R  
2.12.2 True Bearing: 359  
2.12.3 Dimensions: 9000 ft x 150 ft  
2.12.4 PCN: 82 R/C/W/T  
2.12.5 Coordinates: 35-1-26.7376N / 89-58-20.7544W  
2.12.6 Threshold Elevation: 334.3 ft  
2.12.6 Touchdown Zone Elevation: 334.7 ft

2.12.1 Designation: 18L  
2.12.2 True Bearing: 179  
2.12.3 Dimensions: 9000 ft x 150 ft  
2.12.4 PCN: 82 R/C/W/T  
2.12.5 Coordinates: 35-2-55.7402N / 89-58-22.6229W  
2.12.6 Threshold Elevation: 277.6 ft  
2.12.6 Touchdown Zone Elevation: 300.9 ft

2.12.1 Designation: 18R  
2.12.2 True Bearing: 179  
2.12.3 Dimensions: 9320 ft x 150 ft  
2.12.4 PCN: 82 R/C/W/T  
2.12.5 Coordinates: 35-2-58.1489N / 89-59-14.7913W  
2.12.6 Threshold Elevation: 288.4 ft  
2.12.6 Touchdown Zone Elevation: 294.7 ft

2.12.1 Designation: 36L  
2.12.2 True Bearing: 359  
2.12.3 Dimensions: 9320 ft x 150 ft  
2.12.4 PCN: 82 R/C/W/T  
2.12.5 Coordinates: 35-1-25.9852N / 89-59-12.8121W  
2.12.6 Threshold Elevation: 320.8 ft  
2.12.6 Touchdown Zone Elevation: 320.8 ft

**AD 2.13 Declared Distances**

2.13.1 Designation: 09  
2.13.2 Take-off Run Available: 8946  
2.13.3 Take-off Distance Available: 8946  
2.13.4 Accelerate-Stop Distance Available: 8946  
2.13.5 Landing Distance Available: 8946

2.13.1 Designation: 27  
2.13.2 Take-off Run Available: 8946

2.13.3 Take-off Distance Available: 8946  
2.13.4 Accelerate-Stop Distance Available: 8946  
2.13.5 Landing Distance Available: 8946

2.13.1 Designation: 18C  
2.13.2 Take-off Run Available: 11120  
2.13.3 Take-off Distance Available: 11120  
2.13.4 Accelerate-Stop Distance Available: 11120  
2.13.5 Landing Distance Available: 11120

2.13.1 Designation: 36C  
2.13.2 Take-off Run Available: 11120  
2.13.3 Take-off Distance Available: 11120  
2.13.4 Accelerate-Stop Distance Available: 10715  
2.13.5 Landing Distance Available: 10715

2.13.1 Designation: 36R  
2.13.2 Take-off Run Available: 9000  
2.13.3 Take-off Distance Available: 9000  
2.13.4 Accelerate-Stop Distance Available: 9000  
2.13.5 Landing Distance Available: 9000

2.13.1 Designation: 18L  
2.13.2 Take-off Run Available: 9000  
2.13.3 Take-off Distance Available: 9000  
2.13.4 Accelerate-Stop Distance Available: 9000  
2.13.5 Landing Distance Available: 9000

2.13.1 Designation: 18R  
2.13.2 Take-off Run Available: 9320  
2.13.3 Take-off Distance Available: 9320  
2.13.4 Accelerate-Stop Distance Available: 9320  
2.13.5 Landing Distance Available: 9320

2.13.1 Designation: 36L  
2.13.2 Take-off Run Available: 9320  
2.13.3 Take-off Distance Available: 9320  
2.13.4 Accelerate-Stop Distance Available: 9320  
2.13.5 Landing Distance Available: 9320

#### **AD 2.14 Approach and Runway Lighting**

2.14.1 Designation: 09  
2.14.2 Approach Lighting System: MALSR  
2.14.4 Visual Approach Slope Indicator System:

2.14.1 Designation: 27  
2.14.2 Approach Lighting System: MALSR  
2.14.4 Visual Approach Slope Indicator System: P4L

2.14.1 Designation: 18C

2.14.2 Approach Lighting System: MALSR  
2.14.4 Visual Approach Slope Indicator System:

2.14.1 Designation: 36C  
2.14.2 Approach Lighting System: ALSF2  
2.14.4 Visual Approach Slope Indicator System: P4L

2.14.1 Designation: 36R  
2.14.2 Approach Lighting System: ALSF2  
2.14.4 Visual Approach Slope Indicator System: P4R

2.14.1 Designation: 18L  
2.14.2 Approach Lighting System: MALSR  
2.14.4 Visual Approach Slope Indicator System: P4L

2.14.1 Designation: 18R  
2.14.2 Approach Lighting System: MALSR  
2.14.4 Visual Approach Slope Indicator System:

2.14.1 Designation: 36L  
2.14.2 Approach Lighting System: ALSF2  
2.14.4 Visual Approach Slope Indicator System: P4L

**AD 2.18 Air Traffic Services Communication Facilities**

2.18.1 Service Designation: ANG COMD POST  
2.18.3 Channel: 138.1  
2.18.5 Hours of Operation:

2.18.1 Service Designation: ANG COMD POST  
2.18.3 Channel: 353.45  
2.18.5 Hours of Operation:

2.18.1 Service Designation: CD PRE TAXI CLNC  
2.18.3 Channel: 125.2  
2.18.5 Hours of Operation: 24

2.18.1 Service Designation: D-ATIS  
2.18.3 Channel: 127.75  
2.18.5 Hours of Operation: 24

2.18.1 Service Designation: EMERG  
2.18.3 Channel: 121.5  
2.18.5 Hours of Operation:

2.18.1 Service Designation: EMERG  
2.18.3 Channel: 243  
2.18.5 Hours of Operation:

2.18.1 Service Designation: GND/P (RWY 09/27)  
2.18.3 Channel: 121

2.18.5 Hours of Operation: 24

2.18.1 Service Designation: GND/P (RWY 18R/36L)

2.18.3 Channel: 121.65

2.18.5 Hours of Operation: 24

2.18.1 Service Designation: GND/P (RWY 18L/36R, 18C/36C)

2.18.3 Channel: 121.9

2.18.5 Hours of Operation: 24

2.18.1 Service Designation: GND/P

2.18.3 Channel: 379.2

2.18.5 Hours of Operation: 24

2.18.1 Service Designation: LCL/P (RWY 09/27)

2.18.3 Channel: 118.3

2.18.5 Hours of Operation: 24

2.18.1 Service Designation: LCL/P (RWY 18L/36R, 18C/36C)

2.18.3 Channel: 119.7

2.18.5 Hours of Operation: 24

2.18.1 Service Designation: LCL/P (RWY 18R/36L)

2.18.3 Channel: 128.425

2.18.5 Hours of Operation: 24

2.18.1 Service Designation: LCL/P

2.18.3 Channel: 257.8

2.18.5 Hours of Operation: 24

### **AD 2.19 Radio Navigation and Landing Aids**

2.19.1 ILS Type: Glide Slope for runway 09. Magnetic variation: 1W

2.19.2 ILS Identification: MEM

2.19.5 Coordinates: 35-3-27.2174N / 89-58-56.2128W

2.19.6 Site Elevation: 252.5 ft

2.19.1 ILS Type: Localizer for runway 09. Magnetic variation: 1W

2.19.2 ILS Identification: MEM

2.19.5 Coordinates: 35-3-27.6511N / 89-57-7.9461W

2.19.6 Site Elevation: 296.5 ft

2.19.1 ILS Type: Glide Slope for runway 27. Magnetic variation: 1W

2.19.2 ILS Identification: JIM

2.19.5 Coordinates: 35-3-24.4908N / 89-57-36.2529W

2.19.6 Site Elevation: 277.2 ft

2.19.1 ILS Type: Localizer for runway 27. Magnetic variation: 1W

2.19.2 ILS Identification: JIM

2.19.5 Coordinates: 35-3-31.3982N / 89-59-20.811W

2.19.6 Site Elevation: 252.2 ft

2.19.1 ILS Type: Glide Slope for runway 18C. Magnetic variation: 1W  
2.19.2 ILS Identification: SDU  
2.19.5 Coordinates: 35-3-7.6024N / 89-58-37.5142W  
2.19.6 Site Elevation: 273.1 ft

2.19.1 ILS Type: Localizer for runway 18C. Magnetic variation: 1W  
2.19.2 ILS Identification: SDU  
2.19.5 Coordinates: 35-1-10.2462N / 89-58-31.5613W  
2.19.6 Site Elevation: 345.5 ft

2.19.1 ILS Type: DME for runway 36C. Magnetic variation: 1W  
2.19.2 ILS Identification: TSE  
2.19.5 Coordinates: 35-3-22.0479N / 89-58-37.3452W  
2.19.6 Site Elevation: 268.9 ft

2.19.1 ILS Type: Glide Slope for runway 36C. Magnetic variation: 1W  
2.19.2 ILS Identification: TSE  
2.19.5 Coordinates: 35-1-38.095N / 89-58-36.9423W  
2.19.6 Site Elevation: 329.5 ft

2.19.1 ILS Type: Localizer for runway 36C. Magnetic variation: 1W  
2.19.2 ILS Identification: TSE  
2.19.5 Coordinates: 35-3-22.514N / 89-58-34.3391W  
2.19.6 Site Elevation: 261.2 ft

2.19.1 ILS Type: DME for runway 18L. Magnetic variation: 1W  
2.19.2 ILS Identification: EXS  
2.19.5 Coordinates: 35-1-16.8761N / 89-58-19.3033W  
2.19.6 Site Elevation: 328.2 ft

2.19.1 ILS Type: Glide Slope for runway 18L. Magnetic variation: 1W  
2.19.2 ILS Identification: EXS  
2.19.5 Coordinates: 35-2-46.7849N / 89-58-17.6254W  
2.19.6 Site Elevation: 278.6 ft

2.19.1 ILS Type: Localizer for runway 18L. Magnetic variation: 1W  
2.19.2 ILS Identification: EXS  
2.19.5 Coordinates: 35-1-16.6952N / 89-58-20.5424W  
2.19.6 Site Elevation: 344.5 ft

2.19.1 ILS Type: DME for runway 36R. Magnetic variation: 1W  
2.19.2 ILS Identification: MYO  
2.19.5 Coordinates: 35-3-5.9229N / 89-58-19.6804W  
2.19.6 Site Elevation: 282.5 ft

2.19.1 ILS Type: Glide Slope for runway 36R. Magnetic variation: 1W  
2.19.2 ILS Identification: MYO  
2.19.5 Coordinates: 35-1-38.0016N / 89-58-16.1795W  
2.19.6 Site Elevation: 324.2 ft

2.19.1 ILS Type: Localizer for runway 36R. Magnetic variation: 1W  
2.19.2 ILS Identification: MYO  
2.19.5 Coordinates: 35-3-6.1649N / 89-58-22.8431W  
2.19.6 Site Elevation: 278.7 ft

2.19.1 ILS Type: Glide Slope for runway 18R. Magnetic variation: 1W  
2.19.2 ILS Identification: OOI  
2.19.5 Coordinates: 35-2-48.6497N / 89-59-18.4713W  
2.19.6 Site Elevation: 287.1 ft

2.19.1 ILS Type: Localizer for runway 18R. Magnetic variation: 1W  
2.19.2 ILS Identification: OOI  
2.19.5 Coordinates: 35-1-17.2969N / 89-59-12.6028W  
2.19.6 Site Elevation: 321.4 ft

2.19.1 ILS Type: DME for runway 36L. Magnetic variation: 1W  
2.19.2 ILS Identification: OHN  
2.19.5 Coordinates: 35-3-6.901N / 89-59-10.0928W  
2.19.6 Site Elevation: 285.7 ft

2.19.1 ILS Type: Glide Slope for runway 36L. Magnetic variation: 1W  
2.19.2 ILS Identification: OHN  
2.19.5 Coordinates: 35-1-38.7288N / 89-59-17.8741W  
2.19.6 Site Elevation: 308.9 ft

2.19.1 ILS Type: Localizer for runway 36L. Magnetic variation: 1W  
2.19.2 ILS Identification: OHN  
2.19.5 Coordinates: 35-3-8.5885N / 89-59-14.9936W  
2.19.6 Site Elevation: 277.6 ft

2.19.1 Navigation Aid Type: VORTAC. Magnetic variation: 1E  
2.19.2 Navigation Aid Identification: MEM  
2.19.5 Coordinates: 35-0-54.3808N / 89-58-59.5258W  
2.19.6 Site Elevation: 363.4 ft

**General Remarks:**

ANG RAMP OFFL BUS ONLY; PPR - V966-8131. TSNT ACFT RQR FOLLOW ME ASSIST ENTERING ANG RAMP.

ANG: PPR 24 HR PN RQR; OFFL BUS ONLY.

HOLD SHORT INSTRN READ BACK RQR.

COMMUNICATIONS-ANG COMD POST: RADIO CALL GRACELAND OPS.

TWY N BTN TWY M & TWY M7 CLSD TO WINGSPAN MORE THAN 171.5 FT EXC TAX SPEED LESS THAN 15 MPH.

ANG-PPR DSN 726-7131/7505, C901-291-7131/7505. MIL RAMP OPS 1230-0430Z++ MON-FRI; CLSD ALTN MON & HOL. MIL RAMP CLSD OUTSIDE OF PUB HR WITHOUT OG/CC APVL DSN 726-7557, C901-291-7557. TSNT ACFT MAINT NOT AVBL. REFUEL SVC FOR OTR THAN C17 ACFT RQR QUALIFIED CREW CHIEF OR CREWMEMBERS. NON-C17 ACFT SUPPORT PRVDD BY CONTRACT FBO ON FLD. SECURITY AVBL 24 HRS, DSN 726-7101, C901-291-7101. COMD POST DSN 726-7148/7311/7312, C901-291-7148/7311/7312. OPR 1230-0430Z++ MON-FRI, CLSD ALTN MON AND HOL DUE TO ALTN WORK SCHED. AFLD MGR DOES NOT



ISSUE OR STORE COMSEC FOR TRAN CRES. TMPRY STOR OF CLASSIFIED MATERIALS UP TO TOP SECRET AT COMD POST.

AIRCRAFT WITH WINGSPANS GREATER THAN 118 FEET RESTRICTED FROM TAXIING ON TWY J NORTH OF TWY U.

HELI OPS TO/FM TRML BLDG NA.

BASH PHASE II APR-MAY & AUG-OCT; CURRENT BIRD WATCH COND NOT ON ATIS.

NOISE ABATEMENT PROC IN EFCT. SUCCESSIVE AND/OR SIMUL DEP APVD ON RWY 36L-18R & RWY 36C-18C OR RWY 36L-18R & RWY 36R-18L WITH COURSE DVRGNC NO LATER THAN 2.27 NM FROM RWY END.

BIRDS INVOF ARPT.

MIL: MIL RAMP OPS AT REDUCED ARFF, DOWNGRADED TO YELLOW.

TWY V BTN TWY S & Y RSTR TO ACFT WITH TAIL HEIGHT 65 FT 10 IN OR LESS.

LRG & HVY EBND ACFT ON TWY V FOR RWY 27 HOLD SHORT AT MNM THRUST AREA SIGN.

ASDE-X IN USE. OPR PARROT WITH ALT RPRTG MODE & ADS-B ENABLED ON ARPT SFCS.

PPR FOR TAXI CLNC ON TWY N NORTH OF TWY V, TWY S NORTH TWY V & TWY C NORTH OF TWY V - FEDEX RAMP ATCT 131.5.

TWY N NORTH OF TWY V, TWY C NORTH OF TWY V, TWY S NORTH OF TWY V AND TWY V WEST OF TWY N DESIGNATED AS NON-MOVEMENT AREAS.

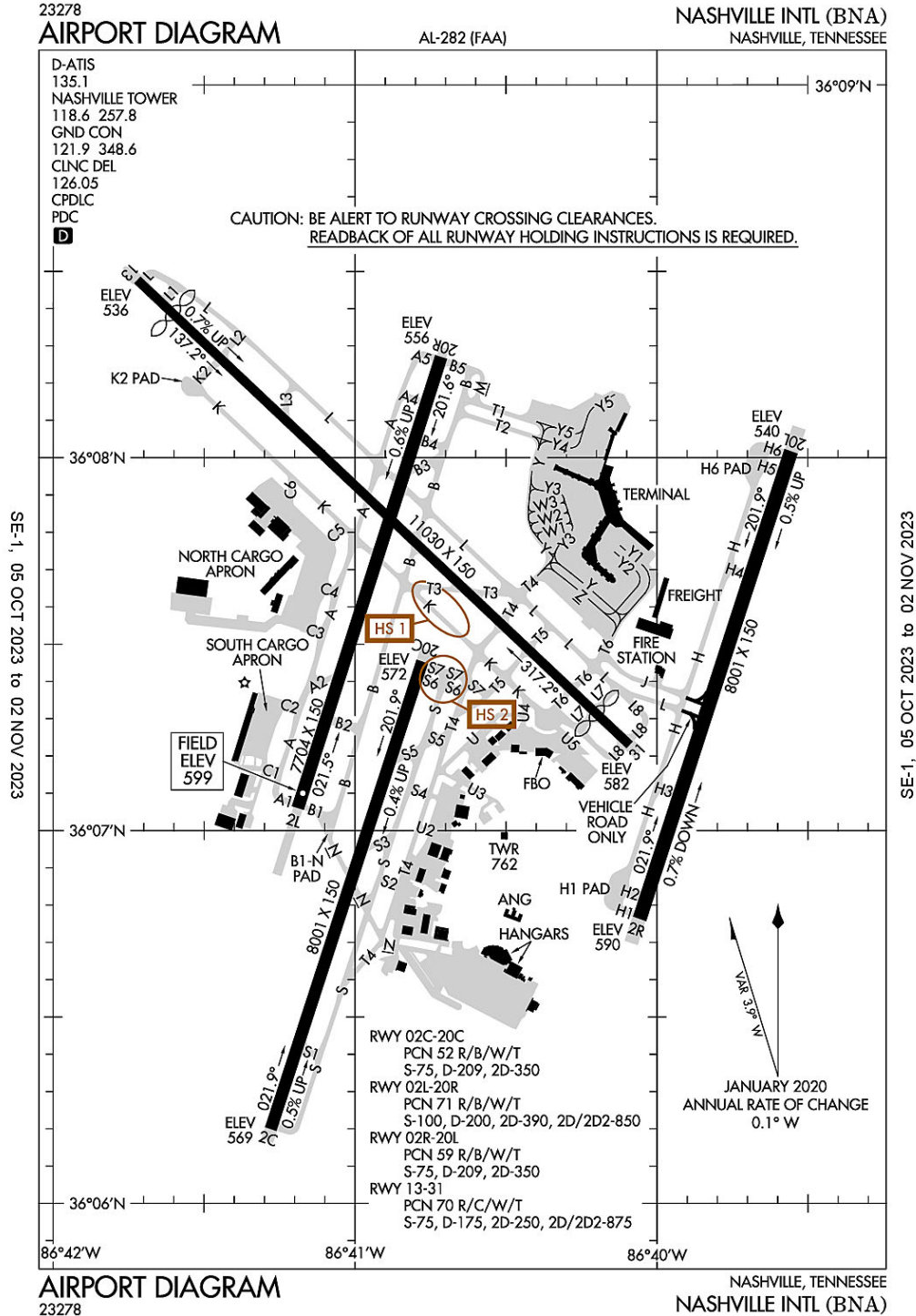
TWY V BTN SPOT 7W & RWY 27 RSTR TO ACFT WITH WINGSPAN OF 171 FT 6 IN OR LESS.

CTC RAMP CONTROL 121.8 FOR ENTRY ON ANG RAMP. ANG FREQS 138.95 353.45. AFT HR CTC COMMAND POST - DSN 726-7148; C901-291-7311/7312 OR SECURITY FORCES - DSN 726-7101; C901-291-7101/7133.

PPR FOR TAXI CLNC FM N & S CARGO RAMP PRKG - 121.9.

ANG-ATIS INFO RPRTS BIRD ACT H24.

### Nashville, Tennessee Nashville International ICAO Identifier KBNA



**Nashville, TN**  
**Nashville Intl**  
**ICAO Identifier KBNA**

**AD 2.2 Aerodrome geographical and administrative data**

- 2.2.1 Reference Point: 36-7-28.11N / 86-40-41.45W
- 2.2.2 From City: 5 miles SE of NASHVILLE, TN
- 2.2.3 Elevation: 599 ft
- 2.2.5 Magnetic Variation: 3W (2010)
- 2.2.6 Airport Contact: ROBERT RAMSEY  
140 BNA PARK DR. SUITE 520  
NASHVILLE, TN 37214 (615-275-1612)
- 2.2.7 Traffic: IFR/VFR

**AD 2.3 Attendance Schedule**

- 2.3.1 All Months, All Days, All Hours

**AD 2.4 Handling Services and Facilities**

- 2.4.1 Cargo Handling Facilities: YES
- 2.4.2 Fuel Types: 100LL,A
- 2.4.5 Hangar Space: YES
- 2.4.6 Repair Facilities: MAJOR

**AD 2.6 Rescue and Firefighting Services**

- 2.6.1 Aerodrome Category: Class-I certified on 5/1/1973
- 2.6.2 Rescue and Firefighting Services: ARFF Index-D

**AD 2.12 Runway Physical Characteristics**

- 2.12.1 Designation: 02C
- 2.12.2 True Bearing: 18
- 2.12.3 Dimensions: 8001 ft x 150 ft
- 2.12.4 PCN: 52 R/B/W/T
- 2.12.5 Coordinates: 36-6-11.9899N / 86-41-16.6591W
- 2.12.6 Threshold Elevation: 569.1 ft
- 2.12.6 Touchdown Zone Elevation: 586.7 ft

- 2.12.1 Designation: 20C
- 2.12.2 True Bearing: 198
- 2.12.3 Dimensions: 8001 ft x 150 ft
- 2.12.4 PCN: 52 R/B/W/T
- 2.12.5 Coordinates: 36-7-27.2406N / 86-40-46.55W
- 2.12.6 Threshold Elevation: 571.8 ft
- 2.12.6 Touchdown Zone Elevation: 587.7 ft

- 2.12.1 Designation: 02L
- 2.12.2 True Bearing: 18
- 2.12.3 Dimensions: 7704 ft x 150 ft
- 2.12.4 PCN: 71 R/B/W/T
- 2.12.5 Coordinates: 36-7-3.6342N / 86-41-11.3105W
- 2.12.6 Threshold Elevation: 598.7 ft
- 2.12.6 Touchdown Zone Elevation: 599 ft

2.12.1 Designation: 20R  
2.12.2 True Bearing: 198  
2.12.3 Dimensions: 7704 ft x 150 ft  
2.12.4 PCN: 71 R/B/W/T  
2.12.5 Coordinates: 36-8-16.2324N / 86-40-42.8335W  
2.12.6 Threshold Elevation: 555.6 ft  
2.12.6 Touchdown Zone Elevation: 578 ft

2.12.1 Designation: 02R  
2.12.2 True Bearing: 18  
2.12.3 Dimensions: 8001 ft x 150 ft  
2.12.4 PCN: 59 R/B/W/T  
2.12.5 Coordinates: 36-6-45.767N / 86-40-3.5138W  
2.12.6 Threshold Elevation: 589.8 ft  
2.12.6 Touchdown Zone Elevation: 589.8 ft

2.12.1 Designation: 20L  
2.12.2 True Bearing: 198  
2.12.3 Dimensions: 8001 ft x 150 ft  
2.12.4 PCN: 59 R/B/W/T  
2.12.5 Coordinates: 36-8-1.0116N / 86-39-33.3955W  
2.12.6 Threshold Elevation: 540 ft  
2.12.6 Touchdown Zone Elevation: 550.6 ft

2.12.1 Designation: 13  
2.12.2 True Bearing: 133  
2.12.3 Dimensions: 11030 ft x 150 ft  
2.12.4 PCN: 70 R/C/W/T  
2.12.5 Coordinates: 36-8-28.5991N / 86-41-43.2788W  
2.12.6 Threshold Elevation: 535.9 ft  
2.12.6 Touchdown Zone Elevation: 567.5 ft

2.12.1 Designation: 31  
2.12.2 True Bearing: 313  
2.12.3 Dimensions: 11030 ft x 150 ft  
2.12.4 PCN: 70 R/C/W/T  
2.12.5 Coordinates: 36-7-13.7852N / 86-40-5.4384W  
2.12.6 Threshold Elevation: 582.3 ft  
2.12.6 Touchdown Zone Elevation: 577.5 ft

#### **AD 2.13 Declared Distances**

2.13.1 Designation: 02C  
2.13.2 Take-off Run Available: 8001  
2.13.3 Take-off Distance Available: 8001  
2.13.4 Accelerate-Stop Distance Available: 7601  
2.13.5 Landing Distance Available: 7601

2.13.1 Designation: 20C  
2.13.2 Take-off Run Available: 8001

2.13.3 Take-off Distance Available: 8001  
2.13.4 Accelerate-Stop Distance Available: 8001  
2.13.5 Landing Distance Available: 8001

2.13.1 Designation: 02L  
2.13.2 Take-off Run Available: 7702  
2.13.3 Take-off Distance Available: 7702  
2.13.4 Accelerate-Stop Distance Available: 7702  
2.13.5 Landing Distance Available: 7702

2.13.1 Designation: 20R  
2.13.2 Take-off Run Available: 7702  
2.13.3 Take-off Distance Available: 7702  
2.13.4 Accelerate-Stop Distance Available: 7702  
2.13.5 Landing Distance Available: 7702

2.13.1 Designation: 02R  
2.13.2 Take-off Run Available: 8000  
2.13.3 Take-off Distance Available: 8000  
2.13.4 Accelerate-Stop Distance Available: 8000  
2.13.5 Landing Distance Available: 8000

2.13.1 Designation: 20L  
2.13.2 Take-off Run Available: 8000  
2.13.3 Take-off Distance Available: 8000  
2.13.4 Accelerate-Stop Distance Available: 8000  
2.13.5 Landing Distance Available: 8000

2.13.1 Designation: 13  
2.13.2 Take-off Run Available: 10288  
2.13.3 Take-off Distance Available: 11029  
2.13.4 Accelerate-Stop Distance Available: 10288  
2.13.5 Landing Distance Available: 9487

2.13.1 Designation: 31  
2.13.2 Take-off Run Available: 10228  
2.13.3 Take-off Distance Available: 11029  
2.13.4 Accelerate-Stop Distance Available: 10228  
2.13.5 Landing Distance Available: 9487

**AD 2.14 Approach and Runway Lighting**

2.14.1 Designation: 02C  
2.14.2 Approach Lighting System: MALSR  
2.14.4 Visual Approach Slope Indicator System:

2.14.1 Designation: 20C  
2.14.2 Approach Lighting System:  
2.14.4 Visual Approach Slope Indicator System: P4L

2.14.1 Designation: 02L

2.14.2 Approach Lighting System: ALSF2  
2.14.4 Visual Approach Slope Indicator System: P4R

2.14.1 Designation: 20R  
2.14.2 Approach Lighting System: MALSF  
2.14.4 Visual Approach Slope Indicator System: P4R

2.14.1 Designation: 02R  
2.14.2 Approach Lighting System: ALSF2  
2.14.4 Visual Approach Slope Indicator System:

2.14.1 Designation: 20L  
2.14.2 Approach Lighting System: MALSR  
2.14.4 Visual Approach Slope Indicator System:

2.14.1 Designation: 13  
2.14.2 Approach Lighting System:  
2.14.4 Visual Approach Slope Indicator System:

2.14.1 Designation: 31  
2.14.2 Approach Lighting System:  
2.14.4 Visual Approach Slope Indicator System: P4R

#### **AD 2.18 Air Traffic Services Communication Facilities**

2.18.1 Service Designation: ALCP  
2.18.3 Channel: 314.4  
2.18.5 Hours of Operation:

2.18.1 Service Designation: APCH/P (WEST)  
2.18.3 Channel: 372  
2.18.5 Hours of Operation: 24

2.18.1 Service Designation: APCH/P IC (EAST)  
2.18.3 Channel: 118.4  
2.18.5 Hours of Operation: 24

2.18.1 Service Designation: APCH/P IC (EAST)  
2.18.3 Channel: 360.7  
2.18.5 Hours of Operation: 24

2.18.1 Service Designation: CD PRE TAXI CLNC  
2.18.3 Channel: 126.05  
2.18.5 Hours of Operation: 24

2.18.1 Service Designation: CLASS C (EAST)  
2.18.3 Channel: 118.4  
2.18.5 Hours of Operation: 24

2.18.1 Service Designation: CLASS C (WEST)  
2.18.3 Channel: 119.35

2.18.5 Hours of Operation: 24

2.18.1 Service Designation: CLASS C (EAST)

2.18.3 Channel: 360.7

2.18.5 Hours of Operation: 24

2.18.1 Service Designation: CLASS C (WEST)

2.18.3 Channel: 372

2.18.5 Hours of Operation: 24

2.18.1 Service Designation: D-ATIS

2.18.3 Channel: 135.1

2.18.5 Hours of Operation: 24

2.18.1 Service Designation: DEP/P (EAST)

2.18.3 Channel: 118.4

2.18.5 Hours of Operation: 24

2.18.1 Service Designation: DEP/P (WEST)

2.18.3 Channel: 119.35

2.18.5 Hours of Operation: 24

2.18.1 Service Designation: DEP/P (EAST)

2.18.3 Channel: 360.7

2.18.5 Hours of Operation: 24

2.18.1 Service Designation: DEP/P (WEST)

2.18.3 Channel: 372

2.18.5 Hours of Operation: 24

2.18.1 Service Designation: EMERG

2.18.3 Channel: 121.5

2.18.5 Hours of Operation:

2.18.1 Service Designation: EMERG

2.18.3 Channel: 243

2.18.5 Hours of Operation:

2.18.1 Service Designation: GND/P

2.18.3 Channel: 121.9

2.18.5 Hours of Operation: 24

2.18.1 Service Designation: GND/P

2.18.3 Channel: 348.6

2.18.5 Hours of Operation: 24

2.18.1 Service Designation: LCL/P

2.18.3 Channel: 118.6

2.18.5 Hours of Operation: 24

2.18.1 Service Designation: LCL/P

2.18.3 Channel: 257.8  
2.18.5 Hours of Operation: 24

**AD 2.19 Radio Navigation and Landing Aids**

2.19.1 ILS Type: Glide Slope for runway 02C. Magnetic variation: 3W

2.19.2 ILS Identification: EZN

2.19.5 Coordinates: 36-6-22.6382N / 86-41-16.8861W

2.19.6 Site Elevation: 570.5 ft

2.19.1 ILS Type: Localizer for runway 02C. Magnetic variation: 3W

2.19.2 ILS Identification: EZN

2.19.5 Coordinates: 36-7-32.9571N / 86-40-44.2611W

2.19.6 Site Elevation: 574.3 ft

2.19.1 ILS Type: DME for runway 02L. Magnetic variation: 3W

2.19.2 ILS Identification: BNA

2.19.5 Coordinates: 36-8-26.4864N / 86-40-42.3692W

2.19.6 Site Elevation: 554 ft

2.19.1 ILS Type: Glide Slope for runway 02L. Magnetic variation: 3W

2.19.2 ILS Identification: BNA

2.19.5 Coordinates: 36-7-12.9535N / 86-41-2.539W

2.19.6 Site Elevation: 589.7 ft

2.19.1 ILS Type: Inner Marker for runway 02L. Magnetic variation: 3W

2.19.2 ILS Identification: BNA

2.19.5 Coordinates: 36-6-54.829N / 86-41-14.7612W

2.19.6 Site Elevation: 594.5 ft

2.19.1 ILS Type: Localizer for runway 02L. Magnetic variation: 3W

2.19.2 ILS Identification: BNA

2.19.5 Coordinates: 36-8-25.7779N / 86-40-39.0927W

2.19.6 Site Elevation: 545.4 ft

2.19.1 ILS Type: Glide Slope for runway 20R. Magnetic variation: 3W

2.19.2 ILS Identification: VIY

2.19.5 Coordinates: 36-8-5.8196N / 86-40-42.7621W

2.19.6 Site Elevation: 554.9 ft

2.19.1 ILS Type: Localizer for runway 20R. Magnetic variation: 3W

2.19.2 ILS Identification: VIY

2.19.5 Coordinates: 36-6-49.6756N / 86-41-16.7814W

2.19.6 Site Elevation: 598.1 ft

2.19.1 ILS Type: DME for runway 02R. Magnetic variation: 3W

2.19.2 ILS Identification: UQU

2.19.5 Coordinates: 36-8-9.8916N / 86-39-35.7867W

2.19.6 Site Elevation: 537.1 ft

2.19.1 ILS Type: Glide Slope for runway 02R. Magnetic variation: 3W



2.19.2 ILS Identification: UQU  
2.19.5 Coordinates: 36-6-56.0152N / 86-39-54.7364W  
2.19.6 Site Elevation: 576.7 ft

2.19.1 ILS Type: Inner Marker for runway 02R. Magnetic variation: 3W  
2.19.2 ILS Identification: UQU  
2.19.5 Coordinates: 36-6-37.6961N / 86-40-6.7484W  
2.19.6 Site Elevation: 569 ft

2.19.1 ILS Type: Localizer for runway 02R. Magnetic variation: 3W  
2.19.2 ILS Identification: UQU  
2.19.5 Coordinates: 36-8-10.5404N / 86-39-29.5803W  
2.19.6 Site Elevation: 531 ft

2.19.1 ILS Type: DME for runway 20L. Magnetic variation: 3W  
2.19.2 ILS Identification: SSX  
2.19.5 Coordinates: 36-6-30.9674N / 86-40-12.8854W  
2.19.6 Site Elevation: 622.2 ft

2.19.1 ILS Type: Glide Slope for runway 20L. Magnetic variation: 3W  
2.19.2 ILS Identification: SSX  
2.19.5 Coordinates: 36-7-50.0286N / 86-39-33.1134W  
2.19.6 Site Elevation: 534.5 ft

2.19.1 ILS Type: Localizer for runway 20L. Magnetic variation: 3W  
2.19.2 ILS Identification: SSX  
2.19.5 Coordinates: 36-6-30.0253N / 86-40-9.8136W  
2.19.6 Site Elevation: 613.4 ft

2.19.1 ILS Type: Glide Slope for runway 31. Magnetic variation: 3W  
2.19.2 ILS Identification: PNO  
2.19.5 Coordinates: 36-7-28.2722N / 86-40-18.5978W  
2.19.6 Site Elevation: 566.4 ft

2.19.1 ILS Type: Localizer for runway 31. Magnetic variation: 3W  
2.19.2 ILS Identification: PNO  
2.19.5 Coordinates: 36-8-30.6518N / 86-41-45.9626W  
2.19.6 Site Elevation: 539.6 ft

2.19.1 Navigation Aid Type: VORTAC. Magnetic variation: 2W  
2.19.2 Navigation Aid Identification: BNA  
2.19.5 Coordinates: 36-8-13.0573N / 86-41-5.1762W  
2.19.6 Site Elevation: 566.4 ft

**General Remarks:**

TBJT RWY NOISE ABATEMENT PROC; MIL TBJT USE RWY 13/31 FOR ARR & DEP.

MIL & ACFT MORE THAN 12500 LB PRAC APCH NA; PRAC APCH BTW 2300-0700 NA.

TRML RAMP & NON-MOVMT AREA UNCTLD; BFR USE - 122.95

PPR GA & CARGO TO PROCD TO AIRLINE TRML GATE FOR DE-ICE - ARPT OPS.

DO NOT CONFUSE TWY S FOR RWY 20C.

BIRD ACT ON & INVOF ARPT.

CTN: READ BACK & COMPLIANCE OF RWY HLDG INSTRN RQR; SPCLY TWY K & RWY 20C, TWY L AT RWY 13 & TWY H AT RWY 31.

C CONCOURSE; INNER TXL OUBD TFC; OUTER TXL INBD TFC.

TRML APRON TAX BTN ACR PUSHBACK OPS & GATES NA.

ANG: PPR – MUSIC CITY OPS 615-367-5579.

180 DEG TURNS OVR 12500 LBS NA ON ASPH SFC.

FLT NOTIFICATION SVC (ADCUS) AVBL.

PAVEMENT ON WEST SIDE OF RUNWAY 2R-20L BETWEEN TAXIWAY H3 AND TAXIWAY H4 IS MARKED AS A VEHICLE ACCESS ROAD ONLY

FLT OVR MAIN TRML NA.

ADHERE TO TWY & TXL CNTRLN WI TRML APRON.

WINGSPAN GREATER THAN 214 FT 96 HR PPR – AMGR.



**Dallas-Fort Worth, TX**  
**Dallas/Fort Worth Intl**  
**ICAO Identifier KDFW**

**AD 2.2 Aerodrome geographical and administrative data**

- 2.2.1 Reference Point: 32-53-50.039N / 97-2-15.701W
- 2.2.2 From City: 12 miles NW of DALLAS-FORT WORTH, TX
- 2.2.3 Elevation: 606.4 ft
- 2.2.5 Magnetic Variation: 4E (2015)
- 2.2.6 Airport Contact: SEAN DONOHUE  
PO BOX 619428  
DALLAS-FT WORTH, TX 75261 (972-973-3112)
- 2.2.7 Traffic: IFR/VFR

**AD 2.3 Attendance Schedule**

- 2.3.1 All Months, All Days, All Hours

**AD 2.4 Handling Services and Facilities**

- 2.4.1 Cargo Handling Facilities: YES
- 2.4.2 Fuel Types: 100LL,A
- 2.4.5 Hangar Space:
- 2.4.6 Repair Facilities: None

**AD 2.6 Rescue and Firefighting Services**

- 2.6.1 Aerodrome Category: Class-I certified on 7/1/1973
- 2.6.2 Rescue and Firefighting Services: ARFF Index-E

**AD 2.12 Runway Physical Characteristics**

- 2.12.1 Designation: 31R
- 2.12.2 True Bearing: 315
- 2.12.3 Dimensions: 9000 ft x 200 ft
- 2.12.4 PCN: 95 R/B/W/T
- 2.12.5 Coordinates: 32-53-41.932N / 97-0-3.0376W
- 2.12.6 Threshold Elevation: 508.4 ft
- 2.12.6 Touchdown Zone Elevation: 523.4 ft
  
- 2.12.1 Designation: 13L
- 2.12.2 True Bearing: 135
- 2.12.3 Dimensions: 9000 ft x 200 ft
- 2.12.4 PCN: 95 R/B/W/T
- 2.12.5 Coordinates: 32-54-45.197N / 97-1-17.3221W
- 2.12.6 Threshold Elevation: 553.1 ft
- 2.12.6 Touchdown Zone Elevation: 550 ft
  
- 2.12.1 Designation: 13R

2.12.2 True Bearing: 139  
2.12.3 Dimensions: 9300 ft x 150 ft  
2.12.4 PCN: 76 R/B/W/T  
2.12.5 Coordinates: 32-54-34.4723N / 97-4-59.276W  
2.12.6 Threshold Elevation: 591 ft  
2.12.6 Touchdown Zone Elevation: 591 ft

2.12.1 Designation: 31L  
2.12.2 True Bearing: 319  
2.12.3 Dimensions: 9300 ft x 150 ft  
2.12.4 PCN: 76 R/B/W/T  
2.12.5 Coordinates: 32-53-24.9716N / 97-3-47.7953W  
2.12.6 Threshold Elevation: 577.2 ft  
2.12.6 Touchdown Zone Elevation: 581.4 ft

2.12.1 Designation: 17C  
2.12.2 True Bearing: 180  
2.12.3 Dimensions: 13400 ft x 150 ft  
2.12.4 PCN: 93 R/B/W/T  
2.12.5 Coordinates: 32-54-56.5441N / 97-1-33.5097W  
2.12.6 Threshold Elevation: 562.2 ft  
2.12.6 Touchdown Zone Elevation: 563.2 ft

2.12.1 Designation: 35C  
2.12.2 True Bearing: 0  
2.12.3 Dimensions: 13400 ft x 150 ft  
2.12.4 PCN: 93 R/B/W/T  
2.12.5 Coordinates: 32-52-43.9636N / 97-1-34.218W  
2.12.6 Threshold Elevation: 563.1 ft  
2.12.6 Touchdown Zone Elevation: 563.2 ft

2.12.1 Designation: 35R  
2.12.2 True Bearing: 0  
2.12.3 Dimensions: 8500 ft x 150 ft  
2.12.4 PCN: 91 R/B/W/T  
2.12.5 Coordinates: 32-52-29.8535N / 97-0-35.6686W  
2.12.6 Threshold Elevation: 575.6 ft  
2.12.6 Touchdown Zone Elevation: 575.6 ft

2.12.1 Designation: 17L  
2.12.2 True Bearing: 180  
2.12.3 Dimensions: 8500 ft x 150 ft  
2.12.4 PCN: 91 R/B/W/T  
2.12.5 Coordinates: 32-53-53.9534N / 97-0-35.203W

2.12.6 Threshold Elevation: 524.3 ft  
2.12.6 Touchdown Zone Elevation: 545.2 ft

2.12.1 Designation: 35L  
2.12.2 True Bearing: 0  
2.12.3 Dimensions: 13400 ft x 200 ft  
2.12.4 PCN: 81 R/B/W/T  
2.12.5 Coordinates: 32-52-44.0203N / 97-1-48.2888W  
2.12.6 Threshold Elevation: 563.4 ft  
2.12.6 Touchdown Zone Elevation: 564 ft

2.12.1 Designation: 17R  
2.12.2 True Bearing: 180  
2.12.3 Dimensions: 13400 ft x 200 ft  
2.12.4 PCN: 81 R/B/W/T  
2.12.5 Coordinates: 32-54-56.5996N / 97-1-47.5806W  
2.12.6 Threshold Elevation: 566.6 ft  
2.12.6 Touchdown Zone Elevation: 566.7 ft

2.12.1 Designation: 18L  
2.12.2 True Bearing: 180  
2.12.3 Dimensions: 13401 ft x 200 ft  
2.12.4 PCN: 83 R/B/W/T  
2.12.5 Coordinates: 32-54-56.8785N / 97-3-2.6511W  
2.12.6 Threshold Elevation: 601.5 ft  
2.12.6 Touchdown Zone Elevation: 601.6 ft

2.12.1 Designation: 36R  
2.12.2 True Bearing: 0  
2.12.3 Dimensions: 13401 ft x 200 ft  
2.12.4 PCN: 83 R/B/W/T  
2.12.5 Coordinates: 32-52-44.2972N / 97-3-3.3332W  
2.12.6 Threshold Elevation: 575.3 ft  
2.12.6 Touchdown Zone Elevation: 580.7 ft

2.12.1 Designation: 36L  
2.12.2 True Bearing: 0  
2.12.3 Dimensions: 13400 ft x 150 ft  
2.12.4 PCN: 90 R/C/W/T  
2.12.5 Coordinates: 32-52-44.3493N / 97-3-17.4003W  
2.12.6 Threshold Elevation: 582.2 ft  
2.12.6 Touchdown Zone Elevation: 587.6 ft

2.12.1 Designation: 18R

- 2.12.2 True Bearing: 180
- 2.12.3 Dimensions: 13400 ft x 150 ft
- 2.12.4 PCN: 90 R/C/W/T
- 2.12.5 Coordinates: 32-54-56.9275N / 97-3-16.7239W
- 2.12.6 Threshold Elevation: 606.4 ft
- 2.12.6 Touchdown Zone Elevation: 606.4 ft

**AD 2.13 Declared Distances**

- 2.13.1 Designation: 31R
- 2.13.2 Take-off Run Available: 8373
- 2.13.3 Take-off Distance Available: 8373
- 2.13.4 Accelerate-Stop Distance Available: 8373
- 2.13.5 Landing Distance Available: 8373

- 2.13.1 Designation: 13L
- 2.13.2 Take-off Run Available: 9000
- 2.13.3 Take-off Distance Available: 9000
- 2.13.4 Accelerate-Stop Distance Available: 9000
- 2.13.5 Landing Distance Available: 8373

- 2.13.1 Designation: 13R
- 2.13.2 Take-off Run Available: 9300
- 2.13.3 Take-off Distance Available: 9300
- 2.13.4 Accelerate-Stop Distance Available: 9300
- 2.13.5 Landing Distance Available: 9300

- 2.13.1 Designation: 31L
- 2.13.2 Take-off Run Available: 9300
- 2.13.3 Take-off Distance Available: 9300
- 2.13.4 Accelerate-Stop Distance Available: 9300
- 2.13.5 Landing Distance Available: 9300

- 2.13.1 Designation: 17C
- 2.13.2 Take-off Run Available: 13400
- 2.13.3 Take-off Distance Available: 13400
- 2.13.4 Accelerate-Stop Distance Available: 13400
- 2.13.5 Landing Distance Available: 13400

- 2.13.1 Designation: 35C
- 2.13.2 Take-off Run Available: 13400
- 2.13.3 Take-off Distance Available: 13400
- 2.13.4 Accelerate-Stop Distance Available: 13400
- 2.13.5 Landing Distance Available: 13400

- 2.13.1 Designation: 35R
- 2.13.2 Take-off Run Available: 8500
- 2.13.3 Take-off Distance Available: 8500
- 2.13.4 Accelerate-Stop Distance Available: 8500
- 2.13.5 Landing Distance Available: 8500

- 2.13.1 Designation: 17L
- 2.13.2 Take-off Run Available: 8500
- 2.13.3 Take-off Distance Available: 8500
- 2.13.4 Accelerate-Stop Distance Available: 8500
- 2.13.5 Landing Distance Available: 8500

- 2.13.1 Designation: 35L
- 2.13.2 Take-off Run Available: 13400
- 2.13.3 Take-off Distance Available: 13400
- 2.13.4 Accelerate-Stop Distance Available: 13400
- 2.13.5 Landing Distance Available: 13400

- 2.13.1 Designation: 17R
- 2.13.2 Take-off Run Available: 13400
- 2.13.3 Take-off Distance Available: 13400
- 2.13.4 Accelerate-Stop Distance Available: 13400
- 2.13.5 Landing Distance Available: 13400

- 2.13.1 Designation: 18L
- 2.13.2 Take-off Run Available: 13401
- 2.13.3 Take-off Distance Available: 13401
- 2.13.4 Accelerate-Stop Distance Available: 13401
- 2.13.5 Landing Distance Available: 13401

- 2.13.1 Designation: 36R
- 2.13.2 Take-off Run Available: 13401
- 2.13.3 Take-off Distance Available: 13401
- 2.13.4 Accelerate-Stop Distance Available: 13401
- 2.13.5 Landing Distance Available: 13401

- 2.13.1 Designation: 36L
- 2.13.2 Take-off Run Available: 13400
- 2.13.3 Take-off Distance Available: 13400
- 2.13.4 Accelerate-Stop Distance Available: 13400
- 2.13.5 Landing Distance Available: 13400

- 2.13.1 Designation: 18R



- 2.13.2 Take-off Run Available: 13400
- 2.13.3 Take-off Distance Available: 13400
- 2.13.4 Accelerate-Stop Distance Available: 13400
- 2.13.5 Landing Distance Available: 13400

**AD 2.14 Approach and Runway Lighting**

- 2.14.1 Designation: 31R
- 2.14.2 Approach Lighting System: MALSR
- 2.14.4 Visual Approach Slope Indicator System: P4L

- 2.14.1 Designation: 13L
- 2.14.2 Approach Lighting System:
- 2.14.4 Visual Approach Slope Indicator System: P4L

- 2.14.1 Designation: 13R
- 2.14.2 Approach Lighting System: MALSR
- 2.14.4 Visual Approach Slope Indicator System: P4L

- 2.14.1 Designation: 31L
- 2.14.2 Approach Lighting System:
- 2.14.4 Visual Approach Slope Indicator System: P4L

- 2.14.1 Designation: 17C
- 2.14.2 Approach Lighting System: ALSF2
- 2.14.4 Visual Approach Slope Indicator System: P4L

- 2.14.1 Designation: 35C
- 2.14.2 Approach Lighting System: ALSF2
- 2.14.4 Visual Approach Slope Indicator System: P4L

- 2.14.1 Designation: 35R
- 2.14.2 Approach Lighting System: ALSF2
- 2.14.4 Visual Approach Slope Indicator System: P4R

- 2.14.1 Designation: 17L
- 2.14.2 Approach Lighting System: ALSF2
- 2.14.4 Visual Approach Slope Indicator System: P4L

- 2.14.1 Designation: 35L
- 2.14.2 Approach Lighting System: MALSR
- 2.14.4 Visual Approach Slope Indicator System: P4L

- 2.14.1 Designation: 17R

2.14.2 Approach Lighting System: MALSR  
2.14.4 Visual Approach Slope Indicator System: P4L

2.14.1 Designation: 18L  
2.14.2 Approach Lighting System: MALSR  
2.14.4 Visual Approach Slope Indicator System: P4L

2.14.1 Designation: 36R  
2.14.2 Approach Lighting System: MALSR  
2.14.4 Visual Approach Slope Indicator System: P4L

2.14.1 Designation: 36L  
2.14.2 Approach Lighting System: MALSR  
2.14.4 Visual Approach Slope Indicator System: P4L

2.14.1 Designation: 18R  
2.14.2 Approach Lighting System: ALSF2  
2.14.4 Visual Approach Slope Indicator System: P4L

**AD 2.18 Air Traffic Services Communication Facilities**

2.18.1 Service Designation: CD/P  
2.18.3 Channel: 128.25  
2.18.5 Hours of Operation: 24

2.18.1 Service Designation: CLASS B (NW)  
2.18.3 Channel: 118.1  
2.18.5 Hours of Operation:

2.18.1 Service Designation: CLASS B (NE)  
2.18.3 Channel: 124.3  
2.18.5 Hours of Operation:

2.18.1 Service Designation: CLASS B (SE)  
2.18.3 Channel: 125.2  
2.18.5 Hours of Operation:

2.18.1 Service Designation: CLASS B (SW)  
2.18.3 Channel: 135.975  
2.18.5 Hours of Operation:

2.18.1 Service Designation: CLASS B (NE)  
2.18.3 Channel: 282.275  
2.18.5 Hours of Operation:

2.18.1 Service Designation: CLASS B (NW)

2.18.3 Channel: 306.95

2.18.5 Hours of Operation:

2.18.1 Service Designation: CLASS B (SE)

2.18.3 Channel: 343.65

2.18.5 Hours of Operation:

2.18.1 Service Designation: CLASS B (SW)

2.18.3 Channel: 379.9

2.18.5 Hours of Operation:

2.18.1 Service Designation: D-ATIS (ARR)

2.18.3 Channel: 123.775

2.18.5 Hours of Operation: 24

2.18.1 Service Designation: D-ATIS (DEP)

2.18.3 Channel: 135.925

2.18.5 Hours of Operation: 24

2.18.1 Service Designation: EMERG

2.18.3 Channel: 243

2.18.5 Hours of Operation:

2.18.1 Service Designation: GND/P (EAST)

2.18.3 Channel: 121.8

2.18.5 Hours of Operation: 24

2.18.1 Service Designation: GND/P IC (EAST)

2.18.3 Channel: 121.65

2.18.5 Hours of Operation: 24

2.18.1 Service Designation: GND/P IC (WEST)

2.18.3 Channel: 121.85

2.18.5 Hours of Operation: 24

2.18.1 Service Designation: JACKY DP (RWYS 31L/R, 36L/R, 35L/C/R)

2.18.3 Channel: 118.1

2.18.5 Hours of Operation:

2.18.1 Service Designation: JACKY DP (RWYS 13L/R, 17L/C/R, 18L/R)

2.18.3 Channel: 135.975

2.18.5 Hours of Operation:

2.18.1 Service Designation: JACKY DP (RWYS 31L/R, 36L/R, 35L/C/R)

2.18.3 Channel: 306.95

2.18.5 Hours of Operation:

2.18.1 Service Designation: JACKY DP (RWYS 13L/R, 17 L/C/R, 18L/R)

2.18.3 Channel: 379.9

2.18.5 Hours of Operation:

2.18.1 Service Designation: LCL/P (EAST)

2.18.3 Channel: 127.5

2.18.5 Hours of Operation: 24

2.18.1 Service Designation: LCL/P (WEST)

2.18.3 Channel: 134.9

2.18.5 Hours of Operation: 24

2.18.1 Service Designation: LCL/P IC (WEST)

2.18.3 Channel: 124.15

2.18.5 Hours of Operation: 24

2.18.1 Service Designation: LCL/P IC (EAST)

2.18.3 Channel: 126.55

2.18.5 Hours of Operation: 24

### **AD 2.19 Radio Navigation and Landing Aids**

2.19.1 ILS Type: DME for runway 31R. Magnetic variation: 4E

2.19.2 ILS Identification: RRA

2.19.5 Coordinates: 32-54-49.6375N / 97-1-18.3123W

2.19.6 Site Elevation: 558.1 ft

2.19.1 ILS Type: Glide Slope for runway 31R. Magnetic variation: 4E

2.19.2 ILS Identification: RRA

2.19.5 Coordinates: 32-53-51.7482N / 97-0-7.9558W

2.19.6 Site Elevation: 509 ft

2.19.1 ILS Type: Localizer for runway 31R. Magnetic variation: 4E

2.19.2 ILS Identification: RRA

2.19.5 Coordinates: 32-54-48.1182N / 97-1-20.7551W

2.19.6 Site Elevation: 551.5 ft

2.19.1 ILS Type: DME for runway 13R. Magnetic variation: 4E

2.19.2 ILS Identification: LWN

2.19.5 Coordinates: 32-53-16.0647N / 97-3-42.7672W

2.19.6 Site Elevation: 588.7 ft

2.19.1 ILS Type: Glide Slope for runway 13R. Magnetic variation: 4E

2.19.2 ILS Identification: LWN

2.19.5 Coordinates: 32-54-24.1329N / 97-4-54.0746W

2.19.6 Site Elevation: 587.6 ft

2.19.1 ILS Type: Localizer for runway 13R. Magnetic variation: 4E

2.19.2 ILS Identification: LWN

2.19.5 Coordinates: 32-53-17.4371N / 97-3-40.0471W

2.19.6 Site Elevation: 575 ft

2.19.1 ILS Type: DME for runway 17C. Magnetic variation: 4E

2.19.2 ILS Identification: FLQ

2.19.5 Coordinates: 32-52-34.123N / 97-1-39.6491W

2.19.6 Site Elevation: 573.6 ft

2.19.1 ILS Type: Glide Slope for runway 17C. Magnetic variation: 4E

2.19.2 ILS Identification: FLQ

2.19.5 Coordinates: 32-54-45.6425N / 97-1-28.781W

2.19.6 Site Elevation: 555.8 ft

2.19.1 ILS Type: Inner Marker for runway 17C. Magnetic variation: 4E

2.19.2 ILS Identification: FLQ

2.19.5 Coordinates: 32-55-4.09N / 97-1-33.46W

2.19.6 Site Elevation: 562 ft

2.19.1 ILS Type: Localizer for runway 17C. Magnetic variation: 4E

2.19.2 ILS Identification: FLQ

2.19.5 Coordinates: 32-52-33.1505N / 97-1-34.2781W

2.19.6 Site Elevation: 562.7 ft

2.19.1 ILS Type: DME for runway 35C. Magnetic variation: 4E

2.19.2 ILS Identification: PKQ

2.19.5 Coordinates: 32-52-34.123N / 97-1-39.6491W

2.19.6 Site Elevation: 573.6 ft

2.19.1 ILS Type: Glide Slope for runway 35C. Magnetic variation: 4E

2.19.2 ILS Identification: PKQ

2.19.5 Coordinates: 32-52-54.3357N / 97-1-29.4713W

2.19.6 Site Elevation: 557.2 ft

2.19.1 ILS Type: Inner Marker for runway 35C. Magnetic variation: 4E

2.19.2 ILS Identification: PKQ  
2.19.5 Coordinates: 32-52-35.3015N / 97-1-34.258W  
2.19.6 Site Elevation: 562.5 ft

2.19.1 ILS Type: Localizer for runway 35C. Magnetic variation: 4E  
2.19.2 ILS Identification: PKQ  
2.19.5 Coordinates: 32-55-7.0371N / 97-1-33.452W  
2.19.6 Site Elevation: 561.2 ft

2.19.1 ILS Type: DME for runway 17L. Magnetic variation: 4E  
2.19.2 ILS Identification: PPZ  
2.19.5 Coordinates: 32-52-18.7175N / 97-0-40.2982W  
2.19.6 Site Elevation: 591.2 ft

2.19.1 ILS Type: Glide Slope for runway 17L. Magnetic variation: 4E  
2.19.2 ILS Identification: PPZ  
2.19.5 Coordinates: 32-53-45.2247N / 97-0-31.1329W  
2.19.6 Site Elevation: 526.4 ft

2.19.1 ILS Type: Inner Marker for runway 17L. Magnetic variation: 4E  
2.19.2 ILS Identification: PPZ  
2.19.5 Coordinates: 32-54-5.3333N / 97-0-35.2536W  
2.19.6 Site Elevation: 521.7 ft

2.19.1 ILS Type: Localizer for runway 17L. Magnetic variation: 4E  
2.19.2 ILS Identification: PPZ  
2.19.5 Coordinates: 32-52-19.4359N / 97-0-35.7267W  
2.19.6 Site Elevation: 584.2 ft

2.19.1 ILS Type: DME for runway 35R. Magnetic variation: 4E  
2.19.2 ILS Identification: AJQ  
2.19.5 Coordinates: 32-52-18.7175N / 97-0-40.2982W  
2.19.6 Site Elevation: 591.2 ft

2.19.1 ILS Type: Glide Slope for runway 35R. Magnetic variation: 4E  
2.19.2 ILS Identification: AJQ  
2.19.5 Coordinates: 32-52-43.4402N / 97-0-30.9032W  
2.19.6 Site Elevation: 559.2 ft

2.19.1 ILS Type: Inner Marker for runway 35R. Magnetic variation: 4E  
2.19.2 ILS Identification: AJQ  
2.19.5 Coordinates: 32-52-22.6082N / 97-0-35.7029W  
2.19.6 Site Elevation: 581.2 ft

2.19.1 ILS Type: Localizer for runway 35R. Magnetic variation: 4E

2.19.2 ILS Identification: AJQ

2.19.5 Coordinates: 32-54-4.1916N / 97-0-35.1492W

2.19.6 Site Elevation: 519.5 ft

2.19.1 ILS Type: DME for runway 17R. Magnetic variation: 4E

2.19.2 ILS Identification: JHZ

2.19.5 Coordinates: 32-52-33.6523N / 97-1-53.6029W

2.19.6 Site Elevation: 556.9 ft

2.19.1 ILS Type: Glide Slope for runway 17R. Magnetic variation: 4E

2.19.2 ILS Identification: JHZ

2.19.5 Coordinates: 32-54-45.8213N / 97-1-43.0635W

2.19.6 Site Elevation: 561.3 ft

2.19.1 ILS Type: Localizer for runway 17R. Magnetic variation: 4E

2.19.2 ILS Identification: JHZ

2.19.5 Coordinates: 32-52-33.207N / 97-1-48.3488W

2.19.6 Site Elevation: 558.2 ft

2.19.1 ILS Type: DME for runway 35L. Magnetic variation: 4E

2.19.2 ILS Identification: UWX

2.19.5 Coordinates: 32-52-33.6523N / 97-1-53.6029W

2.19.6 Site Elevation: 556.9 ft

2.19.1 ILS Type: Glide Slope for runway 35L. Magnetic variation: 4E

2.19.2 ILS Identification: UWX

2.19.5 Coordinates: 32-52-54.9854N / 97-1-43.5413W

2.19.6 Site Elevation: 559 ft

2.19.1 ILS Type: Localizer for runway 35L. Magnetic variation: 4E

2.19.2 ILS Identification: UWX

2.19.5 Coordinates: 32-55-7.3142N / 97-1-47.5225W

2.19.6 Site Elevation: 567.6 ft

2.19.1 ILS Type: DME for runway 18L. Magnetic variation: 4E

2.19.2 ILS Identification: CIX

2.19.5 Coordinates: 32-55-8.6708N / 97-3-7.2741W

2.19.6 Site Elevation: 594.7 ft

2.19.1 ILS Type: Glide Slope for runway 18L. Magnetic variation: 4E

2.19.2 ILS Identification: CIX

2.19.5 Coordinates: 32-54-45.2198N / 97-3-6.8173W

2.19.6 Site Elevation: 594.3 ft

2.19.1 ILS Type: Localizer for runway 18L. Magnetic variation: 4E

2.19.2 ILS Identification: CIX

2.19.5 Coordinates: 32-52-33.5835N / 97-3-3.3873W

2.19.6 Site Elevation: 570.1 ft

2.19.1 ILS Type: DME for runway 36R. Magnetic variation: 4E

2.19.2 ILS Identification: FJN

2.19.5 Coordinates: 32-55-8.6708N / 97-3-7.2741W

2.19.6 Site Elevation: 594.7 ft

2.19.1 ILS Type: Glide Slope for runway 36R. Magnetic variation: 4E

2.19.2 ILS Identification: FJN

2.19.5 Coordinates: 32-52-54.8518N / 97-3-7.9662W

2.19.6 Site Elevation: 577.2 ft

2.19.1 ILS Type: Localizer for runway 36R. Magnetic variation: 4E

2.19.2 ILS Identification: FJN

2.19.5 Coordinates: 32-55-6.8486N / 97-3-2.5997W

2.19.6 Site Elevation: 597.2 ft

2.19.1 ILS Type: DME for runway 18R. Magnetic variation: 4E

2.19.2 ILS Identification: VYN

2.19.5 Coordinates: 32-52-34.0875N / 97-3-12.5854W

2.19.6 Site Elevation: 582.3 ft

2.19.1 ILS Type: Glide Slope for runway 18R. Magnetic variation: 4E

2.19.2 ILS Identification: VYN

2.19.5 Coordinates: 32-54-45.4683N / 97-3-21.5693W

2.19.6 Site Elevation: 598.5 ft

2.19.1 ILS Type: Inner Marker for runway 18R. Magnetic variation: 4E

2.19.2 ILS Identification: VYN

2.19.5 Coordinates: 32-55-4.5483N / 97-3-16.6916W

2.19.6 Site Elevation: 602.6 ft

2.19.1 ILS Type: Localizer for runway 18R. Magnetic variation: 4E

2.19.2 ILS Identification: VYN

2.19.5 Coordinates: 32-52-33.9326N / 97-3-17.4526W

2.19.6 Site Elevation: 580.4 ft

2.19.1 ILS Type: DME for runway 36L. Magnetic variation: 4E

2.19.2 ILS Identification: BXN

2.19.5 Coordinates: 32-52-34.0875N / 97-3-12.5854W



2.19.6 Site Elevation: 582.3 ft

2.19.1 ILS Type: Glide Slope for runway 36L. Magnetic variation: 4E

2.19.2 ILS Identification: BXN

2.19.5 Coordinates: 32-52-54.4087N / 97-3-22.0405W

2.19.6 Site Elevation: 579.9 ft

2.19.1 ILS Type: Localizer for runway 36L. Magnetic variation: 4E

2.19.2 ILS Identification: BXN

2.19.5 Coordinates: 32-55-6.9002N / 97-3-16.6717W

2.19.6 Site Elevation: 601.9 ft

**General Remarks:**

TKOF DSTC FOR RY 35L FM TWY EQ IS 13084 FT & FM TWY EP IS 12811 FT.

ARPT UNDER CONSTRUCTION; PAEW IN MOVEMENT AREAS.

PPR ACFT WITH WINGSPAN 215 FT OR GREATER (GROUP VI) CALL ARPT OPNS 972-973-3112 FOR FOLLOW-ME SERVICES WHILE TAXIING TO & FROM RAMP & RYS.

TWY A6 CLSD TO ACFT WITH WINGSPAN 171 FT AND GREATER.

TKOF DSTC FOR RY 18R FM TWY WG IS 13,082 FT.

RY VISUAL SCREEN 20 FT AGL 1180 FT S AER 35C.

APRON ENTRANCE/EXIT POINT 3 CLSD TO ACFT WITH WINGSPAN GREATER THAN 214 FT EXCEPT PPR.

APRON ENTRANCE/EXIT POINTS 22, 24, 105, AND 107 CLSD TO ACFT WITH WINGSPAN GREATER THAN 125 FT.

ACFT USING TERMINAL A GATES A8-A39 AND TERMINAL C GATES C2-C12 MUST OBTAIN APPROVAL FROM RAMP 131.275 PRIOR TO ENTERING RAMP AND PRIOR TO PUSHBACK.

TKOF DSTC FOR RY 17L FM TWY Q2 IS 8196 FT.

ACFT USING TERMINAL C GATES C14-C39 MUST OBTAIN APPROVAL FROM RAMP 131.80 PRIOR TO ENTERING RAMP AND PRIOR TO PUSHBACK.

PPR GA OPERATIONS 0000-0500; CALL ARPT OPNS 972-973-3112.

APRON ENTRANCE/EXIT POINT 124 CLSD TO ACFT WITH WINGSPAN GREATER THAN 213 FT.

RY STATUS LGTS IN OPN.

TKOF DSTC FOR RY 35R FM TWY Q9 IS 8196 FT.

ACFT USING TERMINAL B GATES B1-B17, ALL TERMINAL D GATES, AND APRON ENTRY POINTS 117-150 MUST OBTAIN APPROVAL FROM RAMP 129.825 PRIOR TO ENTERING RAMP AND PRIOR TO PUSHBACK.

TERMINAL B APRON TAXILANE BTN APRON ENTRANCE/EXIT POINT TAXILANES 107 & 117 CLSD TO ACFT WITH WINGSPAN 94 FT AND GREATER.

TKOF DSTC FOR RY 17C FM TWY EG IS 13,082 FT.

APRON ENTRANCE/EXIT POINTS 110, 111, 112, 113, 114, 115, AND 116 CLSD TO ACFT WITH WINGSPAN GREATER THAN 94 FT.

TKOF DSTC FOR RY 18L FM TWY WG IS 13,082; FM TWY WH IS 12,815.

UNLESS OTHERWISE SPECIFIED, ALL APRON ENTRANCE/EXIT POINTS CLSD TO ACFT WITH WINGSPAN GREATER THAN 214 FT EXCEPT PPR.

PPR FROM ARPT OPNS FOR GEN AVN ACFT TO PROCD TO AIRLINE TRML GATE EXCP GEN AVN FAC.

PPR FM THE PRIMARY TENANT AIRLINES TO OPERATE WITHIN THE CENTRAL TERMINAL AREA. PROPER MINIMUM OBJECT FREE AREA DISTANCES MAY NOT BE MAINTAINED FOR RAMP/APRON TAXILANES.

TWY EDGE REFLECTORS ALONG ALL TWYS.

APRON ENTRANCE/EXIT POINTS 1 AND 2 CLSD TO ACFT WITH WINGSPAN GREATER THAN 89' EXCEPT PPR.

TKOF DSTC FOR RY 36R FM TWY WP IS 12,815 FT; FM TWY WQ IS 13,082 FT.

TKOF DSTC FOR RY 17R FM TWY EG IS 13082 FT & FM TWY EH IS 12816 FT.

LAND & HOLD SHORT SIGNS ON RY 17C AT TWY 'B' 10,460 FT S OF RY 17C THLD; RY 18R AT TWY 'B' 10,100 FT S OF RY 18R THLD; RY 35C AT TWY 'EJ' 9050 FT N OF RY 35C THLD; RY 36L AT TWY 'Z' 10,650 FT N OF RY 36L THLD; LGTD & MKD WITH IN-PAVEMENT PULSATING WHITE LGTS.

ACFT USING TWY HA NORTH OF TWY B MUST OBTAIN APPROVAL FROM RAMP 129.825 PRIOR TO ENTERING RAMP.

APRON ENTRANCE/EXIT POINTS 9, 32, 33, 34, 35, 36, 37, 38, & 53 CLSD TO ACFT WITH WINGSPAN GREATER THAN 135 FT.

APRON ENTRANCE/EXIT POINTS 5, 7, 42, 44, 48, 49, 51, 52, 117, 118 AND 122 CLSD TO ACFT WITH WINGSPAN GREATER THAN 118 FT.

APRON ENTRANCE/EXIT POINTS 31 AND 39 CLSD TO ACFT WITH WINGSPAN GREATER THAN 167 FT.

ACFT USING TERMINAL B GATES B18-B49 MUST OBTAIN APPROVAL FROM RAMP 130.10 PRIOR TO ENTERING RAMP AND PRIOR TO PUSHBACK.

TWYS MAY REQUIRE JUDGMENTAL OVERSTEERING FOR LARGE ACFT.

STD SAWED GROOVING 160 FT WIDE FULL LENGTH RYS 13L/31R; 18L/36R & 17R/35L. STD GROOVING 130 FT WIDE FULL LENGTH RYS 17L/35R; 18R/36L; 13R/31L & 17C/35C.

BIRDS ON & INVOF ARPT.

ASDE-X IN USE. OPERATE TRANSPONDERS WITH ALTITUDE REPORTING MODE AND ADS-B (IF EQUIPPED) ENABLED ON ALL AIRPORT SURFACES.

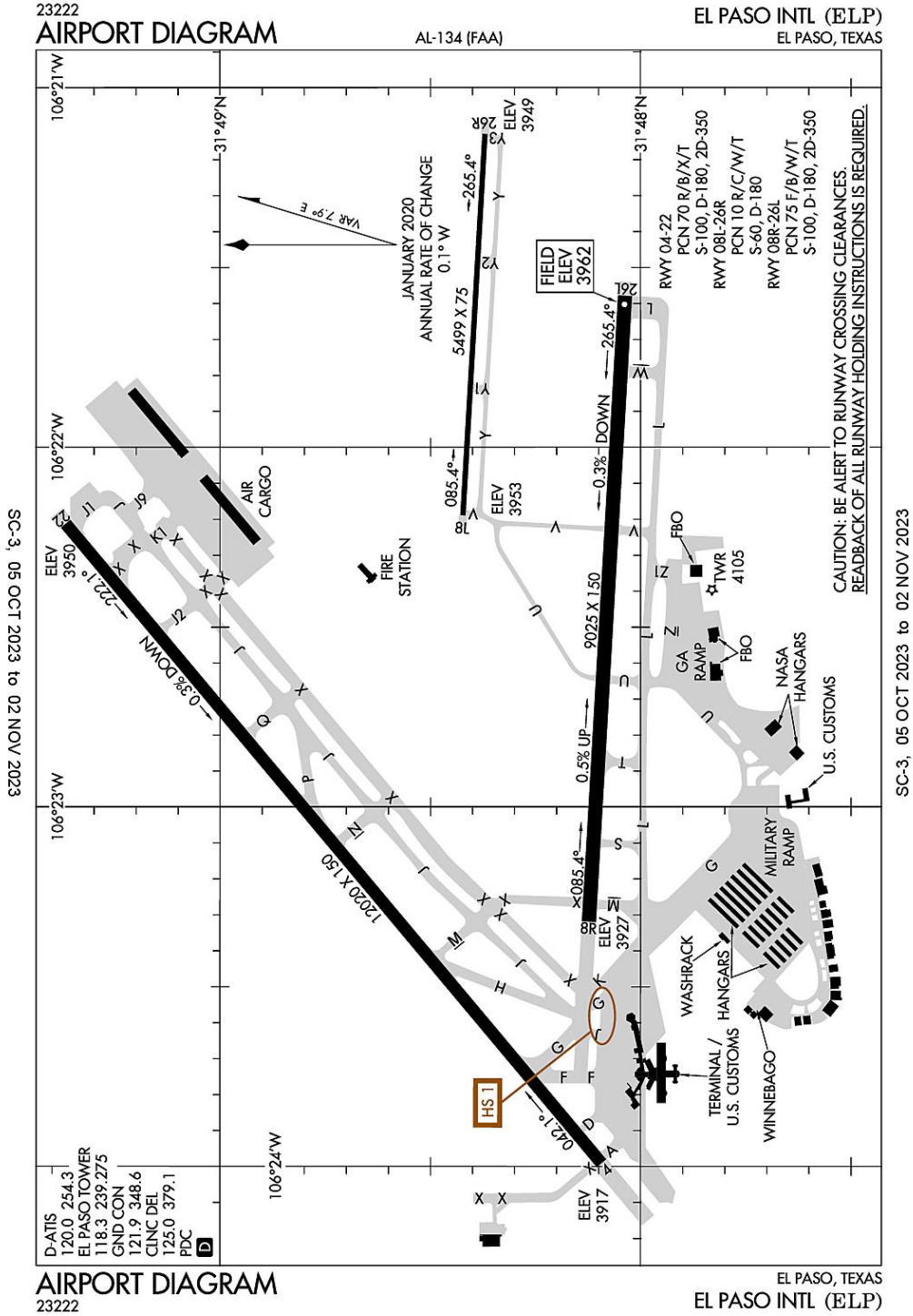
RY VISUAL SCREEN 22 FT AGL 1179 FT S AER 35L.

ACFT USING TERMINAL E GATES E2-E17 MUST OBTAIN APPROVAL FROM RAMP 131.0 PRIOR TO ENTERING RAMP AND PRIOR TO PUSHBACK. ACFT USING TERMINAL E GATES E-18-E38 MUST OBTAIN

APPROVAL FROM RAMP 128.825 PRIOR TO ENTERING RAMP AND PRIOR TO PUSHBACK.

A380 OPNS ONLY AUZD ON RWYS 18R/36L AND 18L/36R. B747-8 OPNS ONLY AUZD ON RWYS 18R/36L, 18L/36R AND 17R/35L. CTC ARPT OPNS FOR ADDNL INFO.

### El Paso, Texas El Paso International ICAO Identifier KELP



**El Paso, TX**  
**El Paso Intl**  
**ICAO Identifier KELP**

**AD 2.2 Aerodrome geographical and administrative data**

- 2.2.1 Reference Point: 31-48-26.4N / 106-22-34.9W
- 2.2.2 From City: 4 miles NE of EL PASO, TX
- 2.2.3 Elevation: 3961.6 ft
- 2.2.5 Magnetic Variation: 8E (2015)
- 2.2.6 Airport Contact: SAM RODRIGUEZ  
6701 CONVAIR RD  
EL PASO, TX 79925 (915-212-0333)
- 2.2.7 Traffic: IFR/VFR

**AD 2.3 Attendance Schedule**

- 2.3.1 All Months, All Days, All Hours

**AD 2.4 Handling Services and Facilities**

- 2.4.1 Cargo Handling Facilities: YES
- 2.4.2 Fuel Types: 100LL,A1+
- 2.4.5 Hangar Space: YES
- 2.4.6 Repair Facilities: MAJOR

**AD 2.6 Rescue and Firefighting Services**

- 2.6.1 Aerodrome Category: Class-I certified on 5/1/1973
- 2.6.2 Rescue and Firefighting Services: ARFF Index-C

**AD 2.12 Runway Physical Characteristics**

- 2.12.1 Designation: 04
- 2.12.2 True Bearing: 50
- 2.12.3 Dimensions: 12020 ft x 150 ft
- 2.12.4 PCN: 70 R/B/X/T
- 2.12.5 Coordinates: 31-48-5.5605N / 106-23-59.4625W
- 2.12.6 Threshold Elevation: 3916.9 ft
- 2.12.6 Touchdown Zone Elevation: 3923.2 ft
  
- 2.12.1 Designation: 22
- 2.12.2 True Bearing: 230
- 2.12.3 Dimensions: 12020 ft x 150 ft
- 2.12.4 PCN: 70 R/B/X/T
- 2.12.5 Coordinates: 31-49-22.0112N / 106-22-12.7821W
- 2.12.6 Threshold Elevation: 3949.5 ft
- 2.12.6 Touchdown Zone Elevation: 3949.5 ft
  
- 2.12.1 Designation: 08L

2.12.2 True Bearing: 93  
2.12.3 Dimensions: 5499 ft x 75 ft  
2.12.4 PCN: 10 R/C/W/T  
2.12.5 Coordinates: 31-48-25.3326N / 106-22-11.3796W  
2.12.6 Threshold Elevation: 3952.6 ft  
2.12.6 Touchdown Zone Elevation: 3952.7 ft

2.12.1 Designation: 26R  
2.12.2 True Bearing: 273  
2.12.3 Dimensions: 5499 ft x 75 ft  
2.12.4 PCN: 10 R/C/W/T  
2.12.5 Coordinates: 31-48-22.1849N / 106-21-7.7768W  
2.12.6 Threshold Elevation: 3949.2 ft  
2.12.6 Touchdown Zone Elevation: 3949.5 ft

2.12.1 Designation: 08R  
2.12.2 True Bearing: 93  
2.12.3 Dimensions: 9025 ft x 150 ft  
2.12.4 PCN: 75 F/B/W/T  
2.12.5 Coordinates: 31-48-7.3509N / 106-23-19.1333W  
2.12.6 Threshold Elevation: 3927.1 ft  
2.12.6 Touchdown Zone Elevation: 3940.3 ft

2.12.1 Designation: 26L  
2.12.2 True Bearing: 273  
2.12.3 Dimensions: 9025 ft x 150 ft  
2.12.4 PCN: 75 F/B/W/T  
2.12.5 Coordinates: 31-48-2.195N / 106-21-34.7505W  
2.12.6 Threshold Elevation: 3961.6 ft  
2.12.6 Touchdown Zone Elevation: 3961.6 ft

### **AD 2.13 Declared Distances**

2.13.1 Designation: 04  
2.13.2 Take-off Run Available: 12020  
2.13.3 Take-off Distance Available: 12020  
2.13.4 Accelerate-Stop Distance Available: 12020  
2.13.5 Landing Distance Available: 12020

2.13.1 Designation: 22  
2.13.2 Take-off Run Available: 12020  
2.13.3 Take-off Distance Available: 12020  
2.13.4 Accelerate-Stop Distance Available: 12020  
2.13.5 Landing Distance Available: 12020

- 2.13.1 Designation: 08L
- 2.13.2 Take-off Run Available: 5499
- 2.13.3 Take-off Distance Available: 5499
- 2.13.4 Accelerate-Stop Distance Available: 5499
- 2.13.5 Landing Distance Available: 5499

- 2.13.1 Designation: 26R
- 2.13.2 Take-off Run Available: 5499
- 2.13.3 Take-off Distance Available: 5499
- 2.13.4 Accelerate-Stop Distance Available: 5499
- 2.13.5 Landing Distance Available: 5499

- 2.13.1 Designation: 08R
- 2.13.2 Take-off Run Available: 9025
- 2.13.3 Take-off Distance Available: 9025
- 2.13.4 Accelerate-Stop Distance Available: 9025
- 2.13.5 Landing Distance Available: 9025

- 2.13.1 Designation: 26L
- 2.13.2 Take-off Run Available: 9025
- 2.13.3 Take-off Distance Available: 9025
- 2.13.4 Accelerate-Stop Distance Available: 9025
- 2.13.5 Landing Distance Available: 9025

#### **AD 2.14 Approach and Runway Lighting**

- 2.14.1 Designation: 04
- 2.14.2 Approach Lighting System:
- 2.14.4 Visual Approach Slope Indicator System: P4L

- 2.14.1 Designation: 22
- 2.14.2 Approach Lighting System: MALSR
- 2.14.4 Visual Approach Slope Indicator System: P4R

- 2.14.1 Designation: 08L
- 2.14.2 Approach Lighting System:
- 2.14.4 Visual Approach Slope Indicator System:

- 2.14.1 Designation: 26R
- 2.14.2 Approach Lighting System:
- 2.14.4 Visual Approach Slope Indicator System:

- 2.14.1 Designation: 08R

2.14.2 Approach Lighting System:  
2.14.4 Visual Approach Slope Indicator System: P4L

2.14.1 Designation: 26L  
2.14.2 Approach Lighting System: MALSR  
2.14.4 Visual Approach Slope Indicator System: P4R

**AD 2.18 Air Traffic Services Communication Facilities**

2.18.1 Service Designation: APCH/P (SOUTH-V16)  
2.18.3 Channel: 119.15  
2.18.5 Hours of Operation: 24

2.18.1 Service Designation: APCH/P (SOUTH-V16)  
2.18.3 Channel: 353.5  
2.18.5 Hours of Operation: 24

2.18.1 Service Designation: APCH/P IC (NORTH-V16)  
2.18.3 Channel: 124.25  
2.18.5 Hours of Operation: 24

2.18.1 Service Designation: APCH/P IC (NORTH-V16)  
2.18.3 Channel: 298.85  
2.18.5 Hours of Operation: 24

2.18.1 Service Designation: CD PRE TAXI CLNC  
2.18.3 Channel: 125  
2.18.5 Hours of Operation: 24

2.18.1 Service Designation: CD/P  
2.18.3 Channel: 379.1  
2.18.5 Hours of Operation: 24

2.18.1 Service Designation: CLASS C  
2.18.3 Channel: 119.15  
2.18.5 Hours of Operation: 24

2.18.1 Service Designation: CLASS C (SOUTH-V16)  
2.18.3 Channel: 119.15  
2.18.5 Hours of Operation: 24

2.18.1 Service Designation: CLASS C (NORTH-V16)  
2.18.3 Channel: 124.25  
2.18.5 Hours of Operation: 24



2.18.1 Service Designation: CLASS C (NORTH-V16)

2.18.3 Channel: 298.85

2.18.5 Hours of Operation: 24

2.18.1 Service Designation: CLASS C (SOUTH-V16)

2.18.3 Channel: 353.5

2.18.5 Hours of Operation: 24

2.18.1 Service Designation: D-ATIS

2.18.3 Channel: 120

2.18.5 Hours of Operation: 24

2.18.1 Service Designation: D-ATIS

2.18.3 Channel: 254.3

2.18.5 Hours of Operation: 24

2.18.1 Service Designation: DEP/P

2.18.3 Channel: 119.15

2.18.5 Hours of Operation: 24

2.18.1 Service Designation: DEP/P

2.18.3 Channel: 263

2.18.5 Hours of Operation: 24

2.18.1 Service Designation: EMERG

2.18.3 Channel: 121.5

2.18.5 Hours of Operation:

2.18.1 Service Designation: EMERG

2.18.3 Channel: 243

2.18.5 Hours of Operation:

2.18.1 Service Designation: GND/P

2.18.3 Channel: 121.9

2.18.5 Hours of Operation: 24

2.18.1 Service Designation: GND/P

2.18.3 Channel: 348.6

2.18.5 Hours of Operation: 24

2.18.1 Service Designation: LCL/P

2.18.3 Channel: 118.3

2.18.5 Hours of Operation: 24

2.18.1 Service Designation: LCL/P

2.18.3 Channel: 239.275

2.18.5 Hours of Operation: 24

**AD 2.19 Radio Navigation and Landing Aids**

2.19.1 ILS Type: DME for runway 04. Magnetic variation: 8E

2.19.2 ILS Identification: ETF

2.19.5 Coordinates: 31-47-58.7232N / 106-24-13.5201W

2.19.6 Site Elevation: 3926 ft

2.19.1 ILS Type: Localizer for runway 04. Magnetic variation: 8E

2.19.2 ILS Identification: ETF

2.19.5 Coordinates: 31-49-28.4448N / 106-22-3.7979W

2.19.6 Site Elevation: 3950.4 ft

2.19.1 ILS Type: DME for runway 22. Magnetic variation: 8E

2.19.2 ILS Identification: ELP

2.19.5 Coordinates: 31-47-58.7232N / 106-24-13.5201W

2.19.6 Site Elevation: 3926 ft

2.19.1 ILS Type: Glide Slope for runway 22. Magnetic variation: 8E

2.19.2 ILS Identification: ELP

2.19.5 Coordinates: 31-49-17.2839N / 106-22-26.5917W

2.19.6 Site Elevation: 3940.3 ft

2.19.1 ILS Type: Localizer for runway 22. Magnetic variation: 8E

2.19.2 ILS Identification: ELP

2.19.5 Coordinates: 31-47-55.923N / 106-24-12.9005W

2.19.6 Site Elevation: 3910.9 ft

2.19.1 Navigation Aid Type: VORTAC. Magnetic variation: 12E

2.19.2 Navigation Aid Identification: ELP

2.19.5 Coordinates: 31-48-57.277N / 106-16-54.7782W

2.19.6 Site Elevation: 4023 ft

**General Remarks:**

TWY A SOUTH OF APCH END OF RWY 4; TWY J NE OF TWY K1; TWY K NE OF TWY K1 BTN TWY J & NORTH CARGO RAMP; TWYS U & V SOUTH OF TWY L; & TWY K2 NOT VISIBLE FM ATCT.

ENGINE POWER IS RSTRD TO IDLE POWER ON ONE ENGINE AT A TIME FOR MAX 5 MIN ON ANY TERMINAL OR PARKING APRONS, CROSS-BLEED STARTS OR OTHER PRE DEP ACTIVITY ON MOVEMENT AREAS ONLY, MAINT OR OTR RQRMT NEEDING LONGER OR HIGHER POWER CTC TWR FOR DIRECTIONS TO DESIGNATED RUNUP AREAS.

CTN: BIGGS AAF 2NM NW RWY 22 CAN BE MISTAKEN FOR ELP RWY 22.

COMPASS ROSE CLSD PERMLY.

NOISE ABATEMENT PROCEDURES IN EFFECT, CTC ATCT FOR DETAILS.

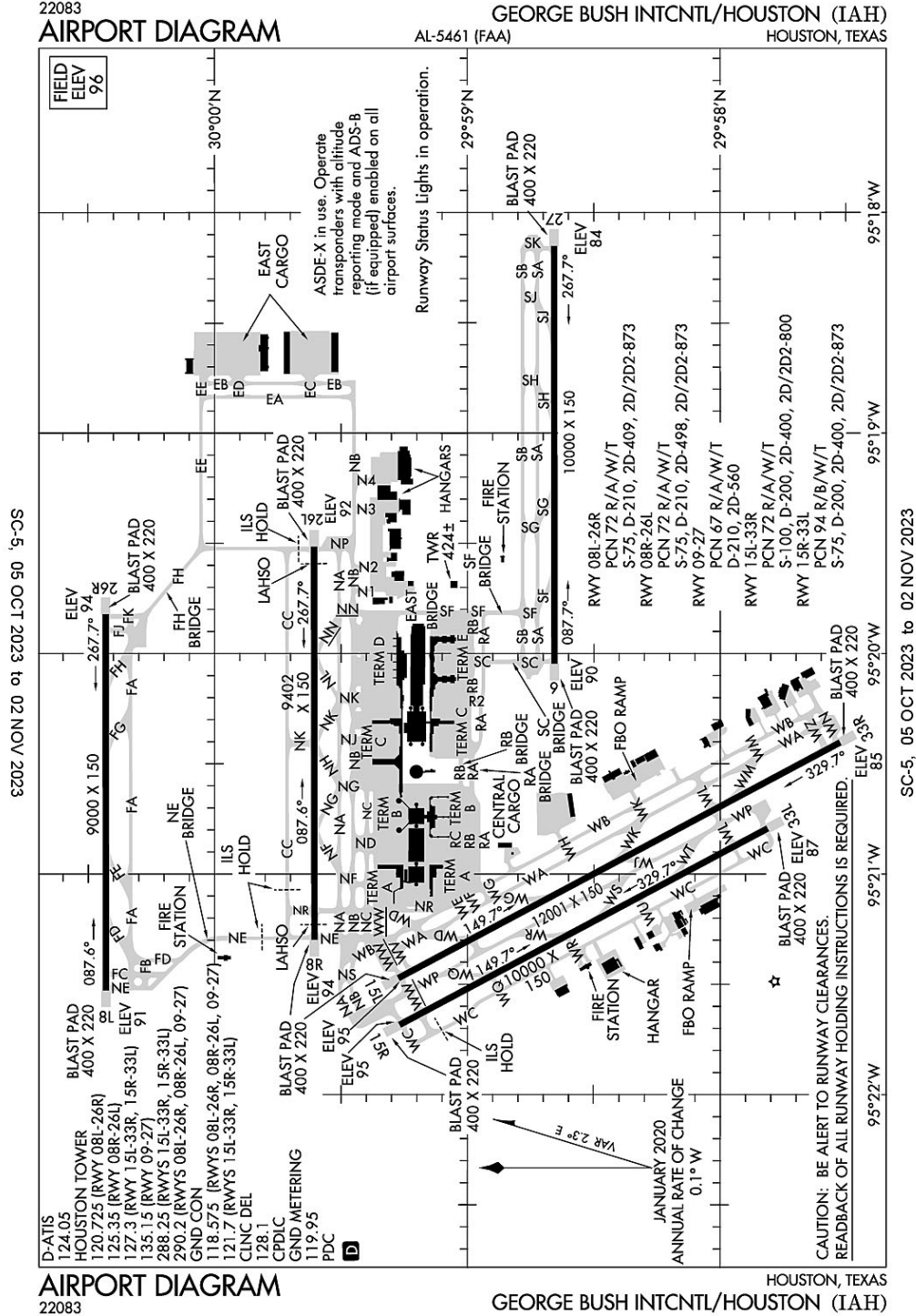
HOLDING POSITION MARKINGS FOR RUNWAY 8R APPROACH AND RUNWAY 4/22 ARE IN CLOSE PROXIMITY TO THE TERMINAL APRON; REVIEW AIRPORT DIAGRAM PRIOR TO PUSHBACK FROM THE GATE.

MILITARY USERS SHOULD REVIEW NOISE ABATEMENT PROCEDURES LISTED FOR BIGGS AAF.

NORTH BOUND TFC PROHIBITED ON TWY F SOUTH OF APCH END RWY 08R.

24 HR PPR CLASS A EXPLOSIVES CTC 915-212-0333.

Houston, Texas  
George Bush Intercontinental/Houston  
ICAO Identifier KIAH



**Houston, TX**  
**George Bush Intercontinental/Houston**  
**ICAO Identifier KIAH**

**AD 2.2 Aerodrome geographical and administrative data**

- 2.2.1 Reference Point: 29-59-3.967N / 95-20-29.193W
- 2.2.2 From City: 15 miles N of HOUSTON, TX
- 2.2.3 Elevation: 95.8 ft
- 2.2.5 Magnetic Variation: 3E (2015)
- 2.2.6 Airport Contact: STEVEN RUNGE  
PO BOX 60106  
HOUSTON, TX 77205 (281-233-1131)
- 2.2.7 Traffic: IFR/VFR

**AD 2.3 Attendance Schedule**

- 2.3.1 All Months, All Days, All Hours

**AD 2.4 Handling Services and Facilities**

- 2.4.1 Cargo Handling Facilities: YES
- 2.4.2 Fuel Types: 100LL,A
- 2.4.5 Hangar Space: YES
- 2.4.6 Repair Facilities: MAJOR

**AD 2.6 Rescue and Firefighting Services**

- 2.6.1 Aerodrome Category: Class-I certified on 5/1/1973
- 2.6.2 Rescue and Firefighting Services: ARFF Index-E

**AD 2.12 Runway Physical Characteristics**

- 2.12.1 Designation: 08L
- 2.12.2 True Bearing: 90
- 2.12.3 Dimensions: 9000 ft x 150 ft
- 2.12.4 PCN: 72 R/A/W/T
- 2.12.5 Coordinates: 30-0-25.7816N / 95-21-31.6473W
- 2.12.6 Threshold Elevation: 90.6 ft
- 2.12.6 Touchdown Zone Elevation: 94 ft
  
- 2.12.1 Designation: 26R
- 2.12.2 True Bearing: 270
- 2.12.3 Dimensions: 9000 ft x 150 ft
- 2.12.4 PCN: 72 R/A/W/T
- 2.12.5 Coordinates: 30-0-25.8612N / 95-19-49.2891W
- 2.12.6 Threshold Elevation: 94.2 ft
- 2.12.6 Touchdown Zone Elevation: 95.3 ft
  
- 2.12.1 Designation: 08R
- 2.12.2 True Bearing: 90
- 2.12.3 Dimensions: 9402 ft x 150 ft
- 2.12.4 PCN: 72 R/A/W/T
- 2.12.5 Coordinates: 29-59-36.3028N / 95-21-17.8703W
- 2.12.6 Threshold Elevation: 94.3 ft
- 2.12.6 Touchdown Zone Elevation: 95.3 ft

2.12.1 Designation: 26L  
2.12.2 True Bearing: 270  
2.12.3 Dimensions: 9402 ft x 150 ft  
2.12.4 PCN: 72 R/A/W/T  
2.12.5 Coordinates: 29-59-36.3817N / 95-19-30.9539W  
2.12.6 Threshold Elevation: 92.3 ft  
2.12.6 Touchdown Zone Elevation: 94.6 ft

2.12.1 Designation: 09  
2.12.2 True Bearing: 90  
2.12.3 Dimensions: 10000 ft x 150 ft  
2.12.4 PCN: 67 R/A/W/T  
2.12.5 Coordinates: 29-58-39.3363N / 95-20-2.7891W  
2.12.6 Threshold Elevation: 89.9 ft  
2.12.6 Touchdown Zone Elevation: 90.1 ft

2.12.1 Designation: 27  
2.12.2 True Bearing: 270  
2.12.3 Dimensions: 10000 ft x 150 ft  
2.12.4 PCN: 67 R/A/W/T  
2.12.5 Coordinates: 29-58-39.4071N / 95-18-9.0948W  
2.12.6 Threshold Elevation: 84.3 ft  
2.12.6 Touchdown Zone Elevation: 86.2 ft

2.12.1 Designation: 33R  
2.12.2 True Bearing: 332  
2.12.3 Dimensions: 12001 ft x 150 ft  
2.12.4 PCN: 72 R/A/W/T  
2.12.5 Coordinates: 29-57-31.5505N / 95-20-24.189W  
2.12.6 Threshold Elevation: 84.9 ft  
2.12.6 Touchdown Zone Elevation: 88 ft

2.12.1 Designation: 15L  
2.12.2 True Bearing: 152  
2.12.3 Dimensions: 12001 ft x 150 ft  
2.12.4 PCN: 72 R/A/W/T  
2.12.5 Coordinates: 29-59-16.4026N / 95-21-28.3335W  
2.12.6 Threshold Elevation: 94.6 ft  
2.12.6 Touchdown Zone Elevation: 95.2 ft

2.12.1 Designation: 33L  
2.12.2 True Bearing: 332  
2.12.3 Dimensions: 10000 ft x 150 ft  
2.12.4 PCN: 94 R/B/W/T  
2.12.5 Coordinates: 29-57-48.7474N / 95-20-47.5811W  
2.12.6 Threshold Elevation: 86.5 ft  
2.12.6 Touchdown Zone Elevation: 89.3 ft

2.12.1 Designation: 15R  
2.12.2 True Bearing: 152

- 2.12.3 Dimensions: 10000 ft x 150 ft
- 2.12.4 PCN: 94 R/B/W/T
- 2.12.5 Coordinates: 29-59-16.1082N / 95-21-41.0384W
- 2.12.6 Threshold Elevation: 94.8 ft
- 2.12.6 Touchdown Zone Elevation: 94.8 ft

**AD 2.13 Declared Distances**

- 2.13.1 Designation: 08L
- 2.13.2 Take-off Run Available: 9000
- 2.13.3 Take-off Distance Available: 9000
- 2.13.4 Accelerate-Stop Distance Available: 9000
- 2.13.5 Landing Distance Available: 9000

- 2.13.1 Designation: 26R
- 2.13.2 Take-off Run Available: 9000
- 2.13.3 Take-off Distance Available: 9000
- 2.13.4 Accelerate-Stop Distance Available: 9000
- 2.13.5 Landing Distance Available: 9000

- 2.13.1 Designation: 08R
- 2.13.2 Take-off Run Available: 9402
- 2.13.3 Take-off Distance Available: 9402
- 2.13.4 Accelerate-Stop Distance Available: 9402
- 2.13.5 Landing Distance Available: 9402

- 2.13.1 Designation: 26L
- 2.13.2 Take-off Run Available: 9402
- 2.13.3 Take-off Distance Available: 9402
- 2.13.4 Accelerate-Stop Distance Available: 9402
- 2.13.5 Landing Distance Available: 9402

- 2.13.1 Designation: 09
- 2.13.2 Take-off Run Available: 10000
- 2.13.3 Take-off Distance Available: 10000
- 2.13.4 Accelerate-Stop Distance Available: 10000
- 2.13.5 Landing Distance Available: 10000

- 2.13.1 Designation: 27
- 2.13.2 Take-off Run Available: 10000
- 2.13.3 Take-off Distance Available: 10000
- 2.13.4 Accelerate-Stop Distance Available: 10000
- 2.13.5 Landing Distance Available: 10000

- 2.13.1 Designation: 33R
- 2.13.2 Take-off Run Available: 12001
- 2.13.3 Take-off Distance Available: 12001
- 2.13.4 Accelerate-Stop Distance Available: 12001
- 2.13.5 Landing Distance Available: 12001

- 2.13.1 Designation: 15L

2.13.2 Take-off Run Available: 12001  
2.13.3 Take-off Distance Available: 12001  
2.13.4 Accelerate-Stop Distance Available: 12001  
2.13.5 Landing Distance Available: 12001

2.13.1 Designation: 33L  
2.13.2 Take-off Run Available: 9999  
2.13.3 Take-off Distance Available: 9999  
2.13.4 Accelerate-Stop Distance Available: 9999  
2.13.5 Landing Distance Available: 9999

2.13.1 Designation: 15R  
2.13.2 Take-off Run Available: 9999  
2.13.3 Take-off Distance Available: 9999  
2.13.4 Accelerate-Stop Distance Available: 9999  
2.13.5 Landing Distance Available: 9999

#### **AD 2.14 Approach and Runway Lighting**

2.14.1 Designation: 08L  
2.14.2 Approach Lighting System: ALSF2  
2.14.4 Visual Approach Slope Indicator System:

2.14.1 Designation: 26R  
2.14.2 Approach Lighting System: ALSF2  
2.14.4 Visual Approach Slope Indicator System:

2.14.1 Designation: 08R  
2.14.2 Approach Lighting System: MALSR  
2.14.4 Visual Approach Slope Indicator System: P4L

2.14.1 Designation: 26L  
2.14.2 Approach Lighting System: ALSF2  
2.14.4 Visual Approach Slope Indicator System: P4R

2.14.1 Designation: 09  
2.14.2 Approach Lighting System: MALSR  
2.14.4 Visual Approach Slope Indicator System: P4R

2.14.1 Designation: 27  
2.14.2 Approach Lighting System: ALSF2  
2.14.4 Visual Approach Slope Indicator System: P4L

2.14.1 Designation: 33R  
2.14.2 Approach Lighting System: MALSR  
2.14.4 Visual Approach Slope Indicator System:

2.14.1 Designation: 15L  
2.14.2 Approach Lighting System:  
2.14.4 Visual Approach Slope Indicator System: P4R



2.14.1 Designation: 33L  
2.14.2 Approach Lighting System:  
2.14.4 Visual Approach Slope Indicator System: P4R

2.14.1 Designation: 15R  
2.14.2 Approach Lighting System: MALSR  
2.14.4 Visual Approach Slope Indicator System: P4L

**AD 2.18 Air Traffic Services Communication Facilities**

2.18.1 Service Designation: CD/P  
2.18.3 Channel: 128.1  
2.18.5 Hours of Operation: 24

2.18.1 Service Designation: D-ATIS  
2.18.3 Channel: 124.05  
2.18.5 Hours of Operation: 24

2.18.1 Service Designation: EMERG  
2.18.3 Channel: 121.5  
2.18.5 Hours of Operation:

2.18.1 Service Designation: GND METERING  
2.18.3 Channel: 119.95  
2.18.5 Hours of Operation: 24

2.18.1 Service Designation: GND/P (RWY 08L/26R, 08R/26L, 09/27)  
2.18.3 Channel: 118.575  
2.18.5 Hours of Operation: 24

2.18.1 Service Designation: GND/P (RWY 15L/33R, 15R/33L)  
2.18.3 Channel: 121.7  
2.18.5 Hours of Operation: 24

2.18.1 Service Designation: LCL/P (RWY 08L/26R)  
2.18.3 Channel: 120.725  
2.18.5 Hours of Operation: 24

2.18.1 Service Designation: LCL/P (RWY 08R/26L)  
2.18.3 Channel: 125.35  
2.18.5 Hours of Operation: 24

2.18.1 Service Designation: LCL/P (RWY 15L/33R, 15R/33L)  
2.18.3 Channel: 127.3  
2.18.5 Hours of Operation: 24

2.18.1 Service Designation: LCL/P (RWY 09/27)  
2.18.3 Channel: 135.15  
2.18.5 Hours of Operation: 24

2.18.1 Service Designation: LCL/P (RWY 15L/33R, 15R/33L)

2.18.3 Channel: 288.25  
2.18.5 Hours of Operation: 24

2.18.1 Service Designation: LCL/P (RWY 08L/26R, 08R/26L, 09/27)  
2.18.3 Channel: 290.2  
2.18.5 Hours of Operation: 24

**AD 2.19 Radio Navigation and Landing Aids**

2.19.1 ILS Type: DME for runway 08L. Magnetic variation: 3E  
2.19.2 ILS Identification: BZU  
2.19.5 Coordinates: 30-0-21.9187N / 95-21-44.0405W  
2.19.6 Site Elevation: 87.5 ft

2.19.1 ILS Type: Glide Slope for runway 08L. Magnetic variation: 3E  
2.19.2 ILS Identification: BZU  
2.19.5 Coordinates: 30-0-29.7528N / 95-21-18.6875W  
2.19.6 Site Elevation: 86 ft

2.19.1 ILS Type: Inner Marker for runway 08L. Magnetic variation: 3E  
2.19.2 ILS Identification: BZU  
2.19.5 Coordinates: 30-0-25.764N / 95-21-40.8592W  
2.19.6 Site Elevation: 90.8 ft

2.19.1 ILS Type: Localizer for runway 08L. Magnetic variation: 3E  
2.19.2 ILS Identification: BZU  
2.19.5 Coordinates: 30-0-25.8701N / 95-19-36.9727W  
2.19.6 Site Elevation: 94.4 ft

2.19.1 ILS Type: DME for runway 26R. Magnetic variation: 3E  
2.19.2 ILS Identification: OND  
2.19.5 Coordinates: 30-0-21.9187N / 95-21-44.0405W  
2.19.6 Site Elevation: 87.5 ft

2.19.1 ILS Type: Glide Slope for runway 26R. Magnetic variation: 3E  
2.19.2 ILS Identification: OND  
2.19.5 Coordinates: 30-0-29.8117N / 95-20-2.26W  
2.19.6 Site Elevation: 89.7 ft

2.19.1 ILS Type: Inner Marker for runway 26R. Magnetic variation: 3E  
2.19.2 ILS Identification: OND  
2.19.5 Coordinates: 30-0-25.8755N / 95-19-40.4195W  
2.19.6 Site Elevation: 94.4 ft

2.19.1 ILS Type: Localizer for runway 26R. Magnetic variation: 3E  
2.19.2 ILS Identification: OND  
2.19.5 Coordinates: 30-0-25.7696N / 95-21-43.9647W  
2.19.6 Site Elevation: 90.8 ft

2.19.1 ILS Type: DME for runway 08R. Magnetic variation: 3E  
2.19.2 ILS Identification: IAH

2.19.5 Coordinates: 29-59-38.9211N / 95-21-31.3127W

2.19.6 Site Elevation: 92.5 ft

2.19.1 ILS Type: Glide Slope for runway 08R. Magnetic variation: 3E

2.19.2 ILS Identification: IAH

2.19.5 Coordinates: 29-59-40.3184N / 95-21-6.0476W

2.19.6 Site Elevation: 88.8 ft

2.19.1 ILS Type: Localizer for runway 08R. Magnetic variation: 3E

2.19.2 ILS Identification: IAH

2.19.5 Coordinates: 29-59-36.3913N / 95-19-19.5749W

2.19.6 Site Elevation: 89.6 ft

2.19.1 ILS Type: DME for runway 26L. Magnetic variation: 3E

2.19.2 ILS Identification: JYV

2.19.5 Coordinates: 29-59-38.9211N / 95-21-31.3127W

2.19.6 Site Elevation: 92.5 ft

2.19.1 ILS Type: Glide Slope for runway 26L. Magnetic variation: 3E

2.19.2 ILS Identification: JYV

2.19.5 Coordinates: 29-59-39.5388N / 95-19-42.8056W

2.19.6 Site Elevation: 86.8 ft

2.19.1 ILS Type: Inner Marker for runway 26L. Magnetic variation: 3E

2.19.2 ILS Identification: JYV

2.19.5 Coordinates: 29-59-36.3841N / 95-19-20.5992W

2.19.6 Site Elevation: 89.2 ft

2.19.1 ILS Type: Localizer for runway 26L. Magnetic variation: 3E

2.19.2 ILS Identification: JYV

2.19.5 Coordinates: 29-59-36.2865N / 95-21-31.2791W

2.19.6 Site Elevation: 92.2 ft

2.19.1 ILS Type: DME for runway 09. Magnetic variation: 3E

2.19.2 ILS Identification: UYO

2.19.5 Coordinates: 29-58-35.3774N / 95-20-13.5882W

2.19.6 Site Elevation: 87.3 ft

2.19.1 ILS Type: Glide Slope for runway 09. Magnetic variation: 3E

2.19.2 ILS Identification: UYO

2.19.5 Coordinates: 29-58-35.3875N / 95-19-50.679W

2.19.6 Site Elevation: 85.3 ft

2.19.1 ILS Type: Localizer for runway 09. Magnetic variation: 3E

2.19.2 ILS Identification: UYO

2.19.5 Coordinates: 29-58-39.4132N / 95-17-57.578W

2.19.6 Site Elevation: 81 ft

2.19.1 ILS Type: DME for runway 27. Magnetic variation: 3E

2.19.2 ILS Identification: GHI

2.19.5 Coordinates: 29-58-35.3774N / 95-20-13.5882W

2.19.6 Site Elevation: 87.3 ft

2.19.1 ILS Type: Glide Slope for runway 27. Magnetic variation: 3E

2.19.2 ILS Identification: GHI

2.19.5 Coordinates: 29-58-35.4434N / 95-18-20.8578W

2.19.6 Site Elevation: 80 ft

2.19.1 ILS Type: Inner Marker for runway 27. Magnetic variation: 3E

2.19.2 ILS Identification: GHI

2.19.5 Coordinates: 29-58-39.4166N / 95-17-59.1664W

2.19.6 Site Elevation: 81.1 ft

2.19.1 ILS Type: Localizer for runway 27. Magnetic variation: 3E

2.19.2 ILS Identification: GHI

2.19.5 Coordinates: 29-58-39.3268N / 95-20-15.3338W

2.19.6 Site Elevation: 87.4 ft

2.19.1 ILS Type: Glide Slope for runway 33R. Magnetic variation: 3E

2.19.2 ILS Identification: CDG

2.19.5 Coordinates: 29-57-38.8144N / 95-20-33.4594W

2.19.6 Site Elevation: 80.4 ft

2.19.1 ILS Type: Localizer for runway 33R. Magnetic variation: 3E

2.19.2 ILS Identification: CDG

2.19.5 Coordinates: 29-59-31.6238N / 95-21-37.6444W

2.19.6 Site Elevation: 91.9 ft

2.19.1 ILS Type: Glide Slope for runway 15R. Magnetic variation: 3E

2.19.2 ILS Identification: LKM

2.19.5 Coordinates: 29-59-4.4118N / 95-21-39.0331W

2.19.6 Site Elevation: 89.9 ft

2.19.1 ILS Type: Localizer for runway 15R. Magnetic variation: 3E

2.19.2 ILS Identification: LKM

2.19.5 Coordinates: 29-57-39.3739N / 95-20-41.8496W

2.19.6 Site Elevation: 82.7 ft

2.19.1 Navigation Aid Type: VORTAC. Magnetic variation: 5E

2.19.2 Navigation Aid Identification: IAH

2.19.5 Coordinates: 29-57-24.9013N / 95-20-44.5885W

2.19.6 Site Elevation: 80.6 ft

**General Remarks:**

THE FLWG MOV AREAS ARE NOT VSB FM THE ATCT: PORTIONS OF TWYS 'WA' & 'WB' FM TWY 'WH' TO THE AER 33R; TWYS 'WA' & 'WB' FM TWY 'WD' NORTH FOR 400 FT; TWY 'WD' FM TWY 'WA' TO TWY 'NR'; TWY 'NR'; TWY 'WL' FM RWY 15L TO TWY 'WB' & TWY 'WM'.

TXLN 'RA', 'RB', 'RC', 'R2', AND TWY 'SC' NORTH OF TWY 'SB' ARE DSGND NON-MOVEMENT AREAS OPERD BY UAL RAMP CTL.

DUAL TWY OPNS TWY NK BTN TWY NB & NORTH RAMP; WEST CNTRLN RSTRD TO ACFT MAX WING SPANS 125 FT & EAST CNTRLN MAX WING SPANS 214 FT.

NORTH RAMP TAXILANE BTN TWYS NF & NR RSTRD TO ACFT WITH WING SPAN 125 FT & BLO.

RWY STATUS LGTS ARE IN OPN.

TWY WW BTN TWY NR AND TWY WB CLSD TO ACFT WINGSPAN MORE THAN 214 FT.

APRON TERMINAL ALPHA NORTH RAMP EAST-WEST TXL CLSD TO ACFT WINGSPAN MORE THAN 118 FT.

TWY 'SF' BTN TWY 'NB' AND TXL 'RA' IS DSGND NON-MOV AREA.

9 FT AGL UNMKD SECURITY FENCE ADJ TO FBO & CORPORATE BASE OPR RAMPS AND NONMOV AREA TXLS.

TWY SF BTN RWY 09/27 UP TO AND INCLUDING THE EAST BRIDGE CLSD TO ACFT WITH WINGSPAN 215 FT & OVER.

HEL HOVER/TAXI RSTRD TO HARD SFC MOV AREAS ONLY.

APRON TERMINAL ALPHA NORTH RAMP SPOT 5 CLSD TO ACFT WINGSPAN MORE THAN 118 FT.

TWY 'NR' CLSD TO ACFT WITH WING SPANS GREATER THAN 125 FT BTN TWY 'WD' & TWY 'WB'.

TWY WC WEST OF RWY 15R/33L RSTRD TO ACFT WITH 118 FT WING SPAN AND BLW.

TWY NR BTN TWY NC AND TWY WW CLSD TO ACFT WINGSPAN MORE THAN 214 FT.

TWY NR BTN WW AND TWY WB DSGND NON-MOVEMENT AREA.

TWY NA LGT ALL BTN TWY WP AND TWY NP NOT STD

APRON TERMINAL ALPHA NORTH RAMP SPOT 6 CLSD TO ACFT WINGSPAN MORE THAN 125 FT.

PILOTS & CREWS SHOULD BE AWARE OF DEP TURNS ON CRS IN EXCESS OF 180 DEGS. PILOT READ BACK OF DRCTN OF TURN IS HIGHLY ENCOURAGED.

TWYS WA & WB MAGNETIC ANOMALIES MAY AFFECT COMPASS HDG.

RWY 15L/33R MAGNETIC ANOMALIES MAY AFFECT COMPASS HDG FOR TKOF.

GBAS APCH SVC VOL 20NM FR THR, ALL GLS APCHS.

TWY WD BTN TWY NR AND TWY WB CLSD TO ACFT WINGSPAN MORE THAN 171 FT.

NORTH RAMP NORTH & SOUTH TAXI LANES CLSD TO ACFT WITH WING SPANS GREATER THAN 125 FT.

RWY 09/27 CLSD TO ACFT WITH WINGSPAN 215 FT & ABOVE.

TWY NJ BTN TWY NB AND TERMINAL C RAMP SIMULTANEOUS ACFT OPS PROHIBITED WHEN MIDDLE TAXILANE IN USE, MIDDLE TAXILANE CLSD TO ACFT WINGSPAN MORE THAN 214FT.

DUAL TWY OPNS TWY NJ BTN TWY NB & TERMINAL C RAMP; WEST CNTRLN RSTRD TO ACFT MAX WING SPANS 118 FT & EAST CNTRLN MAX WING SPANS 118 FT.

TXLN RC CLSD TO ACFT WITH WINGSPAN GREATER THAN 135 FT.

BIRDS ON & INVOF ARPT.

ASDE-X IN USE. OPERATE TRANSPONDERS WITH ALTITUDE REPORTING MODE AND ADS-B (IF EQUIPPED) ENABLED ON ALL AIRPORT SURFACES.

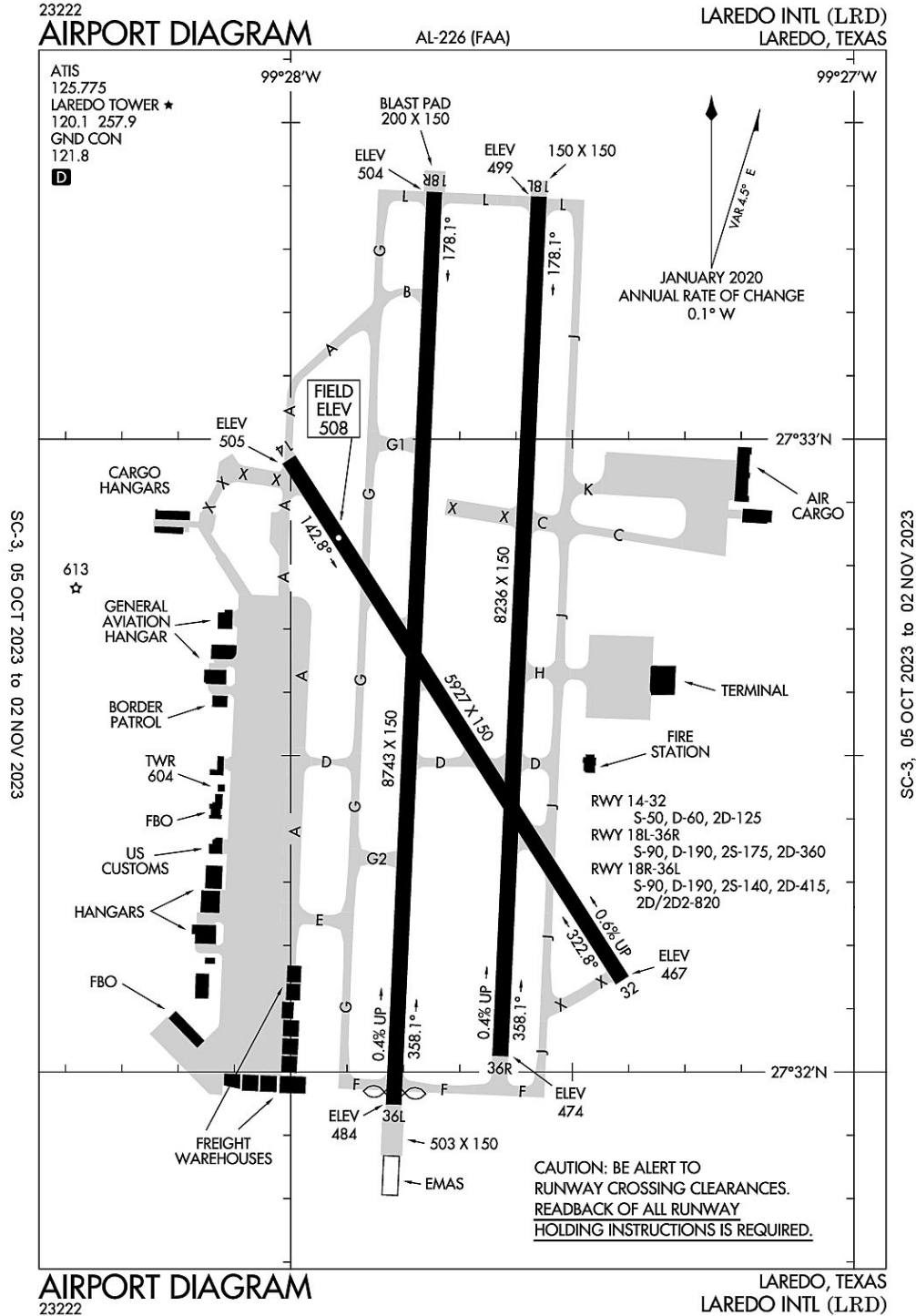
NOISE SENSITIVE AREA N, E AND W OF ARPT.

TWY WW RUN UP PAD FOR RWY 15L CLSD TO ACFT WITH WINGSPAN 135 FT & OVER.

WILDLIFE HAZ BATS INVOF IAH.

TWY NK BTN TWY NB AND TERMINAL D RAMP SIMULTANEOUS ACFT OPS PROHIBITED WHEN MIDDLE TAXILANE IN USE.

Laredo, Texas  
Laredo International  
ICAO Identifier KLRD



**Laredo, TX**  
**Laredo Intl**  
**ICAO Identifier KLRD**

**AD 2.2 Aerodrome geographical and administrative data**

- 2.2.1 Reference Point: 27-32-39.1N / 99-27-41.7W
- 2.2.2 From City: 3 miles NE of LAREDO, TX
- 2.2.3 Elevation: 508 ft
- 2.2.5 Magnetic Variation: 5E (2020)
- 2.2.6 Airport Contact: GILBERTO SANCHEZ  
5210 BOB BULLOCK LOOP  
LAREDO, TX 78041 (956-795-2000)
- 2.2.7 Traffic: IFR/VFR

**AD 2.3 Attendance Schedule**

- 2.3.1 All Months, All Days, All Hours

**AD 2.4 Handling Services and Facilities**

- 2.4.1 Cargo Handling Facilities: YES
- 2.4.2 Fuel Types: 100LL,A
- 2.4.5 Hangar Space: YES
- 2.4.6 Repair Facilities: None

**AD 2.6 Rescue and Firefighting Services**

- 2.6.1 Aerodrome Category: Class-I certified on 7/1/1975
- 2.6.2 Rescue and Firefighting Services: ARFF Index-B

**AD 2.12 Runway Physical Characteristics**

- 2.12.1 Designation: 32
- 2.12.2 True Bearing: 327
- 2.12.3 Dimensions: 5927 ft x 150 ft
- 2.12.4 PCN:
- 2.12.5 Coordinates: 27-32-8.635N / 99-27-24.668W
- 2.12.6 Threshold Elevation: 467.4 ft
- 2.12.6 Touchdown Zone Elevation: 493.6 ft
  
- 2.12.1 Designation: 14
- 2.12.2 True Bearing: 147
- 2.12.3 Dimensions: 5927 ft x 150 ft
- 2.12.4 PCN:
- 2.12.5 Coordinates: 27-32-58.0248N / 99-28-0.2242W
- 2.12.6 Threshold Elevation: 505.4 ft
- 2.12.6 Touchdown Zone Elevation: 508 ft
  
- 2.12.1 Designation: 18L



2.12.2 True Bearing: 183  
2.12.3 Dimensions: 8236 ft x 150 ft  
2.12.4 PCN:  
2.12.5 Coordinates: 27-33-22.9267N / 99-27-33.5988W  
2.12.6 Threshold Elevation: 499.2 ft  
2.12.6 Touchdown Zone Elevation: 499.2 ft

2.12.1 Designation: 36R  
2.12.2 True Bearing: 3  
2.12.3 Dimensions: 8236 ft x 150 ft  
2.12.4 PCN:  
2.12.5 Coordinates: 27-32-1.4547N / 99-27-37.6934W  
2.12.6 Threshold Elevation: 474.2 ft  
2.12.6 Touchdown Zone Elevation: 486.7 ft

2.12.1 Designation: 36L  
2.12.2 True Bearing: 3  
2.12.3 Dimensions: 8743 ft x 150 ft  
2.12.4 PCN:  
2.12.5 Coordinates: 27-31-56.8817N / 99-27-49.0449W  
2.12.6 Threshold Elevation: 483.7 ft  
2.12.6 Touchdown Zone Elevation: 497 ft

2.12.1 Designation: 18R  
2.12.2 True Bearing: 183  
2.12.3 Dimensions: 8743 ft x 150 ft  
2.12.4 PCN:  
2.12.5 Coordinates: 27-33-23.3681N / 99-27-44.7128W  
2.12.6 Threshold Elevation: 503.7 ft  
2.12.6 Touchdown Zone Elevation: 503.7 ft

### **AD 2.13 Declared Distances**

2.13.1 Designation: 32  
2.13.2 Take-off Run Available: 5927  
2.13.3 Take-off Distance Available: 5927  
2.13.4 Accelerate-Stop Distance Available: 5927  
2.13.5 Landing Distance Available: 5927

2.13.1 Designation: 14  
2.13.2 Take-off Run Available: 5927  
2.13.3 Take-off Distance Available: 5927  
2.13.4 Accelerate-Stop Distance Available: 5927  
2.13.5 Landing Distance Available: 5927

- 2.13.1 Designation: 18L
- 2.13.2 Take-off Run Available: 8236
- 2.13.3 Take-off Distance Available: 8236
- 2.13.4 Accelerate-Stop Distance Available: 8236
- 2.13.5 Landing Distance Available: 8236

- 2.13.1 Designation: 36R
- 2.13.2 Take-off Run Available: 8236
- 2.13.3 Take-off Distance Available: 8236
- 2.13.4 Accelerate-Stop Distance Available: 8236
- 2.13.5 Landing Distance Available: 8236

- 2.13.1 Designation: 36L
- 2.13.2 Take-off Run Available: 8743
- 2.13.3 Take-off Distance Available: 8743
- 2.13.4 Accelerate-Stop Distance Available: 8743
- 2.13.5 Landing Distance Available: 8623

- 2.13.1 Designation: 18R
- 2.13.2 Take-off Run Available: 8743
- 2.13.3 Take-off Distance Available: 8743
- 2.13.4 Accelerate-Stop Distance Available: 8743
- 2.13.5 Landing Distance Available: 8743

#### **AD 2.14 Approach and Runway Lighting**

- 2.14.1 Designation: 32
- 2.14.2 Approach Lighting System:
- 2.14.4 Visual Approach Slope Indicator System: V4L

- 2.14.1 Designation: 14
- 2.14.2 Approach Lighting System:
- 2.14.4 Visual Approach Slope Indicator System: V4L

- 2.14.1 Designation: 18L
- 2.14.2 Approach Lighting System:
- 2.14.4 Visual Approach Slope Indicator System: P4L

- 2.14.1 Designation: 36R
- 2.14.2 Approach Lighting System:
- 2.14.4 Visual Approach Slope Indicator System:

- 2.14.1 Designation: 36L

2.14.2 Approach Lighting System:  
2.14.4 Visual Approach Slope Indicator System: P4L

2.14.1 Designation: 18R  
2.14.2 Approach Lighting System: MALSR  
2.14.4 Visual Approach Slope Indicator System: P4L

### **AD 2.18 Air Traffic Services Communication Facilities**

2.18.1 Service Designation: ATIS  
2.18.3 Channel: 125.775  
2.18.5 Hours of Operation: 24

2.18.1 Service Designation: EMERG  
2.18.3 Channel: 243  
2.18.5 Hours of Operation:

2.18.1 Service Designation: GND/P  
2.18.3 Channel: 121.8  
2.18.5 Hours of Operation: 0600-2400

2.18.1 Service Designation: LCL/P  
2.18.3 Channel: 120.1  
2.18.5 Hours of Operation: 0600-2400

2.18.1 Service Designation: LCL/P  
2.18.3 Channel: 257.9  
2.18.5 Hours of Operation: 0600-2400

### **AD 2.19 Radio Navigation and Landing Aids**

2.19.1 ILS Type: DME for runway 18R. Magnetic variation: 5E  
2.19.2 ILS Identification: LRD  
2.19.5 Coordinates: 27-31-50.8814N / 99-27-46.6673W  
2.19.6 Site Elevation: 477 ft

2.19.1 ILS Type: Glide Slope for runway 18R. Magnetic variation: 5E  
2.19.2 ILS Identification: LRD  
2.19.5 Coordinates: 27-33-12.4993N / 99-27-40.6967W  
2.19.6 Site Elevation: 497 ft

2.19.1 ILS Type: Localizer for runway 18R. Magnetic variation: 5E  
2.19.2 ILS Identification: LRD  
2.19.5 Coordinates: 27-31-51.7421N / 99-27-49.3028W

2.19.6 Site Elevation: 477 ft

2.19.1 Navigation Aid Type: VORTAC. Magnetic variation: 9E

2.19.2 Navigation Aid Identification: LRD

2.19.5 Coordinates: 27-28-43.4544N / 99-25-3.6441W

2.19.6 Site Elevation: 583 ft

**General Remarks:**

RWY 14/32 RSTRD TO ACFT LESS THAN 60000 LBS DTW.

BIRDS ON AND INVOF ARPT.

FEDERAL INSPECTION STATION FEE.

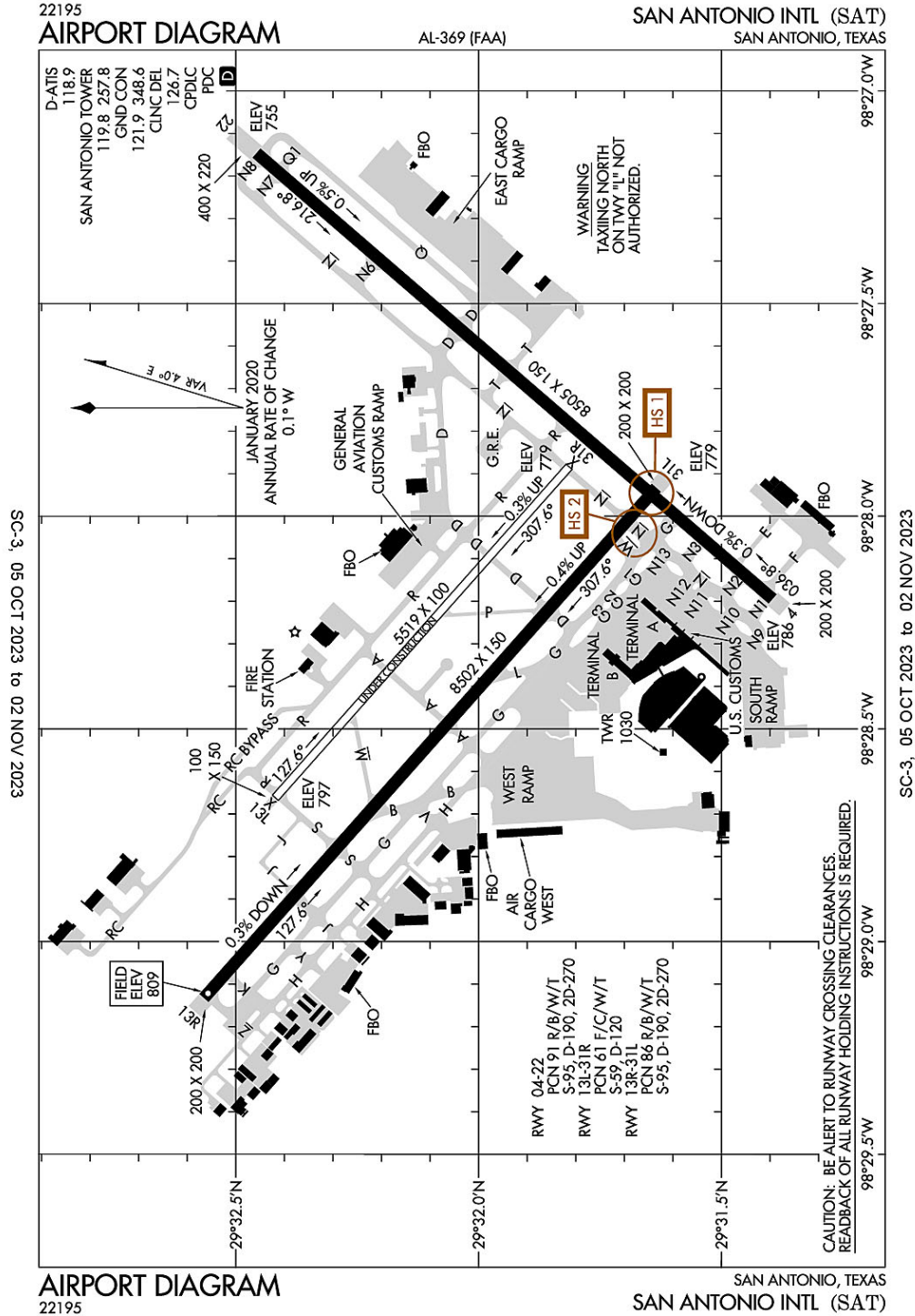
FOR CD IF UNA TO CTC ON FSS FREQ, CTC HOUSTON ARTCC AT 281-230-5622.

TWY C CLSD BTN RWY 18L/36R & RWY 18R INDEFLY.

FEDERAL INSPECTION STATION IS LCTD ON THE WEST GENERAL AVIATION/CARGO APRON.

LNDG FEE ASSESSED FOR ANY "FOR HIRE" ACFT.

San Antonio, Texas  
San Antonio International  
ICAO Identifier KSAT



**San Antonio, TX**  
**San Antonio Intl**  
**ICAO Identifier KSAT**

**AD 2.2 Aerodrome geographical and administrative data**

- 2.2.1 Reference Point: 29-32-2.25N / 98-28-8.605W
- 2.2.2 From City: 7 miles N of SAN ANTONIO, TX
- 2.2.3 Elevation: 809.1 ft
- 2.2.5 Magnetic Variation: 4E (2020)
- 2.2.6 Airport Contact: JESUS H. SAENZ, JR.  
9800 AIRPORT BLVD  
SAN ANTONIO, TX 78216 (210-207-3444)
- 2.2.7 Traffic: IFR/VFR

**AD 2.3 Attendance Schedule**

- 2.3.1 All Months, All Days, All Hours

**AD 2.4 Handling Services and Facilities**

- 2.4.1 Cargo Handling Facilities: YES
- 2.4.2 Fuel Types: 100LL,A
- 2.4.5 Hangar Space: YES
- 2.4.6 Repair Facilities: MAJOR

**AD 2.6 Rescue and Firefighting Services**

- 2.6.1 Aerodrome Category: Class-I certified on 5/1/1973
- 2.6.2 Rescue and Firefighting Services: ARFF Index-C

**AD 2.12 Runway Physical Characteristics**

- 2.12.1 Designation: 04
- 2.12.2 True Bearing: 41
- 2.12.3 Dimensions: 8505 ft x 150 ft
- 2.12.4 PCN: 91 R/B/W/T
- 2.12.5 Coordinates: 29-31-23.6409N / 98-28-11.6562W
- 2.12.6 Threshold Elevation: 786 ft
- 2.12.6 Touchdown Zone Elevation: 786 ft

- 2.12.1 Designation: 22
- 2.12.2 True Bearing: 221
- 2.12.3 Dimensions: 8505 ft x 150 ft
- 2.12.4 PCN: 91 R/B/W/T
- 2.12.5 Coordinates: 29-32-27.3928N / 98-27-8.7715W
- 2.12.6 Threshold Elevation: 754.5 ft
- 2.12.6 Touchdown Zone Elevation: 770 ft

- 2.12.1 Designation: 31R

2.12.2 True Bearing: 312  
2.12.3 Dimensions: 5519 ft x 100 ft  
2.12.4 PCN: 61 F/C/W/T  
2.12.5 Coordinates: 29-31-48.7812N / 98-27-53.0202W  
2.12.6 Threshold Elevation: 779.2 ft  
2.12.6 Touchdown Zone Elevation: 788.1 ft

2.12.1 Designation: 13L  
2.12.2 True Bearing: 132  
2.12.3 Dimensions: 5519 ft x 100 ft  
2.12.4 PCN: 61 F/C/W/T  
2.12.5 Coordinates: 29-32-25.0764N / 98-28-39.714W  
2.12.6 Threshold Elevation: 797.3 ft  
2.12.6 Touchdown Zone Elevation: 797.3 ft

2.12.1 Designation: 31L  
2.12.2 True Bearing: 312  
2.12.3 Dimensions: 8502 ft x 150 ft  
2.12.4 PCN: 86 R/B/W/T  
2.12.5 Coordinates: 29-31-38.0038N / 98-27-55.9932W  
2.12.6 Threshold Elevation: 778.5 ft  
2.12.6 Touchdown Zone Elevation: 790 ft

2.12.1 Designation: 13R  
2.12.2 True Bearing: 132  
2.12.3 Dimensions: 8502 ft x 150 ft  
2.12.4 PCN: 86 R/B/W/T  
2.12.5 Coordinates: 29-32-33.8853N / 98-29-7.9481W  
2.12.6 Threshold Elevation: 809.1 ft  
2.12.6 Touchdown Zone Elevation: 809.1 ft

### **AD 2.13 Declared Distances**

2.13.1 Designation: 04  
2.13.2 Take-off Run Available: 8505  
2.13.3 Take-off Distance Available: 8505  
2.13.4 Accelerate-Stop Distance Available: 8505  
2.13.5 Landing Distance Available: 8505

2.13.1 Designation: 22  
2.13.2 Take-off Run Available: 8505  
2.13.3 Take-off Distance Available: 8505  
2.13.4 Accelerate-Stop Distance Available: 8505  
2.13.5 Landing Distance Available: 8505

- 2.13.1 Designation: 31R
- 2.13.2 Take-off Run Available: 5519
- 2.13.3 Take-off Distance Available: 5519
- 2.13.4 Accelerate-Stop Distance Available: 5519
- 2.13.5 Landing Distance Available: 5519

- 2.13.1 Designation: 13L
- 2.13.2 Take-off Run Available: 5519
- 2.13.3 Take-off Distance Available: 5519
- 2.13.4 Accelerate-Stop Distance Available: 5519
- 2.13.5 Landing Distance Available: 5519

- 2.13.1 Designation: 31L
- 2.13.2 Take-off Run Available: 8502
- 2.13.3 Take-off Distance Available: 8502
- 2.13.4 Accelerate-Stop Distance Available: 8502
- 2.13.5 Landing Distance Available: 8502

- 2.13.1 Designation: 13R
- 2.13.2 Take-off Run Available: 8502
- 2.13.3 Take-off Distance Available: 8502
- 2.13.4 Accelerate-Stop Distance Available: 8502
- 2.13.5 Landing Distance Available: 8502

#### **AD 2.14 Approach and Runway Lighting**

- 2.14.1 Designation: 04
- 2.14.2 Approach Lighting System: MALS
- 2.14.4 Visual Approach Slope Indicator System: P4R

- 2.14.1 Designation: 22
- 2.14.2 Approach Lighting System:
- 2.14.4 Visual Approach Slope Indicator System: P4L

- 2.14.1 Designation: 31R
- 2.14.2 Approach Lighting System:
- 2.14.4 Visual Approach Slope Indicator System: P4L

- 2.14.1 Designation: 13L
- 2.14.2 Approach Lighting System:
- 2.14.4 Visual Approach Slope Indicator System: P4L

- 2.14.1 Designation: 31L



2.14.2 Approach Lighting System: MALSR  
2.14.4 Visual Approach Slope Indicator System: P4L

2.14.1 Designation: 13R  
2.14.2 Approach Lighting System: ALSF2  
2.14.4 Visual Approach Slope Indicator System: P4L

**AD 2.18 Air Traffic Services Communication Facilities**

2.18.1 Service Designation: ALAMO DP (RWY 04, 22, 31)  
2.18.3 Channel: 125.1  
2.18.5 Hours of Operation: 24

2.18.1 Service Designation: ALAMO DP (RWY 13)  
2.18.3 Channel: 127.1  
2.18.5 Hours of Operation: 24

2.18.1 Service Designation: ALAMO DP (RWY 13)  
2.18.3 Channel: 269.1  
2.18.5 Hours of Operation: 24

2.18.1 Service Designation: ALAMO DP (RWY 04, 22, 31)  
2.18.3 Channel: 307  
2.18.5 Hours of Operation: 24

2.18.1 Service Designation: ALISS DP (RWY 04, 22, 31)  
2.18.3 Channel: 125.1  
2.18.5 Hours of Operation: 24

2.18.1 Service Designation: ALISS DP (RWY 13)  
2.18.3 Channel: 125.7  
2.18.5 Hours of Operation: 24

2.18.1 Service Designation: ALISS DP (RWY 13)  
2.18.3 Channel: 290.225  
2.18.5 Hours of Operation: 24

2.18.1 Service Designation: APCH/P  
2.18.3 Channel: 121.375  
2.18.5 Hours of Operation: 24

2.18.1 Service Designation: APCH/P (115-154/35-56 SAT)  
2.18.3 Channel: 257.625  
2.18.5 Hours of Operation: 24

2.18.1 Service Designation: APCH/P DEP/P (141-270)  
2.18.3 Channel: 118.05  
2.18.5 Hours of Operation: 24

2.18.1 Service Designation: APCH/P DEP/P (360-090)  
2.18.3 Channel: 124.45  
2.18.5 Hours of Operation: 24

2.18.1 Service Designation: APCH/P DEP/P (091-140)  
2.18.3 Channel: 128.05  
2.18.5 Hours of Operation: 24

2.18.1 Service Designation: APCH/P DEP/P (091-140)  
2.18.3 Channel: 318.1  
2.18.5 Hours of Operation: 24

2.18.1 Service Designation: APCH/P DEP/P (360-090)  
2.18.3 Channel: 335.625  
2.18.5 Hours of Operation: 24

2.18.1 Service Designation: APCH/P DEP/P (141-270)  
2.18.3 Channel: 353.5  
2.18.5 Hours of Operation: 24

2.18.1 Service Designation: APCH/P DEP/P IC (271-359)  
2.18.3 Channel: 125.1  
2.18.5 Hours of Operation: 24

2.18.1 Service Designation: APCH/P DEP/P IC (271-359)  
2.18.3 Channel: 307  
2.18.5 Hours of Operation: 24

2.18.1 Service Designation: APCH/S DEP/S  
2.18.3 Channel: 125.7  
2.18.5 Hours of Operation: 24

2.18.1 Service Designation: APCH/S DEP/S  
2.18.3 Channel: 127.1  
2.18.5 Hours of Operation: 24

2.18.1 Service Designation: APCH/S DEP/S  
2.18.3 Channel: 251.125  
2.18.5 Hours of Operation: 24

2.18.1 Service Designation: APCH/S DEP/S

2.18.3 Channel: 290.225

2.18.5 Hours of Operation: 24

2.18.1 Service Designation: BOWIE DP (RWY 04 LRD TRANSITION)

2.18.3 Channel: 125.1

2.18.5 Hours of Operation: 24

2.18.1 Service Designation: BOWIE DP (RWY 13, 22, 31)

2.18.3 Channel: 125.7

2.18.5 Hours of Operation: 24

2.18.1 Service Designation: BOWIE DP (RWY 04 CRP TRANSITION)

2.18.3 Channel: 127.1

2.18.5 Hours of Operation: 24

2.18.1 Service Designation: BOWIE DP (RWY 04 CRP TRANSITION)

2.18.3 Channel: 269.1

2.18.5 Hours of Operation: 24

2.18.1 Service Designation: BOWIE DP (RWY 04, 13, 31)

2.18.3 Channel: 290.225

2.18.5 Hours of Operation: 24

2.18.1 Service Designation: BOWIE DP (RWY 04 LRD TRANSITION)

2.18.3 Channel: 307

2.18.5 Hours of Operation: 24

2.18.1 Service Designation: BRAUN STAR

2.18.3 Channel: 127.1

2.18.5 Hours of Operation: 24

2.18.1 Service Designation: BRAUN STAR

2.18.3 Channel: 269.1

2.18.5 Hours of Operation: 24

2.18.1 Service Designation: CD/P

2.18.3 Channel: 126.7

2.18.5 Hours of Operation: 24

2.18.1 Service Designation: CENTERPOINT STAR (RWY 13R, 22)

2.18.3 Channel: 125.1

2.18.5 Hours of Operation: 24

2.18.1 Service Designation: CENTERPOINT STAR (RWY 04, 31L)

2.18.3 Channel: 125.7

2.18.5 Hours of Operation: 24

2.18.1 Service Designation: CENTERPOINT STAR (RWY 04, 31L)

2.18.3 Channel: 290.225

2.18.5 Hours of Operation: 24

2.18.1 Service Designation: CENTERPOINT STAR (RWY 13R, 22)

2.18.3 Channel: 307

2.18.5 Hours of Operation: 24

2.18.1 Service Designation: CLASS C (141-270)

2.18.3 Channel: 118.05

2.18.5 Hours of Operation: 24

2.18.1 Service Designation: CLASS C (360-090)

2.18.3 Channel: 124.45

2.18.5 Hours of Operation: 24

2.18.1 Service Designation: CLASS C (271-359)

2.18.3 Channel: 125.1

2.18.5 Hours of Operation: 24

2.18.1 Service Designation: CLASS C (091-140)

2.18.3 Channel: 128.05

2.18.5 Hours of Operation: 24

2.18.1 Service Designation: CLASS C (271-359)

2.18.3 Channel: 307

2.18.5 Hours of Operation: 24

2.18.1 Service Designation: CLASS C (091-140)

2.18.3 Channel: 318.1

2.18.5 Hours of Operation: 24

2.18.1 Service Designation: CLASS C (360-090)

2.18.3 Channel: 335.625

2.18.5 Hours of Operation: 24

2.18.1 Service Designation: CLASS C (141-270)

2.18.3 Channel: 353.5

2.18.5 Hours of Operation: 24

2.18.1 Service Designation: D-ATIS

2.18.3 Channel: 118.9

2.18.5 Hours of Operation: 24

2.18.1 Service Designation: EMERG

2.18.3 Channel: 121.5

2.18.5 Hours of Operation:

2.18.1 Service Designation: EMERG

2.18.3 Channel: 243

2.18.5 Hours of Operation:

2.18.1 Service Designation: GND/P

2.18.3 Channel: 121.9

2.18.5 Hours of Operation: 24

2.18.1 Service Designation: GND/P

2.18.3 Channel: 348.6

2.18.5 Hours of Operation: 24

2.18.1 Service Designation: LCL/P

2.18.3 Channel: 119.8

2.18.5 Hours of Operation: 24

2.18.1 Service Designation: LCL/P

2.18.3 Channel: 257.8

2.18.5 Hours of Operation: 24

2.18.1 Service Designation: LEJON DP (RWY 04, 22, 31)

2.18.3 Channel: 125.1

2.18.5 Hours of Operation: 24

2.18.1 Service Designation: LEJON DP (RWY 13)

2.18.3 Channel: 125.7

2.18.5 Hours of Operation: 24

2.18.1 Service Designation: LEJON DP (RWY 12)

2.18.3 Channel: 290.225

2.18.5 Hours of Operation: 24

2.18.1 Service Designation: LEJON DP (RWY 13)

2.18.3 Channel: 290.225

2.18.5 Hours of Operation: 24

2.18.1 Service Designation: LEJON DP (RWY 04, 22, 31)  
2.18.3 Channel: 307  
2.18.5 Hours of Operation: 24

2.18.1 Service Designation: LEMIG STAR  
2.18.3 Channel: 125.7  
2.18.5 Hours of Operation: 24

2.18.1 Service Designation: LEMIG STAR  
2.18.3 Channel: 290.225  
2.18.5 Hours of Operation: 24

2.18.1 Service Designation: MARCS STAR  
2.18.3 Channel: 127.1  
2.18.5 Hours of Operation: 24

2.18.1 Service Designation: MARCS STAR  
2.18.3 Channel: 269.1  
2.18.5 Hours of Operation: 24

2.18.1 Service Designation: MILET DP (RWY 04)  
2.18.3 Channel: 125.1  
2.18.5 Hours of Operation: 24

2.18.1 Service Designation: MILET DP (RWY 13, 22, 31)  
2.18.3 Channel: 125.7  
2.18.5 Hours of Operation: 24

2.18.1 Service Designation: MILET DP (RWY 13, 22, 31)  
2.18.3 Channel: 290.225  
2.18.5 Hours of Operation: 24

2.18.1 Service Designation: MILET DP (RWY 04)  
2.18.3 Channel: 307  
2.18.5 Hours of Operation: 24

2.18.1 Service Designation: STONEWALL STAR  
2.18.3 Channel: 125.1  
2.18.5 Hours of Operation: 24

2.18.1 Service Designation: STONEWALL STAR  
2.18.3 Channel: 307  
2.18.5 Hours of Operation: 24

2.18.1 Service Designation: THREE RIVERS DP (RWY 13, 22, 31)

2.18.3 Channel: 125.7

2.18.5 Hours of Operation: 24

2.18.1 Service Designation: THREE RIVERS DP (RWY 04)

2.18.3 Channel: 127.1

2.18.5 Hours of Operation: 24

2.18.1 Service Designation: THREE RIVERS DP (RWY 04)

2.18.3 Channel: 269.1

2.18.5 Hours of Operation: 24

2.18.1 Service Designation: THREE RIVERS DP (RWY 13, 22, 31)

2.18.3 Channel: 290.225

2.18.5 Hours of Operation: 24

#### **AD 2.19 Radio Navigation and Landing Aids**

2.19.1 ILS Type: DME for runway 04. Magnetic variation: 4E

2.19.2 ILS Identification: SAT

2.19.5 Coordinates: 29-32-32.9486N / 98-26-58.6881W

2.19.6 Site Elevation: 746.3 ft

2.19.1 ILS Type: Glide Slope for runway 04. Magnetic variation: 4E

2.19.2 ILS Identification: SAT

2.19.5 Coordinates: 29-31-30.2202N / 98-27-58.0715W

2.19.6 Site Elevation: 774.8 ft

2.19.1 ILS Type: Localizer for runway 04. Magnetic variation: 4E

2.19.2 ILS Identification: SAT

2.19.5 Coordinates: 29-32-35.0937N / 98-27-1.1714W

2.19.6 Site Elevation: 748.9 ft

2.19.1 ILS Type: DME for runway 13R. Magnetic variation: 4E

2.19.2 ILS Identification: ANT

2.19.5 Coordinates: 29-31-29.0932N / 98-27-49.9584W

2.19.6 Site Elevation: 790.7 ft

2.19.1 ILS Type: Glide Slope for runway 13R. Magnetic variation: 4E

2.19.2 ILS Identification: ANT

2.19.5 Coordinates: 29-32-28.9928N / 98-28-54.8202W

2.19.6 Site Elevation: 801.3 ft

2.19.1 ILS Type: Inner Marker for runway 13R. Magnetic variation: 4E

2.19.2 ILS Identification: ANT

2.19.5 Coordinates: 29-32-39.0383N / 98-29-14.595W

2.19.6 Site Elevation: 807.6 ft

2.19.1 ILS Type: Localizer for runway 13R. Magnetic variation: 4E

2.19.2 ILS Identification: ANT

2.19.5 Coordinates: 29-31-31.3122N / 98-27-47.3799W

2.19.6 Site Elevation: 771 ft

2.19.1 ILS Type: Outer Marker for runway 13R. Magnetic variation: 4E

2.19.2 ILS Identification: ANT

2.19.5 Coordinates: 29-36-27.2991N / 98-34-11.0119W

2.19.6 Site Elevation: 1054.4 ft

2.19.1 ILS Type: DME for runway 31L. Magnetic variation: 4E

2.19.2 ILS Identification: IZR

2.19.5 Coordinates: 29-31-29.0932N / 98-27-49.9584W

2.19.6 Site Elevation: 790.7 ft

2.19.1 ILS Type: Glide Slope for runway 31L. Magnetic variation: 4E

2.19.2 ILS Identification: IZR

2.19.5 Coordinates: 29-31-47.9039N / 98-28-1.9173W

2.19.6 Site Elevation: 777.5 ft

2.19.1 ILS Type: Localizer for runway 31L. Magnetic variation: 4E

2.19.2 ILS Identification: IZR

2.19.5 Coordinates: 29-32-43.1182N / 98-29-19.835W

2.19.6 Site Elevation: 813.4 ft

2.19.1 Navigation Aid Type: VORTAC. Magnetic variation: 8E

2.19.2 Navigation Aid Identification: SAT

2.19.5 Coordinates: 29-38-38.508N / 98-27-40.7369W

2.19.6 Site Elevation: 1158.8 ft

**General Remarks:**

TWY L CLSD NORTHBOUND.

FREQUENT RUBBER ACCUMULATION NW 2500 RY 13R/31L.

GLIDER/SOARING OPNS APRXLY 17 MILES NW OF ARPT DURG VFR.

ARPT RSTD TO ACFT WITH WINGSPAN GTR THAN 171 FT, PPR WITH 24HR OPS 210-207-3433. RQRD FOR AUTH.



ALL INTL GENERAL AVIATION CLEAR U.S. CSTMS AT NORTH FIXED BASE OPERATOR RAMP EAST SIDE, CALL U.S. CSTMS 210-821-6965 UPON ARR.

TWY S BTN APCH END RWY 13L AND RWY 13R/31L CLSD TO ACFT WITH WINGSPAN MORE THAN 100 FT.  
TWY R BTN APCH END RWY 13L AND TWY D CLSD TO ACFT WINGSPAN MORE THAN 100 FT.

NOISE SENSITIVE AREAS EXIST ON ALL SIDES OF ARPT, AT PILOTS DISCRETION CLIMB AS QUICKLY AND QUIETLY AS SAFELY POSSIBLE ON DEPARTURE AND USE CONSIDERATION WHEN FLYING OVER POPULATED AREAS BY MINIMIZING FLT AND HIGH PWR SETTINGS. MILITARY AIRCRAFT: DEPARTING AND ARRIVING AIRCRAFT WILL USE MINIMUM POWER SETTINGS CONSISTENT WITH AIRCRAFT FLIGHT MANUALS, AFTERBURNER TAKEOFF IS PROHIBITED UNLESS REQUIRED FOR SAFETY OF FLIGHT. ENGINE-UPS ARE PERMITTED BTN 0600-2300.

ACFT TAXIING ON RY 04 NE BOUND LOOK FOR HOLD SHORT TO RY 31L.

INNER RAMP TAXILANE NORTH OF TRML A AND B IS CLSD TO ACFT WITH WINGSPAN GTR THAN 135 FT.

PPR WITH ARPT OPNS FOR ACFT POWERING BACK FM TERMINAL GATES.

GROUND RUN-UP ENCLOSURE AVBL 24 HRS.

NUMEROUS FLOCKS OF BIRDS INVOF ARPT.

FOREIGN MIL ACFT WITH WINGSPAN LESS THAN 100 FT MUST REP TO GA RAMP FED INSPECTION STATION FOR CUST PROCESSING, CTC AP MANAGEMENT AT 210-207-3433.

RY 13L/31R NOT AVBL FOR PART 121 ACR OPNS.

TERMINAL GATES A1, A2, A6, A7, A8, A15 & A17 USE ONLY WITH PPR CALL OPNS 210-207-3433.

ALL ACFT AFTER LDG ON RWY 13R/31L EXITING SOUTHWEST BOUND ON TWY DELTA TO MAKE 90 DEG TURN ON TWY GOLF TO AVOID UNUSBL SFC.

C130 AND C17 TYPE ACFT MUST PARK ON WEST RAMP TO CLR CUST.

ACFT TAXIING ON TWY N SW BOUND LOOK FOR HOLD SHORT TO RY 31R.

TWY Z CLSD TO ACFT WITH WINGSPAN GREATER THAN 118 FT.

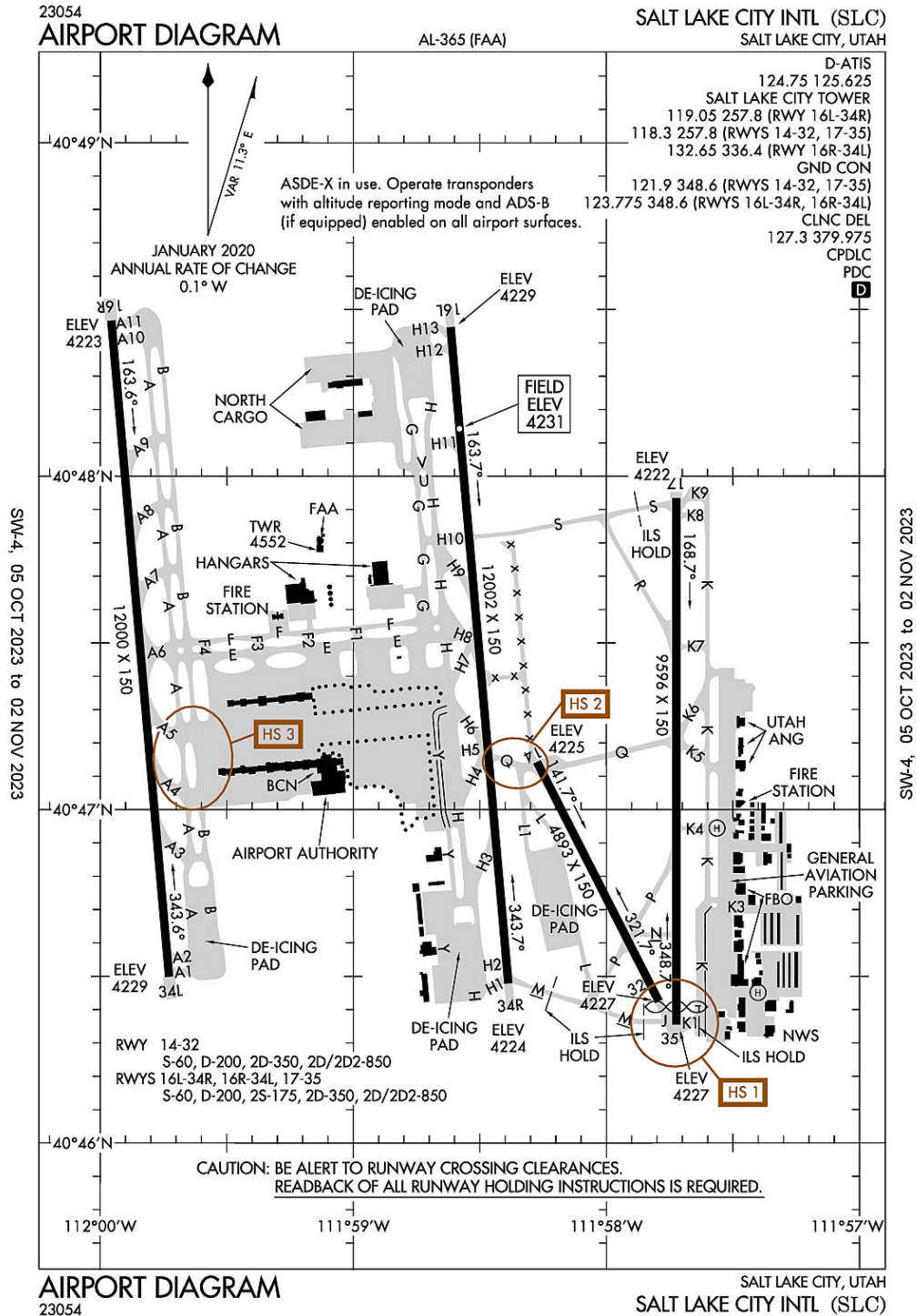
APRON EAST CARGO RAMP INT OF RWY 04/22 AND TWY DELTA ACFT ARE REQ TO APPLY THE MNM THRUST WHEN XNG THE RWY TO AVOID DMG DUE TO JET BLAST.

THE FOLLOWING TWYS ARE NOT AVBL FOR ACFT 59,000 LBS OR OVER: TWY A & TWY J NORTH OF RY 13R-31L, TWY M & TWY P, TWY H NORTHWEST OF TWY Z AND TWY E EAST OF RY 04/22.

TWYS L & B CLSD TO ACFT WITH WINGSPANS GREATER THAN 118 FT EXITING RY 31L.

ACFT AT TERMINAL A & B ADVISE GND CTL PRIOR TO PUSH.

### Salt Lake City, Utah Salt Lake City International ICAO Identifier KSLC



**Salt Lake City, UT**  
**Salt Lake City Intl**  
**ICAO Identifier KSLC**

**AD 2.2 Aerodrome geographical and administrative data**

- 2.2.1 Reference Point: 40-47-18.216N / 111-58-39.984W
- 2.2.2 From City: 3 miles W of SALT LAKE CITY, UT
- 2.2.3 Elevation: 4230.9 ft
- 2.2.5 Magnetic Variation: 11E (2020)
- 2.2.6 Airport Contact: MATTHEW BROWN  
P.O. BOX 145550  
SALT LAKE CITY, UT 84114 (801-575-2244)
- 2.2.7 Traffic: IFR/VFR

**AD 2.3 Attendance Schedule**

- 2.3.1 All Months, All Days, All Hours

**AD 2.4 Handling Services and Facilities**

- 2.4.1 Cargo Handling Facilities: YES
- 2.4.2 Fuel Types: 100LL,A1+
- 2.4.5 Hangar Space: YES
- 2.4.6 Repair Facilities: MAJOR

**AD 2.6 Rescue and Firefighting Services**

- 2.6.1 Aerodrome Category: Class-I certified on 5/1/1973
- 2.6.2 Rescue and Firefighting Services: ARFF Index-E

**AD 2.12 Runway Physical Characteristics**

- 2.12.1 Designation: 14
- 2.12.2 True Bearing: 153
- 2.12.3 Dimensions: 4893 ft x 150 ft
- 2.12.4 PCN:
- 2.12.5 Coordinates: 40-47-8.5848N / 111-58-16.4661W
- 2.12.6 Threshold Elevation: 4224.7 ft
- 2.12.6 Touchdown Zone Elevation: 4224.8 ft
  
- 2.12.1 Designation: 32
- 2.12.2 True Bearing: 333
- 2.12.3 Dimensions: 4893 ft x 150 ft
- 2.12.4 PCN:
- 2.12.5 Coordinates: 40-46-25.5192N / 111-57-47.5915W
- 2.12.6 Threshold Elevation: 4226.8 ft
- 2.12.6 Touchdown Zone Elevation: 4226.8 ft
  
- 2.12.1 Designation: 34R
- 2.12.2 True Bearing: 355
- 2.12.3 Dimensions: 12002 ft x 150 ft
- 2.12.4 PCN:
- 2.12.5 Coordinates: 40-46-28.7185N / 111-58-23.2566W
- 2.12.6 Threshold Elevation: 4224.3 ft
- 2.12.6 Touchdown Zone Elevation: 4224.7 ft

2.12.1 Designation: 16L  
2.12.2 True Bearing: 175  
2.12.3 Dimensions: 12002 ft x 150 ft  
2.12.4 PCN:  
2.12.5 Coordinates: 40-48-26.8298N / 111-58-36.9557W  
2.12.6 Threshold Elevation: 4229.1 ft  
2.12.6 Touchdown Zone Elevation: 4230.9 ft

2.12.1 Designation: 16R  
2.12.2 True Bearing: 175  
2.12.3 Dimensions: 12000 ft x 150 ft  
2.12.4 PCN:  
2.12.5 Coordinates: 40-48-28.0035N / 111-59-57.4282W  
2.12.6 Threshold Elevation: 4223.4 ft  
2.12.6 Touchdown Zone Elevation: 4225.8 ft

2.12.1 Designation: 34L  
2.12.2 True Bearing: 355  
2.12.3 Dimensions: 12000 ft x 150 ft  
2.12.4 PCN:  
2.12.5 Coordinates: 40-46-29.9171N / 111-59-43.6913W  
2.12.6 Threshold Elevation: 4228.8 ft  
2.12.6 Touchdown Zone Elevation: 4228.8 ft

2.12.1 Designation: 35  
2.12.2 True Bearing: 360  
2.12.3 Dimensions: 9596 ft x 150 ft  
2.12.4 PCN:  
2.12.5 Coordinates: 40-46-21.3022N / 111-57-43.4496W  
2.12.6 Threshold Elevation: 4226.8 ft  
2.12.6 Touchdown Zone Elevation: 4226.9 ft

2.12.1 Designation: 17  
2.12.2 True Bearing: 180  
2.12.3 Dimensions: 9596 ft x 150 ft  
2.12.4 PCN:  
2.12.5 Coordinates: 40-47-56.1043N / 111-57-43.4552W  
2.12.6 Threshold Elevation: 4221.7 ft  
2.12.6 Touchdown Zone Elevation: 4222.2 ft

2.12.1 Designation: HB  
2.12.2 True Bearing:  
2.12.3 Dimensions: 60 ft x 60 ft  
2.12.4 PCN:  
2.12.5 Coordinates: 40-46-27.0827N / 111-57-24.0562W  
2.12.6 Threshold Elevation: 4220.4 ft  
2.12.6 Touchdown Zone Elevation: ft

2.12.1 Designation: HF  
2.12.2 True Bearing:

- 2.12.3 Dimensions: 60 ft x 60 ft
- 2.12.4 PCN:
- 2.12.5 Coordinates: -- / --
- 2.12.6 Threshold Elevation: ft
- 2.12.6 Touchdown Zone Elevation: ft

**AD 2.13 Declared Distances**

- 2.13.1 Designation: 14
- 2.13.2 Take-off Run Available: 4892
- 2.13.3 Take-off Distance Available: 4892
- 2.13.4 Accelerate-Stop Distance Available: 4892
- 2.13.5 Landing Distance Available: 4892

- 2.13.1 Designation: 32
- 2.13.2 Take-off Run Available: 4892
- 2.13.3 Take-off Distance Available: 4892
- 2.13.4 Accelerate-Stop Distance Available: 4892
- 2.13.5 Landing Distance Available: 4892

- 2.13.1 Designation: 34R
- 2.13.2 Take-off Run Available: 12002
- 2.13.3 Take-off Distance Available: 12002
- 2.13.4 Accelerate-Stop Distance Available: 12002
- 2.13.5 Landing Distance Available: 12002

- 2.13.1 Designation: 16L
- 2.13.2 Take-off Run Available: 12002
- 2.13.3 Take-off Distance Available: 12002
- 2.13.4 Accelerate-Stop Distance Available: 12002
- 2.13.5 Landing Distance Available: 12002

- 2.13.1 Designation: 16R
- 2.13.2 Take-off Run Available: 12000
- 2.13.3 Take-off Distance Available: 12000
- 2.13.4 Accelerate-Stop Distance Available: 12000
- 2.13.5 Landing Distance Available: 12000

- 2.13.1 Designation: 34L
- 2.13.2 Take-off Run Available: 12000
- 2.13.3 Take-off Distance Available: 12000
- 2.13.4 Accelerate-Stop Distance Available: 12000
- 2.13.5 Landing Distance Available: 12000

- 2.13.1 Designation: 35
- 2.13.2 Take-off Run Available: 9596
- 2.13.3 Take-off Distance Available: 9596
- 2.13.4 Accelerate-Stop Distance Available: 9596
- 2.13.5 Landing Distance Available: 9272

- 2.13.1 Designation: 17

2.13.2 Take-off Run Available: 9596  
2.13.3 Take-off Distance Available: 9596  
2.13.4 Accelerate-Stop Distance Available: 9596  
2.13.5 Landing Distance Available: 9596

2.13.1 Designation: HB  
2.13.2 Take-off Run Available:  
2.13.3 Take-off Distance Available:  
2.13.4 Accelerate-Stop Distance Available:  
2.13.5 Landing Distance Available:

2.13.1 Designation: HF  
2.13.2 Take-off Run Available:  
2.13.3 Take-off Distance Available:  
2.13.4 Accelerate-Stop Distance Available:  
2.13.5 Landing Distance Available:

#### **AD 2.14 Approach and Runway Lighting**

2.14.1 Designation: 14  
2.14.2 Approach Lighting System:  
2.14.4 Visual Approach Slope Indicator System: P4L

2.14.1 Designation: 32  
2.14.2 Approach Lighting System:  
2.14.4 Visual Approach Slope Indicator System: P4L

2.14.1 Designation: 34R  
2.14.2 Approach Lighting System: ALSF2  
2.14.4 Visual Approach Slope Indicator System: P4L

2.14.1 Designation: 16L  
2.14.2 Approach Lighting System: ALSF2  
2.14.4 Visual Approach Slope Indicator System: P4L

2.14.1 Designation: 16R  
2.14.2 Approach Lighting System: ALSF2  
2.14.4 Visual Approach Slope Indicator System: P4L

2.14.1 Designation: 34L  
2.14.2 Approach Lighting System: ALSF2  
2.14.4 Visual Approach Slope Indicator System: P4L

2.14.1 Designation: 35  
2.14.2 Approach Lighting System: MALSR  
2.14.4 Visual Approach Slope Indicator System: P4L

2.14.1 Designation: 17  
2.14.2 Approach Lighting System: MALSR  
2.14.4 Visual Approach Slope Indicator System: P4R

2.14.1 Designation: HB  
2.14.2 Approach Lighting System:  
2.14.4 Visual Approach Slope Indicator System:

2.14.1 Designation: HF  
2.14.2 Approach Lighting System:  
2.14.4 Visual Approach Slope Indicator System:

**AD 2.18 Air Traffic Services Communication Facilities**

2.18.1 Service Designation: ANG COMD POST  
2.18.3 Channel: 303.15  
2.18.5 Hours of Operation:

2.18.1 Service Designation: ANG COMD POST  
2.18.3 Channel: 311  
2.18.5 Hours of Operation:

2.18.1 Service Designation: CD PRE DEP CLNC  
2.18.3 Channel: 127.3  
2.18.5 Hours of Operation: 24

2.18.1 Service Designation: CD PRE TAXI CLNC  
2.18.3 Channel: 127.3  
2.18.5 Hours of Operation: 24

2.18.1 Service Designation: CD/P  
2.18.3 Channel: 379.975  
2.18.5 Hours of Operation: 24

2.18.1 Service Designation: D-ATIS  
2.18.3 Channel: 124.75  
2.18.5 Hours of Operation: 24

2.18.1 Service Designation: D-ATIS  
2.18.3 Channel: 125.625  
2.18.5 Hours of Operation: 24

2.18.1 Service Designation: EMERG  
2.18.3 Channel: 121.5  
2.18.5 Hours of Operation:

2.18.1 Service Designation: EMERG  
2.18.3 Channel: 243  
2.18.5 Hours of Operation:

2.18.1 Service Designation: GND/P (RWY 14/32, 17/35)  
2.18.3 Channel: 121.9  
2.18.5 Hours of Operation: 24

2.18.1 Service Designation: GND/P (RWY 16L/34R, 16R/34L)

2.18.3 Channel: 123.775  
2.18.5 Hours of Operation: 24

2.18.1 Service Designation: GND/P  
2.18.3 Channel: 348.6  
2.18.5 Hours of Operation: 24

2.18.1 Service Designation: LCL/P (RWY 14/32, 17/35)  
2.18.3 Channel: 118.3  
2.18.5 Hours of Operation: 24

2.18.1 Service Designation: LCL/P (RWY 16L/34R)  
2.18.3 Channel: 119.05  
2.18.5 Hours of Operation: 24

2.18.1 Service Designation: LCL/P (RWY 16R/34L)  
2.18.3 Channel: 132.65  
2.18.5 Hours of Operation: 24

2.18.1 Service Designation: LCL/P (RWY 14/32, 16L/34R, 17/35)  
2.18.3 Channel: 257.8  
2.18.5 Hours of Operation: 24

2.18.1 Service Designation: LCL/P (RWY 16R/34L)  
2.18.3 Channel: 336.4  
2.18.5 Hours of Operation: 24

#### **AD 2.19 Radio Navigation and Landing Aids**

2.19.1 ILS Type: DME for runway 16L. Magnetic variation: 11E  
2.19.2 ILS Identification: MOY  
2.19.5 Coordinates: 40-46-18.724N / 111-58-18.1254W  
2.19.6 Site Elevation: 4239.9 ft

2.19.1 ILS Type: Glide Slope for runway 16L. Magnetic variation: 11E  
2.19.2 ILS Identification: MOY  
2.19.5 Coordinates: 40-48-17.0756N / 111-58-30.6172W  
2.19.6 Site Elevation: 4225 ft

2.19.1 ILS Type: Inner Marker for runway 16L. Magnetic variation: 11E  
2.19.2 ILS Identification: MOY  
2.19.5 Coordinates: 40-48-35.7038N / 111-58-38.0115W  
2.19.6 Site Elevation: 4222.8 ft

2.19.1 ILS Type: Localizer for runway 16L. Magnetic variation: 11E  
2.19.2 ILS Identification: MOY  
2.19.5 Coordinates: 40-46-18.5061N / 111-58-22.0717W  
2.19.6 Site Elevation: 4226.5 ft

2.19.1 ILS Type: DME for runway 34R. Magnetic variation: 11E  
2.19.2 ILS Identification: SLC



2.19.5 Coordinates: 40-46-18.724N / 111-58-18.1254W

2.19.6 Site Elevation: 4239.9 ft

2.19.1 ILS Type: Glide Slope for runway 34R. Magnetic variation: 11E

2.19.2 ILS Identification: SLC

2.19.5 Coordinates: 40-46-39.3436N / 111-58-19.2908W

2.19.6 Site Elevation: 4220 ft

2.19.1 ILS Type: Inner Marker for runway 34R. Magnetic variation: 11E

2.19.2 ILS Identification: SLC

2.19.5 Coordinates: 40-46-20.3855N / 111-58-22.2947W

2.19.6 Site Elevation: 4225.1 ft

2.19.1 ILS Type: Localizer for runway 34R. Magnetic variation: 11E

2.19.2 ILS Identification: SLC

2.19.5 Coordinates: 40-48-37.6811N / 111-58-38.2145W

2.19.6 Site Elevation: 4224.5 ft

2.19.1 ILS Type: DME for runway 16R. Magnetic variation: 11E

2.19.2 ILS Identification: UAT

2.19.5 Coordinates: 40-46-19.627N / 111-59-46.3581W

2.19.6 Site Elevation: 4233.6 ft

2.19.1 ILS Type: Glide Slope for runway 16R. Magnetic variation: 11E

2.19.2 ILS Identification: UAT

2.19.5 Coordinates: 40-48-17.3028N / 112-0-1.6005W

2.19.6 Site Elevation: 4218.7 ft

2.19.1 ILS Type: Localizer for runway 16R. Magnetic variation: 11E

2.19.2 ILS Identification: UAT

2.19.5 Coordinates: 40-46-19.9476N / 111-59-42.5324W

2.19.6 Site Elevation: 4227.2 ft

2.19.1 ILS Type: DME for runway 34L. Magnetic variation: 11E

2.19.2 ILS Identification: UUH

2.19.5 Coordinates: 40-46-19.627N / 111-59-46.3581W

2.19.6 Site Elevation: 4233.6 ft

2.19.1 ILS Type: Glide Slope for runway 34L. Magnetic variation: 11E

2.19.2 ILS Identification: UUH

2.19.5 Coordinates: 40-46-39.8998N / 111-59-50.2673W

2.19.6 Site Elevation: 4222.6 ft

2.19.1 ILS Type: Localizer for runway 34L. Magnetic variation: 11E

2.19.2 ILS Identification: UUH

2.19.5 Coordinates: 40-48-37.9731N / 111-59-58.5893W

2.19.6 Site Elevation: 4220 ft

2.19.1 ILS Type: DME for runway 17. Magnetic variation: 11E

2.19.2 ILS Identification: BNT

2.19.5 Coordinates: 40-46-9.7838N / 111-57-47.5356W

2.19.6 Site Elevation: 4242.7 ft

2.19.1 ILS Type: Glide Slope for runway 17. Magnetic variation: 11E

2.19.2 ILS Identification: BNT

2.19.5 Coordinates: 40-47-45.7497N / 111-57-50.0372W

2.19.6 Site Elevation: 4216.4 ft

2.19.1 ILS Type: Localizer for runway 17. Magnetic variation: 11E

2.19.2 ILS Identification: BNT

2.19.5 Coordinates: 40-46-10.0541N / 111-57-43.4502W

2.19.6 Site Elevation: 4227.9 ft

2.19.1 ILS Type: DME for runway 35. Magnetic variation: 11E

2.19.2 ILS Identification: UTJ

2.19.5 Coordinates: 40-46-9.7838N / 111-57-47.5356W

2.19.6 Site Elevation: 4242.7 ft

2.19.1 ILS Type: Glide Slope for runway 35. Magnetic variation: 11E

2.19.2 ILS Identification: UTJ

2.19.5 Coordinates: 40-46-35.1583N / 111-57-48.6413W

2.19.6 Site Elevation: 4229.2 ft

2.19.1 ILS Type: Localizer for runway 35. Magnetic variation: 11E

2.19.2 ILS Identification: UTJ

2.19.5 Coordinates: 40-47-8.3329N / 111-57-51.5557W

2.19.6 Site Elevation: 4220.8 ft

**General Remarks:**

SEE CURRENT NOTAMS FOR DATES AND ADDITIONAL INFO.

MILITARY: ANG RAMP: NSTD PAVEMENT MARK ON RAMP.

SVFR IS NOT RCMD AT THE ARPT, IF REQD, EXPT DLAS.

TWY Y RSTD TO WINGSPANS LESS THAN 171 FT BTWN TWY H3 AND H4.

MILITARY: ANG RAMP: OPR 1430-2230Z++ MON-THU. CLSD FRI-SUN AND HOL. OFFL BUS ONLY. PPR REQ 48 HR ALL ACFT, VALID 1 HR +/- ETA. TRAN PRK/SVC EXTREMELY LTD. BASE OPS DSN 245-2274, C801-245-2274. MIL ALT HILL AFB (KHIF) 25 NM N. ALL ACFT CTC UTAH CTL (COMD POST) 20 MIN OUT WITH ETA AND REQ.

ASDE-X IN USE. OPERATE TRANSPONDERS WITH ALTITUDE REPORTING MODE AND ADS-B (IF EQUIPPED) ENABLED ON ALL AIRPORT SURFACES.

SURFACE MOVEMENT GUIDANCE CONTROL SYSTEM & LOW VISIBILITY TAXI PROCEDURES.

HELIPADS B AND F LOCATED ON GENERAL AVIATION APRONS.

USE CAUTION FOR EXTENSIVE PARAGLIDING OPS INVOF POINT OF THE MOUNTAIN.

SEE FLIP AP/1 SUPPLEMENTARY ARPT INFO.

MILITARY: COMMUNICATIONS: ANG COMD POST - CALL UTAH CONTROL.

USE MINIMUM THRUST IN CONSTRUCTION AREAS.

CONTACT GROUND ON 123.775 BEFORE TAXIING OUT OF NORTH CARGO.

DUE TO TFC VOL, LCL DEPARTURE AND ARR OPNS ARE DISCOURAGED AND DLAS CAN BE EXPCD BTN 1500-1730Z++ AND 0130-0300Z++.

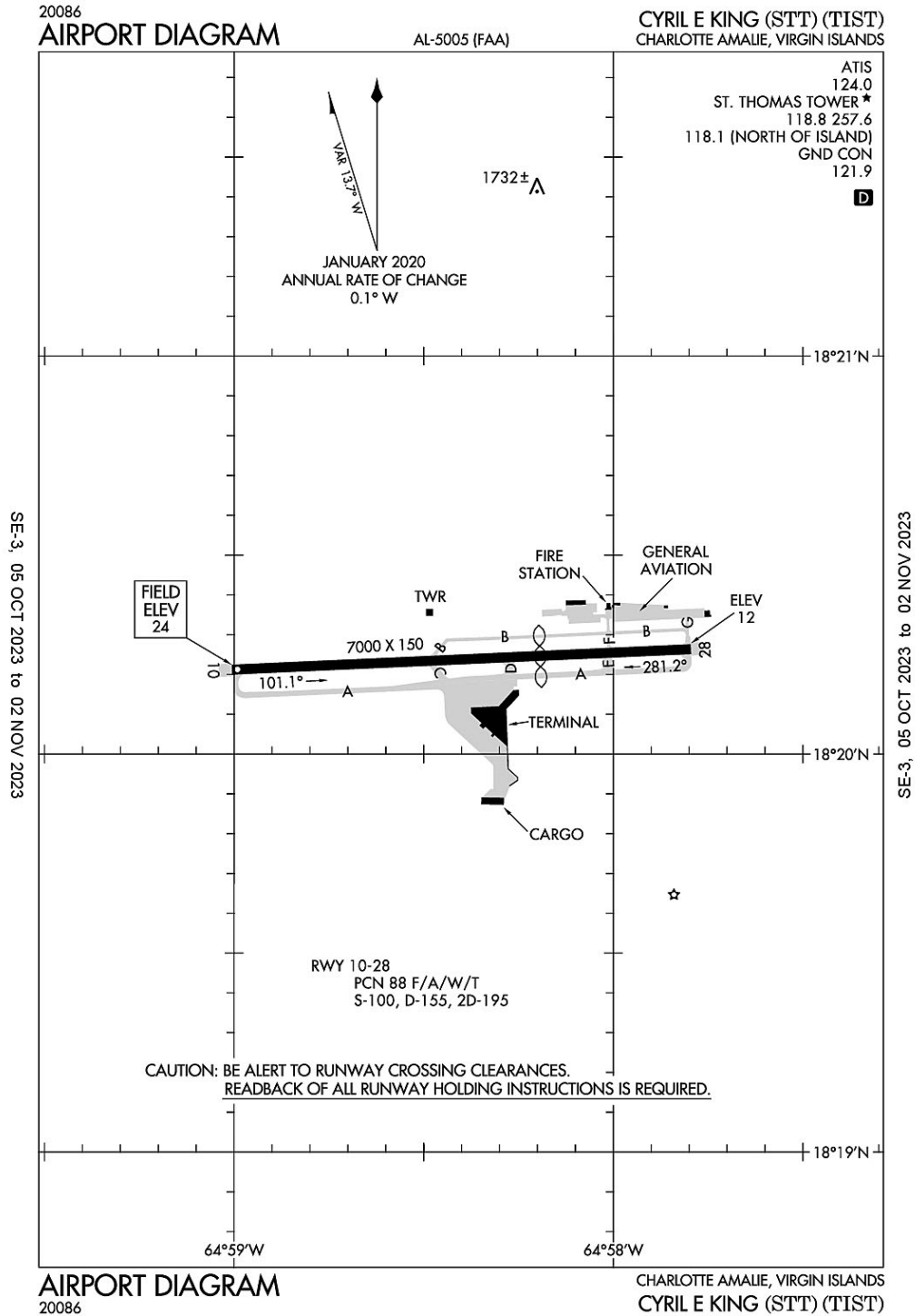
MILITARY: SVC: FUEL A++.

TWY K RSTRD TO ACFT WITH WINGSPAN LESS THAN 171 FT.

FLOCK OF BIRDS ON AND IN VICINITY OF ARPT.

MILITARY: ANG RAMP: ALL ACFT CTC UTAH CONTROL WITH LDG & DEP TIMES. COMD POST DSN: 245-2416/2417; C801-245-2416/2417. PHASE II WILDLIFE ACT DURING MIGRATION/MORNING/EVENING HRS FR OCT-APR. CTC UTAH CTL FOR CURRENT BIRD-WATCH COND.

### Charlotte Amalie St. Thomas, Virgin Islands Cyril E King ICAO Identifier TIST



**Charlotte Amalie, VI**  
**Cyril E King**  
**ICAO Identifier TIST**

**AD 2.2 Aerodrome geographical and administrative data**

- 2.2.1 Reference Point: 18-20-14.3N / 64-58-24W
- 2.2.2 From City: 2 miles W of CHARLOTTE AMALIE, VI
- 2.2.3 Elevation: 23.6 ft
- 2.2.5 Magnetic Variation: 13W (2000)
- 2.2.6 Airport Contact: JEROME SHERIDAN  
CYRIL E. KING AIRPORT  
ST THOMAS, VI 802 ((340) 714-6667)
- 2.2.7 Traffic: IFR/VFR

**AD 2.3 Attendance Schedule**

- 2.3.1 All Months, All Days, 0700-2300 Hours

**AD 2.4 Handling Services and Facilities**

- 2.4.1 Cargo Handling Facilities: YES
- 2.4.2 Fuel Types: 100LL,A
- 2.4.5 Hangar Space: YES
- 2.4.6 Repair Facilities: MINOR

**AD 2.6 Rescue and Firefighting Services**

- 2.6.1 Aerodrome Category: Class-I certified on 5/1/1973
- 2.6.2 Rescue and Firefighting Services: ARFF Index-C

**AD 2.12 Runway Physical Characteristics**

- 2.12.1 Designation: 28
  - 2.12.2 True Bearing: 267
  - 2.12.3 Dimensions: 7000 ft x 150 ft
  - 2.12.4 PCN: 88 F/A/W/T
  - 2.12.5 Coordinates: 18-20-15.8124N / 64-57-47.7382W
  - 2.12.6 Threshold Elevation: 11.7 ft
  - 2.12.6 Touchdown Zone Elevation: 16.5 ft
- 
- 2.12.1 Designation: 10
  - 2.12.2 True Bearing: 87
  - 2.12.3 Dimensions: 7000 ft x 150 ft
  - 2.12.4 PCN: 88 F/A/W/T
  - 2.12.5 Coordinates: 18-20-12.7247N / 64-59-0.3371W
  - 2.12.6 Threshold Elevation: 23.5 ft
  - 2.12.6 Touchdown Zone Elevation: 23.6 ft

**AD 2.13 Declared Distances**

- 2.13.1 Designation: 28
- 2.13.2 Take-off Run Available: 7000
- 2.13.3 Take-off Distance Available: 7000
- 2.13.4 Accelerate-Stop Distance Available: 6170
- 2.13.5 Landing Distance Available: 3870

- 2.13.1 Designation: 10
- 2.13.2 Take-off Run Available: 7000
- 2.13.3 Take-off Distance Available: 7000
- 2.13.4 Accelerate-Stop Distance Available: 6892
- 2.13.5 Landing Distance Available: 6892

**AD 2.14 Approach and Runway Lighting**

- 2.14.1 Designation: 28
- 2.14.2 Approach Lighting System:
- 2.14.4 Visual Approach Slope Indicator System:

- 2.14.1 Designation: 10
- 2.14.2 Approach Lighting System:
- 2.14.4 Visual Approach Slope Indicator System: P4L

**AD 2.18 Air Traffic Services Communication Facilities**

- 2.18.1 Service Designation: ATIS
- 2.18.3 Channel: 124
- 2.18.5 Hours of Operation: 24

- 2.18.1 Service Designation: EMERG
- 2.18.3 Channel: 121.5
- 2.18.5 Hours of Operation:

- 2.18.1 Service Designation: EMERG
- 2.18.3 Channel: 243
- 2.18.5 Hours of Operation:

- 2.18.1 Service Designation: GND/P
- 2.18.3 Channel: 121.9
- 2.18.5 Hours of Operation: 0700-2230, ATCT CLOSERS 1 HR EARLIER DRG DALGT SAVINGS TIME.

- 2.18.1 Service Designation: LCL/P (NORTH OF ISLAND)
- 2.18.3 Channel: 118.1
- 2.18.5 Hours of Operation: 0700-2230, ATCT CLOSERS 1 HR EARLIER DRG DALGT SAVINGS TIME.

2.18.1 Service Designation: LCL/P

2.18.3 Channel: 118.8

2.18.5 Hours of Operation: 0700–2230, ATCT CLOSSES 1 HR EARLIER DRG DALGT SAVINGS TIME.

2.18.1 Service Designation: LCL/P

2.18.3 Channel: 257.6

2.18.5 Hours of Operation: 0700–2230, ATCT CLOSSES 1 HR EARLIER DRG DALGT SAVINGS TIME.

### **AD 2.19 Radio Navigation and Landing Aids**

2.19.1 ILS Type: DME for runway 10. Magnetic variation: 13W

2.19.2 ILS Identification: TMN

2.19.5 Coordinates: 18–20–18.78N / 64–57–39.88W

2.19.6 Site Elevation: 22.6 ft

2.19.1 ILS Type: Glide Slope for runway 10. Magnetic variation: 13W

2.19.2 ILS Identification: TMN

2.19.5 Coordinates: 18–20–10.62N / 64–58–48.29W

2.19.6 Site Elevation: 15.1 ft

2.19.1 ILS Type: Localizer for runway 10. Magnetic variation: 13W

2.19.2 ILS Identification: TMN

2.19.5 Coordinates: 18–20–16.26N / 64–57–37.22W

2.19.6 Site Elevation: 17 ft

2.19.1 Navigation Aid Type: VOR/DME. Magnetic variation: 10W

2.19.2 Navigation Aid Identification: STT

2.19.5 Coordinates: 18–21–20.9431N / 65–1–28.3968W

2.19.6 Site Elevation: 679.2 ft

### **General Remarks:**

LGTS ON HILL 4 NM SE OF ARPT MAY BE MISTAKEN FOR RY 10/28 WHEN MAKING A VISUAL APCH FROM THE SOUTH.

ACFT THAT BACK TAXI FOR DEP ON RY 28 SHALL MAKE THEIR 180 DEG TURN CCLKWS.

NOISE SENSITIVE AREA: AVOID OVERFLIGHTS OF WATER ISLAND LOCATED 2 MI SE OF ARPT.

ARFF UNAVBL 2300–0630.

RY 10 DEPS MAINTAIN RY HDG UNTIL REACHING DEP END OF RY BFR TURNING ON COURSE OR ASSIGNED HDG UNLESS OTRW AUZD BY ATCT.

WHEN TWR CLSD CTC SAN JUAN CERAP AT 787–253–8664/8665

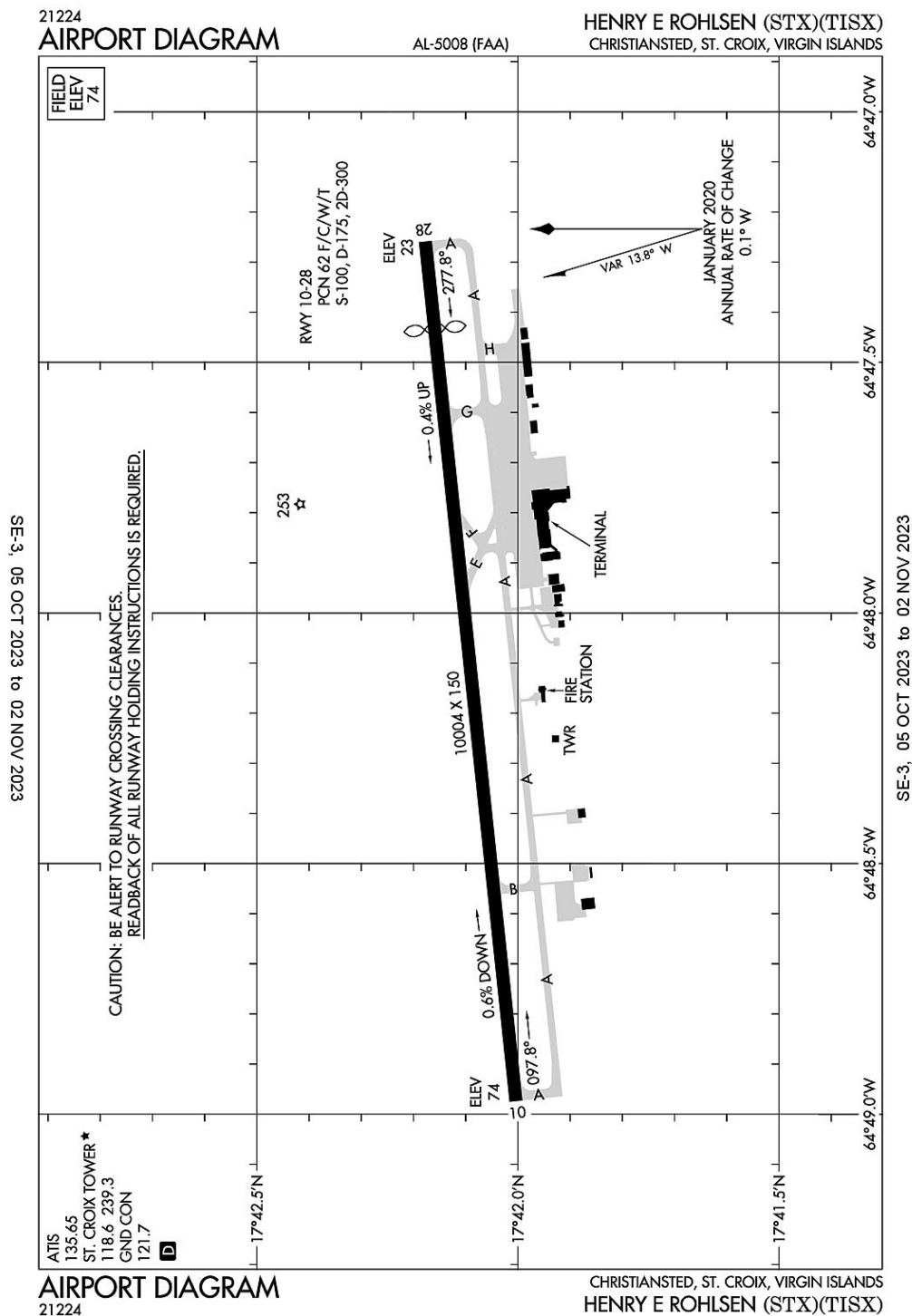
PILOTS CTC GND CTL PRIOR TO PUSHBACK.

PILOTS MAY ENCTR FALSE ILLUSORY INDICATIONS DURG NGT VISUAL APCHS TO RY 10 WHEN USING VISUAL CUES FOR VERTICAL GUIDANCE; RCMD USE OF THE ILS GS & FQT CROSS REF WITH THE ACFT ALTM TO MAINT THE PROPER APCH PROFILE.

OBSTRUCTION SAILBOAT MAST 100FT WEST OF APPROACH END OF RWY 10 50FT AGL



Christiansted St. Croix  
Henry E Rohlsen  
ICAO Identifier TISX



**Christiansted, VI**  
**Henry E Rohlsen**  
**ICAO Identifier TISX**

**AD 2.2 Aerodrome geographical and administrative data**

- 2.2.1 Reference Point: 17-42-5.416N / 64-48-6.9945W
- 2.2.2 From City: 6 miles SW of CHRISTIANSTED, VI
- 2.2.3 Elevation: 74.1 ft
- 2.2.5 Magnetic Variation: 13W (2000)
- 2.2.6 Airport Contact: JEROME SHERIDAN  
P.O. BOX 1134  
ST CROIX, VI 821 (340-714-6662)
- 2.2.7 Traffic: IFR/VFR

**AD 2.3 Attendance Schedule**

- 2.3.1 All Months, All Days, 0500-2300 Hours

**AD 2.4 Handling Services and Facilities**

- 2.4.1 Cargo Handling Facilities: NO
- 2.4.2 Fuel Types: 100LL,A1+
- 2.4.5 Hangar Space: YES
- 2.4.6 Repair Facilities: MAJOR

**AD 2.6 Rescue and Firefighting Services**

- 2.6.1 Aerodrome Category: Class-I certified on 5/1/1973
- 2.6.2 Rescue and Firefighting Services: ARFF Index-C

**AD 2.12 Runway Physical Characteristics**

- 2.12.1 Designation: 28
- 2.12.2 True Bearing: 264
- 2.12.3 Dimensions: 10004 ft x 150 ft
- 2.12.4 PCN: 62 F/C/W/T
- 2.12.5 Coordinates: 17-42-10.62N / 64-47-15.544W
- 2.12.6 Threshold Elevation: 22.5 ft
- 2.12.6 Touchdown Zone Elevation: 40 ft

- 2.12.1 Designation: 10
- 2.12.2 True Bearing: 84
- 2.12.3 Dimensions: 10004 ft x 150 ft
- 2.12.4 PCN: 62 F/C/W/T
- 2.12.5 Coordinates: 17-42-0.212N / 64-48-58.445W
- 2.12.6 Threshold Elevation: 73.7 ft
- 2.12.6 Touchdown Zone Elevation: 74.1 ft

**AD 2.13 Declared Distances**

- 2.13.1 Designation: 28
- 2.13.2 Take-off Run Available: 10004
- 2.13.3 Take-off Distance Available: 10004
- 2.13.4 Accelerate-Stop Distance Available: 10004
- 2.13.5 Landing Distance Available: 8998

- 2.13.1 Designation: 10
- 2.13.2 Take-off Run Available: 10004
- 2.13.3 Take-off Distance Available: 10004
- 2.13.4 Accelerate-Stop Distance Available: 9003
- 2.13.5 Landing Distance Available: 9003

**AD 2.14 Approach and Runway Lighting**

- 2.14.1 Designation: 28
- 2.14.2 Approach Lighting System:
- 2.14.4 Visual Approach Slope Indicator System: P4L

- 2.14.1 Designation: 10
- 2.14.2 Approach Lighting System: MALSR
- 2.14.4 Visual Approach Slope Indicator System: P4L

**AD 2.18 Air Traffic Services Communication Facilities**

- 2.18.1 Service Designation: ATIS
- 2.18.3 Channel: 135.65
- 2.18.5 Hours of Operation: 24

- 2.18.1 Service Designation: EMERG
- 2.18.3 Channel: 121.5
- 2.18.5 Hours of Operation:

- 2.18.1 Service Designation: EMERG
- 2.18.3 Channel: 243
- 2.18.5 Hours of Operation:

- 2.18.1 Service Designation: GND/P
- 2.18.3 Channel: 121.7
- 2.18.5 Hours of Operation: 0700-2200

- 2.18.1 Service Designation: LCL/P
- 2.18.3 Channel: 118.6
- 2.18.5 Hours of Operation: 0700-2200

- 2.18.1 Service Designation: LCL/P
- 2.18.3 Channel: 239.3
- 2.18.5 Hours of Operation: 0700-2200

**AD 2.19 Radio Navigation and Landing Aids**

- 2.19.1 ILS Type: Glide Slope for runway 10. Magnetic variation: 13W
- 2.19.2 ILS Identification: STX
- 2.19.5 Coordinates: 17-41-58.77N / 64-48-45.5W
- 2.19.6 Site Elevation: 63.5 ft

- 2.19.1 ILS Type: Localizer for runway 10. Magnetic variation: 13W

2.19.2 ILS Identification: STX  
2.19.5 Coordinates: 17-42-11.36N / 64-47-8.28W  
2.19.6 Site Elevation: 26.4 ft

2.19.1 ILS Type: Outer Marker for runway 10. Magnetic variation: 13W  
2.19.2 ILS Identification: STX  
2.19.5 Coordinates: 17-41-30.92N / 64-53-4.74W  
2.19.6 Site Elevation: 40 ft

**General Remarks:**

APCH TO RY 28 SMTMS OBSCD BY SMOKE FM LANDFILL LCTD E OF ARPT.

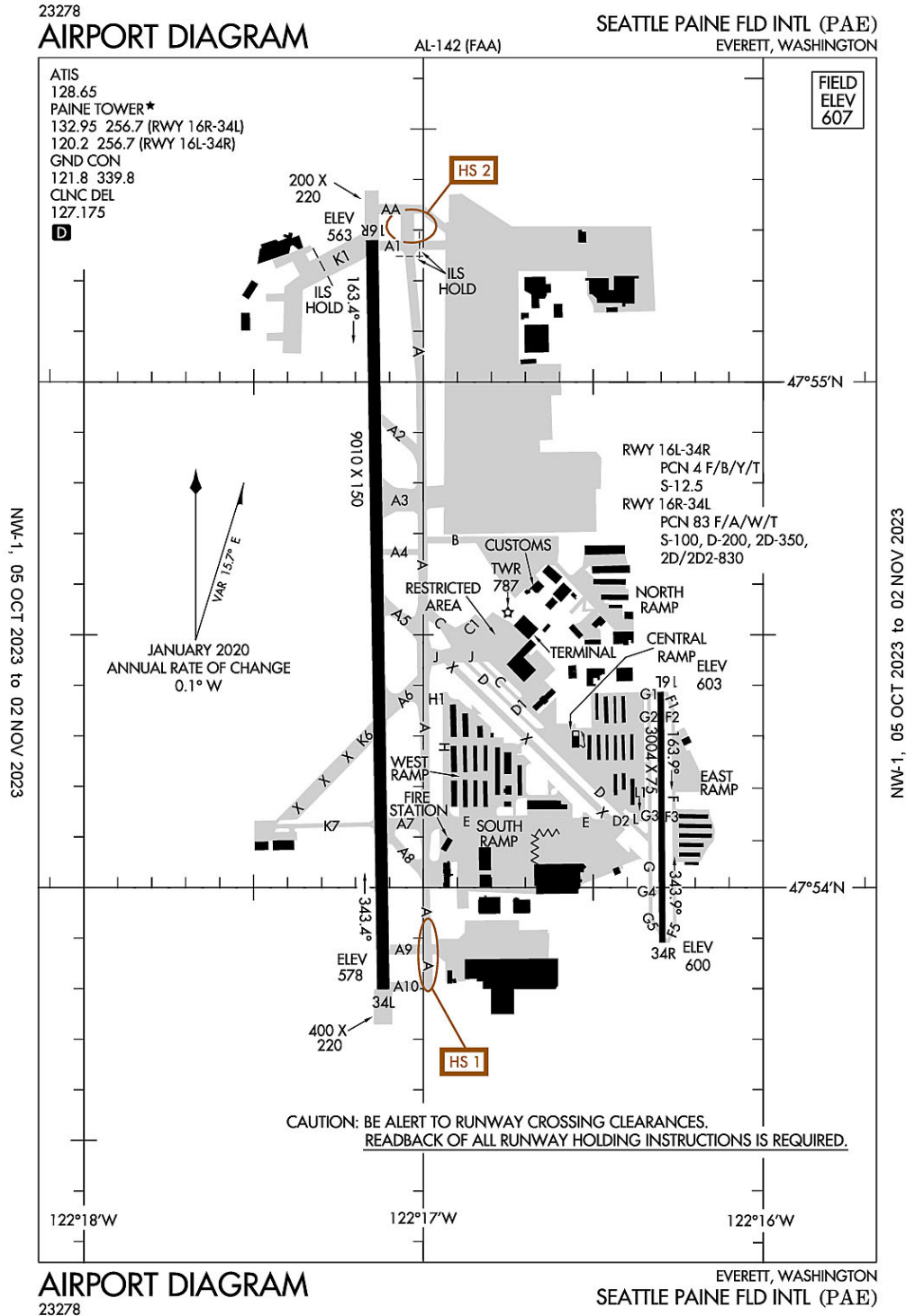
TAXI INTO POSITION AND HOLD PROCEDURES NO LONGER IN EFFECT.

BIRDS & WILDLIFE ON & INVOF ARPT.

AP SFC COND UNMON DLY 2300 - 0600 AST.

WHEN TWR CLSD CTC SAN JUAN CERAP AT 787-253-8664/8665

Everett, Washington  
Snohomish County (Paine Field)  
ICAO Identifier KPAE



**Everett, WA**  
**Snohomish County (Paine Fld)**  
**ICAO Identifier KPAE**

**AD 2.2 Aerodrome geographical and administrative data**

- 2.2.1 Reference Point: 47-54-26.345N / 122-16-55.538W
- 2.2.2 From City: 6 miles SW of EVERETT, WA
- 2.2.3 Elevation: 606.9 ft
- 2.2.5 Magnetic Variation: 16E (2020)
- 2.2.6 Airport Contact: JOSHUA MARCY  
3220 100TH ST SW  
EVERETT, WA 98204 (425-308-2347)
- 2.2.7 Traffic: IFR/VFR

**AD 2.3 Attendance Schedule**

- 2.3.1 NOV-APR Months, All Days, 0700-2100 Hours

**AD 2.4 Handling Services and Facilities**

- 2.4.1 Cargo Handling Facilities: NO
- 2.4.2 Fuel Types: 100LL,A
- 2.4.5 Hangar Space: YES
- 2.4.6 Repair Facilities: MAJOR

**AD 2.6 Rescue and Firefighting Services**

- 2.6.1 Aerodrome Category: Class-I certified on 11/1/1974
- 2.6.2 Rescue and Firefighting Services: ARFF Index-B

**AD 2.12 Runway Physical Characteristics**

- 2.12.1 Designation: 16L
- 2.12.2 True Bearing: 180
- 2.12.3 Dimensions: 3004 ft x 75 ft
- 2.12.4 PCN: 4 F/B/Y/T
- 2.12.5 Coordinates: 47-54-23.129N / 122-16-18.0936W
- 2.12.6 Threshold Elevation: 602.9 ft
- 2.12.6 Touchdown Zone Elevation: 606.9 ft
  
- 2.12.1 Designation: 34R
- 2.12.2 True Bearing: 360
- 2.12.3 Dimensions: 3004 ft x 75 ft
- 2.12.4 PCN: 4 F/B/Y/T
- 2.12.5 Coordinates: 47-53-53.4898N / 122-16-17.7647W
- 2.12.6 Threshold Elevation: 599.8 ft
- 2.12.6 Touchdown Zone Elevation: 606.9 ft
  
- 2.12.1 Designation: 16R

- 2.12.2 True Bearing: 179
- 2.12.3 Dimensions: 9010 ft x 150 ft
- 2.12.4 PCN: 83 F/A/W/T
- 2.12.5 Coordinates: 47-55-16.8088N / 122-17-9.0632W
- 2.12.6 Threshold Elevation: 562.7 ft
- 2.12.6 Touchdown Zone Elevation: 569.8 ft

- 2.12.1 Designation: 34L
- 2.12.2 True Bearing: 359
- 2.12.3 Dimensions: 9010 ft x 150 ft
- 2.12.4 PCN: 83 F/A/W/T
- 2.12.5 Coordinates: 47-53-47.904N / 122-17-7.0916W
- 2.12.6 Threshold Elevation: 577.6 ft
- 2.12.6 Touchdown Zone Elevation: 583.4 ft

#### **AD 2.13 Declared Distances**

- 2.13.1 Designation: 16L
- 2.13.2 Take-off Run Available: 3004
- 2.13.3 Take-off Distance Available: 3004
- 2.13.4 Accelerate-Stop Distance Available: 3004
- 2.13.5 Landing Distance Available: 3004

- 2.13.1 Designation: 34R
- 2.13.2 Take-off Run Available: 3004
- 2.13.3 Take-off Distance Available: 3004
- 2.13.4 Accelerate-Stop Distance Available: 3004
- 2.13.5 Landing Distance Available: 3004

- 2.13.1 Designation: 16R
- 2.13.2 Take-off Run Available: 9010
- 2.13.3 Take-off Distance Available: 9010
- 2.13.4 Accelerate-Stop Distance Available: 9010
- 2.13.5 Landing Distance Available: 9010

- 2.13.1 Designation: 34L
- 2.13.2 Take-off Run Available: 9010
- 2.13.3 Take-off Distance Available: 9010
- 2.13.4 Accelerate-Stop Distance Available: 9010
- 2.13.5 Landing Distance Available: 9010

#### **AD 2.14 Approach and Runway Lighting**

- 2.14.1 Designation: 16L

2.14.2 Approach Lighting System:  
2.14.4 Visual Approach Slope Indicator System: P2L

2.14.1 Designation: 34R  
2.14.2 Approach Lighting System:  
2.14.4 Visual Approach Slope Indicator System: P2L

2.14.1 Designation: 16R  
2.14.2 Approach Lighting System: MALSR  
2.14.4 Visual Approach Slope Indicator System: P4R

2.14.1 Designation: 34L  
2.14.2 Approach Lighting System: MALSF  
2.14.4 Visual Approach Slope Indicator System: P4L

**AD 2.18 Air Traffic Services Communication Facilities**

2.18.1 Service Designation: AR OPS  
2.18.3 Channel: 34.1  
2.18.5 Hours of Operation:

2.18.1 Service Designation: ATIS  
2.18.3 Channel: 128.65  
2.18.5 Hours of Operation: 24

2.18.1 Service Designation: CD/P  
2.18.3 Channel: 127.175  
2.18.5 Hours of Operation: 0700-2100

2.18.1 Service Designation: GND/P  
2.18.3 Channel: 121.8  
2.18.5 Hours of Operation: 0700-2100

2.18.1 Service Designation: GND/P  
2.18.3 Channel: 339.8  
2.18.5 Hours of Operation: 0700-2100

2.18.1 Service Designation: LCL/P (RWY 16L/34R)  
2.18.3 Channel: 120.2  
2.18.5 Hours of Operation: 0700-2100

2.18.1 Service Designation: LCL/P  
2.18.3 Channel: 256.7  
2.18.5 Hours of Operation: 0700-2100



2.18.1 Service Designation: LCL/P IC (RWY 16R/34L)

2.18.3 Channel: 132.95

2.18.5 Hours of Operation: 0700-2100

**AD 2.19 Radio Navigation and Landing Aids**

2.19.1 ILS Type: Glide Slope for runway 16R. Magnetic variation: 16E

2.19.2 ILS Identification: PAE

2.19.5 Coordinates: 47-55-7.3456N / 122-17-13.6246W

2.19.6 Site Elevation: 566.4 ft

2.19.1 ILS Type: Localizer for runway 16R. Magnetic variation: 16E

2.19.2 ILS Identification: PAE

2.19.5 Coordinates: 47-53-34.031N / 122-17-6.7829W

2.19.6 Site Elevation: 569.7 ft

2.19.1 Navigation Aid Type: VOR/DME. Magnetic variation: 20E

2.19.2 Navigation Aid Identification: PAE

2.19.5 Coordinates: 47-55-11.3996N / 122-16-40.0864W

2.19.6 Site Elevation: 669.2 ft

**General Remarks:**

RWY 16L/34R LTD TO HEL 8000 LBS OR LESS.

AVOID INT DEPS FM RWY 16L/34R

IT IS REQ THAT PILOTS ADHERE TO THE FLW NOISE ABATEMENT PROC UNLESS OTRW INSTRD BY ATCT, ITNRNT ARR AND LOW APCH OF SML ACFT OVER 250 HORSEPOWER AUZ ON RWYS 16L AND 34R.

NOISE SENSITIVE ARPT; FOR NOISE ABATEMENT PROC & TFC PROC CALL ARPT OPS 425-388-5125.

TSNT HEL EXP LNDG/TKOF ON TWY B.

RWY 16R/34 TGL PROHIBITED MON-FRI FM 0700-0900.

ITNRNT DEP OF SML ACFT OVER 250 HORSEPOWER ON RWY 34R.

TRNG FLTS DISCOURAGED AFT 2200.

FOR NOISE ABATEMENT FROM 0500-1500Z++ IF ACFT PERFORMANCE/WIND ALLOWS, USE RY 16R FOR ARRIVALS AND RY 34L FOR DEPARTURES.

TWY C BTN TRML RAMP AND CNTRL RAMP RSTRD TO WINGSPAN OF 68 FT OR LESS. TWY D, F, G AND L RSTRD TO WINGSPAN LESS THAN 49 FT. TWY A4, A5, K7 & B RSTRD TO WINGSPAN LESS THAN 118 FT. TAXILANE H RSTRD TO WINGSPAN LESS THAN 49 FT.

LRG ACFT FLY W PAT OVR WTR; SML ACFT FLY E PAT OVR ARPT.

AVOID LOW LVL OVRFLT OF BOEING RAMP; NE CORNER OF ARPT DUE TO JET BLAST.

FLOCKS OF LRG & SML BIRDS INVOF ARPT.

BE ALERT TO CNVG TFC ON BASE TO FINAL LEGS RWY 16R/34L 2100-0700.

FOR CD WHEN ATCT IS CLSD CTC SEATTLE APCH AT 206-214-4722.

PAE HAS FAC CONSTRAINTS THAT LMT ITS ABILITY TO ACCOMMODATE DIVD FLTS AND MNTN THE ARPTS SAFE OPN DUR IREG OPS. ACFT OPR SHOULD CTCT THE ON-DUTY ARPT OPS PSNL (425-388-5125) TO COORD DIVD FLTS EXC IN THE CASE OF A DECLARED IN-FLT EMERG.

PPR RQRD FOR ACES ON BOEING RAMP. CTC BOEING FLT DISPATCH 206-544-5900 FOR APVL. PRIOR TO TAXI ONTO BOEING RAMP CTC BOEING RADIO TWR 123.475 OR CALL 425-342-5900.

TWY K1 CLSD TO ACFT UNDER 30000 LBS.

TKOF CLNC RWY 16R FULL LEN; ENT RWY VIA TWY A1 UNLESS TWY AA SPECIFIED.

USE CTN FOR 80 FT AGL LGT POLES SW EDGE OF BRAVO RAMP.

RWY 16L/34R CLSD BTN 0500-1500Z.

TWY A-2 RSTRD TO 30000 LBS.

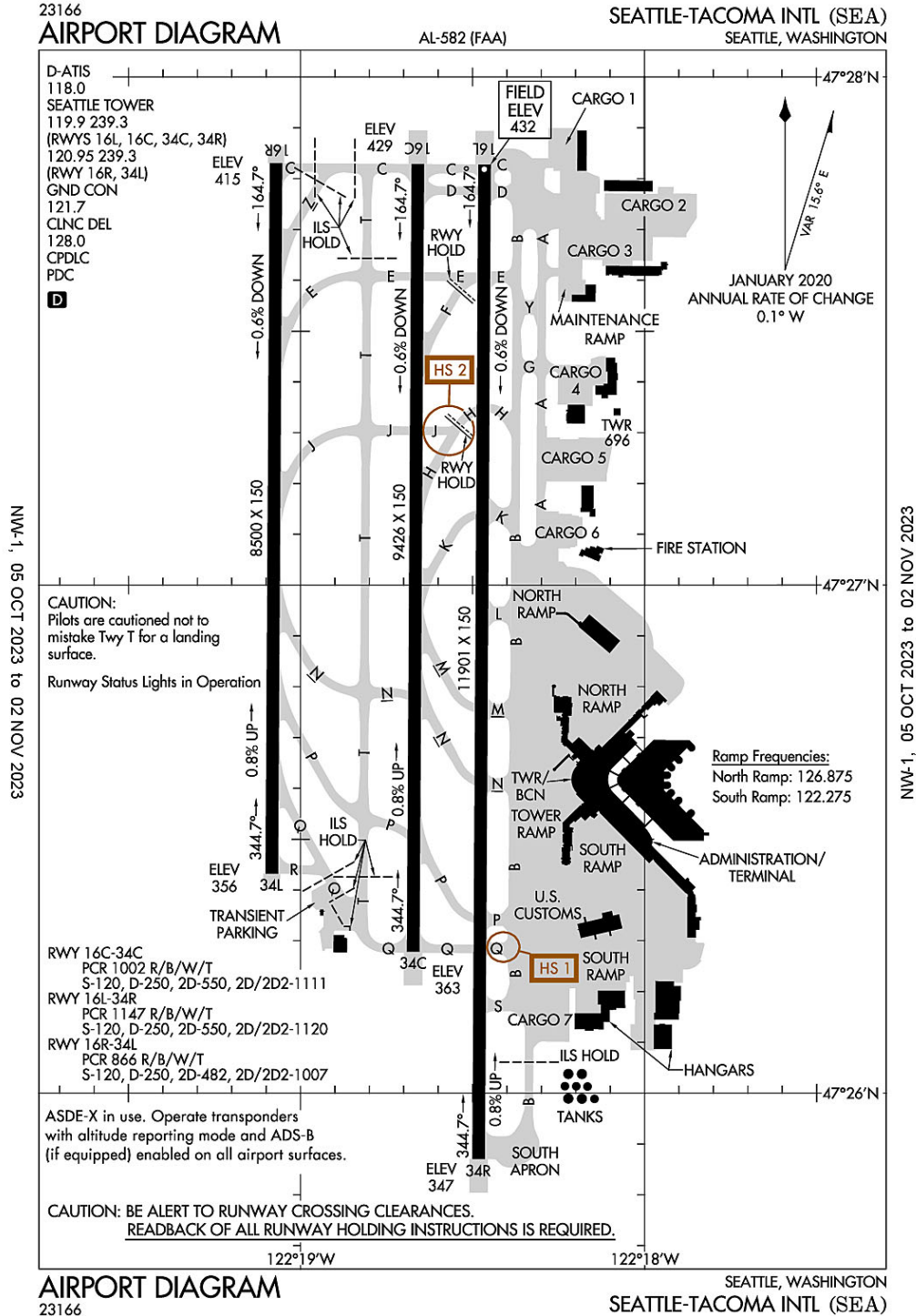
EMERG FREQ 121.5 NOT MNT AT TWR. SEATTLE APP CON-TRACON MNT 121.5 FOR EVERETT (PAE).

AREAS NOT VSB FM ATCT INCL E EDGE OF S 1200 FT OF TWY A, TAXILANE E FM SE CORNER OF W HNGRS TO TWY A, TAXILANE H FROM NW EDGE OF W HNGRS TO TAXILANE E.

TAXILANE E RSTD TO WINGSPAN LESS THAN 171 FT. ACFT WINGSPAN OF 171 FT OR GREATER ON TAXILANE E, TUG OPS ONLY. EAST 500 FT OF TAXILANE E RSTD TO WINGSPAN LESS THAN 49 FT.

AIRFIELD CONDS NOT MNTD BTN 0000-0630.

### Seattle, Washington Seattle-Tacoma International ICAO Identifier KSEA



**Seattle, WA**  
**Seattle-Tacoma Intl**  
**ICAO Identifier KSEA**

**AD 2.2 Aerodrome geographical and administrative data**

- 2.2.1 Reference Point: 47-26-59.6N / 122-18-42.4W
- 2.2.2 From City: 10 miles S of SEATTLE, WA
- 2.2.3 Elevation: 432.3 ft
- 2.2.5 Magnetic Variation: 16E (2020)
- 2.2.6 Airport Contact: LANCE LYTTLE  
BOX 68727  
SEATTLE, WA 98168 ((206) 787-5229)
- 2.2.7 Traffic: IFR/VFR

**AD 2.3 Attendance Schedule**

- 2.3.1 All Months, All Days, All Hours

**AD 2.4 Handling Services and Facilities**

- 2.4.1 Cargo Handling Facilities: YES
- 2.4.2 Fuel Types: A,A1
- 2.4.5 Hangar Space:
- 2.4.6 Repair Facilities: NONE

**AD 2.6 Rescue and Firefighting Services**

- 2.6.1 Aerodrome Category: Class-I certified on 5/1/1973
- 2.6.2 Rescue and Firefighting Services: ARFF Index-E

**AD 2.12 Runway Physical Characteristics**

- 2.12.1 Designation: 16C
- 2.12.2 True Bearing: 180
- 2.12.3 Dimensions: 9426 ft x 150 ft
- 2.12.4 PCN:
- 2.12.5 Coordinates: 47-27-49.7155N / 122-18-39.5415W
- 2.12.6 Threshold Elevation: 429.4 ft
- 2.12.6 Touchdown Zone Elevation: 429.5 ft

- 2.12.1 Designation: 34C
- 2.12.2 True Bearing: 0
- 2.12.3 Dimensions: 9426 ft x 150 ft
- 2.12.4 PCN:
- 2.12.5 Coordinates: 47-26-16.6966N / 122-18-40.3554W
- 2.12.6 Threshold Elevation: 362.9 ft
- 2.12.6 Touchdown Zone Elevation: 387 ft

- 2.12.1 Designation: 16L
- 2.12.2 True Bearing: 180
- 2.12.3 Dimensions: 11901 ft x 150 ft
- 2.12.4 PCN:
- 2.12.5 Coordinates: 47-27-49.6628N / 122-18-27.9008W
- 2.12.6 Threshold Elevation: 432.3 ft
- 2.12.6 Touchdown Zone Elevation: 432.3 ft

2.12.1 Designation: 34R  
2.12.2 True Bearing: 0  
2.12.3 Dimensions: 11901 ft x 150 ft  
2.12.4 PCN:  
2.12.5 Coordinates: 47-25-52.2202N / 122-18-28.9377W  
2.12.6 Threshold Elevation: 346.7 ft  
2.12.6 Touchdown Zone Elevation: 371.5 ft

2.12.1 Designation: 16R  
2.12.2 True Bearing: 180  
2.12.3 Dimensions: 8500 ft x 150 ft  
2.12.4 PCN:  
2.12.5 Coordinates: 47-27-49.8109N / 122-19-4.2846W  
2.12.6 Threshold Elevation: 414.8 ft  
2.12.6 Touchdown Zone Elevation: 414.8 ft

2.12.1 Designation: 34L  
2.12.2 True Bearing: 0  
2.12.3 Dimensions: 8500 ft x 150 ft  
2.12.4 PCN:  
2.12.5 Coordinates: 47-26-25.9217N / 122-19-5.009W  
2.12.6 Threshold Elevation: 356.2 ft  
2.12.6 Touchdown Zone Elevation: 379.3 ft

#### **AD 2.13 Declared Distances**

2.13.1 Designation: 16C  
2.13.2 Take-off Run Available: 9426  
2.13.3 Take-off Distance Available: 9426  
2.13.4 Accelerate-Stop Distance Available: 9426  
2.13.5 Landing Distance Available: 9426

2.13.1 Designation: 34C  
2.13.2 Take-off Run Available: 9426  
2.13.3 Take-off Distance Available: 9426  
2.13.4 Accelerate-Stop Distance Available: 9426  
2.13.5 Landing Distance Available: 9426

2.13.1 Designation: 16L  
2.13.2 Take-off Run Available: 11901  
2.13.3 Take-off Distance Available: 11901  
2.13.4 Accelerate-Stop Distance Available: 11901  
2.13.5 Landing Distance Available: 11901

2.13.1 Designation: 34R  
2.13.2 Take-off Run Available: 11901  
2.13.3 Take-off Distance Available: 11901  
2.13.4 Accelerate-Stop Distance Available: 11901  
2.13.5 Landing Distance Available: 11901

2.13.1 Designation: 16R  
2.13.2 Take-off Run Available: 8500  
2.13.3 Take-off Distance Available: 8500  
2.13.4 Accelerate-Stop Distance Available: 8500  
2.13.5 Landing Distance Available: 8500

2.13.1 Designation: 34L  
2.13.2 Take-off Run Available: 8500  
2.13.3 Take-off Distance Available: 8500  
2.13.4 Accelerate-Stop Distance Available: 8500  
2.13.5 Landing Distance Available: 8500

**AD 2.14 Approach and Runway Lighting**

2.14.1 Designation: 16C  
2.14.2 Approach Lighting System: ALSF2  
2.14.4 Visual Approach Slope Indicator System: P4L

2.14.1 Designation: 34C  
2.14.2 Approach Lighting System: MALSR  
2.14.4 Visual Approach Slope Indicator System: P4L

2.14.1 Designation: 16L  
2.14.2 Approach Lighting System: ALSF2  
2.14.4 Visual Approach Slope Indicator System: P4L

2.14.1 Designation: 34R  
2.14.2 Approach Lighting System: MALSR  
2.14.4 Visual Approach Slope Indicator System: P4L

2.14.1 Designation: 16R  
2.14.2 Approach Lighting System: ALSF2  
2.14.4 Visual Approach Slope Indicator System: P4R

2.14.1 Designation: 34L  
2.14.2 Approach Lighting System: MALSR  
2.14.4 Visual Approach Slope Indicator System: P4L

**AD 2.18 Air Traffic Services Communication Facilities**

2.18.1 Service Designation: CD/P  
2.18.3 Channel: 128  
2.18.5 Hours of Operation: 24

2.18.1 Service Designation: D-ATIS  
2.18.3 Channel: 118  
2.18.5 Hours of Operation: 24

2.18.1 Service Designation: EMERG  
2.18.3 Channel: 121.5  
2.18.5 Hours of Operation:

2.18.1 Service Designation: EMERG  
2.18.3 Channel: 243  
2.18.5 Hours of Operation:

2.18.1 Service Designation: GND/P  
2.18.3 Channel: 121.7  
2.18.5 Hours of Operation: 24

2.18.1 Service Designation: LCL/P (RWY 16L/34R, 16C/34C)  
2.18.3 Channel: 119.9  
2.18.5 Hours of Operation: 24

2.18.1 Service Designation: LCL/P (RWY 16R/34L)  
2.18.3 Channel: 120.95  
2.18.5 Hours of Operation: 24

2.18.1 Service Designation: LCL/P (RWY 16L/34R, 16C/34C)  
2.18.3 Channel: 239.3  
2.18.5 Hours of Operation: 24

2.18.1 Service Designation: LCL/P (RWY 16R/34L)  
2.18.3 Channel: 239.3  
2.18.5 Hours of Operation: 24

2.18.1 Service Designation: RAMP CTL (SOUTH RAMP)  
2.18.3 Channel: 122.275  
2.18.5 Hours of Operation: 24

2.18.1 Service Designation: RAMP CTL (GATE HOLD)  
2.18.3 Channel: 126.25  
2.18.5 Hours of Operation: 24

2.18.1 Service Designation: RAMP CTL (NORTH RAMP)  
2.18.3 Channel: 126.875  
2.18.5 Hours of Operation: 24

#### **AD 2.19 Radio Navigation and Landing Aids**

2.19.1 ILS Type: DME for runway 16C. Magnetic variation: 16E  
2.19.2 ILS Identification: SZI  
2.19.5 Coordinates: 47-26-6.28N / 122-18-39.51W  
2.19.6 Site Elevation: 359 ft

2.19.1 ILS Type: Glide Slope for runway 16C. Magnetic variation: 16E  
2.19.2 ILS Identification: SZI  
2.19.5 Coordinates: 47-27-38.687N / 122-18-45.462W  
2.19.6 Site Elevation: 417.6 ft

2.19.1 ILS Type: Localizer for runway 16C. Magnetic variation: 16E  
2.19.2 ILS Identification: SZI

2.19.5 Coordinates: 47-26-6.703N / 122-18-40.4438W  
2.19.6 Site Elevation: 355.7 ft

2.19.1 ILS Type: DME for runway 34C. Magnetic variation: 16E  
2.19.2 ILS Identification: TUC  
2.19.5 Coordinates: 47-26-6.28N / 122-18-39.51W  
2.19.6 Site Elevation: 359 ft

2.19.1 ILS Type: Glide Slope for runway 34C. Magnetic variation: 16E  
2.19.2 ILS Identification: TUC  
2.19.5 Coordinates: 47-26-25.6028N / 122-18-46.1679W  
2.19.6 Site Elevation: 366.8 ft

2.19.1 ILS Type: Localizer for runway 34C. Magnetic variation: 16E  
2.19.2 ILS Identification: TUC  
2.19.5 Coordinates: 47-27-54.3525N / 122-18-39.5018W  
2.19.6 Site Elevation: 421.8 ft

2.19.1 ILS Type: DME for runway 16L. Magnetic variation: 16E  
2.19.2 ILS Identification: SNQ  
2.19.5 Coordinates: 47-26-3.5974N / 122-18-22.6779W  
2.19.6 Site Elevation: 369.4 ft

2.19.1 ILS Type: Glide Slope for runway 16L. Magnetic variation: 16E  
2.19.2 ILS Identification: SNQ  
2.19.5 Coordinates: 47-27-38.9362N / 122-18-33.8193W  
2.19.6 Site Elevation: 425.2 ft

2.19.1 ILS Type: Localizer for runway 16L. Magnetic variation: 16E  
2.19.2 ILS Identification: SNQ  
2.19.5 Coordinates: 47-25-42.224N / 122-18-29.0263W  
2.19.6 Site Elevation: 335.5 ft

2.19.1 ILS Type: DME for runway 34R. Magnetic variation: 16E  
2.19.2 ILS Identification: SEA  
2.19.5 Coordinates: 47-26-3.5974N / 122-18-22.6779W  
2.19.6 Site Elevation: 369.4 ft

2.19.1 ILS Type: Glide Slope for runway 34R. Magnetic variation: 16E  
2.19.2 ILS Identification: SEA  
2.19.5 Coordinates: 47-26-3.3996N / 122-18-23.0248W  
2.19.6 Site Elevation: 355.1 ft

2.19.1 ILS Type: Localizer for runway 34R. Magnetic variation: 16E  
2.19.2 ILS Identification: SEA  
2.19.5 Coordinates: 47-27-54.2762N / 122-18-27.8613W  
2.19.6 Site Elevation: 428.1 ft

2.19.1 ILS Type: DME for runway 16R. Magnetic variation: 16E  
2.19.2 ILS Identification: CJL  
2.19.5 Coordinates: 47-26-15.6195N / 122-18-59.9408W



2.19.6 Site Elevation: 344.8 ft

2.19.1 ILS Type: Glide Slope for runway 16R. Magnetic variation: 16E

2.19.2 ILS Identification: CJL

2.19.5 Coordinates: 47-27-38.4647N / 122-19-0.5973W

2.19.6 Site Elevation: 405.5 ft

2.19.1 ILS Type: Localizer for runway 16R. Magnetic variation: 16E

2.19.2 ILS Identification: CJL

2.19.5 Coordinates: 47-26-15.9249N / 122-19-5.0962W

2.19.6 Site Elevation: 343.7 ft

2.19.1 ILS Type: DME for runway 34L. Magnetic variation: 16E

2.19.2 ILS Identification: BEJ

2.19.5 Coordinates: 47-26-15.6195N / 122-18-59.9408W

2.19.6 Site Elevation: 344.8 ft

2.19.1 ILS Type: Glide Slope for runway 34L. Magnetic variation: 16E

2.19.2 ILS Identification: BEJ

2.19.5 Coordinates: 47-26-34.9351N / 122-18-59.9836W

2.19.6 Site Elevation: 358.5 ft

2.19.1 ILS Type: Localizer for runway 34L. Magnetic variation: 16E

2.19.2 ILS Identification: BEJ

2.19.5 Coordinates: 47-27-59.7764N / 122-19-4.1986W

2.19.6 Site Elevation: 409.5 ft

2.19.1 Navigation Aid Type: VORTAC. Magnetic variation: 19E

2.19.2 Navigation Aid Identification: SEA

2.19.5 Coordinates: 47-26-7.3434N / 122-18-34.618W

2.19.6 Site Elevation: 348.4 ft

**General Remarks:**

(E94) WSO/WSFO.

RWY 16L/34R RSTD TO ACFT WITH WINGSPAN 260 FT OR LESS.

TAXILANE W RSTD TO ACFT WITH WINGSPAN 135 FT OR LESS N OF TWY N AND 167 FT OR LESS SOUTH OF TWY N. SEATTLE RAMP TWR PRVDS ADZY CTL ONLY.

AIR CARGO 5 RAMP DUAL ENG TAX ONLY

TWYS J & H E OF TWY T RSTD TO ACFT WITH WINGSPAN 167 FT OR LESS.

ASDE-X IN USE. OPERATE TRANSPONDERS WITH ALTITUDE REPORTING MODE AND ADS-B (IF EQUIPPED) ENABLED ON ALL AIRPORT SURFACES.

RPRT BIRD STRIKES TO 206-787-7233

TWY H E OF RWY 16L/34R RSTD TO ACFT WITH WINGSPAN 118 FT OR LESS WHEN EXITING RWY 16L/34R.

HELICOPTERS LANDING & DEPARTING AVOID OVERFLYING FUEL FARM LCTD AT THE SE CORNER OF THE ARPT.

DO NOT MISTAKE TWY T FOR LNDG SFC.

ACES TO AIR CARGO 4 PRKG AND CARGO AREAS RSTD TO ACFT WITH WINGSPAN 170 FT OR LESS.

(E110) CONTINUOUS POWER ARPT.

PPR FOR ALL GA PRKG & SVCS, CTC 206-433-5481. OP HRS 0530L - 2100L, WITH A CALL OUT AVBL UPON REQ.

TWY B SOUTH OF AIR CARGO 7 RAMP RSTD TO ACFT WITH WINGSPAN 260 FT OR LESS.

TWY FOR CORPORATE HNGR RAMP RSTD TO ACFT WITH WINGSPAN 62 FT OR LESS FOR TAXI OPS. GA CUST PKNG IS VERY LTD.

RY STATUS LGTS ARE IN OPN.

TWY A SOUTH OF TWY G RSTD TO ACFT WITH WINGSPAN 225 FT OR LESS.

100LL FUEL NOT AVBL.

TWY B S OF TWY Q RSTD TO ACFT WITH WINGSPAN 260 FT OR LESS.

BIRD FLOCKS WITHIN ARPT VCNTY - CHECK LCL ADZYS.

THE USE OF REVERSE THRUST BYD WHAT IS NEC FOR OPNL OR SAFETY RSNS IS DISCOURAGED AT ALL TIMES. NOISE ABATEMENT FLT PROCS IN EFCT BTN 2200-0600. FOR FURTHER INFO CTC SEA NOISE ABATEMENT OFC AT 206-787-5393.

TAXILANE ON N SIDE OF N STLT RSTD TO ACFT WITH WINGSPAN 118 FT OR LESS. TRI-TAXILANES AT N STLT: CNTR (GREEN) TAXILANE RSTD TO ACFT WITH WINGSPAN 135 FT OR LESS. WHEN AN ACFT IS ON THE CNTR (GREEN) OR OTR (ORANGE/BLUE) TAXILANES, NO OTR ACFT CAN SIMUL USE THE ADJ TAXILANE(S). ORANGE & BLUE TAXILANES ARE RSTD TO ACFT WITH WINGSPAN 118 FT OR LESS. TWO ACFT CAN SIMUL USE THE OUTER TAXILANES.

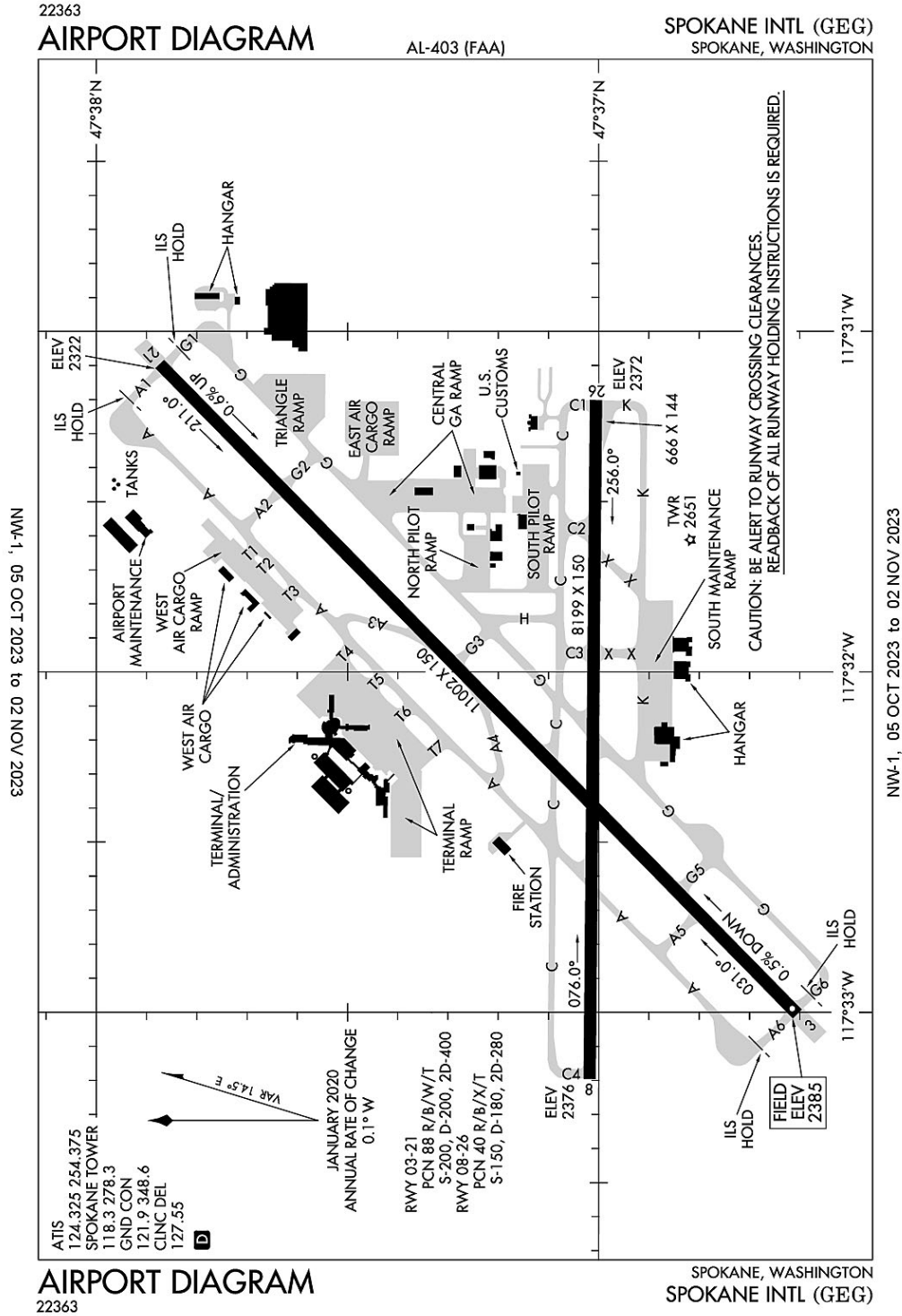
GA LANDING FEES PAYABLE BY MAJOR CREDIT CARDS ONLY.

ACFT WITH WINGSPANS OF 171 FT. OR MORE PARKED AT PAX GATES OR CARGO 7 MUST PROVIDE 30 MIN PPR PRIOR TO PUSHBACK TO SEATTLE RAMP TWR WHEN VSBY LESS THAN 2400 RVR

CONS TAXI TO TKOFS AT SEA. WHEN PRACTICAL, SAFE AND AVBL, CONS TAXI TO TKOFS ARE ENCOURAGED. CONS TAXI TO TKOFS MAY RDC ACFT NOISE WI NEARBY COMMUNITIES.

FLIGHT NOTIFICATION SERVICE (ADCUS) AVBL.

**Spokane, Washington  
Spokane International  
ICAO Identifier KEGG**



**Spokane, WA**  
**Spokane Intl**  
**ICAO Identifier KGEG**

**AD 2.2 Aerodrome geographical and administrative data**

- 2.2.1 Reference Point: 47-37-8.5N / 117-32-6.8W
- 2.2.2 From City: 5 miles SW of SPOKANE, WA
- 2.2.3 Elevation: 2385 ft
- 2.2.5 Magnetic Variation: 14E (2020)
- 2.2.6 Airport Contact: LAWRENCE J KRAUTER  
9000 W AIRPORT DR.  
SPOKANE, WA 99224 ((509) 455-6418)
- 2.2.7 Traffic: IFR/VFR

**AD 2.3 Attendance Schedule**

- 2.3.1 All Months, All Days, All Hours

**AD 2.4 Handling Services and Facilities**

- 2.4.1 Cargo Handling Facilities: YES
- 2.4.2 Fuel Types: 100,100LL,A
- 2.4.5 Hangar Space: YES
- 2.4.6 Repair Facilities: MAJOR

**AD 2.6 Rescue and Firefighting Services**

- 2.6.1 Aerodrome Category: Class-I certified on 5/1/1973
- 2.6.2 Rescue and Firefighting Services: ARFF Index-C

**AD 2.12 Runway Physical Characteristics**

- 2.12.1 Designation: 03
- 2.12.2 True Bearing: 45
- 2.12.3 Dimensions: 11002 ft x 150 ft
- 2.12.4 PCN: 88 R/B/W/T
- 2.12.5 Coordinates: 47-36-36.2909N / 117-33-0.2876W
- 2.12.6 Threshold Elevation: 2385 ft
- 2.12.6 Touchdown Zone Elevation: 2385 ft
  
- 2.12.1 Designation: 21
- 2.12.2 True Bearing: 225
- 2.12.3 Dimensions: 11002 ft x 150 ft
- 2.12.4 PCN: 88 R/B/W/T
- 2.12.5 Coordinates: 47-37-52.3811N / 117-31-5.7573W
- 2.12.6 Threshold Elevation: 2322.4 ft
- 2.12.6 Touchdown Zone Elevation: 2346.1 ft
  
- 2.12.1 Designation: 08
- 2.12.2 True Bearing: 90
- 2.12.3 Dimensions: 8199 ft x 150 ft
- 2.12.4 PCN: 40 R/B/X/T
- 2.12.5 Coordinates: 47-37-1.0687N / 117-33-11.7639W
- 2.12.6 Threshold Elevation: 2376.2 ft
- 2.12.6 Touchdown Zone Elevation: 2376.2 ft

- 2.12.1 Designation: 26
- 2.12.2 True Bearing: 270
- 2.12.3 Dimensions: 8199 ft x 150 ft
- 2.12.4 PCN: 40 R/B/X/T
- 2.12.5 Coordinates: 47-37-0.3642N / 117-31-12.1045W
- 2.12.6 Threshold Elevation: 2371.5 ft
- 2.12.6 Touchdown Zone Elevation: 2371.5 ft

**AD 2.13 Declared Distances**

- 2.13.1 Designation: 03
- 2.13.2 Take-off Run Available: 11002
- 2.13.3 Take-off Distance Available: 11002
- 2.13.4 Accelerate-Stop Distance Available: 11002
- 2.13.5 Landing Distance Available: 11002

- 2.13.1 Designation: 21
- 2.13.2 Take-off Run Available: 11002
- 2.13.3 Take-off Distance Available: 11002
- 2.13.4 Accelerate-Stop Distance Available: 11002
- 2.13.5 Landing Distance Available: 11002

- 2.13.1 Designation: 08
- 2.13.2 Take-off Run Available: 8199
- 2.13.3 Take-off Distance Available: 8199
- 2.13.4 Accelerate-Stop Distance Available: 8199
- 2.13.5 Landing Distance Available: 8199

- 2.13.1 Designation: 26
- 2.13.2 Take-off Run Available: 8199
- 2.13.3 Take-off Distance Available: 8199
- 2.13.4 Accelerate-Stop Distance Available: 8199
- 2.13.5 Landing Distance Available: 8199

**AD 2.14 Approach and Runway Lighting**

- 2.14.1 Designation: 03
- 2.14.2 Approach Lighting System: ALSF2
- 2.14.4 Visual Approach Slope Indicator System: P4L

- 2.14.1 Designation: 21
- 2.14.2 Approach Lighting System: ALSF2
- 2.14.4 Visual Approach Slope Indicator System: P4L

- 2.14.1 Designation: 08
- 2.14.2 Approach Lighting System:
- 2.14.4 Visual Approach Slope Indicator System: P4R

- 2.14.1 Designation: 26
- 2.14.2 Approach Lighting System:

2.14.4 Visual Approach Slope Indicator System: P4L

**AD 2.18 Air Traffic Services Communication Facilities**

2.18.1 Service Designation: APCH/P DEP/P IC (205-025)

2.18.3 Channel: 123.75

2.18.5 Hours of Operation: 24

2.18.1 Service Designation: APCH/P DEP/P IC (026-204)

2.18.3 Channel: 133.35

2.18.5 Hours of Operation: 24

2.18.1 Service Designation: APCH/P DEP/P IC (026-204)

2.18.3 Channel: 263

2.18.5 Hours of Operation: 24

2.18.1 Service Designation: APCH/P DEP/P IC (205-025)

2.18.3 Channel: 282.25

2.18.5 Hours of Operation: 24

2.18.1 Service Designation: APCH/S DEP/S

2.18.3 Channel: 372.9

2.18.5 Hours of Operation: 24

2.18.1 Service Designation: ATIS

2.18.3 Channel: 124.325

2.18.5 Hours of Operation: 24

2.18.1 Service Designation: ATIS

2.18.3 Channel: 254.375

2.18.5 Hours of Operation: 24

2.18.1 Service Designation: CD/P

2.18.3 Channel: 127.55

2.18.5 Hours of Operation: 24

2.18.1 Service Designation: CLASS C (205-025)

2.18.3 Channel: 123.75

2.18.5 Hours of Operation: 24

2.18.1 Service Designation: CLASS C (026-204)

2.18.3 Channel: 133.35

2.18.5 Hours of Operation: 24

2.18.1 Service Designation: CLASS C (026-204)

2.18.3 Channel: 263

2.18.5 Hours of Operation: 24

2.18.1 Service Designation: CLASS C (205-025)

2.18.3 Channel: 282.25

2.18.5 Hours of Operation: 24

2.18.1 Service Designation: EMERG  
2.18.3 Channel: 121.5  
2.18.5 Hours of Operation:

2.18.1 Service Designation: EMERG  
2.18.3 Channel: 243  
2.18.5 Hours of Operation:

2.18.1 Service Designation: GND/P  
2.18.3 Channel: 121.9  
2.18.5 Hours of Operation: 24

2.18.1 Service Designation: GND/P  
2.18.3 Channel: 348.6  
2.18.5 Hours of Operation: 24

2.18.1 Service Designation: HILIE STAR  
2.18.3 Channel: 133.35  
2.18.5 Hours of Operation: 24

2.18.1 Service Designation: HILIE STAR  
2.18.3 Channel: 263  
2.18.5 Hours of Operation: 24

2.18.1 Service Designation: LCL/P  
2.18.3 Channel: 118.3  
2.18.5 Hours of Operation: 24

2.18.1 Service Designation: LCL/P  
2.18.3 Channel: 278.3  
2.18.5 Hours of Operation: 24

2.18.1 Service Designation: ZOOMR STAR  
2.18.3 Channel: 123.75  
2.18.5 Hours of Operation: 24

2.18.1 Service Designation: ZOOMR STAR  
2.18.3 Channel: 282.25  
2.18.5 Hours of Operation: 24

**AD 2.19 Radio Navigation and Landing Aids**

2.19.1 ILS Type: DME for runway 03. Magnetic variation: 14E  
2.19.2 ILS Identification: OIJ  
2.19.5 Coordinates: 47-36-32.05N / 117-33-15.1W  
2.19.6 Site Elevation: 2380.2 ft

2.19.1 ILS Type: Glide Slope for runway 03. Magnetic variation: 14E  
2.19.2 ILS Identification: OIJ  
2.19.5 Coordinates: 47-36-47.5569N / 117-32-51.8755W

2.19.6 Site Elevation: 2372 ft

2.19.1 ILS Type: Localizer for runway 03. Magnetic variation: 14E  
2.19.2 ILS Identification: OLJ  
2.19.5 Coordinates: 47-37-59.6757N / 117-30-54.7682W  
2.19.6 Site Elevation: 2315.7 ft

2.19.1 ILS Type: DME for runway 21. Magnetic variation: 14E  
2.19.2 ILS Identification: GEG  
2.19.5 Coordinates: 47-36-32.05N / 117-33-15.1W  
2.19.6 Site Elevation: 2380.2 ft

2.19.1 ILS Type: Glide Slope for runway 21. Magnetic variation: 14E  
2.19.2 ILS Identification: GEG  
2.19.5 Coordinates: 47-37-48.959N / 117-31-19.4519W  
2.19.6 Site Elevation: 2324.3 ft

2.19.1 ILS Type: Localizer for runway 21. Magnetic variation: 14E  
2.19.2 ILS Identification: GEG  
2.19.5 Coordinates: 47-36-29.2008N / 117-33-10.9524W  
2.19.6 Site Elevation: 2380.1 ft

2.19.1 Navigation Aid Type: VORTAC. Magnetic variation: 14E  
2.19.2 Navigation Aid Identification: GEG  
2.19.5 Coordinates: 47-33-53.805N / 117-37-36.789W  
2.19.6 Site Elevation: 2756.3 ft

**General Remarks:**

PORTIONS OF TWY K NOT VISIBLE FM ATCT.

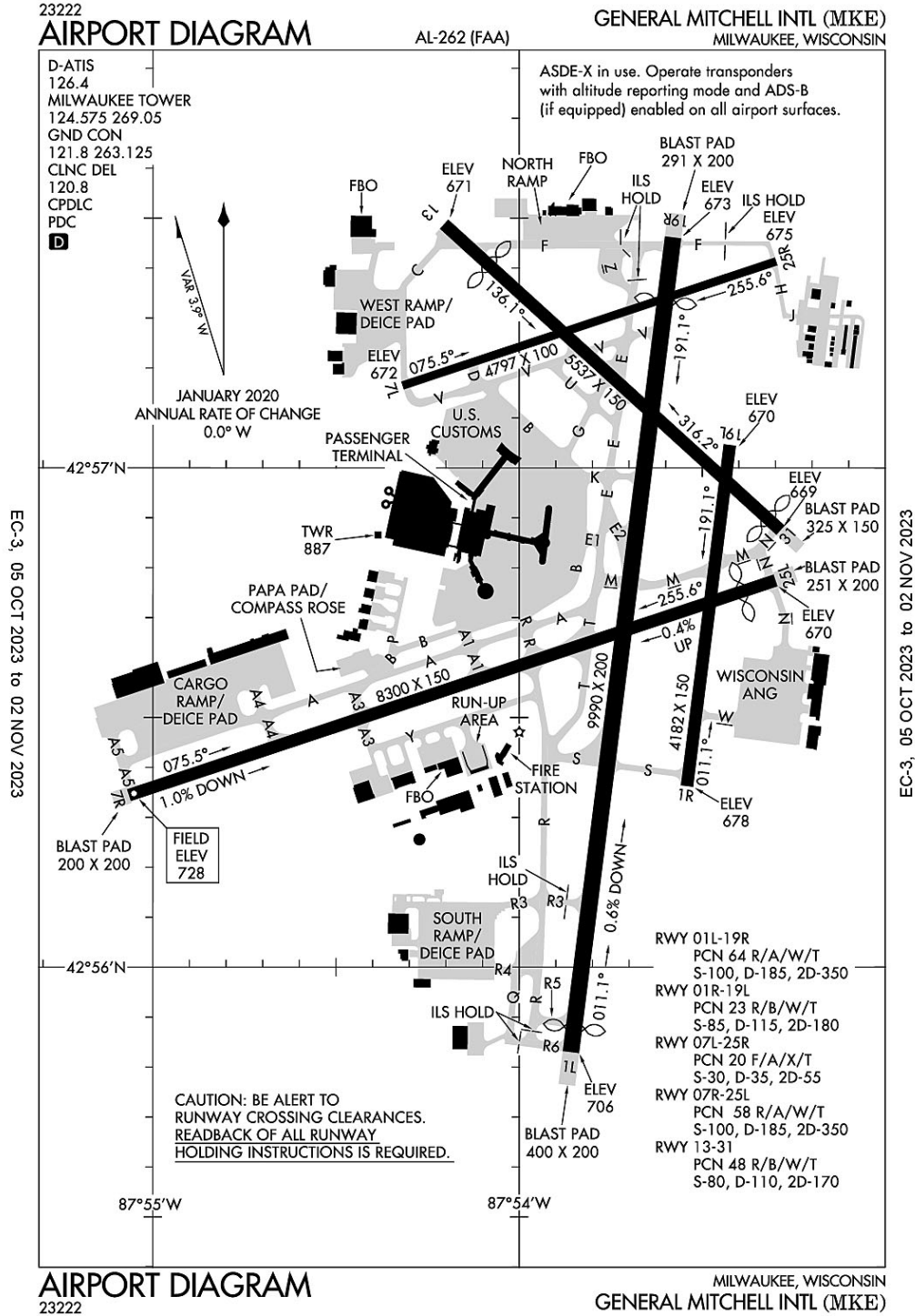
TWY K UNLGTD ON RAMP SIDE ALONG MAINTENANCE RAMP AND IS UNAVBL BELOW 1200 RVR UNLESS UNDER ESCORT BY "FOLLOW ME".

BE ALERT TO TURBULENCE OVER SMOKE STACKS 1 MILE EAST OF ARPT.

WATERFOWL & BIRDS ON & INVOF ARPT.



**Milwaukee, Wisconsin  
General Mitchell International  
ICAO Identifier KMKE**



**Milwaukee, WI**  
**General Mitchell Intl**  
**ICAO Identifier KMKE**

**AD 2.2 Aerodrome geographical and administrative data**

- 2.2.1 Reference Point: 42-56-48.955N / 87-53-49.432W
- 2.2.2 From City: 5 miles S of MILWAUKEE, WI
- 2.2.3 Elevation: 728.4 ft
- 2.2.5 Magnetic Variation: 4W (2020)
- 2.2.6 Airport Contact: BRIAN DRANZIK  
5300 S HOWELL AVE  
MILWAUKEE, WI 53207 (414-747-5300)
- 2.2.7 Traffic: IFR/VFR

**AD 2.3 Attendance Schedule**

- 2.3.1 All Months, All Days, All Hours

**AD 2.4 Handling Services and Facilities**

- 2.4.1 Cargo Handling Facilities: YES
- 2.4.2 Fuel Types: 100LL,A
- 2.4.5 Hangar Space: YES
- 2.4.6 Repair Facilities: MAJOR

**AD 2.6 Rescue and Firefighting Services**

- 2.6.1 Aerodrome Category: Class-I certified on 5/1/1973
- 2.6.2 Rescue and Firefighting Services: ARFF Index-C

**AD 2.12 Runway Physical Characteristics**

- 2.12.1 Designation: 19R
- 2.12.2 True Bearing: 187
- 2.12.3 Dimensions: 9990 ft x 200 ft
- 2.12.4 PCN: 64 R/A/W/T
- 2.12.5 Coordinates: 42-57-27.699N / 87-53-34.7753W
- 2.12.6 Threshold Elevation: 672.7 ft
- 2.12.6 Touchdown Zone Elevation: 671.9 ft

- 2.12.1 Designation: 01L
- 2.12.2 True Bearing: 7
- 2.12.3 Dimensions: 9990 ft x 200 ft
- 2.12.4 PCN: 64 R/A/W/T
- 2.12.5 Coordinates: 42-55-49.7963N / 87-53-51.516W
- 2.12.6 Threshold Elevation: 705.8 ft
- 2.12.6 Touchdown Zone Elevation: 703.5 ft

- 2.12.1 Designation: 01R
- 2.12.2 True Bearing: 7
- 2.12.3 Dimensions: 4182 ft x 150 ft
- 2.12.4 PCN: 23 R/B/W/T
- 2.12.5 Coordinates: 42-56-21.766N / 87-53-32.5016W
- 2.12.6 Threshold Elevation: 677.7 ft
- 2.12.6 Touchdown Zone Elevation: 677.7 ft

2.12.1 Designation: 19L  
2.12.2 True Bearing: 187  
2.12.3 Dimensions: 4182 ft x 150 ft  
2.12.4 PCN: 23 R/B/W/T  
2.12.5 Coordinates: 42-57-2.7448N / 87-53-25.4878W  
2.12.6 Threshold Elevation: 669.6 ft  
2.12.6 Touchdown Zone Elevation: 674.2 ft

2.12.1 Designation: 07L  
2.12.2 True Bearing: 72  
2.12.3 Dimensions: 4797 ft x 100 ft  
2.12.4 PCN: 20 F/A/X/T  
2.12.5 Coordinates: 42-57-9.8896N / 87-54-19.1101W  
2.12.6 Threshold Elevation: 671.5 ft  
2.12.6 Touchdown Zone Elevation: 672 ft

2.12.1 Designation: 25R  
2.12.2 True Bearing: 252  
2.12.3 Dimensions: 4797 ft x 100 ft  
2.12.4 PCN: 20 F/A/X/T  
2.12.5 Coordinates: 42-57-24.8031N / 87-53-17.893W  
2.12.6 Threshold Elevation: 674.6 ft  
2.12.6 Touchdown Zone Elevation: 674.6 ft

2.12.1 Designation: 25L  
2.12.2 True Bearing: 252  
2.12.3 Dimensions: 8300 ft x 150 ft  
2.12.4 PCN: 58 R/A/W/T  
2.12.5 Coordinates: 42-56-46.473N / 87-53-18.0003W  
2.12.6 Threshold Elevation: 669.9 ft  
2.12.6 Touchdown Zone Elevation: 683.1 ft

2.12.1 Designation: 07R  
2.12.2 True Bearing: 72  
2.12.3 Dimensions: 8300 ft x 150 ft  
2.12.4 PCN: 58 R/A/W/T  
2.12.5 Coordinates: 42-56-20.6652N / 87-55-3.9117W  
2.12.6 Threshold Elevation: 728.4 ft  
2.12.6 Touchdown Zone Elevation: 728.4 ft

2.12.1 Designation: 13  
2.12.2 True Bearing: 132  
2.12.3 Dimensions: 5537 ft x 150 ft  
2.12.4 PCN: 48 R/B/W/T  
2.12.5 Coordinates: 42-57-29.2767N / 87-54-12.2946W  
2.12.6 Threshold Elevation: 671.4 ft  
2.12.6 Touchdown Zone Elevation: 670.5 ft

2.12.1 Designation: 31  
2.12.2 True Bearing: 312

- 2.12.3 Dimensions: 5537 ft x 150 ft
- 2.12.4 PCN: 48 R/B/W/T
- 2.12.5 Coordinates: 42-56-52.5074N / 87-53-17.1839W
- 2.12.6 Threshold Elevation: 668.6 ft
- 2.12.6 Touchdown Zone Elevation: 670.1 ft

**AD 2.13 Declared Distances**

- 2.13.1 Designation: 19R
- 2.13.2 Take-off Run Available: 9990
- 2.13.3 Take-off Distance Available: 9990
- 2.13.4 Accelerate-Stop Distance Available: 9990
- 2.13.5 Landing Distance Available: 9205

- 2.13.1 Designation: 01L
- 2.13.2 Take-off Run Available: 9990
- 2.13.3 Take-off Distance Available: 9990
- 2.13.4 Accelerate-Stop Distance Available: 9380
- 2.13.5 Landing Distance Available: 9080

- 2.13.1 Designation: 01R
- 2.13.2 Take-off Run Available: 4182
- 2.13.3 Take-off Distance Available: 4182
- 2.13.4 Accelerate-Stop Distance Available: 4182
- 2.13.5 Landing Distance Available: 4182

- 2.13.1 Designation: 19L
- 2.13.2 Take-off Run Available: 4182
- 2.13.3 Take-off Distance Available: 4182
- 2.13.4 Accelerate-Stop Distance Available: 4182
- 2.13.5 Landing Distance Available: 4182

- 2.13.1 Designation: 07L
- 2.13.2 Take-off Run Available: 4797
- 2.13.3 Take-off Distance Available: 4797
- 2.13.4 Accelerate-Stop Distance Available: 4797
- 2.13.5 Landing Distance Available: 4797

- 2.13.1 Designation: 25R
- 2.13.2 Take-off Run Available: 4797
- 2.13.3 Take-off Distance Available: 4797
- 2.13.4 Accelerate-Stop Distance Available: 4797
- 2.13.5 Landing Distance Available: 4797

- 2.13.1 Designation: 25L
- 2.13.2 Take-off Run Available: 8300
- 2.13.3 Take-off Distance Available: 8300
- 2.13.4 Accelerate-Stop Distance Available: 8300
- 2.13.5 Landing Distance Available: 7867

- 2.13.1 Designation: 07R

2.13.2 Take-off Run Available: 8300  
2.13.3 Take-off Distance Available: 8300  
2.13.4 Accelerate-Stop Distance Available: 8012  
2.13.5 Landing Distance Available: 8012

2.13.1 Designation: 13  
2.13.2 Take-off Run Available: 5537  
2.13.3 Take-off Distance Available: 5537  
2.13.4 Accelerate-Stop Distance Available: 5537  
2.13.5 Landing Distance Available: 4797

2.13.1 Designation: 31  
2.13.2 Take-off Run Available: 5537  
2.13.3 Take-off Distance Available: 5537  
2.13.4 Accelerate-Stop Distance Available: 5537  
2.13.5 Landing Distance Available: 5152

**AD 2.14 Approach and Runway Lighting**

2.14.1 Designation: 19R  
2.14.2 Approach Lighting System: MALSR  
2.14.4 Visual Approach Slope Indicator System: P4R

2.14.1 Designation: 01L  
2.14.2 Approach Lighting System: ALSF2  
2.14.4 Visual Approach Slope Indicator System: P4R

2.14.1 Designation: 01R  
2.14.2 Approach Lighting System:  
2.14.4 Visual Approach Slope Indicator System:

2.14.1 Designation: 19L  
2.14.2 Approach Lighting System:  
2.14.4 Visual Approach Slope Indicator System:

2.14.1 Designation: 07L  
2.14.2 Approach Lighting System:  
2.14.4 Visual Approach Slope Indicator System: P4L

2.14.1 Designation: 25R  
2.14.2 Approach Lighting System:  
2.14.4 Visual Approach Slope Indicator System: P4R

2.14.1 Designation: 25L  
2.14.2 Approach Lighting System:  
2.14.4 Visual Approach Slope Indicator System: P4L

2.14.1 Designation: 07R  
2.14.2 Approach Lighting System: MALSR  
2.14.4 Visual Approach Slope Indicator System: P4L

2.14.1 Designation: 13  
2.14.2 Approach Lighting System:  
2.14.4 Visual Approach Slope Indicator System: P4L

2.14.1 Designation: 31  
2.14.2 Approach Lighting System:  
2.14.4 Visual Approach Slope Indicator System: P4R

**AD 2.18 Air Traffic Services Communication Facilities**

2.18.1 Service Designation: APCH/P (B SE)  
2.18.3 Channel: 118  
2.18.5 Hours of Operation: 24

2.18.1 Service Designation: APCH/P DEP/P (B SE)  
2.18.3 Channel: 317.725  
2.18.5 Hours of Operation: 24

2.18.1 Service Designation: APCH/P DEP/P IC (A NW)  
2.18.3 Channel: 307  
2.18.5 Hours of Operation: 24

2.18.1 Service Designation: APCH/P IC (A NW)  
2.18.3 Channel: 126.5  
2.18.5 Hours of Operation: 24

2.18.1 Service Designation: CD/P  
2.18.3 Channel: 120.8  
2.18.5 Hours of Operation: 24

2.18.1 Service Designation: CLASS C (B SE)  
2.18.3 Channel: 118  
2.18.5 Hours of Operation: 24

2.18.1 Service Designation: CLASS C (A NW)  
2.18.3 Channel: 126.5  
2.18.5 Hours of Operation: 24

2.18.1 Service Designation: CLASS C (A NW)  
2.18.3 Channel: 307  
2.18.5 Hours of Operation: 24

2.18.1 Service Designation: CLASS C (B SE)  
2.18.3 Channel: 317.725  
2.18.5 Hours of Operation: 24

2.18.1 Service Designation: COMD POST (128 ARW ANG UPSET CTL)  
2.18.3 Channel: 321  
2.18.5 Hours of Operation:

2.18.1 Service Designation: COMD POST (28 ARW ANG UPSET CON)

2.18.3 Channel: 6761

2.18.5 Hours of Operation:

2.18.1 Service Designation: D-ATIS

2.18.3 Channel: 126.4

2.18.5 Hours of Operation: 24

2.18.1 Service Designation: DEP/P (A NW)

2.18.3 Channel: 125.35

2.18.5 Hours of Operation: 24

2.18.1 Service Designation: DEP/P (B SE)

2.18.3 Channel: 135.875

2.18.5 Hours of Operation: 24

2.18.1 Service Designation: EMERG

2.18.3 Channel: 121.5

2.18.5 Hours of Operation:

2.18.1 Service Designation: EMERG

2.18.3 Channel: 243

2.18.5 Hours of Operation:

2.18.1 Service Designation: GND/P

2.18.3 Channel: 121.8

2.18.5 Hours of Operation: 24

2.18.1 Service Designation: GND/P

2.18.3 Channel: 263.125

2.18.5 Hours of Operation: 24

2.18.1 Service Designation: GOPAC STAR

2.18.3 Channel: 126.5

2.18.5 Hours of Operation: 24

2.18.1 Service Designation: GOPAC STAR

2.18.3 Channel: 307

2.18.5 Hours of Operation: 24

2.18.1 Service Designation: LCL/P

2.18.3 Channel: 124.575

2.18.5 Hours of Operation: 24

2.18.1 Service Designation: LCL/P

2.18.3 Channel: 269.05

2.18.5 Hours of Operation: 24

2.18.1 Service Designation: OPS

2.18.3 Channel: 139.5

2.18.5 Hours of Operation:

2.18.1 Service Designation: OPS  
2.18.3 Channel: 311  
2.18.5 Hours of Operation:

**AD 2.19 Radio Navigation and Landing Aids**

2.19.1 ILS Type: DME for runway 01L. Magnetic variation: 4W  
2.19.2 ILS Identification: MKE  
2.19.5 Coordinates: 42-57-50.9407N / 87-53-27.4465W  
2.19.6 Site Elevation: 725 ft

2.19.1 ILS Type: Glide Slope for runway 01L. Magnetic variation: 4W  
2.19.2 ILS Identification: MKE  
2.19.5 Coordinates: 42-56-4.4522N / 87-53-43.0463W  
2.19.6 Site Elevation: 691.4 ft

2.19.1 ILS Type: Inner Marker for runway 01L. Magnetic variation: 4W  
2.19.2 ILS Identification: MKE  
2.19.5 Coordinates: 42-55-44.6539N / 87-53-52.3948W  
2.19.6 Site Elevation: 706 ft

2.19.1 ILS Type: Localizer for runway 01L. Magnetic variation: 4W  
2.19.2 ILS Identification: MKE  
2.19.5 Coordinates: 42-57-49.9549N / 87-53-30.968W  
2.19.6 Site Elevation: 713 ft

2.19.1 ILS Type: DME for runway 19R. Magnetic variation: 4W  
2.19.2 ILS Identification: BLY  
2.19.5 Coordinates: 42-57-50.9407N / 87-53-27.4465W  
2.19.6 Site Elevation: 725 ft

2.19.1 ILS Type: Glide Slope for runway 19R. Magnetic variation: 4W  
2.19.2 ILS Identification: BLY  
2.19.5 Coordinates: 42-57-9.1784N / 87-53-32.5226W  
2.19.6 Site Elevation: 666.4 ft

2.19.1 ILS Type: Localizer for runway 19R. Magnetic variation: 4W  
2.19.2 ILS Identification: BLY  
2.19.5 Coordinates: 42-55-38.3041N / 87-53-53.4819W  
2.19.6 Site Elevation: 709.2 ft

2.19.1 ILS Type: DME for runway 07R. Magnetic variation: 4W  
2.19.2 ILS Identification: GMF  
2.19.5 Coordinates: 42-56-18.5074N / 87-55-23.6562W  
2.19.6 Site Elevation: 743.1 ft

2.19.1 ILS Type: Glide Slope for runway 07R. Magnetic variation: 4W  
2.19.2 ILS Identification: GMF  
2.19.5 Coordinates: 42-56-20.4936N / 87-54-47.1205W  
2.19.6 Site Elevation: 707.3 ft



2.19.1 ILS Type: Localizer for runway 07R. Magnetic variation: 4W  
2.19.2 ILS Identification: GMF  
2.19.5 Coordinates: 42-56-49.0824N / 87-53-7.2728W  
2.19.6 Site Elevation: 669.1 ft

2.19.1 ILS Type: DME for runway 25L. Magnetic variation: 4W  
2.19.2 ILS Identification: PXY  
2.19.5 Coordinates: 42-56-18.5074N / 87-55-23.6562W  
2.19.6 Site Elevation: 743.1 ft

2.19.1 ILS Type: Localizer for runway 25L. Magnetic variation: 4W  
2.19.2 ILS Identification: PXY  
2.19.5 Coordinates: 42-56-16.0665N / 87-55-22.7833W  
2.19.6 Site Elevation: 728 ft

**General Remarks:**

TWY B BTN TWY V AND TWY P CLSD TO ACFT WITH WINGSPAN GREATER THAN 170 FT.

RY 19R TODA 8,750 FT FROM INT TWY V.

RY 07L/25R NO ACFT 65,000 LBS OR GREATER ALLOWED TO TAXI BTN TWY D & RY 13/31 AND EAST OF RY 19R.

TWY A CLSD FM TWY R TO TWY E AND TWY E CLSD FM TWY T TO TWY E1 AND TWY T CLSD N OF RWY 07R/25L, AND TWY M CLSD FM TWY E TO RWY 01R/19L TO ACFT WITH TAIL HGT GTR THAN 54.5 FT DURG CAT II AND CAT III OPS.

TWY A CLSD BTN TWY A4 AND TWY A5 TO ACFT WITH WINGSPAN GREATER THAN OR EQUAL TO 214' UNLESS PERMISSION FROM ARPT MGR 414-747-5325

ALL AIRCRAFT PUSHBACKS FROM GATES C20, C21, C22, C23, D39 D41 D43, D45, D48, D51, D53, D54, D55, E65, E66, & E67 REQUIRE CLEARANCE FROM GROUND CONTROL. PUSHBACKS FROM ALL OTHER GATES ARE AT RAMP/ PILOT DISCRETION; CONTACT GROUND CONTROL WHEN READY TO TAXI.

ACFT ARE NOT PERMITTED TO MAKE LEFT TURN ONTO TWY E WHEN EXITING TWY E2.

TWY S & TWY T BTN TWY R & RY 07R/25L AND RY 07R/25L BTN RY 1R/19L & TWY R CLSD DURG CAT II & III OPNS.

HOLDING BAY AT RY 01L CLSD EXCP ACFT WITH WINGSPAN LESS THAN 118 FT.

TWY A BTN TWY R AND TWY A1 CLSD TO ACFT WINGSPAN MORE THAN 171 FT EXC PPR 414-747-5325.

TWY F (E OF RWY 19R), TWY H, TWY J, AND TWY P CLSD TO ACFT WITH WINGSPAN GTR THAN 78 FT UNLESS PMSN FM AMGR AT 414-747-5325.

PREFERRED USAGE BY ACFT BTN 2200-0600 IS TKOF RY 19R & LNDG RY 01L.

RY 07L/25R CLSD TO ALL JET ACFT.

DEICE PAD FOR RWY 07R NOT AUTH FOR THRU TAXI.

TWY C CLSD BTWN APCH END OF RWY 7L AND WEST RAMP NORTH TXL TO ACFT WITH WINGSPAN GTR THAN OR EQUAL TO 118 FT UNLESS PMSN FM ARPT MGR 414-747-5325.

TRNG FLGTS INVOLVING SUCCESSIVE USE OF ANY RY PROHIBITED 2200-0600.

ACFT WITH WINGSPAN GREATER THAN 175 FT CANNOT PASS SIMULTANEOUSLY ON TWY 'E' & TWY 'Z'.

HOLDING BAY AT RY 19R WHEN IN USE, TWY Z ADJACENT TO BAY IS LIMITED TO ACFT WITH WINGSPAN UP TO 170 FT.

RY 13/31 CLSD JET ACFT, UNLESS PMSN FROM TWR OR AMGR 414-747-5325.

RY 01R-19L AVAILABLE TO AIR CARRIERS FOR TAXI ONLY.

ANG: PPR ALL ACFT 48HR PN, CTC AFLD MGMT DSN 580-8241, C414-944-8241. AFLD MGMT HR 1200Z-2230Z++ TUE-FRI, CLSD HOL, SAT-SUN EXC UNIT TMG. MAINT OPS (MOCC) FREQ - 379.85. ANY MDS (OTHER THAN KC-135) IS LTD TO STD TRAN MARSHALLING AND PRK. NO TECH DATA AVBL FOR TRAN MAINT. FUEL AND AGE SUPPORT EQUIP AVBL FOR SELF-SVC. NO ADNL CONFIGN ITEMS SUPPORTED SUCH AS LANTIRN PODS, EDM PODS, ETC. ANG: EOR, ACFT SHELTERS/REVTMENTS, AND ALERT FAC UNAVBL. APRON HAS LTD STATIC GND POINTS AND TIE DOWN POINTS. FLEET SVC/HOT CARGO PRKG UNAVBL. CTC UPSET CTL ON 321.0 30 MIN PRIOR TO LDG AND DEP. NSTD MRK ON APRON FOR WINGTIP CLNC USED BY BASE ASGND ACFT.

TWY F (WEST OF TWY Z) CLSD TO ACFT WITH WINGSPAN GREATER THAN OR EQUAL TO 118 FT UNLESS PERMISSION FROM ARPT DIR AT 414-747-5325.

ALL APCHS ARE OVER NOISE SENSITIVE AREAS; ALL TURBOJET ACFT SHOULD REFRAIN FM CONDUCTING MULTI VFR TFC PATTERN APCHS & DEPS WO PRIOR APVL FM AMGR CALL 414-747-5325.

BIRDS ON & INVOF ARPT.

RYS 13/31 & 01R/19L & 07L/25R CLSD EXCP LGT WT SINGLE ENG ACFT 0400-1200Z DLY.

TWY V BTN TWY D AND RY 7L/25R CLSD TO ACFT WITH WINGSPAN GREATER THAN 170 FT WHEN RY 7L/25R IN USE.

ASDE-X IN USE. OPERATE TRANSPONDERS WITH ALTITUDE REPORTING MODE AND ADS-B (IF EQUIPPED) ENABLED ON ALL AIRPORT SURFACES.

TWY B BTN TWY R AND TWY A1 CLSD TO ACFT WINGSPAN MORE THAN 118 FT EXC PPR 414-747-5325.

## INDEX

[References are to page numbers]

### A

- Abbreviations, GEN 2.2–1
- Accident and Incident Reporting , ENR 1.16–1
  - Items To Be Reported, ENR 1.16–2
- Actual Navigation Performance (ANP), ENR 4.1–37
- ADS–R. *See* Automatic Dependent Surveillance–Rebroadcast
- Aerodrome Forecast (TAF), GEN 3.5–81
- Aeronautical Charts, GEN 3.2–1
- Aeronautical Fixed Telecommunications Network (AFTN), GEN 3.4–8
- Aeronautical Information Publication (AIP)
  - Publication Schedule, GEN 0.1–2
  - Structure, GEN 0.1–1
  - Subscription Information, GEN 0.1–3
- Aeronautical Publications, Distribution of, GEN 3.1–2
- AFTN. *See* Aeronautical Fixed Telecommunications Network (AFTN)
- AHRS. *See* Attitude Heading Reference System
- Air Route Traffic Control Center (ARTCC), GEN 3.3–2
  - ARTCC Communications, GEN 3.3–2
  - ARTCC Radio Frequency Outage, GEN 3.3–13
- Air Traffic Clearance. *See* Clearance
- Air Traffic Control, Pilot/Controller Roles and Responsibilities, ENR 1.1–77
- Aircraft
  - Lights, Use of, ENR 1.1–33
  - Unmanned, ENR 5.7–3
- Airport
  - Aircraft Arresting Devices, AD 1.1–28
  - Airport Advisory/Information Services, ENR 1.4–15
  - Fees and Charges, GEN 4.1–1
  - Fire Fighting Requirements, AD 1.1–3
  - Local Airport Advisory (LAA), GEN 3.3–19
  - Operations, ENR 1.1–1
    - Exiting the Runway after Landing, ENR 1.1–26
    - VFR Flights in Terminal Areas, ENR 1.1–21
    - Low Level Wind Shear/Microburst Detection Systems, ENR 1.1–14
    - Signals, Hand, ENR 1.1–27
    - Taxiing, ENR 1.1–18
    - Traffic Pattern, ENR 1.1–1, ENR 1.1–2, ENR 1.1–7
    - With Operating Control Tower, ENR 1.1–1
    - Without Operating Control Tower, GEN 3.3–18, GEN 3.3–27, ENR 1.1–7
  - Remote Airport Information Service (RAIS), GEN 3.3–19, ENR 1.4–16
  - Reservations Procedures, GEN 3.3–26
- Airport Lighting, AD 1.1–4
  - Airport Beacons, AD 1.1–17, AD 1.1–18
  - Approach Light Systems, AD 1.1–4
  - LED Lighting Systems, AD 1.1–19
  - Obstruction Lighting, AD 1.1–18
  - Pilot–controlled Lighting, AD 1.1–13
  - Precision Approach Path Indicator (PAPI), AD 1.1–5
  - Runway Lighting, AD 1.1–5, AD 1.1–6
  - Taxiway Lighting, AD 1.1–17
  - Visual Approach Slope Indicator (VASI), AD 1.1–4
- Airport Markings, AD 1.1–20
  - Colors, AD 1.1–20
  - Holding Position Markings, AD 1.1–23
  - Other Markings, AD 1.1–24
    - Nonmovement Area Boundary Markings, AD 1.1–25
    - Temporarily Closed Runways and Taxiways, AD 1.1–25
    - VOR Checkpoint Markings, AD 1.1–24
  - Runway Markings, AD 1.1–20
  - Taxiway Markings, AD 1.1–22
- Airport Operations
  - Intersection Takeoffs, ENR 1.1–20
  - Land and Hold Short , ENR 1.1–23
- Airport Signs, AD 1.1–25
  - Destination Signs, AD 1.1–27
  - Direction Signs, AD 1.1–27
  - Information Signs, AD 1.1–27
  - Location Signs, AD 1.1–26
    - ILS Critical Area Boundary Sign, AD 1.1–27
    - Runway Boundary Sign, AD 1.1–27
    - Runway Location Sign, AD 1.1–26
    - Taxiway Location Sign, AD 1.1–26
  - Mandatory Instruction Signs, AD 1.1–25
  - ILS Critical Area Holding Position Sign, AD 1.1–26
  - No Entry Sign, AD 1.1–26
  - Runway Approach Area Holding Position Sign, AD 1.1–26
  - Runway Holding Position Sign, AD 1.1–26

**[References are to page numbers]**

- Runway Distance Remaining Signs, AD 1.1–28
- Airport Surface Detection Equipment – Model X (ASDE–X), ENR 1.1–55
- Airport Surface Surveillance Capability, ENR 1.1–55
- Airport Use, AD 1.1–1 *See also* Airport, Reservations Procedures
- Airports, Designated To Serve International Operations, AD 2–1  
Diagrams of, AD 2–3
- Airspace, ENR 1.4–1  
Classes, ENR 1.4–1, ENR 1.4–4, ENR 1.4–5  
Controlled, ENR 1.4–4  
IFR Requirements, ENR 1.4–4  
VFR Requirements, ENR 1.4–4  
Operating Rules and Requirements, ENR 1.4–5, ENR 1.4–8, ENR 1.4–12, ENR 1.4–13  
Radar Vectors in, ENR 3.5–2  
Speed Adjustments in, ENR 1.1–80  
Vectors, ENR 1.1–80  
VFR Corridors, ENR 1.4–16  
VFR Transition Routes, ENR 1.4–17
- Flights Over Charted U.S. Wildlife Refuges, Parks and Forest Service Areas, ENR 5.6–2
- National Security Area, ENR 5.1–2
- Obstructions to Flight. *See* Flight Hazards, Potential
- Parachute Jump Aircraft Operations, ENR 5.1–5
- Special Use, ENR 5.1–1  
Alert Areas, ENR 5.2–1  
Controlled Firing Areas, ENR 5.2–1  
Military Operations Area (MOA), ENR 5.2–1  
Military Training Routes, ENR 5.2–1  
Prohibited Areas, ENR 5.1–1  
Restricted Areas, ENR 5.1–1  
Warning Areas, ENR 5.1–2
- Temporary Flight Restriction, ENR 5.1–2
- Terminal Radar Service Area, ENR 1.1–75
- Terminal Radar Service Area (TRSA), ENR 1.4–17
- VFR Flyways, ENR 1.4–16
- VFR Routes, Published, ENR 1.4–16
- VFR Weather Minimums, ENR 1.4–3
- Airways and Route Systems. *See* Navigation
- Altimeter Setting Procedures, ENR 1.7–1
- Altitude  
High Altitude Destinations, ENR 1.10–18  
Mandatory, ENR 1.5–30  
Maximum, ENR 1.5–30
- Minimum, ENR 1.5–30
- ANP. *See* Actual Navigation Performance
- Approach Control Service for VFR Arriving Aircraft, GEN 3.3–17
- Approaches, ENR 1.5–11, ENR 1.5–49  
Approach and Landing Minimums, ENR 1.5–22  
Approach Clearance, ENR 1.5–15  
Contact Approach, ENR 1.1–78  
ILS Approaches to Parallel Runways, ENR 1.5–56  
ILS Minimums, ENR 4.1–10  
Instrument Approach, ENR 1.1–78  
Instrument Approach Procedure Charts, ENR 1.5–27 *See also* Aeronautical Charts  
Minimum Vectoring Altitudes, ENR 1.5–40  
Missed Approach, ENR 1.1–79, ENR 1.5–73  
Monitoring of Instrument Approaches, ENR 1.5–50  
No–Gyro Approach, ENR 1.5–50  
Overhead Approach Maneuver, ENR 1.5–76  
Practice Instrument Approaches, ENR 1.1–22  
Precision Approach, ENR 1.5–49  
Side–step Maneuver, ENR 1.5–22  
Simultaneous Approaches to Parallel Runways, ENR 1.5–52  
Simultaneous Close Parallel ILS PRM Approaches, ENR 1.5–58  
Simultaneous Converging Instrument Approaches, ENR 1.5–65  
Surveillance Approach, ENR 1.5–50  
Timed Approaches From a Holding Fix, ENR 1.5–65  
Vertical Descent Angle (VDA), ENR 1.5–42  
Visual, ENR 1.1–83  
Visual Descent Points, ENR 1.5–42, ENR 1.5–72
- Area Navigation (RNAV), ENR 4.1–35, ENR 4.1–37 *See also* Area Navigation
- Area Navigation (RNAV) Routes, ENR 3.3–1
- ARFF (Aircraft Rescue and Fire Fighting)  
Discrete Emergency Frequency, GEN 3.7–1  
Emergency Hand Signals, GEN 3.7–1  
Radio Call Sign, GEN 3.7–1
- ARTCC. *See* Air Route Traffic Control Center (ARTCC)
- ATS Routes, ENR 3.1–1, Appendix 1–1  
Lower ATS Routes, ENR 3.1–1  
Upper ATS Routes, ENR 3.2–1
- Attitude Heading Reference System (AHRS), ENR 4.1–16
- Automated Terminal Information Service (ATIS). *See* Meteorological Services

[References are to page numbers]

Automated Weather Observation System (AWOS) .  
*See* AWOS

Automatic Dependent Surveillance – Contract  
(ADS–C), Climb Descend Procedure (CDP),  
ENR 7.12–1

Automatic Dependent Surveillance (ADS–B),  
In–Trail Procedure (ITP), ENR 7.12–1

Automatic Dependent Surveillance–Rebroadcast,  
ENR 1.1–101

Automatic Flight Information Service (AFIS) –  
Alaska FSSs Only. *See* AFIS

Aviation Safety Reporting Program, ENR 1.16–1

## B

Barometric Altimeter Errors and Setting  
Procedures, ENR 1.7–1

Barometric Pressure Altimeter Errors, ENR 1.7–1

Bird Activity, ENR 5.6–1  
Reporting Bird and Other Wildlife Activities,  
ENR 5.6–1  
Reporting Bird Strikes, ENR 5.6–1

## C

Call Signs  
Aircraft, GEN 3.4–9  
Ground Station, GEN 3.4–11

Charts. *See* Aeronautical Charts

Class C Airspace, Outer Area, ENR 1.4–8

Clearance  
Adherence to, ENR 1.1–39  
Air Traffic Control, ENR 1.1–34  
Amended, ENR 1.1–36  
Clearance Items, ENR 1.1–35  
Pilot Responsibilities, ENR 1.1–37  
Special VFR, ENR 1.1–36  
VFR–On–Top, ENR 1.1–38  
VFR/IFR Flights, ENR 1.1–38

Cold Temperature  
Airports, ENR 1.8–2  
Barometric Altimeter Errors, ENR 1.8–1  
Calculating Altitude Corrections on CTAs, ENR  
1.8–6  
Cold Temperature Airports (CTA), ENR 1.8–1  
Effects of Cold Temperature on Baro–vertical  
Navigation (VNAV) Vertical Guidance, ENR  
1.8–1

Planning for Cold Temperature Altimeter Errors,  
ENR 1.8–1

Cold Temperature Airports (CTA), ENR 1.8–2

Cold Temperature Operations, ENR 1.10–2  
Pilot Responsibilities, ENR 1.1–78

Collision Avoidance, ENR 1.15–8

Common Traffic Advisory Frequency (CTAF). *See*  
Radio Communications

Communications. *See* Radio Communications

Controlled Airspace. *See* Airspace, Controlled  
Controller, Responsibility, ENR 1.5–1

Conversion Tables, GEN 2.6–1

Cruising Altitudes, ENR 1.4–3, ENR 1.4–16

## D

Data Link Procedures, ENR 7.2–1

Declared Distances, ENR 1.1–10

Defense VFR (DVFR) Flights, ENR 1.10–16

Density Altitude. *See* Flight Hazards, Potential

Departure Control, ENR 1.5–81  
Abbreviated IFR Departure Clearance  
Procedures, ENR 1.5–81

Departure Procedures, ENR 1.5–77  
Clearance Void Times, ENR 1.5–80  
Departure Restrictions, ENR 1.5–78, ENR  
1.5–80  
Hold for Release, ENR 1.5–80  
Instrument Departure Procedures (DP), ENR  
1.5–83  
Pre–Taxi Clearance Procedures, ENR 1.5–77  
Release Times, ENR 1.5–80  
Taxi Clearance, ENR 1.5–78

Departure, Instrument, ENR 1.1–84

Differences From ICAO Standards, Recommended  
Practices and Procedures, GEN 1.7–1

Diverse Vector Areas (DVA), ENR 1.5–83

DVFR Flights, ENR 1.10–16

## E

EFVS. *See* Enhanced Flight Vision Systems

**[References are to page numbers]**

ELT. *See* Emergency Locator Transmitters  
Emergency  
  Aircraft Rescue and Fire Fighting  
    Communications, GEN 3.7-1  
  Aircraft, Overdue, GEN 3.6-5  
  Body Signals, GEN 3.6-6  
  Distress and Urgency Communications, GEN  
    3.6-15  
  Ditching Procedures, GEN 3.6-18  
  Fuel Dumping, GEN 3.6-23  
  Obtaining Assistance, GEN 3.6-16  
  VFR Search and Rescue Protection, GEN 3.6-6  
Emergency Autoland System, GEN 3.6-15  
Emergency Descent System, GEN 3.6-15  
Emergency Locator Transmitters, GEN 3.6-2  
Enhanced Flight Vision Systems, ENR 1.5-68  
EPE. *See* Estimate of Position Error  
Estimate of Position Error (EPE), ENR 4.1-37

**F**

FAA Form 7233-4, Appendix 2-1  
FDC NOTAMs, ENR 1.10-5  
Fees and Charges. *See* Airport  
Final Guard, ENR 1.4-15  
FIS-B. *See* Flight Information Service-Broadcast  
Flight Hazards, Potential, ENR 5.7-1  
  Density Altitude, ENR 5.7-5  
  Laser Operations, ENR 5.7-12  
  Mountain Flying, ENR 5.7-4  
  Mountain Wave, ENR 5.7-7  
  Obstructions, ENR 5.7-2  
  VFR in Congested Area, ENR 5.7-2  
Flight Information Service-Broadcast, ENR 1.1-98  
Flight Level Allocation, New York OCA, ENR  
  7.13-1  
Flight Management System (FMS), ENR 1.17-5  
Flight Plan, ENR 1.10-1, ENR 1.11-1  
  Canceling, ENR 1.10-17  
  Defense VFR (DVFR) Flights, ENR 1.10-16  
  IFR Flights, ENR 1.10-11  
  Preflight Preparation, ENR 1.10-1  
  VFR Flights, ENR 1.10-10  
Flight Service Station (FSS), GEN 3.1-5

Forms, Bird Strike Incident/Ingestion Report, ENR  
  5.6-3  
Frequencies. *See* Radio Communications  
FSS. *See* Flight Service Station (FSS)  
Fuel Advisory, Minimum, ENR 1.1-85

**G**

GBAS Landing System (GLS), ENR 4.1-33  
Global Navigation Satellite System (GNSS), ENR  
  1.10-14  
Global Positioning System (GPS), ENR 4.1-16  
GLS. *See* GBAS Landing System  
GPS IFR Equipment Classes/Categories, ENR  
  4.1-28  
Graphical Forecasts for Aviation (GFA), GEN  
  3.5-9  
Gulf of Mexico Grid System, ENR 6.1-6  
Gulf of Mexico RNAV Routes Q100, Q102, AND  
  Q105, ENR 7.14-1

**H**

Half-Way Signs, ENR 5.7-6  
Hazard  
  Flight, Reporting Radio/Radar Altimeter  
    Anomalies, ENR 5.7-1  
  Thermal Plumes, ENR 5.7-16  
HDTA. *See* High Density Traffic Airports  
Helicopter  
  IFR Operations, ENR 6.1-1, ENR 7.1-1  
  Departure Procedures, ENR 6.1-7  
  Special Operations, ENR 6.2-1, ENR 7.2-1  
High Density Traffic Airports, GEN 3.3-26  
Holding Pattern  
  Airspeeds, ENR 1.5-2  
  Distance Measuring Equipment (DME), ENR  
    1.5-6  
  Entry Procedures, ENR 1.5-5  
  Timing, ENR 1.5-5  
Holding Position Markings  
  for Instrument Landing Systems, AD 1.1-24  
  for Intersecting Taxiways, AD 1.1-24  
Holding Procedures, ENR 1.5-1

[References are to page numbers]

I

ICAO Standards, Recommended Practices and Procedures. *See* Differences From ICAO Standards, Recommended Practices and Procedures

Ident Feature, ENR 1.1–58

IFR, Operations, To High Altitude Destinations, ENR 1.10–18

IFR Flights, ENR 1.10–11

Inertial Navigation System, ENR 4.1–16

Inertial Reference Unit (IRU), ENR 4.1–16

INS. *See* Internal Navigation System

Instrument Departure. *See* Departure, Instrument

Instrument Departure Procedures (DP), ENR 1.5–83

Instrument Landing System (ILS), ENR 4.1–5 *See also* Approaches

Course and Glideslope Distortion, ENR 4.1–11

Frequency Table, ENR 4.1–10

Holding Position Markings, AD 1.1–24

Inoperative Components, ENR 4.1–11

Instrument Meteorological Conditions (IMC), ENR 1.5–83

Integrated Terminal Weather System, ENR 1.1–14

International Airports. *See* Airports, Designated To Serve International Operations

International Flight Plan, Appendix 2–1

International NOTAMs, ENR 1.10–5

Intersection Takeoffs. *See* Airport Operations

IRU. *See* Inertial Reference Unit

ITWS. *See* Integrated Terminal Weather System

J

Jamming, ENR 1.17–12

Jet Route System. *See* Navigation

L

Land and Hold Short Operations. *See* Airport Operations

Light Amplification by Stimulated Emission of Radiation (Laser) Operations. *See* Flight Hazards, Potential

Lighting. *See* Airport Lighting

Line Up and Wait, ENR 1.5–78

LLWAS. *See* Low Level Wind Shear Alert System

Local Airport Advisory (LAA), GEN 3.3–19, ENR 1.4–15

LORAN, ENR 4.1–16

Low Level Wind Shear Alert System (LLWAS), ENR 1.1–14

Low Level Wind Shear/Microburst Detection Systems, ENR 1.1–14

Lower ATS Routes, ENR 3.1–1

Low Altitude ATS Route Structure, ENR 3.1–1

LUAW, ENR 1.5–78

M

Medical Facts for Pilots, ENR 1.15–1

Carbon Monoxide Poisoning in Flight, ENR 1.15–5

Certification, ENR 1.15–1

Decompression Sickness after Scuba Diving, ENR 1.15–5

Effects of Altitude, ENR 1.15–3

Ear Block, ENR 1.15–4

Hypoxia, ENR 1.15–3

Sinus Block, ENR 1.15–4

Hyperventilation in Flight, ENR 1.15–5

Illusions, ENR 1.15–5

Personal Checklist, ENR 1.15–3

Scanning for Other Aircraft, ENR 1.15–7

Vision in Flight, ENR 1.15–7

Meteorological Services, Automatic Terminal Information Service (ATIS), GEN 3.3–25

Meteorology, National Weather Service, Aviation Weather Service, GEN 3.5–3

Military NOTAMs, ENR 1.10–6

Military Training Routes. *See* Airspace, Special Use

Minimum Safe Altitudes, ENR 1.5–31

Minimum Turning Altitude (MTA), ENR 3.5–3

Mountain Flying. *See* Flight Hazards, Potential

Mountain Wave. *See* Flight Hazards, Potential

MSA. *See* Minimum Safe Altitudes

[References are to page numbers]

MTA. *See* Minimum Turning Altitude (MTA)

Notices To Air Missions (NOTAM) Service, GEN  
3.1-2, ENR 1.10-3

**N**

National Security, ENR 1.12-1  
ADIZ, ENR 1.12-1  
ADIZ Requirements, ENR 1.12-2  
Airspace Waivers, ENR 1.12-8  
Civil Aircraft Operations, ENR 1.12-4  
Defense Area, ENR 1.12-1  
ESCAT, ENR 1.12-8  
Foreign State Aircraft Operations, ENR 1.12-6  
Territorial Airspace, ENR 1.12-1  
TSA Aviation Security Programs, ENR 1.12-8  
National Security, Requirements, ENR 1.12-1  
National Security and Interception Procedures, ENR  
1.12-12  
National Security Area. *See* Airspace  
NAVAID Identifier Removal During Maintenance,  
ENR 4.1-39  
NAVAID User Reports, ENR 4.1-39  
Navigation. *See also* Global Positioning System  
(GPS)  
Adhering to Airways or Routes, ENR 3.5-3  
Airway or Route Course Changes, ENR 3.5-2  
Airways and Route Systems, ENR 3.5-1  
Changeover Points, ENR 3.5-2  
LORAN, ENR 4.1-16  
Navigation, Radio, GEN 3.4-1  
Nondirectional Radio Beacon, GEN 3.4-6  
Navigation Aids, ENR 4.1-1  
Navigation Specifications (Nav Specs), ENR 1.17-5  
Navigational, Inertial Navigation System, ENR  
4.1-16  
Near Midair Collision Reporting, ENR 1.16-3  
Investigation, ENR 1.16-3  
NOTAM (D), ENR 1.10-5  
Notice to Air Missions  
FDC NOTAMs, ENR 1.10-5  
Temporary Flight Restrictions (TFRs), ENR  
1.10-5  
International NOTAMs, ENR 1.10-5  
Military NOTAMs, ENR 1.10-6  
NOTAM D, ENR 1.10-5  
Pointer NOTAMs, ENR 1.10-5  
Security NOTAMs, ENR 1.10-6

**O**

Oceanic Airspace, In-flight Contingencies, ENR  
7.3-1  
Oceanic Operations, ENR 7.1-1  
Air-to-Air Frequency, ENR 7.1-7  
Beacon Code Requirements, ENR 7.1-4  
Flight Plan Filing Requirements, ENR 7.1-1  
Flight Plans, ENR 7.1-2  
IFR/VFR Operations, ENR 7.1-1  
NAT Clearance Procedures, ENR 7.6-1  
NAT Safety, ENR 7.8-1  
NAT Timekeeping Procedures, ENR 7.7-1  
Offshore Routes, ENR 7.11-1  
Operational Policy  
Lateral Separation, ENR 7.4-1  
Performance-Based Communication and  
Surveillance (PBCS), ENR 7.5-1  
Performance-Based Navigation (PBN), ENR  
7.5-1  
Position Reporting, ENR 7.1-4  
San Juan FIR Customs, ENR 7.9-1  
SATVOICE, ENR 7.1-6  
SLOP, ENR 7.1-7  
Y Routes, ENR 7.10-1  
Operational Information System (OIS), ENR  
1.10-10  
Overhead Approach Maneuver. *See* Approaches

**P**

Parachute Jump Aircraft Operations. *See* Airspace  
PBCS. *See* Performance-Based Communication and  
Surveillance (PBCS)  
PBN. *See* Performance-Based Navigation (PBN)  
Performance-Based Navigation (PBN), ENR  
1.17-1  
Phonetic Alphabet. *See* Radio Communications,  
Phonetic Alphabet  
Pilot Visits to Air Traffic Facilities, GEN 3.3-2  
Pointer NOTAMs, ENR 1.10-5  
Position Reporting, GEN 3.3-14  
Position Reporting Requirements, GEN 3.3-15  
Pre-departure Clearance Procedures, ENR 1.5-77



**[References are to page numbers]**

Precipitation Static, ENR 5.7–11  
Precision Approach Systems, ENR 4.1–35  
Procedure Turns, ENR 1.5–17

**R**

Radar, ENR 1.1–46  
  Air Traffic Control Radar Beacon System, ENR 1.1–48  
  Capabilities, ENR 1.1–46  
  Precision Approach, ENR 1.1–49  
  Surveillance, ENR 1.1–49  
Radar Services Provided by ATC, ENR 1.1–60  
  Aircraft Conflict Alert, ENR 1.1–61  
  Offshore Controlled Airspace, ENR 1.1–76  
  Radar Assistance to VFR Aircraft, ENR 1.1–63  
  Radar Traffic Information Service, ENR 1.1–61  
  Terrain/Obstruction Alert, ENR 1.1–61  
Radio Communications, GEN 3.4–8  
  Common Traffic Advisory Frequency (CTAF), GEN 3.3–18  
  Contact Procedures, GEN 3.4–15  
  Directions, GEN 3.4–13  
  Failure, GEN 3.4–14, GEN 3.4–21  
  For Aircraft on International or Overseas Flights, GEN 3.4–17, GEN 3.4–20  
  Phonetic Alphabet, GEN 3.4–11  
  Phraseology, GEN 3.4–11  
  Radio Technique, GEN 3.4–8  
  Speed, GEN 3.4–13  
  UNICOM/MULTICOM, GEN 3.3–23, GEN 3.3–24  
Radio Navigation Aids  
  Distance Measuring Equipment, ENR 4.1–4, ENR 4.1–9  
  Nondirectional Radio Beacon, ENR 4.1–1  
  Tactical Air Navigation, ENR 4.1–5  
  VHF Omni-directional Radio Range, ENR 4.1–1  
Reduced Separation, Climb/Descent Procedures, ENR 7.12–1  
REL. *See* Runway Entrance Lights  
Remote Airport Advisory (RAA), ENR 1.4–15  
Remote Airport Information Service (RAIS), GEN 3.3–19, ENR 1.4–16  
Reporting Radio/Radar Altimeter Anomalies, ENR 5.7–1  
Required Navigation Performance (RNP), ENR 4.1–36

Required Navigation Performance (RNP) Operations, ENR 1.10–17, ENR 4.1–37  
Reservations. *See* Airport, Reservations Procedures  
Responsibility, Controller, ENR 1.5–1  
RNAV, ENR 1.10–14  
RNAV Routes, Gulf of Mexico, ENR 7.14–1  
RNP. *See* Required Navigation Performance (RNP)  
RNP AR (Authorization Required) Instrument Procedures, ENR 1.5–21  
Runway  
  Entrance Lights, AD 1.1–11  
  Holding Position Markings, AD 1.1–23  
  Status Light (RWSL) System, AD 1.1–11  
RWSL System, Runway Status Light (RWSL) System. *See* Runway Status Light (RWSL) System

**S**

Seaplane Safety, ENR 5.7–7  
Search and Rescue, GEN 3.6–1  
Security Identification Display Area, AD 1.1–28  
Security NOTAMS, ENR 1.10–6  
Separation  
  IFR, Standards, ENR 1.1–41  
  Runway, ENR 1.1–44  
  Visual, ENR 1.1–44, ENR 1.1–83  
SIDA. *See* Security Identifications Display Area  
Signs, Half-Way, ENR 5.7–6  
Single Flights Conducted With Both VFR and IFR Flight Plans, ENR 1.10–16  
Slot Controlled Airports, GEN 3.3–26  
Small Unmanned Aircraft System (sUAS), ENR 8.2–1  
Space Launch and Reentry Area, ENR 5.7–17  
Special Air Traffic Rules (SATR), ENR 5.1–5  
Special Flight Rules Area (SFRA), ENR 5.1–5  
Special Instrument Approach Procedures, ENR 1.5–49  
Special Traffic Management Programs (STMP), GEN 3.3–27  
Spoofing, ENR 1.17–12

[References are to page numbers]

Standard Terminal Arrival, ENR 1.5–12  
STAR. *See* Standard Terminal Arrival  
STMP. *See* Special Traffic Management Programs (STMP)  
sUAS. *See* Small Unmanned Aircraft System (sUAS)  
Surveillance Services, ENR 1.6–1

**T**

Takeoff Hold Lights (THL), AD 1.1–11  
Taxiway, Holding Position Markings, AD 1.1–24  
TDWR. *See* Terminal Doppler Weather Radar  
Temporary Flight Restrictions. *See* Airspace  
Temporary Flight Restrictions (TFRs), ENR 1.10–5  
Terminal Arrival Area (TAA), ENR 1.5–31  
Terminal Doppler Weather Radar, ENR 1.1–14  
TFRs, ENR 1.10–5  
THL. *See* Takeoff Hold Lights  
Time, Conversion from UTC to Standard Time, GEN 3.4–13  
Tower En Route Control (TEC), ENR 1.1–76  
Traffic Advisories, ENR 1.1–81  
Traffic Advisories, At Airports Without Operating Control Towers, GEN 3.3–18  
Traffic Alert and Collision Avoidance System (TCAS I & II), ENR 1.1–85  
Traffic Information Service (TIS), ENR 1.1–86, ENR 1.1–92  
Traffic Pattern. *See* Airport, Operations  
Transponder Operation, ENR 1.1–56  
Automatic Altitude Reporting, ENR 1.1–58  
Code Changes, ENR 1.1–58  
Emergency, ENR 1.1–60  
Mode C Requirements, ENR 1.1–59  
TRSA. *See* Airspace, Terminal Radar Service Area

**U**

U.S. Customs Requirements, Entry, Transit, and Departure of Cargo, GEN 1.4–1

U.S. Differences From ICAO Standards. *See* Differences From ICAO Standards, Recommended Practices and Procedures  
U.S. Territorial Airspace, GEN 1.2–1  
UAS. *See* Unmanned Aircraft Systems (UAS)  
Unidentified Flying Objects (UFO), ENR 1.16–3  
Units of Measurement, GEN 2.1–1  
Unmanned Aircraft, ENR 5.7–3  
Unmanned Aircraft System (UAS)  
Large UAS, ENR 8.3–1  
Emerging Large UAS Civil Operations, ENR 8.3–5  
Exemptions under 49 USC 44807, ENR 8.3–4  
Large Public UAS Operations, ENR 8.3–1  
Small Unmanned Aircraft System (sUAS), ENR 8.2–1  
Part 107 sUAS, ENR 8.2–1  
Recreational Flyers, ENR 8.2–1  
Registration Requirements, ENR 8.2–1  
Unmanned Aircraft Systems (UAS), ENR 8.1–1  
Accidents and Incidents, ENR 8.8–2  
Advanced Air Mobility, ENR 8.6–1  
Air Traffic Control (ATC), ENR 8.8–1  
Airspace Access, ENR 8.4–1  
14 CFR Part 107, ENR 8.4–1  
14 CFR Part 135, ENR 8.4–4  
14 CFR Part 137, ENR 8.4–4  
14 CFR Part 89, ENR 8.4–3  
Airspace Restrictions To Flight, ENR 8.4–6  
FAA–Recognized Identification Area, ENR 8.4–3  
FRIAs, ENR 8.4–3  
PAOs, ENR 8.4–2  
Public Aircraft Operations (PAOs), ENR 8.4–2  
Recreational Flyers, ENR 8.4–1  
Remote Identification, ENR 8.4–3  
UAS Traffic Management (UTM), ENR 8.4–8  
Waivers to 14 CFR Part 107, ENR 8.4–1  
Best Practices, ENR 8.8–1  
Environmental, ENR 8.8–3  
Emergency UAS Authorizations, ENR 8.8–3  
General, ENR 8.1–1  
Access to the National Airspace System (NAS), ENR 8.1–1  
Operations on Airports, ENR 8.7–1  
Pilot Testing, Certification and Responsibilities, ENR 8.5–1  
14 CFR Part 135, ENR 8.5–3  
14 CFR Part 137, ENR 8.5–3  
Foreign Pilot Certification, ENR 8.5–3  
Large Civil UAS, ENR 8.5–3

**[References are to page numbers]**

PAOs, ENR 8.5-3  
Part 107 Pilots and Recreational Flyers, ENR 8.5-1  
Public Aircraft Operations (PAOs), ENR 8.5-3  
Precautions, ENR 8.8-1  
Flight Near Manned Aircraft, ENR 8.8-1  
Flight Over or Near People, ENR 8.8-1  
Flight Over or Near Vehicles, ENR 8.8-1  
Night Operations, ENR 8.8-1  
Resources, ENR 8.8-3  
Special Government Interest (SGI) Airspace Waivers, ENR 8.8-3  
Upper ATS Routes, ENR 3.2-1  
High Altitude ATS Route Structure, ENR 3.2-1

**V**

VFR Flights, ENR 1.10-10  
VFR Flyways. *See* Airspace  
VFR-on-top, ENR 1.1-84  
VHF Omni-directional Range, Minimum Operational Network (MON), ENR 4.1-2

Visual Approach. *See* Approaches  
Visual Climb Over Airport, ENR 1.5-86  
Visual Meteorological Conditions (VMC), ENR 1.5-83  
Visual Separation, ENR 1.1-83  
VOCA. *See* Visual Climb Over Airport  
Volcanic Ash, Flight Operations in, ENR 5.7-9  
VOR Receiver Check, ENR 4.1-3

**W**

Weather Minimums. *See* Airspace, VFR Weather Minimums  
Weather Reconnaissance Area (WRA), ENR 5.1-6  
Weather System Processor, ENR 1.1-14  
Wide Area Augmentation System (WAAS), ENR 4.1-28  
Wildlife Refuges, Parks, and Forest Service Areas. *See* Airspace  
WSP, ENR 1.1-14



## Appendix 1. ATS Routes

### MINIMUM ENROUTE IFR ALTITUDES OVER PARTICULAR ROUTES AND INTERSECTIONS

1. This is an annual consolidation of all data in Subparts C and D of Part 95 – Subchapter F, which were in effect December 29, 2022, Amendment 569 included.

2. It is not an amendment to Part 95; therefore, it will not appear in the Federal Register.

For updates to these routes and access to additional data products, please visit [http://faa.gov/air\\_traffic/flight\\_info/aeronav/](http://faa.gov/air_traffic/flight_info/aeronav/).

#### TABLE OF CONTENTS

Contents	Page
Colored Federal Airways	1
Direct Routes – U.S.	7
(1) Puerto Rico Airways	13
(2) Bahama Airways	15
(3) Atlantic Airways	21
(4) Pacific Airways	64
Low Altitude RNAV Airways	77
High Altitude RNAV Airways	130
Ground-Based High Altitude RNAV Airways	201
VOR Federal Airways	202
Alaska VOR Federal Airways	357
Hawaii VOR Federal Airways	374
Jet Routes	380
VOR Federal Airway Changeover Points	410
(1) Alaska VOR Federal Airway Changeover Points	428
(2) Hawaii VOR Federal Airway Changeover Points	431
Jet Route Changeover Points	432



FROM	TO	MEA
------	----	-----

**95.0040 COLORED FEDERAL AIRWAYS**

**95.101 AMBER FEDERAL AIRWAY A1**

U.S. CANADIAN BORDER	U.S. CANADIAN BORDER	2800
U.S. CANADIAN BORDER	SITKA, AK NDB	*5200
*2300 - MOCA		
SITKA, AK NDB	SPARL, AK FIX	5200
SPARL, AK FIX	OCEAN CAPE, AK NDB	*6000
*2200 - MOCA		
OCEAN CAPE, AK NDB	CAPEM, AK FIX	*6000
*2000 - MOCA		
CAPEM, AK FIX	CORVA, AK FIX	*6000
*4400 - MOCA		
CORVA, AK FIX	EGGER, AK FIX	2000
EGGER, AK FIX	ORCA BAY, AK NDB	5000
TAKOTNA RIVER, AK NDB	NORTH RIVER, AK NDB	*7000
*6000 - MOCA		
NORTH RIVER, AK NDB	FORT DAVIS, AK NDB	3000

**95.102 AMBER FEDERAL AIRWAY A2**

U.S. CANADIAN BORDER	NABESNA, AK NDB	*8400
*6700 - MOCA		
NABESNA, AK NDB	DELTA JUNCTION, AK NDB	8000

**95.103 AMBER FEDERAL AIRWAY A3**

EVANSVILLE, AK NDB	PUT RIVER, AK NDB	10000
--------------------	-------------------	-------

**95.104 AMBER FEDERAL AIRWAY A4**

EVANSVILLE, AK NDB	ANAKTUVUK PASS, AK NDB	*10000
*8300 - MOCA		

**95.105 AMBER FEDERAL AIRWAY A5**

AMBLER, AK NDB	EVANSVILLE, AK NDB	*7500
*6600 - MOCA		

**95.106 AMBER FEDERAL AIRWAY A6**

ST MARYS, AK NDB	NORTH RIVER, AK NDB	5000
------------------	---------------------	------

**95.109 AMBER FEDERAL AIRWAY A9**

CHENA, AK NDB	EVANSVILLE, AK NDB	5500
EVANSVILLE, AK NDB	BROWERVILLE, AK NDB	*10000
*9100 - MOCA		

**95.115 AMBER FEDERAL AIRWAY A15**

U.S. CANADIAN BORDER	NICHOLS, AK NDB	5000
NICHOLS, AK NDB	SUMNER STRAIT, AK NDB	*7000
*5100 - MOCA		
*6000 - GNSS MEA		
SUMNER STRAIT, AK NDB	COGHLAN ISLAND, AK NDB	7000
COGHLAN ISLAND, AK NDB	HAINES, AK NDB	*9000
*8300 - MOCA		

FROM	TO	MEA
<b>95.115 AMBER FEDERAL AIRWAY A15 - CONTINUED</b>		
HAINES, AK NDB *9300 - MOCA	U.S. CANADIAN BORDER	*11000
U.S. CANADIAN BORDER *6700 - MOCA	NABESNA, AK NDB	*8400
NABESNA, AK NDB	DELTA JUNCTION, AK NDB	8000
<b>95.116 AMBER FEDERAL AIRWAY A16</b>		
ACTIVE PASS, CA NDB *2100 - MOCA *FOR THAT AIRSPACE OVER U.S. TERRITORY	WHITE ROCK, CA NDB	*3000
<b>95.117 AMBER FEDERAL AIRWAY A17</b>		
CHENA, AK NDB *10000 - MCA CHANDALAR LAKE, AK NDB , NW BND	*CHANDALAR LAKE, AK NDB	7000
CHANDALAR LAKE, AK NDB *10000 - MCA PUT RIVER, AK NDB , BND	*PUT RIVER, AK NDB	10000
<b>95.201 RED FEDERAL AIRWAY R1</b>		
ST PAUL ISLAND, AK NDB/DME *2700 - MOCA	GARRS, AK FIX	*4600
GARRS, AK FIX	CHINOOK, AK NDB	4600
<b>95.202 RED FEDERAL AIRWAY R2</b>		
ELFEE, AK NDB	PORT HEIDEN, AK NDB/DME	6000
<b>95.239 RED FEDERAL AIRWAY R39</b>		
OSCARVILLE, AK NDB *3500 - MCA ANIAK, AK NDB , NE BND **1400 - MOCA	*ANIAK, AK NDB	**2000
ANIAK, AK NDB *5400 - MOCA	TAKOTNA RIVER, AK NDB	*6000
TAKOTNA RIVER, AK NDB	MINCHUMINA, AK NDB	5000
MINCHUMINA, AK NDB	ICE POOL, AK NDB	4000
<b>95.251 RED FEDERAL AIRWAY R51</b>		
SUMNER STRAIT, AK NDB	SITKA, AK NDB	7000
<b>95.299 RED FEDERAL AIRWAY R99</b>		
ST PAUL ISLAND, AK NDB/DME *HF COMMS REQUIRED BELOW 8000 MSL.	DUTCH HARBOR, AK NDB/DME	*4800
DUTCH HARBOR, AK NDB/DME *6300 - MOCA	CHINOOK, AK NDB	*9000
CHINOOK, AK NDB *4400 - MOCA	ILIAMNA, AK NDB/DME	*5000
ILIAMNA, AK NDB/DME	KACHEMAK, AK NDB	6100
<b>95.401 GREEN FEDERAL AIRWAY G1</b>		
MOUNT MOFFETT, AK NDB/DME	HORTH, AK FIX	8000
HORTH, AK FIX *2500 - MOCA *5000 - GNSS MEA	MORDI, AK FIX	*8000



FROM TO MEA

**95.401 GREEN FEDERAL AIRWAY G1 - CONTINUED**

MORDI, AK FIX ELFEE, AK NDB \*8000  
 \*5300 - MOCA  
 \*7000 - GNSS MEA

**95.402 GREEN FEDERAL AIRWAY G2**

BORLAND, AK NDB/DME WOODY ISLAND, AK NDB \*10000  
 \*6600 - MOCA

**95.404 GREEN FEDERAL AIRWAY G4**

WOOD RIVER, AK NDB ILIAMNA, AK NDB/DME \*4500  
 \*3000 - MOCA

**95.406 GREEN FEDERAL AIRWAY G6**

ST MARYS, AK NDB ANIAK, AK NDB 4000

**95.407 GREEN FEDERAL AIRWAY G7**

GAMBELL, AK NDB/DME FORT DAVIS, AK NDB 3000  
 FORT DAVIS, AK NDB \*5000  
 \*4200 - MOCA

**95.408 GREEN FEDERAL AIRWAY G8**

SHEMYA, AK NDB MOUNT MOFFETT, AK NDB/DME \*8000  
 \*6300 - MOCA  
 \*HF COMMS REQUIRED.  
 MOUNT MOFFETT, AK NDB/DME DUTCH HARBOR, AK NDB/DME \*9000  
 \*8000 - MOCA  
 \*HF COMMUNICATIONS REQUIRED  
 DUTCH HARBOR, AK NDB/DME MORDI, AK FIX \*9000  
 \*5700 - MOCA  
 \*6000 - GNSS MEA  
 MORDI, AK FIX ELFEE, AK NDB \*8000  
 \*5300 - MOCA  
 \*7000 - GNSS MEA  
 \*VHF COMMS AVBL 5000 MSL AND ABOVE.  
 ELFEE, AK NDB CRACK, AK FIX \*5000  
 \*4100 - MOCA  
 \*VHF/UHF COMMS AVBL 9000 MSL AND ABOVE  
 \*HF COMMS ONLY BELOW 5000 MSL  
 \*VHF COMMS AVBL 5000 MSL AND ABOVE.  
 CRACK, AK FIX CHINOOK, AK NDB \*3000  
 \*2300 - MOCA  
 \*HF COMMS ONLY BELOW 9000 MSL  
 \*VHF/UHF COMMS AVBL 9000 MSL AND ABOVE  
 CHINOOK, AK NDB NOSKY, AK FIX \*6000  
 \*4900 - MOCA  
 NOSKY, AK FIX KACHEMAK, AK NDB 6100

**95.409 GREEN FEDERAL AIRWAY G9**

OSCARVILLE, AK NDB ZEKEG, AK FIX  
 NE BND \*6000  
 SW BND \*3000  
 \*2100 - MOCA  
 ZEKEG, AK FIX CAIRN MOUNTAIN, AK NDB 6000

FROM	TO	MEA
<b>95.410 GREEN FEDERAL AIRWAY G10</b>		
CAPE NEWENHAM, AK NDB/DME	ST PAUL ISLAND, AK NDB/DME	4600
ST PAUL ISLAND, AK NDB/DME	BILBE, AK FIX	3000
BILBE, AK FIX	ELFEE, AK NDB	*6000
*3800 - MOCA		
ELFEE, AK NDB	PORT HEIDEN, AK NDB/DME	*5000
*4100 - MOCA		
PORT HEIDEN, AK NDB/DME	WIDTH, AK FIX	9000
	COP 090 RWO	
WIDTH, AK FIX	WOODY ISLAND, AK NDB	*9000
*6300 - MOCA		
WOODY ISLAND, AK NDB	KACHEMAK, AK NDB	6000
<b>95.412 GREEN FEDERAL AIRWAY G12</b>		
ELFEE, AK NDB	BORLAND, AK NDB/DME	10000
BORLAND, AK NDB/DME	PORT HEIDEN, AK NDB/DME	10000
PORT HEIDEN, AK NDB/DME	CHINOOK, AK NDB	2500
<b>95.413 GREEN FEDERAL AIRWAY G13</b>		
ZOLMN, NC FIX	MANTEO, NC NDB	2000
<b>95.415 GREEN FEDERAL AIRWAY G15</b>		
ST MARYS, AK NDB	ANVIK, AK NDB	4000
ANVIK, AK NDB	TAKOTNA RIVER, AK NDB	*9000
*6000 - MOCA		
*7000 - GNSS MEA		
<b>95.416 GREEN FEDERAL AIRWAY G16</b>		
POINT LAY, AK NDB	WAINWRIGHT VILLAGE, AK NDB	*1700
*1200 - MOCA		
WAINWRIGHT VILLAGE, AK NDB	BROWERVILLE, AK NDB	*1600
*1100 - MOCA		
BROWERVILLE, AK NDB	NUIQSUT VILLAGE, AK NDB	1600
	COP 050 UQS	
NUIQSUT VILLAGE, AK NDB	PUT RIVER, AK NDB	*1700
*1200 - MOCA		
<b>95.417 GREEN FEDERAL AIRWAY G17</b>		
WAINWRIGHT VILLAGE, AK NDB	ATQASUK, AK NDB	*1600
*1100 - MOCA		
<b>95.418 GREEN FEDERAL AIRWAY G18</b>		
HOTHAM, AK NDB	POINT LAY, AK NDB	*10000
*6000 - MOCA		
POINT LAY, AK NDB	COP 096 HHM	
	ATQASUK, AK NDB	2300
	COP 050 PIZ	
<b>95.602 BLUE FEDERAL AIRWAY B2</b>		
POINT LAY, AK NDB	CAPE LISBURNE, AK NDB/DME	4000
CAPE LISBURNE, AK NDB/DME	HOTHAM, AK NDB	*8000
*4100 - MOCA		
	COP 057 LUR	

FROM	TO	MEA
<b>95.602 BLUE FEDERAL AIRWAY B2 - CONTINUED</b>		
HOTHAM, AK NDB *4300 - MOCA	TIN CITY, AK NDB/DME	*5000
TIN CITY, AK NDB/DME *5900 - MOCA *6000 - GNSS MEA	FORT DAVIS, AK NDB	*7000
<b>95.603 BLUE FEDERAL AIRWAY B3</b>		
ANIAK, AK NDB	ANVIK, AK NDB	3700
ANVIK, AK NDB	NORTH RIVER, AK NDB	4600
NORTH RIVER, AK NDB	NORTON BAY, AK NDB	3000
NORTON BAY, AK NDB	HOTHAM, AK NDB	4500
HOTHAM, AK NDB	NOATAK, AK NDB/DME	3300
<b>95.604 BLUE FEDERAL AIRWAY B4</b>		
UTOPIA CREEK, AK NDB/DME *6200 - MOCA	EVANSVILLE, AK NDB	*8000
EVANSVILLE, AK NDB *6600 - MOCA	YUKON RIVER, AK NDB	*8000
<b>95.607 BLUE FEDERAL AIRWAY B7</b>		
CAPE NEWENHAM, AK NDB/DME	OSCARVILLE, AK NDB	4600
<b>95.608 BLUE FEDERAL AIRWAY B8</b>		
TIN CITY, AK NDB/DME	SHISHMAREF, AK NDB	4000
<b>95.609 BLUE FEDERAL AIRWAY B9</b>		
*DEEDS, FL FIX *4000 - MRA **1500 - MOCA	MARATHON, FL NDB	**2000
<b>95.612 BLUE FEDERAL AIRWAY B12</b>		
WOODY ISLAND, AK NDB *9300 - MOCA	ILIAMNA, AK NDB/DME	*10000
<b>95.626 BLUE FEDERAL AIRWAY B26</b>		
CHENA, AK NDB	YUKON RIVER, AK NDB	7000
<b>95.627 BLUE FEDERAL AIRWAY B27</b>		
WOODY ISLAND, AK NDB	CHINOOK, AK NDB	10000
CHINOOK, AK NDB *7500 - MOCA	WANIX, AK FIX	*8000
WANIX, AK FIX	OSCARVILLE, AK NDB	
	NW BND	4000
	SE BND	8000
OSCARVILLE, AK NDB	ST MARYS, AK NDB	3000
ST MARYS, AK NDB	FORT DAVIS, AK NDB	3000
FORT DAVIS, AK NDB	HOTHAM, AK NDB	6000
<b>95.628 BLUE FEDERAL AIRWAY B28</b>		
U.S. CANADIAN BORDER	NICHOLS, AK NDB	5000

FROM	TO	MEA
<b>95.628 BLUE FEDERAL AIRWAY B28 - CONTINUED</b>		
NICHOLS, AK NDB *6000 - MOCA *6000 - GNSS MEA	SITKA, AK NDB	*6900
<b>95.637 BLUE FEDERAL AIRWAY B37</b>		
SUMNER STRAIT, AK NDB *6400 - MOCA	ELEPHANT, AK NDB	*7000
ELEPHANT, AK NDB *5000 - MOCA *5000 - GNSS MEA	SPARL, AK FIX	*6000
<b>95.638 BLUE FEDERAL AIRWAY B38</b>		
ELEPHANT, AK NDB CHILL, AK FIX	CHILL, AK FIX HAINES, AK NDB	7300 9000
<b>95.640 BLUE FEDERAL AIRWAY B40</b>		
HAINES, AK NDB *9800 - MOCA	U.S. CANADIAN BORDER	*10000
<b>95.679 BLUE FEDERAL AIRWAY B79</b>		
U.S. CANADIAN BORDER	NICHOLS, AK NDB	5000

FROM

TO

MEA

## 95.1001 DIRECT ROUTES-U.S.

ABILENE, TX VORTAC *3300 - MOCA	WACO, TX VORTAC	*6500
ABILENE, TX VORTAC	LLANO, TX VORTAC	7000
ALEXANDRIA, MN VOR/DME	COP 075 ABI	
	JAMESTOWN, ND VOR/DME	18000
ALLENTOWN, PA VORTAC	STILLWATER, NJ VOR/DME	MAA - 22000
*3000 - MOCA		*3300
ALLENTOWN, PA VORTAC	POTTSTOWN, PA VORTAC	*2700
*2500 - MOCA		
APPIN, TX FIX	LAKE CHARLES, LA VORTAC	*8000
*1500 - MOCA		
BATTLE MOUNTAIN, NV VORTAC	TWIN FALLS, ID VORTAC	*18000
*MEA IS ESTABLISHED WITH A GAP IN NAVIGATION SIGNAL COVERAGE		
BIG SUR, CA VORTAC	AVENAL, CA VOR/DME	*11000
		MAA - 35000
*7900 - MOCA		
BISMARCK, ND VOR/DME	HUMBOLDT, MN TACAN	18000
BISMARCK, ND VOR/DME	DICKINSON, ND VORTAC	18000
		MAA - 24000
BOZEMAN, MT VOR/DME	DUBOIS, ID VORTAC	18000
		MAA - 25000
BOZEMAN, MT VOR/DME	BOYSEN RESERVOIR, WY VOR/DME	19000
		MAA - 35000
BRADFORD, IL VORTAC	DES MOINES, IA VORTAC	18000
		MAA - 41000
BRILO, CA FIX	YAGER, CA FIX	7000
BULLION, NV VOR/DME	BOISE, ID VORTAC	18000
CAJON, CA FIX	HITOP, CA FIX	8000
CALBE, CA FIX	PALMDALE, CA VORTAC	10000
		MAA - 17500
*CAMARILLO, CA VOR/DME	**SANTA MONICA, CA VOR/DME	5000
*3600 - MCA CAMARILLO, CA VOR/DME , E BND		
**3600 - MCA SANTA MONICA, CA VOR/DME , BND		
*CHARM, CO FIX	**PUEBLO, CO VORTAC	8000
		MAA - 45000
*10000 - MCA CHARM, CO FIX , S BND		
**7200 - MCA PUEBLO, CO VORTAC , S BND		
COALDALE, NV VORTAC	WOODSIDE, CA VOR/DME	*18000
		MAA - 45000
*15100 - MOCA		
COALDALE, NV VORTAC	COP 068 OAL	
	SQUAW VALLEY, CA VOR/DME	15000
		MAA - 39000
COLLI, CA FIX	SCAGGS ISLAND, CA VORTAC	3500
COLOM, CA FIX	MINA, NV VORTAC	28000
COLOM, CA FIX	FRIANT, CA VORTAC	18000
		MAA - 45000
COLUMBIA, SC VORTAC	CHARLESTON, WV VOR/DME	18000
		MAA - 45000
CORTEZ, CO VOR/DME	PUEBLO, CO VORTAC	*22000
		MAA - 45000
	COP 080 CEZ	
*MEA IS ESTABLISHED WITH A GAP IN NAVIGATION SIGNAL COVERAGE		
COVEX, LA FIX	APPIN, TX FIX	*8000
*1800 - MOCA		
COVEX, LA FIX	BELCHER, LA VORTAC	*3500
*1900 - MOCA		
DAGGETT, CA VORTAC	PALMDALE, CA VORTAC	7000
DAYTON, OH VOR/DME	GUNNE, OH FIX	18000
		MAA - 39000
DAYTON, OH VOR/DME	FORT WAYNE, IN VORTAC	18000
		MAA - 43000
DAYTON, OH VOR/DME	APPLETON, OH VORTAC	18000
		MAA - 45000
DELLS, WI VORTAC	EAU CLAIRE, WI VORTAC	18000
		MAA - 29000
DES MOINES, IA VORTAC	IOWA CITY, IA VOR/DME	2700
		MAA - 35000

FROM	TO	MEA
DETROIT LAKES, MN VOR/DME *2700 - MOCA	THIEF RIVER FALLS, MN VOR/DME	*3300
DICKINSON, ND VORTAC DICKINSON, ND VORTAC	U.S. CANADIAN BORDER MINOT, ND VOR/DME	18000 18000 MAA - 35000
DILLON, MT VOR/DME	SHERIDAN, WY VOR/DME	*33000 MAA - 45000
*MEA IS ESTABLISHED WITH A GAP IN NAVIGATION SIGNAL COVERAGE DUBOIS, ID VORTAC	BOZEMAN, MT VOR/DME	18000 MAA - 35000
DULUTH, MN VORTAC *3100 - MOCA *FOR THAT AIRSPACE OVER U.S. TERRITORY	U.S. CANADIAN BORDER	*18000
DULUTH, MN VORTAC *DUNOIR, WY VOR/DME *12200 - MCA DUNOIR, WY VOR/DME , E BND **12200 - MCA WORLAND, WY VOR/DME , BND ***15200 - MOCA	TRAVERSE CITY, MI VOR/DME **WORLAND, WY VOR/DME	24000 ***16000
DUNOIR, WY VOR/DME	COP 040 DNW BILLINGS, MT VORTAC	18000 MAA - 45000
DUPREE, SD VOR/DME	BISMARCK, ND VOR/DME	18000 MAA - 35000
EAU CLAIRE, WI VORTAC	DULUTH, MN VORTAC	18000 MAA - 29000
EEDEN, AK FIX	FRIED, OP FIX	10000 MAA - 45000
FARGO, ND VOR/DME FELLOWS, CA VOR/DME FELLOWS, CA VOR/DME FELLOWS, CA VOR/DME	WILLISTON, ND VOR/DME GAVIOTA, CA VORTAC GUADALUPE, CA VOR FILLMORE, CA VORTAC COP 042 FLW	23000 8000 7000 9500
FELLOWS, CA VOR/DME FELLOWS, CA VOR/DME FELLOWS, CA VOR/DME FILLMORE, CA VORTAC FLYING CLOUD, MN VOR/DME	SAN MARCUS, CA VORTAC SHAFTER, CA VORTAC GORMAN, CA VORTAC FELLOWS, CA VOR/DME SIOUX FALLS, SD VORTAC	9000 6400 11000 9500 17000 MAA - 25000
FORT WAYNE, IN VORTAC	KALAMAZOO, MI VOR/DME	18000 MAA - 43000
GINNA, CA FIX GIPPER, MI VORTAC	CAMARILLO, CA VOR/DME LITCHFIELD, MI VOR/DME	4000 *18000 MAA - 41000
*MAXIMUM CROSSING ALT SBN 075/49 33000. GLINA, NM WP	COP 049 GIJ BOLES, NM DME	*13000 MAA - 24000
*9900 - MOCA *RADAR REQUIRED WHEN IN HOLLOWMAN APCH CTL ARSPC. GOOCH SPRINGS, TX VORTAC *3000 - MOCA	COLLEGE STATION, TX VORTAC	*4000
GOPHER, MN VORTAC	MOLINE, IL VOR/DME	13000 MAA - 35000
GOPHER, MN VORTAC	CEDAR RAPIDS, IA VOR/DME	14500 MAA - 35000
GRAND ISLAND, NE VOR/DME	LINCOLN, NE VORTAC	*4000 MAA - 35000
*2900 - MOCA GRAND ISLAND, NE VOR/DME	SALINA, KS VORTAC	*7000 MAA - 17500
*3800 - MOCA GROTON, CT VOR/DME	FLIBB, CT FIX	*2000 MAA - 17500
*1500 - MOCA GUADALUPE, CA VOR GULFPORT, MS VORTAC *5000 - MRA **1700 - MOCA	HABUT, CA FIX *PLUGG, MS FIX	5000 **2000
HOMEE, PA WP HONEZ, CA FIX HUMBLE, TX VORTAC	REVLOC, PA VOR/DME MODESTO, CA VOR/DME QUITMAN, TX DME	4000 2200 *9000 MAA - 41000
*2200 - MOCA JAMESTOWN, ND VOR/DME	BISMARCK, ND VOR/DME	18000 MAA - 24000

FROM	TO	MEA
JAMESTOWN, ND VOR/DME	GRAND FORKS, ND VOR/DME	18000
JULIAN, CA VORTAC	PARADISE, CA VORTAC	MAA - 35000 8000
KALAMAZOO, MI VOR/DME	VICTORY, MI VOR/DME	MAA - 41000 18000
KALISPELL, MT VOR/DME	U.S. CANADIAN BORDER	MAA - 43000 18000 MAA - 45000
KALISPELL, MT VOR/DME *11400 - MOCA	COP 082 FCA HELENA, MT VORTAC	*15500
KEARNEY, NE VOR LAFAYETTE, LA VORTAC LAKE CHARLES, LA VORTAC	COP 050 FCA MANKATO, KS VORTAC ORICH, LA FIX LUFKIN, TX VORTAC	4200 1600 *3000 MAA - 1700
*1600 - MOCA LAKE CHARLES, LA VORTAC *1600 - MOCA LAKE HUGHES, CA VORTAC LAMONI, IA VOR/DME	APPIN, TX FIX	*8000
LAUGHLIN, TX VORTAC *3000 - MOCA LEONA, TX VORTAC *1900 - MOCA LINCOLN, NE VORTAC	FILLMORE, CA VORTAC IOWA CITY, IA VOR/DME	8000 18000 MAA - 42000 *5000
LINCOLN, NE VORTAC	SAN ANTONIO, TX VORTAC	*2500
*2700 - MOCA LONDON, KY VOR/DME	GREGG COUNTY, TX VORTAC	
LUFKIN, TX VORTAC *2000 - MOCA	OMAHA, IA VORTAC	3700 MAA - 35000 *5000 MAA - 45000
MADISON, WI VORTAC	DES MOINES, IA VORTAC	
MANKATO, KS VORTAC *3100 - MOCA *MARIC, CA FIX *3400 - MCA MARIC, CA FIX , E BND **3400 - MCA LAKE HUGHES, CA VORTAC , BND	HOLSTON MOUNTAIN, TN VORTAC	18000 MAA - 43000 *8000
MEEKER, CO VOR/DME *16500 - MRA **15500 - MOCA	MONROE, LA VORTAC	*8000
MENDOCINO, CA VORTAC	COP 082 LFK DELLS, WI VORTAC	18000 MAA - 29000 *3400
MENDOCINO, CA VORTAC	SALINA, KS VORTAC	
*7500 - MOCA MINA, NV VORTAC MINOT, ND VOR/DME	**LAKE HUGHES, CA VORTAC	7800
MISSOULA, MT VOR/DME	*FUNDS, CO FIX	**24000 MAA - 37000
MISSOULA, MT VOR/DME	POINT REYES, CA VOR/DME	5000 MAA - 39000
MISSOULA, MT VOR/DME	BRILO, CA FIX	*11000 MAA - 24000
MISSOULA, MT VOR/DME	BATTLE MOUNTAIN, NV VORTAC	18000
MORMON MESA, NV VORTAC MORRO BAY, CA VORTAC MORRO BAY, CA VORTAC MORRO BAY, CA VORTAC MUDDY MOUNTAIN, WY VOR/DME	U.S. CANADIAN BORDER	18000 MAA - 45000 18000 MAA - 45000
MUSTANG, NV VORTAC NORTH BEND, OR VOR/DME	KALISPELL, MT VOR/DME	18000 MAA - 45000
NORTH BEND, OR VOR/DME	BOZEMAN, MT VOR/DME	20000 MAA - 35000
NORTH PLATTE, NE VOR/DME *4200 - MOCA	GREAT FALLS, MT VORTAC	18000 MAA - 24000
	DILLON, MT VOR/DME	16500 MAA - 35000
	WILSON CREEK, NV VORTAC	18000
	FILLMORE, CA VORTAC	9500
	SHAFTER, CA VORTAC	6000
	FELLOWS, CA VOR/DME	6400
	DICKINSON, ND VORTAC	18000 MAA - 35000
	TROSE, CA FIX	22000
	EUGENE, OR VORTAC	18000 MAA - 41000
	NEWPORT, OR VORTAC	18000 MAA - 45000
	KEARNEY, NE VOR	*5000

FROM	TO	MEA
NORTHBROOK, IL VOR/DME	DES MOINES, IA VORTAC	18000
O'NEILL, NE VORTAC	MASON CITY, IA VOR/DME	MAA - 41000 24000
OAKLAND, CA VOR/DME	SCAGGS ISLAND, CA VORTAC	MAA - 41000 4000
OMAHA, IA VORTAC	HILL CITY, KS VORTAC	18000 MAA - 45000
PACIF, CA FIX	SEAL BEACH, CA VORTAC	3000
PANOCHÉ, CA VORTAC	*HENCE, CA FIX	**9000
*9000 - MCA HENCE, CA FIX , E BND9000 - MCA HENCE, CA FIX , BND		
**5800 - MOCA		
PANOCHÉ, CA VORTAC	GORMAN, CA VORTAC	24000
PANOCHÉ, CA VORTAC	SUNOL, CA FIX	18000 MAA - 31000
PARADISE, CA VORTAC	*CALBE, CA FIX	6000 MAA - 17500
*8500 - MCA CALBE, CA FIX , NW BND8500 - MCA CALBE, CA FIX , BND		
PAWNEE CITY, NE VORTAC	KIRKSVILLE, MO VORTAC	18000 MAA - 41000
PAWNEE CITY, NE VORTAC	KANSAS CITY, MO VORTAC	18000 MAA - 45000
PEACH SPRINGS, AZ VOR/DME	DOVE CREEK, CO VORTAC	18000 MAA - 41000
PENDLETON, OR VORTAC	COP 100 PGS	
*MEA IS ESTABLISHED WITH A GAP IN NAVIGATION SIGNAL COVERAGE	DILLON, MT VOR/DME	*24000
POINT REYES, CA VOR/DME	WOODSIDE, CA VOR/DME	*5000 MAA - 17000
*4400 - MOCA		
PUEBLO, CO VORTAC	HILL CITY, KS VORTAC	18000 MAA - 45000
PUEBLO, CO VORTAC	HAYES CENTER, NE VORTAC	18000 MAA - 41000
PYNON, CO FIX	BLACK FOREST, CO VOR/DME	9400
QUITMAN, TX DME	TULSA, OK VORTAC	*9000
*3000 - MOCA		
RAPID CITY, SD VORTAC	FARGO, ND VOR/DME	24000
RAPID CITY, SD VORTAC	DUPREE, SD VOR/DME	18000 MAA - 35000
RAPID CITY, SD VORTAC	MINOT, ND VOR/DME	*18000
*MEA IS ESTABLISHED WITH A GAP IN NAVIGATION SIGNAL COVERAGE		
RED BLUFF, CA VORTAC	SCAGGS ISLAND, CA VORTAC	*6000
*9000 - MOCA		
RED BLUFF, CA VORTAC	COP 060 RBL	
*REDDING, CA VOR/DME	REDDING, CA VOR/DME	3000
	**TOMAD, CA FIX	
	NE BND	6000
	SW BND	9000
*5000 - MCA REDDING, CA VOR/DME , SW BND		
**5000 - MCA TOMAD, CA FIX , BND		
RIVERTON, WY VOR/DME	LARAMIE, WY VOR/DME	18000 MAA - 35000
RIVERTON, WY VOR/DME	GREAT FALLS, MT VORTAC	*35000
*14800 - MOCA		
*35000 MRA AT COP.		
ROCK SPRINGS, WY VOR/DME	LARAMIE, WY VOR/DME	*18000 MAA - 45000
*14000 - MOCA		
ROCK SPRINGS, WY VOR/DME	JACKSON, WY VOR/DME	*18000 MAA - 45000
*13200 - MOCA		
ROGUE VALLEY, OR VORTAC	COP 118 OCS	
*11000 - MRA	*ROOTY, OR FIX	11000
ROME, OR VOR/DME	DONNELLY, ID VOR/DME	24000 MAA - 45000
ROME, OR VOR/DME	DUBOIS, ID VORTAC	31000 MAA - 45000
SACRAMENTO, CA VORTAC	COP 144 REO	
SALINAS, CA VORTAC	KLAMATH FALLS, OR VORTAC	18000
	COP 130 SAC	
	LICKE, CA WP	6000 MAA - 17500
SALINAS, CA VORTAC	GILRO, CA FIX	5000
SALMON, ID VOR/DME	MISSOULA, MT VOR/DME	18000 MAA - 45000



FROM	TO	MEA
SAN ANGELO, TX VORTAC	BROWNWOOD, TX VOR/DME	4500
SAN ANGELO, TX VORTAC	GOOCH SPRINGS, TX VORTAC	5000
SAN ANGELO, TX VORTAC	BROWNWOOD, TX VOR/DME	3500
SAN ANGELO, TX VORTAC	ROCKSPRINGS, TX VORTAC	4200
SAN JOSE, CA VOR/DME	COLLI, CA FIX	4000
SAN MARCUS, CA VORTAC	GUADALUPE, CA VOR	6700
SAN MARCUS, CA VORTAC	MORRO BAY, CA VORTAC	6800
SANTA CATALINA, CA VORTAC	GAVIOTA, CA VORTAC	6400
SANTY, CA FIX	*TAILS, CA FIX	5000
*7000 - MRA		
SCAPA, PR WP	CRSTL, PR WP	6000
SCOTTSBLUFF, NE VORTAC	WOLBACH, NE VORTAC	18000
		MAA - 45000
SCOTTSBLUFF, NE VORTAC	ABERDEEN, SD VOR/DME	26000
		MAA - 45000
SEAL BEACH, CA VORTAC	ELMOO, CA FIX	*5000
*2400 - MOCA		
*SHAFTER, CA VORTAC	**WRING, CA FIX	5000
*3300 - MCA SHAFTER, CA VORTAC , NE BND		
**5400 - MCA WRING, CA FIX , SE BND		
SHERIDAN, WY VOR/DME	RAPID CITY, SD VORTAC	18000
		MAA - 45000
SIDNEY, NE VOR/DME	ABERDEEN, SD VOR/DME	29000
		MAA - 45000
SIOUX FALLS, SD VORTAC	FARGO, ND VOR/DME	15000
SNOUT, AK FIX	EEDEN, AK FIX	10000
		MAA - 45000
SNOWBIRD, TN VORTAC	LONDON, KY VOR/DME	18000
		MAA - 45000
SPOKANE, WA VORTAC	DONNELLY, ID VOR/DME	18000
		MAA - 41000
SPOKANE, WA VORTAC	MISSOULA, MT VOR/DME	18000
		MAA - 35000
SPOKANE, WA VORTAC	U.S. CANADIAN BORDER	*18000
		MAA - 45000
*MEA IS ESTABLISHED WITH A GAP IN NAVIGATION SIGNAL COVERAGE		
SQUAW VALLEY, CA VOR/DME	KLAMATH FALLS, OR VORTAC	28000
		MAA - 45000
TONOPAH, NV VORTAC	BRYCE CANYON, UT VORTAC	23000
		MAA - 45000
TROSE, CA FIX	MODESTO, CA VOR/DME	
	SW BND	5000
	NE BND	22000
		MAA - 39000
TUSCOLA, TX VOR/DME	LLANO, TX VORTAC	*4500
*3900 - MOCA		
TWENTYNINE PALMS, CA VORTAC	GOFFS, CA VORTAC	18000
		MAA - 45000
	COP 017 TNP	
UNBAR, MI FIX	SALEM, MI VORTAC	18000
		MAA - 45000
*VAN NUYS, CA VOR/DME	**PALMDALE, CA VORTAC	7800
		MAA - 17500
*6000 - MCA VAN NUYS, CA VOR/DME , NE BND		
**5800 - MCA PALMDALE, CA VORTAC , SW BND		
WAKER, CA FIX	FILLMORE, CA VORTAC	4800
*WESLA, CA FIX	**FILLMORE, CA VORTAC	4800
*4100 - MCA WESLA, CA FIX , N BND		
**4100 - MCA FILLMORE, CA VORTAC , BND		
WICHITA FALLS, TX VORTAC	ARDMORE, OK VORTAC	*4000
*2500 - MOCA		
WILKES-BARRE, PA VORTAC	LATTY, NY FIX	4000
		MAA - 10000
WILL ROGERS, OK VORTAC	WICHITA, KS VORTAC	*6000
		MAA - 17500
*3600 - MOCA		
WILLISTON, ND VOR/DME	U.S. CANADIAN BORDER	*8000
		MAA - 17500
*3400 - MOCA		
WILSON CREEK, NV VORTAC	BULLION, NV VOR/DME	20000
WOLBACH, NE VORTAC	OMAHA, IA VORTAC	3800
		MAA - 35000
WOLBACH, NE VORTAC	DES MOINES, IA VORTAC	10000
		MAA - 17500
WOLBACH, NE VORTAC	PAWNEE CITY, NE VORTAC	18000
		MAA - 45000

FROM

TO

MEA

WOODSIDE, CA VOR/DME  
\*7000 - MRA  
\*\*4400 - MOCA

\*EUGEN, CA FIX

\*\*6000

FROM	TO	MEA
------	----	-----

### PUERTO RICO ROUTES

**ROUTE 1**

UTAHS, PR FIX *1300 - MOCA	BORINQUEN, PR VORTAC	*4000
BORINQUEN, PR VORTAC	MAYAGUEZ, PR VOR/DME	2500

**ROUTE 2**

FAJAR, PR FIX	TOURO, PR FIX	2000
TOURO, PR FIX	MALIE, VI FIX	2000

**ROUTE 3**

UTAHS, PR FIX	JAAWS, PR FIX	12000
JAAWS, PR FIX	SAN JUAN, PR VORTAC	3000

**ROUTE 4**

*IDAHO, PR FIX *15000 - MRA **1800 - MOCA	BORINQUEN, PR VORTAC	**2500
BORINQUEN, PR VORTAC	JOSHE, PR FIX	6000
JOSHE, PR FIX	MIGHT, PR FIX	6000
MIGHT, PR FIX	TUUNA, PR FIX	6000
TUUNA, PR FIX	VEDAS, PR FIX	5000
VEDAS, PR FIX	HAKVO, OA FIX	4000
SNOOZ, VI FIX	ST CROIX, VI VOR/DME	2400

**ROUTE 5**

BORINQUEN, PR VORTAC *1800 - MOCA	ROBLL, PR FIX	*3000
ROBLL, PR FIX *1300 - MOCA	PLING, PR FIX	*6000

**ROUTE 6**

*IDAHO, PR FIX *15000 - MRA	ROBLL, PR FIX	15000
ROBLL, PR FIX	BEANO, PR FIX	6000
BEANO, PR FIX *1300 - MOCA	CORAF, PR FIX	*3000
CORAF, PR FIX	SAN JUAN, PR VORTAC	1500
SAN JUAN, PR VORTAC	CHAKA, PR FIX	2500
CHAKA, PR FIX	PALCO, PR FIX	3000
PALCO, PR FIX	ST THOMAS, VI VOR/DME	2700
		MAA - 45000

**ROUTE 7**

PLING, PR FIX	SAALR, PR FIX	12000
SAALR, PR FIX	DONKE, PR FIX	3000
DONKE, PR FIX	SAN JUAN, PR VORTAC	3000
SAN JUAN, PR VORTAC	SANLO, PR FIX	4000
SANLO, PR FIX	TUUNA, PR FIX	4000
TUUNA, PR FIX	GESSO, PR FIX	9000

FROM	TO	MEA
<b>ROUTE 9</b>		
BEWIK, PR FIX	*WIGUM, PR FIX	6000
		MAA - 18000
*8500 - MRA		
WIGUM, PR FIX	CLAYO, PR FIX	5500
		MAA - 18000
CLAYO, PR FIX	MIGHT, PR FIX	5500
		MAA - 18000
MIGHT, PR FIX	GANBO, PR FIX	6000
		MAA - 18000
GANBO, PR FIX	SAN JUAN, PR VORTAC	3800
		MAA - 18000
SAN JUAN, PR VORTAC	WALNA, PR FIX	1500
		MAA - 18000
WALNA, PR FIX	*DEEDY, PR FIX	1500
		MAA - 18000
*2500 - MRA		
DEEDY, PR FIX	VERMO, PR FIX	12000
		MAA - 18000
<b>ROUTE 12</b>		
MAYAGUEZ, PR VOR/DME	JOSHE, PR FIX	7000
JOSHE, PR FIX	*VARNA, PR FIX	6000
*6000 - MRA		
*5000 - MCA VARNA, PR FIX , SW BND		
VARNA, PR FIX	SAN JUAN, PR VORTAC	3700
SAN JUAN, PR VORTAC	JETSS, PR FIX	2000
JETSS, PR FIX	ST THOMAS, VI VOR/DME	2800

FROM

TO

MEA

**BAHAMA ROUTES****BR1L**

JOLTS, BS FIX	FREEPORT, BS VOR/DME	*2000 MAA - 45000
*1500 - MOCA		
FREEPORT, BS VOR/DME	BARTS, BS FIX	*2000
*1300 - MOCA		
BARTS, BS FIX	MAMML, BS FIX	*2000
*1200 - MOCA		
MAMML, BS FIX	DIAZZ, OA FIX	*2000
*1200 - MOCA		
DIAZZ, OA FIX	LOGVN, OA WP	2000
LOGVN, OA WP	BRRGO, OA FIX	2000
BRRGO, OA FIX	AVNEY, OA WP	*2000
*1200 - MOCA		
AVNEY, OA WP	BENIE, IB FIX	*2000
*1200 - MOCA		
BENIE, IB FIX	OREDE, BS WP	*2000 MAA - 41000
*1200 - MOCA		
OREDE, BS WP	RAHAM, TC FIX	*2000
*1200 - MOCA		
RAHAM, TC FIX	STRUD, OA FIX	*2000
*1300 - MOCA		
STRUD, OA FIX	BIKIN, IB FIX	2000
BIKIN, IB FIX	GRAND TURK, TC VORTAC	*2000
*1300 - MOCA		

**BR2L**

SAN SALVADOR, BS NDB	DUKKY, BS WP	5500
DUKKY, BS WP	WRECK, OA FIX	5500
WRECK, OA FIX	SOLEI, OA FIX	5500
SOLEI, OA FIX	TROTR, OA FIX	5500
TROTR, OA FIX	PROVIDENCIALES, TC VOR/DME	5500
PROVIDENCIALES, TC VOR/DME	TOMAZ, OA FIX	5500
TOMAZ, OA FIX	BURTZ, OA FIX	5500
BURTZ, OA FIX	GOVET, OA FIX	5500
GOVET, OA FIX	JUELE, OA FIX	5500 MAA - 60000

**BR9L**

TOMAZ, OA FIX	CARAH, OA FIX	*2000
*1300 - MOCA		
CARAH, OA FIX	SKHOT, OA WP	*2000
*1300 - MOCA		
SKHOT, OA WP	KNSLY, OA WP	2000

**BR10L**

FREEPORT, BS VOR/DME	FLINY, BS FIX	3000
FLINY, BS FIX	HAANA, BS FIX	3000
HAANA, BS FIX	MRRSH, BS FIX	3000
MRRSH, BS FIX	BNTTZ, BS FIX	3000

**BR21V**

FREEPORT, BS VOR/DME	ULAMA, BS FIX	2000
----------------------	---------------	------

FROM	TO	MEA
<b>BR21V - CONTINUED</b>		
ULAMA, BS FIX	KIXAL, OA FIX	2000
		MAA - 45000
KIXAL, OA FIX	WALIK, FL FIX	2000
WALIK, FL FIX	PALM BEACH, FL VORTAC	2000
<b>BR22V</b>		
FORT LAUDERDALE, FL VOR/DME	DEKAL, OA FIX	6000
DEKAL, OA FIX	WIERS, BS FIX	6000
		MAA - 45000
WIERS, BS FIX	OYSTA, BS FIX	10000
		MAA - 45000
OYSTA, BS FIX	CAREY, BS FIX	6000
CAREY, BS FIX	MAJUR, OA FIX	3000
MAJUR, OA FIX	NASSAU, BS VOR/DME	*2000
*1500 - MOCA		
<b>BR49V</b>		
DOLPHIN, FL VORTAC	LUVLY, FL FIX	2000
LUVLY, FL FIX	JUNUR, FL FIX	2000
JUNUR, FL FIX	FOWEE, OA FIX	6000
FOWEE, OA FIX	LUCSS, BS FIX	*7000
		MAA - 45000
*1400 - MOCA		
LUCSS, BS FIX	JERRE, OA FIX	*4000
		MAA - 45000
*1400 - MOCA		
JERRE, OA FIX	*TINKY, OA FIX	**4000
		MAA - 45000
*8000 - MRA		
**1400 - MOCA		
TINKY, OA FIX	NICKO, BS FIX	*4000
		MAA - 45000
*1500 - MOCA		
NICKO, BS FIX	NASSAU, BS VOR/DME	*2000
		MAA - 45000
*1500 - MOCA		
<b>BR53V</b>		
VIRGINIA KEY, FL VOR/DME	SKIPS, BS FIX	4000
SKIPS, BS FIX	LEEVI, BS FIX	5000
		MAA - 45000
LEEVI, BS FIX	SWIMM, BS FIX	5000
		MAA - 45000
SWIMM, BS FIX	WOOZE, BS FIX	9000
		MAA - 45000
WOOZE, BS FIX	RAJAY, BS FIX	11000
RAJAY, BS FIX	PRUNE, BS FIX	4000
PRUNE, BS FIX	HINZY, BS FIX	2000
HINZY, BS FIX	NASSAU, BS VOR/DME	2000
NASSAU, BS VOR/DME	GUAVA, BS FIX	3000
GUAVA, BS FIX	BNTTZ, BS FIX	3000
<b>BR54V</b>		
PALM BEACH, FL VORTAC	MRLIN, FL FIX	2000
MRLIN, FL FIX	PREDA, FL FIX	4000
		MAA - 45000

FROM	TO	MEA
<b>BR54V - CONTINUED</b>		
PREDA, FL FIX	ISAAC, BS FIX	6000
		MAA - 45000
ISAAC, BS FIX	OYSTA, BS FIX	8000
OYSTA, BS FIX	CAREY, BS FIX	6000
CAREY, BS FIX	MAJUR, OA FIX	3000
MAJUR, OA FIX	NASSAU, BS VOR/DME	*2000
*1500 - MOCA		
<b>BR55V</b>		
PALM BEACH, FL VORTAC	MRLIN, FL FIX	2000
MRLIN, FL FIX	PREDA, FL FIX	4000
		MAA - 45000
PREDA, FL FIX	BEECH, BS FIX	4000
		MAA - 45000
BEECH, BS FIX	BIMINI, BS VORTAC	4000
		MAA - 45000
BIMINI, BS VORTAC	RAJAY, BS FIX	4000
RAJAY, BS FIX	PRUNE, BS FIX	4000
PRUNE, BS FIX	HINZY, BS FIX	2000
HINZY, BS FIX	NASSAU, BS VOR/DME	2000
NASSAU, BS VOR/DME	BURRL, BS FIX	*3000
*1500 - MOCA		
BURRL, BS FIX	SEAAN, BS FIX	*3000
*1300 - MOCA		
SEAAN, BS FIX	MUVOD, BS FIX	*10000
*1300 - MOCA		
MUVOD, BS FIX	BRRGO, OA FIX	*16000
*1300 - MOCA		
<b>BR57V</b>		
FORT LAUDERDALE, FL VOR/DME	DEKAL, OA FIX	6000
DEKAL, OA FIX	WIERS, BS FIX	6000
WIERS, BS FIX	BIMINI, BS VORTAC	3000
		MAA - 45000
BIMINI, BS VORTAC	CAREY, BS FIX	*3000
		MAA - 45000
*1300 - MOCA		
CAREY, BS FIX	MAJUR, OA FIX	3000
MAJUR, OA FIX	NASSAU, BS VOR/DME	*2000
*1500 - MOCA		
<b>BR58V</b>		
NASSAU, BS VOR/DME	KURAY, BS FIX	*2000
		MAA - 45000
*1500 - MOCA		
KURAY, BS FIX	*MELON, BS FIX	**2000
		MAA - 45000
*8000 - MRA		
**1400 - MOCA		
MELON, BS FIX	HANKX, BS FIX	*2000
		MAA - 45000
*1400 - MOCA		
HANKX, BS FIX	BARTS, BS FIX	*4000
		MAA - 45000
*1400 - MOCA		
BARTS, BS FIX	ANGLL, BS FIX	*10000
		MAA - 45000
*1400 - MOCA		

FROM	TO	MEA
<b>BR62V</b>		
TREASURE, FL VORTAC	ANGEE, FL FIX	2000
ANGEE, FL FIX	FORNL, FL FIX	2000
FORNL, FL FIX	SURFN, FL FIX	2000
SURFN, FL FIX	BERTH, BS FIX	*4000
*1300 - MOCA		
BERTH, BS FIX	JAKEL, BS FIX	*4000
		MAA - 45000
*1400 - MOCA		
JAKEL, BS FIX	FREEPORT, BS VOR/DME	*4000
*1400 - MOCA		
<b>BR63V</b>		
PALM BEACH, FL VORTAC	TURPS, FL FIX	2000
TURPS, FL FIX	MIXAE, BS FIX	3000
		MAA - 45000
MIXAE, BS FIX	HALBI, BS FIX	4000
		MAA - 45000
HALBI, BS FIX	ULAMA, BS FIX	2000
ULAMA, BS FIX	FREEPORT, BS VOR/DME	2000
FREEPORT, BS VOR/DME	CEGUR, BS FIX	*2000
*1400 - MOCA		
CEGUR, BS FIX	BURBO, BS FIX	*2000
*1300 - MOCA		
BURBO, BS FIX	BAYRU, BS FIX	*10000
*1300 - MOCA		
BAYRU, BS FIX	HANKX, BS FIX	*10000
*1300 - MOCA		
HANKX, BS FIX	*MELON, BS FIX	**2000
		MAA - 45000
*8000 - MRA		
**1400 - MOCA		
MELON, BS FIX	KURAY, BS FIX	*2000
		MAA - 45000
*1400 - MOCA		
KURAY, BS FIX	NASSAU, BS VOR/DME	*2000
		MAA - 45000
*1500 - MOCA		
<b>BR64V</b>		
VIRGINIA KEY, FL VOR/DME	KAINS, FL FIX	5000
		MAA - 45000
KAINS, FL FIX	QEPRO, FL FIX	5000
		MAA - 45000
QEPRO, FL FIX	KUCEP, FL WP	5000
		MAA - 45000
KUCEP, FL WP	HEATT, FL FIX	5000
		MAA - 45000
HEATT, FL FIX	MRLIN, FL FIX	5000
		MAA - 45000
MRLIN, FL FIX	MUNRO, OA FIX	5000
		MAA - 45000
MUNRO, OA FIX	FREEPORT, BS VOR/DME	2000
		MAA - 45000
<b>BR65V</b>		
NASSAU, BS VOR/DME	PEACH, OA FIX	*2000
*1500 - MOCA		



FROM	TO	MEA
<b>BR65V - CONTINUED</b>		
PEACH, OA FIX *5000 - MRA **1300 - MOCA	*SYDNY, BS FIX	**2000
SYDNY, BS FIX *1300 - MOCA	LAUTH, BS FIX	*5000
LAUTH, BS FIX *1400 - MOCA	FREEPORT, BS VOR/DME	*2000
FREEPORT, BS VOR/DME	RAPPS, BS FIX	3000 MAA - 45000
RAPPS, BS FIX	STIFF, BS FIX	8000 MAA - 45000
STIFF, BS FIX	ELDER, FL FIX	8000 MAA - 45000
ELDER, FL FIX	ADOOR, FL FIX	25000 MAA - 45000
<b>BR66V</b>		
VIRGINIA KEY, FL VOR/DME	JANUS, OA FIX	2000
JANUS, OA FIX	PADUS, BS FIX	4000 MAA - 45000
PADUS, BS FIX	FREEPORT, BS VOR/DME	2000 MAA - 45000
<b>BR68V</b>		
FORT LAUDERDALE, FL VOR/DME	MRLIN, FL FIX	6000
MRLIN, FL FIX	MUNRO, OA FIX	5000 MAA - 45000
MUNRO, OA FIX	FREEPORT, BS VOR/DME	2000
<b>BR69V</b>		
BIMINI, BS VORTAC	BAHMA, BS FIX	3000 MAA - 45000
BAHMA, BS FIX	MAYKO, OA FIX	3000 MAA - 45000
MAYKO, OA FIX	FREEPORT, BS VOR/DME	3000 MAA - 45000
FREEPORT, BS VOR/DME	JAMAX, BS FIX	*2000 MAA - 45000
*1400 - MOCA	BENZI, BS FIX	*3000 MAA - 45000
JAMAX, BS FIX	JOLTS, BS FIX	4000 MAA - 45000
*1200 - MOCA	BERTH, BS FIX	4000 MAA - 45000
BENZI, BS FIX	KIXAL, OA FIX	4000 MAA - 45000
JOLTS, BS FIX	WALIK, FL FIX	4000 MAA - 45000
BERTH, BS FIX	PALM BEACH, FL VORTAC	2000 MAA - 45000
KIXAL, OA FIX		
WALIK, FL FIX		
<b>BR70V</b>		
FORT LAUDERDALE, FL VOR/DME	TURBO, OA FIX	2000

FROM	TO	MEA
------	----	-----

**BR70V - CONTINUED**

TURBO, OA FIX	PADUS, BS FIX	7000
		MAA - 45000
PADUS, BS FIX	FREEPORT, BS VOR/DME	2000
		MAA - 45000
FREEPORT, BS VOR/DME	GRREG, BS FIX	3500
		MAA - 45000
GRREG, BS FIX	MRRSH, BS FIX	3500
		MAA - 45000
MRRSH, BS FIX	NASSAU, BS VOR/DME	6000
		MAA - 45000

**BR71V**

FREEPORT, BS VOR/DME	WOPOP, BS FIX	*2000
		MAA - 45000
*1400 - MOCA		
WOPOP, BS FIX	WLKER, BS FIX	*3000
		MAA - 45000
*1200 - MOCA		

FROM

TO

MEA

## ATLANTIC ROUTES

**A301**

*URSUS, OA FIX *16000 - MRA	ZOLLA, OA FIX	10000
ZOLLA, OA FIX	FOWEE, OA FIX	10000
FOWEE, OA FIX	SKIPS, BS FIX	5000
SKIPS, BS FIX	BIMINI, BS VORTAC	4000

**A315**

BIMINI, BS VORTAC	SWIMM, BS FIX	5000
SWIMM, BS FIX *8000 - MRA	*TINKY, OA FIX	8000
TINKY, OA FIX *12500 - MRA	*PEKRE, BS FIX	12500
PEKRE, BS FIX *14000 - MRA	*JAYEE, BS FIX	14000
JAYEE, BS FIX *16500 - MRA	*HODGY, BS FIX	7000
HODGY, BS FIX *16500 - MRA	*AMBIS, BS FIX	7000
AMBIS, BS FIX	DUNNO, BS WP	7000
KNSLY, OA WP	JOSES, OA WP	7000

**A509**

*URSUS, OA FIX *16000 - MRA	ELLEE, BS FIX	16000
ELLEE, BS FIX	EONNS, FL FIX	5000
EONNS, FL FIX	JURER, FL FIX	3000
JURER, FL FIX	DOLPHIN, FL VORTAC	3000
DOLPHIN, FL VORTAC	MARCI, FL FIX	8000

**A517**

ZPATA, PR FIX	SAINT MAARTEN, AN VOR/DME	6000 MAA - 45000
---------------	---------------------------	---------------------

**A555**

ILURI, OA FIX	PORQE, VI FIX	12000
PORQE, VI FIX	DORADO, PR NDB	6000
DORADO, PR NDB *15000 - MRA	*IDAHO, PR FIX	2000
IDAHO, PR FIX *1300 - MOCA	HARDE, PR FIX	*2000
HARDE, PR FIX *1300 - MOCA	GRADI, OA FIX	*2000
GRADI, OA FIX *1300 - MOCA	COCBU, IB FIX	*2000
COCBU, IB FIX *1500 - MOCA	GRAND TURK, TC VORTAC	*2000
GRAND TURK, TC VORTAC	BTLER, OA FIX	2000
BTLER, OA FIX	GUANA, OA FIX	2000
GUANA, OA FIX	INDEE, OA WP	2000
INDEE, OA WP	DUKKY, BS WP	2000

FROM	TO	MEA
<b>A555 - CONTINUED</b>		
DUKKY, BS WP	GEROT, OA FIX	3000
GEROT, OA FIX	DONEZ, OA FIX	3000
DONEZ, OA FIX	BOSAR, BS FIX	3000
BOSAR, BS FIX	LEPAS, BS FIX	*3000
*1300 - MOCA		
LEPAS, BS FIX	NASSAU, BS VOR/DME	*1500
*1500 - MOCA		
NASSAU, BS VOR/DME	HINZY, BS FIX	2000
HINZY, BS FIX	PRUNE, BS FIX	2000
PRUNE, BS FIX	RAJAY, BS FIX	4000
RAJAY, BS FIX	BIMINI, BS VORTAC	4000
<b>A638</b>		
ST THOMAS, VI VOR/DME	GUYRO, VI FIX	4000
GUYRO, VI FIX	SLUGO, VI FIX	4000
SLUGO, VI FIX	SAINT MAARTEN, AN VOR/DME	3000
<b>A699</b>		
NUCAR, BS FIX	STIFF, BS FIX	8000
STIFF, BS FIX	PERMT, FL FIX	8000
PERMT, FL FIX	PALM BEACH, FL VORTAC	6000
<b>A756</b>		
BODLO, OA WP	KNSLY, OA WP	3000
KNSLY, OA WP	ROSEA, OA WP	3000
ROSEA, OA WP	DUKKY, BS WP	3000
<b>A766</b>		
SABINE PASS, TX VOR/DME	LAURL, OG FIX	11000
LAURL, OG FIX	KLAMS, OG FIX	11000
KLAMS, OG FIX	KENGS, OG WP	4000
KENGS, OG WP	KELPP, OG FIX	4000
KELPP, OG FIX	KEHLI, OG FIX	4000
<b>A770</b>		
LEEVILLE, LA VORTAC	DOLPH, OG FIX	4000
		MAA - 45000
DOLPH, OG FIX	ALGAE, OG WP	4000
		MAA - 45000
ALGAE, OG WP	KEHLI, OG FIX	4000
		MAA - 45000
<b>AR3</b>		
NASSAU, BS VOR/DME	KURAY, BS FIX	*2000
		MAA - 45000
*1500 - MOCA		
KURAY, BS FIX	*MELON, BS FIX	**2000
		MAA - 45000
*8000 - MRA		
**1400 - MOCA		
MELON, BS FIX	HANKX, BS FIX	*2000
		MAA - 45000
*1400 - MOCA		

FROM	TO	MEA
<b>AR3 - CONTINUED</b>		
HANKX, BS FIX	BARTS, BS FIX	*4000 MAA - 45000
*1400 - MOCA		
BARTS, BS FIX	ANGLL, BS FIX	*10000 MAA - 45000
*1400 - MOCA		
ANGLL, BS FIX	NUCAR, BS FIX	*8000 MAA - 45000
*1400 - MOCA		
NUCAR, BS FIX	CASPR, OA FIX	2500 MAA - 60000
CASPR, OA FIX	SCOBY, OA WP	2500 MAA - 60000
SCOBY, OA WP	CARPX, OA WP	2500 MAA - 60000
CARPX, OA WP	ADUCI, OA WP	2500 MAA - 45000
ADUCI, OA WP	JAZZI, OA WP	2500 MAA - 60000
JAZZI, OA WP	DIZNY, OA WP	2500 MAA - 60000
DIZNY, OA WP	FRRAM, OA WP	2500 MAA - 60000
FRRAM, OA WP	JRDAN, OA WP	2500 MAA - 60000
JRDAN, OA WP	KEEKS, OA WP	2500 MAA - 60000
KEEKS, OA WP	OSTNN, OA WP	2500 MAA - 60000
OSTNN, OA WP	GARIC, NC WP	2500 MAA - 60000
<b>AR5</b>		
KOOKK, FL WP	FEMON, FL WP	2500 MAA - 60000
FEMON, FL WP	JAWSS, FL FIX	2500 MAA - 60000
JAWSS, FL FIX	BAHAA, OA WP	2500 MAA - 60000
BAHAA, OA WP	SNABS, OA WP	2500 MAA - 60000
SNABS, OA WP	OZENA, OA WP	2500 MAA - 60000
OZENA, OA WP	OHLAA, OA WP	2500 MAA - 60000
OHLAA, OA WP	CARPX, OA WP	2500 MAA - 60000
CARPX, OA WP	TROUT, FL WP	2500 MAA - 60000
<b>AR6</b>		
ORLANDO, FL VORTAC	BITHO, FL FIX	2700 MAA - 45000
BITHO, FL FIX	MALET, FL FIX	2700 MAA - 45000
MALET, FL FIX	APOLO, FL FIX	4000 MAA - 45000

FROM	TO	MEA
<b>AR6 - CONTINUED</b>		
APOLO, FL FIX	HOBEE, FL FIX	24000 MAA - 45000
<b>AR8</b>		
ELIZABETH CITY, NC VOR/DME	OHPEA, NC FIX	21000 MAA - 41000
OHPEA, NC FIX	TOMMZ, OA FIX	21000 MAA - 41000
TOMMZ, OA FIX	OXANA, OA FIX	21000 MAA - 41000
<b>AR10</b>		
DOLPHIN, FL VORTAC	TURBO, OA FIX	6000
TURBO, OA FIX	PREDA, FL FIX	6000
PREDA, FL FIX	ZAPPA, BS FIX	10000
<b>AR11</b>		
VIRGINIA KEY, FL VOR/DME	JANUS, OA FIX	*2000
*VIRGINIA KEY R-058 UNUSABLE JANUS TO VALLY		
JANUS, OA FIX	VALLY, OA FIX	*5000
*5000 - GNSS MEA		
<b>AR12</b>		
DEDDY, SC WP	PITRW, SC WP	18000 MAA - 60000
PITRW, SC WP	SNNTA, SC WP	18000 MAA - 60000
SNNTA, SC WP	OGGRE, OA WP	18000 MAA - 60000
OGGRE, OA WP	EBEAR, OA WP	18000 MAA - 60000
EBEAR, OA WP	DIZNY, OA WP	18000 MAA - 60000
DIZNY, OA WP	RROOO, OA WP	18000 MAA - 60000
RROOO, OA WP	HARON, OA WP	18000 MAA - 60000
HARON, OA WP	JAINS, OA WP	18000 MAA - 60000
<b>AR15</b>		
BAHAA, OA WP	HIBAC, OA WP S BND	24000 MAA - 60000
HIBAC, OA WP	PETEE, OA WP S BND	24000 MAA - 60000
PETEE, OA WP	APOLO, FL FIX S BND	24000 MAA - 60000
APOLO, FL FIX	MALET, FL FIX S BND	4000 MAA - 60000
MALET, FL FIX	ORLANDO, FL VORTAC S BND	2700 MAA - 60000

FROM	TO	MEA
<b>AR16</b>		
PERMT, FL FIX	LEND5, OA WP N BND	24000 MAA - 60000
LEND5, OA WP	GRUBR, OA WP N BND	24000 MAA - 60000
GRUBR, OA WP	SNABS, OA WP N BND	24000 MAA - 60000
SNABS, OA WP	SEELO, OA WP N BND	24000 MAA - 60000
<b>AR17</b>		
ZILLS, NC WP	OSTNN, OA WP S BND	24000 MAA - 60000
OSTNN, OA WP	OGGRE, OA WP S BND	24000 MAA - 60000
OGGRE, OA WP	NRRSE, OA WP S BND	24000 MAA - 60000
NRRSE, OA WP	BAHAA, OA WP S BND	24000 MAA - 60000
BAHAA, OA WP	HIBAC, OA WP	24000 MAA - 60000
HIBAC, OA WP	VIRGINIA KEY, FL VOR/DME	24000 MAA - 60000
<b>AR18</b>		
WOLFO, OA WP	RAMJT, OA WP N BND	24000 MAA - 60000
RAMJT, OA WP	ETECK, OA WP N BND	24000 MAA - 60000
ETECK, OA WP	PELCN, OA WP N BND	24000 MAA - 60000
PELCN, OA WP	OZENA, OA WP N BND	24000 MAA - 60000
OZENA, OA WP	ROWSY, OA WP N BND	24000 MAA - 60000
ROWSY, OA WP	FLRDA, OA WP	24000 MAA - 60000
<b>AR19</b>		
MAJK, OA WP	RAZZL, OA WP S BND	24000 MAA - 60000
RAZZL, OA WP	JRDAN, OA WP S BND	24000 MAA - 60000

FROM	TO	MEA
<b>AR19 - CONTINUED</b>		
JRDAN, OA WP	SAGGY, OA WP S BND	24000 MAA - 60000
SAGGY, OA WP	CHIEZ, NC WP S BND	24000 MAA - 60000
<b>AR22</b>		
HOAGG, OA WP	DUUNK, OA WP S BND	24000 MAA - 60000
DUUNK, OA WP	SPOOF, OA WP S BND	24000 MAA - 60000
SPOOF, OA WP	IDOLS, OA WP S BND	24000 MAA - 60000
IDOLS, OA WP	SKARP, NC WP S BND	24000 MAA - 60000
<b>AR23</b>		
*URSUS, OA FIX	FREEPORT, BS VOR/DME	24000 MAA - 60000
*16000 - MRA FREEPORT, BS VOR/DME	CANIT, OA WP	24000 MAA - 60000
CANIT, OA WP	OZENA, OA WP	24000 MAA - 60000
<b>AR24</b>		
*URSUS, OA FIX	FREEPORT, BS VOR/DME	24000 MAA - 60000
*16000 - MRA FREEPORT, BS VOR/DME	BRATZ, OA WP	24000 MAA - 60000
BRATZ, OA WP	OHLAA, OA WP	GNSS - 24000 MAA - 60000
OHLAA, OA WP	COACH, OA WP	24000 MAA - 60000
COACH, OA WP	TYCAL, OA WP	GNSS - 24000 MAA - 60000
TYCAL, OA WP	JAZZI, OA WP	GNSS - 24000 MAA - 60000
<b>B24</b>		
SEA ISLE, NJ VORTAC	FISSH, NJ FIX	15000 MAA - 45000
FISSH, NJ FIX	WEBBB, OA WP	15000 MAA - 45000
<b>B503</b>		
ENAMO, OA FIX	RYDEL, BS FIX	6000
RYDEL, BS FIX *16500 - MRA	*HODGY, BS FIX	6000



FROM	TO	MEA
<b>B503 - CONTINUED</b>		
HODGY, BS FIX	NASSAU, BS VOR/DME	7000
<b>B646</b>		
CANOA, FL WP	FISH HOOK, FL NDB	2000 MAA - 45000
FISH HOOK, FL NDB	MARATHON, FL NDB	2000 MAA - 45000
MARATHON, FL NDB	AVION, FL FIX	*6000 MAA - 45000
*1400 - MOCA AVION, FL FIX	ELLEE, BS FIX	6000 MAA - 45000
ELLEE, BS FIX	FOWEE, OA FIX	*6000 MAA - 45000
*1400 - MOCA FOWEE, OA FIX	LUCSS, BS FIX	*7000 MAA - 45000
*1400 - MOCA LUCSS, BS FIX	JERRE, OA FIX	*4000 MAA - 45000
*1400 - MOCA JERRE, OA FIX	*TINKY, OA FIX	**4000 MAA - 45000
*8000 - MRA **1400 - MOCA TINKY, OA FIX	NICKO, BS FIX	*4000 MAA - 45000
*1500 - MOCA NICKO, BS FIX	NASSAU, BS VOR/DME	*2000 MAA - 45000
*1500 - MOCA NASSAU, BS VOR/DME	OHBEE, BS FIX	*2000 MAA - 45000
*1500 - MOCA OHBEE, BS FIX	MAMML, BS FIX	*4000 MAA - 45000
*1400 - MOCA MAMML, BS FIX	GRATX, OA WP	*5000 MAA - 45000
*1400 - MOCA		
<b>B760</b>		
BIMINI, BS VORTAC	LEEVI, BS FIX	4000
LEEVI, BS FIX	MENDL, BS FIX	8000
MENDL, BS FIX	BORDO, OA FIX	12000
<b>B891</b>		
POKEG, IB FIX	GRADI, OA FIX	4000
GRADI, OA FIX	WATRS, OA FIX	10000
<b>B892</b>		
ANTEX, PR FIX	MAYAGUEZ, PR VOR/DME	4000
<b>G430</b>		
VIRGINIA KEY, FL VOR/DME	EONNS, FL FIX	3000

FROM	TO	MEA
<b>G430 - CONTINUED</b>		
EONNS, FL FIX	AVION, FL FIX	4000
<b>G437</b>		
*DYNAH, OA FIX	**JAYEE, BS FIX	6000 MAA - 45000
*14000 - MRA		
**14000 - MRA		
JAYEE, BS FIX	JEFRY, BS FIX	*4000 MAA - 45000
*1400 - MOCA		
JEFRY, BS FIX	BRONO, BS FIX	*4000 MAA - 45000
*1500 - MOCA		
BRONO, BS FIX	WELKS, BS FIX	*2000 MAA - 45000
*1500 - MOCA		
WELKS, BS FIX	NASSAU, BS VOR/DME	*2000
*1500 - MOCA		
NASSAU, BS VOR/DME	INGRA, BS FIX	2000
INGRA, BS FIX	MAPYL, OA WP	8000
<b>G439</b>		
DOLPHIN, FL VORTAC	MNATE, FL FIX	3000
MNATE, FL FIX	TWNNNS, FL FIX	5000
TWNNNS, FL FIX	DROWN, FL FIX	5000
<b>G444</b>		
BOTES, OA FIX	SAAKO, IB FIX	3000 MAA - 60000
SAAKO, IB FIX	GRAND TURK, TC VORTAC	3000 MAA - 60000
<b>G629</b>		
KNSLY, OA WP	RAPPR, OA FIX	3000
CATHI, OA FIX	PROVIDENCIALES, TC VOR/DME	1500
PROVIDENCIALES, TC VOR/DME	EGANN, IB FIX	1500
EGANN, IB FIX	RAHAM, TC FIX	2000
RAHAM, TC FIX	LYMIN, OA FIX	2000
<b>G633</b>		
GABAR, VI FIX	*DANDE, VI FIX	3500
*3500 - MRA		
DANDE, VI FIX	TANZY, VI FIX	3100
TANZY, VI FIX	ST CROIX, VI VOR/DME	2400
ST CROIX, VI VOR/DME	SNOOZ, VI FIX	3300
SNOOZ, VI FIX	TUUNA, PR FIX	3300
TUUNA, PR FIX	DORADO, PR NDB	5000
DORADO, PR NDB	MAYAGUEZ, PR VOR/DME	5000
MAYAGUEZ, PR VOR/DME	ZADAV, PR FIX	6000
ZADAV, PR FIX	MELLA, PR WP	6000
<b>G648</b>		
GRAND TURK, TC VORTAC	PROVIDENCIALES, TC VOR/DME	1500

FROM	TO	MEA
<b>G648 - CONTINUED</b>		
PROVIDENCIALES, TC VOR/DME	MICAS, TC FIX	2000
<b>G765</b>		
MAXIM, FL WP	FISH HOOK, FL NDB	*3000
*1300 - MOCA		MAA - 45000
<b>L204</b>		
GESSO, PR FIX	ST CROIX, VI VOR/DME	GNSS - 18000
		MAA - 60000
ST CROIX, VI VOR/DME	MLIZA, OA WP	GNSS - 18000
		MAA - 60000
MLIZA, OA WP	GOUDA, VI FIX	GNSS - 18000
		MAA - 60000
GOUDA, VI FIX	SAINT MAARTEN, AN VOR/DME	GNSS - 18000
		MAA - 60000
<b>L207</b>		
SCHOLES, TX VOR/DME	MUSYL, OG FIX	4000
		MAA - 45000
MUSYL, OG FIX	CATFS, OG WP	4000
		MAA - 45000
CATFS, OG WP	SEAGL, OG WP	4000
		MAA - 45000
SEAGL, OG WP	IPSEV, OG WP	4000
		MAA - 45000
<b>L208</b>		
SABINE PASS, TX VOR/DME	ANKRR, OG WP	4000
		MAA - 45000
ANKRR, OG WP	RUMMM, OG WP	4000
		MAA - 45000
RUMMM, OG WP	PEGLG, OG WP	4000
		MAA - 45000
PEGLG, OG WP	DUTNA, OG WP	4000
		MAA - 45000
<b>L214</b>		
LEEVILLE, LA VORTAC	PLNDR, OG WP	4000
		MAA - 45000
PLNDR, OG WP	DAGGR, OG WP	4000
		MAA - 45000
DAGGR, OG WP	IRDOV, OG WP	4000
		MAA - 45000
<b>L216</b>		
GRAND TURK, TC VORTAC	SHRUM, OA WP	GNSS - 3000
		MAA - 60000
SHRUM, OA WP	LERED, OA FIX	GNSS - 3000
		MAA - 60000
<b>L221</b>		
SATOE, OA WP	TAYOG, PR WP	7000
		MAA - 60000

FROM	TO	MEA
<b>L221 - CONTINUED</b>		
TAYOG, PR WP	JOSHE, PR FIX	7000 MAA - 60000
<b>L325</b>		
SCAPA, PR WP	DAKES, PR WP	GNSS - 7000 MAA - 60000
DAKES, PR WP	GABYY, PR WP	GNSS - 7000 MAA - 60000
GABYY, PR WP	JOSHE, PR FIX	GNSS - 7000 MAA - 60000
<b>L327</b>		
SCAPA, PR WP	OPAU, OA WP	GNSS - 18000 MAA - 45000
<b>L329</b>		
ZPATA, PR FIX	SAINT MAARTEN, AN VOR/DME	GNSS - 18000 MAA - 45000
SAINT MAARTEN, AN VOR/DME	SAULT, PR WP	GNSS - 18000 MAA - 45000
SAULT, PR WP	KEEKA, OA WP	GNSS - 18000 MAA - 45000
<b>L333</b>		
HARVEY, LA VORTAC	HOOCK, OG WP	4000 MAA - 45000
HOOCK, OG WP	TRESR, OG WP	4000 MAA - 45000
TRESR, OG WP	CCUDA, OG WP	4000 MAA - 45000
CCUDA, OG WP	PISAD, OG WP	4000 MAA - 45000
<b>L335</b>		
SCAPA, PR WP	MLIZA, OA WP	GNSS - 18000 MAA - 45000
MLIZA, OA WP	TRNKY, OA WP	GNSS - 18000 MAA - 45000
TRNKY, OA WP	OBIKE, OA WP	GNSS - 18000 MAA - 45000
<b>L337</b>		
ARMUR, PR WP	KBEZA, OA WP	GNSS - 5500 MAA - 60000
KBEZA, OA WP	NEGON, DO FIX	GNSS - 5500 MAA - 60000
<b>L343</b>		
ANADA, OA WP	SATOE, OA WP	GNSS - 5500 MAA - 60000
<b>L349</b>		
GABAR, VI FIX	GESSO, PR FIX	5500 MAA - 60000

FROM	TO	MEA
<b>L349 - CONTINUED</b>		
GESSO, PR FIX	SATOE, OA WP	5500 MAA - 60000
<b>L375</b>		
JAINS, OA WP	FLUPS, OA WP	GNSS - 5500 MAA - 60000
FLUPS, OA WP	GALVN, OA WP	GNSS - 5500 MAA - 60000
GALVN, OA WP	DUNIG, OA WP	GNSS - 5500 MAA - 60000
DUNIG, OA WP	MEGGG, OA WP	GNSS - 5500 MAA - 60000
MEGGG, OA WP	BRKZZ, OA WP	GNSS - 5500 MAA - 60000
BRKZZ, OA WP	KOZIK, OA WP	GNSS - 5500 MAA - 60000
KOZIK, OA WP	FIVZE, OA WP	GNSS - 5500 MAA - 60000
FIVZE, OA WP	DABAK, OA WP	GNSS - 5500 MAA - 60000
<b>L435</b>		
JAINS, OA WP	FLUPS, OA WP	GNSS - 5500 MAA - 60000
FLUPS, OA WP	GALVN, OA WP	GNSS - 5500 MAA - 60000
GALVN, OA WP	DUNIG, OA WP	GNSS - 5500 MAA - 60000
DUNIG, OA WP	MEGGG, OA WP	GNSS - 5500 MAA - 60000
MEGGG, OA WP	BRKZZ, OA WP	GNSS - 5500 MAA - 60000
BRKZZ, OA WP	KOZIK, OA WP	GNSS - 5500 MAA - 60000
KOZIK, OA WP	FIVZE, OA WP	GNSS - 5500 MAA - 60000
FIVZE, OA WP	BUTUX, OA WP	GNSS - 5500 MAA - 60000
<b>L450</b>		
LETON, OA WP	IORIO, OA WP	GNSS - 18000 MAA - 60000
IORIO, OA WP	HELAX, OA WP	GNSS - 18000 MAA - 60000
HELAX, OA WP	COUKY, OA FIX	GNSS - 18000 MAA - 60000
COUKY, OA FIX	FOLLE, OA FIX	GNSS - 18000 MAA - 60000
FOLLE, OA FIX	JEFFO, OA FIX	GNSS - 18000 MAA - 60000
JEFFO, OA FIX	HAGIT, OA WP	GNSS - 18000 MAA - 60000
HAGIT, OA WP	TAANA, OA FIX	GNSS - 18000 MAA - 60000
TAANA, OA FIX	SEKAR, DO FIX	GNSS - 18000 MAA - 60000

FROM	TO	MEA
<b>L451</b>		
ELMUC, OA WP	MYSTR, OA WP	GNSS - 3000 MAA - 60000
MYSTR, OA WP	LERUG, OA FIX	GNSS - 3000 MAA - 60000
LERUG, OA FIX	DUNED, OA FIX	GNSS - 3000 MAA - 60000
DUNED, OA FIX	CERDA, OA WP	GNSS - 3000 MAA - 60000
CERDA, OA WP	JORGG, OA WP	GNSS - 3000 MAA - 60000
JORGG, OA WP	IORIO, OA WP	GNSS - 3000 MAA - 60000
IORIO, OA WP	LETON, OA WP	GNSS - 3000 MAA - 60000
LETON, OA WP	ILIDO, OA WP	GNSS - 5500 MAA - 60000
ILIDO, OA WP	JAINS, OA WP	GNSS - 5500 MAA - 60000
<b>L452</b>		
OXANA, OA FIX	ZZTOP, OA WP	5500 MAA - 60000
ZZTOP, OA WP	OMALA, OA WP	5500 MAA - 60000
OMALA, OA WP	WILYY, OA WP	5500 MAA - 60000
WILYY, OA WP	KANUX, OA WP	5500 MAA - 60000
KANUX, OA WP	GALVN, OA WP	5500 MAA - 60000
GALVN, OA WP	KASAR, OA WP	5500 MAA - 60000
KASAR, OA WP	LNHOM, OA WP	5500 MAA - 60000
LNHOM, OA WP	SLUKA, OA WP	5500 MAA - 60000
SLUKA, OA WP	JORGG, OA WP	5500 MAA - 60000
JORGG, OA WP	CAROX, OA WP	5500 MAA - 60000
CAROX, OA WP	NELSR, OA WP	5500 MAA - 60000
NELSR, OA WP	HAGIT, OA WP	5500 MAA - 60000
HAGIT, OA WP	RNTRY, OA FIX	5500 MAA - 60000
RNTRY, OA FIX	MACKI, OA FIX	5500 MAA - 60000
MACKI, OA FIX	HARBG, OA FIX	5500 MAA - 60000
HARBG, OA FIX	MUNOZ, OA WP	5500 MAA - 60000
MUNOZ, OA WP	BORINQUEN, PR VORTAC	5500 MAA - 60000
BORINQUEN, PR VORTAC	ETEEE, OA WP	5500 MAA - 60000
ETEEE, OA WP	RAFEE, OA WP	5500 MAA - 60000

FROM	TO	MEA
------	----	-----

**L452 - CONTINUED**

RAFEE, OA WP	ANADA, OA WP	5500 MAA - 60000
--------------	--------------	---------------------

**L453**

SAUCR, OA WP	ONGOT, OA WP	GNSS - 5500 MAA - 60000
ONGOT, OA WP	LSIER, OA WP	GNSS - 5500 MAA - 60000
LSIER, OA WP	ALOB, OA WP	GNSS - 5500 MAA - 60000
ALOB, OA WP	BOREX, OA WP	GNSS - 5500 MAA - 60000
BOREX, OA WP	LAMER, OA WP	GNSS - 5500 MAA - 60000
LAMER, OA WP	RODRK, OA WP	GNSS - 5500 MAA - 60000
RODRK, OA WP	CERDA, OA WP	GNSS - 5500 MAA - 60000
CERDA, OA WP	DETRE, OA WP	GNSS - 5500 MAA - 60000
DETRE, OA WP	FARMN, OA WP	GNSS - 5500 MAA - 60000
FARMN, OA WP	JSTIN, OA WP	GNSS - 5500 MAA - 60000
JSTIN, OA WP	ANTOX, OA WP	GNSS - 5500 MAA - 60000
ANTOX, OA WP	KARRN, OA FIX	GNSS - 5500 MAA - 60000
KARRN, OA FIX	MACKI, OA FIX	GNSS - 5500 MAA - 60000
MACKI, OA FIX	ASIVO, DO WP	GNSS - 5500 MAA - 60000

**L454**

OKONU, OA WP	ATUGI, OA WP	GNSS - 5500 MAA - 60000
ATUGI, OA WP	GOUGH, OA WP	GNSS - 5500 MAA - 60000
GOUGH, OA WP	PERDO, OA WP	GNSS - 5500 MAA - 60000
PERDO, OA WP	SAVON, OA WP	GNSS - 5500 MAA - 60000
SAVON, OA WP	GRAMN, OA WP	GNSS - 5500 MAA - 60000
GRAMN, OA WP	SEBIS, OA WP	GNSS - 5500 MAA - 60000
SEBIS, OA WP	RABAL, OA WP	GNSS - 5500 MAA - 60000
RABAL, OA WP	LUCTI, OA WP	GNSS - 5500 MAA - 60000
LUCTI, OA WP	SINGL, OA WP	GNSS - 3000 MAA - 60000
SINGL, OA WP	MNDEZ, OA WP	GNSS - 3000 MAA - 60000
MNDEZ, OA WP	ALERI, OA WP	GNSS - 3000 MAA - 60000
ALERI, OA WP	WOODZ, OA WP	GNSS - 3000 MAA - 60000

FROM	TO	MEA
<b>L454 - CONTINUED</b>		
WOODZ, OA WP	KNDLL, OA WP	GNSS - 3000 MAA - 60000
KNDLL, OA WP	DONQU, OA WP	GNSS - 3000 MAA - 60000
DONQU, OA WP	PANMO, OA WP	GNSS - 5500 MAA - 60000
PANMO, OA WP	GOTAY, PR WP	GNSS - 5500 MAA - 60000
GOTAY, PR WP	LEEEO, OA WP	GNSS - 5500 MAA - 60000
LEEEO, OA WP	ILURI, OA FIX	GNSS - 5500 MAA - 60000
<b>L455</b>		
SAVIK, OA WP	SKPPR, OA WP	GNSS - 5500 MAA - 60000
SKPPR, OA WP	BEXUM, OA WP	GNSS - 5500 MAA - 60000
BEXUM, OA WP	TASNI, OA WP	GNSS - 5500 MAA - 60000
TASNI, OA WP	DUNIG, OA WP	GNSS - 5500 MAA - 60000
DUNIG, OA WP	DUPOX, OA WP	GNSS - 5500 MAA - 60000
DUPOX, OA WP	VESRA, OA WP	GNSS - 5500 MAA - 60000
VESRA, OA WP	MCOOP, OA WP	GNSS - 5500 MAA - 60000
MCOOP, OA WP	MACOR, OA WP	GNSS - 5500 MAA - 60000
MACOR, OA WP	KINCH, OA WP	GNSS - 5500 MAA - 60000
KINCH, OA WP	LENNT, OA WP	GNSS - 5500 MAA - 60000
LENNT, OA WP	JANMA, OA WP	GNSS - 5500 MAA - 60000
JANMA, OA WP	VACHI, OA WP	GNSS - 5500 MAA - 60000
VACHI, OA WP	KBEZA, OA WP	GNSS - 21000 MAA - 60000
KBEZA, OA WP	SCAPA, PR WP	GNSS - 21000 MAA - 60000
<b>L456</b>		
MARIG, OA WP	DARUX, OA WP	GNSS - 5500 MAA - 60000
DARUX, OA WP	NOSID, OA WP	GNSS - 5500 MAA - 60000
NOSID, OA WP	EMAKO, OA WP	GNSS - 5500 MAA - 60000
EMAKO, OA WP	MEGGG, OA WP	GNSS - 5500 MAA - 60000
MEGGG, OA WP	VINSO, OA WP	GNSS - 5500 MAA - 60000
VINSO, OA WP	PRCHA, OA WP	GNSS - 5500 MAA - 60000
PRCHA, OA WP	HANCY, OA WP	GNSS - 5500 MAA - 60000



FROM	TO	MEA
<b>L456 - CONTINUED</b>		
HANCY, OA WP	THANK, PR WP	GNSS - 5500 MAA - 60000
THANK, PR WP	FRATT, OA WP	GNSS - 15000 MAA - 60000
FRATT, OA WP	ETEEE, OA WP	GNSS - 15000 MAA - 60000
ETEEE, OA WP	KIKER, OA WP	GNSS - 15000 MAA - 60000
<b>L457</b>		
OKONU, OA WP	SKPPR, OA WP	GNSS - 5500 MAA - 60000
SKPPR, OA WP	NOSID, OA WP	GNSS - 5500 MAA - 60000
NOSID, OA WP	ENAPI, OA WP	GNSS - 5500 MAA - 60000
ENAPI, OA WP	AWSOM, OA WP	GNSS - 5500 MAA - 60000
AWSOM, OA WP	GUICE, OA WP	GNSS - 21000 MAA - 60000
GUICE, OA WP	BERMUDA, BM VOR/DME	GNSS - 21000 MAA - 60000
<b>L458</b>		
GECAL, OA WP	TALSU, OA WP	GNSS - 5500 MAA - 60000
TALSU, OA WP	CHEDR, OA WP	GNSS - 5500 MAA - 60000
CHEDR, OA WP	THANK, PR WP	GNSS - 5500 MAA - 60000
THANK, PR WP	PANMO, OA WP	GNSS - 7000 MAA - 60000
PANMO, OA WP	ARMUR, PR WP	GNSS - 7000 MAA - 60000
<b>L459</b>		
SAVIK, OA WP	DARUX, OA WP	GNSS - 5500 MAA - 60000
DARUX, OA WP	DASER, OA WP	GNSS - 5500 MAA - 60000
DASER, OA WP	AWSOM, OA WP	GNSS - 5500 MAA - 60000
AWSOM, OA WP	BOBBO, OA WP	GNSS - 5500 MAA - 60000
BOBBO, OA WP	QRTET, OA WP	GNSS - 5500 MAA - 60000
QRTET, OA WP	CATZZ, OA WP	GNSS - 5500 MAA - 60000
CATZZ, OA WP	SHEIL, OA WP	GNSS - 5500 MAA - 60000
SHEIL, OA WP	TALSU, OA WP	GNSS - 5500 MAA - 60000
TALSU, OA WP	NUBUS, OA WP	GNSS - 5500 MAA - 60000
NUBUS, OA WP	KEEKA, OA WP	GNSS - 5500 MAA - 60000

FROM	TO	MEA
<b>L459 - CONTINUED</b>		
KEEKA, OA WP	ODUCA, OA WP	GNSS - 5500 MAA - 60000
ODUCA, OA WP	CAFFE, OA WP	GNSS - 5500 MAA - 60000
CAFFE, OA WP	LEEEO, OA WP	GNSS - 5500 MAA - 60000
LEEEO, OA WP	ANADA, OA WP	GNSS - 5500 MAA - 60000
<b>L460</b>		
ST THOMAS, VI VOR/DME	ODUCA, OA WP	GNSS - 6000 MAA - 60000
<b>L461</b>		
MARIG, OA WP	TILED, OA WP	GNSS - 5500 MAA - 60000
TILED, OA WP	KINER, OA WP	GNSS - 5500 MAA - 60000
KINER, OA WP	BOVIC, OA WP	GNSS - 5500 MAA - 60000
BOVIC, OA WP	FLAMO, OA WP	GNSS - 15000 MAA - 60000
FLAMO, OA WP	GUICE, OA WP	GNSS - 15000 MAA - 60000
GUICE, OA WP	LITTL, OA WP	GNSS - 15000 MAA - 60000
LITTL, OA WP	PIERC, OA WP	GNSS - 15000 MAA - 60000
PIERC, OA WP	ROOFE, OA WP	GNSS - 15000 MAA - 60000
ROOFE, OA WP	SICKL, OA WP	GNSS - 15000 MAA - 60000
SICKL, OA WP	GECAL, OA WP	GNSS - 15000 MAA - 60000
GECAL, OA WP	BRKZZ, OA WP	GNSS - 5500 MAA - 60000
BRKZZ, OA WP	DUPAN, OA WP	GNSS - 5500 MAA - 60000
DUPAN, OA WP	QNEPA, OA WP	GNSS - 5500 MAA - 60000
QNEPA, OA WP	OPAU, OA WP	GNSS - 5500 MAA - 60000
OPAU, OA WP	YIYYO, OA WP	GNSS - 6000 MAA - 60000
YIYYO, OA WP	TRNKY, OA WP	GNSS - 6000 MAA - 60000
TRNKY, OA WP	SAINT MAARTEN, AN VOR/DME	GNSS - 6000 MAA - 60000
<b>L462</b>		
KAYYT, OA WP	OVAPI, OA WP	GNSS - 5500 MAA - 60000
OVAPI, OA WP	ANVER, OA WP	GNSS - 5500 MAA - 60000
KOZIK, OA WP	TARMO, OA WP	GNSS - 5500 MAA - 60000

FROM	TO	MEA
<b>L462 - CONTINUED</b>		
TARMO, OA WP	ZABOR, OA WP	GNSS - 5500 MAA - 60000
ZABOR, OA WP	DAWIN, OA WP	GNSS - 5500 MAA - 60000
DAWIN, OA WP	NEYDU, OA WP	GNSS - 5500 MAA - 60000
NEYDU, OA WP	LAMKN, OA WP	GNSS - 5500 MAA - 60000
<b>L463</b>		
NUCAR, BS FIX	BAAGR, OA WP	GNSS - 3000 MAA - 60000
BAAGR, OA WP	DAAST, BS WP	GNSS - 3000 MAA - 60000
DAAST, BS WP	KRTIS, OA WP	GNSS - 3000 MAA - 60000
KRTIS, OA WP	STAAL, OA WP	GNSS - 3000 MAA - 60000
STAAL, OA WP	BRRGO, OA FIX	GNSS - 3000 MAA - 60000
BRRGO, OA FIX	SMTTY, OA WP	GNSS - 3000 MAA - 60000
SMTTY, OA WP	RNDLY, OA WP	GNSS - 3000 MAA - 60000
RNDLY, OA WP	BTLER, OA FIX	GNSS - 3000 MAA - 60000
BTLER, OA FIX	PROVIDENCIALES, TC VOR/DME	GNSS - 3000 MAA - 60000
PROVIDENCIALES, TC VOR/DME	TOMAZ, OA FIX	GNSS - 3000 MAA - 60000
TOMAZ, OA FIX	GOVET, OA FIX	GNSS - 3000 MAA - 60000
GOVET, OA FIX	JUELE, OA FIX	GNSS - 3000 MAA - 60000
<b>L464</b>		
LAMER, OA WP	RODRK, OA WP	GNSS - 3000 MAA - 60000
RODRK, OA WP	CERDA, OA WP	GNSS - 3000 MAA - 60000
CERDA, OA WP	WAROD, OA WP	GNSS - 3000 MAA - 60000
WAROD, OA WP	MANII, OA WP	GNSS - 3000 MAA - 60000
MANII, OA WP	LENUS, OA WP	GNSS - 3000 MAA - 60000
LENUS, OA WP	SEBUG, OA FIX	GNSS - 3000 MAA - 60000
SEBUG, OA FIX	RNTRY, OA FIX	GNSS - 3000 MAA - 60000
RNTRY, OA FIX	LERED, OA FIX	GNSS - 3000 MAA - 60000
<b>L465</b>		
SHARQ, OG WP	NAVVL, OG WP	4000 MAA - 45000

FROM	TO	MEA
<b>L465 - CONTINUED</b>		
NAVVL, OG WP	MINOW, OG FIX	4000
		MAA - 45000
MINOW, OG FIX	TRESR, OG WP	4000
		MAA - 45000
TRESR, OG WP	PLNDR, OG WP	4000
		MAA - 45000
<b>L466</b>		
MEEGL, PR WP	GEECE, OA WP	GNSS - 7000
		MAA - 60000
<b>L467</b>		
ANADA, OA WP	ANNER, OA WP	GNSS - 7000
		MAA - 60000
ANNER, OA WP	GESSO, PR FIX	GNSS - 7000
		MAA - 60000
<b>L576</b>		
BERMUDA, BM VOR/DME	SEAVR, OA WP	5500
		MAA - 60000
SEAVR, OA WP	RKDIA, OA WP	5500
		MAA - 60000
RKDIA, OA WP	CITRS, OA WP	5500
		MAA - 60000
<b>L577</b>		
ELOPO, PR FIX	GOUDA, VI FIX	6000
		MAA - 60000
GOUDA, VI FIX	STIIV, OA WP	6000
		MAA - 60000
STIIV, OA WP	ANTEX, PR FIX	6000
		MAA - 60000
<b>L776</b>		
MACOR, OA WP	FERNA, OA WP	GNSS - 5500
		MAA - 60000
FERNA, OA WP	STIIV, OA WP	GNSS - 5500
		MAA - 60000
STIIV, OA WP	GEECE, OA WP	GNSS - 5500
		MAA - 60000
<b>M201</b>		
VIRST, OA WP	VEGAA, OA WP	GNSS - 3100
		MAA - 60000
VEGAA, OA WP	ATUGI, OA WP	GNSS - 3100
		MAA - 60000
ATUGI, OA WP	TILED, OA WP	GNSS - 5500
		MAA - 60000
TILED, OA WP	DRYED, OA WP	GNSS - 5500
		MAA - 60000
DRYED, OA WP	NOVOK, OA WP	GNSS - 5500
		MAA - 60000
NOVOK, OA WP	CARAC, OA WP	GNSS - 5500
		MAA - 60000

FROM	TO	MEA
<b>M202</b>		
HOBEE, FL FIX	INDRO, OA WP	GNSS - 5500 MAA - 60000
INDRO, OA WP	BGDOG, OA WP	GNSS - 5500 MAA - 60000
BGDOG, OA WP	LEND, OA WP	GNSS - 5500 MAA - 60000
LEND, OA WP	ADOOR, FL FIX	GNSS - 5500 MAA - 60000
ADOOR, FL FIX	ETECK, OA WP	GNSS - 5500 MAA - 60000
ETECK, OA WP	CANIT, OA WP	GNSS - 5500 MAA - 60000
CANIT, OA WP	CARPX, OA WP	GNSS - 5500 MAA - 60000
CARPX, OA WP	UKOKA, OA WP	GNSS - 5500 MAA - 60000
UKOKA, OA WP	OMALA, OA WP	GNSS - 5500 MAA - 60000
OMALA, OA WP	ONGOT, OA WP	GNSS - 5500 MAA - 60000
ONGOT, OA WP	GOUGH, OA WP	GNSS - 5500 MAA - 60000
GOUGH, OA WP	KINER, OA WP	GNSS - 5500 MAA - 60000
KINER, OA WP	OVAPI, OA WP	GNSS - 5500 MAA - 60000
OVAPI, OA WP	MUNEY, OA WP	GNSS - 5500 MAA - 60000
MUNEY, OA WP	JEBBY, CA WP	GNSS - 5500 MAA - 60000
JEBBY, CA WP	LOMPI, OA WP	GNSS - 5500 MAA - 60000

<b>M203</b>		
HOBEE, FL FIX	INDRO, OA WP	GNSS - 5500 MAA - 60000
INDRO, OA WP	BGDOG, OA WP	GNSS - 5500 MAA - 60000
BGDOG, OA WP	LEND, OA WP	GNSS - 5500 MAA - 60000
LEND, OA WP	ADOOR, FL FIX	GNSS - 5500 MAA - 60000
ADOOR, FL FIX	CASPR, OA FIX	GNSS - 5500 MAA - 60000
CASPR, OA FIX	SNAGY, OA WP	GNSS - 5500 MAA - 60000
SNAGY, OA WP	LEXIM, OA WP	GNSS - 5500 MAA - 60000
LEXIM, OA WP	WILYY, OA WP	GNSS - 5500 MAA - 60000
WILYY, OA WP	LSIER, OA WP	GNSS - 5500 MAA - 60000
LSIER, OA WP	PERDO, OA WP	GNSS - 5500 MAA - 60000
PERDO, OA WP	SELIM, OA WP	GNSS - 5500 MAA - 60000
SELIM, OA WP	BOBTU, CA WP	GNSS - 5500 MAA - 60000

FROM	TO	MEA
<b>M204</b>		
SUMRS, OA WP	FLUPS, OA WP	5500
		MAA - 60000
FLUPS, OA WP	ALOBI, OA WP	5500
		MAA - 60000
ALOBI, OA WP	BEXUM, OA WP	5500
		MAA - 60000
BEXUM, OA WP	LUNKR, OA WP	5500
		MAA - 60000
LUNKR, OA WP	SOORY, OA WP	5500
		MAA - 60000
<b>M215</b>		
PISAD, OG WP	MINOW, OG FIX	4000
		MAA - 45000
MINOW, OG FIX	SNOMN, OG WP	4000
		MAA - 45000
SNOMN, OG WP	CIGAR, OG WP	4000
		MAA - 45000
CIGAR, OG WP	KNOST, OG WP	4000
		MAA - 45000
<b>M219</b>		
MYDIA, OG WP	NAVVL, OG WP	4000
		MAA - 45000
NAVVL, OG WP	SNAKR, OG WP	4000
		MAA - 45000
SNAKR, OG WP	BUUOY, OG WP	4000
		MAA - 45000
BUUOY, OG WP	CULLY, OG WP	4000
		MAA - 45000
CULLY, OG WP	CIGAR, OG WP	4000
		MAA - 45000
CIGAR, OG WP	KNOST, OG WP	4000
		MAA - 45000
<b>M325</b>		
OXANA, OA FIX	NETSS, OA WP	5500
		MAA - 60000
NETSS, OA WP	ONGOT, OA WP	5500
		MAA - 60000
ONGOT, OA WP	PERDO, OA WP	5500
		MAA - 60000
PERDO, OA WP	ENAPI, OA WP	5500
		MAA - 60000
ENAPI, OA WP	AWSOM, OA WP	6000
AWSOM, OA WP	GUICE, OA WP	6000
GUICE, OA WP	BERMUDA, BM VOR/DME	6000
<b>M326</b>		
JAINS, OA WP	LEXIM, OA WP	GNSS - 5500
		MAA - 60000
LEXIM, OA WP	ALOBI, OA WP	GNSS - 5500
		MAA - 60000
ALOBI, OA WP	JIMAC, OA WP	GNSS - 5500
		MAA - 60000

FROM	TO	MEA
------	----	-----

**M326 - CONTINUED**

**M327**

SUMRS, OA WP	KANUX, OA WP	GNSS - 5500 MAA - 60000
KANUX, OA WP	SAVON, OA WP	GNSS - 5500 MAA - 60000
SAVON, OA WP	JIMAC, OA WP	GNSS - 5500 MAA - 60000

**M328**

TANIA, OA FIX	JERRE, OA FIX	GNSS - 5500 MAA - 60000
JERRE, OA FIX	RAJAY, BS FIX	GNSS - 5500 MAA - 60000
RAJAY, BS FIX	BARTS, BS FIX	GNSS - 5500 MAA - 60000
BARTS, BS FIX	NATHY, OA WP	GNSS - 5500 MAA - 60000
NATHY, OA WP	BAAGR, OA WP	GNSS - 5500 MAA - 60000
BAAGR, OA WP	SLEMA, OA WP	GNSS - 5500 MAA - 60000
SLEMA, OA WP	ROTHM, OA WP	GNSS - 5500 MAA - 60000
ROTHM, OA WP	CNNOR, OA WP	GNSS - 5500 MAA - 60000
CNNOR, OA WP	ILIDO, OA WP	GNSS - 5500 MAA - 60000
ILIDO, OA WP	GRAMN, OA WP	GNSS - 5500 MAA - 60000
GRAMN, OA WP	TASNI, OA WP	GNSS - 5500 MAA - 60000
TASNI, OA WP	EMAKO, OA WP	GNSS - 5500 MAA - 60000
EMAKO, OA WP	ANTIG, OA WP	GNSS - 5500 MAA - 60000

**M329**

*DYNAH, OA FIX	NASSAU, BS VOR/DME	GNSS - 5500 MAA - 60000
*14000 - MRA		
NASSAU, BS VOR/DME	OHBEE, BS FIX	GNSS - 5500 MAA - 60000
OHBEE, BS FIX	MAMML, BS FIX	GNSS - 5500 MAA - 60000
MAMML, BS FIX	EXTER, OA FIX	GNSS - 5500 MAA - 60000
EXTER, OA FIX	DAAST, BS WP	GNSS - 5500 MAA - 60000
DAAST, BS WP	LASEE, OA WP	GNSS - 5500 MAA - 60000
LASEE, OA WP	CLETT, OA WP	GNSS - 5500 MAA - 60000
CLETT, OA WP	GRATX, OA WP	GNSS - 5500 MAA - 60000
GRATX, OA WP	KASAR, OA WP	GNSS - 5500 MAA - 60000

FROM	TO	MEA
<b>M329 - CONTINUED</b>		
KASAR, OA WP	BOREX, OA WP	GNSS - 5500 MAA - 60000
BOREX, OA WP	BALTN, OA WP	GNSS - 5500 MAA - 60000
<b>M330</b>		
ENAMO, OA FIX	ZWICK, OA WP	GNSS - 5500 MAA - 60000
ZWICK, OA WP	KFFER, OA WP	GNSS - 5500 MAA - 60000
KFFER, OA WP	DONEZ, OA FIX	GNSS - 5500 MAA - 60000
DONEZ, OA FIX	MUVOD, BS FIX	GNSS - 5500 MAA - 60000
MUVOD, BS FIX	DIAZZ, OA FIX	GNSS - 5500 MAA - 60000
DIAZZ, OA FIX	KRTIS, OA WP	GNSS - 5500 MAA - 60000
KRTIS, OA WP	WITOB, OA WP	GNSS - 5500 MAA - 60000
WITOB, OA WP	ALUTE, OA WP	GNSS - 5500 MAA - 60000
ALUTE, OA WP	MLSAP, OA FIX	GNSS - 5500 MAA - 60000
MLSAP, OA FIX	MILLE, OA WP	GNSS - 5500 MAA - 60000
MILLE, OA WP	RUDLI, OA WP	GNSS - 5500 MAA - 60000
RUDLI, OA WP	DUNIG, OA WP	GNSS - 5500 MAA - 60000
DUNIG, OA WP	SHEIL, OA WP	GNSS - 5500 MAA - 60000
SHEIL, OA WP	SICKL, OA WP	GNSS - 5500 MAA - 60000
<b>M345</b>		
AXEXO, OG WP	SEAGL, OG WP	4000 MAA - 45000
SEAGL, OG WP	RUMMM, OG WP	4000 MAA - 45000
RUMMM, OG WP	KENGS, OG WP	4000 MAA - 45000
KENGS, OG WP	WAHOO, OG FIX	4000 MAA - 45000
WAHOO, OG FIX	TIBBY, LA VOR/DME	4000 MAA - 45000
<b>M348</b>		
MEDKO, OA WP	KNSLY, OA WP	GNSS - 2700 MAA - 60000
KNSLY, OA WP	ALBBE, BS FIX	GNSS - 2700 MAA - 60000
KATOK, PR FIX	AQABA, PR FIX	GNSS - 5500 MAA - 60000
AQABA, PR FIX	MEEGL, PR WP	GNSS - 5500 MAA - 60000



FROM	TO	MEA
<b>M423</b>		
KIKER, OA WP	RAYAS, OA WP	GNSS - 18000 MAA - 60000
RAYAS, OA WP	PLING, PR FIX	GNSS - 18000 MAA - 60000
PLING, PR FIX	LENNT, OA WP	GNSS - 18000 MAA - 60000
<b>M525</b>		
MELLA, PR WP	LEILA, OA WP	GNSS - 5500 MAA - 60000
LEILA, OA WP	VACHI, OA WP	GNSS - 5500 MAA - 60000
VACHI, OA WP	PANMO, OA WP	5500 MAA - 60000
PANMO, OA WP	FRATT, OA WP	GNSS - 5500 MAA - 60000
FRATT, OA WP	CAFFE, OA WP	GNSS - 5500 MAA - 60000
CAFFE, OA WP	YIYYO, OA WP	GNSS - 5500 MAA - 60000
YIYYO, OA WP	SOCCO, OA WP	GNSS - 5500 MAA - 60000
SOCCO, OA WP	ZABOR, OA WP	GNSS - 5500 MAA - 60000
ZABOR, OA WP	KAVAX, OA WP	GNSS - 5500 MAA - 60000
<b>M575</b>		
CLONN, OG FIX	CATFS, OG WP	4000 MAA - 45000
CATFS, OG WP	ANKRR, OG WP	4000 MAA - 45000
ANKRR, OG WP	KENGS, OG WP	4000 MAA - 45000
KENGS, OG WP	WAHOO, OG FIX	4000 MAA - 45000
WAHOO, OG FIX	TIBBY, LA VOR/DME	4000 MAA - 45000
<b>M576</b>		
MILOK, OA WP	RAYAS, OA WP	GNSS - 9000 MAA - 60000
RAYAS, OA WP	RAFEE, OA WP	GNSS - 9000 MAA - 60000
RAFEE, OA WP	ANNER, OA WP	GNSS - 9000 MAA - 60000
ANNER, OA WP	PORQE, VI FIX	GNSS - 9000 MAA - 60000
PORQE, VI FIX	*DANDE, VI FIX	GNSS - 6000 MAA - 60000
*3500 - MRA DANDE, VI FIX	SAINT MAARTEN, AN VOR/DME	GNSS - 6000 MAA - 60000
SAINT MAARTEN, AN VOR/DME	MNOLO, OA WP	GNSS - 6000 MAA - 60000

FROM	TO	MEA
<b>M576 - CONTINUED</b>		
MNOLO, OA WP	NEYDU, OA WP	GNSS - 6000 MAA - 60000
NEYDU, OA WP	OBIKE, OA WP	GNSS - 18000 MAA - 60000
OBIKE, OA WP	RKDIA, OA WP	GNSS - 18000 MAA - 60000
<b>M580</b>		
IRDOV, OG WP	CCUDA, OG WP	4000 MAA - 45000
CCUDA, OG WP	MINOW, OG FIX	4000 MAA - 45000
MINOW, OG FIX	BUUOY, OG WP	4000 MAA - 45000
BUUOY, OG WP	NATLE, OG WP	4000 MAA - 45000
NATLE, OG WP	SHAQQ, FL WP	4000 MAA - 45000
SHAQQ, FL WP	MARCI, FL FIX	4000 MAA - 45000
<b>M593</b>		
GRATX, OA WP	RUDLI, OA WP	GNSS - 5500 MAA - 60000
RUDLI, OA WP	SEBIS, OA WP	GNSS - 5500 MAA - 60000
SEBIS, OA WP	DUPOX, OA WP	GNSS - 5500 MAA - 60000
DUPOX, OA WP	AMENO, OA WP	GNSS - 5500 MAA - 60000
<b>M594</b>		
ALBBE, BS FIX	GOVET, OA FIX	GNSS - 5500 MAA - 60000
GOVET, OA FIX	GRAND TURK, TC VORTAC	GNSS - 5500 MAA - 60000
GRAND TURK, TC VORTAC	NETTA, OA FIX	GNSS - 3000 MAA - 60000
NETTA, OA FIX	EYSEL, OA WP	GNSS - 3000 MAA - 60000
EYSEL, OA WP	CERDA, OA WP	GNSS - 3000 MAA - 60000
CERDA, OA WP	MNDEZ, OA WP	GNSS - 3000 MAA - 60000
MNDEZ, OA WP	MLLER, OA WP	GNSS - 3000 MAA - 60000
MLLER, OA WP	MCOOP, OA WP	GNSS - 5500 MAA - 60000
MCOOP, OA WP	KOZIK, OA WP	GNSS - 5500 MAA - 60000
KOZIK, OA WP	AMENO, OA WP	GNSS - 5500 MAA - 60000
<b>M595</b>		
ERRCA, OA WP	WSSKY, OA WP	GNSS - 3000 MAA - 60000

FROM	TO	MEA
<b>M595 - CONTINUED</b>		
WSSKY, OA WP	LOGVN, OA WP	GNSS - 3000 MAA - 60000
LOGVN, OA WP	STAAL, OA WP	GNSS - 3000 MAA - 60000
STAAL, OA WP	ISOLE, OA WP	GNSS - 3000 MAA - 60000
ISOLE, OA WP	MUSSH, OA WP	GNSS - 3000 MAA - 60000
MUSSH, OA WP	MILLE, OA WP	GNSS - 3000 MAA - 60000
MILLE, OA WP	LFANO, OA WP	GNSS - 5500 MAA - 60000
LFANO, OA WP	RABAL, OA WP	GNSS - 5500 MAA - 60000
RABAL, OA WP	VINSO, OA WP	GNSS - 5500 MAA - 60000
VINSO, OA WP	AYTTE, OA WP	GNSS - 5500 MAA - 60000
<b>M596</b>		
POKEG, IB FIX	MACKI, OA FIX	GNSS - 3000 MAA - 60000
MACKI, OA FIX	GRADI, OA FIX	GNSS - 3000 MAA - 60000
GRADI, OA FIX	NOPIT, OA WP	GNSS - 3000 MAA - 60000
NOPIT, OA WP	CHYLE, OA WP	GNSS - 3000 MAA - 60000
CHYLE, OA WP	FDLEE, OA WP	GNSS - 3000 MAA - 60000
FDLEE, OA WP	MYSTR, OA WP	GNSS - 3000 MAA - 60000
MYSTR, OA WP	KNDLL, OA WP	GNSS - 3000 MAA - 60000
KNDLL, OA WP	WATRS, OA FIX	GNSS - 3000 MAA - 60000
WATRS, OA FIX	MACOR, OA WP	GNSS - 5500 MAA - 60000
MACOR, OA WP	PRCHA, OA WP	GNSS - 5500 MAA - 60000
PRCHA, OA WP	NUBUS, OA WP	GNSS - 5500 MAA - 60000
NUBUS, OA WP	SIFEN, OA WP	GNSS - 5500 MAA - 60000
<b>M597</b>		
BETIR, PR FIX	PUYYA, OA WP	GNSS - 5500 MAA - 60000
PUYYA, OA WP	JANMA, OA WP	GNSS - 5500 MAA - 60000
JANMA, OA WP	THANK, PR WP	GNSS - 5500 MAA - 60000
THANK, PR WP	KEEKA, OA WP	GNSS - 5500 MAA - 60000
KEEKA, OA WP	QNEPA, OA WP	GNSS - 5500 MAA - 60000
QNEPA, OA WP	TARMO, OA WP	GNSS - 5500 MAA - 60000

FROM	TO	MEA
------	----	-----

**M597 - CONTINUED**

TARMO, OA WP	FIVZE, OA WP	GNSS - 5500 MAA - 60000
--------------	--------------	----------------------------

**N779**

ARMUR, PR WP	CRSTL, PR WP	GNSS - 7000 MAA - 60000
CRSTL, PR WP	ALASK, PR WP	GNSS - 7000 MAA - 60000
ALASK, PR WP	JOSHE, PR FIX	GNSS - 7000 MAA - 60000

**Q100**

LEEVILLE, LA VORTAC *1500 - MOCA	REDFN, OG WP	*6000
REDFN, OG WP *1500 - MOCA	NAITE, OG WP	*6000
NAITE, OG WP *1500 - MOCA	ROZZI, OG WP	*6000
ROZZI, OG WP *1500 - MOCA	REMIS, OG WP	*6000
REMIS, OG WP *1500 - MOCA	SARASOTA, FL VOR/DME	*6000

**Q102**

LEEVILLE, LA VORTAC *1500 - MOCA	BLVNS, OG WP	*6000
BLVNS, OG WP *1500 - MOCA	BUNNZ, OG WP	*6000
BUNNZ, OG WP *1500 - MOCA	BACCA, OG WP	*6000
BACCA, OG WP *1500 - MOCA	CIGAR, OG WP	*6000
CIGAR, OG WP *1500 - MOCA	BAGGS, OG WP	*6000
BAGGS, OG WP *1500 - MOCA	CYPRESS, FL VOR/DME	*6000

**Q105**

HARVEY, LA VORTAC *1500 - MOCA	FATSO, OG WP	*6000
FATSO, OG WP *1500 - MOCA	REDFN, OG WP	*6000
REDFN, OG WP *1500 - MOCA	BLVNS, OG WP	*6000

**R56**

LINND, OA FIX	KENDA, OA WP	18000 MAA - 60000
KENDA, OA WP	LARGE, OA WP	18000 MAA - 60000
LARGE, OA WP	PENYT, OA WP	18000 MAA - 60000
PENYT, OA WP	SLATN, OA FIX	18000 MAA - 60000

FROM	TO	MEA
<b>R507</b>		
SAPPO, OA WP	*CONCH, OA FIX	24000
*24000 - MRA		
CONCH, OA FIX	UTAHS, PR FIX	24000
<b>R628</b>		
TANIA, OA FIX	ZOLLA, OA FIX	12000
ZOLLA, OA FIX	MENDL, BS FIX	10000
MENDL, BS FIX	*PEKRE, BS FIX	**6000
		MAA - 45000
*12500 - MRA		
**1400 - MOCA		
PEKRE, BS FIX	SANNS, BS FIX	*2000
		MAA - 45000
*1500 - MOCA		
SANNS, BS FIX	NASSAU, BS VOR/DME	*2000
		MAA - 45000
*1500 - MOCA		
<b>R760</b>		
ST CROIX, VI VOR/DME	GOUDA, VI FIX	5000
		MAA - 18000
GOUDA, VI FIX	SAINT MAARTEN, AN VOR/DME	3000
		MAA - 18000
<b>R763</b>		
GRAND TURK, TC VORTAC	RNTRY, OA FIX	*14000
		MAA - 45000
*1200 - MOCA		
RNTRY, OA FIX	MACKI, OA FIX	14000
MACKI, OA FIX	HARBG, OA FIX	14000
HARBG, OA FIX	MUNOZ, OA WP	14000
MUNOZ, OA WP	BORINQUEN, PR VORTAC	14000
<b>R888</b>		
ST CROIX, VI VOR/DME	MODUX, VI FIX	14000
<b>Y183</b>		
IKBIX, OA WP	PEAKY, FL WP	6000
		MAA - 45000
<b>Y185</b>		
ILURI, OA FIX	ACONY, OA WP	*GNSS - 18000
		MAA - 60000
*4900 - MOCA		
ACONY, OA WP	DOZGO, OA WP	*GNSS - 18000
		MAA - 60000
*4900 - MOCA		
DOZGO, OA WP	DONQU, OA WP	*GNSS - 18000
		MAA - 60000
*4900 - MOCA		
DONQU, OA WP	FARMN, OA WP	GNSS - 18000
		MAA - 60000

FROM	TO	MEA
<b>Y185 - CONTINUED</b>		
FARMN, OA WP	MANII, OA WP	GNSS - 18000 MAA - 60000
MANII, OA WP	NELSR, OA WP	GNSS - 18000 MAA - 60000
NELSR, OA WP	COUKY, OA FIX	GNSS - 18000 MAA - 60000
COUKY, OA FIX	RENAH, OA WP	GNSS - 18000 MAA - 60000
RENAH, OA WP	CVIKK, BS WP	GNSS - 18000 MAA - 60000
CVIKK, BS WP	VENDS, OA WP	GNSS - 18000 MAA - 60000
VENDS, OA WP	BEERD, OA WP	GNSS - 18000 MAA - 60000
BEERD, OA WP	MANLE, FL WP	*GNSS - 18000 MAA - 60000
*1200 - MOCA		
<b>Y196</b>		
CANOA, FL WP	LULLS, FL WP	*GNSS - 18000 MAA - 60000
*1200 - MOCA		
LULLS, FL WP	TUNSL, FL WP	*GNSS - 18000 MAA - 60000
*1200 - MOCA		
<b>Y217</b>		
ZEUSS, OA FIX	FONDS, OA WP	*GNSS - 18000 MAA - 45000
*1300 - MOCA		
FONDS, OA WP	OCTAL, FL WP	GNSS - 18000 MAA - 45000
<b>Y240</b>		
MYDIA, OG WP	NAVVL, OG WP	4000 MAA - 45000
NAVVL, OG WP	SNAKR, OG WP	4000 MAA - 45000
SNAKR, OG WP	YENNE, OG WP	4000 MAA - 45000
YENNE, OG WP	SHAQQ, FL WP	4000 MAA - 45000
SHAQQ, FL WP	MARCI, FL FIX	4000 MAA - 45000
<b>Y259</b>		
BORDO, OA FIX	QUODS, OA WP	*GNSS - 18000 MAA - 60000
*1300 - MOCA		
QUODS, OA WP	OCTAL, FL WP	GNSS - 18000 MAA - 60000
<b>Y260</b>		
ACONY, OA WP	LEEEO, OA WP	GNSS - 18000 MAA - 60000

FROM	TO	MEA
<b>Y260 - CONTINUED</b>		
LEEEO, OA WP	MODUX, VI FIX	GNSS - 18000 MAA - 60000
<b>Y261</b>		
MALVN, OA FIX	BOOZY, OA WP	GNSS - 18000 MAA - 60000
BOOZY, OA WP	MADIZ, OA WP	GNSS - 18000 MAA - 60000
<b>Y262</b>		
MAXIM, FL WP	LULLS, FL WP	GNSS - 18000 MAA - 45000
LULLS, FL WP	TUNSL, FL WP	GNSS - 18000 MAA - 60000
TUNSL, FL WP	GOPEY, FL WP	GNSS - 18000 MAA - 60000
GOPEY, FL WP	LINEY, FL WP	GNSS - 18000 MAA - 60000
LINEY, FL WP	SAXXN, FL WP	GNSS - 18000 MAA - 60000
SAXXN, FL WP	CANVI, OA WP	GNSS - 18000 MAA - 60000
CANVI, OA WP	FREEPORT, BS VOR/DME	GNSS - 18000 MAA - 60000
<b>Y280</b>		
LEEVILLE, LA VORTAC	REDFN, OG WP	GNSS - 6000 MAA - 60000
REDFN, OG WP	NAITE, OG WP	GNSS - 6000 MAA - 60000
NAITE, OG WP	ROZZI, OG WP	GNSS - 6000 MAA - 60000
ROZZI, OG WP	REMIS, OG WP	GNSS - 6000 MAA - 60000
REMIS, OG WP	CHRG, OG WP	GNSS - 6000 MAA - 60000
CHRG, OG WP	JONBU, OG WP	GNSS - 6000 MAA - 60000
JONBU, OG WP	SARASOTA, FL VOR/DME	GNSS - 18000 MAA - 60000
SARASOTA, FL VOR/DME	DOLIE, FL WP	GNSS - 18000 MAA - 60000
DOLIE, FL WP	JAYMC, FL WP	GNSS - 18000 MAA - 60000
JAYMC, FL WP	OCTAL, FL WP	GNSS - 18000 MAA - 60000
OCTAL, FL WP	CANVI, OA WP	GNSS - 18000 MAA - 60000
CANVI, OA WP	PEACH, OA FIX	GNSS - 18000 MAA - 60000
PEACH, OA FIX	SUMAC, OA WP	GNSS - 18000 MAA - 60000
SUMAC, OA WP	RUTO, OA WP	GNSS - 18000 MAA - 60000
RUTO, OA WP	CHASO, OA WP	GNSS - 18000 MAA - 60000

FROM	TO	MEA
<b>Y280 - CONTINUED</b>		
CHASO, OA WP	JSTIN, OA WP	GNSS - 18000 MAA - 60000
JSTIN, OA WP	CHYLE, OA WP	GNSS - 18000 MAA - 60000
CHYLE, OA WP	SAPPO, OA WP	GNSS - 18000 MAA - 60000
SAPPO, OA WP	ACONY, OA WP	GNSS - 18000 MAA - 60000
ACONY, OA WP	GOTAY, PR WP	GNSS - 18000 MAA - 60000
GOTAY, PR WP	STIIV, OA WP	GNSS - 18000 MAA - 60000
STIIV, OA WP	MLIZA, OA WP	GNSS - 18000 MAA - 60000
MLIZA, OA WP	*DANDE, VI FIX	GNSS - 18000 MAA - 60000
*3500 - MRA DANDE, VI FIX	GABAR, VI FIX	GNSS - 18000 MAA - 60000
<b>Y289</b>		
DULEE, OA WP	BAHAA, OA WP	GNSS - 18000 MAA - 45000
BAHAA, OA WP	NRRSE, OA WP	GNSS - 18000 MAA - 60000
NRRSE, OA WP	OGGRE, OA WP	GNSS - 18000 MAA - 60000
OGGRE, OA WP	OSTNN, OA WP	GNSS - 18000 MAA - 60000
OSTNN, OA WP	ZILLS, NC WP	*GNSS - 18000 MAA - 60000
*1300 - MOCA		
<b>Y290</b>		
LEEVILLE, LA VORTAC	BLVNS, OG WP	GNSS - 6000 MAA - 60000
BLVNS, OG WP	BUNNZ, OG WP	GNSS - 6000 MAA - 60000
BUNNZ, OG WP	BACCA, OG WP	GNSS - 6000 MAA - 60000
BACCA, OG WP	CIGAR, OG WP	GNSS - 6000 MAA - 60000
CIGAR, OG WP	GAWKS, OA WP	GNSS - 6000 MAA - 60000
GAWKS, OA WP	BAGGS, OG WP	GNSS - 6000 MAA - 60000
BAGGS, OG WP	THMPR, FL WP	GNSS - 18000 MAA - 60000
THMPR, FL WP	FEMID, FL WP	GNSS - 18000 MAA - 60000
FEMID, FL WP	SAXXN, FL WP	GNSS - 18000 MAA - 60000
SAXXN, FL WP	UCRAZ, OA WP	GNSS - 18000 MAA - 60000
UCRAZ, OA WP	SKIPS, BS FIX	GNSS - 18000 MAA - 60000
SKIPS, BS FIX	BITAC, OA WP	GNSS - 18000 MAA - 60000



FROM	TO	MEA
<b>Y290 - CONTINUED</b>		
BITAC, OA WP	HAGIT, OA WP	GNSS - 18000 MAA - 60000
HAGIT, OA WP	CALTO, OA WP	GNSS - 18000 MAA - 60000
CALTO, OA WP	ZIBER, OA WP	GNSS - 18000 MAA - 60000
ZIBER, OA WP	SAYER, OA WP	GNSS - 18000 MAA - 60000
SAYER, OA WP	BEANO, PR FIX	GNSS - 18000 MAA - 60000
BEANO, PR FIX	JETSS, PR FIX	GNSS - 18000 MAA - 60000
JETSS, PR FIX	SLUGO, VI FIX	GNSS - 18000 MAA - 60000
SLUGO, VI FIX	ELOPO, PR FIX	GNSS - 18000 MAA - 60000
<b>Y291</b>		
MAJIK, OA WP	RAZZL, OA WP	GNSS - 18000 MAA - 60000
RAZZL, OA WP	JRDAN, OA WP	GNSS - 18000 MAA - 60000
JRDAN, OA WP	SAGGY, OA WP	GNSS - 18000 MAA - 60000
SAGGY, OA WP	CHIEZ, NC WP	GNSS - 18000 MAA - 60000
<b>Y292</b>		
MNDEZ, OA WP	FIPEK, OA WP	GNSS - 18000 MAA - 60000
FIPEK, OA WP	PANMO, OA WP	GNSS - 18000 MAA - 60000
<b>Y294</b>		
FIPEK, OA WP	GISSO, PR FIX	GNSS - 18000 MAA - 60000
<b>Y297</b>		
*URSUS, OA FIX	UCRAZ, OA WP	GNSS - 18000 MAA - 45000
*16000 - MRA		
UCRAZ, OA WP	CANVI, OA WP	*GNSS - 18000 MAA - 60000
*1300 - MOCA		
CANVI, OA WP	TOVAR, FL WP	GNSS - 18000 MAA - 60000
<b>Y298</b>		
VENDS, OA WP	WISSET, OA WP	GNSS - 18000 MAA - 60000
WISSET, OA WP	RUMFO, OA WP	GNSS - 18000 MAA - 60000
RUMFO, OA WP	KNSLY, OA WP	GNSS - 18000 MAA - 60000

FROM	TO	MEA
<b>Y298 - CONTINUED</b>		
KNSLY, OA WP	BODLO, OA WP	GNSS - 18000 MAA - 60000
<b>Y299</b>		
GRUBR, OA WP	SNABS, OA WP	GNSS - 18000 MAA - 45000
SNABS, OA WP	SEELO, OA WP	GNSS - 18000 MAA - 60000
<b>Y304</b>		
VENDS, OA WP	RUTO, OA WP	GNSS - 18000 MAA - 60000
RUTO, OA WP	SEKAR, DO FIX	GNSS - 18000 MAA - 60000
<b>Y306</b>		
VENDS, OA WP	CHASO, OA WP	GNSS - 18000 MAA - 45000
CHASO, OA WP	HAGIT, OA WP	GNSS - 18000 MAA - 60000
HAGIT, OA WP	POKEG, IB FIX	GNSS - 18000 MAA - 60000
<b>Y307</b>		
ENAMO, OA FIX	NASSAU, BS VOR/DME	GNSS - 18000 MAA - 45000
NASSAU, BS VOR/DME	HANKX, BS FIX	GNSS - 18000 MAA - 60000
HANKX, BS FIX	NUCAR, BS FIX	GNSS - 18000 MAA - 60000
NUCAR, BS FIX	PAAZZ, OA WP	GNSS - 18000 MAA - 60000
PAAZZ, OA WP	HOVAX, OA WP	GNSS - 18000 MAA - 60000
HOVAX, OA WP	CASPR, OA FIX	GNSS - 18000 MAA - 60000
CASPR, OA FIX	CARPX, OA WP	GNSS - 18000 MAA - 60000
CARPX, OA WP	ADUCI, OA WP	GNSS - 18000 MAA - 60000
ADUCI, OA WP	JAZZI, OA WP	GNSS - 18000 MAA - 60000
<b>Y308</b>		
MADIZ, OA WP	FODED, OA WP	GNSS - 18000 MAA - 60000
FODED, OA WP	HAGIT, OA WP	GNSS - 18000 MAA - 60000
HAGIT, OA WP	ANTOX, OA WP	GNSS - 18000 MAA - 60000
ANTOX, OA WP	FEKKO, OA WP	GNSS - 18000 MAA - 60000
FEKKO, OA WP	ACONY, OA WP	GNSS - 18000 MAA - 60000

FROM	TO	MEA
<b>Y309</b>		
PELCN, OA WP	OZENA, OA WP	GNSS - 18000 MAA - 45000
OZENA, OA WP	ROWSY, OA WP	GNSS - 18000 MAA - 60000
ROWSY, OA WP	FLRDA, OA WP	GNSS - 18000 MAA - 60000
<b>Y313</b>		
HOAGG, OA WP	DUUNK, OA WP	GNSS - 18000 MAA - 60000
DUUNK, OA WP	SPOOF, OA WP	GNSS - 18000 MAA - 60000
SPOOF, OA WP	IDOLS, OA WP	GNSS - 18000 MAA - 60000
IDOLS, OA WP	SKARP, NC WP	GNSS - 18000 MAA - 60000
<b>Y315</b>		
CHUMA, OA WP	DOZGO, OA WP	GNSS - 6000 MAA - 45000
DOZGO, OA WP	GEROA, OA WP	GNSS - 6000 MAA - 45000
GEROA, OA WP	KEEKA, OA WP	GNSS - 6000 MAA - 60000
<b>Y318</b>		
RODRK, OA WP	DONQU, OA WP	GNSS - 18000 MAA - 60000
DONQU, OA WP	WEXET, PR WP	GNSS - 18000 MAA - 60000
WEXET, PR WP	LARPP, VI FIX	GNSS - 18000 MAA - 60000
LARPP, VI FIX	ELOPO, PR FIX	GNSS - 18000 MAA - 60000
<b>Y319</b>		
*URSUS, OA FIX	FREEPORT, BS VOR/DME	**GNSS - 18000 MAA - 45000
*16000 - MRA		
**1400 - MOCA		
FREEPORT, BS VOR/DME	BRATZ, OA WP	*GNSS - 18000 MAA - 60000
*1400 - MOCA		
BRATZ, OA WP	OHLAA, OA WP	GNSS - 18000 MAA - 60000
OHLAA, OA WP	COACH, OA WP	GNSS - 18000 MAA - 60000
COACH, OA WP	TYCAL, OA WP	GNSS - 18000 MAA - 60000
TYCAL, OA WP	JAZZI, OA WP	GNSS - 18000 MAA - 60000
<b>Y323</b>		
CARPX, OA WP	WEAKK, OA WP	GNSS - 18000 MAA - 45000

FROM	TO	MEA
<b>Y323 - CONTINUED</b>		
WEAKK, OA WP	RROOO, OA WP	GNSS - 18000 MAA - 60000
<b>Y327</b>		
JAINS, OA WP	CLOWR, OA WP	GNSS - 18000 MAA - 60000
CLOWR, OA WP	PRTHR, OA WP	GNSS - 18000 MAA - 60000
PRTHR, OA WP	IDOLS, OA WP	GNSS - 18000 MAA - 60000
IDOLS, OA WP	SKARP, NC WP	GNSS - 18000 MAA - 60000
<b>Y329</b>		
ZEUSS, OA FIX	FREEPORT, BS VOR/DME	GNSS - 18000 MAA - 60000
<b>Y330</b>		
FODED, OA WP	PURPE, OA WP	GNSS - 18000 MAA - 60000
PURPE, OA WP	HARBG, OA FIX	GNSS - 18000 MAA - 60000
<b>Y350</b>		
NASSAU, BS VOR/DME	CILEX, OA WP	GNSS - 18000 MAA - 60000
CILEX, OA WP	KNSLY, OA WP	GNSS - 18000 MAA - 60000
<b>Y352</b>		
NASSAU, BS VOR/DME	HAGIT, OA WP	GNSS - 18000 MAA - 60000
<b>Y353</b>		
ALBBE, BS FIX	KNSLY, OA WP	GNSS - 18000 MAA - 60000
KNSLY, OA WP	SUMAC, OA WP	GNSS - 18000 MAA - 60000
SUMAC, OA WP	UPOKE, OA WP	GNSS - 18000 MAA - 60000
UPOKE, OA WP	BAHMA, BS FIX	GNSS - 18000 MAA - 60000
<b>Y354</b>		
DONQU, OA WP	GESSO, PR FIX	GNSS - 18000 MAA - 60000
<b>Y355</b>		
ELOPO, PR FIX	SLUGO, VI FIX	GNSS - 6000 MAA - 60000

FROM	TO	MEA
<b>Y355 - CONTINUED</b>		
SLUGO, VI FIX	KOLAO, OA WP	GNSS - 6000 MAA - 60000
KOLAO, OA WP	PLING, PR FIX	GNSS - 6000 MAA - 60000
PLING, PR FIX	PUYYA, OA WP	GNSS - 6000 MAA - 60000
PUYYA, OA WP	FIPEK, OA WP	GNSS - 6000 MAA - 60000
FIPEK, OA WP	DETRE, OA WP	GNSS - 18000 MAA - 60000
DETRE, OA WP	WAROD, OA WP	GNSS - 18000 MAA - 60000
WAROD, OA WP	CAROX, OA WP	GNSS - 18000 MAA - 60000
CAROX, OA WP	HELAX, OA WP	GNSS - 18000 MAA - 60000
HELAX, OA WP	FOSAS, OA WP	GNSS - 18000 MAA - 60000
FOSAS, OA WP	RENAH, OA WP	GNSS - 18000 MAA - 60000
RENAH, OA WP	OMALY, OA FIX	GNSS - 18000 MAA - 60000
OMALY, OA FIX	NUCAR, BS FIX	GNSS - 18000 MAA - 60000

**Y356**

IORIO, OA WP	CERDA, OA WP	GNSS - 18000 MAA - 60000
CERDA, OA WP	DONQU, OA WP	GNSS - 18000 MAA - 60000
DONQU, OA WP	MEEGL, PR WP	GNSS - 18000 MAA - 60000

**Y374**

NUCAR, BS FIX	WEDER, BS WP	GNSS - 18000 MAA - 60000
WEDER, BS WP	RUMFO, OA WP	GNSS - 18000 MAA - 60000
RUMFO, OA WP	ALBBE, BS FIX	GNSS - 18000 MAA - 60000

**Y396**

BITAC, OA WP	RUMFO, OA WP	GNSS - 18000 MAA - 60000
RUMFO, OA WP	MALVN, OA FIX	GNSS - 18000 MAA - 60000

**Y397**

SEKAR, DO FIX	RENAH, OA WP	GNSS - 18000 MAA - 60000
---------------	--------------	-----------------------------

**Y398**

SAXXN, FL WP	UCRAZ, OA WP	GNSS - 18000 MAA - 60000
--------------	--------------	-----------------------------

FROM	TO	MEA
<b>Y398 - CONTINUED</b>		
UCRAZ, OA WP	SKIPS, BS FIX	GNSS - 18000 MAA - 60000
SKIPS, BS FIX	JAGOR, OA WP	*GNSS - 18000 MAA - 60000
*1300 - MOCA JAGOR, OA WP	KNSLY, OA WP	*GNSS - 18000 MAA - 60000
*2200 - MOCA KNSLY, OA WP	JOSES, OA WP	GNSS - 18000 MAA - 60000
<b>Y399</b>		
SAPPO, OA WP	CADGE, OA WP	GNSS - 18000 MAA - 45000
CADGE, OA WP	NASSAU, BS VOR/DME	*GNSS - 18000 MAA - 60000
*1500 - MOCA		
<b>Y421</b>		
MEEGL, PR WP	HARBG, OA FIX	GNSS - 18000 MAA - 60000
HARBG, OA FIX	HAGIT, OA WP	GNSS - 18000 MAA - 60000
HAGIT, OA WP	WISET, OA WP	GNSS - 18000 MAA - 60000
WISET, OA WP	SUMAC, OA WP	GNSS - 18000 MAA - 60000
SUMAC, OA WP	PEACH, OA FIX	GNSS - 18000 MAA - 60000
PEACH, OA FIX	KOUGH, OA WP	GNSS - 18000 MAA - 60000
KOUGH, OA WP	CANVI, OA WP	GNSS - 18000 MAA - 60000
CANVI, OA WP	OCTAL, FL WP	GNSS - 18000 MAA - 60000
<b>Y436</b>		
DEDDY, SC WP	PITRW, SC WP	GNSS - 18000 MAA - 60000
PITRW, SC WP	SNNTA, SC WP	GNSS - 18000 MAA - 60000
SNNTA, SC WP	OGGRE, OA WP	GNSS - 18000 MAA - 60000
OGGRE, OA WP	EBEAR, OA WP	GNSS - 18000 MAA - 60000
EBEAR, OA WP	DIZNY, OA WP	GNSS - 18000 MAA - 60000
DIZNY, OA WP	RROOO, OA WP	GNSS - 18000 MAA - 60000
RROOO, OA WP	HARON, OA WP	GNSS - 18000 MAA - 60000
HARON, OA WP	JAINS, OA WP	GNSS - 18000 MAA - 60000
<b>Y438</b>		
KOOKK, FL WP	FEMON, FL WP	GNSS - 18000 MAA - 60000

FROM	TO	MEA
<b>Y438 - CONTINUED</b>		
FEMON, FL WP	JAWSS, FL FIX	GNSS - 18000 MAA - 60000
JAWSS, FL FIX	BAHAA, OA WP	GNSS - 18000 MAA - 60000
BAHAA, OA WP	SNABS, OA WP	GNSS - 18000 MAA - 60000
SNABS, OA WP	OZENA, OA WP	GNSS - 18000 MAA - 60000
OZENA, OA WP	OHLAA, OA WP	GNSS - 18000 MAA - 60000
OHLAA, OA WP	CARPX, OA WP	GNSS - 18000 MAA - 60000
CARPX, OA WP	TROUT, FL WP	GNSS - 18000 MAA - 60000
<b>Y439</b>		
ARMUR, PR WP	MEEGL, PR WP	GNSS - 18000 MAA - 60000
MEEGL, PR WP	SAYER, OA WP	GNSS - 18000 MAA - 60000
SAYER, OA WP	FIPEK, OA WP	GNSS - 18000 MAA - 60000
FIPEK, OA WP	CERDA, OA WP	GNSS - 18000 MAA - 60000
CERDA, OA WP	SLUKA, OA WP	GNSS - 18000 MAA - 60000
<b>Y441</b>		
JUELE, OA FIX	RUMFO, OA WP	GNSS - 18000 MAA - 60000
RUMFO, OA WP	NASSAU, BS VOR/DME	GNSS - 18000 MAA - 60000
<b>Y442</b>		
FUNDI, OA WP	MCLAW, FL WP	6000 MAA - 45000
MCLAW, FL WP	TAZER, FL WP	6000 MAA - 45000
TAZER, FL WP	MNATE, FL FIX	6000 MAA - 45000
<b>Y443</b>		
RUMFO, OA WP	SUMAC, OA WP	GNSS - 18000 MAA - 60000
SUMAC, OA WP	UPOKE, OA WP	GNSS - 18000 MAA - 60000
UPOKE, OA WP	BAHMA, BS FIX	GNSS - 18000 MAA - 60000
<b>Y481</b>		
KINGG, OA WP	OHRYN, OA WP	GNSS - 17000 MAA - 60000
OHRYN, OA WP	POPPN, OA WP	GNSS - 17000 MAA - 60000

FROM	TO	MEA
<b>Y481 - CONTINUED</b>		
POPPN, OA WP	OWENZ, OA FIX	GNSS - 17000
		MAA - 60000
OWENZ, OA FIX	DIXIE, NJ FIX	GNSS - 6000
		MAA - 60000
<b>Y482</b>		
DIXIE, NJ FIX	OWENZ, OA FIX	GNSS - 6000
		MAA - 60000
OWENZ, OA FIX	POPPN, OA WP	GNSS - 17000
		MAA - 60000
POPPN, OA WP	OHRYN, OA WP	GNSS - 17000
		MAA - 60000
OHRYN, OA WP	SQUAD, OA WP	GNSS - 17000
		MAA - 60000
<b>Y483</b>		
MARIG, OA WP	ISLES, OA WP	GNSS - 18000
		MAA - 60000
ISLES, OA WP	DUMPR, OA WP	GNSS - 18000
		MAA - 60000
DUMPR, OA WP	BLUUU, OA WP	GNSS - 18000
		MAA - 60000
BLUUU, OA WP	DOGRS, OA WP	GNSS - 18000
		MAA - 60000
DOGRS, OA WP	FATON, OA WP	GNSS - 18000
		MAA - 60000
FATON, OA WP	SHERL, NY FIX	GNSS - 18000
		MAA - 60000
SHERL, NY FIX	SHIPP, OA FIX	GNSS - 18000
		MAA - 60000
SHIPP, OA FIX	KENNEDY, NY VOR/DME	GNSS - 18000
		MAA - 60000
<b>Y484</b>		
KENNEDY, NY VOR/DME	CREEL, NY FIX	GNSS - 18000
		MAA - 60000
CREEL, NY FIX	BOUNO, NY FIX	GNSS - 18000
		MAA - 60000
BOUNO, NY FIX	GEDIC, NJ FIX	GNSS - 18000
		MAA - 60000
GEDIC, NJ FIX	OWENZ, OA FIX	GNSS - 18000
		MAA - 60000
OWENZ, OA FIX	MOUGH, OA WP	GNSS - 18000
		MAA - 60000
MOUGH, OA WP	YETTI, OA WP	GNSS - 18000
		MAA - 60000
YETTI, OA WP	YAALE, OA WP	GNSS - 18000
		MAA - 60000
YAALE, OA WP	WEBBB, OA WP	GNSS - 18000
		MAA - 60000
WEBBB, OA WP	OKONU, OA WP	GNSS - 18000
		MAA - 60000
<b>Y485</b>		
SAUCR, OA WP	STERN, OA WP	GNSS - 31000
		MAA - 60000



FROM	TO	MEA
<b>Y485 - CONTINUED</b>		
STERN, OA WP	CHUBY, OA WP	GNSS - 31000 MAA - 60000
CHUBY, OA WP	HOBOH, OA WP	GNSS - 31000 MAA - 60000
HOBOH, OA WP	SILLY, OA WP	GNSS - 31000 MAA - 60000
SILLY, OA WP	STINK, OA WP	GNSS - 17000 MAA - 60000
STINK, OA WP	YAALE, OA WP	GNSS - 17000 MAA - 60000
<b>Y486</b>		
KENNEDY, NY VOR/DME	CREEL, NY FIX	GNSS - 18000 MAA - 60000
CREEL, NY FIX	BOUNO, NY FIX	GNSS - 18000 MAA - 60000
BOUNO, NY FIX	GEDIC, NJ FIX	GNSS - 18000 MAA - 60000
GEDIC, NJ FIX	OWENZ, OA FIX	GNSS - 18000 MAA - 60000
OWENZ, OA FIX	MOUGH, OA WP	GNSS - 18000 MAA - 60000
MOUGH, OA WP	SAVIK, OA WP	GNSS - 18000 MAA - 60000
<b>Y487</b>		
KINGG, OA WP	ISLES, OA WP	GNSS - 17000 MAA - 60000
ISLES, OA WP	DUMPR, OA WP	GNSS - 17000 MAA - 60000
DUMPR, OA WP	BLUUU, OA WP	GNSS - 17000 MAA - 60000
BLUUU, OA WP	DOGRS, OA WP	GNSS - 11000 MAA - 60000
DOGRS, OA WP	SPDEY, OA WP	GNSS - 6000 MAA - 60000
SPDEY, OA WP	SHIPP, OA FIX	GNSS - 6000 MAA - 60000
<b>Y488</b>		
SHIPP, OA FIX	SPDEY, OA WP	GNSS - 6000 MAA - 60000
SPDEY, OA WP	DOGRS, OA WP	GNSS - 6000 MAA - 60000
DOGRS, OA WP	BLUUU, OA WP	GNSS - 11000 MAA - 60000
BLUUU, OA WP	DUMPR, OA WP	GNSS - 17000 MAA - 60000
DUMPR, OA WP	ICCEY, OA WP	GNSS - 17000 MAA - 60000
ICCEY, OA WP	OHRYN, OA WP	GNSS - 17000 MAA - 60000
OHRYN, OA WP	BEHR, OA WP	GNSS - 17000 MAA - 60000
BEHR, OA WP	WEBBB, OA WP	GNSS - 17000 MAA - 60000

FROM	TO	MEA
------	----	-----

**Y488 - CONTINUED**

WEBBB, OA WP	HOBOH, OA WP	GNSS - 31000 MAA - 60000
HOBOH, OA WP	CHUBY, OA WP	GNSS - 31000 MAA - 60000
CHUBY, OA WP	STERN, OA WP	GNSS - 31000 MAA - 60000
STERN, OA WP	SAUCR, OA WP	GNSS - 31000 MAA - 60000

**Y489**

RESQU, OA WP	BEHR, OA WP	GNSS - 17000 MAA - 60000
BEHR, OA WP	OHRYN, OA WP	GNSS - 17000 MAA - 60000
OHRYN, OA WP	ICCEY, OA WP	GNSS - 17000 MAA - 60000
ICCEY, OA WP	DUMPR, OA WP	GNSS - 17000 MAA - 60000
DUMPR, OA WP	BLUUU, OA WP	GNSS - 17000 MAA - 60000
BLUUU, OA WP	DOGRS, OA WP	GNSS - 11000 MAA - 60000
DOGRS, OA WP	SPDEY, OA WP	GNSS - 6000 MAA - 60000
SPDEY, OA WP	SHIPP, OA FIX	GNSS - 6000 MAA - 60000

**Y490**

SHIPP, OA FIX	SPDEY, OA WP	GNSS - 6000 MAA - 60000
SPDEY, OA WP	DOGRS, OA WP	GNSS - 6000 MAA - 60000
DOGRS, OA WP	BLUUU, OA WP	GNSS - 11000 MAA - 60000
BLUUU, OA WP	DUMPR, OA WP	GNSS - 17000 MAA - 60000
DUMPR, OA WP	ICCEY, OA WP	GNSS - 17000 MAA - 60000
ICCEY, OA WP	OHRYN, OA WP	GNSS - 17000 MAA - 60000
OHRYN, OA WP	BEHR, OA WP	GNSS - 17000 MAA - 60000
BEHR, OA WP	ROLLE, OA WP	GNSS - 17000 MAA - 60000

**Y492**

SHIPP, OA FIX	SPDEY, OA WP	GNSS - 6000 MAA - 60000
SPDEY, OA WP	DOGRS, OA WP	GNSS - 6000 MAA - 60000
DOGRS, OA WP	BLUUU, OA WP	GNSS - 11000 MAA - 60000
BLUUU, OA WP	DUMPR, OA WP	GNSS - 17000 MAA - 60000
DUMPR, OA WP	ISLES, OA WP	GNSS - 17000 MAA - 60000

FROM	TO	MEA
<b>Y492 - CONTINUED</b>		
ISLES, OA WP	SQUAD, OA WP	GNSS - 17000 MAA - 60000
<b>Y493</b>		
BAHAA, OA WP	JENKS, OA WP	GNSS - 24000 MAA - 60000
JENKS, OA WP	AYCHB, OA WP	GNSS - 24000 MAA - 60000
AYCHB, OA WP	ROWSY, OA WP	GNSS - 24000 MAA - 60000
ROWSY, OA WP	COACH, OA WP	GNSS - 24000 MAA - 60000
COACH, OA WP	WEAKK, OA WP	GNSS - 24000 MAA - 60000
WEAKK, OA WP	TUBBS, OA WP	GNSS - 24000 MAA - 60000
TUBBS, OA WP	ROBBB, OA WP	GNSS - 31000 MAA - 60000
ROBBB, OA WP	STERN, OA WP	GNSS - 31000 MAA - 60000
STERN, OA WP	VEGAA, OA WP	GNSS - 31000 MAA - 60000
<b>Y494</b>		
AYCHB, OA WP	ROWSY, OA WP	GNSS - 24000 MAA - 60000
ROWSY, OA WP	COACH, OA WP	GNSS - 24000 MAA - 60000
COACH, OA WP	WEAKK, OA WP	GNSS - 24000 MAA - 60000
WEAKK, OA WP	HARON, OA WP	GNSS - 24000 MAA - 60000
HARON, OA WP	WHOOS, OA WP	GNSS - 24000 MAA - 60000
WHOOS, OA WP	OOONN, OA WP	GNSS - 31000 MAA - 60000
OOONN, OA WP	VIRST, OA WP	GNSS - 31000 MAA - 60000
VIRST, OA WP	HOBOH, OA WP	GNSS - 31000 MAA - 60000
HOBOH, OA WP	SILLY, OA WP	GNSS - 31000 MAA - 60000
SILLY, OA WP	STINK, OA WP	GNSS - 17000 MAA - 60000
STINK, OA WP	YAALE, OA WP	GNSS - 17000 MAA - 60000
<b>Y495</b>		
YAALE, OA WP	YETTI, OA WP	GNSS - 17000 MAA - 60000
YETTI, OA WP	MOUGH, OA WP	GNSS - 17000 MAA - 60000
MOUGH, OA WP	OWENZ, OA FIX	GNSS - 17000 MAA - 60000
OWENZ, OA FIX	*PREPI, OA FIX	GNSS - 6000 MAA - 60000

\*8000 - MRA

FROM	TO	MEA
<b>Y495 - CONTINUED</b>		
PREPI, OA FIX	LEECY, NJ WP	GNSS - 6000
		MAA - 60000
LEECY, NJ WP	CAMRN, NJ FIX	GNSS - 6000
		MAA - 60000
<b>Y497</b>		
YAALE, OA WP	YETTI, OA WP	GNSS - 17000
		MAA - 60000
YETTI, OA WP	MOUGH, OA WP	GNSS - 17000
		MAA - 60000
MOUGH, OA WP	OWENZ, OA FIX	GNSS - 17000
		MAA - 60000
OWENZ, OA FIX	*DRIFT, NJ FIX	GNSS - 6000
		MAA - 60000
*6000 - MRA		
DRIFT, NJ FIX	SUBBS, NJ WP	GNSS - 6000
		MAA - 60000
<b>Y578</b>		
BRUWN, MA FIX	BORQE, OA WP	GNSS - 17000
		MAA - 60000
BORQE, OA WP	JENYY, OA WP	GNSS - 17000
		MAA - 60000
JENYY, OA WP	KAYYT, OA WP	GNSS - 17000
		MAA - 60000
<b>Y585</b>		
ORMOND BEACH, FL VORTAC	ATTIK, OA WP	18000
		MAA - 60000
ATTIK, OA WP	BEERD, OA WP	18000
		MAA - 60000
BEERD, OA WP	CVIKK, BS WP	18000
		MAA - 60000
CVIKK, BS WP	NATHY, OA WP	18000
		MAA - 60000
NATHY, OA WP	DAAST, BS WP	18000
		MAA - 60000
DAAST, BS WP	WITOB, OA WP	18000
		MAA - 60000
WITOB, OA WP	RENAH, OA WP	18000
		MAA - 60000
RENAH, OA WP	COUKY, OA FIX	18000
		MAA - 60000
COUKY, OA FIX	NELSR, OA WP	18000
		MAA - 60000
NELSR, OA WP	EYSEL, OA WP	18000
		MAA - 60000
EYSEL, OA WP	FARMN, OA WP	18000
		MAA - 60000
FARMN, OA WP	FDLEE, OA WP	18000
		MAA - 60000
FDLEE, OA WP	ELMUC, OA WP	18000
		MAA - 60000
ELMUC, OA WP	TILDI, PR WP	18000
		MAA - 60000
TILDI, PR WP	UTAHS, PR FIX	18000
		MAA - 60000

FROM	TO	MEA
<b>Y585 - CONTINUED</b>		
UTAHS, PR FIX	VEDAS, PR FIX	18000 MAA - 60000
<b>Y586</b>		
MADIZ, OA WP	BELAC, OA WP	GNSS - 18000 MAA - 60000
BELAC, OA WP	FORST, BS WP	GNSS - 18000 MAA - 60000
FORST, BS WP	JOSES, OA WP	GNSS - 18000 MAA - 60000
<b>Y587</b>		
SKIPS, BS FIX	RAJAY, BS FIX	18000 MAA - 60000
RAJAY, BS FIX	COZIE, OA WP	18000 MAA - 60000
COZIE, OA WP	DONEZ, OA FIX	18000 MAA - 60000
DONEZ, OA FIX	PAARR, OA WP	18000 MAA - 60000
PAARR, OA WP	RNDLY, OA WP	18000 MAA - 60000
RNDLY, OA WP	GRAND TURK, TC VORTAC	18000 MAA - 60000
GRAND TURK, TC VORTAC	COCBU, IB FIX	18000 MAA - 60000
COCBU, IB FIX	SEBUG, OA FIX	18000 MAA - 60000
SEBUG, OA FIX	GRADI, OA FIX	18000 MAA - 60000
GRADI, OA FIX	HARDE, PR FIX	18000 MAA - 60000
HARDE, PR FIX	GAGDD, OA WP	18000 MAA - 60000
GAGDD, OA WP	ROBLL, PR FIX	18000 MAA - 60000
<b>Y588</b>		
BROOM, OA WP	ROTHM, OA WP	18000 MAA - 60000
ROTHM, OA WP	CLETT, OA WP	18000 MAA - 60000
CLETT, OA WP	MLSAP, OA FIX	18000 MAA - 60000
MLSAP, OA FIX	RENAH, OA WP	18000 MAA - 60000
<b>Y589</b>		
ALBBE, BS FIX	MADIZ, OA WP	GNSS - 18000 MAA - 60000

FROM

TO

MEA

**PACIFIC ROUTES****A216**

MONPI, OP WP	OATSS, OP WP	18000 MAA - 60000
OATSS, OP WP	RIDLL, OP WP	18000 MAA - 60000
RIDLL, OP WP	LOEBB, OP WP	18000 MAA - 60000
LOEBB, OP WP	HOOVR, OP WP	18000 MAA - 60000
HOOVR, OP WP	GALEE, OP WP	18000 MAA - 60000
GALEE, OP WP	FACED, OP WP	18000 MAA - 60000

**A220**

MAEVA, OP WP	CRONN, OP WP	5500
CRONN, OP WP	BINGE, OP WP	5500
BINGE, OP WP	AHND0, OP WP	5500
AHND0, OP WP	MANEY, OP WP	5500 MAA - 60000
MANEY, OP WP	MAFIC, OP WP	5500 MAA - 60000
MAFIC, OP WP	CINNY, OP WP	5500 MAA - 60000

**A221**

CULPS, MP FIX	ERTTS, GU FIX	1500 MAA - 60000
ERTTS, GU FIX	MONIE, MP FIX	1500 MAA - 60000
MONIE, MP FIX	LULJY, GU FIX	6000 MAA - 60000
LULJY, GU FIX	HEXUG, OP FIX	6000 MAA - 60000
HEXUG, OP FIX	WILLE, GU FIX	6000 MAA - 60000

**A222**

NIMITZ, GU VORTAC	CLANS, OP WP	20000 MAA - 60000
CLANS, OP WP	AXIDE, OP WP	20000 MAA - 60000
AXIDE, OP WP	FIBSS, OP WP	20000 MAA - 60000
FIBSS, OP WP	KRONK, OP WP	20000 MAA - 60000
KRONK, OP WP	ADUFO, FM FIX	20000 MAA - 60000
ADUFO, FM FIX	POHNPEI, FM NDB/DME	20000 MAA - 60000
POHNPEI, FM NDB/DME	AXTEN, FM WP	20000 MAA - 60000

FROM	TO	MEA
<b>A222 - CONTINUED</b>		
AXTEN, FM WP	KOSRAE, FM NDB/DME	20000
		MAA - 60000
KOSRAE, FM NDB/DME	STEFF, OP WP	20000
		MAA - 60000
STEFF, OP WP	BUCHOLZ, MH NDB	18000
		MAA - 60000
<b>A331</b>		
ZIGIE, OP FIX	ZOULU, OP WP	5500
		MAA - 60000
ZOULU, OP WP	ZEMOM, OP WP	5500
		MAA - 60000
ZEMOM, OP WP	ZINNO, OP WP	5500
		MAA - 60000
ZINNO, OP WP	ZAGER, OP WP	5500
		MAA - 60000
ZAGER, OP WP	ZANNG, OP WP	5500
		MAA - 60000
ZANNG, OP WP	SEDAR, OP WP	5500
		MAA - 60000
<b>A332</b>		
AUNTI, OP WP	HALLI, OP WP	5500
		MAA - 60000
HALLI, OP WP	HELOP, OP WP	5500
		MAA - 60000
HELOP, OP WP	HEKAB, OP WP	5500
		MAA - 60000
HEKAB, OP WP	HEMLO, OP WP	5500
		MAA - 60000
<b>A337</b>		
JUNIE, GU FIX	AXIDE, OP WP	6000
		MAA - 60000
AXIDE, OP WP	FONUG, OP WP	6000
		MAA - 60000
FONUG, OP WP	SNAPP, GU FIX	6000
		MAA - 60000
SNAPP, GU FIX	TEEDE, OP WP	6000
		MAA - 60000
TEEDE, OP WP	TEGOD, OP WP	6000
		MAA - 60000
<b>A339</b>		
SHREE, OP WP	WRNNR, OP WP	15000
		MAA - 60000
WRNNR, OP WP	TILLY, OP WP	15000
		MAA - 60000
TILLY, OP WP	KEITH, OP WP	15000
		MAA - 60000
<b>A342</b>		
NUZAN, OP WP	OPAKE, OP WP	18000
		MAA - 60000

FROM	TO	MEA
<b>A342 - CONTINUED</b>		
OPAKE, OP WP	PINSO, OP WP	18000
		MAA - 60000
PINSO, OP WP	AMOND, AK FIX	18000
		MAA - 60000
AMOND, AK FIX	DRAPP, AK FIX	18000
		MAA - 60000
DRAPP, AK FIX	CRYPT, AK FIX	18000
		MAA - 60000
CRYPT, AK FIX	COLD BAY, AK VORTAC	18000
		MAA - 60000
<b>A450</b>		
CAHYO, OP WP	TNUGE, OP WP	18000
TNUGE, OP WP	PIGFA, OP WP	18000
PIGFA, OP WP	LOEBB, OP WP	8000
LOEBB, OP WP	BUCAT, OP WP	8000
BUCAT, OP WP	NIMITZ, GU VORTAC	8000
NIMITZ, GU VORTAC	BAGBE, GU FIX	5000
BAGBE, GU FIX	HOPPY, GU FIX	5000
HOPPY, GU FIX	FONUG, OP WP	5000
		MAA - 60000
FONUG, OP WP	STINE, GU FIX	5000
		MAA - 60000
STINE, GU FIX	DEWSS, OP WP	18000
		MAA - 60000
DEWSS, OP WP	JIMOS, OP WP	5500
		MAA - 60000
JIMOS, OP WP	NGUEN, OP WP	5500
		MAA - 60000
NGUEN, OP WP	NATIE, OP WP	5500
		MAA - 60000
NATIE, OP WP	RESEE, OP WP	5500
		MAA - 60000
RESEE, OP WP	SYSTA, OP WP	5500
		MAA - 60000
SYSTA, OP WP	BRIUN, OP WP	5500
		MAA - 60000
BRIUN, OP WP	HOOPA, OP WP	5500
		MAA - 60000
HOOPA, OP WP	KATHS, HI FIX	5500
		MAA - 60000
<b>A578</b>		
POHNPEI, FM NDB/DME	AFOYU, FM WP	18000
		MAA - 60000
AFOYU, FM WP	FENSE, OP WP	18000
		MAA - 60000
<b>A590</b>		
PASRO, OP WP	POWAL, OP WP	18000
		MAA - 60000
POWAL, OP WP	PLADO, OP WP	18000
		MAA - 60000
PLADO, OP WP	PINSO, OP WP	18000
		MAA - 60000
PINSO, OP WP	POOFF, OP WP	18000
		MAA - 60000



FROM	TO	MEA
<b>A590 - CONTINUED</b>		
POOFF, OP WP	PINTT, OP WP	18000
		MAA - 60000
PINTT, OP WP	PTZGR, OP WP	18000
		MAA - 60000
PTZGR, OP WP	PUGGY, OP WP	18000
		MAA - 60000
PUGGY, OP WP	POETT, OP WP	18000
		MAA - 60000
POETT, OP WP	SELDM, OP WP	18000
		MAA - 60000
SELDM, OP WP	PORGE, AK WP	18000
		MAA - 60000
PORGE, AK WP	HAMND, AK WP	18000
		MAA - 60000
<b>A597</b>		
ADBON, OP WP	OKOLE, OP WP	18000
OKOLE, OP WP	GALSS, OP WP	18000
GALSS, OP WP	JUNIE, GU FIX	18000
JUNIE, GU FIX	OPLAR, GU FIX	5000
OPLAR, GU FIX	GUMGE, GU FIX	5000
GUMGE, GU FIX	NIMITZ, GU VORTAC	5000
NIMITZ, GU VORTAC	WUVEN, GU FIX	5000
WUVEN, GU FIX	REEDE, OP WP	5000
REEDE, OP WP	RICHH, OP WP	5000
RICHH, OP WP	MONPI, OP WP	5000
<b>A598</b>		
MARTI, OP WP	MAJURO, MH NDB/DME	2300
<b>B96</b>		
LARSA, RU WP	GAMBELL, AK NDB/DME	5000
		MAA - 18000
<b>B200</b>		
BISOX, OP WP	ANJJE, OP WP	5500
ANJJE, OP WP	CARLS, OP WP	5500
CARLS, OP WP	BENTS, OP WP	5500
BENTS, OP WP	AMATT, OP WP	5500
AMATT, OP WP	TONYS, OP WP	5500
TONYS, OP WP	FICKY, OP WP	5500
<b>B233</b>		
GALENA, AK VOR/DME	SANGL, AK WP	18000
		MAA - 45000
SANGL, AK WP	KUTAL, RU WP	18000
		MAA - 45000
<b>B240</b>		
ERNIK, RU WP	IDROD, AK WP	18000
		MAA - 45000
IDROD, AK WP	AVUBA, AK WP	18000
		MAA - 45000

FROM	TO	MEA
<b>B240 - CONTINUED</b>		
AVUBA, AK WP	EMMONAK, AK VOR/DME	18000 MAA - 45000
<b>B241</b>		
EMMONAK, AK VOR/DME	ENEGU, AK WP	18000 MAA - 45000
ENEGU, AK WP	ROCET, AK WP	18000 MAA - 45000
ROCET, AK WP	RUSOR, RU WP	18000 MAA - 45000
<b>B244</b>		
FRENK, OP WP	KOTZEBUE, AK VOR/DME	5000 MAA - 40000
<b>B452</b>		
ATIGO, OP WP	KERRY, OP WP	6000
KERRY, OP WP	KRONK, OP WP	6000
KRONK, OP WP	KRASZ, OP WP	6000
KRASZ, OP WP	DOHRT, OP WP	6000
<b>B453</b>		
BOXER, OP WP	KYLLE, OP WP	18000
KYLLE, OP WP	KANUA, OP WP	18000
KANUA, OP WP	VIDKU, CA FIX	18000
VIDKU, CA FIX	TAMRU, CA FIX	18000
TAMRU, CA FIX	SIMLU, CA FIX	18000
SIMLU, CA FIX	KURTT, OP WP	18000
KURTT, OP WP	PETPA, CA FIX	18000
PETPA, CA FIX	NAKBI, CA FIX	18000
NAKBI, CA FIX	METPA, CA FIX	18000
METPA, CA FIX	KATCH, AK FIX	18000
KATCH, AK FIX	MIDDLETON ISLAND, AK VOR/DME	18000
<b>B454</b>		
UPNAR, OP WP	COMIR, OP WP	5500
COMIR, OP WP	BORIC, OP WP	5500
BORIC, OP WP	ARENS, OP WP	5500
ARENS, OP WP	TONYS, OP WP	5500
<b>B577</b>		
PASSA, OP WP	QUIGG, OP WP	5500
QUIGG, OP WP	SANTA, OP WP	5500
SANTA, OP WP	CANOL, OP WP	5500
CANOL, OP WP	BELAN, OP WP	5500
BELAN, OP WP	AHNDQ, OP WP	5500
AHNDQ, OP WP	LENNQ, OP WP	5500
LENNQ, OP WP	FICKY, OP WP	5500
<b>B581</b>		
WOOPY, OP WP	WACOS, OP WP	5500

FROM	TO	MEA
<b>B581 - CONTINUED</b>		
WACOS, OP WP	WOSLU, OP WP	5500
WOSLU, OP WP	WAYSE, OP WP	5500
WAYSE, OP WP	WINTY, OP WP	5500
WINTY, OP WP	CAMOS, OP WP	5500
CAMOS, OP WP	BALKS, OP WP	5500
BALKS, OP WP	AFONE, OP WP	5500
AFONE, OP WP	WEDES, OP WP	5500
WEDES, OP WP	FICKY, OP WP	5500
<b>B586</b>		
OMLET, OP WP	TOESS, OP WP	18000
TOESS, OP WP	WINZR, OP WP	18000
WINZR, OP WP	NIMITZ, GU VORTAC	18000
NIMITZ, GU VORTAC	ASADE, GU FIX	5000
ASADE, GU FIX	KAPOK, GU FIX	5000
KAPOK, GU FIX	HUTEL, OP WP	18000
HUTEL, OP WP	NUTTI, OP WP	18000
NUTTI, OP WP	PIKOK, OP WP	18000
<b>B589</b>		
MAJURO, MH NDB/DME	ELNUR, OP WP	18000
<b>B932</b>		
BAMOK, OP WP	MORLY, AK WP	18000 MAA - 45000
MORLY, AK WP	EPLOS, AK WP	18000 MAA - 45000
EPLOS, AK WP	KIVAK, AK WP	18000 MAA - 45000
KIVAK, AK WP	LESAD, AK WP	18000 MAA - 45000
LESAD, AK WP	ST MARYS, AK NDB	18000 MAA - 45000
ST MARYS, AK NDB	MC GRATH, AK VORTAC	18000 MAA - 45000
<b>G7</b>		
OLTON, RU WP	GAMBELL, AK NDB/DME	5000 MAA - 18000
<b>G205</b>		
RUTUS, OP WP	KISME, OP WP	1500
KISME, OP WP	GOOFI, OP WP	1500
GOOFI, OP WP	JUNIE, GU FIX	1500
JUNIE, GU FIX	OPLAR, GU FIX	5000
OPLAR, GU FIX	GUMGE, GU FIX	5000
GUMGE, GU FIX	NIMITZ, GU VORTAC	5000
NIMITZ, GU VORTAC	GUYES, OP WP	18000
GUYES, OP WP	TERYY, OP WP	18000
TERYY, OP WP	TEGOD, OP WP	18000
<b>G212</b>		
VALDA, OP WP	YUREE, OP WP	5000 MAA - 18000

FROM	TO	MEA
------	----	-----

**G212 - CONTINUED**

YUREE, OP WP	FORT DAVIS, AK NDB	5000 MAA - 18000
--------------	--------------------	---------------------

**G215**

NRKEY, OP WP	OLCOT, OP WP	18000 MAA - 60000
OLCOT, OP WP	PLADO, OP WP	18000 MAA - 60000
PLADO, OP WP	SHEMYA, AK VORTAC	18000 MAA - 60000
SHEMYA, AK VORTAC	CURVS, AK FIX	18000 MAA - 60000
CURVS, AK FIX	DUTCH HARBOR, AK NDB/DME	18000 MAA - 60000

**G223**

MUBIT, OP WP	OLGIS, OP WP	18000
OLGIS, OP WP	PHILY, OP WP	18000
PHILY, OP WP	RISBA, OP WP	6000

**G339**

NIMITZ, GU VORTAC	SHAWS, OP WP	6000
SHAWS, OP WP	RIDLL, OP WP	6000
RIDLL, OP WP	NATSS, OP WP	6000
NATSS, OP WP	PAKDO, OP WP	6000

**G344**

CUTEE, OP WP	CARTO, AK FIX	18000 MAA - 60000
CARTO, AK FIX	CHIPT, OP WP	18000 MAA - 60000
CHIPT, OP WP	CHIKI, AK FIX	18000 MAA - 60000
CHIKI, AK FIX	CURVS, AK FIX	18000 MAA - 60000
CURVS, AK FIX	CRYPT, AK FIX	18000 MAA - 60000
CRYPT, AK FIX	CAMBO, AK FIX	18000 MAA - 60000
CAMBO, AK FIX	*CUDDA, AK WP	18000 MAA - 60000

\*24000 - MRA

**G349**

MARCC, AK WP	KIVAK, AK WP	18000 MAA - 60000
KIVAK, AK WP	PALIN, AK WP	18000 MAA - 60000
PALIN, AK WP	NEONN, AK WP	18000 MAA - 60000

**G467**

YELLO, OP WP	KITSS, OP WP	18000
--------------	--------------	-------

FROM	TO	MEA
<b>G467 - CONTINUED</b>		
KITSS, OP WP	ACRON, GU FIX	18000
ACRON, GU FIX	PULEE, GU FIX	18000
PULEE, GU FIX	NIMITZ, GU VORTAC	5000
<b>G469</b>		
NYMPH, OP WP	ONEIL, OP WP	18000
ONEIL, OP WP	RULOY, OP WP	MAA - 60000 18000
RULOY, OP WP	PINTT, OP WP	MAA - 60000 18000
PINTT, OP WP	CREMR, AK FIX	MAA - 60000 18000
CREMR, AK FIX	ST PAUL ISLAND, AK NDB/DME	MAA - 60000 18000
ST PAUL ISLAND, AK NDB/DME	PORT HEIDEN, AK NDB/DME	MAA - 60000 18000 MAA - 60000
<b>G575</b>		
CINTO, OP WP	BIGBY, OP WP	5500
BIGBY, OP WP	APIDD, OP WP	5500
APIDD, OP WP	HILCO, OP WP	5500
HILCO, OP WP	FICKY, OP WP	5500
<b>G583</b>		
BESAT, OP WP	MARCC, AK WP	18000
MARCC, AK WP	MUNRI, AK WP	MAA - 60000 18000
MUNRI, AK WP	EMMONAK, AK VOR/DME	MAA - 45000 18000 MAA - 60000
<b>H201</b>		
NOME, AK VOR/DME	SLEDD, AK WP	18000
SLEDD, AK WP	AVUBA, AK WP	MAA - 45000 18000
AVUBA, AK WP	ENEGU, AK WP	MAA - 45000 18000
ENEGU, AK WP	MUNRI, AK WP	MAA - 45000 18000
MUNRI, AK WP	KIVAK, AK WP	MAA - 45000 18000
KIVAK, AK WP	NAYLD, AK FIX	MAA - 45000 18000 MAA - 45000
<b>H222</b>		
VALDA, OP WP	ICEEE, AK WP	18000
ICEEE, AK WP	SLEDD, AK WP	MAA - 45000 18000
SLEDD, AK WP	MC GRATH, AK VORTAC	MAA - 45000 18000 MAA - 45000
<b>M756</b>		
OLBIE, OP WP	AIBIE, OP WP	6000

FROM	TO	MEA
<b>M756 - CONTINUED</b>		
AIBIE, OP WP	KEONE, OP WP	6000
<b>R204</b>		
KYWEE, OP WP	KALIN, OP WP	*18000
<b>R220</b>		
NODLE, AK FIX	NICHO, AK WP	18000 MAA - 60000
NICHO, AK WP	NOSHO, AK FIX	18000 MAA - 60000
NOSHO, AK FIX	NEONN, AK WP	18000 MAA - 60000
NEONN, AK WP	NANZA, AK FIX	18000 MAA - 60000
NANZA, AK FIX	NOLTI, OP WP	18000 MAA - 60000
NOLTI, OP WP	NAYLD, AK FIX	18000 MAA - 60000
NAYLD, AK FIX	NULUK, AK FIX	18000 MAA - 60000
NULUK, AK FIX	NANDY, AK FIX	18000 MAA - 60000
NANDY, AK FIX	NATES, OP WP	18000 MAA - 60000
NATES, OP WP	NIKLL, OP WP	18000 MAA - 60000
NIKLL, OP WP	NYMPH, OP WP	18000 MAA - 60000
NYMPH, OP WP	NUZAN, OP WP	18000 MAA - 60000
NUZAN, OP WP	NRKEY, OP WP	18000 MAA - 60000
NRKEY, OP WP	NIPPI, OP WP	18000 MAA - 60000
<b>R330</b>		
POWAL, OP WP	SHEMYA, AK VORTAC	18000 MAA - 60000
<b>R332</b>		
MAJURO, MH NDB/DME	VAVEE, OP WP	6000
<b>R336</b>		
CARTO, AK FIX	LYYLE, AK FIX	18000 MAA - 60000
LYYLE, AK FIX	MOUNT MOFFETT, AK NDB/DME	18000 MAA - 60000
<b>R337</b>		
ISGOG, OP WP	KOROR, PW NDB/DME	6500
<b>R338</b>		
NOME, AK VOR/DME	ICEEE, AK WP	18000 MAA - 60000

FROM	TO	MEA
<b>R338 - CONTINUED</b>		
ICEEE, AK WP	IDROD, AK WP	18000
		MAA - 60000
IDROD, AK WP	ROCET, AK WP	18000
		MAA - 60000
ROCET, AK WP	MUCLA, AK FIX	18000
		MAA - 60000
MUCLA, AK FIX	MARCC, AK WP	18000
		MAA - 60000
MARCC, AK WP	MORLY, AK WP	18000
		MAA - 60000
MORLY, AK WP	NATES, OP WP	18000
		MAA - 60000
NATES, OP WP	OPAKE, OP WP	18000
		MAA - 60000
<b>R341</b>		
NATES, OP WP	HAVAM, OP WP	18000
		MAA - 60000
HAVAM, OP WP	OFORD, OP WP	18000
		MAA - 60000
OFORD, OP WP	HODDY, AK FIX	18000
		MAA - 60000
HODDY, AK FIX	PUGGY, OP WP	18000
		MAA - 60000
PUGGY, OP WP	CHUUK, AK FIX	18000
		MAA - 60000
CHUUK, AK FIX	KODIAK, AK VOR/DME	18000
		MAA - 60000
<b>R451</b>		
HIXOR, OP WP	POWAL, OP WP	18000
		MAA - 60000
POWAL, OP WP	AAMYY, OP WP	18000
		MAA - 60000
AAMYY, OP WP	WALLT, AK FIX	18000
		MAA - 60000
WALLT, AK FIX	CHIKI, AK FIX	18000
		MAA - 60000
CHIKI, AK FIX	MOUNT MOFFETT, AK NDB/DME	18000
		MAA - 60000
<b>R463</b>		
MAGGI, OP FIX	SERYU, OP FIX	5000
SERYU, OP FIX	TOADS, OP FIX	5000
TOADS, OP FIX	APACK, OP FIX	5000
APACK, OP FIX	AUNTI, OP WP	5500
AUNTI, OP WP	ADOPE, OP WP	5500
ADOPE, OP WP	AXELE, OP WP	5500
AXELE, OP WP	ADTIL, OP WP	5500
ADTIL, OP WP	ALLBE, OP WP	5500
ALLBE, OP WP	ALCOA, OP FIX	5500
<b>R464</b>		
MAGGI, OP FIX	BITTA, OP FIX	5500
BITTA, OP FIX	BOARD, OP WP	21000

FROM	TO	MEA
<b>R464 - CONTINUED</b>		
BOARD, OP WP	BEKME, OP WP	5500
BEKME, OP WP	BILLO, OP WP	5500
BILLO, OP WP	BARAZ, OP WP	5500
BARAZ, OP WP	BAART, OP WP	5500
BAART, OP WP	BEBOP, OP FIX	5500
<b>R465</b>		
MAGGI, OP FIX	*SHARK, HI FIX	5500
*16000 - MRA		
SHARK, HI FIX	CLUTS, OP FIX	5500
CLUTS, OP FIX	CEBEN, OP WP	5500
CEBEN, OP WP	CIVIT, OP WP	5500
CIVIT, OP WP	CORTT, OP WP	5500
CORTT, OP WP	CUNDU, OP WP	5500
CUNDU, OP WP	CREAN, OP WP	5500
CREAN, OP WP	CINNY, OP WP	5500
<b>R576</b>		
MAUI, HI VORTAC	ALAFU, HI FIX	9000
ALAFU, HI FIX	WAPPO, HI FIX	14000
WAPPO, HI FIX	ONOVY, HI FIX	26000
ONOVY, HI FIX	DENNS, OP FIX	26000
DENNS, OP FIX	DRAYK, OP WP	24000
DRAYK, OP WP	DUSAC, OP WP	5500
DUSAC, OP WP	DIALO, OP WP	5500
DIALO, OP WP	DADIE, OP WP	5500
DADIE, OP WP	DUETS, OP WP	5500
DUETS, OP WP	DINTY, OP FIX	5500
<b>R577</b>		
MAUI, HI VORTAC	AWAHI, HI FIX	9000
AWAHI, HI FIX	AZIBA, HI FIX	16000
AZIBA, HI FIX	TANFO, HI FIX	35000
TANFO, HI FIX	ALICA, OP FIX	35000
ALICA, OP FIX	EBBER, OP FIX	35000
EBBER, OP FIX	ELOYI, OP WP	21000
ELOYI, OP WP	ERROT, OP WP	5500
ERROT, OP WP	ETNIC, OP WP	5500
ETNIC, OP WP	ETECO, OP WP	5500
ETECO, OP WP	EDSEL, OP WP	5500
EDSEL, OP WP	EDTOO, OP WP	5500
EDTOO, OP WP	*ELKEY, CA FIX	5500
*26000 - MRA		
<b>R578</b>		
DEREC, HI FIX	BYROW, HI FIX	14000
BYROW, HI FIX	FITES, OP FIX	14000
FITES, OP FIX	FAPIS, OP WP	21000
FAPIS, OP WP	FOMAS, OP WP	21000
FOMAS, OP WP	FIZEL, OP WP	5500
FIZEL, OP WP	FLITY, OP WP	5500
FLITY, OP WP	FOOTS, OP WP	5500
FOOTS, OP WP	FICKY, OP WP	5500
<b>R580</b>		
OMOTO, OP WP	OGDEN, OP WP	18000
		MAA - 60000



FROM	TO	MEA
<b>R580 - CONTINUED</b>		
OGDEN, OP WP	OPHET, OP WP	18000
		MAA - 60000
OPHET, OP WP	OLCOT, OP WP	18000
		MAA - 60000
OLCOT, OP WP	OPAKE, OP WP	18000
		MAA - 60000
OPAKE, OP WP	ONEIL, OP WP	18000
		MAA - 60000
ONEIL, OP WP	OBOYD, OP WP	18000
		MAA - 60000
OBOYD, OP WP	OFORD, OP WP	18000
		MAA - 60000
OFORD, OP WP	OGGOE, OP WP	18000
		MAA - 60000
OGGOE, OP WP	ONEOX, OP WP	18000
		MAA - 60000
ONEOX, OP WP	ORVIL, OP WP	18000
		MAA - 60000
ORVIL, OP WP	ORCCA, AK WP	18000
		MAA - 60000
ORCCA, AK WP	HAMND, AK WP	18000
		MAA - 60000

**R584**

CHOKO, OP WP	MCFLY, OP WP	5500
MCFLY, OP WP	MANRE, OP WP	5500
MANRE, OP WP	MAZZA, OP WP	5500
MAZZA, OP WP	MAJURO, MH NDB/DME	18000
MAJURO, MH NDB/DME	CURCH, OP WP	18000
CURCH, OP WP	BUCHOLZ, MH NDB	18000
BUCHOLZ, MH NDB	LOOIS, OP WP	18000
LOOIS, OP WP	HAVNU, FM FIX	18000
HAVNU, FM FIX	TRADD, FM FIX	18000
TRADD, FM FIX	POHNPEI, FM NDB/DME	18000
POHNPEI, FM NDB/DME	BIRUQ, FM FIX	18000
BIRUQ, FM FIX	TRUK, FM NDB/DME	18000
TRUK, FM NDB/DME	GUNSS, OP WP	18000
GUNSS, OP WP	JUNIE, GU FIX	18000
JUNIE, GU FIX	OPLAR, GU FIX	5000
OPLAR, GU FIX	GUMGE, GU FIX	5000
GUMGE, GU FIX	NIMITZ, GU VORTAC	5000
NIMITZ, GU VORTAC	OTTRE, OP WP	6000
OTTRE, OP WP	MIKYY, OP WP	18000
MIKYY, OP WP	KEITH, OP WP	18000

**R591**

AKISU, OP WP	ASPIN, OP WP	18000
		MAA - 60000
ASPIN, OP WP	AAMYY, OP WP	18000
		MAA - 60000
AAMYY, OP WP	SHEMYA, AK VORTAC	18000
		MAA - 60000
SHEMYA, AK VORTAC	AMOND, AK FIX	18000
		MAA - 60000
AMOND, AK FIX	ALDOZ, AK FIX	18000
		MAA - 60000
ALDOZ, AK FIX	ALUFF, AK FIX	18000
		MAA - 60000

FROM	TO	MEA
------	----	-----

**R591 - CONTINUED**

ALUFF, AK FIX	ST PAUL ISLAND, AK NDB/DME	18000
		MAA - 60000
ST PAUL ISLAND, AK NDB/DME	CHUUK, AK FIX	18000
		MAA - 60000
CHUUK, AK FIX	CAPE NEWENHAM, AK NDB/DME	18000
		MAA - 60000
CAPE NEWENHAM, AK NDB/DME	HAMND, AK WP	18000
		MAA - 60000

**R595**

NIMITZ, GU VORTAC	OTTRE, OP WP	6000
OTTRE, OP WP	MIKYY, OP WP	18000
MIKYY, OP WP	KEITH, OP WP	18000

**W21**

KAQTU, MP FIX	SANDO, GU FIX	3000
SANDO, GU FIX	NUJCO, MP FIX	9000
NUJCO, MP FIX	KATQO, GU FIX	9000
KATQO, GU FIX	HIRCH, MP FIX	9000
HIRCH, MP FIX	ANEVY, GU FIX	9000
ANEVY, GU FIX	SNAPP, GU FIX	9000
SNAPP, GU FIX	BESSS, OP WP	9000

FROM	TO	MEA	MAA
------	----	-----	-----

**§95.3000 LOW ALTITUDE RNAV ROUTES**

**95.3200 RNAV ROUTE T200**

COLLEGE STATION, TX VORTAC	SEALY, TX FIX	2100	17500
SEALY, TX FIX	MOLLR, TX WP	2000	17500
MOLLR, TX WP	SABINE PASS, TX VOR/DME	3100	17500

**95.3201 RNAV ROUTE T201**

MEVAE, SC WP	TRUEX, SC WP	2200	7000
TRUEX, SC WP	FEGNO, NC WP	2400	7000
FEGNO, NC WP	NUROE, NC WP	2700	7000
NUROE, NC WP	BORTZ, NC WP	3900	7000

**95.3202 RNAV ROUTE T202**

GURSH, SC WP	AWRYT, SC WP	2400	8000
AWRYT, SC WP	RICHE, SC FIX	2400	8000
RICHE, SC FIX	HUSTN, NC FIX	2500	8000
HUSTN, NC FIX	FEGNO, NC WP	2500	8000
FEGNO, NC WP	GANTS, NC FIX	2600	8000
GANTS, NC FIX	ZADEL, NC WP	2700	8000

**95.3203 RNAV ROUTE T203**

ANDYS, SC FIX	AWRYT, SC WP	2400	17500
AWRYT, SC WP	ROUTH, NC WP	2800	17500
ROUTH, NC WP	FADOS, NC WP	3400	17500
FADOS, NC WP	OREAD, NC WP	3500	17500

**95.3204 RNAV ROUTE T204**

TAYLOR, FL VORTAC	BRUNSWICK, GA VORTAC	2100	15000
-------------------	----------------------	------	-------

**95.3205 RNAV ROUTE T205**

OCALA, FL VORTAC *2500 - MOCA	VALDOSTA, GA VOR/DME	*3000	15000
----------------------------------	----------------------	-------	-------

**95.3206 RNAV ROUTE T206**

ENADE, NC WP	FADOS, NC WP	3000	17500
FADOS, NC WP	GOTHS, NC WP	3400	17500
GOTHS, NC WP	NUROE, NC WP	3400	17500
NUROE, NC WP	ZADEL, NC WP	3000	17500

**95.3207 RNAV ROUTE T207**

FOXAM, FL WP	MMKAY, FL WP	1800	17500
MMKAY, FL WP	WALEE, FL WP	2000	17500

**95.3208 RNAV ROUTE T208**

SIROC, GA WP	SAHND, FL WP	1800	17500
SAHND, FL WP	FOXAM, FL WP	1800	17500
FOXAM, FL WP	SUUGR, FL WP	1800	17500

FROM	TO	MEA	MAA
------	----	-----	-----

**95.3208 RNAV ROUTE T208 - CONTINUED**

SUUGR, FL WP	SMYRA, FL FIX	1800	17500
SMYRA, FL FIX	OAKIE, FL FIX	1800	17500
OAKIE, FL FIX	MALET, FL FIX	1800	17500
MALET, FL FIX	TICCO, FL FIX	1800	17500
TICCO, FL FIX	INDIA, FL FIX	1800	17500
INDIA, FL FIX	DIMBY, FL WP	1800	17500
DIMBY, FL WP	VALKA, FL FIX	1800	17500
VALKA, FL FIX	SULTY, FL WP	1700	17500
SULTY, FL WP	WIXED, FL WP	1700	17500
WIXED, FL WP	CLEFF, FL WP	1700	17500
CLEFF, FL WP	DURRY, FL WP	1700	17500
DURRY, FL WP	BOBOE, FL WP	1700	17500
BOBOE, FL WP	SHANC, FL FIX	1700	17500

**95.3209 RNAV ROUTE T209**

EHEJO, GA FIX	NASDE, GA WP	2000	17500
NASDE, GA WP	YASLU, GA WP	2000	17500
YASLU, GA WP	JAMTA, GA WP	2000	17500
JAMTA, GA WP	COLLIERS, SC VORTAC	2500	17500

**95.3210 RNAV ROUTE T210**

HADDE, FL FIX	MISSM, FL WP	1900	17500
MISSM, FL WP	OHLEE, FL WP	2500	17500
OHLEE, FL WP	MMKAY, FL WP	2500	17500
MMKAY, FL WP	MRUTT, FL WP	2500	17500
MRUTT, FL WP	*GUANO, FL FIX	2500	17500
*1900 - MCA GUANO, FL FIX , S BND			
GUANO, FL FIX	KIZER, FL FIX	2800	17500
KIZER, FL FIX	EMSEE, FL WP	2800	17500
EMSEE, FL WP	DAIYL, FL WP	1900	17500
DAIYL, FL WP	AKOJO, FL WP	1800	17500
AKOJO, FL WP	PUNQU, FL WP	2000	17500
PUNQU, FL WP	VARZE, FL WP	1900	17500

**95.3211 RNAV ROUTE T211**

OCALA, FL VORTAC	JUTTS, FL WP	2500	15000
JUTTS, FL WP	CARRA, FL WP	1900	15000
CARRA, FL WP	CRAIG, FL VORTAC	2100	15000

**95.3212 RNAV ROUTE T212**

RASHE, PA FIX	SELINGROVE, PA VOR/DME	4000	17500
SELINGROVE, PA VOR/DME	DIANO, PA FIX	3700	17500
DIANO, PA FIX	WILKES-BARRE, PA VORTAC	5000	17500
WILKES-BARRE, PA VORTAC	LAAYK, PA FIX	4000	17500
LAAYK, PA FIX	WEETS, NY FIX	4700	17500
WEETS, NY FIX	NELIE, CT FIX	3500	17500
NELIE, CT FIX	PUTNAM, CT VOR/DME	3000	17500

**95.3213 RNAV ROUTE T213**

LOUISVILLE, KY VORTAC	GAMKE, IN WP	*3600	8000
*NORTHBOUND EXPECT 7000			
*SOUTHBOUND EXPECT 6000			
GAMKE, IN WP	MILAN, IN FIX	*2800	8000
*NORTHBOUND EXPECT 7000			
*SOUTHBOUND EXPECT 6000			

FROM	TO	MEA	MAA
------	----	-----	-----

**95.3213 RNAV ROUTE T213 - CONTINUED**

MILAN, IN FIX *NORTHBOUND EXPECT 7000 *SOUTHBOUND EXPECT 6000	RICHMOND, IN DME	*2800	8000
---	------------------	-------	------

**95.3214 RNAV ROUTE T214**

OREAD, NC WP	BORTZ, NC WP	3500	17500
BORTZ, NC WP	THMSN, NC WP	3400	17500
THMSN, NC WP	ZADEL, NC WP	2400	17500
ZADEL, NC WP	ORPEE, NC WP	2700	17500

**95.3215 RNAV ROUTE T215**

BURGG, SC WP *4600 - MCA GENOD, NC FIX , N BND	*GENOD, NC FIX	4000	17500
GENOD, NC FIX	HORAL, TN WP	8500	17500
HORAL, TN WP	HILTO, VA FIX	6700	17500
HILTO, VA FIX	FLENR, VA WP	6500	17500
FLENR, VA WP *4800 - MCA RISTE, KY WP , SE BND	*RISTE, KY WP	6000	17500
RISTE, KY WP	DACEL, KY WP	3800	17500
DACEL, KY WP	HUGEN, KY WP	3300	17500
HUGEN, KY WP	LEXINGTON, KY VOR/DME	3100	17500
LEXINGTON, KY VOR/DME	NERVE, KY FIX	2800	8000
NERVE, KY FIX	GAMKE, IN WP	2600	8000
GAMKE, IN WP	MILAN, IN FIX	2800	8000
MILAN, IN FIX	DEEKS, IN FIX	2900	17500
DEEKS, IN FIX	BONNOY, IN WP	2700	17500
BONNOY, IN WP	CLEFT, IN FIX	2600	17500
CLEFT, IN FIX	MAPPS, IN FIX	2600	17500
MAPPS, IN FIX	SMARS, IL WP	2500	10000
SMARS, IL WP	CPTON, IL WP	2400	10000

**95.3216 RNAV ROUTE T216**

PHILIPSBURG, PA VORTAC	WILLIAMSPORT, PA VOR/DME	4200	17500
WILLIAMSPORT, PA VOR/DME	ELEXY, PA WP	4500	17500
ELEXY, PA WP	LAAYK, PA FIX	4100	17500
LAAYK, PA FIX	HELON, NY FIX	4000	17500
HELON, NY FIX	KINGSTON, NY VOR/DME	4000	17500
KINGSTON, NY VOR/DME	MOONI, CT FIX	3200	17500
MOONI, CT FIX	HARTFORD, CT VOR/DME	3200	17500
HARTFORD, CT VOR/DME	GROTON, CT VOR/DME	2600	17500
GROTON, CT VOR/DME *1500 - MOCA	SANDY POINT, RI VOR/DME	*2000	17500
SANDY POINT, RI VOR/DME	NANTUCKET, MA VOR/DME	2000	17500

**95.3217 RNAV ROUTE T217**

LEXINGTON, KY VOR/DME *NORTHBOUND EXPECT 7000 *SOUTHBOUND EXPECT 6000	BOSTR, OH FIX	*3000	8000
BOSTR, OH FIX *NORTHBOUND EXPECT 7000 *SOUTHBOUND EXPECT 6000	HEDEN, OH FIX	*2700	8000
HEDEN, OH FIX *NORTHBOUND EXPECT 7000 *SOUTHBOUND EXPECT 6000	PRUDE, OH FIX	*2800	8000
PRUDE, OH FIX *NORTHBOUND EXPECT 7000 *SOUTHBOUND EXPECT 6000	SPRINGFIELD, OH DME	*2800	8000

FROM	TO	MEA	MAA
<b>95.3217 RNAV ROUTE T217 - CONTINUED</b>			
SPRINGFIELD, OH DME *NORTHBOUND EXPECT 7000 *SOUTHBOUND EXPECT 6000	BONEE, OH FIX	*2900	8000
BONEE, OH FIX	SJAAY, IN WP	3000	17500
SJAAY, IN WP	DERRF, IN WP	2800	17500
DERRF, IN WP	GETCH, MI WP	2800	17500
GETCH, MI WP	GAYLE, MI WP	2400	17500
<b>95.3218 RNAV ROUTE T218</b>			
DLMAR, PA WP *4700 - MCA LAAYK, PA FIX , W BND	*LAAYK, PA FIX	4900	17500
LAAYK, PA FIX	SPARTA, NJ VORTAC	4000	17500
<b>95.3219 RNAV ROUTE T219</b>			
DILLINGHAM, AK VOR/DME *5000 - MOCA	BROUS, AK WP	*6000	17500
BROUS, AK WP *5400 - MOCA	NACIP, AK FIX	*6000	17500
NACIP, AK FIX *5400 - MOCA	ACATE, AK WP	*6000	17500
ACATE, AK WP *1300 - MOCA	RUFVY, AK WP	*2000	17500
RUFVY, AK WP	MKLUK, AK WP	2000	17500
MKLUK, AK WP *1300 - MOCA	HOOPER BAY, AK VOR/DME	*2000	17500
<b>95.3220 RNAV ROUTE T220</b>			
INDUSTRY, TX VORTAC	SEALY, TX FIX	2100	17500
SEALY, TX FIX	MOLLR, TX WP	2000	17500
MOLLR, TX WP	SABINE PASS, TX VOR/DME	3100	17500
<b>95.3221 RNAV ROUTE T221</b>			
*MAZIE, PA FIX *5000 - MRA **2200 - MOCA	ALLENTOWN, PA VORTAC	**3000	17500
ALLENTOWN, PA VORTAC	LAAYK, PA FIX	4000	17500
LAAYK, PA FIX	BINGHAMTON, NY VOR/DME	4000	17500
<b>95.3222 RNAV ROUTE T222</b>			
ST PAUL ISLAND, AK NDB/DME *2400 - MOCA	RUFVY, AK WP	*3000	17500
RUFVY, AK WP *1400 - MOCA	BETHEL, AK VORTAC	*3000	17500
BETHEL, AK VORTAC *1500 - MOCA	CABOT, AK FIX	*5000	17500
CABOT, AK FIX *1400 - MOCA	WOGAX, AK WP	*5000	17500
WOGAX, AK WP *2600 - MOCA	IKUFU, AK FIX	*5000	17500
IKUFU, AK FIX *3200 - MOCA	JILSI, AK WP	*5000	17500
JILSI, AK WP *3500 - MOCA	CYCAS, AK WP	*5000	17500
CYCAS, AK WP *3700 - MOCA	UTICE, AK WP	*5000	17500

FROM	TO	MEA	MAA
<b>95.3222 RNAV ROUTE T222 - CONTINUED</b>			
UTICE, AK WP	MC GRATH, AK VORTAC	5000	17500
MC GRATH, AK VORTAC	NENANA, AK VORTAC	5000	17500
NENANA, AK VORTAC	FAIRBANKS, AK VORTAC	*4000	17500
*3200 - MOCA			
<b>95.3223 RNAV ROUTE T223</b>			
CAPE NEWENHAM, AK NDB/DME	DILLINGHAM, AK VOR/DME	4400	17500
DILLINGHAM, AK VOR/DME	FAGIN, AK FIX	4400	17500
FAGIN, AK FIX	NONDA, AK FIX	8400	17500
NONDA, AK FIX	*BLUGA, AK FIX	12400	17500
*10000 - MCA BLUGA, AK FIX , SW BND			
BLUGA, AK FIX	*AMOTT, AK FIX	3000	17500
*7400 - MCA AMOTT, AK FIX , SW BND			
AMOTT, AK FIX	ANCHORAGE, AK VOR/DME	3000	17500
<b>95.3224 RNAV ROUTE T224</b>			
PALACIOS, TX VORTAC	MOLLR, TX WP	2500	17500
MOLLR, TX WP	FRYED, TX WP	1800	17500
FRYED, TX WP	MOCKS, TX WP	2100	17500
MOCKS, TX WP	SHWNN, TX WP	2100	17500
SHWNN, TX WP	WASPY, LA FIX	1700	17500
WASPY, LA FIX	KNZLY, LA WP	1700	17500
KNZLY, LA WP	ARTEL, LA FIX	1700	17500
ARTEL, LA FIX	CRISP, LA FIX	1700	17500
CRISP, LA FIX	MICRO, LA FIX	1700	17500
MICRO, LA FIX	ZIROR, LA FIX	1700	17500
ZIROR, LA FIX	DAFLY, LA WP	1800	17500
DAFLY, LA WP	LULEW, LA FIX	2100	17500
LULEW, LA FIX	BUDAM, LA FIX	1700	17500
BUDAM, LA FIX	MYRIC, LA FIX	*1700	17500
*1200 - MOCA			
MYRIC, LA FIX	WOVON, LA FIX	1700	17500
WOVON, LA FIX	DONBE, LA FIX	1700	17500
DONBE, LA FIX	AWDAD, LA FIX	1700	17500
AWDAD, LA FIX	SIMBY, LA FIX	1700	17500
SIMBY, LA FIX	VOODO, LA FIX	1700	17500
VOODO, LA FIX	KJAAAY, LA WP	1700	17500
KJAAAY, LA WP	SNAKI, LA FIX	1700	17500
SNAKI, LA FIX	SLIDD, LA FIX	1700	17500
SLIDD, LA FIX	CLERY, MS FIX	1700	17500
CLERY, MS FIX	MUDDA, MS FIX	1800	17500
MUDDA, MS FIX	WTERS, MS WP	1800	17500
WTERS, MS WP	NESFE, MS FIX	1800	17500
NESFE, MS FIX	BUGLE, MS FIX	1900	17500
BUGLE, MS FIX	SQWID, MS FIX	1800	17500
SQWID, MS FIX	LYNRD, AL WP	1900	17500
LYNRD, AL WP	AXSIS, AL FIX	2000	17500
AXSIS, AL FIX	AXEJA, AL CN	2000	17500
AXEJA, AL CN	TENSA, AL FIX	1900	17500
TENSA, AL FIX	WIILL, AL WP	2200	17500
WIILL, AL WP	*PICKS, AL FIX	2300	17500
*3500 - MRA			
PICKS, AL FIX	ALOON, AL FIX	2300	17500
ALOON, AL FIX	MGMRY, AL WP	2100	17500
MGMRY, AL WP	GONDR, AL WP	2100	17500
GONDR, AL WP	RSVLT, GA WP	2400	17500
RSVLT, GA WP	CANER, GA FIX	2800	17500

FROM	TO	MEA	MAA
<b>95.3224 RNAV ROUTE T224 - CONTINUED</b>			
CANER, GA FIX	GRANT, GA FIX	2800	17500
GRANT, GA FIX	HUZER, GA FIX	2600	17500
HUZER, GA FIX	SMARR, GA FIX	2500	17500
SMARR, GA FIX	SINCA, GA FIX	2500	17500
SINCA, GA FIX	GLOSS, GA FIX	2400	17500
GLOSS, GA FIX	MADDI, GA FIX	2400	17500
MADDI, GA FIX	JOTNO, GA FIX	2500	17500
JOTNO, GA FIX	DACHA, GA FIX	2500	17500
DACHA, GA FIX	UGAAA, GA WP	2500	17500
UGAAA, GA WP	JOSPI, GA FIX	2500	17500
JOSPI, GA FIX	BOWMN, GA FIX	2500	17500
BOWMN, GA FIX	HARTI, GA FIX	2600	17500
HARTI, GA FIX	ECITY, SC WP	2500	17500
ECITY, SC WP	PEDAL, SC FIX	3700	17500
PEDAL, SC FIX	DOODD, SC FIX	3900	17500
DOODD, SC FIX	TUXDO, SC FIX	5200	17500
TUXDO, SC FIX	STYLZ, NC WP	6200	17500
STYLZ, NC WP	GENOD, NC FIX	6200	17500
GENOD, NC FIX	SWENK, NC FIX	5200	17500
SWENK, NC FIX	VAESE, NC FIX	4900	17500
VAESE, NC FIX	BONZE, NC WP	4500	17500
BONZE, NC WP	SANFI, NC FIX	4100	17500
SANFI, NC FIX	JOTTA, NC FIX	4000	17500
JOTTA, NC FIX	INGON, NC FIX	3500	17500
INGON, NC FIX	PROVE, NC FIX	3400	17500
PROVE, NC FIX	MAYOS, NC FIX	4100	17500
MAYOS, NC FIX	LEAKS, NC FIX	4100	17500
LEAKS, NC FIX	UFFIN, NC FIX	3300	17500
UFFIN, NC FIX	MCDON, VA WP	3300	17500
MCDON, VA WP	YUDUG, VA FIX	2400	17500
YUDUG, VA FIX	*NUTTS, VA FIX	2300	17500
*9000 - MRA			
NUTTS, VA FIX	WAVES, VA WP	3400	17500
WAVES, VA WP	TAPPA, VA FIX	2100	17500
TAPPA, VA FIX	COLIN, VA FIX	1900	17500

**95.3225 RNAV ROUTE T225**

HOOPER BAY, AK VOR/DME	AKELT, AK FIX	4600	17500
AKELT, AK FIX	ALMOT, AK FIX	4400	17500
ALMOT, AK FIX	UNALAKLEET, AK VOR/DME	3700	17500
UNALAKLEET, AK VOR/DME	EDMON, AK FIX	5000	17500
EDMON, AK FIX	VENCE, AK FIX	5900	17500
VENCE, AK FIX	GALENA, AK VOR/DME	3400	17500
GALENA, AK VOR/DME	KUHZE, AK FIX	4400	17500
KUHZE, AK FIX	CHOKK, AK FIX	6800	17500
CHOKK, AK FIX	TANANA, AK VOR/DME	4000	17500
TANANA, AK VOR/DME	*REEBA, AK FIX	4000	17500
*7000 - MRA			
REEBA, AK FIX	*FAIRBANKS, AK VORTAC	5000	17500
*4700 - MCA FAIRBANKS, AK VORTAC , BND			

**95.3226 RNAV ROUTE T226**

JOHNSTONE POINT, AK VOR/DME	*FIDAL, AK FIX	5000	17500
*7000 - MCA FIDAL, AK FIX , N BND			
FIDAL, AK FIX	*ROBES, AK FIX	8000	17500
*8900 - MCA ROBES, AK FIX , N BND			
ROBES, AK FIX	*KLUNG, AK FIX	10000	17500
*7100 - MCA KLUNG, AK FIX , S BND			



FROM	TO	MEA	MAA
<b>95.3226 RNAV ROUTE T226 - CONTINUED</b>			
KLUNG, AK FIX	GULKANA, AK VOR/DME	7000	17500
GULKANA, AK VOR/DME	DOZEY, AK FIX	5000	17500
DOZEY, AK FIX	*PAXON, AK FIX	**8000	17500
*9500 - MCA PAXON, AK FIX , N BND			
**7300 - MOCA			
PAXON, AK FIX	*DONEL, AK FIX	**12000	17500
*10600 - MCA DONEL, AK FIX , S BND			
**11500 - MOCA			
DONEL, AK FIX	BIG DELTA, AK VORTAC	7000	17500
BIG DELTA, AK VORTAC	HEXAX, AK WP	7000	17500
HEXAX, AK WP	FORT YUKON, AK VORTAC	*4000	17500
*3100 - MOCA			
<b>95.3227 RNAV ROUTE T227</b>			
SHEMYA, AK VORTAC	JANNT, AK WP	3400	17500
JANNT, AK WP	BAERE, AK WP	*7500	17500
*2900 - MOCA			
BAERE, AK WP	ALEUT, AK WP	*7500	17500
*3300 - MOCA			
ALEUT, AK WP	MORDI, AK FIX	2500	17500
MORDI, AK FIX	GENFU, AK FIX	*4900	17500
*4000 - MOCA			
GENFU, AK FIX	*BINAL, AK FIX	4000	17500
*3300 - MCA BINAL, AK FIX , SW BND			
BINAL, AK FIX	WIXER, AK WP	*3800	17500
*3000 - MOCA			
WIXER, AK WP	CULTI, AK WP	3400	17500
CULTI, AK WP	*ZAFPO, AK WP	4300	17500
*4600 - MCA ZAFPO, AK WP , NE BND			
ZAFPO, AK WP	BATTY, AK FIX	5600	17500
BATTY, AK FIX	GAMIC, AK WP	5700	17500
GAMIC, AK WP	FEDGI, AK WP	5000	17500
FEDGI, AK WP	*WEZZL, AK WP	6300	17500
*2700 - MCA WEZZL, AK WP , SW BND			
WEZZL, AK WP	AMOTT, AK FIX	*2100	17500
*1500 - MOCA			
AMOTT, AK FIX	*BIG LAKE, AK VORTAC	2300	17500
*2700 - MCA BIG LAKE, AK VORTAC , N BND			
BIG LAKE, AK VORTAC	*SURES, AK FIX	7000	17500
*10000 - MRA			
SURES, AK FIX	CAWIN, AK FIX	*9700	17500
*8600 - MOCA			
CAWIN, AK FIX	LIBER, AK FIX	9000	17500
LIBER, AK FIX	*GLOWS, AK FIX	7100	17500
*4800 - MCA GLOWS, AK FIX , S BND			
GLOWS, AK FIX	PERZO, AK WP	*3600	17500
*2300 - MOCA			
PERZO, AK WP	*FAIRBANKS, AK VORTAC	3400	17500
*3600 - MCA FAIRBANKS, AK VORTAC , N BND			
FAIRBANKS, AK VORTAC	*PESGE, AK WP	5400	17500
*5100 - MCA PESGE, AK WP , S BND			
PESGE, AK WP	*JIFFS, AK WP	5000	17500
*8400 - MCA JIFFS, AK WP , N BND			
JIFFS, AK WP	FIPSU, AK WP	*11000	17500
*8400 - MOCA			
FIPSU, AK WP	*CUGOB, AK WP	**11000	17500
*7000 - MCA CUGOB, AK WP , S BND			
**10300 - MOCA			

FROM	TO	MEA	MAA
<b>95.3227 RNAV ROUTE T227 - CONTINUED</b>			
CUGOB, AK WP	SIKLV, AK WP	4500	17500
SIKLV, AK WP	DEADHORSE, AK VOR/DME	2200	17500
<b>95.3228 RNAV ROUTE T228</b>			
CAPE NEWENHAM, AK NDB/DME	KUCYE, AK WP	4600	17500
KUCYE, AK WP	RUFVY, AK WP	2000	17500
RUFVY, AK WP	HOOPER BAY, AK VOR/DME	3000	17500
HOOPER BAY, AK VOR/DME	NOME, AK VOR/DME	*5000	17500
*4400 - MOCA			
NOME, AK VOR/DME	HIKAX, AK WP	7000	17500
HIKAX, AK WP	SHISHMAREF, AK NDB	4000	17500
SHISHMAREF, AK NDB	ECIPI, AK FIX	*10000	17500
*2000 - MOCA			
ECIPI, AK FIX	JAPKI, AK WP	*8000	17500
*3800 - MOCA			
JAPKI, AK WP	PODKI, AK WP	*13000	17500
*4200 - MOCA			
PODKI, AK WP	CIRSU, AK WP	3800	17500
CIRSU, AK WP	BARROW, AK VOR/DME	2000	17500
BARROW, AK VOR/DME	DEADHORSE, AK VOR/DME	*2000	17500
*1500 - MOCA			
DEADHORSE, AK VOR/DME	ROCES, AK WP	*2000	17500
*1300 - MOCA			
<b>95.3229 RNAV ROUTE T229</b>			
**FAIRBANKS, AK VORTAC	*REEBA, AK FIX	5000	17500
*7000 - MRA			
**4700 - MCA FAIRBANKS, AK VORTAC , W BND			
REEBA, AK FIX	TANANA, AK VOR/DME	4000	17500
TANANA, AK VOR/DME	HUSLIA, AK VOR/DME	*6000	17500
*5500 - MOCA			
HUSLIA, AK VOR/DME	SELAWIK, AK VOR/DME	4000	17500
SELAWIK, AK VOR/DME	KOTZEBUE, AK VOR/DME	*3000	17500
*2500 - MOCA			
KOTZEBUE, AK VOR/DME	SUGRE, AK FIX	4000	17500
SUGRE, AK FIX	VANTY, AK WP	3000	17500
<b>95.3230 RNAV ROUTE T230</b>			
ST PAUL ISLAND, AK NDB/DME	CHINOOK, AK NDB	*3000	17500
*2700 - MOCA			
<b>95.3231 RNAV ROUTE T231</b>			
*FAIRBANKS, AK VORTAC	HOBOM, AK WP	5100	17500
*4300 - MCA FAIRBANKS, AK VORTAC , W BND			
HOBOM, AK WP	MIPMY, AK WP	6300	17500
MIPMY, AK WP	SELAWIK, AK VOR/DME	3300	17500
SELAWIK, AK VOR/DME	KOTZEBUE, AK VOR/DME	*3000	17500
*2500 - MOCA			
<b>95.3232 RNAV ROUTE T232</b>			
BARROW, AK VOR/DME	BRONX, AK FIX	*4000	17500
*1900 - MOCA			
BRONX, AK FIX	AKUMY, AK WP	9100	17500
AKUMY, AK WP	*OCOCU, AK FIX	**9000	17500
*5600 - MCA OCOCU, AK FIX , NW BND			
**7800 - MOCA			

FROM	TO	MEA	MAA
<b>95.3232 RNAV ROUTE T232 - CONTINUED</b>			
OCOCU, AK FIX *4100 - MOCA	BETTLES, AK VOR/DME	*9000	17500
BETTLES, AK VOR/DME *3600 - MCA FAIRBANKS, AK VORTAC , NW BND **5400 - MOCA	*FAIRBANKS, AK VORTAC	**6000	17500
FAIRBANKS, AK VORTAC *2900 - MOCA	KRNKL, AK FIX	*3200	17500
KRNKL, AK FIX *1900 - MOCA	IMARE, AK FIX	*2300	17500
IMARE, AK FIX *3400 - MOCA	CUTUB, AK WP	*3900	17500
CUTUB, AK WP *2800 - MCA RIVOR, AK FIX , W BND	*RIVOR, AK FIX	3700	17500
RIVOR, AK FIX *5100 - MCA BIG DELTA, AK VORTAC , E BND	*BIG DELTA, AK VORTAC	3200	17500
BIG DELTA, AK VORTAC	MEYLE, AK FIX	6400	17500
MEYLE, AK FIX	NORTHWAY, AK VORTAC	8000	17500
<b>95.3233 RNAV ROUTE T233</b>			
KOTZEBUE, AK VOR/DME	CIBDU, AK WP	2600	17500
CIBDU, AK WP	TOMPY, AK WP	4100	17500
TOMPY, AK WP	KORKY, AK WP	4900	17500
KORKY, AK WP *4900 - MCA ENCOR, AK WP , W BND	*ENCOR, AK WP	6800	17500
ENCOR, AK WP	BETTLES, AK VOR/DME	4700	17500
<b>95.3234 RNAV ROUTE T234</b>			
*FAIRBANKS, AK VORTAC *4300 - MCA FAIRBANKS, AK VORTAC , W BND	TOLLO, AK FIX	5000	17500
TOLLO, AK FIX	RAMPA, AK FIX	7000	17500
<b>95.3235 RNAV ROUTE T235</b>			
FILEV, AK WP	ZISDU, AK WP	1800	17500
ZISDU, AK WP *1400 - MOCA	WUPUV, AK WP	*2000	17500
WUPUV, AK WP *1500 - MOCA	JATIL, AK WP	*3500	17500
JATIL, AK WP	ZADRO, AK WP	1800	17500
ZADRO, AK WP	DEADHORSE, AK VOR/DME	1900	17500
<b>95.3236 RNAV ROUTE T236</b>			
NENANA, AK VORTAC	RAMPA, AK FIX	7000	17500
<b>95.3237 RNAV ROUTE T237</b>			
*HOMER, AK VOR/DME *4800 - MCA HOMER, AK VOR/DME , E BND **8500 - MOCA	WUXAN, AK WP	**9000	17500
WUXAN, AK WP *4100 - MOCA	MIDDLETON ISLAND, AK VOR/DME	*5000	17500
<b>95.3238 RNAV ROUTE T238</b>			
RAMPA, AK FIX	BETTLES, AK VOR/DME	7000	17500
<b>95.3239 RNAV ROUTE T239</b>			
PECAN, GA VOR/DME *4000 - MRA	*SHANY, GA FIX	2000	17500

FROM	TO	MEA	MAA
<b>95.3239 RNAV ROUTE T239 - CONTINUED</b>			
SHANY, GA FIX	EUFAULA, AL VORTAC	2300	17500
EUFAULA, AL VORTAC	MILER, AL FIX	2000	17500
MILER, AL FIX	TUSKEGEE, AL VOR/DME	2300	17500
TUSKEGEE, AL VOR/DME	KENTT, AL FIX	*2600	17500
*2100 - MOCA			
KENTT, AL FIX	VLKNN, AL WP	3200	17500
VLKNN, AL WP	FOGUM, AL WP	2600	17500
FOGUM, AL WP	SWIKI, AL WP	*2600	17500
*2100 - MOCA			
SWIKI, AL WP	GANTT, MS WP	2500	17500
GANTT, MS WP	ICAVY, MS WP	2300	17500
ICAVY, MS WP	GOINS, MS WP	2400	17500
<b>95.3240 RNAV ROUTE T240</b>			
BETTLES, AK VOR/DME	TEGDE, AK FIX	7800	17500
TEGDE, AK FIX	*DERIK, AK FIX	9700	17500
*4700 - MCA DERIK, AK FIX , S BND			
DERIK, AK FIX	SHELO, AK FIX	3600	17500
SHELO, AK FIX	DEADHORSE, AK VOR/DME	2000	17500
<b>95.3241 RNAV ROUTE T241</b>			
LATCH, AK FIX	*FOROP, AK WP	**1700	17500
*3800 - MCA FOROP, AK WP , NE BND			
**1200 - MOCA			
FOROP, AK WP	AKCAR, AK WP	4600	17500
AKCAR, AK WP	LEVEL ISLAND, AK VOR/DME	4800	17500
LEVEL ISLAND, AK VOR/DME	ZIDRA, AK WP	5800	17500
<b>95.3242 RNAV ROUTE T242</b>			
*TALKEETNA, AK VOR/DME	**JOKAP, AK WP	***16000	17500
*12100 - MCA TALKEETNA, AK VOR/DME , N BND			
**11500 - MCA JOKAP, AK WP , S BND			
***15300 - MOCA			
JOKAP, AK WP	KUTDE, AK WP	6000	17500
KUTDE, AK WP	LACIL, AK WP	*15000	17500
*9400 - MOCA			
LACIL, AK WP	BARROW, AK VOR/DME	*8000	17500
*1800 - MOCA			
<b>95.3243 RNAV ROUTE T243</b>			
PUNGO, NC FIX	ZOLMN, NC FIX	*4000	17000
*1500 - MOCA			
<b>95.3244 RNAV ROUTE T244</b>			
NOME, AK VOR/DME	CONFI, AK WP	3000	17500
CONFI, AK WP	CHEFF, AK WP	5300	17500
CHEFF, AK WP	*BETPE, AK WP	6400	17500
*7800 - MCA BETPE, AK WP , SE BND			
BETPE, AK WP	CEXIX, AK WP	10000	17500
CEXIX, AK WP	*CAKAD, AK WP	6600	17500
*6400 - MCA CAKAD, AK WP , NW BND			
CAKAD, AK WP	ANCHORAGE, AK VOR/DME	3000	17500
<b>95.3245 RNAV ROUTE T245</b>			
SEAL BEACH, CA VORTAC	POPPR, CA FIX	2500	17500

FROM	TO	MEA	MAA
<b>95.3245 RNAV ROUTE T245 - CONTINUED</b>			
POPPR, CA FIX	*SANTA MONICA, CA VOR/DME	2500	17500
*3200 - MCA SANTA MONICA, CA VOR/DME , NW BND			
SANTA MONICA, CA VOR/DME	SILEX, CA FIX	4600	17500
<b>95.3246 RNAV ROUTE T246</b>			
BARROW, AK VOR/DME	GALENA, AK VOR/DME	9200	17500
GALENA, AK VOR/DME	MC GRATH, AK VORTAC	5800	17500
MC GRATH, AK VORTAC	*WINOR, AK FIX	4900	17500
*7500 - MCA WINOR, AK FIX , SE BND			
WINOR, AK FIX	FFITZ, AK FIX	8200	17500
FFITZ, AK FIX	*FRIDA, AK FIX	8800	17500
*9500 - MRA			
*7600 - MCA FRIDA, AK FIX , NW BND			
FRIDA, AK FIX	*IVANN, AK FIX	6600	17500
*5900 - MCA IVANN, AK FIX , W BND			
IVANN, AK FIX	ANCHORAGE, AK VOR/DME	2200	17500
<b>95.3247 RNAV ROUTE T247</b>			
SEAL BEACH, CA VORTAC	POPPR, CA FIX	2500	17500
POPPR, CA FIX	*SANTA MONICA, CA VOR/DME	2500	17500
*3200 - MCA SANTA MONICA, CA VOR/DME , NW BND			
SANTA MONICA, CA VOR/DME	CANOG, CA FIX	5000	17500
<b>95.3248 RNAV ROUTE T248</b>			
GAMBELL, AK NDB/DME	QAYAQ, AK WP	3600	17500
QAYAQ, AK WP	EMMONAK, AK VOR/DME	3000	17500
<b>95.3249 RNAV ROUTE T249</b>			
VAN NUYS, CA VOR/DME	*SANTA MONICA, CA VOR/DME	4700	17500
*3300 - MCA SANTA MONICA, CA VOR/DME , N BND			
SANTA MONICA, CA VOR/DME	POPPR, CA FIX	2500	17500
POPPR, CA FIX	SEAL BEACH, CA VORTAC	2500	17500
<b>95.3250 RNAV ROUTE T250</b>			
BETHEL, AK VORTAC	AKELT, AK FIX	3800	17500
AKELT, AK FIX	QAYAQ, AK WP	3000	17500
QAYAQ, AK WP	KUKULIAK, AK VOR/DME	3700	17500
<b>95.3251 RNAV ROUTE T251</b>			
FRNIA, MO WP	FARMINGTON, MO VORTAC	2900	17500
FARMINGTON, MO VORTAC	FORISTELL, MO VORTAC	3100	6000
FORISTELL, MO VORTAC	*RIVRS, IL FIX	2700	6000
*6000 - MRA			
RIVRS, IL FIX	KAYUU, MO WP	2700	17500
KAYUU, MO WP	MERKR, IA WP	2500	17500
MERKR, IA WP	AGENS, IA FIX	2500	17500
AGENS, IA FIX	PICRA, IA WP	2700	17500
PICRA, IA WP	HAVOS, IA WP	2800	17500
HAVOS, IA WP	WATERLOO, IA VOR/DME	2800	17500
WATERLOO, IA VOR/DME	ZEZDU, IA FIX	2800	17500
ZEZDU, IA FIX	FALAR, MN FIX	3000	17500
FALAR, MN FIX	KOETZ, WI WP	3100	17500
<b>95.3252 RNAV ROUTE T252</b>			
NOME, AK VOR/DME	KOTZEBUE, AK VOR/DME	5900	17500

FROM	TO	MEA	MAA
<b>95.3252 RNAV ROUTE T252 - CONTINUED</b>			
KOTZEBUE, AK VOR/DME	PERCI, AK WP	3000	17500
PERCI, AK WP	WARRT, AK WP	7000	17500
WARRT, AK WP	DEADHORSE, AK VOR/DME	3000	17500
<b>95.3254 RNAV ROUTE T254</b>			
COLLEGE STATION, TX VORTAC	HIPPS, TX WP	3000	15000
HIPPS, TX WP	EAKES, TX WP	3000	15000
EAKES, TX WP	CREPO, TX WP	3100	15000
CREPO, TX WP	LAKE CHARLES, LA VORTAC	2200	15000
<b>95.3255 RNAV ROUTE T255</b>			
MARTHAS VINEYARD, MA VOR/DME	FALMA, RI FIX	2000	17500
FALMA, RI FIX	PROVIDENCE, RI VOR/DME	2000	17500
PROVIDENCE, RI VOR/DME	NOXSE, RI WP	2500	17500
NOXSE, RI WP	BLATT, CT FIX	2500	17500
BLATT, CT FIX	NELIE, CT FIX	2800	17500
<b>95.3256 RNAV ROUTE T256</b>			
SAN ANTONIO, TX VORTAC	LDRET, TX WP	3000	17500
LDRET, TX WP	MOLLR, TX WP	2400	17500
MOLLR, TX WP	SABINE PASS, TX VOR/DME	3100	17500
SABINE PASS, TX VOR/DME	GUSTI, LA FIX	2000	17500
GUSTI, LA FIX	DAFLY, LA WP	2800	17500
<b>95.3257 RNAV ROUTE T257</b>			
VENTURA, CA VOR/DME	SAN MARCUS, CA VORTAC	6300	17500
SAN MARCUS, CA VORTAC	MORRO BAY, CA VORTAC	7300	17500
MORRO BAY, CA VORTAC	CALIS, CA FIX	4100	17500
CALIS, CA FIX	BLANC, CA FIX	3400	17500
BLANC, CA FIX	HNNTR, CA WP	6600	17500
HNNTR, CA WP	DUBSS, CA WP	7000	17500
DUBSS, CA WP	CAATE, CA WP	6900	17500
CAATE, CA WP	CHAWZ, CA WP	3900	17500
CHAWZ, CA WP	PORTE, CA FIX	4200	17500
PORTE, CA FIX	THHEO, CA WP	4200	17500
THHEO, CA WP	JAMIN, CA WP	4300	17500
JAMIN, CA WP	POINT REYES, CA VOR/DME	4300	17500
POINT REYES, CA VOR/DME	FREES, CA FIX	3500	17500
FREES, CA FIX	NACKI, CA WP	4900	17500
NACKI, CA WP	MENDOCINO, CA VORTAC	5600	17500
MENDOCINO, CA VORTAC	MERRI, CA FIX	5600	17500
MERRI, CA FIX	FLUEN, CA FIX	5700	17500
FLUEN, CA FIX	PLYAT, CA FIX	6800	17500
PLYAT, CA FIX	CCHUK, CA WP	6700	17500
CCHUK, CA WP	CICRO, CA WP	4800	17500
CICRO, CA WP	SEGVE, CA FIX	3800	17500
SEGVE, CA FIX	SCUPY, CA WP	2400	17500
SCUPY, CA WP	OLJEK, CA FIX	2200	17500
OLJEK, CA FIX	CIGCA, CA WP	1700	17500
CIGCA, CA WP	FURNS, CA WP	2200	17500
FURNS, CA WP	MITUE, OR FIX	4700	17500
MITUE, OR FIX	JANAS, OR FIX	4600	17500
JANAS, OR FIX	NEWPORT, OR VORTAC	4300	17500
NEWPORT, OR VORTAC	CUTEL, OR FIX	4100	17500
CUTEL, OR FIX	EYCEH, OR WP	4100	17500

FROM	TO	MEA	MAA
<b>95.3257 RNAV ROUTE T257 - CONTINUED</b>			
EYCEH, OR WP	ILWAC, WA FIX	2300	17500
ILWAC, WA FIX	ZEDAT, WA FIX	2300	17500
ZEDAT, WA FIX	WAVLU, WA FIX	2900	17500
WAVLU, WA FIX	HOQUIAM, WA VORTAC	2900	17500
HOQUIAM, WA VORTAC	COPLS, WA WP	2600	17500
COPLS, WA WP	WAPTO, WA FIX	2900	17500
WAPTO, WA FIX	OZETT, WA WP	3700	17500
OZETT, WA WP	TATOOSH, WA VORTAC	4300	17500

**95.3258 RNAV ROUTE T258**

MINIM, AL FIX	CAYAP, AL FIX	2300	17500
CAYAP, AL FIX	CRMSN, AL WP	2200	17500
CRMSN, AL WP	ZIVMU, AL FIX	2300	17500
ZIVMU, AL FIX	DAYVS, AL WP	2500	17500
DAYVS, AL WP	HEENA, AL FIX	2600	17500
HEENA, AL FIX	KYLEE, AL FIX	2900	17500
KYLEE, AL FIX	CAMPP, AL FIX	3200	17500
CAMPP, AL FIX	BRAVS, GA WP	2900	17500
BRAVS, GA WP	LANGA, GA FIX	2600	17500
LANGA, GA FIX	CANER, GA FIX	3500	17500
CANER, GA FIX	GRANT, GA FIX	2900	17500
GRANT, GA FIX	HUZER, GA FIX	2600	17500
HUZER, GA FIX	SMARR, GA FIX	2500	17500
SMARR, GA FIX	SINCA, GA FIX	2500	17500
SINCA, GA FIX	GLOSS, GA FIX	2400	17500
GLOSS, GA FIX	MADDI, GA FIX	2400	17500
MADDI, GA FIX	JOTNO, GA FIX	2500	17500
JOTNO, GA FIX	DACHA, GA FIX	2500	17500
DACHA, GA FIX	UGAAA, GA WP	2500	17500
UGAAA, GA WP	HRTWL, SC WP	2500	17500
HRTWL, SC WP	WILLS, SC FIX	2400	17500
WILLS, SC FIX	TAYSO, SC FIX	2300	17500
TAYSO, SC FIX	RICHE, SC FIX	2400	17500
RICHE, SC FIX	HUNNY, NC WP	2500	17500
HUNNY, NC WP	NATCH, NC FIX	2400	17500
NATCH, NC FIX	GMINI, NC WP	2400	17500

**95.3259 RNAV ROUTE T259**

LAKE HUGHES, CA VORTAC	SHAFTER, CA VORTAC	8800	17500
SHAFTER, CA VORTAC	AVENAL, CA VOR/DME	*4300	17500
*3600 - MOCA			
AVENAL, CA VOR/DME	MBARI, CA WP	6600	17500
MBARI, CA WP	LKHRN, CA WP	6200	17500
LKHRN, CA WP	SALINAS, CA VORTAC	6000	17500
SALINAS, CA VORTAC	CAATE, CA WP	4000	17500
CAATE, CA WP	SANTY, CA FIX	*4000	17500
*3300 - MOCA			
SANTY, CA FIX	SAPID, CA FIX	5200	17500
SAPID, CA FIX	CRTER, CA WP	5500	17500
CRTER, CA WP	NORCL, CA WP	6000	17500
NORCL, CA WP	*MOVDD, CA WP	6000	17500
*5000 - MCA MOVDD, CA WP , SW BND			
MOVDD, CA WP	OOWEN, CA WP	3500	17500
OOWEN, CA WP	OXJEF, CA WP	2300	17500
OXJEF, CA WP	*SAAGO, CA WP	7000	17500
*9600 - MCA SAAGO, CA WP , E BND			
SAAGO, CA WP	*BNAKI, CA WP	11500	17500
*13200 - MCA BNAKI, CA WP , E BND			

FROM	TO	MEA	MAA
<b>95.3259 RNAV ROUTE T259 - CONTINUED</b>			
BNAKI, CA WP	WEXIM, CA WP	14700	17500
WEXIM, CA WP	*NIKOL, CA FIX	14600	17500
*12200 - MCA NIKOL, CA FIX , W BND			
NIKOL, CA FIX	DAYMN, NV WP	13100	17500
DAYMN, NV WP	ELY, NV VOR/DME	12100	17500
<b>95.3260 RNAV ROUTE T260</b>			
NOME, AK VOR/DME	TIN CITY, AK NDB/DME	6900	17500
TIN CITY, AK NDB/DME	COGNUM, AK WP	5300	17500
COGNUM, AK WP	POINT HOPE, AK NDB	3000	17500
<b>95.3261 RNAV ROUTE T261</b>			
SANTA CATALINA, CA VORTAC	GAVIOTA, CA VORTAC	6500	17500
GAVIOTA, CA VORTAC	MORRO BAY, CA VORTAC	*6200	17500
*5700 - MOCA			
MORRO BAY, CA VORTAC	CLMNS, CA FIX	4100	17500
CLMNS, CA FIX	HRRNG, CA WP	2300	17500
HRRNG, CA WP	*HMPBK, CA WP	2300	17500
*4300 - MCA HMPBK, CA WP , N BND			
HMPBK, CA WP	*WOZZZ, CA WP	5400	17500
*6600 - MCA WOZZZ, CA WP , N BND			
WOZZZ, CA WP	DUBSS, CA WP	6900	17500
DUBSS, CA WP	SALINAS, CA VORTAC	6900	17500
SALINAS, CA VORTAC	KARNN, CA FIX	5500	17500
KARNN, CA FIX	WINDY, CA FIX	4700	17500
WINDY, CA FIX	SMONE, CA WP	5700	17500
SMONE, CA WP	*MOVDD, CA WP	5700	17500
*4700 - MCA MOVDD, CA WP , SE BND			
MOVDD, CA WP	RBLEW, CA WP	3600	17500
RBLEW, CA WP	GIFME, CA WP	2500	17500
GIFME, CA WP	HNNRY, CA WP	2500	17500
HNNRY, CA WP	*GRIDD, CA FIX	3400	17500
*4000 - MRA			
*2600 - MCA GRIDD, CA FIX , S BND			
GRIDD, CA FIX	TALUM, CA FIX	1800	17500
TALUM, CA FIX	JINGO, CA FIX	1900	17500
JINGO, CA FIX	GONGS, CA FIX	1800	17500
GONGS, CA FIX	HOMAN, CA FIX	4800	17500
HOMAN, CA FIX	GARSA, CA FIX	5500	17500
GARSA, CA FIX	CCAPS, CA WP	9000	17500
CCAPS, CA WP	MUREX, CA FIX	9500	17500
MUREX, CA FIX	MIXUP, OR FIX	8600	17500
MIXUP, OR FIX	PIIKZ, OR WP	8600	17500
PIIKZ, OR WP	TUPSE, OR WP	9400	17500
TUPSE, OR WP	DESCHUTES, OR VORTAC	6800	17500
DESCHUTES, OR VORTAC	HERBS, OR FIX	6300	17500
HERBS, OR FIX	CUPRI, OR FIX	6100	17500
CUPRI, OR FIX	SUPOC, OR WP	5500	17500
SUPOC, OR WP	KUKTE, OR FIX	6000	17500
KUKTE, OR FIX	VECCU, WA FIX	5500	17500
VECCU, WA FIX	SUNSN, WA WP	7000	17500
SUNSN, WA WP	MUDLE, WA FIX	7100	17500
MUDLE, WA FIX	YAKIMA, WA VORTAC	*5300	17500
*4800 - MOCA			
YAKIMA, WA VORTAC	SELAH, WA FIX	5400	17500
SELAH, WA FIX	GEBTE, WA FIX	6000	17500
GEBTE, WA FIX	LARDY, WA WP	6000	17500



FROM	TO	MEA	MAA
------	----	-----	-----

**95.3261 RNAV ROUTE T261 - CONTINUED**

LARDY, WA WP	QUINT, WA FIX	6400	17500
QUINT, WA FIX	KLSEY, WA WP	5200	17500
KLSEY, WA WP	PAWYO, WA WP	5100	17500
PAWYO, WA WP	HVAR, WA WP	5400	17500
HVAR, WA WP	SOFFE, WA WP	6500	17500
SOFFE, WA WP	JSTEN, WA WP	6900	17500

**95.3262 RNAV ROUTE T262**

KODIAK, AK VOR/DME	*WUXAN, AK WP	**6000	17500
*5200 - MCA WUXAN, AK WP , E BND			
**3800 - MOCA			
WUXAN, AK WP	JOHNSTONE POINT, AK VOR/DME	7000	17500

**95.3263 RNAV ROUTE T263**

FILLMORE, CA VORTAC	*DERBB, CA FIX	11000	17500
*7200 - MCA DERBB, CA FIX , SE BND			
DERBB, CA FIX	AVENAL, CA VOR/DME	6600	17500
AVENAL, CA VOR/DME	PANOCHE, CA VORTAC	7100	17500
PANOCHE, CA VORTAC	WINDY, CA FIX	6400	17500
WINDY, CA FIX	SMONE, CA WP	5700	17500
SMONE, CA WP	*MOVDD, CA WP	5700	17500
*4700 - MCA MOVDD, CA WP , SE BND			
MOVDD, CA WP	RBLEW, CA WP	3600	17500
RBLEW, CA WP	PITTS, CA FIX	3400	17500
PITTS, CA FIX	SCAGGS ISLAND, CA VORTAC	3400	17500
SCAGGS ISLAND, CA VORTAC	POPES, CA FIX	4800	17500
POPES, CA FIX	NAKPT, CA WP	5400	17500
NAKPT, CA WP	DIBLE, CA FIX	4800	17500
DIBLE, CA FIX	KENDL, CA FIX	*4900	17500
*3200 - MOCA			
KENDL, CA FIX	FOLDS, CA FIX	6900	17500
FOLDS, CA FIX	HOMEG, CA WP	10400	17500
HOMEG, CA WP	ZUNAS, CA FIX	9900	17500
ZUNAS, CA FIX	*TALEM, OR FIX	9500	17500
*9000 - MCA TALEM, OR FIX , S BND			
TALEM, OR FIX	*OREGN, OR WP	7800	17500
*6100 - MCA OREGN, OR WP , SE BND			
OREGN, OR WP	EROWY, OR WP	6000	17500
EROWY, OR WP	NOTTI, OR FIX	5400	17500
NOTTI, OR FIX	CORVALLIS, OR VOR/DME	4200	17500
CORVALLIS, OR VOR/DME	ARTTY, OR FIX	4000	17500
ARTTY, OR FIX	NEWBERG, OR VOR/DME	3900	17500
NEWBERG, OR VOR/DME	LOATH, OR FIX	4400	17500
LOATH, OR FIX	KELNG, WA WP	5200	17500
WINLO, WA FIX	ULESS, WA FIX	5400	17500
ULESS, WA FIX	MTLOK, WA WP	*5800	17500
*5200 - MOCA			
MTLOK, WA WP	*QUIIN, WA WP	7200	17500
*8100 - MCA QUIIN, WA WP , N BND			
QUIIN, WA WP	ARRIE, WA FIX	9100	17500
ARRIE, WA FIX	ELWHA, WA WP	8900	17500

**95.3264 RNAV ROUTE T264**

KODIAK, AK VOR/DME	ZAXUM, AK WP	*6000	17500
*4000 - MOCA			
ZAXUM, AK WP	MIDDLETON ISLAND, AK VOR/DME	*3000	17500
*2200 - MOCA			

FROM	TO	MEA	MAA
<b>95.3265 RNAV ROUTE T265</b>			
JAYBE, WI WP	GRIFT, IL WP	2800	10000
GRIFT, IL WP	START, IL FIX	2700	10000
START, IL FIX	MEITZ, IL FIX	2700	10000
MEITZ, IL FIX	COYAP, IL WP	2400	10000
COYAP, IL WP	MAPPS, IN FIX	2500	10000
MAPPS, IN FIX	KLROY, IN WP	2400	17500
KLROY, IN WP	SMUUV, MI WP	2600	17500
SMUUV, MI WP	GETCH, MI WP	2500	17500
GETCH, MI WP	*LADIN, MI FIX	4000	17500
*5000 - MRA			
LADIN, MI FIX	CARGA, MI FIX	3200	17500
CARGA, MI FIX	BUDHA, MI WP	3200	17500
BUDHA, MI WP	*RONDO, MI FIX	3200	17500
*5000 - MRA			
RONDO, MI FIX	PINES, MI FIX	2700	17500
<b>95.3266 RNAV ROUTE T266</b>			
U.S. CANADIAN BORDER	*AKCAP, AK WP	9100	17500
*8300 - MCA AKCAP, AK WP , N BND			
AKCAP, AK WP	ZEDEM, AK WP	8100	17500
ZEDEM, AK WP	*FEDMI, AK WP	8100	17500
*7900 - MCA FEDMI, AK WP , N BND			
FEDMI, AK WP	*BAVKE, AK WP	7400	17500
*7800 - MCA BAVKE, AK WP , SE BND			
BAVKE, AK WP	ROTVE, AK WP	8200	17500
ROTVE, AK WP	*WONOS, AK WP	8200	17500
*7600 - MCA WONOS, AK WP , NW BND			
WONOS, AK WP	COPOG, AK WP	7400	17500
COPOG, AK WP	*JAPOR, AK WP	6900	17500
*5800 - MCA JAPOR, AK WP , NW BND			
JAPOR, AK WP	*NIGPE, AK WP	5700	17500
*5000 - MCA NIGPE, AK WP , NW BND			
NIGPE, AK WP	GUMLE, AK WP	4500	17500
GUMLE, AK WP	ZONPU, AK WP	4200	17500
ZONPU, AK WP	*ZADED, AK WP	4300	17500
*5100 - MCA ZADED, AK WP , SE BND			
ZADED, AK WP	RADKY, AK FIX	6700	17500
RADKY, AK FIX	UNEKY, AK FIX	7000	17500
UNEKY, AK FIX	*XADZY, AK WP	6400	17500
*5900 - MCA XADZY, AK WP , NW BND			
XADZY, AK WP	VULHO, AK WP	5800	17500
VULHO, AK WP	*FOGID, AK WP	5300	17500
*4800 - MCA FOGID, AK WP , NW BND			
FOGID, AK WP	*YICAX, AK WP	4500	17500
*4800 - MCA YICAX, AK WP , SE BND			
YICAX, AK WP	NEREE, AK WP	5000	17500
NEREE, AK WP	*ZIDRA, AK WP	4900	17500
*4900 - MCA ZIDRA, AK WP , SE BND			
ZIDRA, AK WP	*VAZPU, AK WP	4900	17500
*5200 - MCA VAZPU, AK WP , SE BND			
VAZPU, AK WP	DOOZI, AK FIX	6200	17500
DOOZI, AK FIX	GIRTS, AK FIX	5300	17500
GIRTS, AK FIX	ANNETTE ISLAND, AK VOR/DME	5000	17500
<b>95.3267 RNAV ROUTE T267</b>			
NOME, AK VOR/DME	*BALIN, AK FIX	**8000	17500
*2300 - MCA BALIN, AK FIX , SW BND			
**5900 - MOCA			

FROM	TO	MEA	MAA
<b>95.3267 RNAV ROUTE T267 - CONTINUED</b>			
BALIN, AK FIX *2600 - MOCA	KOTZEBUE, AK VOR/DME	*3300	17500
KOTZEBUE, AK VOR/DME *2400 - MCA SICOV, AK WP , SE BND	*SICOV, AK WP	3900	17500
SICOV, AK WP *2600 - MCA HIBLA, AK WP , NW BND **2200 - MOCA	*HIBLA, AK WP	**5000	17500
HIBLA, AK WP *5300 - MCA UBASY, AK WP , N BND **5000 - MOCA	*UBASY, AK WP	**5500	17500
UBASY, AK WP *4100 - MCA PODKE, AK WP , S BND **5400 - MOCA	*PODK, AK WP	**6300	17500
PODK, AK WP	JODGU, AK WP	4000	17500
JODGU, AK WP *1300 - MOCA	ZISDU, AK WP	*2300	17500
<b>95.3268 RNAV ROUTE T268</b>			
TATOOSH, WA VORTAC	HEMER, WA WP	3800	17500
HEMER, WA WP	YUCSU, WA FIX	4500	17500
YUCSU, WA FIX	NOOEL, WA WP	4500	17500
NOOEL, WA WP	STVOH, WA WP	4400	17500
STVOH, WA WP	WATTR, WA FIX	2600	17500
WATTR, WA FIX *2400 - MOCA	LEION, WA WP	*3000	17500
LEION, WA WP *3500 - MCA AYURU, WA WP , E BND	*AYURU, WA WP	2000	17500
AYURU, WA WP	WOODI, WA FIX	5600	17500
WOODI, WA FIX	BANDR, WA FIX	7600	17500
BANDR, WA FIX *7200 - MCA TMBOB, WA WP , W BND	*TMBOB, WA WP	7800	17500
TMBOB, WA WP *6600 - MOCA	MERFF, WA WP	*6600	17500
MERFF, WA WP *5400 - MCA DOFDO, WA FIX , SW BND	*DOFDO, WA FIX	6800	17500
DOFDO, WA FIX	MOSES LAKE, WA VOR/DME	3400	17500
MOSES LAKE, WA VOR/DME	SUBDY, WA FIX	3700	17500
SUBDY, WA FIX	YICUB, WA FIX	4400	17500
YICUB, WA FIX *5300 - MCA SPOKANE, WA VORTAC , E BND	*SPOKANE, WA VORTAC	4800	17500
SPOKANE, WA VORTAC	HILIE, ID FIX	7400	17500
HILIE, ID FIX	MULLAN PASS, ID VOR/DME	9000	17500
MULLAN PASS, ID VOR/DME	ALTON, MT FIX	9400	17500
ALTON, MT FIX	MISSOULA, MT VOR/DME	8800	17500
MISSOULA, MT VOR/DME	BAMBE, MT FIX	9500	17500
BAMBE, MT FIX	PIXXI, MT FIX	10000	17500
PIXXI, MT FIX *10300 - MCA RICHD, MT FIX , W BND	*RICHD, MT FIX	10600	17500
RICHD, MT FIX	HELENA, MT VORTAC	9700	17500
HELENA, MT VORTAC	SWEDD, MT FIX	10000	17500
SWEDD, MT FIX	CONNS, MT FIX	10800	17500
CONNS, MT FIX	NUKUW, MT FIX	10000	17500
NUKUW, MT FIX *10000 - MCA SUBKY, MT FIX , W BND	*SUBKY, MT FIX	11700	17500
SUBKY, MT FIX *7200 - MCA REEPO, MT FIX , W BND	*REEPO, MT FIX	8300	17500
REEPO, MT FIX	COLUS, MT FIX	6900	17500
COLUS, MT FIX	BILLINGS, MT VORTAC	6500	17500

FROM	TO	MEA	MAA
<b>95.3268 RNAV ROUTE T268 - CONTINUED</b>			
BILLINGS, MT VORTAC	MILES CITY, MT VOR/DME	5800	17500
MILES CITY, MT VOR/DME	QATSA, ND FIX	5200	17500
QATSA, ND FIX	DICKINSON, ND VORTAC	*4700	17500
*4200 - MOCA			
DICKINSON, ND VORTAC	BISMARCK, ND VOR/DME	4500	17500
<b>95.3269 RNAV ROUTE T269</b>			
ANNETTE ISLAND, AK VOR/DME	TURTY, AK WP	5600	17500
TURTY, AK WP	TOKEE, AK FIX	4800	17500
TOKEE, AK FIX	AKCAR, AK WP	4700	17500
AKCAR, AK WP	FLIPS, AK FIX	*5600	17500
*5100 - MOCA			
FLIPS, AK FIX	BIORKA ISLAND, AK VORTAC	5300	17500
BIORKA ISLAND, AK VORTAC	SALIS, AK FIX	*4900	17500
*4400 - MOCA			
SALIS, AK FIX	*HAPIT, AK FIX	**1700	17500
*15000 - MRA			
**1200 - MOCA			
HAPIT, AK FIX	*CENTA, AK FIX	**2200	17500
*1700 - MCA CENTA, AK FIX , NW BND			
**1200 - MOCA			
CENTA, AK FIX	*YAKUTAT, AK VOR/DME	2400	17500
*2400 - MCA YAKUTAT, AK VOR/DME , W BND			
YAKUTAT, AK VOR/DME	*MALAS, AK FIX	2700	17500
*2800 - MCA MALAS, AK FIX , W BND			
MALAS, AK FIX	*OXIDS, AK WP	2800	17500
*2200 - MCA OXIDS, AK WP , E BND			
OXIDS, AK WP	FOGNU, AK WP	2000	17500
FOGNU, AK WP	*HORG, AK WP	2800	17500
*2500 - MCA HORG, AK WP , E BND			
HORG, AK WP	*ZIXIM, AK WP	2400	17500
*2500 - MCA ZIXIM, AK WP , W BND			
ZIXIM, AK WP	JOVOM, AK WP	3700	17500
JOVOM, AK WP	OXUGE, AK WP	3700	17500
OXUGE, AK WP	*KATAT, AK FIX	5200	17500
*4900 - MCA KATAT, AK FIX , E BND			
KATAT, AK FIX	CASEL, AK FIX	4700	17500
CASEL, AK FIX	*JOHNSTONE POINT, AK VOR/DME	5100	17500
*5000 - MCA JOHNSTONE POINT, AK VOR/DME , E BND			
JOHNSTONE POINT, AK VOR/DME	*FIMIB, AK WP	4000	17500
*5200 - MCA FIMIB, AK WP , W BND			
FIMIB, AK WP	*ANCHORAGE, AK VOR/DME	8800	17500
*6200 - MCA ANCHORAGE, AK VOR/DME , E BND			
ANCHORAGE, AK VOR/DME	*YONEK, AK FIX	3000	17500
*6000 - MCA YONEK, AK FIX , W BND			
YONEK, AK FIX	*TORTE, AK FIX	5000	17500
*8700 - MCA TORTE, AK FIX , W BND			
TORTE, AK FIX	*VEILL, AK FIX	10400	17500
*8000 - MCA VEILL, AK FIX , E BND			
VEILL, AK FIX	*FAMEK, AK WP	7200	17500
*7200 - MCA FAMEK, AK WP , E BND			
FAMEK, AK WP	SPARREVOHN, AK VOR/DME	*6600	17500
*6000 - MOCA			
SPARREVOHN, AK VOR/DME	ACRAN, AK FIX	5500	17500
ACRAN, AK FIX	ZOKAM, AK WP	5200	17500
ZOKAM, AK WP	*VIDDA, AK FIX	5900	17500
*3100 - MCA VIDDA, AK FIX , E BND			
VIDDA, AK FIX	BETHEL, AK VORTAC	2500	17500

FROM	TO	MEA	MAA
<b>95.3269 RNAV ROUTE T269 - CONTINUED</b>			
BETHEL, AK VORTAC *1500 - MOCA	MKLUK, AK WP	*3200	17500
<b>95.3270 RNAV ROUTE T270</b>			
NORTON BAY, AK NDB *5400 - MOCA	HEXOG, AK WP	*6000	17500
HEXOG, AK WP	SHISHMAREF, AK NDB	5000	17500
<b>95.3271 RNAV ROUTE T271</b>			
COLD BAY, AK VORTAC	BINAL, AK FIX	4400	17500
BINAL, AK FIX	KING SALMON, AK VORTAC	2700	17500
KING SALMON, AK VORTAC	JIVCO, AK WP	3000	17500
JIVCO, AK WP	WOLCI, AK WP	4000	17500
WOLCI, AK WP	*WIDVA, AK WP	7000	17500
*8000 - MCA WIDVA, AK WP , NE BND			
WIDVA, AK WP	*ZINAM, AK WP	11800	17500
*10700 - MCA ZINAM, AK WP , SW BND			
ZINAM, AK WP	AMOTT, AK FIX	2500	17500
<b>95.3272 RNAV ROUTE T272</b>			
HALLSVILLE, MO VORTAC	VANDALIA, IL VOR/DME	2700	6000
<b>95.3273 RNAV ROUTE T273</b>			
FAIRBANKS, AK VORTAC	AYKID, AK FIX	6700	17500
AYKID, AK FIX	TUVVO, AK FIX	6400	17500
TUVVO, AK FIX	*SOTGE, AK WP	11300	17500
*8000 - MCA SOTGE, AK WP , S BND			
SOTGE, AK WP	ROCES, AK WP	*4000	17500
*2800 - MOCA			
<b>95.3274 RNAV ROUTE T274</b>			
NEWPORT, OR VORTAC	WESHH, OR WP	4200	17500
WESHH, OR WP	CRAAF, OR FIX	4500	17500
CRAAF, OR FIX	JAIME, OR FIX	6100	17500
JAIME, OR FIX	*DBLEY, OR WP	8000	17500
*8200 - MCA DBLEY, OR WP , E BND			
DBLEY, OR WP	MMDSN, OR WP	10000	17500
MMDSN, OR WP	MMASN, OR WP	9000	17500
MMASN, OR WP	POCIT, OR FIX	9000	17500
POCIT, OR FIX	GIFRD, OR WP	9000	17500
GIFRD, OR WP	FASAB, OR WP	10000	17500
FASAB, OR WP	NUSME, CA WP	10000	17500
NUSME, CA WP	RUFUS, CA WP	10100	17500
RUFUS, CA WP	DUCCS, NV WP	10100	17500
DUCCS, NV WP	SEDTO, NV FIX	*10200	17500
*9200 - MOCA			
SEDTO, NV FIX	MUSTANG, NV VORTAC	11000	17500
MUSTANG, NV VORTAC	*YERIN, NV FIX	10000	17500
*10400 - MCA YERIN, NV FIX , SE BND			
YERIN, NV FIX	SCOLA, NV WP	11400	17500
SCOLA, NV WP	BABIT, NV FIX	*10800	17500
*10100 - MOCA			
BABIT, NV FIX	COALDALE, NV VORTAC	10500	17500
COALDALE, NV VORTAC	LIDAT, NV FIX	10000	17500

FROM	TO	MEA	MAA
<b>95.3275 RNAV ROUTE T275</b>			
ZIKNI, AK WP *3600 - MOCA	BETHEL, AK VORTAC	*5900	17500
BETHEL, AK VORTAC *3200 - MOCA	DAVBE, AK WP	*5900	17500
DAVBE, AK WP *4700 - MOCA	YELLW, AK WP	*5900	17500
YELLW, AK WP *5100 - MOCA	VUSUY, AK FIX	*5900	17500
VUSUY, AK FIX *4400 - MOCA	JERDN, AK WP	*5900	17500
JERDN, AK WP *4000 - MOCA	UNALAKLEET, AK VOR/DME	*5900	17500
<b>95.3276 RNAV ROUTE T276</b>			
WAVLU, WA FIX	WINLO, WA FIX	5400	17500
WINLO, WA FIX	COUGA, WA FIX	5100	17500
COUGA, WA FIX *6500 - MOCA	CARBY, WA FIX	*7000	17500
CARBY, WA FIX	VECCU, WA FIX	7000	17500
VECCU, WA FIX	HUNGR, WA WP	5600	17500
HUNGR, WA WP	LAYTN, WA WP	5000	17500
LAYTN, WA WP	WALLA WALLA, WA VOR/DME	4500	17500
WALLA WALLA, WA VOR/DME	RENGO, WA FIX	6400	17500
RENGO, WA FIX	SEVER, WA FIX	7200	17500
POTOR, WA FIX *5600 - MOCA	CUPEV, ID FIX	*6100	17500
CUPEV, ID FIX	HENVO, ID WP	6300	17500
HENVO, ID WP	OFINO, ID FIX	6300	17500
OFINO, ID FIX	JIROS, MT FIX	9800	17500
JIROS, MT FIX	MISSOULA, MT VOR/DME	9500	17500
MISSOULA, MT VOR/DME *10200 - MOCA	ARSHO, MT WP	*10700	17500
ARSHO, MT WP *10000 - MCA BRCKN, MT WP , SW BND	*BRCKN, MT WP	11600	17500
BRCKN, MT WP	FRYMN, MT FIX	8300	17500
FRYMN, MT FIX *6600 - MOCA	YOGOS, MT FIX	*8000	17500
YOGOS, MT FIX	EVBUJ, MT WP	8500	17500
EVBUJ, MT WP	ITEVE, MT WP	8000	17500
ITEVE, MT WP *5200 - MCA WUDEY, MT WP , W BND	*WUDEY, MT WP	8000	17500
WUDEY, MT WP	GLASGOW, MT VOR/DME	5000	17500
<b>95.3277 RNAV ROUTE T277</b>			
BETTLES, AK VOR/DME *4000 - MOCA	JIGTI, AK WP	*6000	17500
JIGTI, AK WP *7000 - MOCA	NOKFE, AK WP	*8000	17500
NOKFE, AK WP *9400 - MOCA	VOVUY, AK WP	*10300	17500
VOVUY, AK WP *9500 - MOCA	EPEHO, AK WP	*16000	17500
EPEHO, AK WP *5500 - MOCA	POINT LAY, AK NDB	*6400	17500
<b>95.3278 RNAV ROUTE T278</b>			
*HAPIT, AK FIX *15000 - MRA **4300 - MCA CSPER, AK FIX , NE BND	**CSPER, AK FIX	4000	17500

FROM	TO	MEA	MAA
<b>95.3278 RNAV ROUTE T278 - CONTINUED</b>			
CSPER, AK FIX	BIKUW, AK WP	4800	17500
BIKUW, AK WP	SISTERS ISLAND, AK VORTAC	4400	17500
SISTERS ISLAND, AK VORTAC	RADKY, AK FIX	6700	17500
<b>95.3279 RNAV ROUTE T279</b>			
ALEUT, AK WP	BETHEL, AK VORTAC	3200	17500
<b>95.3280 RNAV ROUTE T280</b>			
FLIPS, AK FIX	LEVEL ISLAND, AK VOR/DME	*7000	17500
*6300 - MOCA			
<b>95.3281 RNAV ROUTE T281</b>			
*YOZLE, NE FIX	BOKKI, NE FIX	4700	17500
*7000 - MRA			
BOKKI, NE FIX	AINSWORTH, NE VOR/DME	4600	17500
AINSWORTH, NE VOR/DME	LKOTA, SD WP	4400	17500
LKOTA, SD WP	PIERRE, SD VORTAC	4300	17500
<b>95.3282 RNAV ROUTE T282</b>			
VENCE, AK FIX	HORSI, AK FIX	5000	17500
HORSI, AK FIX	PERZO, AK WP	4700	17500
PERZO, AK WP	FAIRBANKS, AK VORTAC	4300	17500
<b>95.3283 RNAV ROUTE T283</b>			
SCOTTSBLUFF, NE VORTAC	GORDON, NE NDB	6300	17500
GORDON, NE NDB	WNDED, SD WP	*5500	17500
*5000 - MOCA			
WNDED, SD WP	PIERRE, SD VORTAC	5000	17500
<b>95.3285 RNAV ROUTE T285</b>			
NORTH PLATTE, NE VOR/DME	THEDFORD, NE VOR/DME	5000	17500
THEDFORD, NE VOR/DME	MARSS, NE FIX	4900	17500
MARSS, NE FIX	VALENTINE, NE NDB	4800	17500
VALENTINE, NE NDB	LKOTA, SD WP	4500	17500
LKOTA, SD WP	LESNR, SD WP	4300	17500
LESNR, SD WP	HURON, SD DME	4000	17500
<b>95.3286 RNAV ROUTE T286</b>			
RAPID CITY, SD VORTAC	GORDON, NE NDB	5700	17500
GORDON, NE NDB	EFFEX, NE FIX	5600	17500
EFFEX, NE FIX	THEDFORD, NE VOR/DME	5400	17500
THEDFORD, NE VOR/DME	BOKKI, NE FIX	4900	17500
BOKKI, NE FIX	GRAND ISLAND, NE VOR/DME	4600	17500
GRAND ISLAND, NE VOR/DME	PAWNEE CITY, NE VORTAC	3600	17500
PAWNEE CITY, NE VORTAC	ROBINSON, KS DME	3100	17500
ROBINSON, KS DME	BOWLR, KS FIX	2900	17500
<b>95.3287 RNAV ROUTE T287</b>			
DENNN, VA WP	CAARY, VA WP	*5200	10000
*3400 - MOCA			

FROM	TO	MEA	MAA
<b>95.3287 RNAV ROUTE T287 - CONTINUED</b>			
CAARY, VA WP *6100 - MOCA	WILMY, VA WP	*6900	10000
WILMY, VA WP *4900 - MOCA	KAIJE, VA WP	*5400	10000
KAIJE, VA WP	BAMMY, WV WP	5500	10000
BAMMY, WV WP *4300 - MOCA	REEES, PA WP	*5000	10000
REEES, PA WP *3800 - MOCA	TOMYD, MD WP	*5000	10000
<b>95.3288 RNAV ROUTE T288</b>			
GILLETTE, WY VOR/DME	TRTTL, WY WP	7000	17500
TRTTL, WY WP	KARAS, WY FIX	9000	17500
KARAS, WY FIX *9700 - MRA	*PACTO, SD FIX	10000	17500
PACTO, SD FIX	RAPID CITY, SD VORTAC	7100	17500
RAPID CITY, SD VORTAC	WNDED, SD WP	5000	17500
WNDED, SD WP	VALENTINE, NE NDB	5000	17500
VALENTINE, NE NDB *4200 - MOCA	AINSWORTH, NE VOR/DME	*4700	17500
AINSWORTH, NE VOR/DME	FESNT, NE WP	4500	17500
FESNT, NE WP	WOLBACH, NE VORTAC	4300	17500
<b>95.3290 RNAV ROUTE T290</b>			
HABJE, MS FIX	MERIDIAN, MS VORTAC	2300	17500
MERIDIAN, MS VORTAC	KWANE, MS WP	2400	17500
KWANE, MS WP	RABEC, AL WP	2300	17500
RABEC, AL WP	MONTGOMERY, AL VORTAC	2000	17500
MONTGOMERY, AL VORTAC *3400 - MCA SCAIL, AL WP , E BND	*SCAIL, AL WP	2600	17500
SCAIL, AL WP	BBAIT, GA WP	4000	17500
BBAIT, GA WP	BBASS, GA WP	3500	17500
BBASS, GA WP	BBOAT, GA WP	2500	17500
BBOAT, GA WP	BOBBR, GA WP	2400	17500
BOBBR, GA WP	JACET, GA WP	2400	17500
<b>95.3291 RNAV ROUTE T291</b>			
LOUIE, MD FIX *1800 - MOCA	BAABS, MD WP	*5000	11000
BAABS, MD WP *3000 - MOCA	HARRISBURG, PA VORTAC	*5000	11000
HARRISBURG, PA VORTAC	SELINGROVE, PA VOR/DME	3300	17500
SELINGROVE, PA VOR/DME	MILTON, PA VORTAC	3200	17500
MILTON, PA VORTAC	MEGSS, PA FIX	3500	17500
MEGSS, PA FIX	LAAYK, PA FIX	4000	17500
LAAYK, PA FIX	DELANCEY, NY VOR/DME	4400	17500
DELANCEY, NY VOR/DME	ALBANY, NY VORTAC	5600	17500
<b>95.3292 RNAV ROUTE T292</b>			
SEMMES, AL VORTAC	ANTUH, AL WP	2000	17500
ANTUH, AL WP	JANES, AL WP	2000	17500
JANES, AL WP	KWANE, MS WP	2300	17500
KWANE, MS WP	EUTAW, AL FIX	2000	17500
EUTAW, AL FIX	MOVIL, AL WP	2300	17500
MOVIL, AL WP	BROOKWOOD, AL VORTAC	2500	17500



FROM	TO	MEA	MAA
<b>95.3292 RNAV ROUTE T292 - CONTINUED</b>			
BROOKWOOD, AL VORTAC	VLKNN, AL WP	2500	17500
VLKNN, AL WP	HOKES, AL FIX	3200	17500
HOKES, AL FIX	MAYES, AL FIX	2900	17500
MAYES, AL FIX	RKMRT, GA WP	3600	17500
RKMRT, GA WP	POLL, GA WP	2900	17500
POLL, GA WP	CCATT, GA WP	3600	17500
CCATT, GA WP	REELL, GA WP	3700	17500
REELL, GA WP	TRREE, GA WP	2600	17500
TRREE, GA WP	JACET, GA WP	2400	17500
<b>95.3293 RNAV ROUTE T293</b>			
CHUTT, AL WP	NFTRY, GA WP	2500	17500
NFTRY, GA WP	RTLRY, GA WP	3200	17500
RTLRY, GA WP	HONRR, GA WP	3300	17500
HONRR, GA WP	POLL, GA WP	3300	17500
POLL, GA WP	DAISI, GA WP	4700	17500
<b>95.3294 RNAV ROUTE T294</b>			
HABJE, MS FIX	MERIDIAN, MS VORTAC	2300	17500
MERIDIAN, MS VORTAC	BOYDD, AL WP	2300	17500
BOYDD, AL WP	CRMSN, AL WP	2000	17500
CRMSN, AL WP	VLKNN, AL WP	2500	17500
VLKNN, AL WP	JOTAV, AL FIX	3300	17500
JOTAV, AL FIX	DEGAA, AL WP	2700	17500
DEGAA, AL WP	HEFIN, AL FIX	3400	17500
HEFIN, AL FIX	BBAIT, GA WP	4000	17500
BBAIT, GA WP	JMPPR, GA WP	3500	17500
JMPPR, GA WP	GRANT, GA FIX	3000	17500
<b>95.3295 RNAV ROUTE T295</b>			
LOUIE, MD FIX	BAABS, MD WP	*5000	11000
*1800 - MOCA			
BAABS, MD WP	LANCASTER, PA VOR/DME	*5000	11000
*2400 - MOCA			
LANCASTER, PA VOR/DME	WILKES-BARRE, PA VORTAC	4000	17500
WILKES-BARRE, PA VORTAC	LAAYK, PA FIX	4000	17500
LAAYK, PA FIX	SAGES, NY FIX	6400	17500
SAGES, NY FIX	SASHA, MA FIX	6100	17500
SASHA, MA FIX	KEYNN, NH WP	4200	17500
KEYNN, NH WP	CONCORD, NH VOR/DME	5000	17500
CONCORD, NH VOR/DME	KENNEBUNK, ME VOR/DME	3000	17500
KENNEBUNK, ME VOR/DME	BRNNS, ME FIX	3000	17500
BRNNS, ME FIX	BANGOR, ME VORTAC	3000	17500
BANGOR, ME VORTAC	LAUDS, ME WP	2800	17500
LAUDS, ME WP	HULTN, ME WP	2500	17500
HULTN, ME WP	PRESQUE ISLE, ME VOR/DME	3000	17500
<b>95.3296 RNAV ROUTE T296</b>			
JMPPR, GA WP	BBASS, GA WP	3000	17500
BBASS, GA WP	TATRS, GA WP	2500	17500
TATRS, GA WP	TACKL, GA WP	2500	17500
<b>95.3297 RNAV ROUTE T297</b>			
PAIRA, GA WP	NFTRY, GA WP	3400	17500

FROM	TO	MEA	MAA
<b>95.3297 RNAV ROUTE T297 - CONTINUED</b>			
NFTRY, GA WP	HEFIN, AL FIX	3400	17500
HEFIN, AL FIX	RKMRT, GA WP	3200	17500
RKMRT, GA WP	CHTTE, GA WP	2900	17500
CHTTE, GA WP	DAISI, GA WP	4000	17500
DAISI, GA WP	AWSON, GA FIX	5000	17500
AWSON, GA FIX	REELL, GA WP	3300	17500
<b>95.3298 RNAV ROUTE T298</b>			
OAKLAND, CA VOR/DME	*SALAD, CA FIX	4300	17500
*4800 - MCA SALAD, CA FIX , E BND			
SALAD, CA FIX	*ALTAM, CA FIX	5000	17500
*4600 - MCA ALTAM, CA FIX , W BND			
ALTAM, CA FIX	*RBLEW, CA WP	4400	17500
*2700 - MCA RBLEW, CA WP , W BND			
RBLEW, CA WP	ORANG, CA FIX	1800	17500
ORANG, CA FIX	*EVETT, CA WP	1800	17500
*2500 - MCA EVETT, CA WP , E BND			
EVETT, CA WP	*ELKHN, CA WP	6300	17500
*7500 - MCA ELKHN, CA WP , E BND			
ELKHN, CA WP	*SMURA, CA WP	9600	17500
*11700 - MCA SMURA, CA WP , E BND			
SMURA, CA WP	*NIKOL, CA FIX	14600	17500
*12200 - MCA NIKOL, CA FIX , W BND			
NIKOL, CA FIX	COALDALE, NV VORTAC	11700	17500
COALDALE, NV VORTAC	KATTS, NV WP	11400	17500
KATTS, NV WP	KITTN, NV WP	13300	17500
KITTN, NV WP	WILSON CREEK, NV VORTAC	11600	17500
WILSON CREEK, NV VORTAC	WOOOP, UT WP	11900	17500
WOOOP, UT WP	MILFORD, UT VORTAC	11700	17500
MILFORD, UT VORTAC	*DETAN, UT FIX	11900	17500
*12700 - MCA DETAN, UT FIX , NE BND			
DETAN, UT FIX	EBOVE, UT WP	13400	17500
EBOVE, UT WP	CARBON, UT VOR/DME	13200	17500
CARBON, UT VOR/DME	MYTON, UT VOR/DME	11700	17500
MYTON, UT VOR/DME	ROCK SPRINGS, WY VOR/DME	13700	17500
ROCK SPRINGS, WY VOR/DME	DORTN, WY WP	10500	17500
DORTN, WY WP	CRAZY WOMAN, WY VOR/DME	9300	17500
<b>95.3299 RNAV ROUTE T299</b>			
UCREK, VA WP	KAIJE, VA WP	5000	10000
KAIJE, VA WP	BAMMY, WV WP	5500	10000
BAMMY, WV WP	REEES, PA WP	*5000	10000
*4300 - MOCA			
REEES, PA WP	SCAPE, PA FIX	*5000	10000
*3800 - MOCA			
<b>95.3300 RNAV ROUTE T300</b>			
SSENA, NY WP	STANK, NY WP	4100	17500
STANK, NY WP	JONNN, NY FIX	4600	17500
JONNN, NY FIX	*UUBER, NY WP	4500	17500
*5300 - MCA UUBER, NY WP , S BND			
UUBER, NY WP	*OPDIE, NY WP	5800	17500
*6600 - MCA OPDIE, NY WP , S BND			
OPDIE, NY WP	GASSY, NY WP	7500	17500
GASSY, NY WP	*OTOLE, NY WP	4900	17500
*2800 - MCA OTOLE, NY WP , N BND			

FROM	TO	MEA	MAA
<b>95.3300 RNAV ROUTE T300 - CONTINUED</b>			
OTOLE, NY WP	ALBANY, NY VORTAC	2200	17500
ALBANY, NY VORTAC	*CANAN, NY FIX	3400	17500
*3600 - MCA CANAN, NY FIX , SE BND			
CANAN, NY FIX	SHIGY, MA FIX	3900	17500
SHIGY, MA FIX	STELA, MA FIX	4000	17500
STELA, MA FIX	MOLDS, MA FIX	3900	17500
MOLDS, MA FIX	TOMES, MA FIX	3500	17500
TOMES, MA FIX	COBOL, MA FIX	3300	17500
COBOL, MA FIX	NELIE, CT FIX	3100	17500
NELIE, CT FIX	WIPOR, CT FIX	2600	17500
WIPOR, CT FIX	YANTC, CT WP	*2300	17500
*1900 - MOCA			
YANTC, CT WP	LAFAY, RI FIX	2300	17500
LAFAY, RI FIX	MINNK, RI FIX	2000	17500
MINNK, RI FIX	NEWBE, RI FIX	*2000	17500
*1200 - MOCA			
NEWBE, RI FIX	DEEPO, MA FIX	2000	17500
<b>95.3301 RNAV ROUTE T301</b>			
CAPE GIRARDEAU, MO DME	CENTRALIA, IL VORTAC	3500	17500
CENTRALIA, IL VORTAC	TYMME, IL WP	2400	17500
TYMME, IL WP	SPINNER, IL VORTAC	2500	17500
SPINNER, IL VORTAC	PEORIA, IL VORTAC	2400	17500
<b>95.3302 RNAV ROUTE T302</b>			
CUKIS, OR WP	JJACE, OR WP	7300	17500
JJACE, OR WP	JJETT, OR WP	8000	17500
JJETT, OR WP	JERMM, OR WP	8000	17500
JERMM, OR WP	CUPRI, OR FIX	*6600	17500
*5900 - MOCA			
CUPRI, OR FIX	ZUDMI, OR WP	*9000	17500
*8200 - MOCA			
ZUDMI, OR WP	DRYLD, OR WP	9100	17500
DRYLD, OR WP	WILDHORSE, OR VOR/DME	9000	17500
WILDHORSE, OR VOR/DME	JOSTN, OR WP	8100	17500
JOSTN, OR WP	*UKAYI, OR WP	8000	17500
*5500 - MCA UKAYI, OR WP , SW BND			
UKAYI, OR WP	PARMO, ID FIX	5000	17500
PARMO, ID FIX	*ADEXE, ID WP	5000	17500
*5400 - MCA ADEXE, ID WP , E BND			
ADEXE, ID WP	*ALKAL, ID FIX	7000	17500
*6200 - MCA ALKAL, ID FIX , W BND			
ALKAL, ID FIX	FEVDO, ID WP	6000	17500
FEVDO, ID WP	TOXEE, ID FIX	6100	17500
TOXEE, ID FIX	JADUP, ID WP	7000	17500
JADUP, ID WP	*MRILE, ID WP	9100	17500
*10200 - MCA MRILE, ID WP , E BND			
MRILE, ID WP	RAMMM, ID WP	11000	17500
RAMMM, ID WP	MIKAE, WY WP	11700	17500
MIKAE, WY WP	BXTER, WY WP	11700	17500
BXTER, WY WP	EEBEE, WY WP	*10000	17500
*8700 - MOCA			
EEBEE, WY WP	REGVE, WY WP	10200	17500
REGVE, WY WP	ROCK SPRINGS, WY VOR/DME	10200	17500
ROCK SPRINGS, WY VOR/DME	FIKLA, WY WP	10000	17500
FIKLA, WY WP	MEDICINE BOW, WY VOR/DME	10000	17500
MEDICINE BOW, WY VOR/DME	*ZIKRU, NE FIX	10000	17500
*7400 - MCA ZIKRU, NE FIX , W BND			

FROM	TO	MEA	MAA
------	----	-----	-----

**95.3302 RNAV ROUTE T302 - CONTINUED**

ZIKRU, NE FIX	SCOTTSBLUFF, NE VORTAC	6700	17500
SCOTTSBLUFF, NE VORTAC	WAKPA, NE WP	6000	17500
WAKPA, NE WP	ALLIANCE, NE VOR/DME	6000	17500
ALLIANCE, NE VOR/DME	EVENN, NE FIX	6000	17500
EFFEX, NE FIX	MARSS, NE FIX	5400	17500
MARSS, NE FIX	PUKFA, NE WP	4800	17500
PUKFA, NE WP	GIYED, NE FIX	4600	17500
GIYED, NE FIX	LLUKY, NE WP	3900	17500
LLUKY, NE WP	ROKKK, IA WP	4400	17500
ROKKK, IA WP	WATERLOO, IA VOR/DME	3000	17500
WATERLOO, IA VOR/DME	DUBUQUE, IA VORTAC	2900	17500
DUBUQUE, IA VORTAC	JOOLZ, IL WP	*2900	17500
*2500 - MOCA			
JOOLZ, IL WP	GRIFT, IL WP	3000	17500

**95.3305 RNAV ROUTE T305**

CAPE GIRARDEAU, MO DME	AMART, IL WP	3300	17500
AMART, IL WP	TYMME, IL WP	2400	17500
TYMME, IL WP	DELCO, IL FIX	2400	17500
DELCO, IL FIX	JIBKA, IN WP	2400	17500

**95.3306 RNAV ROUTE T306**

LOS ANGELES, CA VORTAC	PRADO, CA FIX	4000	17500
PRADO, CA FIX	PARADISE, CA VORTAC	5000	17500
PARADISE, CA VORTAC	*SETER, CA FIX	5500	17500
*12100 - MCA SETER, CA FIX , E BND			
SETER, CA FIX	BANDS, CA FIX	9000	17500
BANDS, CA FIX	*PALM SPRINGS, CA VORTAC	13000	17500
*11800 - MCA PALM SPRINGS, CA VORTAC , W BND			
PALM SPRINGS, CA VORTAC	BLYTHE, CA VORTAC	8000	17500
BLYTHE, CA VORTAC	BUCKEYE, AZ VORTAC	6000	17500
BUCKEYE, AZ VORTAC	PERKY, AZ FIX	5000	17500
PERKY, AZ FIX	PHOENIX, AZ VORTAC	4000	17500
PHOENIX, AZ VORTAC	*TOTEC, AZ FIX	5000	17500
*5500 - MCA TOTEC, AZ FIX , E BND			
TOTEC, AZ FIX	TUCSON, AZ VORTAC	6500	17500
TUCSON, AZ VORTAC	NOCHI, AZ WP	10700	17500
NOCHI, AZ WP	ANIMA, NM FIX	10700	17500
ANIMA, NM FIX	DARCE, NM FIX	9000	17500
DARCE, NM FIX	COLUMBUS, NM VOR/DME	*9000	17500
*8200 - MOCA			
COLUMBUS, NM VOR/DME	EL PASO, TX VORTAC	9000	17500

**95.3308 RNAV ROUTE T308**

EMMONAK, AK VOR/DME	WEREL, AK WP	5000	17500
---------------------	--------------	------	-------

**95.3310 RNAV ROUTE T310**

TUCSON, AZ VORTAC	*SULLI, AZ FIX	**8000	17500
*9200 - MCA SULLI, AZ FIX , E BND			
**7200 - MOCA			
SULLI, AZ FIX	MESCA, AZ FIX	10000	17500
MESCA, AZ FIX	NOCHI, AZ WP	10000	17500
NOCHI, AZ WP	SAN SIMON, AZ VORTAC	10000	17500
SAN SIMON, AZ VORTAC	SILVER CITY, NM VOR/DME	10300	17500
SILVER CITY, NM VOR/DME	*KEAPS, NM FIX	10300	17500
*11600 - MCA KEAPS, NM FIX , NE BND			

FROM	TO	MEA	MAA
------	----	-----	-----

**95.3310 RNAV ROUTE T310 - CONTINUED**

KEAPS, NM FIX	TRUTH OR CONSEQUENCES, NM VORTAC	12300	17500
---------------	----------------------------------	-------	-------

**95.3312 RNAV ROUTE T312**

HILL CITY, KS VORTAC	MOZEE, KS WP	4400	17500
MOZEE, KS WP	HUTCHINSON, KS VOR/DME	3800	17500
HUTCHINSON, KS VOR/DME	DROOP, MO WP	3500	17500
DROOP, MO WP	DOGWOOD, MO VORTAC	3300	17500
DOGWOOD, MO VORTAC	FARMINGTON, MO VORTAC	3400	17500
FARMINGTON, MO VORTAC	JEDPA, IL WP	2900	17500
JEDPA, IL WP	POCKET CITY, IN VORTAC	2300	17500

**95.3314 RNAV ROUTE T314**

BARNES, MA VORTAC	FAIDS, MA FIX	2900	17500
FAIDS, MA FIX	PUDGY, MA FIX	2800	17500
PUDGY, MA FIX	GARDNER, MA VOR/DME	3000	17500
GARDNER, MA VOR/DME	JOHNZ, NH FIX	3500	17500
JOHNZ, NH FIX	MANCH, NH WP	*2600	17500
*2100 - MOCA			
MANCH, NH WP	KHRIS, NH FIX	2300	17500
KHRIS, NH FIX	RAYMY, NH FIX	*2600	17500
*2100 - MOCA			
RAYMY, NH FIX	YUKES, NH WP	2300	17500
YUKES, NH WP	KENNEBUNK, ME VOR/DME	2600	17500

**95.3315 RNAV ROUTE T315**

HARTFORD, CT VOR/DME	DVANY, CT FIX	2700	17500
DVANY, CT FIX	DARTH, CT WP	2700	17500
DARTH, CT WP	WITNY, MA FIX	*3000	17500
*2500 - MOCA			
WITNY, MA FIX	SPENO, MA FIX	2900	17500
SPENO, MA FIX	GARDNER, MA VOR/DME	3000	17500
GARDNER, MA VOR/DME	*KEYNN, NH WP	3600	17500
*3900 - MCA KEYNN, NH WP , N BND			
KEYNN, NH WP	JAMMA, VT WP	4400	17500
JAMMA, VT WP	*EBERT, VT WP	5600	17500
*6100 - MCA EBERT, VT WP , N BND			
EBERT, VT WP	MUDDI, VT WP	6400	17500
MUDDI, VT WP	BURLINGTON, VT VOR/DME	6000	17500

**95.3316 RNAV ROUTE T316**

LAMMS, NY WP	*ROOMS, NY WP	3900	17500
*3900 - MCA ROOMS, NY WP , W BND			
ROOMS, NY WP	PAYGE, NY WP	3500	17500
PAYGE, NY WP	GALWA, NY FIX	2900	17500
GALWA, NY FIX	ETZUN, NY WP	3000	17500
ETZUN, NY WP	*CAMBRIDGE, NY VOR/DME	3300	17500
*5000 - MCA CAMBRIDGE, NY VOR/DME , E BND			
CAMBRIDGE, NY VOR/DME	DORIS, VT FIX	6000	17500
DORIS, VT FIX	*BRATS, VT WP	6000	17500
*4700 - MCA BRATS, VT WP , W BND			
BRATS, VT WP	STRUM, NH WP	4100	17500
STRUM, NH WP	*DUBIN, NH WP	4800	17500
*4400 - MCA DUBIN, NH WP , W BND			
DUBIN, NH WP	*MUGGY, NH FIX	**4000	17500
*3100 - MCA MUGGY, NH FIX , W BND			
**3500 - MOCA			

FROM	TO	MEA	MAA
<b>95.3316 RNAV ROUTE T316 - CONTINUED</b>			
MUGGY, NH FIX	BASUU, NH FIX	3000	17500
BASUU, NH FIX	MANCH, NH WP	2600	17500
<b>95.3317 RNAV ROUTE T317</b>			
NEWMAN, TX VORTAC	*MOLLY, NM FIX	8900	17500
*10000 - MRA			
*7700 - MCA MOLLY, NM FIX , E BND			
MOLLY, NM FIX	FRIAN, NM FIX	*6800	17500
*6300 - MOCA			
FRIAN, NM FIX	*DUCAS, NM FIX	7900	17500
*9200 - MCA DUCAS, NM FIX , NW BND			
DUCAS, NM FIX	TRUTH OR CONSEQUENCES, NM VORTAC	9700	17500
TRUTH OR CONSEQUENCES, NM VORTAC	SOCORRO, NM VORTAC	10100	17500
SOCORRO, NM VORTAC	YECUG, NM WP	7900	17500
YECUG, NM WP	AWASH, NM FIX	*8600	17500
*8100 - MOCA			
AWASH, NM FIX	CABZO, NM FIX	10000	17500
CABZO, NM FIX	TANER, NM FIX	10300	17500
TANER, NM FIX	MISSY, NM FIX	9600	17500
MISSY, NM FIX	RATTLESNAKE, NM VORTAC	8900	17500
RATTLESNAKE, NM VORTAC	*RIZAL, CO FIX	8900	17500
*10000 - MCA RIZAL, CO FIX , N BND			
RIZAL, CO FIX	MANCA, CO FIX	11200	17500
MANCA, CO FIX	HAVWU, CO FIX	12200	17500
GRAND JUNCTION, CO VOR/DME	*TESSY, CO FIX	10100	17500
*10500 - MRA			
*10700 - MCA TESSY, CO FIX , N BND			
TESSY, CO FIX	*RACER, CO FIX	11300	17500
*12000 - MRA			
RACER, CO FIX	*RENAE, CO FIX	10800	17500
*13000 - MRA			
RENAE, CO FIX	*ROCK SPRINGS, WY VOR/DME	11900	17500
*10200 - MCA ROCK SPRINGS, WY VOR/DME , S BND			
ROCK SPRINGS, WY VOR/DME	SWEAT, WY FIX	10000	17500
SWEAT, WY FIX	HONOX, WY FIX	10000	17500
HONOX, WY FIX	RIVERTON, WY VOR/DME	*8300	17500
*7800 - MOCA			
RIVERTON, WY VOR/DME	*FETIK, WY FIX	**7500	17500
*8800 - MCA FETIK, WY FIX , N BND			
**7500 - MOCA			
FETIK, WY FIX	CRANY, WY FIX	9800	17500
CRANY, WY FIX	PECKK, WY FIX	7900	17500
PECKK, WY FIX	*PRYER, MT FIX	11100	17500
*9900 - MCA PRYER, MT FIX , S BND			
PRYER, MT FIX	BILLINGS, MT VORTAC	7500	17500
BILLINGS, MT VORTAC	TASSE, MT FIX	6200	17500
TASSE, MT FIX	*JUGAP, MT FIX	6800	17500
*8400 - MCA JUGAP, MT FIX , NW BND			
JUGAP, MT FIX	ZERZO, MT FIX	9700	17500
ZERZO, MT FIX	*AUBBY, MT WP	10500	17500
*8300 - MCA AUBBY, MT WP , E BND			
AUBBY, MT WP	GREAT FALLS, MT VORTAC	6500	17500
GREAT FALLS, MT VORTAC	TUCKB, MT FIX	7000	17500
TUCKB, MT FIX	ROSOE, MT FIX	*7600	17500
*7600 - MOCA			
ROSOE, MT FIX	*PREEL, MT WP	8600	17500
*10200 - MCA PREEL, MT WP , SW BND			
PREEL, MT WP	KUNZY, MT WP	11200	17500

FROM	TO	MEA	MAA
------	----	-----	-----

**95.3317 RNAV ROUTE T317 - CONTINUED**

KUNZY, MT WP *9100 - MOCA	OCEDA, MT FIX	*9600	17500
OCEDA, MT FIX	MISSOULA, MT VOR/DME	10100	17500
MISSOULA, MT VOR/DME	JIROS, MT FIX	9500	17500
JIROS, MT FIX	OFINO, ID FIX	9800	17500
OFINO, ID FIX	NEZ PERCE, ID VOR/DME	6100	17500
NEZ PERCE, ID VOR/DME *5600 - MOCA	POTOR, WA FIX	*6100	17500
POTOR, WA FIX	RENGO, WA FIX	7200	17500
RENGO, WA FIX	BUTOC, WA FIX	6400	17500
BUTOC, WA FIX	BACUN, WA FIX	4500	17500
BACUN, WA FIX	PASCO, WA VOR/DME	3300	17500
PASCO, WA VOR/DME *3300 - MCA NIALS, WA FIX , NW BND	*NIALS, WA FIX	2900	17500
NIALS, WA FIX	FEBUS, WA FIX	4900	17500
FEBUS, WA FIX	MERFF, WA WP	6200	17500
MERFF, WA WP *7200 - MOCA	THICK, WA FIX	*7900	17500
THICK, WA FIX	RADDY, WA FIX	8700	17500
RADDY, WA FIX	MOUNT, WA FIX	8400	17500
MOUNT, WA FIX *4600 - MCA COFAY, WA WP , E BND	*COFAY, WA WP	7700	17500
COFAY, WA WP	FESAS, WA WP	2000	17500
FESAS, WA WP *3800 - MCA OZEYO, WA FIX , SW BND	*OZEYO, WA FIX	**3000	17500
**2500 - MOCA			
OZEYO, WA FIX	CETUV, WA FIX	4700	17500
CETUV, WA FIX	HEVOL, WA FIX	5200	17500
HEVOL, WA FIX *4300 - MOCA	ASTORIA, OR VOR/DME	*4800	17500

**95.3319 RNAV ROUTE T319**

CCLAY, GA WP	DUNCS, GA WP	2700	17500
DUNCS, GA WP	SHURT, GA WP	2700	17500
SHURT, GA WP	KLOWD, GA WP	3100	17500
KLOWD, GA WP	BLEWW, GA WP	3100	17500

**95.3321 RNAV ROUTE T321**

BBOAT, GA WP	TACKL, GA WP	2500	17500
TACKL, GA WP	REELL, GA WP	2600	17500
REELL, GA WP	BIGNN, GA WP	3700	17500

**95.3322 RNAV ROUTE T322**

RAPID CITY, SD VORTAC	PHILIP, SD VOR/DME	5000	17500
PHILIP, SD VOR/DME	PIERRE, SD VORTAC	4000	17500
PIERRE, SD VORTAC	DAKPE, SD WP	3900	17500
DAKPE, SD WP *2800 - MOCA	DIDDL, SD WP	*3700	17500
DIDDL, SD WP *3200 - MOCA	OBITT, SD WP	*3700	17500
OBITT, SD WP	CARIT, MN WP	3700	17500
CARIT, MN WP *3200 - MOCA	REDWOOD FALLS, MN VOR/DME	*3700	17500

**95.3323 RNAV ROUTE T323**

MARQO, FL WP	LRSEY, GA WP	2300	17500
--------------	--------------	------	-------

FROM	TO	MEA	MAA
------	----	-----	-----

**95.3323 RNAV ROUTE T323 - CONTINUED**

LRSEY, GA WP	CROCS, GA WP	2000	17500
CROCS, GA WP	BOBBR, GA WP	2300	17500
BOBBR, GA WP	*BIGNN, GA WP	2700	17500
*3400 - MCA BIGNN, GA WP , N BND			
BIGNN, GA WP	HELNN, NC WP	7000	17500
HELNN, NC WP	OCOEE, NC WP	6600	17500
OCOEE, NC WP	*KNITS, TN FIX	7400	17500
*6200 - MCA KNITS, TN FIX , S BND			
KNITS, TN FIX	CRECY, TN WP	5000	17500
CRECY, TN WP	*ZADOT, TN WP	4200	17500
*5400 - MCA ZADOT, TN WP , N BND			
ZADOT, TN WP	*WELLA, KY WP	5900	17500
*4400 - MCA WELLA, KY WP , S BND			
WELLA, KY WP	DACEL, KY WP	3800	17500

**95.3325 RNAV ROUTE T325**

BOWLING GREEN, KY DME	RENRO, KY WP	*4500	17500
*2400 - MOCA			
RENRO, KY WP	LOONE, KY WP	*4500	17500
*2100 - MOCA			
LOONE, KY WP	APALO, IN FIX	*4500	17500
*2100 - MOCA			
APALO, IN FIX	BUNKA, IN FIX	2500	17500
BUNKA, IN FIX	JIBKA, IN WP	2400	17500
JIBKA, IN WP	CAPPY, IL WP	2500	17500
CAPPY, IL WP	SMARS, IL WP	3000	17500
SMARS, IL WP	TRENM, IL WP	3100	10000
TRENM, IL WP	START, IL FIX	3100	10000
START, IL FIX	GRIFT, IL WP	2700	10000
GRIFT, IL WP	*DEBOW, WI FIX	2800	10000
*10000 - MRA			
DEBOW, WI FIX	LUNGS, WI WP	2700	10000
LUNGS, WI WP	HOMNY, WI WP	*2800	10000
*2300 - MOCA			
HOMNY, WI WP	OSHKOSH, WI VORTAC	*3900	10000
*2600 - MOCA			

**95.3326 RNAV ROUTE T326**

MISSION BAY, CA VORTAC	HAILE, CA FIX	3800	17500
HAILE, CA FIX	BLLYJ, CA WP	6400	17500
BLLYJ, CA WP	STAXS, CA WP	8000	17500
STAXS, CA WP	GILYY, CA WP	8600	17500
GILYY, CA WP	KUMBA, CA FIX	8600	17500
KUMBA, CA FIX	IMPERIAL, CA VORTAC	4700	17500

**95.3328 RNAV ROUTE T328**

ORCUS, WA FIX	*MADEE, WA WP	2000	17500
*4800 - MCA MADEE, WA WP , E BND			
MADEE, WA WP	BOCAT, WA FIX	6000	17500
BOCAT, WA FIX	*BJAAY, WA WP	6300	17500
*8100 - MCA BJAAY, WA WP , E BND			
BJAAY, WA WP	*CREEB, WA FIX	9000	17500
*10200 - MCA CREEB, WA FIX , E BND			
CREEB, WA FIX	*ROZSE, WA WP	11000	17500
*11300 - MCA ROZSE, WA WP , E BND			
ROZSE, WA WP	KRUZR, WA FIX	11700	17500



FROM	TO	MEA	MAA
<b>95.3328 RNAV ROUTE T328 - CONTINUED</b>			
KRUZR, WA FIX	*STRDP, WA WP	10800	17500
*8800 - MCA STRDP, WA WP , W BND			
STRDP, WA WP	*KLSEY, WA WP	7600	17500
*6700 - MCA KLSEY, WA WP , W BND			
KLSEY, WA WP	*SINGG, WA WP	5000	17500
*6200 - MCA SINGG, WA WP , E BND			
SINGG, WA WP	ROZTY, WA WP	7000	17500
ROZTY, WA WP	PRRKS, WA WP	7400	17500
PRRKS, WA WP	DAINA, WA WP	7500	17500
DAINA, WA WP	INOBE, ID FIX	7300	17500
INOBE, ID FIX	*RNDDY, ID WP	7700	17500
*8600 - MCA RNDDY, ID WP , E BND			
RNDDY, ID WP	*KAPPN, MT WP	11000	17500
*10200 - MCA KAPPN, MT WP , W BND			
KAPPN, MT WP	KARSH, MT WP	8800	17500
<b>95.3329 RNAV ROUTE T329</b>			
MORRO BAY, CA VORTAC	PASO ROBLES, CA VORTAC	5000	17500
PASO ROBLES, CA VORTAC	LKHRN, CA WP	5900	17500
LKHRN, CA WP	PANOCHE, CA VORTAC	6900	17500
PANOCHE, CA VORTAC	MKNNA, CA WP	6400	17500
MKNNA, CA WP	OXJEF, CA WP	*6400	17500
*1600 - MOCA			
OXJEF, CA WP	TIPRE, CA WP	2700	17500
TIPRE, CA WP	OLIPH, CA WP	2700	17500
OLIPH, CA WP	HNNRY, CA WP	2400	17500
HNNRY, CA WP	*ROWWN, CA WP	1800	17500
*3200 - MCA ROWWN, CA WP , W BND			
ROWWN, CA WP	RAGGS, CA FIX	5100	17500
RAGGS, CA FIX	POPES, CA FIX	4900	17500
POPES, CA FIX	NACKI, CA WP	5900	17500
<b>95.3330 RNAV ROUTE T330</b>			
GRAND FORKS, ND VOR/DME	BYZIN, MN WP	*3900	17500
*2500 - MOCA			
BYZIN, MN WP	TAMMR, MN WP	*3900	17500
*3000 - MOCA			
TAMMR, MN WP	WATAM, MN WP	*3900	17500
*2900 - MOCA			
WATAM, MN WP	MAFLN, MN WP	*3900	17500
*2900 - MOCA			
MAFLN, MN WP	DAYLE, MN FIX	*3900	17500
*3000 - MOCA			
DAYLE, MN FIX	GOPHER, MN VORTAC	*4000	17500
*3500 - MOCA			
<b>95.3331 RNAV ROUTE T331</b>			
FRAME, CA FIX	NTELL, CA WP	2000	17500
NTELL, CA WP	MKNNA, CA WP	2300	17500
MKNNA, CA WP	KARNN, CA FIX	4700	17500
KARNN, CA FIX	VINCO, CA FIX	6600	17500
VINCO, CA FIX	NORCL, CA WP	6300	17500
NORCL, CA WP	*MOVDD, CA WP	6000	17500
*5000 - MCA MOVDD, CA WP , SW BND			
MOVDD, CA WP	EVETT, CA WP	3500	17500
EVETT, CA WP	TIPRE, CA WP	2700	17500

FROM	TO	MEA	MAA
------	----	-----	-----

**95.3331 RNAV ROUTE T331 - CONTINUED**

TIPRE, CA WP *7800 - MCA ESSOH, CA WP , NE BND	*ESSOH, CA WP	6300	17500
ESSOH, CA WP	SQUAW VALLEY, CA VOR/DME	11200	17500
SQUAW VALLEY, CA VOR/DME	TRUCK, CA FIX	11200	17500
TRUCK, CA FIX	MUSTANG, NV VORTAC	11600	17500
MUSTANG, NV VORTAC	HIXUP, NV WP	10300	17500
HIXUP, NV WP	LOVELOCK, NV VORTAC	9300	17500
LOVELOCK, NV VORTAC *11900 - MCA CUTVA, NV FIX , E BND	*CUTVA, NV FIX	10500	17500
CUTVA, NV FIX	BATTLE MOUNTAIN, NV VORTAC	11900	17500
BATTLE MOUNTAIN, NV VORTAC	PARZZ, NV WP	10900	17500
PARZZ, NV WP	DRYAD, ID FIX	10700	17500
DRYAD, ID FIX	TULIE, ID WP	11400	17500
TULIE, ID WP	AMFAL, ID WP	8300	17500
AMFAL, ID WP	POCATELLO, ID VOR/DME	8300	17500
POCATELLO, ID VOR/DME	VIPUC, ID FIX	7700	17500
VIPUC, ID FIX	IDAHO FALLS, ID VOR/DME	7100	17500
IDAHO FALLS, ID VOR/DME	PULTE, ID FIX	7100	17500
PULTE, ID FIX *10000 - MRA	*SABAT, ID FIX	7600	17500
SABAT, ID FIX	WAHNZ, ID WP	9900	17500
WAHNZ, ID WP	BUFVO, WY WP	11700	17500
BUFVO, WY WP *13400 - MCA SPECT, MT WP , SW BND	*SPECT, MT WP	14900	17500
SPECT, MT WP	BILLINGS, MT VORTAC	8300	17500
BILLINGS, MT VORTAC	TRUED, MT WP	6100	17500
TRUED, MT WP	EXADE, MT FIX	5900	17500
EXADE, MT FIX	JEKOK, ND WP	4400	17500
JEKOK, ND WP	FONIA, ND FIX	4000	17500

**95.3332 RNAV ROUTE T332**

ZONUV, WA WP *4600 - MOCA	CRNEL, WA WP	*6100	17500
CRNEL, WA WP	AALIX, WA WP	7200	17500
AALIX, WA WP *9400 - MCA BAALE, WA WP , E BND	*BAALE, WA WP	8500	17500
BAALE, WA WP *9500 - MOCA	SNNDY, WA WP	*10000	17500
SNNDY, WA WP	COADY, WA WP	10400	17500
COADY, WA WP	DYNGO, WA WP	10600	17500
DYNGO, WA WP *9500 - MCA METOO, WA WP , W BND	*METOO, WA WP	10400	17500
METOO, WA WP	HVARD, WA WP	7900	17500
HVARD, WA WP	REPII, WA WP	7000	17500
REPII, WA WP	ROZTY, WA WP	7000	17500

**95.3333 RNAV ROUTE T333**

FELLOWS, CA VOR/DME	REDDE, CA WP	7300	17500
REDDE, CA WP	LKHRN, CA WP	5800	17500
LKHRN, CA WP *6200 - MCA RANCK, CA FIX , SE BND	*RANCK, CA FIX	6700	17500
RANCK, CA FIX *5500 - MCA PANOS, CA FIX , SE BND	*PANOS, CA FIX	6200	17500
PANOS, CA FIX *4500 - MCA ULENY, CA WP , SE BND	*ULENY, CA WP	5200	17500
ULENY, CA WP	HENCE, CA FIX	4300	17500
HENCE, CA FIX	GILRO, CA FIX	4700	17500

FROM	TO	MEA	MAA
<b>95.3333 RNAV ROUTE T333 - CONTINUED</b>			
GILRO, CA FIX	BORED, CA FIX	6100	17500
BORED, CA FIX	SMONE, CA WP	6100	17500
SMONE, CA WP	*OOWEN, CA WP	5700	17500
*4200 - MCA OOWEN, CA WP , S BND			
OOWEN, CA WP	EVETT, CA WP	2300	17500
EVETT, CA WP	TIPRE, CA WP	2700	17500
<b>95.3336 RNAV ROUTE T336</b>			
TROYR, FL WP	FUTSY, FL WP	2500	17500
FUTSY, FL WP	OMMNI, FL WP	1900	17500
OMMNI, FL WP	VIZTA, FL WP	1800	17500
VIZTA, FL WP	PUNQU, FL WP	2000	17500
PUNQU, FL WP	YOJIX, FL FIX	2200	17500
YOJIX, FL FIX	YONMA, FL FIX	2200	17500
YONMA, FL FIX	*ODDEL, FL FIX	1800	17500
*2700 - MCA ODDEL, FL FIX , E BND			
ODDEL, FL FIX	DEARY, FL FIX	2700	17500
DEARY, FL FIX	VALKA, FL FIX	1800	17500
<b>95.3338 RNAV ROUTE T338</b>			
DSIRE, NV WP	LNDIN, NV WP	7200	17500
LNDIN, NV WP	WYLND, NV WP	6600	17500
WYLND, NV WP	BOEGY, AZ WP	7700	17500
<b>95.3339 RNAV ROUTE T339</b>			
CARNU, FL FIX	*DEEDS, FL FIX	1800	17500
*4000 - MRA			
DEEDS, FL FIX	SWAGS, FL FIX	1700	17500
SWAGS, FL FIX	ZAGPO, FL WP	1700	17500
ZAGPO, FL WP	DIDDY, FL FIX	1700	17500
DIDDY, FL FIX	ODDEL, FL FIX	2700	17500
<b>95.3341 RNAV ROUTE T341</b>			
MEAGN, FL WP	ZAGPO, FL WP	1700	17500
ZAGPO, FL WP	CUSEK, FL WP	1700	17500
CUSEK, FL WP	YELLZ, FL WP	1900	17500
YELLZ, FL WP	WEZER, FL WP	2000	17500
WEZER, FL WP	VARZE, FL WP	2000	17500
VARZE, FL WP	DULFN, FL WP	1800	17500
DULFN, FL WP	OMMNI, FL WP	1800	17500
OMMNI, FL WP	WHOOU, FL WP	2100	12000
WHOOU, FL WP	MARQO, FL WP	1900	12000
<b>95.3343 RNAV ROUTE T343</b>			
COOFS, FL FIX	CUSEK, FL WP	1800	17500
CUSEK, FL WP	FEBRO, FL WP	1800	17500
FEBRO, FL WP	TAHRS, FL WP	2000	17500
TAHRS, FL WP	YOJIX, FL FIX	2000	17500
YOJIX, FL FIX	YONMA, FL FIX	2200	17500
YONMA, FL FIX	*ODDEL, FL FIX	1800	17500
*2700 - MCA ODDEL, FL FIX , E BND			
ODDEL, FL FIX	DEARY, FL FIX	2700	17500
DEARY, FL FIX	INDIA, FL FIX	1800	17500
<b>95.3345 RNAV ROUTE T345</b>			
MARKT, FL WP	AIRBT, FL WP	1700	17500

FROM	TO	MEA	MAA
<b>95.3345 RNAV ROUTE T345 - CONTINUED</b>			
AIRBT, FL WP	DOWDI, FL WP	1700	17500
DOWDI, FL WP	LLNCH, FL FIX	1800	17500
LLNCH, FL FIX	VALKA, FL FIX	1800	17500
<b>95.3347 RNAV ROUTE T347</b>			
SHANC, FL FIX	BOBOE, FL WP	1700	17500
BOBOE, FL WP	DURRY, FL WP	1700	17500
DURRY, FL WP	CLEFF, FL WP	1700	17500
CLEFF, FL WP	BAIRN, FL FIX	1800	17500
BAIRN, FL FIX	ODDEL, FL FIX	2700	17500
ODDEL, FL FIX	SABOT, FL FIX	2700	17500
SABOT, FL FIX	*CROPY, FL FIX	1800	17500
*2000 - MCA CROPY, FL FIX , N BND			
CROPY, FL FIX	KIZER, FL FIX	2800	17500
KIZER, FL FIX	GUANO, FL FIX	2800	17500
GUANO, FL FIX	MRUTT, FL WP	1800	17500
MRUTT, FL WP	FOXAM, FL WP	1800	17500
FOXAM, FL WP	*SEBAG, FL FIX	1700	17500
*3000 - MRA			
<b>95.3348 RNAV ROUTE T348</b>			
LESNR, SD WP	TECUD, SD WP	4000	17500
TECUD, SD WP	SIOUX FALLS, SD VORTAC	4100	17500
SIOUX FALLS, SD VORTAC	GRSIS, MN WP	3500	17500
GRSIS, MN WP	FOOLS, MN WP	3200	17500
FOOLS, MN WP	GABDE, MN WP	3100	17500
GABDE, MN WP	KRRTR, IA WP	3200	17500
KRRTR, IA WP	MADISON, WI VORTAC	3000	17500
MADISON, WI VORTAC	LUNGS, WI WP	2800	17500
<b>95.3349 RNAV ROUTE T349</b>			
VARZE, FL WP	MILOW, FL WP	1900	17500
MILOW, FL WP	MURDE, FL WP	1900	17500
MURDE, FL WP	TROYR, FL WP	1900	17500
<b>95.3353 RNAV ROUTE T353</b>			
FEBRO, FL WP	MOANS, FL FIX	1900	17500
MOANS, FL FIX	PUNQU, FL WP	1900	17500
PUNQU, FL WP	AKOJO, FL WP	2000	17500
AKOJO, FL WP	DAIYL, FL WP	1800	17500
DAIYL, FL WP	EMSEE, FL WP	1900	17500
EMSEE, FL WP	KIZER, FL FIX	2800	17500
KIZER, FL FIX	GUANO, FL FIX	2800	17500
GUANO, FL FIX	MRUTT, FL WP	1800	17500
MRUTT, FL WP	FOXAM, FL WP	1800	17500
FOXAM, FL WP	COBOK, FL FIX	1700	17500
COBOK, FL FIX	SUBER, FL FIX	*1700	17500
*1200 - MOCA			
SUBER, FL FIX	STARY, GA FIX	*1700	17500
*1200 - MOCA			
<b>95.3354 RNAV ROUTE T354</b>			
BYZIN, MN WP	PARK RAPIDS, MN DME	3600	17500
PARK RAPIDS, MN DME	BRNRD, MN WP	3300	17500

FROM	TO	MEA	MAA
------	----	-----	-----

**95.3354 RNAV ROUTE T354 - CONTINUED**

BRNRD, MN WP	SSKYY, WI WP	3000	17500
SSKYY, WI WP	TONOC, WI FIX	3000	17500
TONOC, WI FIX	KOETZ, WI WP	3000	17500
KOETZ, WI WP	HRMNN, WI WP	3500	17500
HRMNN, WI WP	FOMAG, WI WP	3000	17500
FOMAG, WI WP	MAYSE, WI WP	3000	10000
MAYSE, WI WP	HOMRC, IL WP	3000	10000
HOMRC, IL WP	CPTON, IL WP	2600	10000
CPTON, IL WP	BLLUE, IL FIX	2700	17500
BLLUE, IL FIX	BOSTN, IL WP	2800	17500
BOSTN, IL WP	BIBLE GROVE, IL VORTAC	2500	17500
BIBLE GROVE, IL VORTAC	NUWAY, IL WP	2100	17500
NUWAY, IL WP	MESSR, KY WP	2300	17500
MESSR, KY WP	AHOYE, KY FIX	2000	17500
AHOYE, KY FIX	SACDO, TN WP	2200	17500
SACDO, TN WP	HAUSS, TN WP	2000	17500

**95.3355 RNAV ROUTE T355**

FOLDS, CA FIX	*DIMGE, CA WP	11200	17500
*9600 - MCA DIMGE, CA WP , S BND			
DIMGE, CA WP	GRENA, CA FIX	*7600	17500
*6300 - MOCA			
GRENA, CA FIX	ROMAE, CA FIX	9000	17500
ROMAE, CA FIX	*TALEM, OR FIX	9700	17500
*9200 - MCA TALEM, OR FIX , SE BND			
TALEM, OR FIX	SAMIE, OR FIX	7800	17500
SAMIE, OR FIX	BROKN, OR FIX	6900	17500
BROKN, OR FIX	KINZY, OR WP	8900	17500
KINZY, OR WP	SSTRS, OR WP	9800	17500
SSTRS, OR WP	*OCTAD, OR FIX	**8300	17500
*7100 - MCA OCTAD, OR FIX , S BND			
**7700 - MOCA			
OCTAD, OR FIX	HERBS, OR FIX	6900	17500
HERBS, OR FIX	WISSL, OR WP	6400	17500
WISSL, OR WP	JJETT, OR WP	7700	17500
JJETT, OR WP	PUTZZ, OR WP	7700	17500
PUTZZ, OR WP	*GLARA, OR FIX	7300	17500
*5100 - MCA GLARA, OR FIX , E BND			
GLARA, OR FIX	CANBY, OR FIX	*3500	17500
*2800 - MOCA			
CANBY, OR FIX	KKARP, OR WP	5300	17500
KKARP, OR WP	CETUV, WA FIX	5300	17500
CETUV, WA FIX	ZOLGI, WA FIX	4900	17500
ZOLGI, WA FIX	*WUMOX, WA FIX	3400	17500
*3100 - MCA WUMOX, WA FIX , S BND			
WUMOX, WA FIX	PENN COVE, WA VOR/DME	3000	17500
PENN COVE, WA VOR/DME	ZONUV, WA WP	3000	17500
ZONUV, WA WP	UCAKI, WA WP	3000	17500
UCAKI, WA WP	SECOG, WA FIX	2300	17500

**95.3356 RNAV ROUTE T356**

*WOOLY, MD FIX	DROSA, MD WP	**6000	17500
*6000 - MCA WOOLY, MD FIX , SE BND			
**3100 - MOCA			
DROSA, MD WP	OBWON, MD WP	*6000	17500
*2600 - MOCA			
OBWON, MD WP	SWANN, MD FIX	*6000	17500
*1800 - MOCA			

FROM	TO	MEA	MAA
<b>95.3356 RNAV ROUTE T356 - CONTINUED</b>			
SWANN, MD FIX *6000 - MCA GATBY, MD FIX , SW BND **1500 - MOCA	*GATBY, MD FIX	**6000	17500
GATBY, MD FIX *1400 - MOCA	KERNO, MD FIX	*4000	17500
KERNO, MD FIX *1500 - MOCA	ODESA, MD FIX	*4000	17500
ODESA, MD FIX *4000 - MCA ELUDE, MD FIX , BND **1800 - MOCA	*ELUDE, MD FIX	**4000	17500
<b>95.3357 RNAV ROUTE T357</b>			
KONNG, NV WP	DICSA, NV FIX	7600	17500
DICSA, NV FIX	WANDR, NV WP	7600	17500
WANDR, NV WP	DSIRE, NV WP	6900	17500
<b>95.3358 RNAV ROUTE T358</b>			
MARTINSBURG, WV VORTAC *3800 - MOCA	CPTAL, MD WP	*5000	17500
CPTAL, MD WP *4300 - MOCA	HOGZZ, MD WP	*5000	17500
HOGZZ, MD WP *3200 - MOCA	MOYRR, MD WP	*5000	17500
MOYRR, MD WP *3100 - MOCA	DANII, MD WP	*6000	17500
DANII, MD WP *2600 - MOCA	OBWON, MD WP	*6000	17500
OBWON, MD WP *1800 - MOCA	SWANN, MD FIX	*6000	17500
SWANN, MD FIX *1500 - MOCA	GOLDA, MD FIX	*1800	17500
GOLDA, MD FIX *1500 - MOCA	BROSS, MD FIX	*1800	17500
BROSS, MD FIX *1500 - MOCA	SMYRNA, DE VORTAC	*1800	17500
SMYRNA, DE VORTAC *1400 - MOCA	LEEAH, NJ FIX	*1800	17500
LEEAH, NJ FIX *1600 - MOCA	AVALO, NJ FIX	*1800	17500
<b>95.3359 RNAV ROUTE T359</b>			
DANBY, CA FIX	WOPMA, CA FIX	10500	17500
WOPMA, CA FIX	DICSA, NV FIX	8300	17500
DICSA, NV FIX	RAATT, NV WP	7600	17500
RAATT, NV WP	DSIRE, NV WP	6300	17500
<b>95.3361 RNAV ROUTE T361</b>			
BOEGY, AZ WP	PUTTT, AZ WP	7000	17500
PUTTT, AZ WP	DICSA, NV FIX	7600	17500
DICSA, NV FIX	WANDR, NV WP	7600	17500
WANDR, NV WP	LNDIN, NV WP	6300	17500
LNDIN, NV WP	SHIEK, NV WP	7700	17500
SHIEK, NV WP *5900 - MOCA	MORMON MESA, NV VORTAC	*7600	17500
<b>95.3363 RNAV ROUTE T363</b>			
DICSA, NV FIX	PUTTT, AZ WP	7600	17500

FROM	TO	MEA	MAA
------	----	-----	-----

**95.3363 RNAV ROUTE T363 - CONTINUED**

PUTTT, AZ WP	SHIEK, NV WP	7600	17500
SHIEK, NV WP	MORMON MESA, NV VORTAC	*7600	17500
*5900 - MOCA			

**95.3364 RNAV ROUTE T364**

COGNUM, AK WP	HIPIV, AK WP	*3000	17500
*1700 - MOCA			
HIPIV, AK WP	KOTZEBUE, AK VOR/DME	2600	17500

**95.3366 RNAV ROUTE T366**

VANTY, AK WP	CABGI, AK WP	4000	17500
CABGI, AK WP	SUPGY, AK WP	4000	17500
SUPGY, AK WP	JODGU, AK WP	2200	17500
JODGU, AK WP	FILEV, AK WP	1900	17500
FILEV, AK WP	BARROW, AK VOR/DME	*1900	17500
*1400 - MOCA			
BARROW, AK VOR/DME	JATIL, AK WP	1800	17500

**95.3367 RNAV ROUTE T367**

JOPES, AK WP	*WOMEV, AK WP	**2600	17500
*2800 - MCA WOMEV, AK WP , NE BND			
**2100 - MOCA			
WOMEV, AK WP	*JERDN, AK WP	4600	17500
*4200 - MCA JERDN, AK WP , SW BND			
JERDN, AK WP	*MKLUR, AK WP	**4400	17500
*4400 - MCA MKLUR, AK WP , SE BND			
**4000 - MOCA			
MKLUR, AK WP	*HALUS, AK WP	3000	17500
*5000 - MCA HALUS, AK WP , NE BND			
HALUS, AK WP	*FEMEP, AK WP	**5000	17500
*3700 - MCA FEMEP, AK WP , NW BND			
**3000 - MOCA			
FEMEP, AK WP	*JIGUM, AK WP	**6500	17500
*2800 - MCA JIGUM, AK WP , SE BND			
**5200 - MOCA			
JIGUM, AK WP	KOTZEBUE, AK VOR/DME	2700	17500
KOTZEBUE, AK VOR/DME	CABGI, AK WP	4400	17500

**95.3368 RNAV ROUTE T368**

KING SALMON, AK VORTAC	*CACCA, AK FIX	2300	17500
*3300 - MCA CACCA, AK FIX , E BND			
CACCA, AK FIX	*ICADI, AK FIX	3300	17500
*3900 - MCA ICADI, AK FIX , E BND			
ICADI, AK FIX	*ZAFPO, AK WP	4300	17500
*4900 - MCA ZAFPO, AK WP , E BND			
ZAFPO, AK WP	*KOKOZ, AK FIX	4800	17500
*5900 - MCA KOKOZ, AK FIX , NE BND			
KOKOZ, AK FIX	*WORRI, AK FIX	7000	17500
*7600 - MCA WORRI, AK FIX , E BND			
WORRI, AK FIX	*CIXUL, AK WP	9200	17500
*8500 - MCA CIXUL, AK WP , W BND			
CIXUL, AK WP	*OSBOE, AK FIX	4700	17500
*4700 - MCA OSBOE, AK FIX , NW BND			
OSBOE, AK FIX	KODIAK, AK VOR/DME	4600	17500

**95.3369 RNAV ROUTE T369**

BETHEL, AK VORTAC	JOPES, AK WP	*3000	17500
*1900 - MOCA			

FROM	TO	MEA	MAA
<b>95.3369 RNAV ROUTE T369 - CONTINUED</b>			
JOPEL, AK WP *2400 - MOCA	ZIPIX, AK WP	*3200	17500
ZIPIX, AK WP	NOME, AK VOR/DME	2800	17500
<b>95.3370 RNAV ROUTE T370</b>			
WIXER, AK WP	ITAWU, AK WP	3500	17500
ITAWU, AK WP *1500 - MOCA	DILLINGHAM, AK VOR/DME	*2800	17500
DILLINGHAM, AK VOR/DME *4600 - MCA DUMZU, AK WP , NE BND	*DUMZU, AK WP	3500	17500
DUMZU, AK WP *6300 - MCA AWOMY, AK FIX , NE BND	*AWOMY, AK FIX	6100	17500
AWOMY, AK FIX *4900 - MCA MOFOF, AK FIX , SW BND	*MOFOF, AK FIX	8200	17500
MOFOF, AK FIX	KENAI, AK VOR/DME	2800	17500
<b>95.3370 RNAV ROUTE T370</b>			
BURBN, TX WP *3700 - MCA ZUMKI, TX FIX , E BND	*ZUMKI, TX FIX	3000	17500
ZUMKI, TX FIX	RRORY, TX WP	4000	17500
RRORY, TX WP	RAKOC, TX FIX	2400	17500
RAKOC, TX FIX	TASEY, TX WP	2300	17500
TASEY, TX WP	SLOTH, TX WP	2000	17500
SLOTH, TX WP	LOCUS, AR FIX	2000	17500
LOCUS, AR FIX	HAMPT, AR FIX	1900	17500
HAMPT, AR FIX	RICKG, AR WP	2000	17500
RICKG, AR WP	EJКСN, MS WP	1900	17500
EJКСN, MS WP	IZAAC, MS WP	1800	17500
IZAAC, MS WP *2200 - MCA TOMLN, MS FIX , E BND	*TOMLN, MS FIX	2000	17500
TOMLN, MS FIX	CLOUT, MS FIX	2500	17500
CLOUT, MS FIX	SKNRR, MS WP	2000	17500
SKNRR, MS WP	MINIM, AL FIX	2000	17500
MINIM, AL FIX	BESOM, AL FIX	2300	17500
BESOM, AL FIX *2000 - MOCA	NESTS, AL WP	*2500	17500
NESTS, AL WP	VLKNN, AL WP	2500	17500
<b>95.3371 RNAV ROUTE T371</b>			
KODIAK, AK VOR/DME	JEKEX, AK FIX	4900	17500
JEKEX, AK FIX	HAMPU, AK WP	4200	17500
HAMPU, AK WP	AMOTT, AK FIX	3100	17500
<b>95.3372 RNAV ROUTE T372</b>			
BIG LAKE, AK VORTAC *7500 - MCA WUNTU, AK WP , NE BND	*WUNTU, AK WP	6600	17500
WUNTU, AK WP *8100 - MOCA	CAGOP, AK WP	*10000	17500
CAGOP, AK WP *8200 - MOCA	FITAT, AK WP	*10000	17500
FITAT, AK WP *8400 - MOCA	TOYOC, AK WP	*10000	17500
TOYOC, AK WP *9100 - MOCA	ZAMUP, AK WP	*10000	17500
ZAMUP, AK WP *9100 - MOCA	CANGI, AK WP	*10000	17500



FROM	TO	MEA	MAA
<b>95.3372 RNAV ROUTE T372 - CONTINUED</b>			
CANGI, AK WP *8600 - MOCA	WAPRU, AK WP	*10000	17500
WAPRU, AK WP *7700 - MOCA	HOSON, AK WP	*10000	17500
HOSON, AK WP	SMOKY, AK FIX	7200	17500
SMOKY, AK FIX	GULKANA, AK VOR/DME	5300	17500
GULKANA, AK VOR/DME	BEFTI, AK WP	5200	17500
BEFTI, AK WP *5700 - MCA CEBUN, AK WP , NE BND	*CEBUN, AK WP	5200	17500
CEBUN, AK WP *7800 - MCA HIGOL, AK WP , NE BND	*HIGOL, AK WP	6900	17500
HIGOL, AK WP *8200 - MCA JOLOB, AK WP , SW BND	*JOLOB, AK WP	**11000	17500
*8600 - MOCA			
JOLOB, AK WP *6400 - MCA WEBOL, AK WP , SW BND	*WEBOL, AK WP	7100	17500
WEBOL, AK WP	NORTHWAY, AK VORTAC	5200	17500
NORTHWAY, AK VORTAC	U.S. CANADIAN BORDER	5800	17500
<b>95.3373 RNAV ROUTE T373</b>			
KOWOK, AK FIX	RAGES, AK FIX	4400	17500
RAGES, AK FIX *6600 - MCA ZUDSO, AK WP , W BND	*ZUDSO, AK WP	5500	17500
ZUDSO, AK WP	MAYHW, AK WP	7400	17500
MAYHW, AK WP *5200 - MCA FEXOP, AK WP , SE BND	*FEXOP, AK WP	7400	17500
FEXOP, AK WP *4800 - MCA ZETNU, AK WP , E BND	*ZETNU, AK WP	4900	17500
ZETNU, AK WP	BETHEL, AK VORTAC	3700	17500
BETHEL, AK VORTAC	WEREL, AK WP	3900	17500
<b>95.3374 RNAV ROUTE T374</b>			
KOTZEBUE, AK VOR/DME	CIBDU, AK WP	2600	17500
CIBDU, AK WP *4000 - MOCA	ZUBES, AK WP	*10000	17500
ZUBES, AK WP *4200 - MOCA	CUTIB, AK WP	*10000	17500
CUTIB, AK WP *4300 - MOCA	NINGE, AK WP	*10000	17500
NINGE, AK WP *5100 - MOCA	WUNED, AK WP	*10000	17500
WUNED, AK WP	CEREX, AK WP	5000	17500
CEREX, AK WP *4600 - MCA WEPSI, AK WP , SW BND	*WEPSI, AK WP	5000	17500
WEPSI, AK WP *4700 - MCA BETTLES, AK VOR/DME , E BND	*BETTLES, AK VOR/DME	4600	17500
BETTLES, AK VOR/DME	FORT YUKON, AK VORTAC	6700	17500
<b>95.3375 RNAV ROUTE T375</b>			
BETTLES, AK VOR/DME *5300 - MCA FEDEN, AK WP , N BND	*FEDEN, AK WP	4500	17500
FEDEN, AK WP	HEKDU, AK WP	6600	17500
HEKDU, AK WP *7000 - MCA TOUTS, AK WP , NW BND	*TOUTS, AK WP	6900	17500
TOUTS, AK WP	ZEBUR, AK WP	7100	17500
ZEBUR, AK WP	RUTTY, AK WP	7300	17500

FROM	TO	MEA	MAA
<b>95.3375 RNAV ROUTE T375 - CONTINUED</b>			
RUTTY, AK WP	FERKA, AK WP	7800	17500
FERKA, AK WP	ZENSA, AK WP	8100	17500
ZENSA, AK WP	*HAKSA, AK WP	8100	17500
*6900 - MCA HAKSA, AK WP , S BND			
HAKSA, AK WP	DERIK, AK FIX	5800	17500
<b>95.3377 RNAV ROUTE T377</b>			
ANNETTE ISLAND, AK VOR/DME	INEPE, AK WP	5500	17500
INEPE, AK WP	FOROP, AK WP	4900	17500
FOROP, AK WP	BIORKA ISLAND, AK VORTAC	5300	17500
<b>95.3378 RNAV ROUTE T378</b>			
BRION, AK FIX	*URIAL, AK WP	5100	17500
*3300 - MCA URIAL, AK WP , SW BND			
URIAL, AK WP	JIFFS, AK WP	2900	17500
JIFFS, AK WP	ZUSPA, AK WP	*2500	17500
*1700 - MOCA			
ZUSPA, AK WP	DUTKE, AK WP	*2500	17500
*1700 - MOCA			
DUTKE, AK WP	FORT YUKON, AK VORTAC	*2500	17500
*1700 - MOCA			
<b>95.3381 RNAV ROUTE T381</b>			
BIG LAKE, AK VORTAC	TALKEETNA, AK VOR/DME	3000	17500
TALKEETNA, AK VOR/DME	*HUMUB, AK WP	3000	17500
*4000 - MCA HUMUB, AK WP , NW BND			
HUMUB, AK WP	*WEGNO, AK WP	4600	17500
*5400 - MCA WEGNO, AK WP , N BND			
WEGNO, AK WP	ZALVI, AK WP	6200	17500
ZALVI, AK WP	ZEKLI, AK WP	6400	17500
ZEKLI, AK WP	*CEKED, AK WP	6400	17500
*6600 - MCA CEKED, AK WP , N BND			
CEKED, AK WP	EBIME, AK WP	*9000	17500
*7100 - MOCA			
EBIME, AK WP	JOTSO, AK WP	*9000	17500
*7900 - MOCA			
JOTSO, AK WP	PAWKY, AK WP	*9000	17500
*8200 - MOCA			
PAWKY, AK WP	WIVEN, AK WP	*9000	17500
*7800 - MOCA			
WIVEN, AK WP	*WUKIR, AK WP	**9000	17500
*7100 - MCA WUKIR, AK WP , S BND			
**7700 - MOCA			
WUKIR, AK WP	*SOYAS, AK WP	6700	17500
*5300 - MCA SOYAS, AK WP , S BND			
SOYAS, AK WP	GLOWS, AK FIX	4000	17500
GLOWS, AK FIX	PERZO, AK WP	3600	17500
PERZO, AK WP	*FAIRBANKS, AK VORTAC	3600	17500
*3700 - MCA FAIRBANKS, AK VORTAC , N BND			
FAIRBANKS, AK VORTAC	*CHATA, AK FIX	5000	17500
*5000 - MCA CHATA, AK FIX , N BND			
CHATA, AK FIX	*BURMA, AK FIX	7400	17500
*4100 - MCA BURMA, AK FIX , S BND			
BURMA, AK FIX	BIJOU, AK FIX	3000	17500
BIJOU, AK FIX	FORT YUKON, AK VORTAC	2800	17500
<b>95.3382 RNAV ROUTE T382</b>			
HOOPER BAY, AK VOR/DME	MEVIC, AK FIX	*3300	17500
*2400 - MOCA			

FROM	TO	MEA	MAA
<b>95.3382 RNAV ROUTE T382 - CONTINUED</b>			
MEVIC, AK FIX *2400 - MOCA	JOPEL, AK WP	*3300	17500
JOPEL, AK WP *3700 - MCA FELSA, AK WP , NE BND	*FELSA, AK WP	3400	17500
FELSA, AK WP *3500 - MCA YELLW, AK WP , SW BND	*YELLW, AK WP	3800	17500
YELLW, AK WP	WEREL, AK WP	3000	17500
WEREL, AK WP *3100 - MOCA	OTTAC, AK WP	*3600	17500
OTTAC, AK WP *3900 - MCA CHEFF, AK WP , E BND	*CHEFF, AK WP	3600	17500
CHEFF, AK WP	MC GRATH, AK VORTAC	5400	17500
<b>95.3383 RNAV ROUTE T383</b>			
GOPHER, MN VORTAC *3100 - MOCA	BRNRD, MN WP	*3600	17500
BRNRD, MN WP *3400 - MOCA	BLUOX, MN FIX	*3900	17500
BLUOX, MN FIX	BAUDETTE, MN DME	3500	17500
<b>95.3385 RNAV ROUTE T385</b>			
KODIAK, AK VOR/DME *4700 - MOCA	WUMVI, AK WP	*7500	17500
WUMVI, AK WP *4300 - MCA GAMIC, AK WP , E BND	*GAMIC, AK WP	5400	17500
GAMIC, AK WP	WUXON, AK WP	3000	17500
WUXON, AK WP	CUPTO, AK WP	3000	17500
CUPTO, AK WP	DUMZU, AK WP	4000	17500
<b>95.3390 RNAV ROUTE T390</b>			
WANKI, AK WP *2800 - MOCA	RANND, AK FIX	*4800	17500
RANND, AK FIX *1200 - MOCA	DIBWO, AK FIX	*4800	17500
DIBWO, AK FIX *1500 - MOCA	ALEUT, AK WP	*6600	17500
ALEUT, AK WP *3000 - MOCA	ZEBUV, AK FIX	*6600	17500
ZEBUV, AK FIX *2600 - MOCA	TESPE, AK FIX	*6000	17500
TESPE, AK FIX *2200 - MOCA	KING SALMON, AK VORTAC	*9000	17500
KING SALMON, AK VORTAC *4100 - MCA OLAYA, AK FIX , SW BND	*OLAYA, AK FIX	**4100	17500
**2100 - MOCA			
OLAYA, AK FIX *6000 - MCA TOMMY, AK FIX , NE BND	*TOMMY, AK FIX	**3100	17500
**2600 - MOCA			
TOMMY, AK FIX *2100 - MOCA	BISAY, AK WP	*6000	17500
BISAY, AK WP *1300 - MOCA	NUTUW, AK FIX	*6000	17500
NUTUW, AK FIX *3800 - MOCA	DUMZU, AK WP	*6000	17500
<b>95.3391 RNAV ROUTE T391</b>			
HANCOCK, NY VOR/DME	OXFOR, NY WP	4000	17500

FROM	TO	MEA	MAA
<b>95.3391 RNAV ROUTE T391 - CONTINUED</b>			
OXFOR, NY WP	PITCH, NY WP	3700	17500
PITCH, NY WP	GTOWN, NY WP	3800	17500
GTOWN, NY WP	POMPY, NY WP	3800	17500
POMPY, NY WP	*FATUP, NY WP	3600	17500
*3100 - MCA FATUP, NY WP , SE BND			
FATUP, NY WP	SYRACUSE, NY VORTAC	2900	17500
SYRACUSE, NY VORTAC	PAGER, NY FIX	2300	17500
PAGER, NY FIX	BRUIN, NY WP	2600	17500
BRUIN, NY WP	WATERTOWN, NY VORTAC	2600	17500
WATERTOWN, NY VORTAC	WILRD, NY WP	2300	17500
WILRD, NY WP	*LETUS, NY FIX	2300	17500
*4000 - MRA			
LETUS, NY FIX	SSENA, NY WP	2200	17500
<b>95.3392 RNAV ROUTE T392</b>			
MZEEE, IA WP	KAATO, IA WP	3300	17500
KAATO, IA WP	BERRG, IA WP	3000	17500
BERRG, IA WP	GRSIS, MN WP	3300	17500
<b>95.3393 RNAV ROUTE T393</b>			
GAILS, MA FIX	INNDY, MA FIX	2000	17500
INNDY, MA FIX	PROVIDENCE, RI VOR/DME	2000	17500
PROVIDENCE, RI VOR/DME	FOSTY, RI FIX	2400	17500
FOSTY, RI FIX	PUTNM, CT WP	2500	17500
PUTNM, CT WP	GRIPE, MA FIX	2600	17500
GRIPE, MA FIX	GARDNER, MA VOR/DME	3100	17500
GARDNER, MA VOR/DME	KEYNN, NH WP	3500	17500
KEYNN, NH WP	STRUM, NH WP	3500	17500
STRUM, NH WP	*UNKER, NH WP	3800	17500
*4200 - MCA UNKER, NH WP , N BND			
UNKER, NH WP	MCADM, NH WP	5000	17500
MCADM, NH WP	LBNON, NH WP	4100	17500
LBNON, NH WP	*ZIECH, VT WP	4000	17500
*4100 - MCA ZIECH, VT WP , N BND			
ZIECH, VT WP	DAVID, VT WP	4600	17500
DAVID, VT WP	MONTPELIER, VT VOR/DME	4700	17500
MONTPELIER, VT VOR/DME	CEVIB, VT FIX	5200	17500
CEVIB, VT FIX	*POROE, VT WP	5200	17500
*5700 - MCA POROE, VT WP , NW BND			
POROE, VT WP	BURLINGTON, VT VOR/DME	6300	17500
<b>95.3395 RNAV ROUTE T395</b>			
CONCORD, NH VOR/DME	*YECKA, NH WP	3300	17500
*3700 - MCA YECKA, NH WP , NE BND			
YECKA, NH WP	*GRUMP, NH WP	4000	17500
*4600 - MCA GRUMP, NH WP , NE BND			
GRUMP, NH WP	LAROE, NH WP	5200	17500
LAROE, NH WP	NOTTY, NH WP	5400	17500
NOTTY, NH WP	WYLIE, NH WP	5900	17500
WYLIE, NH WP	*JOBBY, NH WP	6300	17500
*6200 - MCA JOBBY, NH WP , S BND			
JOBBY, NH WP	BRLIN, NH WP	5800	17500
<b>95.3396 RNAV ROUTE T396</b>			
NOME, AK VOR/DME	EZATY, AK FIX	3000	17500

FROM	TO	MEA	MAA
<b>95.3396 RNAV ROUTE T396 - CONTINUED</b>			
EZATY, AK FIX *3600 - MCA HALUS, AK WP , W BND	*HALUS, AK WP	4500	17500
HALUS, AK WP *4000 - MCA JAYQE, AK FIX , E BND	*JAYQE, AK FIX	3000	17500
JAYQE, AK FIX	JAGGU, AK FIX	5900	17500
JAGGU, AK FIX *6000 - MRA	*DIBVY, AK FIX	2600	17500
DIBVY, AK FIX	GALENA, AK VOR/DME	3100	17500
<b>95.3397 RNAV ROUTE T397</b>			
WALNUT RIDGE, AR VORTAC	VICHY, MO VOR/DME	3000	17500
VICHY, MO VOR/DME	LEWRP, MO WP	3100	17500
LEWRP, MO WP	OHGEE, IA FIX	2800	17500
OHGEE, IA FIX	LACON, IA FIX	2800	17500
LACON, IA FIX	DES MOINES, IA VORTAC	2800	17500
DES MOINES, IA VORTAC	WATERLOO, IA VOR/DME	3100	17500
<b>95.3398 RNAV ROUTE T398</b>			
SLOTH, TX WP	MUFRE, AR FIX	2000	17500
MUFRE, AR FIX	CANEY, AR FIX	2300	17500
CANEY, AR FIX	LITTR, AR WP	2200	17500
LITTR, AR WP	ATERS, AR FIX	2000	17500
ATERS, AR FIX	DRAST, AR WP	1900	17500
DRAST, AR WP	EMEEY, AR WP	2000	17500
EMEEY, AR WP	WSTON, MS FIX	2100	17500
WSTON, MS FIX	YUGPU, MS FIX	2000	17500
YUGPU, MS FIX	GOINS, MS WP	2300	17500
GOINS, MS WP	SULLY, MS WP	2400	17500
SULLY, MS WP	KERMI, MS WP	2500	17500
KERMI, MS WP	AYOTE, AL WP	2700	17500
AYOTE, AL WP *2100 - MOCA	HAGIE, AL WP	*2600	17500
HAGIE, AL WP	MARZZ, AL WP	2500	17500
MARZZ, AL WP	FILUN, AL WP	3000	17500
FILUN, AL WP	COMAR, AL FIX	4100	17500
COMAR, AL FIX	JILIS, GA WP	4600	17500
JILIS, GA WP *4900 - MCA CRAND, GA FIX , E BND	*CRAND, GA FIX	3000	17500
CRAND, GA FIX *6400 - MCA MADOL, GA FIX , E BND	*MADOL, GA FIX	6300	17500
MADOL, GA FIX	MELLS, GA FIX	6400	17500
MELLS, GA FIX *6300 - MCA BALNN, GA WP , E BND	*BALNN, GA WP	5900	17500
BALNN, GA WP	DAYEL, GA WP	7500	17500
DAYEL, GA WP	DILLA, GA WP	7000	17500
DILLA, GA WP	SUNET, SC WP	6700	17500
SUNET, SC WP	RESTS, SC WP	5800	17500
RESTS, SC WP *3400 - MCA UNMAN, SC FIX , W BND	*UNMAN, SC FIX	5700	17500
UNMAN, SC FIX	BURGG, SC WP	2900	17500
BURGG, SC WP	GAFFE, SC WP	2900	17500
GAFFE, SC WP *2900 - MOCA	CRLNA, NC WP	*3400	17500
CRLNA, NC WP	LOCAS, NC FIX	3100	17500
LOCAS, NC FIX	ZOPOC, NC FIX	2500	17500
ZOPOC, NC FIX	PEKNN, NC FIX	2300	17500
PEKNN, NC FIX	RELPHY, NC WP	2400	17500

FROM	TO	MEA	MAA
<b>95.3398 RNAV ROUTE T398 - CONTINUED</b>			
RELPHY, NC WP	GMINI, NC WP	2400	17500
<b>95.3399 RNAV ROUTE T399</b>			
TALKEETNA, AK VOR/DME *6600 - MCA EGRAM, AK FIX , N BND	*EGRAM, AK FIX	6000	17500
EGRAM, AK FIX *7000 - MCA ZEKLI, AK WP , N BND	*ZEKLI, AK WP	6400	17500
ZEKLI, AK WP *9000 - MCA AILEE, AK FIX , S BND	*AILEE, AK FIX	10000	17500
AILEE, AK FIX *8000 - MCA CRISL, AK WP , S BND	*CRISL, AK WP	8100	17500
CRISL, AK WP *7000 - MCA PAWWW, AK WP , S BND	*PAWWW, AK WP	6900	17500
PAWWW, AK WP *6100 - MCA EVIEE, AK WP , S BND	*EVIEE, AK WP	5800	17500
EVIEE, AK WP *4600 - MCA SEAHK, AK WP , S BND	*SEAHK, AK WP	4000	17500
SEAHK, AK WP *2800 - MOCA	NENANA, AK VORTAC	*3300	17500
<b>95.3400 RNAV ROUTE T400</b>			
LLUKY, NE WP	IMUPP, SD WP	3700	17500
IMUPP, SD WP	DURWN, MN WP	3400	17500
DURWN, MN WP	MEMCO, MN WP	3300	17500
MEMCO, MN WP *2400 - MOCA	ZOSAG, MN WP	*2900	17500
<b>95.3403 RNAV ROUTE T403</b>			
GENEO, MN WP	TESEE, MN FIX	3100	17500
TESEE, MN FIX	ALEXANDRIA, MN VOR/DME	3200	17500
ALEXANDRIA, MN VOR/DME	PARK RAPIDS, MN DME	3300	17500
PARK RAPIDS, MN DME	BLUOX, MN FIX	3500	17500
<b>95.3404 RNAV ROUTE T404</b>			
TYGRR, AL WP	RENFO, GA FIX	2400	17500
RENFO, GA FIX	PREST, GA FIX	2400	17500
PREST, GA FIX	WILMS, GA FIX	2400	17500
WILMS, GA FIX	POTAR, GA FIX	2400	17500
POTAR, GA FIX	BYROE, GA WP	2300	17500
BYROE, GA WP	NOKIE, GA WP	2300	17500
NOKIE, GA WP	RIPPI, GA FIX	2300	17500
RIPPI, GA FIX	HADOC, GA FIX	2300	17500
HADOC, GA FIX	MISTY, GA WP	2300	17500
MISTY, GA WP	HARLE, GA WP	2300	17500
HARLE, GA WP	WANSA, SC WP	2300	17500
WANSA, SC WP	GRAZE, SC WP	2400	17500
GRAZE, SC WP	SAMMI, SC FIX	2400	17500
SAMMI, SC FIX	STEET, SC FIX	2300	17500
STEET, SC FIX	CAYCE, SC WP	2300	17500
<b>95.3405 RNAV ROUTE T405</b>			
FIITS, SD WP	MITCHELL, SD VOR/DME	3200	17500
MITCHELL, SD VOR/DME	DIDDL, SD WP	3000	17500
DIDDL, SD WP	ABERDEEN, SD VOR/DME	3000	17500

FROM	TO	MEA	MAA
<b>95.3405 RNAV ROUTE T405 - CONTINUED</b>			
ABERDEEN, SD VOR/DME	JAMESTOWN, ND VOR/DME	3300	17500
JAMESTOWN, ND VOR/DME	FARRM, ND FIX	3400	17500
FARRM, ND FIX	GICHI, ND WP	3500	17500
<b>95.3406 RNAV ROUTE T406</b>			
KNZLY, LA WP	ARTEL, LA FIX	1700	17500
ARTEL, LA FIX	CRISP, LA FIX	1700	17500
CRISP, LA FIX	MICRO, LA FIX	1700	17500
MICRO, LA FIX	*ZIROR, LA FIX	1700	17500
*1600 - MCA ZIROR, LA FIX , E BND			
ZIROR, LA FIX	DAFLY, LA WP	1800	17500
DAFLY, LA WP	*ROSEY, LA FIX	1700	17500
*5000 - MRA			
ROSEY, LA FIX	TATER, LA FIX	2100	17500
TATER, LA FIX	RCOLA, LA WP	1800	17500
RCOLA, LA WP	DILLS, LA FIX	1900	17500
DILLS, LA FIX	*WALKE, LA FIX	1800	17500
*1700 - MCA WALKE, LA FIX , E BND			
WALKE, LA FIX	TICKS, LA FIX	1800	17500
TICKS, LA FIX	RYTHM, LA FIX	1800	17500
RYTHM, LA FIX	FRANK, LA FIX	1900	17500
FRANK, LA FIX	PELLO, MS WP	1900	17500
PELLO, MS WP	WIGGO, MS FIX	2100	17500
WIGGO, MS FIX	GARTS, MS WP	2000	17500
GARTS, MS WP	ERNON, AL FIX	2100	17500
ERNON, AL FIX	WILL, AL WP	2200	17500
WILL, AL WP	CHAFF, AL FIX	2200	17500
CHAFF, AL FIX	RUTEL, AL FIX	2200	17500
RUTEL, AL FIX	BANBI, AL FIX	2300	17500
BANBI, AL FIX	CHIRP, AL FIX	2400	17500
CHIRP, AL FIX	TYGRR, AL WP	2300	17500
TYGRR, AL WP	*LUMPP, GA FIX	2300	17500
*2000 - MCA LUMPP, GA FIX , W BND			
LUMPP, GA FIX	AMAPO, GA FIX	2300	17500
AMAPO, GA FIX	LILLY, GA FIX	2300	17500
LILLY, GA FIX	GUVNR, GA FIX	2100	17500
GUVNR, GA FIX	GAMSE, GA FIX	2100	17500
GAMSE, GA FIX	DOOLY, GA WP	2100	17500
DOOLY, GA WP	OCONE, GA FIX	2100	17500
OCONE, GA FIX	KLICK, GA FIX	2100	17500
KLICK, GA FIX	MILEN, GA FIX	2100	17500
MILEN, GA FIX	DURBE, SC WP	2000	17500
<b>95.3407 RNAV ROUTE T407</b>			
SIoux FALLS, SD VORTAC	FFORT, SD WP	3600	17500
FFORT, SD WP	FARGO, ND VOR/DME	*4500	17500
*3800 - MOCA			
FARGO, ND VOR/DME	GRAND FORKS, ND VOR/DME	2700	17500
GRAND FORKS, ND VOR/DME	WUBED, MN WP	2600	17500
WUBED, MN WP	U.S. CANADIAN BORDER	2500	17500
<b>95.3408 RNAV ROUTE T408</b>			
NOKIE, GA WP	OTGUQ, GA WP	2300	17500
OTGUQ, GA WP	GUMPY, GA WP	2000	17500
GUMPY, GA WP	*LOTTs, GA FIX	2000	17500
*11000 - MRA			

FROM	TO	MEA	MAA
<b>95.3408 RNAV ROUTE T408 - CONTINUED</b>			
LOTS, GA FIX	BROSE, GA FIX	1900	17500
BROSE, GA FIX	TBERT, GA WP	1800	17500
<b>95.3409 RNAV ROUTE T409</b>			
LLUKY, NE WP	ADEDY, SD WP	4000	17500
ADEDY, SD WP	LESNR, SD WP	4000	17500
LESNR, SD WP	PIERRE, SD VORTAC	4200	17500
<b>95.3410 RNAV ROUTE T410</b>			
SINCA, GA FIX	BEYLO, GA FIX	2400	17500
BEYLO, GA FIX	ANNAN, GA FIX	3000	17500
ANNAN, GA FIX	*WANSA, SC WP	3000	17500
*1900 - MCA WANSA, SC WP , W BND			
WANSA, SC WP	TREAD, SC FIX	2200	17500
TREAD, SC FIX	JOKER, SC FIX	2300	17500
JOKER, SC FIX	*MONET, SC FIX	2400	17500
*2000 - MCA MONET, SC FIX , NW BND			
MONET, SC FIX	LEDAS, SC FIX	2400	17500
LEDAS, SC FIX	*WIDER, SC FIX	2200	17500
*4000 - MRA			
<b>95.3411 RNAV ROUTE T411</b>			
RAZORBACK, AR VORTAC	DROOP, MO WP	3200	17500
DROOP, MO WP	BUTLER, MO VORTAC	2800	17500
BUTLER, MO VORTAC	TOPEKA, KS VORTAC	3100	17500
TOPEKA, KS VORTAC	LINCOLN, NE VORTAC	3200	17500
<b>95.3412 RNAV ROUTE T412</b>			
KNZLY, LA WP	HATHA, LA FIX	1700	17500
HATHA, LA FIX	MAXON, LA FIX	1700	17500
MAXON, LA FIX	BOZAN, LA FIX	1800	17500
BOZAN, LA FIX	MOGAN, LA FIX	1800	17500
MOGAN, LA FIX	WRACK, LA FIX	2000	17500
WRACK, LA FIX	LESTE, MS FIX	2100	17500
LESTE, MS FIX	ICEKI, MS WP	2200	17500
ICEKI, MS WP	CETDA, MS FIX	2200	17500
CETDA, MS FIX	WOBAK, MS FIX	2200	17500
WOBAK, MS FIX	SSLAW, MS WP	2100	17500
SSLAW, MS WP	*LIGIC, MS FIX	2100	17500
*2200 - MCA LIGIC, MS FIX , E BND			
LIGIC, MS FIX	PICAN, MS FIX	2300	17500
PICAN, MS FIX	YARBO, AL FIX	2100	17500
YARBO, AL FIX	WILL, AL WP	2200	17500
WILL, AL WP	*PICKS, AL FIX	2300	17500
*3500 - MRA			
PICKS, AL FIX	ALOON, AL FIX	2300	17500
ALOON, AL FIX	MGMRY, AL WP	2100	17500
MGMRY, AL WP	PETOC, AL FIX	2000	17500
PETOC, AL FIX	*MARST, AL FIX	2400	17500
*3500 - MRA			
MARST, AL FIX	KENTT, AL FIX	2300	17500
KENTT, AL FIX	YARBE, AL FIX	2500	17500
YARBE, AL FIX	*TIMMY, AL FIX	2500	17500
*2300 - MCA TIMMY, AL FIX , NE BND			
TIMMY, AL FIX	HHRVY, AL WP	2600	17500



FROM	TO	MEA	MAA
<b>95.3412 RNAV ROUTE T412 - CONTINUED</b>			
HHRVY, AL WP	BRAVS, GA WP	2600	17500
BRAVS, GA WP	HONIE, GA FIX	2600	17500
HONIE, GA FIX	*TIROE, GA FIX	2600	17500
*4000 - MRA			
<b>95.3413 RNAV ROUTE T413</b>			
RAZORBACK, AR VORTAC	DROOP, MO WP	3200	17500
DROOP, MO WP	EMPORIA, KS VORTAC	3100	17500
EMPORIA, KS VORTAC	SALINA, KS VORTAC	3300	17500
SALINA, KS VORTAC	GRAND ISLAND, NE VOR/DME	3900	17500
GRAND ISLAND, NE VOR/DME	ISTIQ, NE WP	3800	17500
ISTIQ, NE WP	LLUKY, NE WP	4000	17500
LLUKY, NE WP	MMINI, NE WP	4000	17500
MMINI, NE WP	JMBAG, SD WP	4300	17500
JMBAG, SD WP	PIERRE, SD VORTAC	4200	17500
<b>95.3414 RNAV ROUTE T414</b>			
LOGEN, GA FIX	*MILBY, SC WP	3700	17500
*4000 - MCA MILBY, SC WP , NE BND			
MILBY, SC WP	*SUNET, SC WP	4800	17500
*5600 - MCA SUNET, SC WP , NE BND			
SUNET, SC WP	STYLZ, NC WP	7100	17500
STYLZ, NC WP	BONZE, NC WP	6200	17500
BONZE, NC WP	HENBY, VA FIX	4100	17500
HENBY, VA FIX	AYARA, VA WP	3700	17500
AYARA, VA WP	BOJAR, VA WP	3600	17500
<b>95.3415 RNAV ROUTE T415</b>			
WRNGL, AK WP	GRYNE, AK WP	7400	17500
GRYNE, AK WP	*DUYZI, AK WP	7300	17500
*6600 - MCA DUYZI, AK WP , E BND			
DUYZI, AK WP	GULKANA, AK VOR/DME	4700	17500
<b>95.3416 RNAV ROUTE T416</b>			
SMYRNA, DE VORTAC	TEBEE, NJ FIX	1800	17500
TEBEE, NJ FIX	LULOO, NJ WP	1900	17500
LULOO, NJ WP	RIDNG, NJ WP	1900	17500
RIDNG, NJ WP	*ALBEK, NJ FIX	1900	17500
*2000 - MCA ALBEK, NJ FIX , E BND			
ALBEK, NJ FIX	COYLE, NJ VORTAC	2100	17500
COYLE, NJ VORTAC	*PREPI, OA FIX	1900	17500
*8000 - MRA			
<b>95.3417 RNAV ROUTE T417</b>			
CEBUN, AK WP	HATIX, AK WP	9100	17500
HATIX, AK WP	EGAXE, AK FIX	9100	17500
<b>95.3418 RNAV ROUTE T418</b>			
LAMAR, CO VOR/DME	DRAWL, KS FIX	5600	17500
DRAWL, KS FIX	TOTOE, KS WP	5000	17500
TOTOE, KS WP	MITBEE, OK VORTAC	*5000	17500
*4400 - MOCA			
<b>95.3419 RNAV ROUTE T419</b>			
MAHTY, AR WP	FRNIA, MO WP	2000	17500

FROM	TO	MEA	MAA
<b>95.3419 RNAV ROUTE T419 - CONTINUED</b>			
FRNIA, MO WP	SNOWD, MO WP	2100	17500
SNOWD, MO WP	MESSR, KY WP	2000	17500
MESSR, KY WP	ROOKE, KY WP	2200	17500
ROOKE, KY WP	WESON, KY FIX	2500	17500
WESON, KY FIX	TERGE, IN WP	2000	17500
<b>95.3420 RNAV ROUTE T420</b>			
DALHART, TX VORTAC	WLBIR, TX WP	5800	17500
WLBIR, TX WP	BRISC, TX FIX	5000	17500
BRISC, TX FIX	BURNS FLAT, OK VORTAC	4700	17500
BURNS FLAT, OK VORTAC	WILL ROGERS, OK VORTAC	4500	17500
<b>95.3421 RNAV ROUTE T421</b>			
LYFEE, AL WP	EGEST, AL FIX	1900	17500
EGEST, AL FIX	SKIPO, AL FIX	2000	17500
SKIPO, AL FIX	CLIOS, AL FIX	2100	17500
CLIOS, AL FIX	BANBI, AL FIX	2100	17500
BANBI, AL FIX	ZOREL, AL WP	2600	17500
ZOREL, AL WP	GUMMP, AL WP	2400	17500
GUMMP, AL WP	VLKNN, AL WP	3100	17500
VLKNN, AL WP	SIPSY, AL FIX	2400	17500
SIPSY, AL FIX	JOHNY, AL FIX	2400	17500
JOHNY, AL FIX	LANER, AL WP	2600	17500
LANER, AL WP	YOSNU, AL WP	2300	17500
YOSNU, AL WP	HAGIE, AL WP	2400	17500
<b>95.3422 RNAV ROUTE T422</b>			
PANHANDLE, TX VORTAC	FASOG, TX FIX	5300	17500
FASOG, TX FIX	WUDPI, TX FIX	5000	17500
WUDPI, TX FIX	ASAZE, OK FIX	4600	17500
ASAZE, OK FIX	BURNS FLAT, OK VORTAC	3600	17500
BURNS FLAT, OK VORTAC	HISLA, OK FIX	3600	17500
HISLA, OK FIX	ZELNU, OK FIX	3500	17500
ZELNU, OK FIX	BISKT, OK WP	*3300	17500
*3000 - MOCA			
BISKT, OK WP	LASTS, OK FIX	2900	17500
LASTS, OK FIX	GULLI, OK FIX	2900	17500
GULLI, OK FIX	SEARS, OK FIX	2800	17500
SEARS, OK FIX	TULSA, OK VORTAC	3400	17500
<b>95.3423 RNAV ROUTE T423</b>			
STYLZ, NC WP	*ROANS, TN FIX	8900	17500
*8200 - MCA ROANS, TN FIX , S BND			
ROANS, TN FIX	HORAL, TN WP	6900	17500
HORAL, TN WP	GAUZY, VA WP	6700	17500
GAUZY, VA WP	ZOMAD, VA FIX	6500	17500
ZOMAD, VA FIX	STACY, VA FIX	5900	17500
STACY, VA FIX	SLINK, WV FIX	4700	17500
SLINK, WV FIX	MACET, WV FIX	4800	17500
MACET, WV FIX	DIPUH, WV FIX	4400	17500
DIPUH, WV FIX	CHARLESTON, WV VOR/DME	4400	17500
<b>95.3425 RNAV ROUTE T425</b>			
SIROC, GA WP	BERTT, GA FIX	1800	17500

FROM	TO	MEA	MAA
<b>95.3425 RNAV ROUTE T425 - CONTINUED</b>			
BERTT, GA FIX	HABLE, GA FIX	1800	17500
HABLE, GA FIX	CROCS, GA WP	2300	17500
CROCS, GA WP	RIPPI, GA FIX	2300	17500
RIPPI, GA FIX	WOGOM, GA FIX	2300	17500
WOGOM, GA FIX	SINCA, GA FIX	2400	17500
SINCA, GA FIX	CANUK, GA FIX	2400	17500
CANUK, GA FIX	WEMOB, GA FIX	2400	17500
WEMOB, GA FIX	HUSKY, GA FIX	2500	17500
<b>95.3427 RNAV ROUTE T427</b>			
CAYCE, SC WP	HUFMN, SC WP	2400	17500
HUFMN, SC WP	BLANE, SC FIX	2400	17500
BLANE, SC FIX	VESTO, GA FIX	2300	17500
VESTO, GA FIX	DNICE, GA WP	2400	17500
DNICE, GA WP	UGAAA, GA WP	2500	17500
UGAAA, GA WP	*CONLY, GA WP	2700	17500
*3500 - MCA CONLY, GA WP , NW BND			
CONLY, GA WP	*WOMAC, GA FIX	4700	17500
*4700 - MCA WOMAC, GA FIX , SE BND			
WOMAC, GA FIX	LOGEN, GA FIX	4100	17500
<b>95.3429 RNAV ROUTE T429</b>			
HOKES, AL FIX	SNEAR, AL FIX	3800	17500
SNEAR, AL FIX	*JOSEP, AL FIX	3700	17500
*3200 - MCA JOSEP, AL FIX , SE BND			
JOSEP, AL FIX	FEWER, AL FIX	2800	17500
FEWER, AL FIX	LEACH, AL WP	2900	17500
LEACH, AL WP	MASHA, AL WP	2500	17500
MASHA, AL WP	JUVLO, AL FIX	2500	17500
JUVLO, AL FIX	HAGIE, AL WP	2600	17500
<b>95.3430 RNAV ROUTE T430</b>			
PHILIPSBURG, PA VORTAC	SELINGROVE, PA VOR/DME	4900	17500
SELINGROVE, PA VOR/DME	*PINNA, PA FIX	3500	17500
*3100 - MCA PINNA, PA FIX , NW BND			
PINNA, PA FIX	EAST TEXAS, PA VOR/DME	2700	17500
EAST TEXAS, PA VOR/DME	TROXL, PA FIX	2600	17500
TROXL, PA FIX	BOPLY, PA FIX	2400	17500
BOPLY, PA FIX	*LANNA, NJ FIX	2400	17500
*5000 - MRA			
LANNA, NJ FIX	SOLBERG, NJ VOR/DME	2400	17500
<b>95.3431 RNAV ROUTE T431</b>			
KENTO, NM FIX	ADEOS, OK WP	6700	17500
ADEOS, OK WP	TOTOE, KS WP	5600	17500
TOTOE, KS WP	MOZEE, KS WP	4800	17500
MOZEE, KS WP	KNSAS, KS WP	3900	17500
<b>95.3435 RNAV ROUTE T435</b>			
HOLIM, AK WP	*RAYMD, AK FIX	4200	17500
*5300 - MCA RAYMD, AK FIX , N BND			
RAYMD, AK FIX	*FEPAB, AK WP	8400	17500
*7500 - MCA FEPAB, AK WP , S BND			
FEPAB, AK WP	WIXER, AK WP	6000	17500

FROM	TO	MEA	MAA
<b>95.3435 RNAV ROUTE T435 - CONTINUED</b>			
WIXER, AK WP	OBUKE, AK FIX	2600	17500
OBUKE, AK FIX	ZILKO, AK FIX	*3700	17500
*1200 - MOCA			
ZILKO, AK FIX	KING SALMON, AK VORTAC	*3300	17500
*1600 - MOCA			
<b>95.3438 RNAV ROUTE T438</b>			
RASHE, PA FIX	*HERDA, PA FIX	4600	17500
*4300 - MCA HERDA, PA FIX , W BND			
HERDA, PA FIX	MORTO, PA FIX	3800	17500
MORTO, PA FIX	RAVINE, PA VORTAC	3500	17500
RAVINE, PA VORTAC	VAYRE, PA FIX	3500	17500
VAYRE, PA FIX	DUMMR, PA FIX	3400	17500
DUMMR, PA FIX	FLOAT, PA FIX	3200	17500
FLOAT, PA FIX	*HIKES, PA FIX	**2900	17500
*4000 - MRA			
**2400 - MOCA			
HIKES, PA FIX	*MAZIE, PA FIX	2800	17500
*5000 - MRA			
MAZIE, PA FIX	YARDLEY, PA VOR/DME	2000	17500
YARDLEY, PA VOR/DME	ROBBINSVILLE, NJ VORTAC	2100	17500
ROBBINSVILLE, NJ VORTAC	CASVI, NJ FIX	2000	17500
CASVI, NJ FIX	ZIGGI, NJ FIX	1900	17500
ZIGGI, NJ FIX	*PREPI, OA FIX	1700	17500
*8000 - MRA			
<b>95.3462 RNAV ROUTE T462</b>			
BISMARCK, ND VOR/DME	WISEK, ND FIX	3900	17500
WISEK, ND FIX	IRIWY, ND FIX	4000	17500
IRIWY, ND FIX	ABERDEEN, SD VOR/DME	3900	17500
ABERDEEN, SD VOR/DME	FIBDA, SD WP	3000	17500
FIBDA, SD WP	WICKA, SD FIX	3600	17500
WICKA, SD FIX	FFORT, SD WP	*3700	17500
*3200 - MOCA			
FFORT, SD WP	DAWSO, MN WP	3800	17500
DAWSO, MN WP	CLAPS, MN FIX	2800	17500
CLAPS, MN FIX	FITAS, MN FIX	2900	17500
FITAS, MN FIX	GENEO, MN WP	3000	17500
<b>95.3464 RNAV ROUTE T464</b>			
CUSAY, WI WP	TONOC, WI FIX	3400	17500
TONOC, WI FIX	EDGRR, WI WP	3200	17500
EDGRR, WI WP	HEVAV, WI WP	3300	17500
HEVAV, WI WP	CHURP, WI FIX	3100	17500
<b>95.3466 RNAV ROUTE T466</b>			
SAN ANGELO, TX VORTAC	CHILD, TX FIX	4000	17500
CHILD, TX FIX	JUNCTION, TX VORTAC	4000	17500
JUNCTION, TX VORTAC	STONEWALL, TX VORTAC	4000	17500
STONEWALL, TX VORTAC	GOBBY, TX FIX	4100	17500
GOBBY, TX FIX	BETTI, TX FIX	3400	17500
BETTI, TX FIX	MARCS, TX FIX	2900	17500
MARCS, TX FIX	SEEDS, TX WP	2400	17500
SEEDS, TX WP	LDRET, TX WP	3000	17500
LDRET, TX WP	KEEDS, TX WP	1900	17500

FROM	TO	MEA	MAA
<b>95.3466 RNAV ROUTE T466 - CONTINUED</b>			
KEEDS, TX WP	SCHOLES, TX VOR/DME	3100	17500
SCHOLES, TX VOR/DME	SABINE PASS, TX VOR/DME	2000	17500
<b>95.3608 RNAV ROUTE T608</b>			
HOCKE, MI WP	U.S. CANADIAN BORDER	*3500	17500
*2900 - MOCA			
U.S. CANADIAN BORDER	WOZEE, NY WP	2400	17500
WOZEE, NY WP	CLUNG, NY WP	2700	17500
CLUNG, NY WP	ROCHESTER, NY VOR/DME	2500	17500
ROCHESTER, NY VOR/DME	LORTH, NY FIX	2500	17500
LORTH, NY FIX	SYRACUSE, NY VORTAC	2400	17500
SYRACUSE, NY VORTAC	STODA, NY FIX	2300	17500
STODA, NY FIX	VASTS, NY WP	3000	17500
VASTS, NY WP	LAMMS, NY WP	3400	17500
LAMMS, NY WP	NORSE, NY WP	3500	17500
NORSE, NY WP	MARIA, NY FIX	3400	17500
MARIA, NY FIX	ALBANY, NY VORTAC	3000	17500
ALBANY, NY VORTAC	*WARUV, NY WP	3100	17500
*3700 - MCA WARUV, NY WP , E BND			
WARUV, NY WP	*GRAVE, NY WP	4100	17500
*4400 - MCA GRAVE, NY WP , SE BND			
GRAVE, NY WP	GRISY, MA WP	5300	17500
GRISY, MA WP	WARIC, MA WP	4700	17500
WARIC, MA WP	HURLY, MA WP	3300	17500
HURLY, MA WP	GARDNER, MA VOR/DME	3000	17500
GARDNER, MA VOR/DME	GRAYM, MA FIX	3000	17500
GRAYM, MA FIX	BLATT, CT FIX	*2800	17500
*2300 - MOCA			
BLATT, CT FIX	MOGUL, CT FIX	2500	17500
MOGUL, CT FIX	YANTC, CT WP	2300	17500
<b>95.3616 RNAV ROUTE T616</b>			
FLINT, MI VORTAC	URSSA, MI WP	2500	17500
URSSA, MI WP	HOCKE, MI WP	2800	17500
HOCKE, MI WP	U.S. CANADIAN BORDER	*6000	17500
*2100 - MOCA			
<b>95.3634 RNAV ROUTE T634</b>			
SYRACUSE, NY VORTAC	PAGER, NY FIX	2300	17500
PAGER, NY FIX	BRUIN, NY WP	2600	17500
BRUIN, NY WP	WATERTOWN, NY VORTAC	2600	17500
WATERTOWN, NY VORTAC	U.S. CANADIAN BORDER	2000	17500
<b>95.3662 RNAV ROUTE T662</b>			
U.S. CANADIAN BORDER	KATAH, ME WP	*7000	17500
*4600 - MOCA			
KATAH, ME WP	HULTN, ME WP	5800	17500
<b>95.3698 RNAV ROUTE T698</b>			
U.S. CANADIAN BORDER	HULTN, ME WP	7600	17500
HULTN, ME WP	U.S. CANADIAN BORDER	2500	17500
<b>95.3705 RNAV ROUTE T705</b>			
DANZI, NY WP	CODDI, NY FIX	4400	17500

FROM	TO	MEA	MAA
<b>95.3705 RNAV ROUTE T705 - CONTINUED</b>			
CODDI, NY FIX	MILID, NY FIX	4000	17500
MILID, NY FIX	LAMMS, NY WP	3800	17500
LAMMS, NY WP	USICI, NY FIX	3400	17500
USICI, NY FIX	GACKE, NY WP	4100	17500
GACKE, NY WP	BECKS, NY WP	5200	17500
BECKS, NY WP	SMAIR, NY WP	5400	17500
SMAIR, NY WP	FOSYU, NY WP	5300	17500
FOSYU, NY WP	SRNAC, NY WP	5400	17500
SRNAC, NY WP	UUBER, NY WP	5100	17500
UUBER, NY WP	*RIGID, NY WP	5400	17500
*4800 - MCA RIGID, NY WP , W BND			
RIGID, NY WP	PBERG, NY WP	3800	17500
PBERG, NY WP	LATTS, NY WP	3200	17500
LATTS, NY WP	U.S. CANADIAN BORDER	2900	17500
<b>95.3768 RNAV ROUTE T768</b>			
INTERNATIONAL FALLS, MN VOR/DME	YUPNU, MN WP	2900	17500
YUPNU, MN WP	CIVLU, MN FIX	3000	17500
CIVLU, MN FIX	U.S. CANADIAN BORDER	3000	17500
<b>95.3781 RNAV ROUTE T781</b>			
FLINT, MI VORTAC	KATTY, MI FIX	*3000	17500
*2300 - MOCA			
KATTY, MI FIX	HANKY, MI WP	*4000	17500
*2900 - MOCA			
HANKY, MI WP	ADRIE, MI WP	*4000	17500
*2800 - MOCA			
ADRIE, MI WP	MARGN, MI FIX	*4000	17500
*2800 - MOCA			
MARGN, MI FIX	BLUEZ, MI WP	*4000	17500
*2800 - MOCA			
BLUEZ, MI WP	U.S. CANADIAN BORDER	*4000	17500
*2800 - MOCA			
U.S. CANADIAN BORDER	HULTN, ME WP	*7000	17500
*4000 - MOCA			
<b>TK502 RNAV ROUTE TK502</b>			
WESTMINSTER, MD VORTAC	TAYLO, MD WP	2700	17500
TAYLO, MD WP	WINGO, PA WP	*2500	17500
*2000 - MOCA			
WINGO, PA WP	SINON, PA WP	2400	17500
SINON, PA WP	GRIBL, PA WP	2400	17500
GRIBL, PA WP	TOLAN, NJ WP	2100	17500
TOLAN, NJ WP	BALDE, NY WP	*2100	17500
*1500 - MOCA			
BALDE, NY WP	SPATE, NY WP	*2100	17500
*1400 - MOCA			
SPATE, NY WP	DECKR, NY WP	2900	17500
<b>TK504 RNAV ROUTE TK504</b>			
RUSEY, MD WP	CIDOB, MD WP	*1800	17500
*1500 - MOCA			
CIDOB, MD WP	HAMOR, PA WP	2300	17500
HAMOR, PA WP	ARCUM, PA WP	*2300	17500
*2000 - MOCA			

FROM

TO

MEA

MAA

**TK504 RNAV ROUTE TK504 - CONTINUED**

ARCUM, PA WP	TULLY, PA WP	2600	17500
TULLY, PA WP	BORKE, NJ FIX	2000	17500
BORKE, NJ FIX	BANKA, NJ WP	2000	17500

FROM	TO	MEA	MAA
------	----	-----	-----

**§95.4000 HIGH ALTITUDE RNAV ROUTES**

**95.4001 RNAV ROUTE Q1**

POINT REYES, CA VOR/DME *18000 - GNSS MEA *DME/DME/IRU MEA	ETCHY, CA WP	*24000	45000
ETCHY, CA WP *18000 - GNSS MEA *DME/DME/IRU MEA	TOCOS, CA WP	*24000	45000
TOCOS, CA WP *18000 - GNSS MEA *DME/DME/IRU MEA	ENVIE, CA WP	*24000	45000
ENVIE, CA WP *18000 - GNSS MEA *DME/DME/IRU MEA	ELENN, CA WP	*24000	45000
ELENN, CA WP *18000 - GNSS MEA *DME/DME/IRU MEA	EBINY, OR WP	*24000	45000
EBINY, OR WP *18000 - GNSS MEA *DME/DME/IRU MEA	EASON, OR WP	*24000	45000
EASON, OR WP *18000 - GNSS MEA *DME/DME/IRU MEA	ERAVE, WA WP	*24000	45000
ERAVE, WA WP *18000 - GNSS MEA *DME/DME/IRU MEA	ELMAA, WA FIX	*24000	45000

**95.4002 RNAV ROUTE Q2**

BOILE, CA FIX *18000 - GNSS MEA *DME/DME/IRU MEA	HEDVI, AZ WP	*24000	45000
HEDVI, AZ WP *18000 - GNSS MEA *DME/DME/IRU MEA	HOBOL, AZ WP	*24000	45000
HOBOL, AZ WP *18000 - GNSS MEA *DME/DME/IRU MEA	ITUCO, AZ WP	*24000	45000
ITUCO, AZ WP *18000 - GNSS MEA *DME/DME/IRU MEA	NEWMAN, TX VORTAC	*26000	45000

**95.4003 RNAV ROUTE Q3**

FEPOT, WA WP *18000 - GNSS MEA *DME/DME/IRU MEA	POINT REYES, CA VOR/DME	*24000	45000
---	-------------------------	--------	-------

**95.4004 RNAV ROUTE Q4**

BOILE, CA FIX *18000 - GNSS MEA *DME/DME/IRU MEA	SKTTR, AZ WP	*24000	45000
SKTTR, AZ WP *18000 - GNSS MEA *DME/DME/IRU MEA	EL PASO, TX VORTAC	*26000	45000



FROM	TO	MEA	MAA
<b>95.4005 RNAV ROUTE Q5</b>			
HAROB, WA WP *18000 - GNSS MEA *DME/DME/IRU MEA	STIKM, CA WP	*26000	45000
<b>95.4006 RNAV ROUTE Q6</b>			
TALKEETNA, AK VOR/DME *GNSS REQUIRED	BARROW, AK VOR/DME	*18000	45000
<b>95.4007 RNAV ROUTE Q7</b>			
JINMO, WA WP *18000 - GNSS MEA *DME/DME/IRU MEA	JOGEN, OR WP	*24000	45000
JOGEN, OR WP *18000 - GNSS MEA *DME/DME/IRU MEA	JUNEJ, CA WP	*24000	45000
JUNEJ, CA WP *18000 - GNSS MEA *DME/DME/IRU MEA	JAGWA, CA WP	*24000	45000
JAGWA, CA WP *18000 - GNSS MEA *DME/DME/IRU MEA	AVENAL, CA VOR/DME	*24000	45000
<b>95.4008 RNAV ROUTE Q8</b>			
GALENA, AK VOR/DME *GNSS REQUIRED	ANCHORAGE, AK VOR/DME	*18000	45000
<b>95.4009 RNAV ROUTE Q9</b>			
SUMMA, WA FIX *18000 - GNSS MEA *DME/DME/IRU MEA	DERBB, CA FIX	*24000	45000
<b>95.4010 RNAV ROUTE Q10</b>			
KUKULIAK, AK VOR/DME *GNSS REQUIRED	EMMONAK, AK VOR/DME	*18000	45000
<b>95.4011 RNAV ROUTE Q11</b>			
PAAGE, WA WP *18000 - GNSS MEA *DME/DME/IRU MEA	LOS ANGELES, CA VORTAC	*26000	45000
<b>95.4012 RNAV ROUTE Q12</b>			
KOTZEBUE, AK VOR/DME *GNSS REQUIRED	DEADHORSE, AK VOR/DME	*18000	45000
<b>95.4013 RNAV ROUTE Q13</b>			
EL PASO, TX VORTAC *18000 - GNSS MEA *DME/DME/IRU MEA	VERNO, AZ FIX	*24000	45000
VERNO, AZ FIX *18000 - GNSS MEA *DME/DME/IRU MEA	NABOB, AZ FIX	*24000	45000

FROM	TO	MEA	MAA
<b>95.4013 RNAV ROUTE Q13 - CONTINUED</b>			
NABOB, AZ FIX *18000 - GNSS MEA *DME/DME/IRU MEA	DRAKE, AZ VORTAC	*24000	45000
DRAKE, AZ VORTAC *18000 - GNSS MEA *DME/DME/IRU MEA	WOTRO, AZ FIX	*24000	45000
WOTRO, AZ FIX *18000 - GNSS MEA *DME/DME/IRU MEA	PRFUM, AZ FIX	*24000	45000
PRFUM, AZ FIX *18000 - GNSS MEA *DME/DME/IRU MEA	HOUZZ, NV WP	*24000	45000
HOUZZ, NV WP *18000 - GNSS MEA *DME/DME/IRU MEA	FUULL, NV WP	*25000	45000
FUULL, NV WP *18000 - GNSS MEA *DME/DME/IRU MEA	SKANN, NV WP	*25000	45000
SKANN, NV WP *18000 - GNSS MEA *DME/DME/IRU MEA	SHUFL, NV WP	*25000	45000
SHUFL, NV WP *18000 - GNSS MEA *DME/DME/IRU MEA	LOMIA, NV WP	*25000	45000
LOMIA, NV WP *18000 - GNSS MEA *DME/DME/IRU MEA	RUFUS, CA WP	*25000	45000
RUFUS, CA WP *18000 - GNSS MEA *DME/DME/IRU MEA	PAWLI, OR WP	*25000	45000

**95.4014 RNAV ROUTE Q14**

KODIAK, AK VOR/DME *GNSS REQUIRED	JOHNSTONE POINT, AK VOR/DME	*18000	45000
--------------------------------------	-----------------------------	--------	-------

**95.4015 RNAV ROUTE Q15**

NABOB, AZ FIX *18000 - GNSS MEA *DME/DME/IRU MEA	CHILY, AZ FIX	*24000	45000
CHILY, AZ FIX *18000 - GNSS MEA *DME/DME/IRU MEA	DOVEE, NV FIX	*24000	45000
DOVEE, NV FIX *18000 - GNSS MEA *DME/DME/IRU MEA	SOTOO, NV WP	*24000	45000
SOTOO, NV WP *18000 - GNSS MEA *DME/DME/IRU MEA	HOUZZ, NV WP	*24000	45000
HOUZZ, NV WP *18000 - GNSS MEA *DME/DME/IRU MEA	FUULL, NV WP	*25000	45000
FUULL, NV WP *18000 - GNSS MEA *DME/DME/IRU MEA	SKANN, NV WP	*25000	45000
SKANN, NV WP *18000 - GNSS MEA *DME/DME/IRU MEA	SHUFL, NV WP	*25000	45000

FROM	TO	MEA	MAA
<b>95.4015 RNAV ROUTE Q15 - CONTINUED</b>			
SHUFL, NV WP *18000 - GNSS MEA *DME/DME/IRU MEA	LOMIA, NV WP	*25000	45000
<b>95.4016 RNAV ROUTE Q16</b>			
KODIAK, AK VOR/DME *GNSS REQUIRED	MIDDLETON ISLAND, AK VOR/DME	*18000	45000
MIDDLETON ISLAND, AK VOR/DME *GNSS REQUIRED	YAKUTAT, AK VOR/DME	*18000	45000
<b>95.4017 RNAV ROUTE Q17</b>			
HOMER, AK VOR/DME *GNSS REQUIRED	MIDDLETON ISLAND, AK VOR/DME	*18000	45000
<b>95.4018 RNAV ROUTE Q18</b>			
GALENA, AK VOR/DME *GNSS REQUIRED	BARROW, AK VOR/DME	*18000	45000
<b>95.4019 RNAV ROUTE Q19</b>			
BULZI, FL WP *18000 - GNSS MEA *DME/DME/IRU MEA	WYATT, GA WP	*18000	45000
WYATT, GA WP *18000 - GNSS MEA *DME/DME/IRU MEA	GOONS, GA WP	*18000	45000
GOONS, GA WP *18000 - GNSS MEA *DME/DME/IRU MEA	LAYIN, AL WP	*18000	45000
LAYIN, AL WP *18000 - GNSS MEA *DME/DME/IRU MEA	TOJXE, AL WP	*18000	45000
TOJXE, AL WP *18000 - GNSS MEA *DME/DME/IRU MEA	HITMN, TN WP	*18000	45000
HITMN, TN WP *18000 - GNSS MEA *DME/DME/IRU MEA	PLESS, IL FIX	*18000	45000
PLESS, IL FIX *18000 - GNSS MEA *DME/DME/IRU MEA	ST LOUIS, MO VORTAC	*18000	45000
ST LOUIS, MO VORTAC *18000 - GNSS MEA *DME/DME/IRU MEA	DES MOINES, IA VORTAC	*18000	45000
DES MOINES, IA VORTAC *18000 - GNSS MEA *DME/DME/IRU MEA	SIoux FALLS, SD VORTAC	*18000	45000
SIoux FALLS, SD VORTAC *18000 - GNSS MEA *DME/DME/IRU MEA	ABERDEEN, SD VOR/DME	*18000	45000
<b>95.4020 RNAV ROUTE Q20</b>			
CORONA, NM VORTAC *18000 - GNSS MEA *DME/DME/IRU MEA	HONDS, NM FIX	*24000	45000

FROM	TO	MEA	MAA
<b>95.4020 RNAV ROUTE Q20 - CONTINUED</b>			
HONDS, NM FIX *18000 - GNSS MEA *DME/DME/IRU MEA	UNNOS, NM WP	*24000	45000
UNNOS, NM WP *18000 - GNSS MEA *DME/DME/IRU MEA	FUSCO, TX FIX	*24000	45000
FUSCO, TX FIX *18000 - GNSS MEA *DME/DME/IRU MEA	JUNCTION, TX VORTAC	*24000	45000
<b>95.4021 RNAV ROUTE Q21</b>			
JONEZ, OK WP *18000 - GNSS MEA *DME/DME/IRU MEA	RAZORBACK, AR VORTAC	*18000	45000
<b>95.4022 RNAV ROUTE Q22</b>			
GUSTI, LA FIX *18000 - GNSS MEA *DME/DME/IRU MEA	OYSTY, LA FIX	*18000	45000
OYSTY, LA FIX *18000 - GNSS MEA *DME/DME/IRU MEA	ACMES, AL WP	*18000	45000
ACMES, AL WP *18000 - GNSS MEA *DME/DME/IRU MEA	CATLN, AL FIX	*18000	45000
CATLN, AL FIX *18000 - GNSS MEA *DME/DME/IRU MEA	TWOUP, GA WP	*18000	45000
TWOUP, GA WP *18000 - GNSS MEA *DME/DME/IRU MEA	BURGG, SC WP	*18000	45000
BURGG, SC WP *18000 - GNSS MEA *DME/DME/IRU MEA	NYBLK, NC WP	*18000	45000
NYBLK, NC WP *18000 - GNSS MEA *DME/DME/IRU MEA	MASHI, NC WP	*18000	45000
MASHI, NC WP *18000 - GNSS MEA *DME/DME/IRU MEA	KIDDO, NC WP	*18000	45000
KIDDO, NC WP *18000 - GNSS MEA *DME/DME/IRU MEA	OMENS, VA WP	*18000	45000
OMENS, VA WP *18000 - GNSS MEA *DME/DME/IRU MEA	BEARI, VA WP	*18000	45000
BEARI, VA WP *18000 - GNSS MEA *DME/DME/IRU MEA	UMBRE, VA WP	*18000	45000
UMBRE, VA WP *18000 - GNSS MEA *DME/DME/IRU MEA	BBOBO, VA WP	*18000	45000
BBOBO, VA WP *18000 - GNSS MEA *DME/DME/IRU MEA	SHTGN, MD WP	*18000	45000
SHTGN, MD WP *18000 - GNSS MEA *DME/DME/IRU MEA	SYFER, MD WP	*18000	45000

FROM	TO	MEA	MAA
------	----	-----	-----

**95.4022 RNAV ROUTE Q22 - CONTINUED**

SYFER, MD WP *18000 - GNSS MEA *DME/DME/IRU MEA	DANGR, MD WP	*18000	45000
DANGR, MD WP *18000 - GNSS MEA *DME/DME/IRU MEA	PYTHN, DE WP	*18000	45000
PYTHN, DE WP *18000 - GNSS MEA *DME/DME/IRU MEA	BESSI, NJ FIX	*18000	45000
BESSI, NJ FIX *18000 - GNSS MEA *DME/DME/IRU MEA	JOEPO, NJ WP	*18000	45000
JOEPO, NJ WP *18000 - GNSS MEA *DME/DME/IRU MEA	BRAND, NJ FIX	*18000	45000
BRAND, NJ FIX *18000 - GNSS MEA *DME/DME/IRU MEA	ROBBINSVILLE, NJ VORTAC	*18000	45000
ROBBINSVILLE, NJ VORTAC *18000 - GNSS MEA *DME/DME/IRU MEA	LAURN, NY WP	*18000	45000
LAURN, NY WP *18000 - GNSS MEA *DME/DME/IRU MEA	LLUND, NY FIX	*18000	45000
LLUND, NY FIX *18000 - GNSS MEA *DME/DME/IRU MEA	BAYYS, CT FIX	*18000	45000
BAYYS, CT FIX *18000 - GNSS MEA *DME/DME/IRU MEA	FOXWD, CT WP	*18000	45000

**95.4023 RNAV ROUTE Q23**

FORT SMITH, AR VORTAC *18000 - GNSS MEA *DME/DME/IRU MEA	RAZORBACK, AR VORTAC	*18000	45000
--	----------------------	--------	-------

**95.4024 RNAV ROUTE Q24**

SAN ANTONIO, TX VORTAC *18000 - GNSS MEA *DME/DME/IRU MEA	MOLLR, TX WP	*18000	45000
MOLLR, TX WP *18000 - GNSS MEA *DME/DME/IRU MEA	LAKE CHARLES, LA VORTAC	*18000	45000
LAKE CHARLES, LA VORTAC *18000 - GNSS MEA *DME/DME/IRU MEA	FIGHTING TIGER, LA VORTAC	*20000	45000
FIGHTING TIGER, LA VORTAC *18000 - GNSS MEA *DME/DME/IRU MEA	IRUBE, MS WP	*20000	45000
IRUBE, MS WP *18000 - GNSS MEA *DME/DME/IRU MEA	PAYTN, AL FIX	*20000	45000

**95.4025 RNAV ROUTE Q25**

MEEOW, AR FIX *18000 - GNSS MEA *DME/DME/IRU MEA	WALNUT RIDGE, AR VORTAC	*20000	45000
--	-------------------------	--------	-------

FROM	TO	MEA	MAA
------	----	-----	-----

**95.4025 RNAV ROUTE Q25 - CONTINUED**

WALNUT RIDGE, AR VORTAC *18000 - GNSS MEA *DME/DME/IRU MEA	POCKET CITY, IN VORTAC	*20000	45000
--	------------------------	--------	-------

**95.4026 RNAV ROUTE Q26**

WALNUT RIDGE, AR VORTAC *18000 - GNSS MEA *DME/DME/IRU MEA	DEVAC, AL FIX	*20000	33000
--	---------------	--------	-------

**95.4027 RNAV ROUTE Q27**

FORT SMITH, AR VORTAC *18000 - GNSS MEA *DME/DME/IRU MEA	ZALDA, AR WP	*18000	45000
--	--------------	--------	-------

**95.4028 RNAV ROUTE Q28**

GRAZN, AR WP *18000 - GNSS MEA *DME/DME/IRU MEA	POCKET CITY, IN VORTAC	*20000	45000
---	------------------------	--------	-------

**95.4029 RNAV ROUTE Q29**

HARES, LA WP *18000 - GNSS MEA *DME/DME/IRU MEA	BAKRE, MS WP	*18000	45000
BAKRE, MS WP *18000 - GNSS MEA *DME/DME/IRU MEA	MEMFS, TN WP	*18000	45000
MEMFS, TN WP *18000 - GNSS MEA *DME/DME/IRU MEA	OMDUE, TN WP	*18000	45000
OMDUE, TN WP *18000 - GNSS MEA *DME/DME/IRU MEA	SIDAE, KY WP	*18000	45000
SIDAE, KY WP *18000 - GNSS MEA *DME/DME/IRU MEA	CREEP, OH FIX	*18000	45000
CREEP, OH FIX *18000 - GNSS MEA *DME/DME/IRU MEA	KLYNE, OH WP	*18000	45000
KLYNE, OH WP *18000 - GNSS MEA *DME/DME/IRU MEA	DUTSH, OH WP	*18000	45000
DUTSH, OH WP *18000 - GNSS MEA *DME/DME/IRU MEA	WWSHR, OH WP	*18000	45000
WWSHR, OH WP *18000 - GNSS MEA *DME/DME/IRU MEA	DORET, OH FIX	*18000	45000
DORET, OH FIX *18000 - GNSS MEA *DME/DME/IRU MEA	JAMESTOWN, NY VOR/DME	*18000	45000
JAMESTOWN, NY VOR/DME *18000 - GNSS MEA *DME/DME/IRU MEA	HANKK, NY WP	*18000	45000
HANKK, NY WP *18000 - GNSS MEA *DME/DME/IRU MEA	GONZZ, NY WP	*18000	45000

FROM	TO	MEA	MAA
<b>95.4029 RNAV ROUTE Q29 - CONTINUED</b>			
GONZZ, NY WP *18000 - GNSS MEA *DME/DME/IRU MEA	KRAZZ, NY WP	*18000	45000
KRAZZ, NY WP *18000 - GNSS MEA *DME/DME/IRU MEA	NIPPY, NY WP	*18000	45000
NIPPY, NY WP *18000 - GNSS MEA *DME/DME/IRU MEA	CABCI, VT WP	*18000	45000
CABCI, VT WP *GNSS REQUIRED	EBONY, ME FIX	*18000	45000
EBONY, ME FIX *GNSS REQUIRED	U.S. CANADIAN BORDER	*18000	45000
<b>95.4030 RNAV ROUTE Q30</b>			
IZAAC, MS WP *18000 - GNSS MEA *DME/DME/IRU MEA	SKNRR, MS WP	*18000	45000
SKNRR, MS WP *18000 - GNSS MEA *DME/DME/IRU MEA	VLKNN, AL WP	*18000	45000
<b>95.4031 RNAV ROUTE Q31</b>			
DHART, AR FIX *18000 - GNSS MEA *DME/DME/IRU MEA	MARVELL, AR VOR/DME	*18000	45000
MARVELL, AR VOR/DME *18000 - GNSS MEA *DME/DME/IRU MEA	POCKET CITY, IN VORTAC	*18000	45000
<b>95.4032 RNAV ROUTE Q32</b>			
EL DORADO, AR VOR/DME *18000 - GNSS MEA *DME/DME/IRU MEA	GAGLE, MS WP	*20000	45000
GAGLE, MS WP *18000 - GNSS MEA *DME/DME/IRU MEA	CRAMM, MS WP	*20000	45000
CRAMM, MS WP *18000 - GNSS MEA *DME/DME/IRU MEA	NASHVILLE, TN VORTAC	*20000	45000
NASHVILLE, TN VORTAC *18000 - GNSS MEA *DME/DME/IRU MEA	SWAPP, TN FIX	*20000	45000
<b>95.4033 RNAV ROUTE Q33</b>			
DHART, AR FIX *18000 - GNSS MEA *DME/DME/IRU MEA	LITTLE ROCK, AR VORTAC	*20000	45000
LITTLE ROCK, AR VORTAC *18000 - GNSS MEA *DME/DME/IRU MEA	PROWL, MO WP	*20000	45000
<b>95.4034 RNAV ROUTE Q34</b>			
TEXARKANA, AR VORTAC *18000 - GNSS MEA *DME/DME/IRU MEA	LOOSE, AR WP	*18000	45000

FROM	TO	MEA	MAA
LOOSE, AR WP *18000 - GNSS MEA *DME/DME/IRU MEA	WASKO, AR FIX	*18000	45000
WASKO, AR FIX *18000 - GNSS MEA *DME/DME/IRU MEA	MATIE, AR WP	*18000	45000
MATIE, AR WP *18000 - GNSS MEA *DME/DME/IRU MEA	EDWAH, AR WP	*18000	45000
EDWAH, AR WP *18000 - GNSS MEA *DME/DME/IRU MEA	MEMFS, TN WP	*18000	45000
MEMFS, TN WP *18000 - GNSS MEA *DME/DME/IRU MEA	HENSY, TN WP	*18000	45000
HENSY, TN WP *18000 - GNSS MEA *DME/DME/IRU MEA	WAKOL, TN WP	*18000	45000
WAKOL, TN WP *18000 - GNSS MEA *DME/DME/IRU MEA	HITMN, TN WP	*18000	45000
HITMN, TN WP *18000 - GNSS MEA *DME/DME/IRU MEA	SWAPP, TN FIX	*18000	45000
SWAPP, TN FIX *18000 - GNSS MEA *DME/DME/IRU MEA	GHATS, KY FIX	*18000	45000
GHATS, KY FIX *18000 - GNSS MEA *DME/DME/IRU MEA	FOUNT, KY FIX	*18000	45000
FOUNT, KY FIX *18000 - GNSS MEA *DME/DME/IRU MEA	TONIO, KY WP	*18000	45000
TONIO, KY WP *18000 - GNSS MEA *DME/DME/IRU MEA	KONGO, KY WP	*18000	45000
KONGO, KY WP *18000 - GNSS MEA *DME/DME/IRU MEA	NEALS, WV FIX	*18000	45000
NEALS, WV FIX *18000 - GNSS MEA *DME/DME/IRU MEA	SITTR, WV WP	*18000	45000
SITTR, WV WP *18000 - GNSS MEA *DME/DME/IRU MEA	ASBUR, WV WP	*18000	45000
ASBUR, WV WP *18000 - GNSS MEA *DME/DME/IRU MEA	DENNY, VA FIX	*18000	45000
DENNY, VA FIX *18000 - GNSS MEA *DME/DME/IRU MEA	MAULS, VA WP	*18000	45000
MAULS, VA WP *18000 - GNSS MEA *DME/DME/IRU MEA	GORDONSVILLE, VA VORTAC	*18000	45000
GORDONSVILLE, VA VORTAC *18000 - GNSS MEA *DME/DME/IRU MEA	BOOYA, VA WP	*18000	45000
BOOYA, VA WP *18000 - GNSS MEA *DME/DME/IRU MEA	DUALY, MD WP	*18000	45000



FROM	TO	MEA	MAA
<b>95.4034 RNAV ROUTE Q34 - CONTINUED</b>			
DUALY, MD WP *18000 - GNSS MEA *DME/DME/IRU MEA	BIGRG, MD WP	*18000	45000
BIGRG, MD WP *18000 - GNSS MEA *DME/DME/IRU MEA	PNGWN, NJ WP	*18000	45000
PNGWN, NJ WP *18000 - GNSS MEA *DME/DME/IRU MEA	HULKK, NJ WP	*18000	45000
HULKK, NJ WP *18000 - GNSS MEA *DME/DME/IRU MEA	ROBBINSVILLE, NJ VORTAC	*18000	45000
<b>95.4035 RNAV ROUTE Q35</b>			
DRAKE, AZ VORTAC *18000 - GNSS MEA *DME/DME/IRU MEA	CORKR, AZ FIX	*22000	45000
CORKR, AZ FIX *18000 - GNSS MEA *DME/DME/IRU MEA	WINEN, UT WP	*29000	45000
WINEN, UT WP *18000 - GNSS MEA *DME/DME/IRU MEA	NEERO, NV WP	*29000	45000
NEERO, NV WP *18000 - GNSS MEA *DME/DME/IRU MEA	KOATA, OR WP	*29000	45000
KOATA, OR WP *18000 - GNSS MEA *DME/DME/IRU MEA	KIMBERLY, OR VOR/DME	*29000	45000
<b>95.4036 RNAV ROUTE Q36</b>			
RAZORBACK, AR VORTAC *18000 - GNSS MEA *DME/DME/IRU MEA	NASHVILLE, TN VORTAC	*20000	45000
NASHVILLE, TN VORTAC *18000 - GNSS MEA *DME/DME/IRU MEA	SWAPP, TN FIX	*20000	45000
<b>95.4037 RNAV ROUTE Q37</b>			
FORT STOCKTON, TX VORTAC *18000 - GNSS MEA *DME/DME/IRU MEA	CAVRN, TX FIX	*25000	45000
CAVRN, TX FIX *18000 - GNSS MEA *DME/DME/IRU MEA	YORUB, NM WP	*25000	45000
YORUB, NM WP *18000 - GNSS MEA *DME/DME/IRU MEA	IMMAS, NM WP	*25000	45000
IMMAS, NM WP *18000 - GNSS MEA *DME/DME/IRU MEA	PUEBLO, CO VORTAC	*25000	45000
<b>95.4038 RNAV ROUTE Q38</b>			
ROKIT, TX WP *18000 - GNSS MEA *DME/DME/IRU MEA	BESOM, AL FIX	*18000	45000

FROM	TO	MEA	MAA
<b>95.4039 RNAV ROUTE Q39</b>			
CLAWD, NC WP *18000 - GNSS MEA *DME/DME/IRU MEA	TARCI, WV FIX	*18000	45000
TARCI, WV FIX *18000 - GNSS MEA *DME/DME/IRU MEA	ASERY, WV WP	*18000	45000
<b>95.4040 RNAV ROUTE Q40</b>			
ALEXANDRIA, LA VORTAC *18000 - GNSS MEA *DME/DME/IRU MEA	DOOMS, MS WP	*18000	45000
DOOMS, MS WP *18000 - GNSS MEA *DME/DME/IRU MEA	WINAP, MS WP	*18000	45000
WINAP, MS WP *18000 - GNSS MEA *DME/DME/IRU MEA	MISLE, AL WP	*18000	45000
MISLE, AL WP *18000 - GNSS MEA *DME/DME/IRU MEA	BFOLO, AL WP	*18000	45000
BFOLO, AL WP *18000 - GNSS MEA *DME/DME/IRU MEA	NIOLA, GA WP	*18000	45000
NIOLA, GA WP *18000 - GNSS MEA *DME/DME/IRU MEA	JAARE, TN WP	*18000	45000
JAARE, TN WP *18000 - GNSS MEA *DME/DME/IRU MEA	OJESS, TN WP	*18000	45000
OJESS, TN WP *18000 - GNSS MEA *DME/DME/IRU MEA	ALEAN, VA WP	*18000	45000
ALEAN, VA WP *18000 - GNSS MEA *DME/DME/IRU MEA	FEEDS, VA WP	*18000	45000
FEEDS, VA WP *18000 - GNSS MEA *DME/DME/IRU MEA	MAULS, VA WP	*18000	45000
MAULS, VA WP *18000 - GNSS MEA *DME/DME/IRU MEA	FANPO, VA WP	*18000	45000
<b>95.4041 RNAV ROUTE Q41</b>			
CAWIN, AK FIX *GNSS REQUIRED	DEADHORSE, AK VOR/DME	*18000	45000
<b>95.4042 RNAV ROUTE Q42</b>			
KIRKSVILLE, MO VORTAC *18000 - GNSS MEA *DME/DME/IRU MEA	DANVILLE, IL VORTAC	*34000	45000
DANVILLE, IL VORTAC *18000 - GNSS MEA *DME/DME/IRU MEA	MUNCIE, IN VOR/DME	*34000	45000
MUNCIE, IN VOR/DME *18000 - GNSS MEA *DME/DME/IRU MEA	BRNAN, PA WP	*24000	45000

FROM	TO	MEA	MAA
<b>95.4042 RNAV ROUTE Q42 - CONTINUED</b>			
BRNAN, PA WP *18000 - GNSS MEA *DME/DME/IRU MEA	HOTEE, PA WP	*18000	45000
HOTEE, PA WP *18000 - GNSS MEA *DME/DME/IRU MEA	MIKYG, PA WP	*18000	45000
MIKYG, PA WP *18000 - GNSS MEA *DME/DME/IRU MEA	SPOTZ, PA WP	*18000	45000
SPOTZ, PA WP *18000 - GNSS MEA *DME/DME/IRU MEA	ZIMMZ, PA FIX	*18000	45000
<b>95.4043 RNAV ROUTE Q43</b>			
ANCHORAGE, AK VOR/DME *GNSS REQUIRED	BIG LAKE, AK VORTAC	*18000	45000
BIG LAKE, AK VORTAC *GNSS REQUIRED	FAIRBANKS, AK VORTAC	*18000	45000
<b>95.4044 RNAV ROUTE Q44</b>			
NOME, AK VOR/DME *GNSS REQUIRED	HLBLY, AK WP	*18000	45000
HLBLY, AK WP *GNSS REQUIRED	ANCHORAGE, AK VOR/DME	*18000	45000
<b>95.4045 RNAV ROUTE Q45</b>			
DILLINGHAM, AK VOR/DME *GNSS REQUIRED	NONDA, AK FIX	*18000	45000
NONDA, AK FIX *GNSS REQUIRED	AMOTT, AK FIX	*18000	45000
<b>95.4046 RNAV ROUTE Q46</b>			
POINT HOPE, AK NDB *GNSS REQUIRED	BARROW, AK VOR/DME	*18000	45000
<b>95.4047 RNAV ROUTE Q47</b>			
KING SALMON, AK VORTAC *GNSS REQUIRED	AMOTT, AK FIX	*18000	45000
<b>95.4048 RNAV ROUTE Q48</b>			
BARROW, AK VOR/DME *GNSS REQUIRED	DEADHORSE, AK VOR/DME	*18000	45000
DEADHORSE, AK VOR/DME *GNSS REQUIRED	ROCES, AK WP	*18000	45000
<b>95.4049 RNAV ROUTE Q49</b>			
KODIAK, AK VOR/DME *GNSS REQUIRED	AMOTT, AK FIX	*18000	45000
<b>95.4050 RNAV ROUTE Q50</b>			
LOUISVILLE, KY VORTAC *18000 - GNSS MEA *DME/DME/IRU MEA	HELUB, KY WP	*18000	45000

FROM	TO	MEA	MAA
<b>95.4050 RNAV ROUTE Q50 - CONTINUED</b>			
HELUB, KY WP *18000 - GNSS MEA *DME/DME/IRU MEA	ENGRA, KY WP	*18000	45000
ENGRA, KY WP *18000 - GNSS MEA *DME/DME/IRU MEA	IBATE, KY WP	*18000	45000
IBATE, KY WP *18000 - GNSS MEA *DME/DME/IRU MEA	CUBIM, KY WP	*18000	45000
<b>95.4051 RNAV ROUTE Q51</b>			
KING SALMON, AK VORTAC *GNSS REQUIRED	SLIIM, AK WP	*18000	45000
SLIIM, AK WP *GNSS REQUIRED	HLBLY, AK WP	*18000	45000
HLBLY, AK WP *GNSS REQUIRED	KOTZEBUE, AK VOR/DME	*18000	45000
<b>95.4052 RNAV ROUTE Q52</b>			
CHOPZ, GA WP *18000 - GNSS MEA *DME/DME/IRU MEA	IPTAY, GA WP	*18000	45000
IPTAY, GA WP *18000 - GNSS MEA *DME/DME/IRU MEA	AWYAT, SC WP	*18000	45000
AWYAT, SC WP *18000 - GNSS MEA *DME/DME/IRU MEA	COLZI, NC WP	*18000	45000
<b>95.4053 RNAV ROUTE Q53</b>			
KODIAK, AK VOR/DME *GNSS REQUIRED	ILIAMNA, AK NDB/DME	*18000	45000
ILIAMNA, AK NDB/DME *GNSS REQUIRED	KOTZEBUE, AK VOR/DME	*18000	45000
<b>95.4054 RNAV ROUTE Q54</b>			
HRTWL, SC WP *18000 - GNSS MEA *DME/DME/IRU MEA	NYLLA, SC WP	*18000	45000
NYLLA, SC WP *18000 - GNSS MEA *DME/DME/IRU MEA	CHYPS, NC WP	*18000	45000
CHYPS, NC WP *18000 - GNSS MEA *DME/DME/IRU MEA	AHOEY, NC WP	*18000	45000
AHOEY, NC WP *18000 - GNSS MEA *DME/DME/IRU MEA	RAANE, NC WP	*18000	45000
RAANE, NC WP *18000 - GNSS MEA *DME/DME/IRU MEA	ASHEL, NC WP	*18000	45000
ASHEL, NC WP *18000 - GNSS MEA *DME/DME/IRU MEA	NUTZE, NC WP	*18000	45000
<b>95.4055 RNAV ROUTE Q55</b>			
KODIAK, AK VOR/DME *GNSS REQUIRED	SLIIM, AK WP	*18000	45000

FROM	TO	MEA	MAA
<b>95.4055 RNAV ROUTE Q55 - CONTINUED</b>			
SLIIM, AK WP *GNSS REQUIRED	NOME, AK VOR/DME	*18000	45000
<b>95.4056 RNAV ROUTE Q56</b>			
SAN ANTONIO, TX VORTAC *18000 - GNSS MEA *DME/DME/IRU MEA	MOLLR, TX WP	*18000	45000
MOLLR, TX WP *18000 - GNSS MEA *DME/DME/IRU MEA	PEKON, LA FIX	*18000	45000
PEKON, LA FIX *18000 - GNSS MEA *DME/DME/IRU MEA	HARVEY, LA VORTAC	*18000	45000
HARVEY, LA VORTAC *18000 - GNSS MEA *DME/DME/IRU MEA	SEMMES, AL VORTAC	*18000	45000
SEMMES, AL VORTAC *18000 - GNSS MEA *DME/DME/IRU MEA	CATLN, AL FIX	*18000	45000
CATLN, AL FIX *18000 - GNSS MEA *DME/DME/IRU MEA	KBLER, GA WP	*18000	45000
KBLER, GA WP *18000 - GNSS MEA *DME/DME/IRU MEA	KELLN, SC WP	*18000	45000
KELLN, SC WP *18000 - GNSS MEA *DME/DME/IRU MEA	KTOWN, NC WP	*18000	45000
KTOWN, NC WP *18000 - GNSS MEA *DME/DME/IRU MEA	BYSKO, NC WP	*18000	45000
BYSKO, NC WP *18000 - GNSS MEA *DME/DME/IRU MEA	JOOLI, NC WP	*18000	45000
JOOLI, NC WP *18000 - GNSS MEA *DME/DME/IRU MEA	NUUMN, NC WP	*18000	45000
NUUMN, NC WP *18000 - GNSS MEA *DME/DME/IRU MEA	ORACL, NC WP	*18000	45000
ORACL, NC WP *18000 - GNSS MEA *DME/DME/IRU MEA	KIWII, VA WP	*18000	45000
<b>95.4057 RNAV ROUTE Q57</b>			
KING SALMON, AK VORTAC *GNSS REQUIRED	MC GRATH, AK VORTAC	*18000	45000
<b>95.4058 RNAV ROUTE Q58</b>			
KELLN, SC WP *18000 - GNSS MEA *DME/DME/IRU MEA	GLOVR, NC WP	*18000	45000
GLOVR, NC WP *18000 - GNSS MEA *DME/DME/IRU MEA	LUMAY, NC WP	*18000	45000
LUMAY, NC WP *18000 - GNSS MEA *DME/DME/IRU MEA	STUKI, NC WP	*18000	45000

FROM	TO	MEA	MAA
<b>95.4058 RNAV ROUTE Q58 - CONTINUED</b>			
STUKI, NC WP *18000 - GNSS MEA *DME/DME/IRU MEA	PEETT, NC WP	*18000	45000
<b>95.4059 RNAV ROUTE Q59</b>			
COLD BAY, AK VORTAC *GNSS REQUIRED	BETHEL, AK VORTAC	*18000	45000
<b>95.4060 RNAV ROUTE Q60</b>			
BURGG, SC WP *18000 - GNSS MEA *DME/DME/IRU MEA	EVING, NC WP	*18000	45000
EVING, NC WP *18000 - GNSS MEA *DME/DME/IRU MEA	JAXSN, VA FIX	*18000	45000
JAXSN, VA FIX *18000 - GNSS MEA *DME/DME/IRU MEA	SHIRY, VA WP	*18000	45000
SHIRY, VA WP *18000 - GNSS MEA *DME/DME/IRU MEA	HURTS, VA WP	*18000	45000
<b>95.4061 RNAV ROUTE Q61</b>			
FAIRBANKS, AK VORTAC *GNSS REQUIRED	BARROW, AK VOR/DME	*18000	45000
<b>95.4062 RNAV ROUTE Q62</b>			
WATSN, IN FIX *18000 - GNSS MEA *DME/DME/IRU MEA	DAIFE, IN WP	*18000	45000
DAIFE, IN WP *18000 - GNSS MEA *DME/DME/IRU MEA	NOLNN, OH WP	*18000	45000
NOLNN, OH WP *18000 - GNSS MEA *DME/DME/IRU MEA	WEEVR, OH WP	*18000	45000
WEEVR, OH WP *18000 - GNSS MEA *DME/DME/IRU MEA	PSKUR, OH WP	*18000	45000
PSKUR, OH WP *18000 - GNSS MEA *DME/DME/IRU MEA	FAALS, OH WP	*18000	45000
FAALS, OH WP *18000 - GNSS MEA *DME/DME/IRU MEA	ALEEE, OH WP	*18000	45000
ALEEE, OH WP *18000 - GNSS MEA *DME/DME/IRU MEA	QUARM, PA WP	*18000	45000
QUARM, PA WP *18000 - GNSS MEA *DME/DME/IRU MEA	BURNI, PA FIX	*18000	45000
BURNI, PA FIX *18000 - GNSS MEA *DME/DME/IRU MEA	MCMAN, PA FIX	*18000	45000
MCMAN, PA FIX *18000 - GNSS MEA *DME/DME/IRU MEA	VALLO, PA FIX	*18000	45000

FROM	TO	MEA	MAA
<b>95.4062 RNAV ROUTE Q62 - CONTINUED</b>			
VALLO, PA FIX *18000 - GNSS MEA *DME/DME/IRU MEA	RAVINE, PA VORTAC	*18000	45000
RAVINE, PA VORTAC *18000 - GNSS MEA *DME/DME/IRU MEA	SUZIE, PA FIX	*18000	45000
SUZIE, PA FIX *18000 - GNSS MEA *DME/DME/IRU MEA	SARAA, PA FIX	*18000	45000
<b>95.4064 RNAV ROUTE Q64</b>			
CATLN, AL FIX *18000 - GNSS MEA *DME/DME/IRU MEA	FIGEY, GA WP	*18000	45000
FIGEY, GA WP *18000 - GNSS MEA *DME/DME/IRU MEA	HRTWL, SC WP	*18000	45000
HRTWL, SC WP *18000 - GNSS MEA *DME/DME/IRU MEA	DARRL, SC WP	*18000	45000
DARRL, SC WP *18000 - GNSS MEA *DME/DME/IRU MEA	IDDAA, NC WP	*18000	45000
IDDAA, NC WP *18000 - GNSS MEA *DME/DME/IRU MEA	DADDS, NC WP	*18000	45000
DADDS, NC WP *18000 - GNSS MEA *DME/DME/IRU MEA	MARCL, NC WP	*18000	45000
MARCL, NC WP *18000 - GNSS MEA *DME/DME/IRU MEA	TAR RIVER, NC VORTAC	*18000	45000
TAR RIVER, NC VORTAC *18000 - GNSS MEA *DME/DME/IRU MEA	GUILD, NC WP	*18000	45000
GUILD, NC WP *18000 - GNSS MEA *DME/DME/IRU MEA	SAWED, VA FIX	*18000	45000
<b>95.4065 RNAV ROUTE Q65</b>			
MGNTY, FL WP *18000 - GNSS MEA *DME/DME/IRU MEA	DOFFY, FL WP	*18000	45000
DOFFY, FL WP *18000 - GNSS MEA *DME/DME/IRU MEA	FETAL, FL WP	*18000	45000
FETAL, FL WP *18000 - GNSS MEA *DME/DME/IRU MEA	ENEME, GA WP	*18000	45000
ENEME, GA WP *18000 - GNSS MEA *DME/DME/IRU MEA	KERLY, GA WP	*18000	45000
KERLY, GA WP *18000 - GNSS MEA *DME/DME/IRU MEA	DAREE, GA WP	*18000	45000
DAREE, GA WP *18000 - GNSS MEA *DME/DME/IRU MEA	LORNN, TN WP	*18000	45000

FROM	TO	MEA	MAA
<b>95.4065 RNAV ROUTE Q65 - CONTINUED</b>			
LORNN, TN WP *18000 - GNSS MEA *DME/DME/IRU MEA	SOGEE, TN WP	*18000	45000
SOGEE, TN WP *18000 - GNSS MEA *DME/DME/IRU MEA	ENGRA, KY WP	*18000	45000
ENGRA, KY WP *18000 - GNSS MEA *DME/DME/IRU MEA	OCASE, KY WP	*18000	45000
OCASE, KY WP *18000 - GNSS MEA *DME/DME/IRU MEA	RINTE, OH WP	*18000	45000
<b>95.4066 RNAV ROUTE Q66</b>			
LITTLE ROCK, AR VORTAC *18000 - GNSS MEA *DME/DME/IRU MEA	CIVKI, AR WP	*18000	45000
CIVKI, AR WP *18000 - GNSS MEA *DME/DME/IRU MEA	RICKX, AR WP	*18000	45000
RICKX, AR WP *18000 - GNSS MEA *DME/DME/IRU MEA	TROVE, TN WP	*18000	45000
TROVE, TN WP *18000 - GNSS MEA *DME/DME/IRU MEA	BAZOO, TN WP	*18000	45000
BAZOO, TN WP *18000 - GNSS MEA *DME/DME/IRU MEA	METWO, TN WP	*18000	45000
METWO, TN WP *18000 - GNSS MEA *DME/DME/IRU MEA	MXEEN, TN WP	*18000	45000
MXEEN, TN WP *18000 - GNSS MEA *DME/DME/IRU MEA	ALEAN, VA WP	*18000	45000
<b>95.4067 RNAV ROUTE Q67</b>			
SMTTH, TN WP *18000 - GNSS MEA *DME/DME/IRU MEA	TONIO, KY WP	*18000	45000
TONIO, KY WP *18000 - GNSS MEA *DME/DME/IRU MEA	HENDERSON, WV DME	*18000	45000
<b>95.4068 RNAV ROUTE Q68</b>			
LITTR, AR WP *18000 - GNSS MEA *DME/DME/IRU MEA	SOPIE, TN FIX	*18000	45000
SOPIE, TN FIX *18000 - GNSS MEA *DME/DME/IRU MEA	BOWLING GREEN, KY DME	*18000	45000
BOWLING GREEN, KY DME *18000 - GNSS MEA *DME/DME/IRU MEA	YOCKY, KY FIX	*18000	45000
YOCKY, KY FIX *18000 - GNSS MEA *DME/DME/IRU MEA	SPAYD, WV FIX	*18000	45000



FROM	TO	MEA	MAA
<b>95.4068 RNAV ROUTE Q68 - CONTINUED</b>			
SPAYD, WV FIX *18000 - GNSS MEA *DME/DME/IRU MEA	CHARLESTON, WV VOR/DME	*18000	45000
CHARLESTON, WV VOR/DME *18000 - GNSS MEA *DME/DME/IRU MEA	TOMCA, WV WP	*18000	45000
TOMCA, WV WP *18000 - GNSS MEA *DME/DME/IRU MEA	RONZZ, WV WP	*18000	45000
RONZZ, WV WP *18000 - GNSS MEA *DME/DME/IRU MEA	HHOLZ, WV WP	*18000	45000
HHOLZ, WV WP *18000 - GNSS MEA *DME/DME/IRU MEA	HAMME, WV WP	*18000	45000
HAMME, WV WP *18000 - GNSS MEA *DME/DME/IRU MEA	CAPOE, VA WP	*18000	45000
CAPOE, VA WP *18000 - GNSS MEA *DME/DME/IRU MEA	OTTTO, VA WP	*18000	45000
<b>95.4069 RNAV ROUTE Q69</b>			
VIYAP, GA WP *18000 - GNSS MEA *DME/DME/IRU MEA	OLBEC, GA WP	*18000	45000
OLBEC, GA WP *18000 - GNSS MEA *DME/DME/IRU MEA	ISUZO, GA WP	*18000	45000
ISUZO, GA WP *18000 - GNSS MEA *DME/DME/IRU MEA	GURGE, SC WP	*18000	45000
GURGE, SC WP *18000 - GNSS MEA *DME/DME/IRU MEA	BLAAN, SC WP	*18000	45000
BLAAN, SC WP *18000 - GNSS MEA *DME/DME/IRU MEA	EMCET, SC WP	*18000	45000
EMCET, SC WP *18000 - GNSS MEA *DME/DME/IRU MEA	RYCKI, NC WP	*18000	45000
RYCKI, NC WP *18000 - GNSS MEA *DME/DME/IRU MEA	LUNDD, VA WP	*18000	45000
LUNDD, VA WP *18000 - GNSS MEA *DME/DME/IRU MEA	ILLSA, VA WP	*18000	45000
ILLSA, VA WP *18000 - GNSS MEA *DME/DME/IRU MEA	EWESS, WV WP	*18000	45000
EWESS, WV WP *18000 - GNSS MEA *DME/DME/IRU MEA	RICCS, WV WP	*18000	45000
<b>95.4070 RNAV ROUTE Q70</b>			
HAILO, CA WP *18000 - GNSS MEA *DME/DME/IRU MEA	LAS VEGAS, NV VORTAC	*18000	45000

FROM	TO	MEA	MAA
<b>95.4070 RNAV ROUTE Q70 - CONTINUED</b>			
LAS VEGAS, NV VORTAC *18000 - GNSS MEA *DME/DME/IRU MEA	IFEYE, NV WP	*20000	45000
IFEYE, NV WP *18000 - GNSS MEA *DME/DME/IRU MEA	BLIPP, NV WP	*20000	45000
BLIPP, NV WP *18000 - GNSS MEA *DME/DME/IRU MEA	EEVUN, UT WP	*20000	45000
EEVUN, UT WP *18000 - GNSS MEA *DME/DME/IRU MEA	BLOBB, UT WP	*20000	45000
BLOBB, UT WP *18000 - GNSS MEA *DME/DME/IRU MEA	BAWER, UT WP	*22000	45000
BAWER, UT WP *18000 - GNSS MEA *DME/DME/IRU MEA	SAKES, UT FIX	*22000	45000
<b>95.4071 RNAV ROUTE Q71</b>			
BOBBD, TN WP *18000 - GNSS MEA *DME/DME/IRU MEA	ATUME, KY WP	*18000	45000
ATUME, KY WP *18000 - GNSS MEA *DME/DME/IRU MEA	HAPKI, KY WP	*18000	45000
HAPKI, KY WP *18000 - GNSS MEA *DME/DME/IRU MEA	KONGO, KY WP	*18000	45000
KONGO, KY WP *18000 - GNSS MEA *DME/DME/IRU MEA	WISTA, WV WP	*18000	45000
WISTA, WV WP *18000 - GNSS MEA *DME/DME/IRU MEA	GEFFS, WV FIX	*18000	45000
GEFFS, WV FIX *18000 - GNSS MEA *DME/DME/IRU MEA	EMNEM, WV WP	*18000	45000
EMNEM, WV WP *18000 - GNSS MEA *DME/DME/IRU MEA	PSYKO, PA WP	*18000	45000
PSYKO, PA WP *18000 - GNSS MEA *DME/DME/IRU MEA	PHILIPSBURG, PA VORTAC	*18000	45000
<b>95.4072 RNAV ROUTE Q72</b>			
HACKS, WV FIX *18000 - GNSS MEA *DME/DME/IRU MEA	GEQUE, WV WP	*18000	45000
GEQUE, WV WP *18000 - GNSS MEA *DME/DME/IRU MEA	BENSH, WV WP	*18000	45000
BENSH, WV WP *18000 - GNSS MEA *DME/DME/IRU MEA	RAMAY, VA WP	*18000	45000
<b>95.4073 RNAV ROUTE Q73</b>			
MOMAR, CA FIX *GNSS REQUIRED	CABIC, CA WP	*18000	45000

FROM	TO	MEA	MAA
<b>95.4073 RNAV ROUTE Q73 - CONTINUED</b>			
CABIC, CA WP *GNSS REQUIRED	CHADT, CA WP	*18000	45000
CHADT, CA WP *GNSS REQUIRED	LVELL, CA WP	*18000	45000
LVELL, CA WP *GNSS REQUIRED	BLKWL, CA WP	*18000	45000
BLKWL, CA WP *GNSS REQUIRED	ZELMA, CA FIX	*18000	45000
ZELMA, CA FIX *GNSS REQUIRED	KRLIE, CA WP	*18000	45000
KRLIE, CA WP *GNSS REQUIRED	HAKMN, NV WP	*18000	45000
HAKMN, NV WP *18000 - GNSS MEA *DME/DME/IRU MEA	ZZYZX, NV WP	*18000	45000
ZZYZX, NV WP *18000 - GNSS MEA *DME/DME/IRU MEA	LAKRR, NV WP	*18000	45000
LAKRR, NV WP *GNSS REQUIRED	GUNTR, AZ WP	*18000	45000
GUNTR, AZ WP *GNSS REQUIRED	ZAINY, AZ WP	*18000	45000
ZAINY, AZ WP *GNSS REQUIRED	EEVUN, UT WP	*18000	45000
EEVUN, UT WP *GNSS REQUIRED	WINEN, UT WP	*18000	45000
WINEN, UT WP *GNSS REQUIRED	CRITO, NV WP	*18000	45000
CRITO, NV WP *GNSS REQUIRED	BROPH, ID WP	*18000	45000
BROPH, ID WP *GNSS REQUIRED	DERSO, ID FIX	*18000	45000
DERSO, ID FIX *GNSS REQUIRED	SAWTT, ID WP	*18000	45000
SAWTT, ID WP *GNSS REQUIRED	ZATIP, ID FIX	*18000	45000
ZATIP, ID FIX *GNSS REQUIRED	CORDU, ID FIX	*18000	45000

**95.4074 RNAV ROUTE Q74**

NATEE, NV WP *18000 - GNSS MEA *DME/DME/IRU MEA	BOULDER CITY, NV VORTAC	*18000	45000
BOULDER CITY, NV VORTAC *18000 - GNSS MEA *DME/DME/IRU MEA	ZAINY, AZ WP	*20000	45000
ZAINY, AZ WP *18000 - GNSS MEA *DME/DME/IRU MEA	FIZZL, AZ WP	*20000	45000
FIZZL, AZ WP *18000 - GNSS MEA *DME/DME/IRU MEA	GARDD, UT WP	*20000	45000
GARDD, UT WP *18000 - GNSS MEA *DME/DME/IRU MEA	DEANN, UT WP	*20000	45000

**95.4075 RNAV ROUTE Q75**

ENEME, GA WP *18000 - GNSS MEA *DME/DME/IRU MEA	TEUFL, GA WP	*18000	45000
---	--------------	--------	-------

FROM	TO	MEA	MAA
TEUFL, GA WP *18000 - GNSS MEA *DME/DME/IRU MEA	TEEEM, GA WP	*18000	45000
TEEEM, GA WP *18000 - GNSS MEA *DME/DME/IRU MEA	SHRIL, GA WP	*18000	45000
SHRIL, GA WP *18000 - GNSS MEA *DME/DME/IRU MEA	FISHO, SC WP	*18000	45000
FISHO, SC WP *18000 - GNSS MEA *DME/DME/IRU MEA	ILBEE, SC WP	*18000	45000
ILBEE, SC WP *18000 - GNSS MEA *DME/DME/IRU MEA	SLOJO, SC WP	*18000	45000
SLOJO, SC WP *18000 - GNSS MEA *DME/DME/IRU MEA	GREENSBORO, NC VORTAC	*18000	45000
GREENSBORO, NC VORTAC *18000 - GNSS MEA *DME/DME/IRU MEA	BROSK, NC WP	*18000	45000
BROSK, NC WP *18000 - GNSS MEA *DME/DME/IRU MEA	DRAIK, VA FIX	*18000	45000
DRAIK, VA FIX *18000 - GNSS MEA *DME/DME/IRU MEA	GORDONSVILLE, VA VORTAC	*18000	45000
GORDONSVILLE, VA VORTAC *20000 - GNSS MEA *DME/DME/IRU MEA	HAMMZ, VA WP	*20000	45000
HAMMZ, VA WP *20000 - GNSS MEA *DME/DME/IRU MEA	TOOBN, MD WP	*20000	45000
TOOBN, MD WP *20000 - GNSS MEA *DME/DME/IRU MEA	MURPH, MD WP	*20000	45000
MURPH, MD WP *18000 - GNSS MEA *DME/DME/IRU MEA	SACRI, MD WP	*18000	45000
SACRI, MD WP *18000 - GNSS MEA *DME/DME/IRU MEA	STOEN, PA FIX	*18000	45000
STOEN, PA FIX *18000 - GNSS MEA *DME/DME/IRU MEA	MODENA, PA VORTAC	*18000	45000
MODENA, PA VORTAC *18000 - GNSS MEA *DME/DME/IRU MEA	COPEP, PA FIX	*18000	45000
COPEP, PA FIX *18000 - GNSS MEA *DME/DME/IRU MEA	BIGGY, NJ FIX	*18000	45000
BIGGY, NJ FIX *18000 - GNSS MEA *DME/DME/IRU MEA	SOLBERG, NJ VOR/DME	*18000	45000
SOLBERG, NJ VOR/DME *18000 - GNSS MEA *DME/DME/IRU MEA	JERSY, NJ WP	*18000	45000
JERSY, NJ WP *18000 - GNSS MEA *DME/DME/IRU MEA	FARLE, NY FIX	*18000	45000

FROM	TO	MEA	MAA
<b>95.4075 RNAV ROUTE Q75 - CONTINUED</b>			
FARLE, NY FIX *18000 - GNSS MEA *DME/DME/IRU MEA	BIZEX, NY WP	*18000	45000
BIZEX, NY WP *18000 - GNSS MEA *DME/DME/IRU MEA	GREKI, CT FIX	*18000	45000
GREKI, CT FIX *18000 - GNSS MEA *DME/DME/IRU MEA	NELIE, CT FIX	*18000	45000
NELIE, CT FIX *18000 - GNSS MEA *DME/DME/IRU MEA	SWALO, MA WP	*18000	45000
SWALO, MA WP *18000 - GNSS MEA *DME/DME/IRU MEA	BOSTON, MA VOR/DME	*18000	45000
BOSTON, MA VOR/DME *18000 - GNSS MEA *DME/DME/IRU MEA	COPLY, MA WP	*18000	45000
<b>95.4077 RNAV ROUTE Q77</b>			
OCTAL, FL WP *18000 - GNSS MEA *DME/DME/IRU MEA	MATLK, FL WP	*18000	45000
MATLK, FL WP *18000 - GNSS MEA *DME/DME/IRU MEA	STYMY, FL WP	*18000	45000
STYMY, FL WP *18000 - GNSS MEA *DME/DME/IRU MEA	WAKKO, FL WP	*18000	45000
WAKKO, FL WP *18000 - GNSS MEA *DME/DME/IRU MEA	MJAMS, FL WP	*18000	45000
MJAMS, FL WP *18000 - GNSS MEA *DME/DME/IRU MEA	ETORE, FL WP	*18000	45000
ETORE, FL WP *18000 - GNSS MEA *DME/DME/IRU MEA	SHRKS, FL WP	*18000	45000
SHRKS, FL WP *18000 - GNSS MEA *DME/DME/IRU MEA	TEUFL, GA WP	*18000	45000
TEUFL, GA WP *18000 - GNSS MEA *DME/DME/IRU MEA	WIGVO, GA WP	*18000	45000
WIGVO, GA WP *18000 - GNSS MEA *DME/DME/IRU MEA	MELKR, SC WP	*18000	45000
MELKR, SC WP *18000 - GNSS MEA *DME/DME/IRU MEA	HRTWL, SC WP	*18000	45000
<b>95.4078 RNAV ROUTE Q78</b>			
MARUE, NV WP *18000 - GNSS MEA *DME/DME/IRU MEA	DUGGN, AZ WP	*24000	45000
DUGGN, AZ WP *18000 - GNSS MEA *DME/DME/IRU MEA	TOADD, AZ WP	*24000	45000

FROM	TO	MEA	MAA
<b>95.4079 RNAV ROUTE Q79</b>			
MCLAW, FL WP *18000 - GNSS MEA *DME/DME/IRU MEA	VAULT, FL WP	*18000	45000
VAULT, FL WP *18000 - GNSS MEA *DME/DME/IRU MEA	FEMID, FL WP	*18000	45000
FEMID, FL WP *18000 - GNSS MEA *DME/DME/IRU MEA	WULFF, FL WP	*18000	45000
WULFF, FL WP *18000 - GNSS MEA *DME/DME/IRU MEA	MOLIE, FL WP	*18000	45000
MOLIE, FL WP *18000 - GNSS MEA *DME/DME/IRU MEA	DOFFY, FL WP	*18000	45000
DOFFY, FL WP *18000 - GNSS MEA *DME/DME/IRU MEA	EVANZ, FL WP	*18000	45000
EVANZ, FL WP *18000 - GNSS MEA *DME/DME/IRU MEA	IISLY, GA WP	*18000	45000
IISLY, GA WP *18000 - GNSS MEA *DME/DME/IRU MEA	ZPLEN, GA WP	*18000	45000
ZPLEN, GA WP *18000 - GNSS MEA *DME/DME/IRU MEA	THRSR, GA WP	*18000	45000
THRSR, GA WP *18000 - GNSS MEA *DME/DME/IRU MEA	KAILL, GA WP	*18000	45000
KAILL, GA WP *18000 - GNSS MEA *DME/DME/IRU MEA	WUDEE, GA WP	*18000	45000
WUDEE, GA WP *18000 - GNSS MEA *DME/DME/IRU MEA	RESPE, TN WP	*18000	45000
RESPE, TN WP *18000 - GNSS MEA *DME/DME/IRU MEA	SWAPP, TN FIX	*18000	45000
SWAPP, TN FIX *18000 - GNSS MEA *DME/DME/IRU MEA	LOUISVILLE, KY VORTAC	*18000	45000
<b>95.4080 RNAV ROUTE Q80</b>			
FAREV, KY WP *18000 - GNSS MEA *DME/DME/IRU MEA	JEDER, KY WP	*18000	45000
JEDER, KY WP *18000 - GNSS MEA *DME/DME/IRU MEA	ENGRA, KY WP	*18000	45000
ENGRA, KY WP *18000 - GNSS MEA *DME/DME/IRU MEA	DEWAK, KY WP	*18000	45000
DEWAK, KY WP *18000 - GNSS MEA *DME/DME/IRU MEA	CEGMA, KY WP	*18000	45000
CEGMA, KY WP *18000 - GNSS MEA *DME/DME/IRU MEA	JONEN, KY WP	*18000	45000

FROM	TO	MEA	MAA
<b>95.4080 RNAV ROUTE Q80 - CONTINUED</b>			
JONEN, KY WP *18000 - GNSS MEA *DME/DME/IRU MEA	BULVE, WV WP	*18000	45000
BULVE, WV WP *18000 - GNSS MEA *DME/DME/IRU MEA	WISTA, WV WP	*18000	45000
WISTA, WV WP *18000 - GNSS MEA *DME/DME/IRU MEA	LEVII, WV WP	*18000	45000
LEVII, WV WP *18000 - GNSS MEA *DME/DME/IRU MEA	RONZZ, WV WP	*18000	45000
RONZZ, WV WP *18000 - GNSS MEA *DME/DME/IRU MEA	HHOLZ, WV WP	*18000	45000
HHOLZ, WV WP *18000 - GNSS MEA *DME/DME/IRU MEA	HAMME, WV WP	*18000	45000
HAMME, WV WP *18000 - GNSS MEA *DME/DME/IRU MEA	CAPOE, VA WP	*18000	45000
CAPOE, VA WP *18000 - GNSS MEA *DME/DME/IRU MEA	OTTTO, VA WP	*18000	45000

**95.4081 RNAV ROUTE Q81**

TUNSL, FL WP *18000 - GNSS MEA *DME/DME/IRU MEA	KARTR, FL FIX	*18000	45000
KARTR, FL FIX *18000 - GNSS MEA *DME/DME/IRU MEA	FIPES, OG WP	*18000	45000
FIPES, OG WP *18000 - GNSS MEA *DME/DME/IRU MEA	ZEILR, FL FIX	*18000	45000
ZEILR, FL FIX *18000 - GNSS MEA *DME/DME/IRU MEA	PIKKR, OG WP	*18000	45000
PIKKR, OG WP *18000 - GNSS MEA *DME/DME/IRU MEA	FARLU, FL WP	*18000	45000
FARLU, FL WP *18000 - GNSS MEA *DME/DME/IRU MEA	MGNTY, FL WP	*18000	45000
MGNTY, FL WP *18000 - GNSS MEA *DME/DME/IRU MEA	ENDEW, FL WP	*18000	45000
ENDEW, FL WP *18000 - GNSS MEA *DME/DME/IRU MEA	BITNY, OG WP	*18000	45000
BITNY, OG WP *18000 - GNSS MEA *DME/DME/IRU MEA	NICKI, FL WP	*18000	45000
NICKI, FL WP *18000 - GNSS MEA *DME/DME/IRU MEA	SNAPY, FL WP	*18000	45000
SNAPY, FL WP *18000 - GNSS MEA *DME/DME/IRU MEA	BULZI, FL WP	*18000	45000

FROM	TO	MEA	MAA
<b>95.4081 RNAV ROUTE Q81 - CONTINUED</b>			
BULZI, FL WP *18000 - GNSS MEA *DME/DME/IRU MEA	IPOKE, GA WP	*18000	45000
IPOKE, GA WP *18000 - GNSS MEA *DME/DME/IRU MEA	HONID, GA WP	*18000	45000
<b>95.4082 RNAV ROUTE Q82</b>			
WWSHR, OH WP *18000 - GNSS MEA *DME/DME/IRU MEA	DORET, OH FIX	*18000	45000
DORET, OH FIX *18000 - GNSS MEA *DME/DME/IRU MEA	JAMESTOWN, NY VOR/DME	*18000	45000
JAMESTOWN, NY VOR/DME *18000 - GNSS MEA *DME/DME/IRU MEA	WAYLA, NY WP	*18000	45000
WAYLA, NY WP *18000 - GNSS MEA *DME/DME/IRU MEA	VIEEW, NY FIX	*18000	45000
VIEEW, NY FIX *18000 - GNSS MEA *DME/DME/IRU MEA	MEMMS, NY FIX	*18000	45000
MEMMS, NY FIX *18000 - GNSS MEA *DME/DME/IRU MEA	LOXXE, NY FIX	*18000	45000
LOXXE, NY FIX *18000 - GNSS MEA *DME/DME/IRU MEA	PONCT, NY WP	*18000	45000
<b>95.4083 RNAV ROUTE Q83</b>			
JEVED, GA WP *18000 - GNSS MEA *DME/DME/IRU MEA	ROYCO, GA WP	*18000	45000
ROYCO, GA WP *18000 - GNSS MEA *DME/DME/IRU MEA	TAALN, GA WP	*18000	45000
TAALN, GA WP *18000 - GNSS MEA *DME/DME/IRU MEA	KONEY, SC WP	*18000	45000
KONEY, SC WP *18000 - GNSS MEA *DME/DME/IRU MEA	WURFL, SC WP	*18000	45000
WURFL, SC WP *18000 - GNSS MEA *DME/DME/IRU MEA	JUSEE, SC WP	*18000	45000
JUSEE, SC WP *18000 - GNSS MEA *DME/DME/IRU MEA	EFFAY, SC WP	*18000	45000
EFFAY, SC WP *18000 - GNSS MEA *DME/DME/IRU MEA	SLOJO, SC WP	*18000	45000
<b>95.4084 RNAV ROUTE Q84</b>			
JAMESTOWN, NY VOR/DME *18000 - GNSS MEA *DME/DME/IRU MEA	AUDIL, NY FIX	*18000	45000



FROM	TO	MEA	MAA
<b>95.4084 RNAV ROUTE Q84 - CONTINUED</b>			
AUDIL, NY FIX *18000 - GNSS MEA *DME/DME/IRU MEA	PUPPY, NY WP	*18000	45000
PUPPY, NY WP *18000 - GNSS MEA *DME/DME/IRU MEA	PAYGE, NY WP	*18000	45000
PAYGE, NY WP *18000 - GNSS MEA *DME/DME/IRU MEA	CAMBRIDGE, NY VOR/DME	*18000	45000
<b>95.4085 RNAV ROUTE Q85</b>			
LPERD, FL WP *18000 - GNSS MEA *DME/DME/IRU MEA	BEEGE, GA WP	*18000	45000
BEEGE, GA WP *18000 - GNSS MEA *DME/DME/IRU MEA	GIPPL, GA WP	*18000	45000
GIPPL, GA WP *18000 - GNSS MEA *DME/DME/IRU MEA	ROYCO, GA WP	*18000	45000
ROYCO, GA WP *18000 - GNSS MEA *DME/DME/IRU MEA	IGARY, SC WP	*18000	45000
IGARY, SC WP *18000 - GNSS MEA *DME/DME/IRU MEA	PELIE, SC WP	*18000	45000
PELIE, SC WP *18000 - GNSS MEA *DME/DME/IRU MEA	BUMMA, SC WP	*18000	45000
BUMMA, SC WP *18000 - GNSS MEA *DME/DME/IRU MEA	KAATT, NC WP	*18000	45000
KAATT, NC WP *18000 - GNSS MEA *DME/DME/IRU MEA	SMPRR, NC WP	*18000	45000
SMPRR, NC WP *18000 - GNSS MEA *DME/DME/IRU MEA	PBCUP, NC WP	*18000	45000
PBCUP, NC WP *18000 - GNSS MEA *DME/DME/IRU MEA	MOXXY, NC WP	*18000	45000
MOXXY, NC WP *18000 - GNSS MEA *DME/DME/IRU MEA	CRPLR, VA WP	*18000	45000
<b>95.4086 RNAV ROUTE Q86</b>			
TTRUE, AZ WP *18000 - GNSS MEA *DME/DME/IRU MEA	YORRK, AZ WP	*18000	45000
YORRK, AZ WP *18000 - GNSS MEA *DME/DME/IRU MEA	SCHLS, AZ WP	*20000	45000
SCHLS, AZ WP *18000 - GNSS MEA *DME/DME/IRU MEA	CUTRO, AZ FIX	*20000	45000
CUTRO, AZ FIX *18000 - GNSS MEA *DME/DME/IRU MEA	VALEQ, AZ WP	*20000	45000

FROM	TO	MEA	MAA
<b>95.4086 RNAV ROUTE Q86 - CONTINUED</b>			
VALEQ, AZ WP *18000 - GNSS MEA *DME/DME/IRU MEA	PLNDL, AZ WP	*20000	45000
<b>95.4087 RNAV ROUTE Q87</b>			
PEAKY, FL WP *18000 - GNSS MEA *DME/DME/IRU MEA	GOPEY, FL WP	*18000	45000
GOPEY, FL WP *18000 - GNSS MEA *DME/DME/IRU MEA	GRIDS, FL WP	*18000	45000
GRIDS, FL WP *18000 - GNSS MEA *DME/DME/IRU MEA	TIRCO, FL WP	*18000	45000
TIRCO, FL WP *18000 - GNSS MEA *DME/DME/IRU MEA	MATLK, FL WP	*18000	45000
MATLK, FL WP *18000 - GNSS MEA *DME/DME/IRU MEA	ONEWY, FL WP	*18000	45000
ONEWY, FL WP *18000 - GNSS MEA *DME/DME/IRU MEA	ZERBO, FL WP	*18000	45000
ZERBO, FL WP *18000 - GNSS MEA *DME/DME/IRU MEA	DUCEN, FL WP	*18000	45000
DUCEN, FL WP *18000 - GNSS MEA *DME/DME/IRU MEA	OVENP, FL WP	*18000	45000
OVENP, FL WP *18000 - GNSS MEA *DME/DME/IRU MEA	FEMON, FL WP	*18000	45000
FEMON, FL WP *18000 - GNSS MEA *DME/DME/IRU MEA	VIYAP, GA WP	*18000	45000
VIYAP, GA WP *18000 - GNSS MEA *DME/DME/IRU MEA	SUSYQ, GA WP	*18000	45000
SUSYQ, GA WP *18000 - GNSS MEA *DME/DME/IRU MEA	TAALN, GA WP	*18000	45000
TAALN, GA WP *18000 - GNSS MEA *DME/DME/IRU MEA	JROSS, SC WP	*18000	45000
JROSS, SC WP *18000 - GNSS MEA *DME/DME/IRU MEA	RAYVO, SC WP	*18000	45000
RAYVO, SC WP *18000 - GNSS MEA *DME/DME/IRU MEA	HINTZ, SC WP	*18000	45000
HINTZ, SC WP *18000 - GNSS MEA *DME/DME/IRU MEA	REDFH, SC WP	*18000	45000
REDFH, SC WP *18000 - GNSS MEA *DME/DME/IRU MEA	LCAPE, SC WP	*18000	45000
LCAPE, SC WP *18000 - GNSS MEA *DME/DME/IRU MEA	ALWZZ, NC WP	*18000	45000

FROM	TO	MEA	MAA
<b>95.4087 RNAV ROUTE Q87 - CONTINUED</b>			
ALWZZ, NC WP *18000 - GNSS MEA *DME/DME/IRU MEA	ASHEL, NC WP	*18000	45000
ASHEL, NC WP *18000 - GNSS MEA *DME/DME/IRU MEA	DADDS, NC WP	*18000	45000
DADDS, NC WP *18000 - GNSS MEA *DME/DME/IRU MEA	NOWAE, NC WP	*18000	45000
NOWAE, NC WP *18000 - GNSS MEA *DME/DME/IRU MEA	RIDDN, VA WP	*18000	45000
RIDDN, VA WP *18000 - GNSS MEA *DME/DME/IRU MEA	GEARS, VA WP	*18000	45000
GEARS, VA WP *18000 - GNSS MEA *DME/DME/IRU MEA	HURTS, VA WP	*18000	45000
<b>95.4088 RNAV ROUTE Q88</b>			
HAKMN, NV WP *18000 - GNSS MEA *DME/DME/IRU MEA	ZZYZX, NV WP	*18000	45000
ZZYZX, NV WP *18000 - GNSS MEA *DME/DME/IRU MEA	LAKRR, NV WP	*18000	45000
LAKRR, NV WP *18000 - GNSS MEA *DME/DME/IRU MEA	NOOTN, AZ FIX	*22000	45000
NOOTN, AZ FIX *18000 - GNSS MEA *DME/DME/IRU MEA	GARDD, UT WP	*22000	45000
GARDD, UT WP *18000 - GNSS MEA *DME/DME/IRU MEA	VERKN, UT WP	*22000	45000
VERKN, UT WP *18000 - GNSS MEA *DME/DME/IRU MEA	PROMT, UT WP	*22000	45000
PROMT, UT WP *18000 - GNSS MEA *DME/DME/IRU MEA	CHESZ, UT WP	*22000	45000
CHESZ, UT WP *18000 - GNSS MEA *DME/DME/IRU MEA	SINRY, CO WP	*22000	45000
SINRY, CO WP *18000 - GNSS MEA *DME/DME/IRU MEA	ZAKRY, CO WP	*22000	45000
ZAKRY, CO WP *22000 - GNSS MEA *DME/DME/IRU MEA	YAMPA, CO WP	*22000	45000
YAMPA, CO WP *18000 - GNSS MEA *DME/DME/IRU MEA	BICAR, NE WP	*22000	45000
BICAR, NE WP *18000 - GNSS MEA *DME/DME/IRU MEA	CHUWY, NE WP	*22000	45000
CHUWY, NE WP *18000 - GNSS MEA *DME/DME/IRU MEA	KEEFF, NE WP	*22000	45000

FROM	TO	MEA	MAA
<b>95.4088 RNAV ROUTE Q88 - CONTINUED</b>			
KEEFF, NE WP *18000 - GNSS MEA *DME/DME/IRU MEA	GUDDY, SD WP	*22000	45000
GUDDY, SD WP *18000 - GNSS MEA *DME/DME/IRU MEA	VIVID, SD FIX	*22000	45000
VIVID, SD FIX *18000 - GNSS MEA *DME/DME/IRU MEA	JOYCC, SD WP	*22000	45000
JOYCC, SD WP *18000 - GNSS MEA *DME/DME/IRU MEA	DKOTA, SD WP	*22000	45000
<b>95.4089 RNAV ROUTE Q89</b>			
MANLE, FL WP *18000 - GNSS MEA *DME/DME/IRU MEA	WAKUP, FL WP	*18000	45000
WAKUP, FL WP *18000 - GNSS MEA *DME/DME/IRU MEA	PRMUS, FL WP	*18000	45000
PRMUS, FL WP *18000 - GNSS MEA *DME/DME/IRU MEA	OVENP, FL WP	*18000	45000
OVENP, FL WP *18000 - GNSS MEA *DME/DME/IRU MEA	SHRKS, FL WP	*18000	45000
SHRKS, FL WP *18000 - GNSS MEA *DME/DME/IRU MEA	YANTI, GA WP	*18000	45000
YANTI, GA WP *18000 - GNSS MEA *DME/DME/IRU MEA	HESPI, GA WP	*18000	45000
HESPI, GA WP *18000 - GNSS MEA *DME/DME/IRU MEA	CULTO, GA WP	*18000	45000
CULTO, GA WP *18000 - GNSS MEA *DME/DME/IRU MEA	SMTTH, TN WP	*18000	45000
<b>95.4090 RNAV ROUTE Q90</b>			
DNERO, CA WP *18000 - GNSS MEA *DME/DME/IRU MEA	ESGEE, NV WP	*20000	45000
ESGEE, NV WP *18000 - GNSS MEA *DME/DME/IRU MEA	AREAF, AZ WP	*20000	45000
AREAF, AZ WP *18000 - GNSS MEA *DME/DME/IRU MEA	JASSE, AZ WP	*20000	45000
JASSE, AZ WP *18000 - GNSS MEA *DME/DME/IRU MEA	NAVJO, AZ WP	*24000	45000
NAVJO, AZ WP *18000 - GNSS MEA *DME/DME/IRU MEA	YAMHA, CO WP	*24000	45000
YAMHA, CO WP *18000 - GNSS MEA *DME/DME/IRU MEA	DAAYE, CO WP	*24000	45000

FROM	TO	MEA	MAA
<b>95.4090 RNAV ROUTE Q90 - CONTINUED</b>			
DAAYE, CO WP *18000 - GNSS MEA *DME/DME/IRU MEA	SKWYR, CO WP	*24000	45000
SKWYR, CO WP *18000 - GNSS MEA *DME/DME/IRU MEA	HUSQA, KS WP	*24000	45000
HUSQA, KS WP *18000 - GNSS MEA *DME/DME/IRU MEA	VARNE, KS WP	*24000	45000
VARNE, KS WP *18000 - GNSS MEA *DME/DME/IRU MEA	ATIJA, KS WP	*20000	45000
ATIJA, KS WP *18000 - GNSS MEA *DME/DME/IRU MEA	LEFAM, NE WP	*20000	45000
LEFAM, NE WP *18000 - GNSS MEA *DME/DME/IRU MEA	BOVEY, MO WP	*20000	45000
BOVEY, MO WP *18000 - GNSS MEA *DME/DME/IRU MEA	WELKY, IA WP	*20000	45000
<b>95.4092 RNAV ROUTE Q92</b>			
CHUWY, NE WP *20000 - GNSS MEA *DME/DME/IRU MEA	KUTCH, NE WP	*22000	45000
KUTCH, NE WP *20000 - GNSS MEA *DME/DME/IRU MEA	WYYTE, NE WP	*22000	45000
WYYTE, NE WP *20000 - GNSS MEA *DME/DME/IRU MEA	MAASI, NE WP	*20000	45000
MAASI, NE WP *20000 - GNSS MEA *DME/DME/IRU MEA	HANKU, IA WP	*20000	45000
HANKU, IA WP *20000 - GNSS MEA *DME/DME/IRU MEA	JORDY, IA FIX	*20000	45000
<b>95.4093 RNAV ROUTE Q93</b>			
MCLAW, FL WP *18000 - GNSS MEA *DME/DME/IRU MEA	VAULT, FL WP	*18000	45000
VAULT, FL WP *18000 - GNSS MEA *DME/DME/IRU MEA	LINEY, FL WP	*18000	45000
LINEY, FL WP *18000 - GNSS MEA *DME/DME/IRU MEA	FOBIN, FL WP	*18000	45000
FOBIN, FL WP *18000 - GNSS MEA *DME/DME/IRU MEA	EBAYY, FL WP	*18000	45000
EBAYY, FL WP *18000 - GNSS MEA *DME/DME/IRU MEA	MALET, FL FIX	*18000	45000
MALET, FL FIX *18000 - GNSS MEA *DME/DME/IRU MEA	DEBRL, FL WP	*18000	45000

FROM	TO	MEA	MAA
<b>95.4093 RNAV ROUTE Q93 - CONTINUED</b>			
DEBRL, FL WP *18000 - GNSS MEA *DME/DME/IRU MEA	KENLL, FL WP	*18000	45000
KENLL, FL WP *18000 - GNSS MEA *DME/DME/IRU MEA	PRMUS, FL WP	*18000	45000
PRMUS, FL WP *18000 - GNSS MEA *DME/DME/IRU MEA	WOPNR, OA WP	*18000	45000
WOPNR, OA WP *18000 - GNSS MEA *DME/DME/IRU MEA	GIPPL, GA WP	*18000	45000
GIPPL, GA WP *18000 - GNSS MEA *DME/DME/IRU MEA	SUSYQ, GA WP	*18000	45000
SUSYQ, GA WP *18000 - GNSS MEA *DME/DME/IRU MEA	ISUZO, GA WP	*18000	45000
ISUZO, GA WP *18000 - GNSS MEA *DME/DME/IRU MEA	GURGE, SC WP	*18000	45000
GURGE, SC WP *18000 - GNSS MEA *DME/DME/IRU MEA	FISHO, SC WP	*18000	45000
FISHO, SC WP *18000 - GNSS MEA *DME/DME/IRU MEA	QUIWE, SC WP	*18000	45000
QUIWE, SC WP *18000 - GNSS MEA *DME/DME/IRU MEA	JEPEX, SC WP	*18000	45000
JEPEX, SC WP *18000 - GNSS MEA *DME/DME/IRU MEA	BENBY, NC WP	*18000	45000
BENBY, NC WP *18000 - GNSS MEA *DME/DME/IRU MEA	DOOGE, VA WP	*18000	45000
DOOGE, VA WP *18000 - GNSS MEA *DME/DME/IRU MEA	HAPKI, KY WP	*18000	45000
HAPKI, KY WP *18000 - GNSS MEA *DME/DME/IRU MEA	TONIO, KY WP	*18000	45000
TONIO, KY WP *18000 - GNSS MEA *DME/DME/IRU MEA	OCASE, KY WP	*18000	45000
OCASE, KY WP *18000 - GNSS MEA *DME/DME/IRU MEA	HEVAN, IN WP	*18000	45000

**95.4094 RNAV ROUTE Q94**

WELUM, NV WP *18000 - GNSS MEA *DME/DME/IRU MEA	MNGGO, AZ WP	*22000	45000
MNGGO, AZ WP *18000 - GNSS MEA *DME/DME/IRU MEA	ROOLL, AZ WP	*22000	45000

**95.4096 RNAV ROUTE Q96**

PURSE, NV WP *18000 - GNSS MEA *DME/DME/IRU MEA	DODDL, NV WP	*22000	45000
---	--------------	--------	-------

FROM	TO	MEA	MAA
<b>95.4096 RNAV ROUTE Q96 - CONTINUED</b>			
DODDL, NV WP *18000 - GNSS MEA *DME/DME/IRU MEA	BFUNE, AZ WP	*22000	45000
BFUNE, AZ WP *18000 - GNSS MEA *DME/DME/IRU MEA	GUNTR, AZ WP	*18000	45000
GUNTR, AZ WP *18000 - GNSS MEA *DME/DME/IRU MEA	PIIXR, AZ WP	*22000	45000
PIIXR, AZ WP *18000 - GNSS MEA *DME/DME/IRU MEA	FIZZL, AZ WP	*22000	45000
FIZZL, AZ WP *18000 - GNSS MEA *DME/DME/IRU MEA	BAWER, UT WP	*22000	45000
BAWER, UT WP *18000 - GNSS MEA *DME/DME/IRU MEA	ROCCY, UT WP	*22000	45000
ROCCY, UT WP *18000 - GNSS MEA *DME/DME/IRU MEA	SARAF, UT WP	*22000	45000
SARAF, UT WP *18000 - GNSS MEA *DME/DME/IRU MEA	KIMMR, UT WP	*22000	45000

**95.4097 RNAV ROUTE Q97**

TOVAR, FL WP *18000 - GNSS MEA *DME/DME/IRU MEA	EBAYY, FL WP	*18000	45000
EBAYY, FL WP *18000 - GNSS MEA *DME/DME/IRU MEA	MALET, FL FIX	*18000	45000
MALET, FL FIX *18000 - GNSS MEA *DME/DME/IRU MEA	DEBRL, FL WP	*18000	45000
DEBRL, FL WP *18000 - GNSS MEA *DME/DME/IRU MEA	KENLL, FL WP	*18000	45000
KENLL, FL WP *18000 - GNSS MEA *DME/DME/IRU MEA	PRMUS, FL WP	*18000	45000
PRMUS, FL WP *18000 - GNSS MEA *DME/DME/IRU MEA	WOPNR, OA WP	*18000	45000
WOPNR, OA WP *18000 - GNSS MEA *DME/DME/IRU MEA	JEVED, GA WP	*18000	45000
JEVED, GA WP *18000 - GNSS MEA *DME/DME/IRU MEA	CAKET, SC WP	*18000	45000
CAKET, SC WP *18000 - GNSS MEA *DME/DME/IRU MEA	ELMSZ, SC WP	*18000	45000
ELMSZ, SC WP *18000 - GNSS MEA *DME/DME/IRU MEA	YURCK, NC WP	*18000	45000
YURCK, NC WP *18000 - GNSS MEA *DME/DME/IRU MEA	ELLDE, NC WP	*18000	45000

FROM	TO	MEA	MAA
<b>95.4097 RNAV ROUTE Q97 - CONTINUED</b>			
ELLDE, NC WP *18000 - GNSS MEA *DME/DME/IRU MEA	YEASO, NC WP	*18000	45000
YEASO, NC WP *18000 - GNSS MEA *DME/DME/IRU MEA	PAACK, NC WP	*18000	45000
PAACK, NC WP *18000 - GNSS MEA *DME/DME/IRU MEA	KOHLs, NC WP	*18000	45000
KOHLs, NC WP *18000 - GNSS MEA *DME/DME/IRU MEA	SAWED, VA FIX	*18000	45000
SAWED, VA FIX *18000 - GNSS MEA *DME/DME/IRU MEA	KALDA, VA FIX	*18000	45000
KALDA, VA FIX *18000 - GNSS MEA *DME/DME/IRU MEA	ZJAAy, MD WP	*18000	45000
ZJAAy, MD WP *18000 - GNSS MEA *DME/DME/IRU MEA	DLAAy, MD WP	*18000	45000
DLAAy, MD WP *18000 - GNSS MEA *DME/DME/IRU MEA	BRIGs, NJ FIX	*18000	45000
BRIGs, NJ FIX *18000 - GNSS MEA *DME/DME/IRU MEA	HEADI, NJ WP	*18000	45000
HEADI, NJ WP *18000 - GNSS MEA *DME/DME/IRU MEA	SAILN, OA WP	*18000	45000
SAILN, OA WP *18000 - GNSS MEA *DME/DME/IRU MEA	CALVERTON, NY VOR/DME	*18000	45000
CALVERTON, NY VOR/DME *18000 - GNSS MEA *DME/DME/IRU MEA	NTMEG, CT WP	*18000	45000
NTMEG, CT WP *18000 - GNSS MEA *DME/DME/IRU MEA	VENTE, MA WP	*18000	45000
VENTE, MA WP *18000 - GNSS MEA *DME/DME/IRU MEA	BLENO, NH WP	*18000	45000
BLENO, NH WP *18000 - GNSS MEA *DME/DME/IRU MEA	BEEKN, ME WP	*18000	45000
BEEKN, ME WP *GNSS REQUIRED	FRIAR, ME FIX	*18000	45000
FRIAR, ME FIX *GNSS REQUIRED	PRESQUE ISLE, ME VOR/DME	*18000	45000

**95.4098 RNAV ROUTE Q98**

HAKMN, NV WP *18000 - GNSS MEA *DME/DME/IRU MEA	ZZYZX, NV WP	*18000	45000
ZZYZX, NV WP *18000 - GNSS MEA *DME/DME/IRU MEA	LAKRR, NV WP	*18000	45000
LAKRR, NV WP *18000 - GNSS MEA *DME/DME/IRU MEA	DUZIT, AZ WP	*20000	45000



FROM	TO	MEA	MAA
------	----	-----	-----

**95.4098 RNAV ROUTE Q98 - CONTINUED**

DUZIT, AZ WP *18000 - GNSS MEA *DME/DME/IRU MEA	EEEZY, AZ WP	*24000	45000
EEEZY, AZ WP *18000 - GNSS MEA *DME/DME/IRU MEA	PEEWE, AZ WP	*24000	45000

**95.4099 RNAV ROUTE Q99**

KPASA, FL WP *18000 - GNSS MEA *DME/DME/IRU MEA	DOFFY, FL WP	*18000	45000
DOFFY, FL WP *18000 - GNSS MEA *DME/DME/IRU MEA	CAMJO, FL WP	*18000	45000
CAMJO, FL WP *18000 - GNSS MEA *DME/DME/IRU MEA	HEPAR, GA WP	*18000	45000
HEPAR, GA WP *18000 - GNSS MEA *DME/DME/IRU MEA	TEEEM, GA WP	*18000	45000
TEEEM, GA WP *18000 - GNSS MEA *DME/DME/IRU MEA	BLAAN, SC WP	*18000	45000
BLAAN, SC WP *18000 - GNSS MEA *DME/DME/IRU MEA	BWAGS, SC WP	*18000	45000
BWAGS, SC WP *18000 - GNSS MEA *DME/DME/IRU MEA	EFFAY, SC WP	*18000	45000
EFFAY, SC WP *18000 - GNSS MEA *DME/DME/IRU MEA	WNGUD, SC WP	*18000	45000
WNGUD, SC WP *18000 - GNSS MEA *DME/DME/IRU MEA	POLYY, NC WP	*18000	45000
POLYY, NC WP *18000 - GNSS MEA *DME/DME/IRU MEA	RAANE, NC WP	*18000	45000
RAANE, NC WP *18000 - GNSS MEA *DME/DME/IRU MEA	OGRAE, NC WP	*18000	45000
OGRAE, NC WP *18000 - GNSS MEA *DME/DME/IRU MEA	PEETT, NC WP	*18000	45000
PEETT, NC WP *18000 - GNSS MEA *DME/DME/IRU MEA	SHIRY, VA WP	*18000	45000
SHIRY, VA WP *18000 - GNSS MEA *DME/DME/IRU MEA	UMBRE, VA WP	*18000	45000
UMBRE, VA WP *18000 - GNSS MEA *DME/DME/IRU MEA	QUART, VA WP	*18000	45000
QUART, VA WP *18000 - GNSS MEA *DME/DME/IRU MEA	HURLE, VA WP	*18000	45000

**95.4101 RNAV ROUTE Q101**

SKARP, NC WP *18000 - GNSS MEA *DME/DME/IRU MEA	PRANK, NC WP	*18000	45000
---	--------------	--------	-------

FROM	TO	MEA	MAA
<b>95.4101 RNAV ROUTE Q101 - CONTINUED</b>			
PRANK, NC WP *18000 - GNSS MEA *DME/DME/IRU MEA	BGBRD, NC WP	*18000	45000
BGBRD, NC WP *18000 - GNSS MEA *DME/DME/IRU MEA	HYPAL, VA WP	*18000	45000
HYPAL, VA WP *18000 - GNSS MEA *DME/DME/IRU MEA	TUGGR, VA WP	*18000	45000
<b>95.4103 RNAV ROUTE Q103</b>			
CYNNTA, GA WP *30000 - GNSS MEA *DME/DME/IRU MEA	PUPYY, GA WP	*30000	45000
PUPYY, GA WP *30000 - GNSS MEA *DME/DME/IRU MEA	RIELE, SC WP	*30000	45000
RIELE, SC WP *30000 - GNSS MEA *DME/DME/IRU MEA	GRONK, SC WP	*30000	45000
GRONK, SC WP *18000 - GNSS MEA *DME/DME/IRU MEA	EMCET, SC WP	*18000	45000
EMCET, SC WP *18000 - GNSS MEA *DME/DME/IRU MEA	SLOJO, SC WP	*18000	45000
SLOJO, SC WP *18000 - GNSS MEA *DME/DME/IRU MEA	DANCO, VA WP	*18000	45000
DANCO, VA WP *18000 - GNSS MEA *DME/DME/IRU MEA	ASBUR, WV WP	*18000	45000
ASBUR, WV WP *18000 - GNSS MEA *DME/DME/IRU MEA	OAKLE, WV FIX	*18000	45000
OAKLE, WV FIX *18000 - GNSS MEA *DME/DME/IRU MEA	PERRI, WV FIX	*18000	45000
PERRI, WV FIX *18000 - GNSS MEA *DME/DME/IRU MEA	PERKS, WV FIX	*18000	45000
PERKS, WV FIX *18000 - GNSS MEA *DME/DME/IRU MEA	RICCS, WV WP	*18000	45000
RICCS, WV WP *18000 - GNSS MEA *DME/DME/IRU MEA	EMNEM, WV WP	*18000	45000
EMNEM, WV WP *18000 - GNSS MEA *DME/DME/IRU MEA	AIRRA, PA WP	*18000	45000
<b>95.4104 RNAV ROUTE Q104</b>			
ACORI, AL WP *18000 - GNSS MEA *DME/DME/IRU MEA	CABLO, GA WP	*18000	45000
CABLO, GA WP *18000 - GNSS MEA *DME/DME/IRU MEA	HEVVN, FL FIX	*18000	45000

FROM	TO	MEA	MAA
<b>95.4104 RNAV ROUTE Q104 - CONTINUED</b>			
HEVVN, FL FIX *18000 - GNSS MEA *DME/DME/IRU MEA	LEGGT, FL FIX	*18000	45000
LEGGT, FL FIX *18000 - GNSS MEA *DME/DME/IRU MEA	PLYER, FL FIX	*18000	45000
PLYER, FL FIX *18000 - GNSS MEA *DME/DME/IRU MEA	SWABE, FL FIX	*18000	45000
SWABE, FL FIX *18000 - GNSS MEA *DME/DME/IRU MEA	ENDEW, FL WP	*18000	45000
ENDEW, FL WP *18000 - GNSS MEA *DME/DME/IRU MEA	ST PETERSBURG, FL VORTAC	*18000	45000
<b>95.4107 RNAV ROUTE Q107</b>			
GARIC, NC WP *18000 - GNSS MEA *DME/DME/IRU MEA	ZORDO, NC WP	*18000	45000
ZORDO, NC WP *18000 - GNSS MEA *DME/DME/IRU MEA	JAAMS, NC WP	*18000	45000
JAAMS, NC WP *18000 - GNSS MEA *DME/DME/IRU MEA	ALINN, NC WP	*18000	45000
ALINN, NC WP *18000 - GNSS MEA *DME/DME/IRU MEA	HURTS, VA WP	*18000	45000
<b>95.4109 RNAV ROUTE Q109</b>			
KNOST, OG WP *18000 - GNSS MEA *DME/DME/IRU MEA	DEANR, FL WP	*18000	45000
DEANR, FL WP *18000 - GNSS MEA *DME/DME/IRU MEA	BRUTS, FL WP	*18000	45000
BRUTS, FL WP *18000 - GNSS MEA *DME/DME/IRU MEA	EVANZ, FL WP	*18000	45000
EVANZ, FL WP *18000 - GNSS MEA *DME/DME/IRU MEA	CAMJO, FL WP	*18000	45000
CAMJO, FL WP *18000 - GNSS MEA *DME/DME/IRU MEA	HEPAR, GA WP	*18000	45000
HEPAR, GA WP *18000 - GNSS MEA *DME/DME/IRU MEA	TEEEM, GA WP	*18000	45000
TEEEM, GA WP *18000 - GNSS MEA *DME/DME/IRU MEA	RIELE, SC WP	*18000	45000
RIELE, SC WP *18000 - GNSS MEA *DME/DME/IRU MEA	PANDY, SC WP	*18000	45000
PANDY, SC WP *18000 - GNSS MEA *DME/DME/IRU MEA	RAYVO, SC WP	*18000	45000

FROM	TO	MEA	MAA
<b>95.4109 RNAV ROUTE Q109 - CONTINUED</b>			
RAYVO, SC WP *18000 - GNSS MEA *DME/DME/IRU MEA	SESUE, SC WP	*18000	45000
SESUE, SC WP *18000 - GNSS MEA *DME/DME/IRU MEA	BUMMA, SC WP	*18000	45000
BUMMA, SC WP *18000 - GNSS MEA *DME/DME/IRU MEA	YURCK, NC WP	*18000	45000
YURCK, NC WP *18000 - GNSS MEA *DME/DME/IRU MEA	LAANA, NC WP	*18000	45000
LAANA, NC WP *18000 - GNSS MEA *DME/DME/IRU MEA	TINKK, NC WP	*18000	45000
TINKK, NC WP *18000 - GNSS MEA *DME/DME/IRU MEA	DFENC, NC WP	*18000	45000
<b>95.4110 RNAV ROUTE Q110</b>			
BLANS, IL WP *18000 - GNSS MEA *DME/DME/IRU MEA	BETIE, TN WP	*18000	45000
BETIE, TN WP *18000 - GNSS MEA *DME/DME/IRU MEA	SKIDO, AL WP	*18000	45000
SKIDO, AL WP *18000 - GNSS MEA *DME/DME/IRU MEA	BFOLO, AL WP	*18000	45000
BFOLO, AL WP *18000 - GNSS MEA *DME/DME/IRU MEA	JYROD, AL WP	*18000	45000
JYROD, AL WP *18000 - GNSS MEA *DME/DME/IRU MEA	DAWWN, GA WP	*18000	45000
DAWWN, GA WP *18000 - GNSS MEA *DME/DME/IRU MEA	JOKKY, FL WP	*18000	45000
JOKKY, FL WP *18000 - GNSS MEA *DME/DME/IRU MEA	AMORY, FL WP	*18000	45000
AMORY, FL WP *18000 - GNSS MEA *DME/DME/IRU MEA	SMELZ, FL WP	*18000	45000
SMELZ, FL WP *18000 - GNSS MEA *DME/DME/IRU MEA	SHEEK, FL WP	*18000	45000
SHEEK, FL WP *18000 - GNSS MEA *DME/DME/IRU MEA	JAYMC, FL WP	*18000	45000
JAYMC, FL WP *18000 - GNSS MEA *DME/DME/IRU MEA	OCTAL, FL WP	*18000	45000
<b>95.4111 RNAV ROUTE Q111</b>			
ZORDO, NC WP *18000 - GNSS MEA *DME/DME/IRU MEA	LARKE, NC WP	*18000	45000

FROM	TO	MEA	MAA
<b>95.4111 RNAV ROUTE Q111 - CONTINUED</b>			
LARKE, NC WP *18000 - GNSS MEA *DME/DME/IRU MEA	RUKRR, VA WP	*18000	45000
RUKRR, VA WP *18000 - GNSS MEA *DME/DME/IRU MEA	GEARS, VA WP	*18000	45000
GEARS, VA WP *18000 - GNSS MEA *DME/DME/IRU MEA	SWNGR, VA WP	*18000	45000
SWNGR, VA WP *18000 - GNSS MEA *DME/DME/IRU MEA	ALXEA, VA WP	*18000	45000
<b>95.4113 RNAV ROUTE Q113</b>			
RAYVO, SC WP *18000 - GNSS MEA *DME/DME/IRU MEA	CEELY, SC WP	*18000	45000
CEELY, SC WP *18000 - GNSS MEA *DME/DME/IRU MEA	SARKY, SC WP	*18000	45000
SARKY, SC WP *18000 - GNSS MEA *DME/DME/IRU MEA	MARCL, NC WP	*18000	45000
MARCL, NC WP *18000 - GNSS MEA *DME/DME/IRU MEA	AARNN, NC WP	*18000	45000
AARNN, NC WP *18000 - GNSS MEA *DME/DME/IRU MEA	RIDDN, VA WP	*18000	45000
<b>95.4114 RNAV ROUTE Q114</b>			
NATEE, NV WP *18000 - GNSS MEA *DME/DME/IRU MEA	BOULDER CITY, NV VORTAC	*18000	45000
BOULDER CITY, NV VORTAC *18000 - GNSS MEA *DME/DME/IRU MEA	ZAINY, AZ WP	*20000	45000
ZAINY, AZ WP *18000 - GNSS MEA *DME/DME/IRU MEA	AHOWW, UT WP	*20000	45000
AHOWW, UT WP *18000 - GNSS MEA *DME/DME/IRU MEA	BAWER, UT WP	*24000	45000
BAWER, UT WP *18000 - GNSS MEA *DME/DME/IRU MEA	BUGGG, UT WP	*24000	45000
BUGGG, UT WP *18000 - GNSS MEA *DME/DME/IRU MEA	ZAKRY, CO WP	*24000	45000
ZAKRY, CO WP *20000 - GNSS MEA *DME/DME/IRU MEA	BULDG, CO WP	*20000	45000
BULDG, CO WP *20000 - GNSS MEA *DME/DME/IRU MEA	COUGH, CO WP	*20000	45000
COUGH, CO WP *18000 - GNSS MEA *DME/DME/IRU MEA	AVVVS, CO FIX	*20000	45000

FROM	TO	MEA	MAA
<b>95.4114 RNAV ROUTE Q114 - CONTINUED</b>			
AVVVS, CO FIX *18000 - GNSS MEA *DME/DME/IRU MEA	BRAFF, CO WP	*20000	45000
BRAFF, CO WP *18000 - GNSS MEA *DME/DME/IRU MEA	GOORE, CO WP	*20000	45000
GOORE, CO WP *18000 - GNSS MEA *DME/DME/IRU MEA	AYOLE, NE WP	*20000	45000
AYOLE, NE WP *18000 - GNSS MEA *DME/DME/IRU MEA	PECKS, NE WP	*20000	45000
PECKS, NE WP *18000 - GNSS MEA *DME/DME/IRU MEA	LEONG, IA WP	*20000	45000
<b>95.4116 RNAV ROUTE Q116</b>			
SPRINGFIELD, MO VORTAC *18000 - GNSS MEA *DME/DME/IRU MEA	ZAVEL, AR WP	*18000	45000
ZAVEL, AR WP *18000 - GNSS MEA *DME/DME/IRU MEA	LUKKY, AR WP	*18000	45000
LUKKY, AR WP *18000 - GNSS MEA *DME/DME/IRU MEA	MEMFS, TN WP	*18000	45000
MEMFS, TN WP *18000 - GNSS MEA *DME/DME/IRU MEA	GOOGY, AL WP	*18000	45000
GOOGY, AL WP *18000 - GNSS MEA *DME/DME/IRU MEA	LOBBS, AL FIX	*18000	45000
LOBBS, AL FIX *18000 - GNSS MEA *DME/DME/IRU MEA	VLKNN, AL WP	*18000	45000
VLKNN, AL WP *18000 - GNSS MEA *DME/DME/IRU MEA	DEEDA, GA WP	*18000	45000
DEEDA, GA WP *18000 - GNSS MEA *DME/DME/IRU MEA	JAWJA, FL WP	*18000	45000
JAWJA, FL WP *18000 - GNSS MEA *DME/DME/IRU MEA	MICES, FL WP	*18000	45000
MICES, FL WP *18000 - GNSS MEA *DME/DME/IRU MEA	DEANR, FL WP	*18000	45000
DEANR, FL WP *18000 - GNSS MEA *DME/DME/IRU MEA	PAToy, FL WP	*18000	45000
PAToy, FL WP *18000 - GNSS MEA *DME/DME/IRU MEA	SMELZ, FL WP	*18000	45000
SMELZ, FL WP *18000 - GNSS MEA *DME/DME/IRU MEA	SHEEK, FL WP	*18000	45000
SHEEK, FL WP *18000 - GNSS MEA *DME/DME/IRU MEA	JAYMC, FL WP	*18000	45000

FROM	TO	MEA	MAA
<b>95.4116 RNAV ROUTE Q116 - CONTINUED</b>			
JAYMC, FL WP *18000 - GNSS MEA *DME/DME/IRU MEA	OCTAL, FL WP	*18000	45000
<b>95.4117 RNAV ROUTE Q117</b>			
YLEEE, NC WP *18000 - GNSS MEA *DME/DME/IRU MEA	CUDLE, NC WP	*18000	45000
CUDLE, NC WP *18000 - GNSS MEA *DME/DME/IRU MEA	SUSSA, NC WP	*18000	45000
SUSSA, NC WP *18000 - GNSS MEA *DME/DME/IRU MEA	KTEEE, NC WP	*18000	45000
KTEEE, NC WP *18000 - GNSS MEA *DME/DME/IRU MEA	SAWED, VA FIX	*18000	45000
<b>95.4118 RNAV ROUTE Q118</b>			
BONNT, IN WP *18000 - GNSS MEA *DME/DME/IRU MEA	HEVAN, IN WP	*18000	45000
HEVAN, IN WP *18000 - GNSS MEA *DME/DME/IRU MEA	ROYYZ, IN WP	*18000	45000
ROYYZ, IN WP *18000 - GNSS MEA *DME/DME/IRU MEA	VOSTK, KY WP	*18000	45000
VOSTK, KY WP *18000 - GNSS MEA *DME/DME/IRU MEA	HELUB, KY WP	*18000	45000
HELUB, KY WP *18000 - GNSS MEA *DME/DME/IRU MEA	JEDER, KY WP	*18000	45000
JEDER, KY WP *18000 - GNSS MEA *DME/DME/IRU MEA	GLAZR, TN WP	*18000	45000
GLAZR, TN WP *18000 - GNSS MEA *DME/DME/IRU MEA	KAILL, GA WP	*18000	45000
KAILL, GA WP *18000 - GNSS MEA *DME/DME/IRU MEA	THRSR, GA WP	*18000	45000
THRSR, GA WP *18000 - GNSS MEA *DME/DME/IRU MEA	JOHNN, GA WP	*18000	45000
JOHNN, GA WP *18000 - GNSS MEA *DME/DME/IRU MEA	JAMIZ, FL WP	*18000	45000
JAMIZ, FL WP *18000 - GNSS MEA *DME/DME/IRU MEA	BRUTS, FL WP	*18000	45000
BRUTS, FL WP *18000 - GNSS MEA *DME/DME/IRU MEA	JINOS, FL WP	*18000	45000
JINOS, FL WP *18000 - GNSS MEA *DME/DME/IRU MEA	KPASA, FL WP	*18000	45000

FROM	TO	MEA	MAA
<b>95.4118 RNAV ROUTE Q118 - CONTINUED</b>			
KPASA, FL WP *18000 - GNSS MEA *DME/DME/IRU MEA	SHEEK, FL WP	*18000	45000
SHEEK, FL WP *18000 - GNSS MEA *DME/DME/IRU MEA	CHRRI, FL WP	*18000	45000
CHRRI, FL WP *18000 - GNSS MEA *DME/DME/IRU MEA	FEMID, FL WP	*18000	45000
FEMID, FL WP *18000 - GNSS MEA *DME/DME/IRU MEA	PEAKY, FL WP	*18000	45000
<b>95.4119 RNAV ROUTE Q119</b>			
SCOOB, VA WP *18000 - GNSS MEA *DME/DME/IRU MEA	GROKK, VA WP	*18000	45000
GROKK, VA WP *18000 - GNSS MEA *DME/DME/IRU MEA	RYVRR, VA WP	*18000	45000
RYVRR, VA WP *18000 - GNSS MEA *DME/DME/IRU MEA	SHTGN, MD WP	*18000	45000
SHTGN, MD WP *18000 - GNSS MEA *DME/DME/IRU MEA	DUALY, MD WP	*18000	45000
DUALY, MD WP *18000 - GNSS MEA *DME/DME/IRU MEA	HALEX, MD WP	*18000	45000
HALEX, MD WP *18000 - GNSS MEA *DME/DME/IRU MEA	WESTMINSTER, MD VORTAC	*18000	45000
<b>95.4120 RNAV ROUTE Q120</b>			
ORRCA, CA WP *18000 - GNSS MEA *DME/DME/IRU MEA	BETBE, NV WP	*24000	45000
BETBE, NV WP *18000 - GNSS MEA *DME/DME/IRU MEA	ZORUN, NV WP	*24000	45000
ZORUN, NV WP *18000 - GNSS MEA *DME/DME/IRU MEA	GALLI, NV WP	*31000	45000
GALLI, NV WP *18000 - GNSS MEA *DME/DME/IRU MEA	JAJAY, NV WP	*31000	45000
JAJAY, NV WP *18000 - GNSS MEA *DME/DME/IRU MEA	TRAKY, NV WP	*31000	45000
TRAKY, NV WP *18000 - GNSS MEA *DME/DME/IRU MEA	PROXI, UT WP	*29000	45000
PROXI, UT WP *18000 - GNSS MEA *DME/DME/IRU MEA	BIG PINEY, WY VOR/DME	*25000	45000
BIG PINEY, WY VOR/DME *18000 - GNSS MEA *DME/DME/IRU MEA	JUGIV, WY WP	*23000	45000



FROM	TO	MEA	MAA
------	----	-----	-----

**95.4120 RNAV ROUTE Q120 - CONTINUED**

JUGIV, WY WP *18000 - GNSS MEA *DME/DME/IRU MEA	HIKOX, WY FIX	*23000	45000
HIKOX, WY FIX *18000 - GNSS MEA *DME/DME/IRU MEA	JASTI, SD WP	*23000	45000
JASTI, SD WP *18000 - GNSS MEA *DME/DME/IRU MEA	UFFDA, MN WP	*19000	45000

**95.4121 RNAV ROUTE Q121**

PARZZ, NV WP *18000 - GNSS MEA *DME/DME/IRU MEA	POCATELLO, ID VOR/DME	*24000	45000
POCATELLO, ID VOR/DME *18000 - GNSS MEA *DME/DME/IRU MEA	SWTHN, MT WP	*24000	45000

**95.4122 RNAV ROUTE Q122**

MOGEE, CA WP *18000 - GNSS MEA *DME/DME/IRU MEA	MACUS, NV WP	*18000	45000
MACUS, NV WP *18000 - GNSS MEA *DME/DME/IRU MEA	MCORD, NV WP	*28000	45000
MCORD, NV WP *18000 - GNSS MEA *DME/DME/IRU MEA	LUCIN, UT VORTAC	*28000	45000
LUCIN, UT VORTAC *18000 - GNSS MEA *DME/DME/IRU MEA	BEARR, UT FIX	*28000	45000
BEARR, UT FIX *18000 - GNSS MEA *DME/DME/IRU MEA	KURSE, WY WP	*28000	45000
KURSE, WY WP *18000 - GNSS MEA *DME/DME/IRU MEA	O'NEILL, NE VORTAC	*21000	45000
O'NEILL, NE VORTAC *18000 - GNSS MEA *DME/DME/IRU MEA	KATES, NE WP	*18000	45000
KATES, NE WP *18000 - GNSS MEA *DME/DME/IRU MEA	VIRGN, IA WP	*18000	45000
VIRGN, IA WP *18000 - GNSS MEA *DME/DME/IRU MEA	VIGGR, IA WP	*18000	45000

**95.4123 RNAV ROUTE Q123**

PARZZ, NV WP *18000 - GNSS MEA *DME/DME/IRU MEA	COKEE, MT WP	*24000	45000
---	--------------	--------	-------

**95.4124 RNAV ROUTE Q124**

MOGEE, CA WP *18000 - GNSS MEA *DME/DME/IRU MEA	MACUS, NV WP	*18000	45000
---	--------------	--------	-------

FROM	TO	MEA	MAA
<b>95.4124 RNAV ROUTE Q124 - CONTINUED</b>			
MACUS, NV WP *18000 - GNSS MEA *DME/DME/IRU MEA	MCORD, NV WP	*28000	45000
MCORD, NV WP *18000 - GNSS MEA *DME/DME/IRU MEA	SLOWN, NV WP	*28000	45000
SLOWN, NV WP *18000 - GNSS MEA *DME/DME/IRU MEA	FASTE, NV WP	*28000	45000
FASTE, NV WP *18000 - GNSS MEA *DME/DME/IRU MEA	BONNEVILLE, UT VORTAC	*23000	45000
BONNEVILLE, UT VORTAC *18000 - GNSS MEA *DME/DME/IRU MEA	WAATS, UT FIX	*18000	45000
<b>95.4125 RNAV ROUTE Q125</b>			
PARZZ, NV WP *18000 - GNSS MEA *DME/DME/IRU MEA	WLLES, MT WP	*24000	45000
<b>95.4126 RNAV ROUTE Q126</b>			
TIPRE, CA WP *18000 - GNSS MEA *DME/DME/IRU MEA	INSLO, NV WP	*21000	45000
INSLO, NV WP *18000 - GNSS MEA *DME/DME/IRU MEA	CHUKR, NV WP	*26000	45000
CHUKR, NV WP *18000 - GNSS MEA *DME/DME/IRU MEA	TTOES, NV WP	*26000	45000
TTOES, NV WP *18000 - GNSS MEA *DME/DME/IRU MEA	GAROT, UT WP	*26000	45000
GAROT, UT WP *18000 - GNSS MEA *DME/DME/IRU MEA	KREYK, UT WP	*19000	45000
KREYK, UT WP *18000 - GNSS MEA *DME/DME/IRU MEA	DRRSI, UT WP	*19000	45000
DRRSI, UT WP *18000 - GNSS MEA *DME/DME/IRU MEA	LBATO, UT WP	*19000	45000
LBATO, UT WP *18000 - GNSS MEA *DME/DME/IRU MEA	BASNN, CO WP	*19000	45000
BASNN, CO WP *19000 - GNSS MEA *DME/DME/IRU MEA	BRAFF, CO WP	*19000	45000
<b>95.4127 RNAV ROUTE Q127</b>			
GORDONSVILLE, VA VORTAC *18000 - GNSS MEA *DME/DME/IRU MEA	BUKYY, MD WP	*18000	45000
BUKYY, MD WP *18000 - GNSS MEA *DME/DME/IRU MEA	BAILZ, MD WP	*18000	45000

FROM	TO	MEA	MAA
<b>95.4127 RNAV ROUTE Q127 - CONTINUED</b>			
BAILZ, MD WP *18000 - GNSS MEA *DME/DME/IRU MEA	GRACO, MD FIX	*18000	45000
GRACO, MD FIX *18000 - GNSS MEA *DME/DME/IRU MEA	SMYRNA, DE VORTAC	*18000	45000
<b>95.4128 RNAV ROUTE Q128</b>			
SYRAH, CA WP *18000 - GNSS MEA *DME/DME/IRU MEA	JSICA, NV WP	*27000	45000
JSICA, NV WP *18000 - GNSS MEA *DME/DME/IRU MEA	TABLL, UT WP	*25000	45000
TABLL, UT WP *18000 - GNSS MEA *DME/DME/IRU MEA	EDLES, UT FIX	*25000	45000
EDLES, UT FIX *18000 - GNSS MEA *DME/DME/IRU MEA	FLOOD, CO FIX	*24000	45000
FLOOD, CO FIX *18000 - GNSS MEA *DME/DME/IRU MEA	ZAROS, CO WP	*22000	45000
ZAROS, CO WP *18000 - GNSS MEA *DME/DME/IRU MEA	VEGUC, OK WP	*20000	45000
VEGUC, OK WP *18000 - GNSS MEA *DME/DME/IRU MEA	VLUST, AR WP	*18000	45000
VLUST, AR WP *18000 - GNSS MEA *DME/DME/IRU MEA	ECIGE, AR WP	*18000	45000
ECIGE, AR WP *18000 - GNSS MEA *DME/DME/IRU MEA	MUDHO, MS WP	*18000	45000
MUDHO, MS WP *18000 - GNSS MEA *DME/DME/IRU MEA	JILLS, AL WP	*18000	45000
<b>95.4129 RNAV ROUTE Q129</b>			
GARIC, NC WP *18000 - GNSS MEA *DME/DME/IRU MEA	YERBA, NC WP	*18000	45000
YERBA, NC WP *18000 - GNSS MEA *DME/DME/IRU MEA	AARNN, NC WP	*18000	45000
AARNN, NC WP *18000 - GNSS MEA *DME/DME/IRU MEA	THEOO, VA WP	*18000	45000
THEOO, VA WP *18000 - GNSS MEA *DME/DME/IRU MEA	PYTON, MD WP	*18000	45000
<b>95.4130 RNAV ROUTE Q130</b>			
SYRAH, CA WP *18000 - GNSS MEA *DME/DME/IRU MEA	JSICA, NV WP	*27000	45000

FROM	TO	MEA	MAA
<b>95.4130 RNAV ROUTE Q130 - CONTINUED</b>			
JSICA, NV WP *18000 - GNSS MEA *DME/DME/IRU MEA	REANA, NV WP	*27000	45000
REANA, NV WP *18000 - GNSS MEA *DME/DME/IRU MEA	ROCCY, UT WP	*27000	45000
ROCCY, UT WP *18000 - GNSS MEA *DME/DME/IRU MEA	HASSL, UT WP	*27000	45000
HASSL, UT WP *18000 - GNSS MEA *DME/DME/IRU MEA	TAHIB, CO WP	*22000	45000
TAHIB, CO WP *18000 - GNSS MEA *DME/DME/IRU MEA	DIXAN, NM FIX	*22000	45000
DIXAN, NM FIX *18000 - GNSS MEA *DME/DME/IRU MEA	MIRME, NM WP	*22000	45000
MIRME, NM WP *18000 - GNSS MEA *DME/DME/IRU MEA	PANHANDLE, TX VORTAC	*18000	45000
<b>95.4131 RNAV ROUTE Q131</b>			
ZILLS, NC WP *18000 - GNSS MEA *DME/DME/IRU MEA	YLEEE, NC WP	*18000	45000
YLEEE, NC WP *18000 - GNSS MEA *DME/DME/IRU MEA	EARZZ, NC WP	*18000	45000
EARZZ, NC WP *18000 - GNSS MEA *DME/DME/IRU MEA	ODAWG, VA WP	*18000	45000
ODAWG, VA WP *18000 - GNSS MEA *DME/DME/IRU MEA	KALDA, VA FIX	*18000	45000
KALDA, VA FIX *18000 - GNSS MEA *DME/DME/IRU MEA	ZJAAY, MD WP	*18000	45000
<b>95.4132 RNAV ROUTE Q132</b>			
WEBGO, CA WP *18000 - GNSS MEA *DME/DME/IRU MEA	ANAHO, NV FIX	*18000	45000
ANAHO, NV FIX *18000 - GNSS MEA *DME/DME/IRU MEA	MYBAD, NV WP	*18000	45000
MYBAD, NV WP *18000 - GNSS MEA *DME/DME/IRU MEA	ZERAM, NV WP	*18000	45000
ZERAM, NV WP *18000 - GNSS MEA *DME/DME/IRU MEA	MAGPY, NV WP	*26000	45000
<b>95.4133 RNAV ROUTE Q133</b>			
CHIEZ, NC WP *18000 - GNSS MEA *DME/DME/IRU MEA	BENCH, NC WP	*18000	45000

FROM	TO	MEA	MAA
------	----	-----	-----

**95.4133 RNAV ROUTE Q133 - CONTINUED**

BENCH, NC WP *18000 - GNSS MEA *DME/DME/IRU MEA	KOOKI, NC WP	*18000	45000
KOOKI, NC WP *18000 - GNSS MEA *DME/DME/IRU MEA	PYSTN, VA WP	*18000	45000
PYSTN, VA WP *18000 - GNSS MEA *DME/DME/IRU MEA	KALDA, VA FIX	*18000	45000
KALDA, VA FIX *18000 - GNSS MEA *DME/DME/IRU MEA	CONFR, MD WP	*18000	45000
CONFR, MD WP *18000 - GNSS MEA *DME/DME/IRU MEA	MGERK, DE WP	*18000	45000
MGERK, DE WP *18000 - GNSS MEA *DME/DME/IRU MEA	LEEAH, NJ FIX	*18000	45000
LEEAH, NJ FIX *18000 - GNSS MEA *DME/DME/IRU MEA	MYRCA, NJ WP	*18000	45000
MYRCA, NJ WP *18000 - GNSS MEA *DME/DME/IRU MEA	KENNEDY, NY VOR/DME	*18000	45000
KENNEDY, NY VOR/DME *18000 - GNSS MEA *DME/DME/IRU MEA	LLUND, NY FIX	*18000	45000
LLUND, NY FIX *18000 - GNSS MEA *DME/DME/IRU MEA	FARLE, NY FIX	*18000	45000
FARLE, NY FIX *18000 - GNSS MEA *DME/DME/IRU MEA	GANDE, NY FIX	*18000	45000
GANDE, NY FIX *18000 - GNSS MEA *DME/DME/IRU MEA	PONCT, NY WP	*18000	45000

**95.4134 RNAV ROUTE Q134**

DUGLE, CA FIX *18000 - GNSS MEA *DME/DME/IRU MEA	TATOO, NV WP	*20000	45000
TATOO, NV WP *18000 - GNSS MEA *DME/DME/IRU MEA	JULIK, UT FIX	*24000	45000
JULIK, UT FIX *18000 - GNSS MEA *DME/DME/IRU MEA	HERSH, UT WP	*21000	45000
HERSH, UT WP *18000 - GNSS MEA *DME/DME/IRU MEA	VOAXA, CO FIX	*21000	45000

**95.4135 RNAV ROUTE Q135**

JROSS, SC WP *18000 - GNSS MEA *DME/DME/IRU MEA	PELIE, SC WP	*18000	45000
PELIE, SC WP *18000 - GNSS MEA *DME/DME/IRU MEA	ELMSZ, SC WP	*18000	45000

FROM	TO	MEA	MAA
<b>95.4135 RNAV ROUTE Q135 - CONTINUED</b>			
ELMSZ, SC WP *18000 - GNSS MEA *DME/DME/IRU MEA	RAPZZ, NC WP	*18000	45000
RAPZZ, NC WP *18000 - GNSS MEA *DME/DME/IRU MEA	ZORDO, NC WP	*18000	45000
ZORDO, NC WP *18000 - GNSS MEA *DME/DME/IRU MEA	CUDLE, NC WP	*18000	45000
<b>95.4136 RNAV ROUTE Q136</b>			
COALDALE, NV VORTAC *GNSS REQUIRED	RUMPS, NV WP	*18000	45000
RUMPS, NV WP *GNSS REQUIRED	KATTS, NV WP	*18000	45000
KATTS, NV WP *GNSS REQUIRED	CRLES, NV WP	*18000	45000
CRLES, NV WP *18000 - GNSS MEA *DME/DME/IRU MEA	GDGET, UT WP	*26000	45000
GDGET, UT WP *18000 - GNSS MEA *DME/DME/IRU MEA	TRALP, UT WP	*26000	45000
TRALP, UT WP *18000 - GNSS MEA *DME/DME/IRU MEA	MANRD, UT WP	*26000	45000
MANRD, UT WP *18000 - GNSS MEA *DME/DME/IRU MEA	WEEMN, UT WP	*26000	45000
WEEMN, UT WP *18000 - GNSS MEA *DME/DME/IRU MEA	ELLFF, CO WP	*26000	45000
ELLFF, CO WP *18000 - GNSS MEA *DME/DME/IRU MEA	VOAXA, CO FIX	*21000	45000
VOAXA, CO FIX *21000 - GNSS MEA *DME/DME/IRU MEA	COUGH, CO WP	*21000	45000
COUGH, CO WP *18000 - GNSS MEA *DME/DME/IRU MEA	BBULL, CO WP	*21000	45000
BBULL, CO WP *18000 - GNSS MEA *DME/DME/IRU MEA	ZIRKL, NE WP	*21000	45000
ZIRKL, NE WP *18000 - GNSS MEA *DME/DME/IRU MEA	KAWWA, NE WP	*21000	45000
KAWWA, NE WP *18000 - GNSS MEA *DME/DME/IRU MEA	SYTHH, NE WP	*21000	45000
SYTHH, NE WP *18000 - GNSS MEA *DME/DME/IRU MEA	AYEGI, NE WP	*19000	45000
AYEGI, NE WP *18000 - GNSS MEA *DME/DME/IRU MEA	TURCK, NE WP	*19000	45000
TURCK, NE WP *18000 - GNSS MEA *DME/DME/IRU MEA	WRNCH, IA WP	*19000	45000

FROM	TO	MEA	MAA
<b>95.4136 RNAV ROUTE Q136 - CONTINUED</b>			
WRNCH, IA WP *18000 - GNSS MEA *DME/DME/IRU MEA	BVEEE, IA WP	*19000	45000
BVEEE, IA WP *18000 - GNSS MEA *DME/DME/IRU MEA	HIBAV, IA WP	*19000	45000
HIBAV, IA WP *18000 - GNSS MEA *DME/DME/IRU MEA	DIYAP, IA WP	*19000	45000
<b>95.4138 RNAV ROUTE Q138</b>			
WILLIAMS, CA VORTAC *18000 - GNSS MEA *DME/DME/IRU MEA	FIMUV, CA WP	*18000	45000
FIMUV, CA WP *18000 - GNSS MEA *DME/DME/IRU MEA	JENSA, NV WP	*22000	45000
JENSA, NV WP *18000 - GNSS MEA *DME/DME/IRU MEA	PUHGI, NV WP	*24000	45000
PUHGI, NV WP *18000 - GNSS MEA *DME/DME/IRU MEA	ROOHZ, NV WP	*24000	45000
ROOHZ, NV WP *18000 - GNSS MEA *DME/DME/IRU MEA	PARZZ, NV WP	*24000	45000
PARZZ, NV WP *18000 - GNSS MEA *DME/DME/IRU MEA	UROCO, WY WP	*24000	45000
UROCO, WY WP *18000 - GNSS MEA *DME/DME/IRU MEA	RICCO, WY WP	*24000	45000
RICCO, WY WP *18000 - GNSS MEA *DME/DME/IRU MEA	MOTLY, SD WP	*24000	45000
MOTLY, SD WP *18000 - GNSS MEA *DME/DME/IRU MEA	DKOTA, SD WP	*24000	45000
DKOTA, SD WP *18000 - GNSS MEA *DME/DME/IRU MEA	WELOK, MN WP	*20000	45000
WELOK, MN WP *18000 - GNSS MEA *DME/DME/IRU MEA	CESNA, WI WP	*20000	45000
CESNA, WI WP *18000 - GNSS MEA *DME/DME/IRU MEA	GUUME, WI WP	*20000	45000
GUUME, WI WP *18000 - GNSS MEA *DME/DME/IRU MEA	SNARG, WI WP	*20000	45000
SNARG, WI WP *18000 - GNSS MEA *DME/DME/IRU MEA	SAULT STE MARIE, MI VOR/DME	*20000	45000
<b>95.4139 RNAV ROUTE Q139</b>			
MGMRY, AL WP *18000 - GNSS MEA *DME/DME/IRU MEA	VLKNN, AL WP	*18000	45000

FROM	TO	MEA	MAA
<b>95.4139 RNAV ROUTE Q139 - CONTINUED</b>			
VLKNN, AL WP *18000 - GNSS MEA *DME/DME/IRU MEA	SALMS, TN WP	*18000	45000
SALMS, TN WP *18000 - GNSS MEA *DME/DME/IRU MEA	HITMN, TN WP	*18000	45000
HITMN, TN WP *18000 - GNSS MEA *DME/DME/IRU MEA	LOUISVILLE, KY VORTAC	*18000	45000
LOUISVILLE, KY VORTAC *18000 - GNSS MEA *DME/DME/IRU MEA	GBEES, IN FIX	*18000	45000
GBEES, IN FIX *18000 - GNSS MEA *DME/DME/IRU MEA	HICKI, IN FIX	*18000	45000
HICKI, IN FIX *18000 - GNSS MEA *DME/DME/IRU MEA	CREEP, OH FIX	*18000	45000
CREEP, OH FIX *18000 - GNSS MEA *DME/DME/IRU MEA	RINTE, OH WP	*18000	45000
<b>95.4140 RNAV ROUTE Q140</b>			
WOBED, WA WP *18000 - GNSS MEA *DME/DME/IRU MEA	GETNG, WA WP	*25000	45000
GETNG, WA WP *18000 - GNSS MEA *DME/DME/IRU MEA	CORDU, ID FIX	*25000	45000
CORDU, ID FIX *18000 - GNSS MEA *DME/DME/IRU MEA	PETIY, MT WP	*30000	45000
PETIY, MT WP *18000 - GNSS MEA *DME/DME/IRU MEA	CHOTE, MT FIX	*32000	45000
CHOTE, MT FIX *18000 - GNSS MEA *DME/DME/IRU MEA	LEWIT, MT WP	*26000	45000
LEWIT, MT WP *18000 - GNSS MEA *DME/DME/IRU MEA	SAYOR, MT WP	*24000	45000
SAYOR, MT WP *18000 - GNSS MEA *DME/DME/IRU MEA	WILTN, ND FIX	*18000	45000
WILTN, ND FIX *18000 - GNSS MEA *DME/DME/IRU MEA	TTAIL, MN WP	*18000	45000
TTAIL, MN WP *18000 - GNSS MEA *DME/DME/IRU MEA	CESNA, WI WP	*18000	45000
CESNA, WI WP *18000 - GNSS MEA *DME/DME/IRU MEA	WISCN, WI WP	*19000	45000
WISCN, WI WP *18000 - GNSS MEA *DME/DME/IRU MEA	EEGEE, WI WP	*18000	45000
EEGEE, WI WP *18000 - GNSS MEA *DME/DME/IRU MEA	DAYYY, MI WP	*18000	45000



FROM	TO	MEA	MAA
------	----	-----	-----

**95.4140 RNAV ROUTE Q140 - CONTINUED**

DAYYY, MI WP *18000 - GNSS MEA *DME/DME/IRU MEA	U.S. CANADIAN BORDER	*18000	45000
U.S. CANADIAN BORDER *18000 - GNSS MEA *DME/DME/IRU MEA	AHPAH, NY WP	*18000	45000
AHPAH, NY WP *18000 - GNSS MEA *DME/DME/IRU MEA	HANKK, NY WP	*18000	45000
HANKK, NY WP *18000 - GNSS MEA *DME/DME/IRU MEA	BEEPS, NY FIX	*18000	45000
BEEPS, NY FIX *18000 - GNSS MEA *DME/DME/IRU MEA	EXTOL, NY FIX	*18000	45000
EXTOL, NY FIX *18000 - GNSS MEA *DME/DME/IRU MEA	MEMMS, NY FIX	*18000	45000
MEMMS, NY FIX *18000 - GNSS MEA *DME/DME/IRU MEA	KODEY, NY FIX	*18000	45000
KODEY, NY FIX *18000 - GNSS MEA *DME/DME/IRU MEA	ARRKK, NY WP	*18000	45000
ARRKK, NY WP *18000 - GNSS MEA *DME/DME/IRU MEA	RODYY, NY WP	*18000	45000
RODYY, NY WP *18000 - GNSS MEA *DME/DME/IRU MEA	YODAA, NY FIX	*18000	45000

**95.4142 RNAV ROUTE Q142**

METOW, WA WP *18000 - GNSS MEA *DME/DME/IRU MEA	MULLAN PASS, ID VOR/DME	*26000	45000
MULLAN PASS, ID VOR/DME *18000 - GNSS MEA *DME/DME/IRU MEA	KEETA, MT WP	*26000	45000
KEETA, MT WP *18000 - GNSS MEA *DME/DME/IRU MEA	OKVUJ, MT WP	*24000	45000
OKVUJ, MT WP *18000 - GNSS MEA *DME/DME/IRU MEA	KIXCO, MT FIX	*22000	45000

**95.4144 RNAV ROUTE Q144**

ZIRAN, WA WP *18000 - GNSS MEA *DME/DME/IRU MEA	ZOOMR, WA FIX	*18000	45000
ZOOMR, WA FIX *18000 - GNSS MEA *DME/DME/IRU MEA	BLOWS, MT WP	*21000	45000
BLOWS, MT WP *18000 - GNSS MEA *DME/DME/IRU MEA	KEETA, MT WP	*21000	45000
KEETA, MT WP *18000 - GNSS MEA *DME/DME/IRU MEA	LEWIT, MT WP	*21000	45000

FROM	TO	MEA	MAA
<b>95.4145 RNAV ROUTE Q145</b>			
KONGO, KY WP *18000 - GNSS MEA *DME/DME/IRU MEA	CHARLESTON, WV VOR/DME	*18000	45000
CHARLESTON, WV VOR/DME *18000 - GNSS MEA *DME/DME/IRU MEA	CLNTN, OH WP	*18000	45000
CLNTN, OH WP *18000 - GNSS MEA *DME/DME/IRU MEA	FOXEE, PA WP	*18000	45000
<b>95.4146 RNAV ROUTE Q146</b>			
CASHS, WA FIX *18000 - GNSS MEA *DME/DME/IRU MEA	BLUNT, WA FIX	*24000	45000
BLUNT, WA FIX *18000 - GNSS MEA *DME/DME/IRU MEA	DIPHU, MT FIX	*24000	45000
DIPHU, MT FIX *18000 - GNSS MEA *DME/DME/IRU MEA	CUSDA, MT FIX	*24000	45000
CUSDA, MT FIX *18000 - GNSS MEA *DME/DME/IRU MEA	ZERZO, MT FIX	*24000	45000
ZERZO, MT FIX *18000 - GNSS MEA *DME/DME/IRU MEA	KIXCO, MT FIX	*22000	45000
KIXCO, MT FIX *18000 - GNSS MEA *DME/DME/IRU MEA	TIMMR, ND FIX	*20000	45000
TIMMR, ND FIX *18000 - GNSS MEA *DME/DME/IRU MEA	SMERF, SD WP	*20000	45000
SMERF, SD WP *18000 - GNSS MEA *DME/DME/IRU MEA	HUFFR, MN WP	*18000	45000
<b>95.4148 RNAV ROUTE Q148</b>			
STEVs, WA WP *18000 - GNSS MEA *DME/DME/IRU MEA	ZAXUL, WA FIX	*18000	45000
ZAXUL, WA FIX *18000 - GNSS MEA *DME/DME/IRU MEA	FINUT, WA WP	*24000	45000
FINUT, WA WP *18000 - GNSS MEA *DME/DME/IRU MEA	WEDAK, MT FIX	*26000	45000
WEDAK, MT FIX *18000 - GNSS MEA *DME/DME/IRU MEA	WAIDE, MT FIX	*26000	45000
WAIDE, MT FIX *18000 - GNSS MEA *DME/DME/IRU MEA	JUGIV, WY WP	*26000	45000
JUGIV, WY WP *18000 - GNSS MEA *DME/DME/IRU MEA	MEDICINE BOW, WY VOR/DME	*26000	45000
MEDICINE BOW, WY VOR/DME *18000 - GNSS MEA *DME/DME/IRU MEA	MOCTU, WY FIX	*26000	45000

FROM	TO	MEA	MAA
<b>95.4148 RNAV ROUTE Q148 - CONTINUED</b>			
MOCTU, WY FIX *18000 - GNSS MEA *DME/DME/IRU MEA	LEWOY, CO WP	*26000	45000
LEWOY, CO WP *18000 - GNSS MEA *DME/DME/IRU MEA	CUGGA, KS FIX	*26000	45000
CUGGA, KS FIX *18000 - GNSS MEA *DME/DME/IRU MEA	PENUT, KS WP	*26000	45000
PENUT, KS WP *18000 - GNSS MEA *DME/DME/IRU MEA	KIRKE, KS FIX	*26000	45000
KIRKE, KS FIX *18000 - GNSS MEA *DME/DME/IRU MEA	MORRR, KS WP	*26000	45000
MORRR, KS WP *18000 - GNSS MEA *DME/DME/IRU MEA	BARTLESVILLE, OK VOR/DME	*26000	45000
<b>95.4150 RNAV ROUTE Q150</b>			
STEVS, WA WP *18000 - GNSS MEA *DME/DME/IRU MEA	ZAXUL, WA FIX	*18000	45000
ZAXUL, WA FIX *18000 - GNSS MEA *DME/DME/IRU MEA	LEZLE, WA FIX	*24000	45000
LEZLE, WA FIX *18000 - GNSS MEA *DME/DME/IRU MEA	BAXGO, ID FIX	*24000	45000
BAXGO, ID FIX *18000 - GNSS MEA *DME/DME/IRU MEA	LAMON, ID FIX	*24000	45000
LAMON, ID FIX *18000 - GNSS MEA *DME/DME/IRU MEA	GANNE, WY WP	*24000	45000
GANNE, WY WP *18000 - GNSS MEA *DME/DME/IRU MEA	DDRTH, WY WP	*24000	45000
DDRTH, WY WP *18000 - GNSS MEA *DME/DME/IRU MEA	YAMPA, CO WP	*24000	45000
YAMPA, CO WP *18000 - GNSS MEA *DME/DME/IRU MEA	BBULL, CO WP	*24000	45000
BBULL, CO WP *18000 - GNSS MEA *DME/DME/IRU MEA	DUUZE, KS WP	*24000	45000
DUUZE, KS WP *18000 - GNSS MEA *DME/DME/IRU MEA	EXHAS, KS WP	*24000	45000
<b>95.4152 RNAV ROUTE Q152</b>			
SUNED, WA FIX *18000 - GNSS MEA *DME/DME/IRU MEA	LEZLE, WA FIX	*24000	45000
LEZLE, WA FIX *18000 - GNSS MEA *DME/DME/IRU MEA	WEDAK, MT FIX	*24000	45000

FROM	TO	MEA	MAA
<b>95.4152 RNAV ROUTE Q152 - CONTINUED</b>			
WEDAK, MT FIX *18000 - GNSS MEA *DME/DME/IRU MEA	IKFOM, WY WP	*24000	45000
IKFOM, WY WP *18000 - GNSS MEA *DME/DME/IRU MEA	WUVUT, WY FIX	*24000	45000
WUVUT, WY FIX *18000 - GNSS MEA *DME/DME/IRU MEA	O'NEILL, NE VORTAC	*24000	45000
<b>95.4154 RNAV ROUTE Q154</b>			
WANTA, WA FIX *18000 - GNSS MEA *DME/DME/IRU MEA	JELTI, OR FIX	*24000	45000
JELTI, OR FIX *18000 - GNSS MEA *DME/DME/IRU MEA	HOVEL, ID FIX	*24000	45000
HOVEL, ID FIX *18000 - GNSS MEA *DME/DME/IRU MEA	VELUY, ID WP	*24000	45000
VELUY, ID WP *18000 - GNSS MEA *DME/DME/IRU MEA	BURLEY, ID VOR/DME	*24000	45000
BURLEY, ID VOR/DME *18000 - GNSS MEA *DME/DME/IRU MEA	PIMIE, UT FIX	*24000	45000
PIMIE, UT FIX *18000 - GNSS MEA *DME/DME/IRU MEA	NAGNE, UT FIX	*24000	45000
NAGNE, UT FIX *18000 - GNSS MEA *DME/DME/IRU MEA	BONGO, UT FIX	*24000	45000
BONGO, UT FIX *18000 - GNSS MEA *DME/DME/IRU MEA	PITMN, CO FIX	*24000	45000
PITMN, CO FIX *18000 - GNSS MEA *DME/DME/IRU MEA	TAYLR, CO FIX	*24000	45000
TAYLR, CO FIX *18000 - GNSS MEA *DME/DME/IRU MEA	GOSIP, CO FIX	*24000	45000
GOSIP, CO FIX *18000 - GNSS MEA *DME/DME/IRU MEA	KENTO, NM FIX	*24000	45000
KENTO, NM FIX *18000 - GNSS MEA *DME/DME/IRU MEA	NOSEW, TX WP	*24000	45000
NOSEW, TX WP *18000 - GNSS MEA *DME/DME/IRU MEA	BOWIE, TX VORTAC	*24000	45000
<b>95.4156 RNAV ROUTE Q156</b>			
STEVS, WA WP *18000 - GNSS MEA *DME/DME/IRU MEA	ZAXUL, WA FIX	*18000	45000
ZAXUL, WA FIX *18000 - GNSS MEA *DME/DME/IRU MEA	FINUT, WA WP	*24000	45000

FROM	TO	MEA	MAA
<b>95.4156 RNAV ROUTE Q156 - CONTINUED</b>			
FINUT, WA WP *18000 - GNSS MEA *DME/DME/IRU MEA	TUFFY, MT FIX	*24000	45000
TUFFY, MT FIX *18000 - GNSS MEA *DME/DME/IRU MEA	UPUGE, MT FIX	*24000	45000
UPUGE, MT FIX *18000 - GNSS MEA *DME/DME/IRU MEA	HEXOL, MT FIX	*24000	45000
HEXOL, MT FIX *18000 - GNSS MEA *DME/DME/IRU MEA	SWTHN, MT WP	*24000	45000
SWTHN, MT WP *18000 - GNSS MEA *DME/DME/IRU MEA	JELRO, SD FIX	*28000	45000
JELRO, SD FIX *18000 - GNSS MEA *DME/DME/IRU MEA	KEKPE, SD WP	*28000	45000
KEKPE, SD WP *18000 - GNSS MEA *DME/DME/IRU MEA	UFFDA, MN WP	*28000	45000
UFFDA, MN WP *18000 - GNSS MEA *DME/DME/IRU MEA	HSTIN, MN WP	*28000	45000
HSTIN, MN WP *18000 - GNSS MEA *DME/DME/IRU MEA	ZZIPR, IA WP	*18000	45000

**95.4158 RNAV ROUTE Q158**

NTELL, CA WP *18000 - GNSS MEA *DME/DME/IRU MEA	PPARK, CA WP	*24000	45000
PPARK, CA WP *18000 - GNSS MEA *DME/DME/IRU MEA	TRTIS, CA WP	*24000	45000
TRTIS, CA WP *18000 - GNSS MEA *DME/DME/IRU MEA	BIKKR, CA WP	*24000	45000
BIKKR, CA WP *18000 - GNSS MEA *DME/DME/IRU MEA	MYCAL, NV WP	*24000	45000
MYCAL, NV WP *18000 - GNSS MEA *DME/DME/IRU MEA	JEDNA, NV WP	*24000	45000

**95.4160 RNAV ROUTE Q160**

SHVVR, CA WP *18000 - GNSS MEA *DME/DME/IRU MEA	FAANG, CA FIX	*36000	45000
FAANG, CA FIX *18000 - GNSS MEA *DME/DME/IRU MEA	RIVVO, CA WP	*36000	45000
RIVVO, CA WP *18000 - GNSS MEA *DME/DME/IRU MEA	BIKKR, CA WP	*25000	45000

**95.4164 RNAV ROUTE Q164**

NTELL, CA WP *18000 - GNSS MEA *DME/DME/IRU MEA	CABAB, CA WP	*24000	45000
---	--------------	--------	-------

FROM	TO	MEA	MAA
<b>95.4164 RNAV ROUTE Q164 - CONTINUED</b>			
CABAB, CA WP *18000 - GNSS MEA *DME/DME/IRU MEA	KICHI, NV WP	*26000	45000
KICHI, NV WP *18000 - GNSS MEA *DME/DME/IRU MEA	KATTS, NV WP	*26000	45000
KATTS, NV WP *18000 - GNSS MEA *DME/DME/IRU MEA	KITTN, NV WP	*27000	45000
KITTN, NV WP *18000 - GNSS MEA *DME/DME/IRU MEA	ROCCY, UT WP	*27000	45000
<b>95.4167 RNAV ROUTE Q167</b>			
ZJAAY, MD WP *18000 - GNSS MEA *DME/DME/IRU MEA	PAJET, DE WP	*18000	45000
PAJET, DE WP *18000 - GNSS MEA *DME/DME/IRU MEA	CAANO, DE WP	*18000	45000
CAANO, DE WP *18000 - GNSS MEA *DME/DME/IRU MEA	TBONN, OA WP	*18000	45000
TBONN, OA WP *18000 - GNSS MEA *DME/DME/IRU MEA	ZIZZI, NJ FIX	*18000	45000
ZIZZI, NJ FIX *18000 - GNSS MEA *DME/DME/IRU MEA	YAZUU, NJ FIX	*18000	45000
YAZUU, NJ FIX *18000 - GNSS MEA *DME/DME/IRU MEA	TOPRR, OA WP	*18000	45000
TOPRR, OA WP *18000 - GNSS MEA *DME/DME/IRU MEA	EMJAY, NJ FIX	*18000	45000
EMJAY, NJ FIX *18000 - GNSS MEA *DME/DME/IRU MEA	SPDEY, OA WP	*18000	45000
SPDEY, OA WP *18000 - GNSS MEA *DME/DME/IRU MEA	RIFLE, NY FIX	*18000	45000
RIFLE, NY FIX *18000 - GNSS MEA *DME/DME/IRU MEA	HOFFI, NY FIX	*18000	45000
HOFFI, NY FIX *18000 - GNSS MEA *DME/DME/IRU MEA	ORCHA, NY WP	*18000	45000
ORCHA, NY WP *18000 - GNSS MEA *DME/DME/IRU MEA	ALBOW, NY WP	*18000	45000
ALBOW, NY WP *18000 - GNSS MEA *DME/DME/IRU MEA	GRONC, NY WP	*18000	45000
GRONC, NY WP *18000 - GNSS MEA *DME/DME/IRU MEA	NESTT, RI WP	*18000	45000
NESTT, RI WP *18000 - GNSS MEA *DME/DME/IRU MEA	BUZRD, MA WP	*18000	45000

FROM	TO	MEA	MAA
------	----	-----	-----

**95.4167 RNAV ROUTE Q167 - CONTINUED**

BUZRD, MA WP *18000 - GNSS MEA *DME/DME/IRU MEA	SSOXS, MA FIX	*18000	45000
---	---------------	--------	-------

**95.4168 RNAV ROUTE Q168**

FNDA, CA WP *18000 - GNSS MEA *DME/DME/IRU MEA	SHIVA, AZ WP	*21000	45000
SHIVA, AZ WP *18000 - GNSS MEA *DME/DME/IRU MEA	KRINA, AZ WP	*21000	45000
KRINA, AZ WP *18000 - GNSS MEA *DME/DME/IRU MEA	JASSE, AZ WP	*21000	45000

**95.4172 RNAV ROUTE Q172**

YUTEE, SC WP *18000 - GNSS MEA *DME/DME/IRU MEA	BWAGS, SC WP	*18000	45000
BWAGS, SC WP *18000 - GNSS MEA *DME/DME/IRU MEA	HINTZ, SC WP	*18000	45000
HINTZ, SC WP *18000 - GNSS MEA *DME/DME/IRU MEA	CEELY, SC WP	*18000	45000
CEELY, SC WP *18000 - GNSS MEA *DME/DME/IRU MEA	OKNEE, SC WP	*18000	45000
OKNEE, SC WP *18000 - GNSS MEA *DME/DME/IRU MEA	KAATT, NC WP	*18000	45000
KAATT, NC WP *18000 - GNSS MEA *DME/DME/IRU MEA	RAPZZ, NC WP	*18000	45000

**95.4174 RNAV ROUTE Q174**

NTELL, CA WP *18000 - GNSS MEA *DME/DME/IRU MEA	CABAB, CA WP	*24000	45000
CABAB, CA WP *18000 - GNSS MEA *DME/DME/IRU MEA	TTMSN, CA WP	*24000	45000
TTMSN, CA WP *18000 - GNSS MEA *DME/DME/IRU MEA	SKANN, NV WP	*24000	45000
SKANN, NV WP *18000 - GNSS MEA *DME/DME/IRU MEA	FLCHR, NV WP	*24000	45000

**95.4176 RNAV ROUTE Q176**

CIMARRON, NM VORTAC *18000 - GNSS MEA *DME/DME/IRU MEA	KENTO, NM FIX	*22000	45000
KENTO, NM FIX *18000 - GNSS MEA *DME/DME/IRU MEA	TOTOE, KS WP	*22000	45000

FROM	TO	MEA	MAA
<b>95.4176 RNAV ROUTE Q176 - CONTINUED</b>			
TOTOE, KS WP *18000 - GNSS MEA *DME/DME/IRU MEA	WRIGL, KS WP	*22000	45000
WRIGL, KS WP *18000 - GNSS MEA *DME/DME/IRU MEA	BUTLER, MO VORTAC	*18000	45000
BUTLER, MO VORTAC *18000 - GNSS MEA *DME/DME/IRU MEA	ST LOUIS, MO VORTAC	*18000	45000
ST LOUIS, MO VORTAC *18000 - GNSS MEA *DME/DME/IRU MEA	GBEES, IN FIX	*18000	45000
GBEES, IN FIX *18000 - GNSS MEA *DME/DME/IRU MEA	BICKS, KY WP	*18000	45000
BICKS, KY WP *18000 - GNSS MEA *DME/DME/IRU MEA	HENDERSON, WV DME	*18000	45000
HENDERSON, WV DME *18000 - GNSS MEA *DME/DME/IRU MEA	OTTTO, VA WP	*18000	45000
<b>95.4184 RNAV ROUTE Q184</b>			
RANGER, TX VORTAC *18000 - GNSS MEA *DME/DME/IRU MEA	DOBIS, LA WP	*18000	45000
DOBIS, LA WP *18000 - GNSS MEA *DME/DME/IRU MEA	BERKE, LA FIX	*18000	45000
BERKE, LA FIX *18000 - GNSS MEA *DME/DME/IRU MEA	MIXIE, LA FIX	*18000	45000
MIXIE, LA FIX *18000 - GNSS MEA *DME/DME/IRU MEA	STAGE, LA FIX	*18000	45000
STAGE, LA FIX *18000 - GNSS MEA *DME/DME/IRU MEA	KAMEN, LA FIX	*18000	45000
KAMEN, LA FIX *18000 - GNSS MEA *DME/DME/IRU MEA	SARKK, MS WP	*18000	45000
SARKK, MS WP *18000 - GNSS MEA *DME/DME/IRU MEA	MERDN, MS WP	*18000	45000
MERDN, MS WP *18000 - GNSS MEA *DME/DME/IRU MEA	KWANE, MS WP	*18000	45000
KWANE, MS WP *18000 - GNSS MEA *DME/DME/IRU MEA	ARNNY, AL WP	*18000	45000
<b>95.4220 RNAV ROUTE Q220</b>			
RIFLE, NY FIX *18000 - GNSS MEA *DME/DME/IRU MEA	HOFFI, NY FIX	*18000	45000
HOFFI, NY FIX *18000 - GNSS MEA *DME/DME/IRU MEA	ORCHA, NY WP	*18000	45000



FROM	TO	MEA	MAA
<b>95.4220 RNAV ROUTE Q220 - CONTINUED</b>			
ORCHA, NY WP *18000 - GNSS MEA *DME/DME/IRU MEA	ALBOW, NY WP	*18000	45000
ALBOW, NY WP *18000 - GNSS MEA *DME/DME/IRU MEA	SANDY POINT, RI VOR/DME	*18000	45000
SANDY POINT, RI VOR/DME *18000 - GNSS MEA *DME/DME/IRU MEA	SKOWL, RI WP	*18000	45000
SKOWL, RI WP *18000 - GNSS MEA *DME/DME/IRU MEA	JAWZZ, MA WP	*18000	45000
JAWZZ, MA WP *18000 - GNSS MEA *DME/DME/IRU MEA	LARIE, MA WP	*18000	45000
<b>95.4406 RNAV ROUTE Q406</b>			
BROADWAY, NJ VOR/DME *18000 - GNSS MEA *DME/DME/IRU MEA	DBABE, NY WP	*18000	45000
DBABE, NY WP *18000 - GNSS MEA *DME/DME/IRU MEA	BASYE, NY FIX	*18000	45000
BASYE, NY FIX *18000 - GNSS MEA *DME/DME/IRU MEA	TRIBS, CT WP	*18000	45000
TRIBS, CT WP *18000 - GNSS MEA *DME/DME/IRU MEA	BIGGO, CT FIX	*18000	45000
BIGGO, CT FIX *18000 - GNSS MEA *DME/DME/IRU MEA	BARNES, MA VORTAC	*18000	45000
<b>95.4409 RNAV ROUTE Q409</b>			
ENEME, GA WP *18000 - GNSS MEA *DME/DME/IRU MEA	PUPYY, GA WP	*18000	45000
PUPYY, GA WP *18000 - GNSS MEA *DME/DME/IRU MEA	ISUZO, GA WP	*18000	45000
ISUZO, GA WP *18000 - GNSS MEA *DME/DME/IRU MEA	KONEY, SC WP	*18000	45000
KONEY, SC WP *18000 - GNSS MEA *DME/DME/IRU MEA	JROSS, SC WP	*18000	45000
JROSS, SC WP *18000 - GNSS MEA *DME/DME/IRU MEA	SESUE, SC WP	*18000	45000
SESUE, SC WP *18000 - GNSS MEA *DME/DME/IRU MEA	OKNEE, SC WP	*18000	45000
OKNEE, SC WP *18000 - GNSS MEA *DME/DME/IRU MEA	MRPIT, NC WP	*18000	45000
MRPIT, NC WP *18000 - GNSS MEA *DME/DME/IRU MEA	DEEEZ, NC WP	*18000	45000

FROM	TO	MEA	MAA
<b>95.4409 RNAV ROUTE Q409 - CONTINUED</b>			
DEEEZ, NC WP *18000 - GNSS MEA *DME/DME/IRU MEA	GUILD, NC WP	*18000	45000
GUILD, NC WP *18000 - GNSS MEA *DME/DME/IRU MEA	CRPLR, VA WP	*18000	45000
CRPLR, VA WP *18000 - GNSS MEA *DME/DME/IRU MEA	TRPOD, MD WP	*18000	45000
TRPOD, MD WP *18000 - GNSS MEA *DME/DME/IRU MEA	GNARO, DE WP	*18000	45000
GNARO, DE WP *18000 - GNSS MEA *DME/DME/IRU MEA	VILLS, NJ FIX	*18000	45000
VILLS, NJ FIX *18000 - GNSS MEA *DME/DME/IRU MEA	COYLE, NJ VORTAC	*18000	45000
COYLE, NJ VORTAC *18000 - GNSS MEA *DME/DME/IRU MEA	WHITE, NJ FIX	*18000	45000
<b>95.4419 RNAV ROUTE Q419</b>			
BROSS, MD FIX *18000 - GNSS MEA *DME/DME/IRU MEA	MYFOO, DE WP	*18000	45000
MYFOO, DE WP *18000 - GNSS MEA *DME/DME/IRU MEA	NACYN, NJ WP	*18000	45000
NACYN, NJ WP *18000 - GNSS MEA *DME/DME/IRU MEA	BSERK, NJ WP	*18000	45000
BSERK, NJ WP *18000 - GNSS MEA *DME/DME/IRU MEA	HULKK, NJ WP	*18000	45000
HULKK, NJ WP *18000 - GNSS MEA *DME/DME/IRU MEA	ROBBINSVILLE, NJ VORTAC	*18000	45000
ROBBINSVILLE, NJ VORTAC *18000 - GNSS MEA *DME/DME/IRU MEA	LAURN, NY WP	*18000	45000
LAURN, NY WP *18000 - GNSS MEA *DME/DME/IRU MEA	KENNEDY, NY VOR/DME	*18000	45000
KENNEDY, NY VOR/DME *18000 - GNSS MEA *DME/DME/IRU MEA	DEER PARK, NY VOR/DME	*18000	45000
<b>95.4430 RNAV ROUTE Q430</b>			
ZANDR, OH FIX *18000 - GNSS MEA *DME/DME/IRU MEA	BELLAIRE, OH VOR/DME	*18000	45000
BELLAIRE, OH VOR/DME *18000 - GNSS MEA *DME/DME/IRU MEA	LEJOY, PA FIX	*18000	45000
LEJOY, PA FIX *18000 - GNSS MEA *DME/DME/IRU MEA	VINSE, PA FIX	*18000	45000

FROM	TO	MEA	MAA
<b>95.4430 RNAV ROUTE Q430 - CONTINUED</b>			
VINSE, PA FIX *18000 - GNSS MEA *DME/DME/IRU MEA	BEETS, PA FIX	*18000	45000
BEETS, PA FIX *18000 - GNSS MEA *DME/DME/IRU MEA	LARRI, PA FIX	*18000	45000
LARRI, PA FIX *18000 - GNSS MEA *DME/DME/IRU MEA	SAAME, PA FIX	*18000	45000
SAAME, PA FIX *18000 - GNSS MEA *DME/DME/IRU MEA	BYRDD, PA FIX	*18000	45000
BYRDD, PA FIX *18000 - GNSS MEA *DME/DME/IRU MEA	COPEES, PA FIX	*18000	45000
COPEES, PA FIX *18000 - GNSS MEA *DME/DME/IRU MEA	ROBBINSVILLE, NJ VORTAC	*18000	45000
ROBBINSVILLE, NJ VORTAC *18000 - GNSS MEA *DME/DME/IRU MEA	MYRCA, NJ WP	*18000	45000
MYRCA, NJ WP *18000 - GNSS MEA *DME/DME/IRU MEA	CREEL, NY FIX	*18000	45000
CREEL, NY FIX *18000 - GNSS MEA *DME/DME/IRU MEA	RIFLE, NY FIX	*18000	45000
RIFLE, NY FIX *18000 - GNSS MEA *DME/DME/IRU MEA	KYSKY, NY WP	*18000	45000
KYSKY, NY WP *18000 - GNSS MEA *DME/DME/IRU MEA	LIBBE, NY FIX	*18000	45000
LIBBE, NY FIX *18000 - GNSS MEA *DME/DME/IRU MEA	FLAPE, MA FIX	*18000	45000
FLAPE, MA FIX *18000 - GNSS MEA *DME/DME/IRU MEA	DEEPO, MA FIX	*18000	45000
DEEPO, MA FIX *18000 - GNSS MEA *DME/DME/IRU MEA	NANTUCKET, MA VOR/DME	*18000	45000

**95.4436 RNAV ROUTE Q436**

EMMMA, MI FIX *18000 - GNSS MEA *DME/DME/IRU MEA	DIXSN, MI WP	*18000	45000
DIXSN, MI WP *18000 - GNSS MEA *DME/DME/IRU MEA	BOOTT, MI WP	*18000	45000
BOOTT, MI WP *18000 - GNSS MEA *DME/DME/IRU MEA	RRONS, MI WP	*18000	45000
RRONS, MI WP *18000 - GNSS MEA *DME/DME/IRU MEA	U.S. CANADIAN BORDER	*18000	45000
U.S. CANADIAN BORDER *18000 - GNSS MEA *DME/DME/IRU MEA	RAAKK, NY WP	*18000	45000

FROM	TO	MEA	MAA
<b>95.4436 RNAV ROUTE Q436 - CONTINUED</b>			
RAAKK, NY WP *18000 - GNSS MEA *DME/DME/IRU MEA	HERBA, NY WP	*18000	45000
HERBA, NY WP *18000 - GNSS MEA *DME/DME/IRU MEA	REXXY, NY WP	*18000	45000
REXXY, NY WP *18000 - GNSS MEA *DME/DME/IRU MEA	REBBL, PA FIX	*18000	45000
REBBL, PA FIX *18000 - GNSS MEA *DME/DME/IRU MEA	MTCAF, PA WP	*18000	45000
MTCAF, PA WP *18000 - GNSS MEA *DME/DME/IRU MEA	DGRAF, PA FIX	*18000	45000
DGRAF, PA FIX *18000 - GNSS MEA *DME/DME/IRU MEA	YYOST, PA WP	*18000	45000
YYOST, PA WP *18000 - GNSS MEA *DME/DME/IRU MEA	LAAYK, PA FIX	*18000	45000
LAAYK, PA FIX *18000 - GNSS MEA *DME/DME/IRU MEA	COATE, NJ FIX	*18000	45000

**95.4437 RNAV ROUTE Q437**

VILLS, NJ FIX *18000 - GNSS MEA *DME/DME/IRU MEA	DITCH, NJ FIX	*18000	45000
DITCH, NJ FIX *18000 - GNSS MEA *DME/DME/IRU MEA	LUIGI, NJ WP	*18000	45000
LUIGI, NJ WP *18000 - GNSS MEA *DME/DME/IRU MEA	HNNAH, NJ WP	*18000	45000
HNNAH, NJ WP *18000 - GNSS MEA *DME/DME/IRU MEA	LLUND, NY FIX	*18000	45000
LLUND, NY FIX *18000 - GNSS MEA *DME/DME/IRU MEA	BIZEX, NY WP	*18000	45000
BIZEX, NY WP *18000 - GNSS MEA *DME/DME/IRU MEA	BINGS, NY WP	*18000	45000
BINGS, NY WP *18000 - GNSS MEA *DME/DME/IRU MEA	WARUV, NY WP	*18000	45000
WARUV, NY WP *18000 - GNSS MEA *DME/DME/IRU MEA	SLANG, VT WP	*18000	45000

**95.4438 RNAV ROUTE Q438**

RUBYY, MI WP *18000 - GNSS MEA *DME/DME/IRU MEA	BERYS, MI WP	*18000	45000
BERYS, MI WP *18000 - GNSS MEA *DME/DME/IRU MEA	TWIGS, MI WP	*18000	45000

FROM	TO	MEA	MAA
<b>95.4438 RNAV ROUTE Q438 - CONTINUED</b>			
TWIGS, MI WP *18000 - GNSS MEA *DME/DME/IRU MEA	U.S. CANADIAN BORDER	*18000	45000
U.S. CANADIAN BORDER *18000 - GNSS MEA *DME/DME/IRU MEA	RAAKK, NY WP	*18000	45000
<b>95.4439 RNAV ROUTE Q439</b>			
BRIGS, NJ FIX *18000 - GNSS MEA *DME/DME/IRU MEA	DRIFT, NJ FIX	*18000	45000
DRIFT, NJ FIX *18000 - GNSS MEA *DME/DME/IRU MEA	MANTA, NJ FIX	*18000	45000
MANTA, NJ FIX *18000 - GNSS MEA *DME/DME/IRU MEA	PLUME, NJ FIX	*18000	45000
PLUME, NJ FIX *18000 - GNSS MEA *DME/DME/IRU MEA	SHERL, NY FIX	*18000	45000
SHERL, NY FIX *18000 - GNSS MEA *DME/DME/IRU MEA	DUNEE, NY FIX	*18000	45000
DUNEE, NY FIX *18000 - GNSS MEA *DME/DME/IRU MEA	SARDI, NY FIX	*18000	45000
SARDI, NY FIX *18000 - GNSS MEA *DME/DME/IRU MEA	RIFLE, NY FIX	*18000	45000
RIFLE, NY FIX *18000 - GNSS MEA *DME/DME/IRU MEA	FOXWD, CT WP	*18000	45000
FOXWD, CT WP *18000 - GNSS MEA *DME/DME/IRU MEA	BOGRT, MA WP	*18000	45000
BOGRT, MA WP *18000 - GNSS MEA *DME/DME/IRU MEA	BLENO, NH WP	*18000	45000
BLENO, NH WP *18000 - GNSS MEA *DME/DME/IRU MEA	BEEKN, ME WP	*18000	45000
BEEKN, ME WP *18000 - GNSS MEA *DME/DME/IRU MEA	FRIAR, ME FIX	*18000	45000
FRIAR, ME FIX *GNSS REQUIRED	PRESQUE ISLE, ME VOR/DME	*18000	45000
<b>95.4440 RNAV ROUTE Q440</b>			
HUFFR, MN WP *18000 - GNSS MEA *DME/DME/IRU MEA	IDIOM, WI WP	*18000	45000
IDIOM, WI WP *18000 - GNSS MEA *DME/DME/IRU MEA	DEANI, MI WP	*18000	45000
DEANI, MI WP *18000 - GNSS MEA *DME/DME/IRU MEA	SLLAP, MI WP	*18000	45000

FROM	TO	MEA	MAA
<b>95.4440 RNAV ROUTE Q440 - CONTINUED</b>			
SLLAP, MI WP *18000 - GNSS MEA *DME/DME/IRU MEA	BERYS, MI WP	*18000	45000
BERYS, MI WP *18000 - GNSS MEA *DME/DME/IRU MEA	TWIGS, MI WP	*18000	45000
TWIGS, MI WP *18000 - GNSS MEA *DME/DME/IRU MEA	U.S. CANADIAN BORDER	*18000	45000
U.S. CANADIAN BORDER *18000 - GNSS MEA *DME/DME/IRU MEA	RAAKK, NY WP	*18000	45000
<b>95.4445 RNAV ROUTE Q445</b>			
PAACK, NC WP *18000 - GNSS MEA *DME/DME/IRU MEA	JAMIE, VA FIX	*18000	45000
JAMIE, VA FIX *18000 - GNSS MEA *DME/DME/IRU MEA	CONFR, MD WP	*18000	45000
CONFR, MD WP *18000 - GNSS MEA *DME/DME/IRU MEA	RADDS, DE FIX	*18000	45000
RADDS, DE FIX *18000 - GNSS MEA *DME/DME/IRU MEA	WNSTN, NJ WP	*18000	45000
WNSTN, NJ WP *18000 - GNSS MEA *DME/DME/IRU MEA	AVALO, NJ FIX	*18000	45000
AVALO, NJ FIX *18000 - GNSS MEA *DME/DME/IRU MEA	BRIGS, NJ FIX	*18000	45000
BRIGS, NJ FIX *18000 - GNSS MEA *DME/DME/IRU MEA	SHAUP, OA WP	*18000	45000
SHAUP, OA WP *18000 - GNSS MEA *DME/DME/IRU MEA	VALCO, OA WP	*18000	45000
VALCO, OA WP *18000 - GNSS MEA *DME/DME/IRU MEA	KYSKY, NY WP	*18000	45000
<b>95.4448 RNAV ROUTE Q448</b>			
POTTSTOWN, PA VORTAC *18000 - GNSS MEA *DME/DME/IRU MEA	LANNA, NJ FIX	*18000	45000
LANNA, NJ FIX *18000 - GNSS MEA *DME/DME/IRU MEA	DBABE, NY WP	*18000	45000
DBABE, NY WP *18000 - GNSS MEA *DME/DME/IRU MEA	BASYE, NY FIX	*18000	45000
BASYE, NY FIX *18000 - GNSS MEA *DME/DME/IRU MEA	TRIBS, CT WP	*18000	45000
TRIBS, CT WP *18000 - GNSS MEA *DME/DME/IRU MEA	BIGGO, CT FIX	*18000	45000

FROM	TO	MEA	MAA
<b>95.4448 RNAV ROUTE Q448 - CONTINUED</b>			
BIGGO, CT FIX *18000 - GNSS MEA *DME/DME/IRU MEA	BARNES, MA VORTAC	*18000	45000
<b>95.4450 RNAV ROUTE Q450</b>			
HNNAH, NJ WP *18000 - GNSS MEA *DME/DME/IRU MEA	KENNEDY, NY VOR/DME	*18000	45000
KENNEDY, NY VOR/DME *18000 - GNSS MEA *DME/DME/IRU MEA	DEER PARK, NY VOR/DME	*18000	45000
<b>95.4475 RNAV ROUTE Q475</b>			
COPLY, MA WP *18000 - GNSS MEA *DME/DME/IRU MEA	SCUPP, OA FIX	*18000	45000
SCUPP, OA FIX *18000 - GNSS MEA *DME/DME/IRU MEA	CANAL, OA WP	*18000	45000
CANAL, OA WP *GNSS REQUIRED	U.S. CANADIAN BORDER	*18000	45000
<b>95.4480 RNAV ROUTE Q480</b>			
ZANDR, OH FIX *18000 - GNSS MEA *DME/DME/IRU MEA	BELLAIRE, OH VOR/DME	*18000	45000
BELLAIRE, OH VOR/DME *18000 - GNSS MEA *DME/DME/IRU MEA	LEJOY, PA FIX	*18000	45000
LEJOY, PA FIX *18000 - GNSS MEA *DME/DME/IRU MEA	VINSE, PA FIX	*18000	45000
VINSE, PA FIX *18000 - GNSS MEA *DME/DME/IRU MEA	BEETS, PA FIX	*18000	45000
BEETS, PA FIX *18000 - GNSS MEA *DME/DME/IRU MEA	HOTEE, PA WP	*18000	45000
HOTEE, PA WP *18000 - GNSS MEA *DME/DME/IRU MEA	MIKYG, PA WP	*18000	45000
MIKYG, PA WP *18000 - GNSS MEA *DME/DME/IRU MEA	SPOTZ, PA WP	*18000	45000
SPOTZ, PA WP *18000 - GNSS MEA *DME/DME/IRU MEA	CANDR, NJ FIX	*18000	45000
CANDR, NJ FIX *18000 - GNSS MEA *DME/DME/IRU MEA	JEFFF, NJ FIX	*18000	45000
JEFFF, NJ FIX *18000 - GNSS MEA *DME/DME/IRU MEA	KINGSTON, NY VOR/DME	*18000	45000
KINGSTON, NY VOR/DME *18000 - GNSS MEA *DME/DME/IRU MEA	LESWL, CT WP	*18000	45000

FROM	TO	MEA	MAA
<b>95.4480 RNAV ROUTE Q480 - CONTINUED</b>			
LESWL, CT WP *18000 - GNSS MEA *DME/DME/IRU MEA	BARNES, MA VORTAC	*18000	45000
BARNES, MA VORTAC *18000 - GNSS MEA *DME/DME/IRU MEA	KYLOH, NH WP	*18000	45000
KYLOH, NH WP *18000 - GNSS MEA *DME/DME/IRU MEA	BEEKN, ME WP	*18000	45000
BEEKN, ME WP *18000 - GNSS MEA *DME/DME/IRU MEA	KENNEBUNK, ME VOR/DME	*18000	45000
<b>95.4481 RNAV ROUTE Q481</b>			
CONFR, MD WP *18000 - GNSS MEA *DME/DME/IRU MEA	MGERK, DE WP	*18000	45000
MGERK, DE WP *18000 - GNSS MEA *DME/DME/IRU MEA	LEEAH, NJ FIX	*18000	45000
LEEAH, NJ FIX *18000 - GNSS MEA *DME/DME/IRU MEA	ZIGGI, NJ FIX	*18000	45000
ZIGGI, NJ FIX *18000 - GNSS MEA *DME/DME/IRU MEA	DEER PARK, NY VOR/DME	*18000	45000
<b>95.4806 RNAV ROUTE Q806</b>			
U.S. CANADIAN BORDER *18000 - GNSS MEA *DME/DME/IRU MEA	MILLINOCKET, ME VOR/DME	*18000	45000
MILLINOCKET, ME VOR/DME *18000 - GNSS MEA *DME/DME/IRU MEA	CANME, ME WP	*18000	45000
CANME, ME WP *18000 - GNSS MEA *DME/DME/IRU MEA	U.S. CANADIAN BORDER	*18000	45000
<b>95.4811 RNAV ROUTE Q811</b>			
DILLINGHAM, AK VOR/DME *GNSS REQUIRED	KOWOK, AK FIX	*18000	45000
KOWOK, AK FIX *GNSS REQUIRED	SAHOK, AK FIX	*18000	45000
SAHOK, AK FIX *GNSS REQUIRED	FAGIN, AK FIX	*18000	45000
FAGIN, AK FIX *GNSS REQUIRED	NONDA, AK FIX	*18000	45000
NONDA, AK FIX *GNSS REQUIRED	AMOTT, AK FIX	*18000	45000
AMOTT, AK FIX *GNSS REQUIRED	GASTO, AK FIX	*18000	45000
GASTO, AK FIX *GNSS REQUIRED	ANCHORAGE, AK VOR/DME	*18000	45000
ANCHORAGE, AK VOR/DME *GNSS REQUIRED	GULKANA, AK VOR/DME	*18000	45000
GULKANA, AK VOR/DME *GNSS REQUIRED	U.S. CANADIAN BORDER	*18000	45000



FROM	TO	MEA	MAA
<b>95.4812 RNAV ROUTE Q812</b>			
TIMMR, ND FIX *18000 - GNSS MEA *DME/DME/IRU MEA	WELOK, MN WP	*20000	45000
WELOK, MN WP *18000 - GNSS MEA *DME/DME/IRU MEA	CEWDA, WI WP	*20000	45000
CEWDA, WI WP *18000 - GNSS MEA *DME/DME/IRU MEA	ZOHAN, MI WP	*20000	45000
ZOHAN, MI WP *18000 - GNSS MEA *DME/DME/IRU MEA	U.S. CANADIAN BORDER	*20000	45000
U.S. CANADIAN BORDER *18000 - GNSS MEA *DME/DME/IRU MEA	KELTI, NY WP	*20000	45000
KELTI, NY WP *18000 - GNSS MEA *DME/DME/IRU MEA	AHPAH, NY WP	*20000	45000
AHPAH, NY WP *18000 - GNSS MEA *DME/DME/IRU MEA	GOATR, NY WP	*20000	45000
GOATR, NY WP *18000 - GNSS MEA *DME/DME/IRU MEA	SYRACUSE, NY VORTAC	*18000	45000
SYRACUSE, NY VORTAC *18000 - GNSS MEA *DME/DME/IRU MEA	FABEN, NY WP	*18000	45000
FABEN, NY WP *18000 - GNSS MEA *DME/DME/IRU MEA	LOXXE, NY FIX	*18000	45000
LOXXE, NY FIX *18000 - GNSS MEA *DME/DME/IRU MEA	ARRKK, NY WP	*18000	45000
ARRKK, NY WP *18000 - GNSS MEA *DME/DME/IRU MEA	STOMP, NY FIX	*18000	45000
STOMP, NY FIX *18000 - GNSS MEA *DME/DME/IRU MEA	MSLIN, NY FIX	*18000	45000
MSLIN, NY FIX *18000 - GNSS MEA *DME/DME/IRU MEA	GAYEL, NY FIX	*18000	45000
<b>95.4816 RNAV ROUTE Q816</b>			
HOCKE, MI WP *18000 - GNSS MEA *DME/DME/IRU MEA	U.S. CANADIAN BORDER	*18000	45000
U.S. CANADIAN BORDER *18000 - GNSS MEA *DME/DME/IRU MEA	KELTI, NY WP	*18000	45000
KELTI, NY WP *18000 - GNSS MEA *DME/DME/IRU MEA	AHPAH, NY WP	*18000	45000
AHPAH, NY WP *18000 - GNSS MEA *DME/DME/IRU MEA	GOATR, NY WP	*18000	45000
GOATR, NY WP *18000 - GNSS MEA *DME/DME/IRU MEA	ARNII, NY FIX	*18000	45000

FROM	TO	MEA	MAA
------	----	-----	-----

**95.4816 RNAV ROUTE Q816 - CONTINUED**

ARNII, NY FIX *18000 - GNSS MEA *DME/DME/IRU MEA	HANAA, NY WP	*18000	45000
--	--------------	--------	-------

**95.4818 RNAV ROUTE Q818**

FLINT, MI VORTAC *18000 - GNSS MEA *DME/DME/IRU MEA	U.S. CANADIAN BORDER	*18000	45000
U.S. CANADIAN BORDER *18000 - GNSS MEA *DME/DME/IRU MEA	WOZEE, NY WP	*18000	45000
WOZEE, NY WP *18000 - GNSS MEA *DME/DME/IRU MEA	KELIE, NY FIX	*18000	45000
KELIE, NY FIX *18000 - GNSS MEA *DME/DME/IRU MEA	VIEEW, NY FIX	*18000	45000
VIEEW, NY FIX *18000 - GNSS MEA *DME/DME/IRU MEA	BINGHAMTON, NY VOR/DME	*18000	45000
BINGHAMTON, NY VOR/DME *18000 - GNSS MEA *DME/DME/IRU MEA	BUFFY, PA FIX	*18000	45000
BUFFY, PA FIX *18000 - GNSS MEA *DME/DME/IRU MEA	STOMP, NY FIX	*18000	45000
STOMP, NY FIX *18000 - GNSS MEA *DME/DME/IRU MEA	MSLIN, NY FIX	*18000	45000
MSLIN, NY FIX *18000 - GNSS MEA *DME/DME/IRU MEA	GAYEL, NY FIX	*18000	45000

**95.4822 RNAV ROUTE Q822**

FLINT, MI VORTAC *18000 - GNSS MEA *DME/DME/IRU MEA	U.S. CANADIAN BORDER	*18000	45000
U.S. CANADIAN BORDER *18000 - GNSS MEA *DME/DME/IRU MEA	HOZIR, NY WP	*18000	45000
HOZIR, NY WP *18000 - GNSS MEA *DME/DME/IRU MEA	GONZZ, NY WP	*18000	45000
GONZZ, NY WP *18000 - GNSS MEA *DME/DME/IRU MEA	PUPPY, NY WP	*18000	45000
PUPPY, NY WP *18000 - GNSS MEA *DME/DME/IRU MEA	PAYGE, NY WP	*18000	45000
PAYGE, NY WP *18000 - GNSS MEA *DME/DME/IRU MEA	CAMBRIDGE, NY VOR/DME	*18000	45000
CAMBRIDGE, NY VOR/DME *18000 - GNSS MEA *DME/DME/IRU MEA	KENNEBUNK, ME VOR/DME	*18000	45000
KENNEBUNK, ME VOR/DME *18000 - GNSS MEA *DME/DME/IRU MEA	AJJAY, ME WP	*18000	45000

FROM	TO	MEA	MAA
<b>95.4822 RNAV ROUTE Q822 - CONTINUED</b>			
AJJAY, ME WP *18000 - GNSS MEA *DME/DME/IRU MEA	U.S. CANADIAN BORDER	*18000	45000
<b>95.4824 RNAV ROUTE Q824</b>			
FLINT, MI VORTAC *18000 - GNSS MEA *DME/DME/IRU MEA	HOCKE, MI WP	*18000	45000
HOCKE, MI WP *18000 - GNSS MEA *DME/DME/IRU MEA	U.S. CANADIAN BORDER	*18000	45000
<b>95.4842 RNAV ROUTE Q842</b>			
BEALE, NV FIX *GNSS REQUIRED	BLIPP, NV WP	*18000	45000
BLIPP, NV WP *GNSS REQUIRED	WINEN, UT WP	*18000	45000
WINEN, UT WP *GNSS REQUIRED	TABLL, UT WP	*18000	45000
TABLL, UT WP *GNSS REQUIRED	PICHO, UT WP	*18000	45000
PICHO, UT WP *GNSS REQUIRED	PATIO, UT WP	*18000	45000
PATIO, UT WP *GNSS REQUIRED	PROXI, UT WP	*18000	45000
PROXI, UT WP *GNSS REQUIRED	VAANE, MT WP	*18000	45000
VAANE, MT WP *GNSS REQUIRED	KEETA, MT WP	*18000	45000
KEETA, MT WP *GNSS REQUIRED	U.S. CANADIAN BORDER	*18000	45000
<b>95.4844 RNAV ROUTE Q844</b>			
SYRACUSE, NY VORTAC *18000 - GNSS MEA *DME/DME/IRU MEA	U.S. CANADIAN BORDER	*18000	45000
<b>95.4848 RNAV ROUTE Q848</b>			
SLLAP, MI WP *18000 - GNSS MEA *DME/DME/IRU MEA	HHIPP, MI WP	*18000	45000
HHIPP, MI WP *18000 - GNSS MEA *DME/DME/IRU MEA	U.S. CANADIAN BORDER	*18000	45000
<b>95.4864 RNAV ROUTE Q864</b>			
U.S. CANADIAN BORDER *GNSS REQUIRED	U.S. CANADIAN BORDER	*18000	45000
<b>95.4902 RNAV ROUTE Q902</b>			
SEATTLE, WA VORTAC *GNSS REQUIRED	ORCUS, WA FIX	*18000	45000
ORCUS, WA FIX *GNSS REQUIRED	U. S. CANADIAN BORDER	*18000	45000

FROM	TO	MEA	MAA
------	----	-----	-----

**95.4902 RNAV ROUTE Q902 - CONTINUED**

U. S. CANADIAN BORDER *GNSS REQUIRED	ANNETTE ISLAND, AK VOR/DME	*18000	45000
ANNETTE ISLAND, AK VOR/DME *GNSS REQUIRED	GESTI, AK FIX	*18000	45000
GESTI, AK FIX *GNSS REQUIRED	DOOZI, AK FIX	*18000	45000
DOOZI, AK FIX *GNSS REQUIRED	LEVEL ISLAND, AK VOR/DME	*18000	45000
LEVEL ISLAND, AK VOR/DME *GNSS REQUIRED	HOODS, AK FIX	*18000	45000
HOODS, AK FIX *GNSS REQUIRED	SISTERS ISLAND, AK VORTAC	*18000	45000
SISTERS ISLAND, AK VORTAC *GNSS REQUIRED	U. S. CANADIAN BORDER	*18000	45000
U. S. CANADIAN BORDER *GNSS REQUIRED	NORTHWAY, AK VORTAC	*18000	45000
NORTHWAY, AK VORTAC *GNSS REQUIRED	RDFLG, AK FIX	*18000	45000
RDFLG, AK FIX *GNSS REQUIRED	HRDNG, AK FIX	*18000	45000
HRDNG, AK FIX *GNSS REQUIRED	FAIRBANKS, AK VORTAC	*18000	45000
FAIRBANKS, AK VORTAC *GNSS REQUIRED	KOTZEBUE, AK VOR/DME	*18000	45000

**95.4905 RNAV ROUTE Q905**

HOCKE, MI WP *18000 - GNSS MEA *DME/DME/IRU MEA	U.S. CANADIAN BORDER	*18000	45000
---	----------------------	--------	-------

**95.4907 RNAV ROUTE Q907**

POSTS, MI WP *18000 - GNSS MEA *DME/DME/IRU MEA	PADDE, MI WP	*18000	45000
PADDE, MI WP *18000 - GNSS MEA *DME/DME/IRU MEA	SALEM, MI VORTAC	*18000	45000
SALEM, MI VORTAC *18000 - GNSS MEA *DME/DME/IRU MEA	U.S. CANADIAN BORDER	*18000	45000
U.S. CANADIAN BORDER *18000 - GNSS MEA *DME/DME/IRU MEA	U.S. CANADIAN BORDER	*18000	45000

**95.4913 RNAV ROUTE Q913**

U.S. CANADIAN BORDER *18000 - GNSS MEA *DME/DME/IRU MEA	CABCI, VT WP	*18000	45000
CABCI, VT WP *18000 - GNSS MEA *DME/DME/IRU MEA	TOPPS, ME FIX	*18000	45000

**95.4917 RNAV ROUTE Q917**

SAULT STE MARIE, MI VOR/DME *18000 - GNSS MEA *DME/DME/IRU MEA	U.S. CANADIAN BORDER	*18000	45000
--	----------------------	--------	-------

FROM	TO	MEA	MAA
<b>95.4917 RNAV ROUTE Q917 - CONTINUED</b>			
U.S. CANADIAN BORDER *18000 - GNSS MEA *DME/DME/IRU MEA	U.S. CANADIAN BORDER	*18000	45000
U.S. CANADIAN BORDER *18000 - GNSS MEA *DME/DME/IRU MEA	HOZIR, NY WP	*18000	45000
HOZIR, NY WP *18000 - GNSS MEA *DME/DME/IRU MEA	WOZEE, NY WP	*18000	45000
<b>95.4923 RNAV ROUTE Q923</b>			
HOCKE, MI WP *18000 - GNSS MEA *DME/DME/IRU MEA	U.S. CANADIAN BORDER	*18000	45000
<b>95.4935 RNAV ROUTE Q935</b>			
MONEE, MI FIX *18000 - GNSS MEA *DME/DME/IRU MEA	HOCKE, MI WP	*18000	45000
HOCKE, MI WP *18000 - GNSS MEA *DME/DME/IRU MEA	U.S. CANADIAN BORDER	*18000	45000
U.S. CANADIAN BORDER *18000 - GNSS MEA *DME/DME/IRU MEA	WOZEE, NY WP	*18000	45000
WOZEE, NY WP *18000 - GNSS MEA *DME/DME/IRU MEA	HANKK, NY WP	*18000	45000
HANKK, NY WP *18000 - GNSS MEA *DME/DME/IRU MEA	JOSSY, NY WP	*18000	45000
JOSSY, NY WP *18000 - GNSS MEA *DME/DME/IRU MEA	AUDIL, NY FIX	*18000	45000
AUDIL, NY FIX *18000 - GNSS MEA *DME/DME/IRU MEA	FABEN, NY WP	*18000	45000
FABEN, NY WP *18000 - GNSS MEA *DME/DME/IRU MEA	PONCT, NY WP	*18000	45000
PONCT, NY WP *18000 - GNSS MEA *DME/DME/IRU MEA	GARDNER, MA VOR/DME	*18000	45000
GARDNER, MA VOR/DME *18000 - GNSS MEA *DME/DME/IRU MEA	BOSTON, MA VOR/DME	*18000	45000
<b>95.4937 RNAV ROUTE Q937</b>			
U.S. CANADIAN BORDER *18000 - GNSS MEA *DME/DME/IRU MEA	WAYGO, NY WP	*18000	45000
WAYGO, NY WP *18000 - GNSS MEA *DME/DME/IRU MEA	KRAZZ, NY WP	*18000	45000
<b>95.4951 RNAV ROUTE Q951</b>			
POSTS, MI WP *18000 - GNSS MEA *DME/DME/IRU MEA	PADDE, MI WP	*18000	45000

FROM	TO	MEA	MAA
<b>95.4951 RNAV ROUTE Q951 - CONTINUED</b>			
PADDE, MI WP *18000 - GNSS MEA *DME/DME/IRU MEA	SALEM, MI VORTAC	*18000	45000
SALEM, MI VORTAC *18000 - GNSS MEA *DME/DME/IRU MEA	U.S. CANADIAN BORDER	*18000	45000
U.S. CANADIAN BORDER *18000 - GNSS MEA *DME/DME/IRU MEA	DAVDA, NY WP	*18000	45000
DAVDA, NY WP *18000 - GNSS MEA *DME/DME/IRU MEA	SAVAL, NY WP	*18000	45000
SAVAL, NY WP *18000 - GNSS MEA *DME/DME/IRU MEA	U.S. CANADIAN BORDER	*18000	45000
U.S. CANADIAN BORDER *18000 - GNSS MEA *DME/DME/IRU MEA	U.S. CANADIAN BORDER	*18000	45000
U.S. CANADIAN BORDER *18000 - GNSS MEA *DME/DME/IRU MEA	U.S. CANADIAN BORDER	*18000	45000

**§95.5000 GROUND-BASED HIGH ALTITUDE RNAV ROUTES**

<b>FROM/TO</b>	<b>TOTAL DISTANCE</b>	<b>CHANGEOVER DISTANCE</b>	<b>POINT FROM</b>	<b>TRACK ANGLE</b>	<b>MEA</b>	<b>MAA</b>
<b>J804R</b>						
ANCHORAGE, AK VOR/DME	60.0				18000	45000
NOWEL, AK RP				133/314 TO NOWEL		
NOWEL, AK RP	90.5				18000	45000
MIDDLETON ISLAND, AK VOR/DME				134/316 TO MIDDLETON ISLAND		
MIDDLETON ISLAND, AK VOR/DME	170.9	121	MIDDLETON ISLAND	095/275 TO COP	24000	45000
SNOUT, AK RP				120/300 TO SNOUT		
SNOUT, AK RP	196.9	197	SNOUT	096/276 TO COP	24000	45000
EEDEN, AK RP				125/305 TO EEDEN		
EEDEN, AK RP	153.9	112	EEDEN	102/282 TO COP	24000	45000
FRIED, AK RP				129/309 TO FRIED		
 <b>J889R</b>						
NOWEL, AK RP	75.0	10	NOWEL	112/294 TO COP	18000	45000
ARISE, AK RP				112/294 TO ARISE		
ARISE, AK RP	71.0			112/293 TO KONKS	18000	45000
KONKS, AK WP				293/113 TO KONKS		
KONKS, AK WP	116.0	40	KONKS	111/294 TO COP	18000	45000
LAIRE, AK RP				294/114 TO LAIRE		

FROM

TO

MEA

**§95.6001 VOR FEDERAL AIRWAYS****95.6001 VOR FEDERAL AIRWAY V1**

CRAIG, FL VORTAC *2100 - MOCA	STARY, GA FIX	*4000
STARY, GA FIX *1200 - MOCA	RUBYS, SC FIX	*11000
RUBYS, SC FIX *3000 - MRA **2300 - MOCA	*BASSO, SC FIX	**11000
BASSO, SC FIX CHARLESTON, SC VORTAC *6000 - MRA **2000 - GNSS MEA	CHARLESTON, SC VORTAC *KIMMY, SC FIX	2000 **5000
KIMMY, SC FIX *2100 - GNSS MEA	INLET, SC FIX	*5000
INLET, SC FIX  *2100 - GNSS MEA	GRAND STRAND, SC VORTAC NE BND SW BND	*2100 *5000
GRAND STRAND, SC VORTAC	ASHES, NC FIX NE BND SW BND	5000 2000
ASHES, NC FIX *2100 - MOCA	YOAST, NC FIX	*5000
YOAST, NC FIX *1700 - MOCA	WALLO, NC FIX	*7000
WALLO, NC FIX	KINSTON, NC VORTAC NE BND SW BND	*2000 *7000
*SEGMENT UNUSABLE EXCEPT FOR AIRCRAFT EQUIPPED WITH SUITABLE RNAV SYSTEM WITH GPS		
KINSTON, NC VORTAC	ZAGGY, NC FIX	UNUSABLE
ZAGGY, NC FIX *1500 - MOCA	COFIELD, NC VORTAC	*3000
COFIELD, NC VORTAC	DRONE, NC FIX	2000
DRONE, NC FIX *1600 - MOCA	NORFOLK, VA VORTAC	*2500
NORFOLK, VA VORTAC *1800 - MOCA	CAPE CHARLES, VA VORTAC	*2500
CAPE CHARLES, VA VORTAC	SALISBURY, MD VORTAC	2000
SALISBURY, MD VORTAC *1500 - MOCA *SALISBURY R-039 UNUSABLE BELOW 5000 MSL	WATERLOO, DE VOR/DME	*2000
WATERLOO, DE VOR/DME	COYLE, NJ VORTAC	1800
COYLE, NJ VORTAC *3800 - MCA DIXIE, NJ FIX , SW BND	*DIXIE, NJ FIX	3800
DIXIE, NJ FIX *1700 - MOCA	KENNEDY, NY VOR/DME	*2500
KENNEDY, NY VOR/DME	DEER PARK, NY VOR/DME	1800
DEER PARK, NY VOR/DME	MADISON, CT VOR/DME	2000
MADISON, CT VOR/DME	HARTFORD, CT VOR/DME	2500
HARTFORD, CT VOR/DME	DVANY, CT FIX	3000
DVANY, CT FIX *2500 - MOCA	GRAYM, MA FIX	*4000
GRAYM, MA FIX *2500 - MOCA *3000 - GNSS MEA	BOSTON, MA VOR/DME	*4000



FROM	TO	MEA
<b>95.6002 VOR FEDERAL AIRWAY V2</b>		
*SEATTLE, WA VORTAC	VAMPS, WA FIX	
	E BND	**8400
	W BND	**4000
*4300 - MCA SEATTLE, WA VORTAC , E BND		
**3100 - MOCA		
**5300 - GNSS MEA		
VAMPS, WA FIX	BANDR, WA FIX	
	E BND	*8400
	W BND	*7700
*7700 - GNSS MEA		
BANDR, WA FIX	*BEEZR, WA FIX	8400
*9000 - MRA		
BEEZR, WA FIX	ELLENSBURG, WA VOR/DME	*8000
*7200 - MOCA		
ELLENSBURG, WA VOR/DME	PLUSS, WA FIX	7000
PLUSS, WA FIX	MOSES LAKE, WA VOR/DME	4000
MOSES LAKE, WA VOR/DME	BATUM, WA FIX	4000
BATUM, WA FIX	SUBDY, WA FIX	5000
SUBDY, WA FIX	*SPOKANE, WA VORTAC	5000
*5200 - MCA SPOKANE, WA VORTAC , E BND		
SPOKANE, WA VORTAC	ROPES, WA FIX	7100
ROPES, WA FIX	MULLAN PASS, ID VOR/DME	9100
MULLAN PASS, ID VOR/DME	ALTON, MT FIX	9600
ALTON, MT FIX	MISSOULA, MT VOR/DME	
	SE BND	*9000
	NW BND	*9600
*8500 - MOCA		
MISSOULA, MT VOR/DME	HELENA, MT VORTAC	*13000
*10300 - MOCA		
HELENA, MT VORTAC	SWEDD, MT FIX	10000
SWEDD, MT FIX	CONNS, MT FIX	10800
CONNS, MT FIX	LIVINGSTON, MT VOR/DME	10000
LIVINGSTON, MT VOR/DME	REEPO, MT FIX	9700
REEPO, MT FIX	COLUS, MT FIX	
	W BND	9700
	E BND	7000
COLUS, MT FIX	BILLINGS, MT VORTAC	
	W BND	9700
	E BND	6400
BILLINGS, MT VORTAC	MILES CITY, MT VOR/DME	6000
MILES CITY, MT VOR/DME	DICKINSON, ND VORTAC	6000
DICKINSON, ND VORTAC	BISMARCK, ND VOR/DME	4600
BISMARCK, ND VOR/DME	JAMESTOWN, ND VOR/DME	4000
JAMESTOWN, ND VOR/DME	*CHAFE, ND FIX	3300
*6000 - MRA		
CHAFE, ND FIX	FARGO, ND VOR/DME	
	W BND	3300
	E BND	2700
FARGO, ND VOR/DME	ALEXANDRIA, MN VOR/DME	*3500
*3000 - MOCA		
ALEXANDRIA, MN VOR/DME	GOPHER, MN VORTAC	3400
GOPHER, MN VORTAC	PEGGS, MN FIX	3400
PEGGS, MN FIX	NODINE, MN VORTAC	3000

**95.6003 VOR FEDERAL AIRWAY V3**

KEY WEST, FL VORTAC	*BIPIN, FL FIX	**GNSS - 15000
*14500 - MCA BIPIN, FL FIX , W BND		
**KEY WEST R-082 UNUSABLE		

FROM TO MEA

**95.6003 VOR FEDERAL AIRWAY V3 - CONTINUED**

BIPIN, FL FIX	DROWN, FL FIX	GNSS - 3000
DROWN, FL FIX	MNATE, FL FIX	5000
MNATE, FL FIX	DOLPHIN, FL VORTAC	*5000
*2800 - MOCA		
DOLPHIN, FL VORTAC	FORT LAUDERDALE, FL VOR/DME	2100
FORT LAUDERDALE, FL VOR/DME	PALM BEACH, FL VORTAC	2000
PALM BEACH, FL VORTAC	TREASURE, FL VORTAC	*3000
*2100 - MOCA		
TREASURE, FL VORTAC	MELBOURNE, FL VOR/DME	2000
MELBOURNE, FL VOR/DME	MALET, FL FIX	2000
MALET, FL FIX	ORMOND BEACH, FL VORTAC	*4000
*1600 - MOCA		
ORMOND BEACH, FL VORTAC	*SEBAG, FL FIX	**2000
*3000 - MRA		
**1400 - MOCA		
SEBAG, FL FIX	BRUNSWICK, GA VORTAC	*2000
*1400 - MOCA		
BRUNSWICK, GA VORTAC	*BROUN, GA FIX	**3000
*11000 - MRA		
**2200 - MOCA		
BROUN, GA FIX	*HARPS, GA FIX	**3000
*3800 - MRA		
**2200 - MOCA		
HARPS, GA FIX	KELER, GA FIX	*3000
*2200 - MOCA		
KELER, GA FIX	SAVANNAH, GA VORTAC	*3000
*1900 - MOCA		
SAVANNAH, GA VORTAC	OWENS, SC FIX	*3000
*1500 - MOCA		
OWENS, SC FIX	*VANCE, SC VORTAC	2000
*13000 - MCA VANCE, SC VORTAC , NE BND		
VANCE, SC VORTAC	*FLORENCE, SC VORTAC	**13000
*12000 - MCA FLORENCE, SC VORTAC , SW BND		
**2000 - GNSS MEA		
**VANCE R-047 UNUSABLE, USE FLORENCE R-224		
FLORENCE, SC VORTAC	TOWEY, SC FIX	2000
TOWEY, SC FIX	SANDHILLS, NC VORTAC	*8000
*1900 - MOCA		
SANDHILLS, NC VORTAC	RALEIGH/DURHAM, NC VORTAC	2500
RALEIGH/DURHAM, NC VORTAC	HARVY, VA FIX	3000
HARVY, VA FIX	*NUTTS, VA FIX	**6000
*9000 - MRA		
**4000 - GNSS MEA		
NUTTS, VA FIX	FLAT ROCK, VA VORTAC	*6000
*4000 - GNSS MEA		
FLAT ROCK, VA VORTAC	GORDONSVILLE, VA VORTAC	2500
GORDONSVILLE, VA VORTAC	LURAY, VA FIX	6100
LURAY, VA FIX	*KERRE, VA FIX	**6000
*7000 - MRA		
**5000 - MOCA		
KERRE, VA FIX	MARTINSBURG, WV VORTAC	*6000
*5000 - MOCA		
MARTINSBURG, WV VORTAC	WESTMINSTER, MD VORTAC	*4000
*3300 - MOCA		
WESTMINSTER, MD VORTAC	VINNY, PA FIX	3000
VINNY, PA FIX	MODENA, PA VORTAC	3500
MODENA, PA VORTAC	*MAZIE, PA FIX	3000
*5000 - MRA		
MAZIE, PA FIX	*HARRS, PA FIX	2500
*5000 - MRA		

FROM TO MEA

**95.6003 VOR FEDERAL AIRWAY V3 - CONTINUED**

HARRS, PA FIX *5000 - MRA	*BIGGY, NJ FIX	2500
BIGGY, NJ FIX	SOLBERG, NJ VOR/DME	2500
SOLBERG, NJ VOR/DME *2500 - MOCA	CARMEL, NY VOR/DME	*3000
CARMEL, NY VOR/DME	RACEY, CT FIX	2100
RACEY, CT FIX	HARTFORD, CT VOR/DME	3000
HARTFORD, CT VOR/DME *2100 - MOCA	JEWIT, CT FIX	*2600
JEWIT, CT FIX	WOONS, RI FIX	2500
WOONS, RI FIX	BOSTON, MA VOR/DME	2000
PRESQUE ISLE, ME VOR/DME *4200 - MOCA	U.S. CANADIAN BORDER	*8000

**95.6004 VOR FEDERAL AIRWAY V4**

TATOOSH, WA VORTAC	JAWBN, WA FIX	5800
JAWBN, WA FIX *4300 - MOCA	LOFAL, WA FIX	*5400
LOFAL, WA FIX *6200 - MCA SEATTLE, WA VORTAC , E BND **2800 - MOCA	*SEATTLE, WA VORTAC	**4000
SEATTLE, WA VORTAC	BLAKO, WA FIX E BND W BND	*10000 *4000
*3100 - MOCA	HUMPP, WA FIX E BND W BND	*10000 *6600
BLAKO, WA FIX *6600 - MOCA	CHINS, WA FIX	*10000
HUMPP, WA FIX *9000 - MOCA	TITON, WA FIX E BND W BND	*7000 *10000
CHINS, WA FIX *7000 - MOCA	GLEED, WA FIX W BND E BND	*7000 *5500
TITON, WA FIX *5000 - MOCA	YAKIMA, WA VORTAC E BND W BND	5000 5500
GLEED, WA FIX	AMPLE, WA FIX	5000
YAKIMA, WA VORTAC	PENDLETON, OR VORTAC	4000
AMPLE, WA FIX	PIANO, OR FIX SE BND NW BND	7000 6000
PENDLETON, OR VORTAC	LACED, OR FIX NW BND SE BND	7000 10000
PIANO, OR FIX	BAKER CITY, OR VOR/DME	10000
LACED, OR FIX	PAYET, ID FIX	9000
BAKER CITY, OR VOR/DME	*EMETT, ID FIX SE BND NW BND	5900 9000
PAYET, ID FIX *9400 - MRA	BOISE, ID VORTAC	5900
EMETT, ID FIX	CANEK, ID FIX NW BND SE BND	7000 9500
BOISE, ID VORTAC		

FROM	TO	MEA
<b>95.6004 VOR FEDERAL AIRWAY V4 - CONTINUED</b>		
CANEK, ID FIX	ALKAL, ID FIX	*9500
*8500 - MOCA		
ALKAL, ID FIX	GOODE, ID FIX	
	E BND	*8000
	W BND	*9500
*6200 - MOCA		
GOODE, ID FIX	JEROT, ID FIX	*8000
*6500 - MOCA		
JEROT, ID FIX	BURLEY, ID VOR/DME	6500
BURLEY, ID VOR/DME	MEDEA, ID FIX	*8400
*7800 - MOCA		
MEDEA, ID FIX	MALAD CITY, ID VOR/DME	9400
MALAD CITY, ID VOR/DME	FILOB, ID FIX	10900
FILOB, ID FIX	HODNI, ID FIX	*12000
*10800 - MOCA		
*10800 - GNSS MEA		
HODNI, ID FIX	GRIPS, WY FIX	*16000
*11700 - MOCA		
*11700 - GNSS MEA		
GRIPS, WY FIX	ROCK SPRINGS, WY VOR/DME	*11000
*10000 - MOCA		
*10000 - GNSS MEA		
ROCK SPRINGS, WY VOR/DME	CHEROKEE, WY VOR/DME	10000
CHEROKEE, WY VOR/DME	KLASH, WY FIX	
	E BND	13000
	W BND	11000
KLASH, WY FIX	*LARAMIE, WY VOR/DME	13000
*10600 - MCA LARAMIE, WY VOR/DME , W BND		
LARAMIE, WY VOR/DME	FLEMS, WY FIX	11000
FLEMS, WY FIX	BARGR, CO FIX	*11000
*10000 - MOCA		
BARGR, CO FIX	WISER, CO FIX	8400
WISER, CO FIX	GILL, CO VOR/DME	8000
GILL, CO VOR/DME	THURMAN, CO VORTAC	7000
THURMAN, CO VORTAC	GOODLAND, KS VORTAC	*7000
*6300 - MOCA		
GOODLAND, KS VORTAC	HILL CITY, KS VORTAC	5500
HILL CITY, KS VORTAC	*WESAL, KS FIX	**5500
*4500 - MRA		
**4100 - MOCA		
WESAL, KS FIX	SALINA, KS VORTAC	
	E BND	*4000
	W BND	*4500
*2900 - MOCA		
SALINA, KS VORTAC	*VASCO, KS FIX	3000
*5000 - MRA		
VASCO, KS FIX	ALMAS, KS FIX	3000
ALMAS, KS FIX	TOPEKA, KS VORTAC	3600
TOPEKA, KS VORTAC	KANSAS CITY, MO VORTAC	2700
KANSAS CITY, MO VORTAC	LEXIN, MO FIX	2600
LEXIN, MO FIX	HALLSVILLE, MO VORTAC	*6000
*3000 - GNSS MEA		
HALLSVILLE, MO VORTAC	SADEN, MO FIX	2600
SADEN, MO FIX	ST LOUIS, MO VORTAC	*2400
*1700 - MOCA		
ST LOUIS, MO VORTAC	TROY, IL VORTAC	2400
TROY, IL VORTAC	CENTRALIA, IL VORTAC	2300
CENTRALIA, IL VORTAC	POCKET CITY, IN VORTAC	3000
POCKET CITY, IN VORTAC	LAMBS, IN FIX	
	W BND	2500
	E BND	10000

FROM TO MEA

**95.6004 VOR FEDERAL AIRWAY V4 - CONTINUED**

LAMBS, IN FIX	*LOUISVILLE, KY VORTAC	**10000
*10000 - MCA LOUISVILLE, KY VORTAC , W BND		
**3000 - GNSS MEA		
LOUISVILLE, KY VORTAC	LEXINGTON, KY VOR/DME	2800
CHARLESTON, WV VOR/DME	REACH, WV FIX	4000
REACH, WV FIX	*ELKINS, WV VORTAC	4400
*4900 - MCA ELKINS, WV VORTAC , E BND		
ELKINS, WV VORTAC	KESSEL, WV VOR/DME	6400
KESSEL, WV VOR/DME	ARMEL, VA VOR/DME	5000

**95.6005 VOR FEDERAL AIRWAY V5**

PECAN, GA VOR/DME	VIENNA, GA VORTAC	*2000
*1900 - MOCA		
VIENNA, GA VORTAC	DUBLIN, GA VORTAC	2100
DUBLIN, GA VORTAC	ATHENS, GA VOR/DME	*3000
*2200 - MOCA		
ATHENS, GA VOR/DME	IRMOS, GA FIX	3100
IRMOS, GA FIX	CORCE, GA FIX	3800
CORCE, GA FIX	AWSON, GA FIX	*5400
*4600 - MOCA		
AWSON, GA FIX	*NELLO, GA FIX	**7000
*7000 - MCA NELLO, GA FIX , E BND		
**5500 - MOCA		
NELLO, GA FIX	*HOICHE, GA FIX	5400
*4000 - MCA HOICHE, GA FIX , SE BND		
HOICHE, GA FIX	CHOO CHOO, TN VORTAC	3000
NEW HOPE, KY VOR/DME	*LOUISVILLE, KY VORTAC	2700
*10000 - MCA LOUISVILLE, KY VORTAC , NE BND		
LOUISVILLE, KY VORTAC	*NERVE, KY FIX	**10000
*10000 - MCA NERVE, KY FIX , SW BND		
**2700 - GNSS MEA		
**LOUISVILLE R-036 UNUSABLE BELOW 10000.		
NERVE, KY FIX	CINCINNATI, KY VORTAC	2700
CINCINNATI, KY VORTAC	PRUDE, OH FIX	3000
PRUDE, OH FIX	SHIRT, OH FIX	*4000
*2500 - MOCA		
SHIRT, OH FIX	*GLOOM, OH FIX	3000
*4000 - MRA		
GLOOM, OH FIX	APPLETON, OH VORTAC	3000

**95.6006 VOR FEDERAL AIRWAY V6**

OAKLAND, CA VOR/DME	COLLI, CA FIX	4000
COLLI, CA FIX	*PITTS, CA FIX	5000
*3800 - MCA PITTS, CA FIX , S BND		
PITTS, CA FIX	REJOY, CA FIX	*4000
*2400 - MOCA		
REJOY, CA FIX	SACRAMENTO, CA VORTAC	2000
SACRAMENTO, CA VORTAC	FOLLY, CA FIX	3000
FOLLY, CA FIX	*COLOM, CA FIX	5000
*9500 - MCA COLOM, CA FIX , NE BND		
COLOM, CA FIX	SQUAW VALLEY, CA VOR/DME	11000
SQUAW VALLEY, CA VOR/DME	*MUSTANG, NV VORTAC	13000
*12000 - MCA MUSTANG, NV VORTAC , SW BND		
MUSTANG, NV VORTAC	WADDS, NV FIX	10300
WADDS, NV FIX	*LOVELOCK, NV VORTAC	**10000
*8500 - MCA LOVELOCK, NV VORTAC , NE BND		
**9500 - MOCA		

FROM TO MEA

**95.6006 VOR FEDERAL AIRWAY V6 - CONTINUED**

LOVELOCK, NV VORTAC	BATTLE MOUNTAIN, NV VORTAC	12000
BATTLE MOUNTAIN, NV VORTAC	WELLS, NV VOR/DME	*11000
*10100 - MOCA		
WELLS, NV VOR/DME	LUCIN, UT VORTAC	10300
LUCIN, UT VORTAC	*OGDEN, UT VORTAC	9000
*10700 - MCA OGDEN, UT VORTAC , E BND		
OGDEN, UT VORTAC	EVIEW, UT FIX	
	E BND	12000
	W BND	7000
EVIEW, UT FIX	FORT BRIDGER, WY VOR/DME	12000
FORT BRIDGER, WY VOR/DME	ROCK SPRINGS, WY VOR/DME	10000
ROCK SPRINGS, WY VOR/DME	CHEROKEE, WY VOR/DME	10000
CHEROKEE, WY VOR/DME	MEDICINE BOW, WY VOR/DME	10000
MEDICINE BOW, WY VOR/DME	MOIST, WY FIX	9500
MOIST, WY FIX	*LITER, WY FIX	**10500
*10500 - MCA LITER, WY FIX , W BND		
**9500 - MOCA		
LITER, WY FIX	SIDNEY, NE VOR/DME	*9500
*7600 - MOCA		
SIDNEY, NE VOR/DME	NORTH PLATTE, NE VOR/DME	*6000
*5700 - MOCA		
NORTH PLATTE, NE VOR/DME	RAGAR, NE FIX	*5000
*4300 - MOCA		
RAGAR, NE FIX	GRAND ISLAND, NE VOR/DME	*5000
*3600 - MOCA		
GRAND ISLAND, NE VOR/DME	HUSKR, NE FIX	*4000
*3200 - MOCA		
HUSKR, NE FIX	OMAHA, IA VORTAC	4000
OMAHA, IA VORTAC	DES MOINES, IA VORTAC	3000
DES MOINES, IA VORTAC	IOWA CITY, IA VOR/DME	2700
IOWA CITY, IA VOR/DME	DAVENPORT, IA VORTAC	2700
DAVENPORT, IA VORTAC	LEECS, IL FIX	2500
LEECS, IL FIX	DUPAGE, IL VOR/DME	*4000
*2700 - GNSS MEA		
NILES, IL FIX	CHETT, MI FIX	*3500
*2500 - MOCA		
CHETT, MI FIX	GIPPER, MI VORTAC	*3000
*2200 - MOCA		
GIPPER, MI VORTAC	MODEM, IN FIX	*4000
*2600 - MOCA		
PHILIPSBURG, PA VORTAC	SELINGROVE, PA VOR/DME	4100
SELINGROVE, PA VOR/DME	SNOWY, PA FIX	*5000
*4000 - GNSS MEA		
SNOWY, PA FIX	ALLENTOWN, PA VORTAC	*4000
*3300 - MOCA		
ALLENTOWN, PA VORTAC	SOLBERG, NJ VOR/DME	*3000
*2200 - MOCA		
*ALLENTOWN R-115 UNUSABLE. USE SOLBERG R-295.		
SOLBERG, NJ VOR/DME	EMPYR, NY FIX	2300
EMPYR, NY FIX	NANCI, NY FIX	2700
NANCI, NY FIX	LA GUARDIA, NY VOR/DME	2900

**95.6007 VOR FEDERAL AIRWAY V7**

DOLPHIN, FL VORTAC	LEE COUNTY, FL VORTAC	2300
LEE COUNTY, FL VORTAC	JOCKS, FL FIX	2600
JOCKS, FL FIX	*CROWD, FL FIX	**2300
*5000 - MRA		
**1600 - MOCA		

FROM TO MEA

**95.6007 VOR FEDERAL AIRWAY V7 - CONTINUED**

CROWD, FL FIX	LAKELAND, FL VORTAC	2300
LAKELAND, FL VORTAC	*DADES, FL FIX	**2300
*5000 - MRA		
**1800 - MOCA		
DADES, FL FIX	NITTS, FL FIX	*2300
*1800 - MOCA		
NITTS, FL FIX	*ORATE, FL FIX	**3000
*3000 - MRA		
**1700 - MOCA		
ORATE, FL FIX	CROSS CITY, FL VORTAC	*2000
*1500 - MOCA		
CROSS CITY, FL VORTAC	SEMINOLE, FL VORTAC	2000
SEMINOLE, FL VORTAC	OALDY, AL FIX	2000
OALDY, AL FIX	WIREGRASS, AL VORTAC	2500
WIREGRASS, AL VORTAC	SKIPO, AL FIX	2300
SKIPO, AL FIX	*BANBI, AL FIX	**4000
*4000 - MCA BANBI, AL FIX , SE BND		
**1900 - MOCA		
**2300 - GNSS MEA		
BANBI, AL FIX	MONTGOMERY, AL VORTAC	2400
MONTGOMERY, AL VORTAC	VULCAN, AL VORTAC	3100
POCKET CITY, IN VORTAC	PRINC, IN FIX	
	N BND	2300
	S BND	4500
PRINC, IN FIX	LISLE, IN FIX	4500
LISLE, IN FIX	TERRE HAUTE, IN VORTAC	3000
TERRE HAUTE, IN VORTAC	*POTES, IN FIX	2500
*4000 - MRA		
POTES, IN FIX	BOILER, IN VORTAC	2500
BOILER, IN VORTAC	CHICAGO HEIGHTS, IL VORTAC	2800
CHICAGO HEIGHTS, IL VORTAC	*LAIRD, IL FIX	3500
*2700 - MCA LAIRD, IL FIX , S BND		
LAIRD, IL FIX	*THORR, IL FIX	2500
*2600 - MCA THORR, IL FIX , S BND		
THORR, IL FIX	PAPPI, IL FIX	*2500
*1800 - MOCA		
PAPPI, IL FIX	*TALOR, WI FIX	**4000
*5300 - MCA TALOR, WI FIX , N BND		
**1800 - MOCA		
TALOR, WI FIX	PETTY, WI FIX	*6000
*1900 - MOCA		

**95.6008 VOR FEDERAL AIRWAY V8**

DOYLE, CA FIX	LIMBO, CA FIX	3000
LIMBO, CA FIX	*WILMA, CA FIX	3200
*2800 - MCA WILMA, CA FIX , W BND		
WILMA, CA FIX	SEAL BEACH, CA VORTAC	2300
SEAL BEACH, CA VORTAC	AHEIM, CA FIX	*3000
*2200 - MOCA		
AHEIM, CA FIX	*OLLIE, CA FIX	3000
*4300 - MCA OLLIE, CA FIX , NE BND		
OLLIE, CA FIX	PARADISE, CA VORTAC	5300
PARADISE, CA VORTAC	*RAVON, CA FIX	4700
*8800 - MCA RAVON, CA FIX , NE BND		
RAVON, CA FIX	GAREY, CA FIX	
	SW BND	8000
	NE BND	10500
GAREY, CA FIX	*LUCER, CA FIX	10500
*9300 - MCA LUCER, CA FIX , SW BND		

FROM	TO	MEA
------	----	-----

**95.6008 VOR FEDERAL AIRWAY V8 - CONTINUED**

LUCER, CA FIX *8000 - MOCA	BULGY, CA FIX	*9000
BULGY, CA FIX *7000 - MOCA	HECTOR, CA VORTAC	*9000
HECTOR, CA VORTAC *8200 - MOCA	GOFFS, CA VORTAC	*9000
GOFFS, CA VORTAC	LYNSY, NV FIX	7600
LYNSY, NV FIX	MEADS, NV FIX	7500
MEADS, NV FIX	MORMON MESA, NV VORTAC	6000
MORMON MESA, NV VORTAC	MATZO, UT FIX	
	NE BND	12000
	SW BND	9000
MATZO, UT FIX	BRYCE CANYON, UT VORTAC	12300
BRYCE CANYON, UT VORTAC	HANKSVILLE, UT VORTAC	13300
HANKSVILLE, UT VORTAC	GRAND JUNCTION, CO VOR/DME	10000
GRAND JUNCTION, CO VOR/DME *12000 - MCA SQUAT, CO FIX , NE BND **9600 - MOCA	*SQUAT, CO FIX	**10500
SQUAT, CO FIX	RIFLE, CO VOR/DME	13200
RIFLE, CO VOR/DME	KREMMLING, CO VOR/DME	13400
KREMMLING, CO VOR/DME *10300 - MCA MILE HIGH, CO VORTAC , W BND	*MILE HIGH, CO VORTAC	15500
MILE HIGH, CO VORTAC	HOYTT, CO FIX	7600
HOYTT, CO FIX	AKRON, CO VOR/DME	7000
AKRON, CO VOR/DME	HAYES CENTER, NE VORTAC	6500
HAYES CENTER, NE VORTAC *4900 - MOCA	GRAND ISLAND, NE VOR/DME	*5500
GRAND ISLAND, NE VOR/DME *3200 - MOCA	HUSKR, NE FIX	*4000
HUSKR, NE FIX	OMAHA, IA VORTAC	4000
OMAHA, IA VORTAC	DES MOINES, IA VORTAC	3000
DES MOINES, IA VORTAC	IOWA CITY, IA VOR/DME	2700
IOWA CITY, IA VOR/DME	MOLINE, IL VOR/DME	2700
MOLINE, IL VOR/DME	TRIDE, IL FIX	
	W BND	3300
	E BND	4000
TRIDE, IL FIX	JOLIET, IL VOR/DME	
	E BND	2600
	W BND	3300
JOLIET, IL VOR/DME	CHICAGO HEIGHTS, IL VORTAC	2500
CHICAGO HEIGHTS, IL VORTAC	HALIE, IN FIX	2600
HALIE, IN FIX *2300 - MOCA	INKEN, IN FIX	*4000
INKEN, IN FIX	GOSHEN, IN VORTAC	2600
GOSHEN, IN VORTAC *5000 - MRA **2500 - MOCA	*TWERP, OH FIX	**4500
TWERP, OH FIX	FLAG CITY, OH VORTAC	2700
MARTINSBURG, WV VORTAC	WASHINGTON, DC VOR/DME	3300

**95.6009 VOR FEDERAL AIRWAY V9**

LEEVILLE, LA VORTAC *1400 - MOCA	SAFES, LA FIX	*2000
SAFES, LA FIX *1600 - MOCA	WAVEZ, LA FIX	*4000
WAVEZ, LA FIX *1800 - MOCA	OYSTY, LA FIX	*3000
OYSTY, LA FIX	MC COMB, MS VORTAC	2000



FROM TO MEA

**95.6009 VOR FEDERAL AIRWAY V9 - CONTINUED**

MC COMB, MS VORTAC *4000 - MRA **1900 - MOCA	*ROMAR, MS FIX	**3000
ROMAR, MS FIX *1900 - MOCA	MAGNOLIA, MS VORTAC	*3000
MAGNOLIA, MS VORTAC	SIDON, MS VORTAC	2000
SIDON, MS VORTAC	MARVELL, AR VOR/DME	2100
FARMINGTON, MO VORTAC *2500 - MOCA	ARNOL, IL FIX	*3000
ARNOL, IL FIX	ST LOUIS, MO VORTAC	2800
ST LOUIS, MO VORTAC *2100 - MOCA	SPINNER, IL VORTAC	*2700
SPINNER, IL VORTAC *2300 - MOCA	PONTIAC, IL VOR/DME	*3000
JANESVILLE, WI VOR/DME	MADISON, WI VORTAC	3000
MADISON, WI VORTAC	OSHKOSH, WI VORTAC	3000
OSHKOSH, WI VORTAC *2300 - MOCA	GREEN BAY, WI VORTAC	*3000
GREEN BAY, WI VORTAC	IRON MOUNTAIN, MI VOR/DME	2900
IRON MOUNTAIN, MI VOR/DME *3300 - MOCA	HOUGHTON, MI VOR/DME	*3800

**95.6010 VOR FEDERAL AIRWAY V10**

PUEBLO, CO VORTAC	LAMAR, CO VOR/DME	7000
LAMAR, CO VOR/DME	ADEER, KS FIX	5700
ADEER, KS FIX	GARDEN CITY, KS VORTAC W BND E BND	*5700 *5000
*4400 - MOCA	DODGE CITY, KS VORTAC	4600
GARDEN CITY, KS VORTAC	STAFF, KS FIX	4300
DODGE CITY, KS VORTAC	HUTCHINSON, KS VOR/DME E BND W BND	3800 4300
STAFF, KS FIX	WAIVE, KS FIX	4000
HUTCHINSON, KS VOR/DME	*FLOSS, KS FIX	3300
WAIVE, KS FIX *5000 - MRA	EMPORIA, KS VORTAC	3300
FLOSS, KS FIX	WETZL, KS FIX	*5000
EMPORIA, KS VORTAC *2600 - MOCA *3000 - GNSS MEA	NAPOLEON, MO VORTAC	3100
WETZL, KS FIX	KIRKSVILLE, MO VORTAC	3000
NAPOLEON, MO VORTAC	LOAMY, MO FIX	3000
KIRKSVILLE, MO VORTAC	BURLINGTON, IA VOR/DME	*2700
LOAMY, MO FIX *2200 - MOCA	BRADFORD, IL VORTAC	2600
BURLINGTON, IA VOR/DME	PLANO, IL FIX	3000
BRADFORD, IL VORTAC	CHETT, MI FIX	*3500
NILES, IL FIX *2500 - MOCA	GIPPER, MI VORTAC	*3000
CHETT, MI FIX *2200 - MOCA	LITCHFIELD, MI VOR/DME	2800
GIPPER, MI VORTAC	VOLAN, PA FIX	*5000
YOUNGSTOWN, OH VORTAC *3000 - MOCA *3000 - GNSS MEA	TALLS, PA FIX	*5000
VOLAN, PA FIX *3200 - MOCA *3300 - GNSS MEA		

FROM TO MEA

**95.6010 VOR FEDERAL AIRWAY V10 - CONTINUED**

TALLS, PA FIX	*REVLOC, PA VOR/DME	
	SE BND	4200
	NW BND	5000
*5000 - MCA REVLOC, PA VOR/DME , SE BND		
REVLOC, PA VOR/DME	JUNEY, PA FIX	*5000
		MAA - 12000
*5000 - GNSS MEA		
JUNEY, PA FIX	LANCASTER, PA VOR/DME	*5000
*3600 - MOCA		

**95.6011 VOR FEDERAL AIRWAY V11**

BROOKLEY, AL VORTAC	GREENE COUNTY, MS VORTAC	2000
GREENE COUNTY, MS VORTAC	MIZZE, MS FIX	*4000
*1900 - MOCA		
*3000 - GNSS MEA		
MIZZE, MS FIX	MAGNOLIA, MS VORTAC	*3000
*2400 - MOCA		
CUNNINGHAM, KY VOR/DME	POCKET CITY, IN VORTAC	2600
POCKET CITY, IN VORTAC	MACKY, IN FIX	
	N BND	2300
	S BND	3000
MACKY, IN FIX	CLOWN, IN FIX	
	N BND	*3000
	S BND	*6000
*2100 - MOCA		
CLOWN, IN FIX	SCOTO, IN FIX	*6000
*2100 - MOCA		
SCOTO, IN FIX	BRICKYARD, IN VORTAC	*2900
*2200 - MOCA		
BRICKYARD, IN VORTAC	WELDO, IN FIX	2900
WELDO, IN FIX	MARION, IN VOR/DME	2800
MARION, IN VOR/DME	FORT WAYNE, IN VORTAC	2600
FORT WAYNE, IN VORTAC	*GRABI, IN FIX	3000
*4500 - MRA		
GRABI, IN FIX	EDGE, OH FIX	*3000
*2400 - MOCA		

**95.6012 VOR FEDERAL AIRWAY V12**

GAVIOTA, CA VORTAC	SAN MARCUS, CA VORTAC	6400
SAN MARCUS, CA VORTAC	PALMDALE, CA VORTAC	9300
PALMDALE, CA VORTAC	HELDE, CA FIX	6000
HELDE, CA FIX	HECTOR, CA VORTAC	7900
HECTOR, CA VORTAC	CLIPP, CA FIX	9000
CLIPP, CA FIX	NEEDLES, CA VORTAC	*8000
*5900 - MOCA		
NEEDLES, CA VORTAC	DRAKE, AZ VORTAC	10000
DRAKE, AZ VORTAC	OATES, AZ FIX	10100
OATES, AZ FIX	WINSLOW, AZ VORTAC	10800
WINSLOW, AZ VORTAC	ZUNI, NM VORTAC	9000
ZUNI, NM VORTAC	*CARTY, NM FIX	11000
*10000 - MCA CARTY, NM FIX , W BND		
CARTY, NM FIX	*ALBUQUERQUE, NM VORTAC	9000
*10700 - MCA ALBUQUERQUE, NM VORTAC , E BND		
ALBUQUERQUE, NM VORTAC	OTTO, NM VOR	12000
OTTO, NM VOR	ANTON CHICO, NM VORTAC	*10000
*9400 - MOCA		
ANTON CHICO, NM VORTAC	TUCUMCARI, NM VORTAC	7700

FROM TO MEA

**95.6012 VOR FEDERAL AIRWAY V12 - CONTINUED**

TUCUMCARI, NM VORTAC	PANHANDLE, TX VORTAC	6000
PANHANDLE, TX VORTAC	MITBEE, OK VORTAC	5500
WICHITA, KS VORTAC	EMPORIA, KS VORTAC	3600
EMPORIA, KS VORTAC	WETZL, KS FIX	*5000
*2600 - MOCA		
*3000 - GNSS MEA		
WETZL, KS FIX	NAPOLEON, MO VORTAC	3100
NAPOLEON, MO VORTAC	FRANC, MO FIX	3000
FRANC, MO FIX	COLUMBIA, MO VOR/DME	2600
COLUMBIA, MO VOR/DME	STITH, MO FIX	*4000
*2200 - MOCA		
*COU R-096 UNUSABLE, USE FTZ R-272		
STITH, MO FIX	FORISTELL, MO VORTAC	*3000
*2500 - MOCA		
FORISTELL, MO VORTAC	TROY, IL VORTAC	*2600
*2100 - MOCA		
TROY, IL VORTAC	BIBLE GROVE, IL VORTAC	2300
BIBLE GROVE, IL VORTAC	WORKE, IL FIX	
	SW BND	2300
	NE BND	6000
WORKE, IL FIX	OZMOE, IN FIX	*6000
*2600 - MOCA		
OZMOE, IN FIX	SHELBYVILLE, IN VOR/DME	2500
*ALLEGHENY, PA VOR/DME	**JOHNSTOWN, PA VOR/DME	10000
*10000 - MCA ALLEGHENY, PA VOR/DME , E BND		
**10000 - MCA JOHNSTOWN, PA VOR/DME , W BND		
*ALLEGHENY R-096 UNUSABLE USE JOHNSTOWN R-274		
JOHNSTOWN, PA VOR/DME	HARRISBURG, PA VORTAC	5400
HARRISBURG, PA VORTAC	KUPPS, PA FIX	UNUSABLE
KUPPS, PA FIX	BOYER, PA FIX	UNUSABLE
BOYER, PA FIX	POTTSTOWN, PA VORTAC	*3000
*2400 - MOCA		

**95.6013 VOR FEDERAL AIRWAY V13**

MC ALLEN, TX VOR/DME	MANNY, TX FIX	*5000
*1700 - MOCA		
MANNY, TX FIX	ASCOT, TX FIX	*5000
*1500 - MOCA		
ASCOT, TX FIX	SOLON, TX FIX	
	N BND	*4000
	S BND	*5000
*1600 - MOCA		
SOLON, TX FIX	CORPUS CHRISTI, TX VORTAC	1800
CORPUS CHRISTI, TX VORTAC	PALACIOS, TX VORTAC	1700
PALACIOS, TX VORTAC	HUMBLE, TX VORTAC	2000
HUMBLE, TX VORTAC	CLEEP, TX FIX	3000
CLEEP, TX FIX	*LEGGE, TX FIX	3100
*3000 - MRA		
LEGGE, TX FIX	LUFKIN, TX VORTAC	2100
LUFKIN, TX VORTAC	CARTH, TX FIX	*3800
*2400 - MOCA		
CARTH, TX FIX	BELCHER, LA VORTAC	3100
BELCHER, LA VORTAC	*IDDAS, LA FIX	2000
*3000 - MRA		
IDDAS, LA FIX	*DUBOW, AR FIX	2000
*4000 - MRA		
DUBOW, AR FIX	TEXARKANA, AR VORTAC	2000
TEXARKANA, AR VORTAC	DEENS, AR FIX	
	SE BND	2300
	NW BND	4600

FROM TO MEA

**95.6013 VOR FEDERAL AIRWAY V13 - CONTINUED**

DEENS, AR FIX	RICH MOUNTAIN, OK VORTAC	*4600
*4000 - MOCA		
RICH MOUNTAIN, OK VORTAC	*HADES, AR FIX	**4600
*5000 - MRA		
**3900 - MOCA		
HADES, AR FIX	FORT SMITH, AR VORTAC	2000
FORT SMITH, AR VORTAC	*CHESO, AR FIX	3400
*5000 - MRA		
CHESO, AR FIX	RAZORBACK, AR VORTAC	3700
BUTLER, MO VORTAC	NAPOLEON, MO VORTAC	2900
NAPOLEON, MO VORTAC	LAMONI, IA VOR/DME	2900
LAMONI, IA VOR/DME	*WIVEY, IA FIX	3000
*4300 - MRA		
WIVEY, IA FIX	DES MOINES, IA VORTAC	3000
DES MOINES, IA VORTAC	*ANKEN, IA FIX	2700
*3500 - MCA ANKEN, IA FIX , N BND		
ANKEN, IA FIX	NEVAD, IA FIX	4000
NEVAD, IA FIX	ALOCK, IA FIX	*3300
*2800 - MOCA		
ALOCK, IA FIX	MASON CITY, IA VOR/DME	3000
MASON CITY, IA VOR/DME	FARMINGTON, MN VORTAC	3000
DULUTH, MN VORTAC	WEMAN, MN FIX	4000
WEMAN, MN FIX	BYPOR, MN FIX	5000
BYPOR, MN FIX	U.S. CANADIAN BORDER	4000

**95.6014 VOR FEDERAL AIRWAY V14**

CHISUM, NM VORTAC	ONSOM, NM FIX	
	W BND	*7000
	E BND	*7500
*6000 - MOCA		
ONSOM, NM FIX	WINNS, TX FIX	*8000
*6400 - MOCA		
WINNS, TX FIX	*FLATT, TX FIX	**8000
*8000 - MRA		
**5400 - MOCA		
FLATT, TX FIX	LUBBOCK, TX VORTAC	*5200
*5000 - MOCA		
LUBBOCK, TX VORTAC	CHILDRESS, TX VORTAC	5100
CHILDRESS, TX VORTAC	HOBART, OK VORTAC	3700
HOBART, OK VORTAC	CARFF, OK FIX	3700
CARFF, OK FIX	WILL ROGERS, OK VORTAC	3000
WILL ROGERS, OK VORTAC	TOTES, OK FIX	3700
TOTES, OK FIX	DROPS, OK FIX	*3700
*2500 - MOCA		
DROPS, OK FIX	TULSA, OK VORTAC	
	NE BND	2800
	SW BND	3800
SPRINGFIELD, MO VORTAC	VICHY, MO VOR/DME	3100
VICHY, MO VOR/DME	STEER, MO FIX	*3000
*2300 - MOCA		
STEER, MO FIX	ST LOUIS, MO VORTAC	2600
ST LOUIS, MO VORTAC	VANDALIA, IL VOR/DME	2500
VANDALIA, IL VOR/DME	TERRE HAUTE, IN VORTAC	2400
TERRE HAUTE, IN VORTAC	BRICKYARD, IN VORTAC	2700
BRICKYARD, IN VORTAC	MUNCIE, IN VOR/DME	2900
MUNCIE, IN VOR/DME	FLAG CITY, OH VORTAC	3000

**95.6015 VOR FEDERAL AIRWAY V15**

NAVASOTA, TX VOR/DME	COLLEGE STATION, TX VORTAC	2000
----------------------	----------------------------	------

FROM TO MEA

**95.6015 VOR FEDERAL AIRWAY V15 - CONTINUED**

COLLEGE STATION, TX VORTAC	SATTY, TX FIX	2200
SATTY, TX FIX	WACO, TX VORTAC	2400
WACO, TX VORTAC	CEDAR CREEK, TX VORTAC	2500
CEDAR CREEK, TX VORTAC	BONHAM, TX VORTAC	*3500
*2200 - MOCA		
ABERDEEN, SD VOR/DME	BISMARCK, ND VOR/DME	*5000
*3700 - MOCA		
BISMARCK, ND VOR/DME	MINOT, ND VOR/DME	4100

**95.6016 VOR FEDERAL AIRWAY V16**

LOS ANGELES, CA VORTAC	PRADO, CA FIX	4000
PRADO, CA FIX	PARADISE, CA VORTAC	5000
PARADISE, CA VORTAC	*SETER, CA FIX	5500
*12100 - MCA SETER, CA FIX , E BND		
SETER, CA FIX	BANDS, CA FIX	
	E BND	13000
	W BND	9000
BANDS, CA FIX	*PALM SPRINGS, CA VORTAC	13000
*11800 - MCA PALM SPRINGS, CA VORTAC , W BND		
PALM SPRINGS, CA VORTAC	BLYTHE, CA VORTAC	8000
BLYTHE, CA VORTAC	BUCKEYE, AZ VORTAC	6000
BUCKEYE, AZ VORTAC	PERKY, AZ FIX	5000
PERKY, AZ FIX	PHOENIX, AZ VORTAC	4000
PHOENIX, AZ VORTAC	*TOTEC, AZ FIX	5000
*5500 - MCA TOTEC, AZ FIX , E BND		
TOTEC, AZ FIX	TUCSON, AZ VORTAC	6500
TUCSON, AZ VORTAC	SAN SIMON, AZ VORTAC	11500
SAN SIMON, AZ VORTAC	ANIMA, NM FIX	8000
ANIMA, NM FIX	DARCE, NM FIX	9000
DARCE, NM FIX	COLUMBUS, NM VOR/DME	*9000
*8200 - MOCA		
COLUMBUS, NM VOR/DME	EL PASO, TX VORTAC	9000
EL PASO, TX VORTAC	SALT FLAT, TX VORTAC	*8000
*7400 - MOCA		
SALT FLAT, TX VORTAC	DILLI, TX FIX	8000
DILLI, TX FIX	CAVRN, TX FIX	*10000
*7500 - MOCA		
CAVRN, TX FIX	WINK, TX VORTAC	*10000
*5300 - MOCA		
WINK, TX VORTAC	GOMIT, TX FIX	5500
GOMIT, TX FIX	PIZON, TX FIX	5000
PIZON, TX FIX	MERGE, TX FIX	*7000
*4400 - MOCA		
MERGE, TX FIX	BIG SPRING, TX VORTAC	4400
BIG SPRING, TX VORTAC	WEEPE, TX FIX	4200
WEEPE, TX FIX	*LORAN, TX FIX	4500
*6500 - MRA		
LORAN, TX FIX	MERKE, TX FIX	4500
MERKE, TX FIX	ABILENE, TX VORTAC	*4000
*3200 - MOCA		
ABILENE, TX VORTAC	*ROGEE, TX FIX	3600
*5000 - MRA		
ROGEE, TX FIX	BOWIE, TX VORTAC	*4500
*2900 - MOCA		
BOWIE, TX VORTAC	BONHAM, TX VORTAC	4000
BONHAM, TX VORTAC	PARIS, TX VOR/DME	2400
PARIS, TX VOR/DME	TEXARKANA, AR VORTAC	2000
TEXARKANA, AR VORTAC	*HOSES, AR FIX	2000
*3000 - MRA		

FROM TO MEA

**95.6016 VOR FEDERAL AIRWAY V16 - CONTINUED**

HOSES, AR FIX *2300 - MOCA	SPARO, AR FIX	*4000
SPARO, AR FIX *1900 - MOCA	BUNNS, AR FIX	*6000
BUNNS, AR FIX	PINE BLUFF, AR VOR/DME	2000
PINE BLUFF, AR VOR/DME	MARVELL, AR VOR/DME	1900
MARVELL, AR VOR/DME	HOLLY SPRINGS, MS VORTAC	2200
SHELBYVILLE, TN VOR/DME	HINCH MOUNTAIN, TN VOR/DME	5000
HINCH MOUNTAIN, TN VOR/DME	BUCKY, TN FIX	5000
BUCKY, TN FIX	VOLUNTEER, TN VORTAC	3500
VOLUNTEER, TN VORTAC *4000 - MCA PENCE, TN FIX , NE BND	*PENCE, TN FIX	3000
PENCE, TN FIX	TAKEN, TN FIX	4000
TAKEN, TN FIX	HOLSTON MOUNTAIN, TN VORTAC	6000
HOLSTON MOUNTAIN, TN VORTAC	DAMAS, TN FIX	6000
DAMAS, TN FIX *7500 - MCA STOVE, VA FIX , SW BND	*STOVE, VA FIX	7500
STOVE, VA FIX	SPEEL, VA FIX	6000
SPEEL, VA FIX	PULASKI, VA VORTAC	5400
PULASKI, VA VORTAC	ROANOKE, VA VOR/DME	5300
ROANOKE, VA VOR/DME	GOOZE, VA FIX	5000
GOOZE, VA FIX	LYNCHBURG, VA VOR/DME W BND	*5000
	E BND	*3000
*2900 - MOCA		
LYNCHBURG, VA VOR/DME	FLAT ROCK, VA VORTAC	3000
FLAT ROCK, VA VORTAC	RICHMOND, VA VORTAC	2600
RICHMOND, VA VORTAC *5000 - MCA TAPPA, VA FIX , NE BND	*TAPPA, VA FIX	2000
TAPPA, VA FIX *1500 - MOCA	PATUXENT, MD VORTAC	*5000
*2000 - GNSS MEA		
PATUXENT, MD VORTAC *8000 - MRA	*GARED, MD FIX	**4500
*1500 - MOCA		
*4000 - GNSS MEA		
GARED, MD FIX *1500 - MOCA	CHOPS, MD FIX	*4500
*4000 - GNSS MEA		
CHOPS, MD FIX *1500 - MOCA	SMYRNA, DE VORTAC	*2000
SMYRNA, DE VORTAC	CEDAR LAKE, NJ VOR/DME	1800
CEDAR LAKE, NJ VOR/DME	COYLE, NJ VORTAC	1900
COYLE, NJ VORTAC *3800 - MCA DIXIE, NJ FIX , SW BND	*DIXIE, NJ FIX	3800
DIXIE, NJ FIX *1700 - MOCA	KENNEDY, NY VOR/DME	*2500
KENNEDY, NY VOR/DME	CALVERTON, NY VOR/DME	2000
CALVERTON, NY VOR/DME	CREAM, NY FIX	2000
CREAM, NY FIX	NORWICH, CT VOR/DME	2500
NORWICH, CT VOR/DME	WOONS, RI FIX	2500
WOONS, RI FIX	BOSTON, MA VOR/DME	2000

**95.6017 VOR FEDERAL AIRWAY V17**

BROWNSVILLE, TX VORTAC	HARLINGEN, TX VOR/DME	1600
HARLINGEN, TX VOR/DME	MC ALLEN, TX VOR/DME	2400
MC ALLEN, TX VOR/DME *1700 - MOCA	FATOR, TX FIX	*2500

FROM TO MEA

**95.6017 VOR FEDERAL AIRWAY V17 - CONTINUED**

FATOR, TX FIX *5500 - MRA **2800 - MOCA	*NELEE, TX FIX	**4000
NELEE, TX FIX	LAREDO, TX VORTAC	2500
LAREDO, TX VORTAC *5000 - MRA	*KAHAN, TX FIX	2400
KAHAN, TX FIX *1800 - MOCA	COTULLA, TX VORTAC	*2400
COTULLA, TX VORTAC	MILET, TX FIX	2500
MILET, TX FIX *2500 - MOCA	SOMER, TX FIX	*4000
SOMER, TX FIX *2400 - MOCA	SAN ANTONIO, TX VORTAC	*3000
SAN ANTONIO, TX VORTAC	CENTEX, TX VORTAC	3500
CENTEX, TX VORTAC	WACO, TX VORTAC	3600
MILLSAP, TX VORTAC	BOWIE, TX VORTAC	3000
BOWIE, TX VORTAC	ARDMORE, OK VORTAC	3000
ARDMORE, OK VORTAC	WILL ROGERS, OK VORTAC	3100
WILL ROGERS, OK VORTAC	ODINS, OK FIX	
	NW BND	4900
	SE BND	3300
ODINS, OK FIX *3600 - MOCA	CAMAR, OK FIX	*4900
CAMAR, OK FIX	MITBEE, OK VORTAC	
	W BND	4300
	E BND	4900
MITBEE, OK VORTAC	GARDEN CITY, KS VORTAC	4800
GARDEN CITY, KS VORTAC *9000 - MRA **4600 - MOCA	*COFFE, KS FIX	**5500
COFFE, KS FIX	GOODLAND, KS VORTAC	5500

**95.6018 VOR FEDERAL AIRWAY V18**

BELCHER, LA VORTAC	MONROE, LA VORTAC	2000
MONROE, LA VORTAC	MAGNOLIA, MS VORTAC	2500
MAGNOLIA, MS VORTAC	MERIDIAN, MS VORTAC	2500
COLLIERS, SC VORTAC	LASHE, SC FIX	2400
LASHE, SC FIX *2200 - MOCA	NORMS, SC FIX	*3000
NORMS, SC FIX *1700 - MOCA	SACKS, SC FIX	*4000
SACKS, SC FIX	CHARLESTON, SC VORTAC	2100

**95.6019 VOR FEDERAL AIRWAY V19**

CINCINNATI, KY VORTAC *2800 - MOCA	APPLETON, OH VORTAC	*4000
---------------------------------------	---------------------	-------

**95.6020 VOR FEDERAL AIRWAY V20**

MC ALLEN, TX VOR/DME	LATEX, TX FIX	1700
LATEX, TX FIX *1900 - MOCA	ASCOT, TX FIX	*4000
ASCOT, TX FIX	SOLON, TX FIX	
	N BND	*4000
*1600 - MOCA	S BND	*5000
SOLON, TX FIX	CORPUS CHRISTI, TX VORTAC	1800

FROM TO MEA

**95.6020 VOR FEDERAL AIRWAY V20 - CONTINUED**

CORPUS CHRISTI, TX VORTAC	BETZY, TX FIX	1800
BETZY, TX FIX	PALACIOS, TX VORTAC	2000
BEAUMONT, TX VOR/DME	LAKE CHARLES, LA VORTAC	2000
LAKE CHARLES, LA VORTAC	LAFAYETTE, LA VORTAC	1800
LAFAYETTE, LA VORTAC	RESERVE, LA VOR/DME	2000
RESERVE, LA VOR/DME	GULFPORT, MS VORTAC	2000
GULFPORT, MS VORTAC	SEMMES, AL VORTAC	*5000
*1800 - MOCA		
SEMMES, AL VORTAC	MONROEVILLE, AL VORTAC	2000
MONROEVILLE, AL VORTAC	*PICKS, AL FIX	2300
*3500 - MRA		
PICKS, AL FIX	MONTGOMERY, AL VORTAC	2300
MONTGOMERY, AL VORTAC	TUSKEGEE, AL VOR/DME	2000
TUSKEGEE, AL VOR/DME	MARVO, AL FIX	2100
MARVO, AL FIX	COLUMBUS, GA VORTAC	*2600
*2000 - MOCA		
COLUMBUS, GA VORTAC	SINCA, GA FIX	*4500
*2500 - MOCA		
SINCA, GA FIX	ATHENS, GA VOR/DME	*3000
*2200 - MOCA		
ATHENS, GA VOR/DME	ELECTRIC CITY, SC VORTAC	*2800
*2300 - MOCA		
ELECTRIC CITY, SC VORTAC	ELLID, SC FIX	3000
ELLID, SC FIX	CLEVA, SC FIX	3400
CLEVA, SC FIX	TUXDO, SC FIX	5000
TUXDO, SC FIX	SUGARLOAF MOUNTAIN, NC VORTAC	6200
SUGARLOAF MOUNTAIN, NC VORTAC	BARRETT'S MOUNTAIN, NC VOR/DME	6200
BARRETT'S MOUNTAIN, NC VOR/DME	LEAKS, NC FIX	3600
LEAKS, NC FIX	SOUTH BOSTON, VA VORTAC	3000
SOUTH BOSTON, VA VORTAC	*NUTTS, VA FIX	**3000
*9000 - MRA		
**2000 - MOCA		
NUTTS, VA FIX	MELIA, VA FIX	*3000
*2400 - MOCA		
MELIA, VA FIX	RICHMOND, VA VORTAC	2000
RICHMOND, VA VORTAC	*TAPPA, VA FIX	2000
*5000 - MCA TAPPA, VA FIX , NE BND		
TAPPA, VA FIX	*COLIN, VA FIX	**5000
*10000 - MCA COLIN, VA FIX , N BND		
**1500 - MOCA		
**2000 - GNSS MEA		
COLIN, VA FIX	NOTTINGHAM, MD VORTAC	*10000
*1800 - MOCA		
*2000 - GNSS MEA		

**95.6021 VOR FEDERAL AIRWAY V21**

SANTA CATALINA, CA VORTAC	SEAL BEACH, CA VORTAC	4000
SEAL BEACH, CA VORTAC	AHEIM, CA FIX	*3000
*2200 - MOCA		
AHEIM, CA FIX	*OLLIE, CA FIX	3000
*4300 - MCA OLLIE, CA FIX , NE BND		
OLLIE, CA FIX	PARADISE, CA VORTAC	5300
PARADISE, CA VORTAC	*RAVON, CA FIX	4700
*8800 - MCA RAVON, CA FIX , NE BND		
RAVON, CA FIX	GAREY, CA FIX	
	NE BND	10500
	SW BND	8000
GAREY, CA FIX	*LUCER, CA FIX	10500
*9300 - MCA LUCER, CA FIX , SW BND		



FROM TO MEA

**95.6021 VOR FEDERAL AIRWAY V21 - CONTINUED**

LUCER, CA FIX	BULGY, CA FIX	*9000
*8000 - MOCA		
BULGY, CA FIX	*HECTOR, CA VORTAC	**9000
*8200 - MCA HECTOR, CA VORTAC , NE BND		
**7000 - MOCA		
HECTOR, CA VORTAC	*WHIGG, CA FIX	10500
*12000 - MRA		
WHIGG, CA FIX	BOULDER CITY, NV VORTAC	10500
BOULDER CITY, NV VORTAC	MORMON MESA, NV VORTAC	7500
MORMON MESA, NV VORTAC	BERYL, UT FIX	9800
BERYL, UT FIX	MILFORD, UT VORTAC	10000
MILFORD, UT VORTAC	DELTA, UT VORTAC	9600
DELTA, UT VORTAC	FAIRFIELD, UT VORTAC	10300
FAIRFIELD, UT VORTAC	*WASATCH, UT VORTAC	9600
*8000 - MCA WASATCH, UT VORTAC , S BND		
WASATCH, UT VORTAC	OGDEN, UT VORTAC	7000
OGDEN, UT VORTAC	*CORIN, UT FIX	
	N BND	10000
	S BND	7600
*13000 - MRA		
CORIN, UT FIX	MALAD CITY, ID VOR/DME	10000
MALAD CITY, ID VOR/DME	BANNO, ID FIX	10000
BANNO, ID FIX	*POCATELLO, ID VOR/DME	9000
*8000 - MCA POCATELLO, ID VOR/DME , SE BND		
POCATELLO, ID VOR/DME	IDAHO FALLS, ID VOR/DME	7000
IDAHO FALLS, ID VOR/DME	*DUBOIS, ID VORTAC	7600
*8600 - MCA DUBOIS, ID VORTAC , N BND		
DUBOIS, ID VORTAC	DILLON, MT VOR/DME	*12000
*11200 - MOCA		
DILLON, MT VOR/DME	*WHITEHALL, MT VOR/DME	10000
*9300 - MCA WHITEHALL, MT VOR/DME , N BND		
WHITEHALL, MT VOR/DME	*HELENA, MT VORTAC	10600
*10000 - MCA HELENA, MT VORTAC , SE BND		
HELENA, MT VORTAC	GREAT FALLS, MT VORTAC	10000
GREAT FALLS, MT VORTAC	CUT BANK, MT VOR/DME	6000
CUT BANK, MT VOR/DME	U.S. CANADIAN BORDER	6300

**95.6023 VOR FEDERAL AIRWAY V23**

MISSION BAY, CA VORTAC	OCEANSIDE, CA VORTAC	3000
OCEANSIDE, CA VORTAC	BALBO, CA FIX	4000
BALBO, CA FIX	SEAL BEACH, CA VORTAC	
	NW BND	3000
	SE BND	4000
SEAL BEACH, CA VORTAC	LOS ANGELES, CA VORTAC	2500
LOS ANGELES, CA VORTAC	*CHATY, CA FIX	4000
*5400 - MCA CHATY, CA FIX , NW BND		
CHATY, CA FIX	*CASTA, CA FIX	6000
*8300 - MCA CASTA, CA FIX , NW BND		
CASTA, CA FIX	GORMAN, CA VORTAC	9500
GORMAN, CA VORTAC	*GRAPE, CA FIX	9500
*9500 - MCA GRAPE, CA FIX , S BND		
GRAPE, CA FIX	*LAMPE, CA FIX	
	NW BND	5000
	SE BND	9500
*7800 - MCA LAMPE, CA FIX , SE BND		
LAMPE, CA FIX	SHAFTER, CA VORTAC	
	NW BND	3000
	SE BND	6000

FROM TO MEA

**95.6023 VOR FEDERAL AIRWAY V23 - CONTINUED**

SHAFTER, CA VORTAC	DELNO, CA FIX	3000
DELNO, CA FIX	PIXEY, CA FIX	*5000
*2000 - MOCA		
*3000 - GNSS MEA		
PIXEY, CA FIX	LATON, CA FIX	*6000
*2000 - MOCA		
*3000 - GNSS MEA		
LATON, CA FIX	FRAME, CA FIX	*6000
*1900 - MOCA		
*2000 - GNSS MEA		
EBTUW, CA FIX	WRAPS, CA FIX	*4000
*3000 - MOCA		
WRAPS, CA FIX	LINDEN, CA VOR/DME	3000
LINDEN, CA VOR/DME	SACRAMENTO, CA VORTAC	2300
SACRAMENTO, CA VORTAC	GRIME, CA FIX	2000
GRIME, CA FIX	YUBBA, CA FIX	*4000
*2000 - MOCA		
YUBBA, CA FIX	*GRIDD, CA FIX	**4000
*4000 - MRA		
**3400 - MOCA		
GRIDD, CA FIX	RED BLUFF, CA VORTAC	*3000
*1700 - MOCA		
RED BLUFF, CA VORTAC	BEIRA, CA FIX	
	NW BND	8000
	SE BND	3000
BEIRA, CA FIX	*SHATA, CA FIX	
	NW BND	**8000
	SE BND	**6500
*8000 - MCA SHATA, CA FIX , NW BND		
**5500 - MOCA		
SHATA, CA FIX	FORT JONES, CA VOR/DME	10000
FORT JONES, CA VOR/DME	TALEM, OR FIX	*10000
*9400 - MOCA		
TALEM, OR FIX	*ROGUE VALLEY, OR VORTAC	
	NW BND	8000
	SE BND	10000
*7000 - MCA ROGUE VALLEY, OR VORTAC , SE BND		
ROGUE VALLEY, OR VORTAC	MOURN, OR FIX	7000
MOURN, OR FIX	*CURTI, OR FIX	**8000
*7000 - MRA		
**6500 - MOCA		
CURTI, OR FIX	EUGENE, OR VORTAC	
	SE BND	*6000
	NW BND	*4000
*4000 - MOCA		
EUGENE, OR VORTAC	TURNO, OR FIX	3000
TURNO, OR FIX	RAWER, OR FIX	5000
RAWER, OR FIX	BATTLE GROUND, WA VORTAC	4100
BATTLE GROUND, WA VORTAC	*MALAY, WA FIX	
	NW BND	6000
	SE BND	5000
*9500 - MRA		
MALAY, WA FIX	*MCKEN, WA FIX	
	S BND	6000
	N BND	5000
*4100 - MCA MCKEN, WA FIX , S BND		
MCKEN, WA FIX	SEATTLE, WA VORTAC	3000
SEATTLE, WA VORTAC	PAINE, WA VOR/DME	3000
PAINE, WA VOR/DME	EGRET, WA FIX	4500

FROM TO MEA

**95.6023 VOR FEDERAL AIRWAY V23 - CONTINUED**

EGRET, WA FIX	ACORD, WA FIX	3500
ACORD, WA FIX	WHATCOM, WA VORTAC	*3000
*2200 - MOCA		
WHATCOM, WA VORTAC	U.S. CANADIAN BORDER	3000

**95.6024 VOR FEDERAL AIRWAY V24**

REDWOOD FALLS, MN VOR/DME	*ALMAY, MN FIX	**3400
*5000 - MRA		
**2900 - MOCA		
ALMAY, MN FIX	KASPR, MN FIX	3400
KASPR, MN FIX	ROCHESTER, MN VOR/DME	3000
JANESVILLE, WI VOR/DME	FARMM, IL FIX	2900
FARMM, IL FIX	NORTHBROOK, IL VOR/DME	2700
PEOTONE, IL VORTAC	KENLA, IL FIX	2400
KENLA, IL FIX	VAGES, IN FIX	2600
VAGES, IN FIX	*POTES, IN FIX	**4000
*4000 - MRA		
**2300 - MOCA		
POTES, IN FIX	JAKKS, IN FIX	*4000
*2300 - MOCA		
JAKKS, IN FIX	BRICKYARD, IN VORTAC	2700

**95.6025 VOR FEDERAL AIRWAY V25**

MISSION BAY, CA VORTAC	REDIN, CA FIX	3000
REDIN, CA FIX	PACIF, CA FIX	*6000
*2000 - MOCA		
PACIF, CA FIX	ALBAS, CA FIX	*3000
*2000 - MOCA		
ALBAS, CA FIX	*FERMY, CA FIX	2100
*2700 - MCA FERMY, CA FIX , NW BND		
FERMY, CA FIX	*HERMO, CA FIX	3200
*2700 - MCA HERMO, CA FIX , SE BND		
HERMO, CA FIX	LOS ANGELES, CA VORTAC	2500
LOS ANGELES, CA VORTAC	*MERMA, CA FIX	2000
*3000 - MRA		
MERMA, CA FIX	EXERT, CA FIX	2000
EXERT, CA FIX	VENTURA, CA VOR/DME	5000
VENTURA, CA VOR/DME	DEANO, CA FIX	6000
DEANO, CA FIX	*SAN MARCUS, CA VORTAC	6200
*7600 - MCA SAN MARCUS, CA VORTAC , NW BND		
SAN MARCUS, CA VORTAC	POZOE, CA FIX	8600
POZOE, CA FIX	PASO ROBLES, CA VORTAC	
	NW BND	6000
	SE BND	7000
PASO ROBLES, CA VORTAC	SALINAS, CA VORTAC	5500
SALINAS, CA VORTAC	SANTY, CA FIX	*5000
*4000 - MOCA		
SANTY, CA FIX	WOODSIDE, CA VOR/DME	5100
WOODSIDE, CA VOR/DME	SAN FRANCISCO, CA VOR/DME	4700
SAN FRANCISCO, CA VOR/DME	SUTRO, CA FIX	3500
SUTRO, CA FIX	GOBBS, CA FIX	3000
GOBBS, CA FIX	STINS, CA FIX	3500
STINS, CA FIX	*POINT REYES, CA VOR/DME	3700
*8200 - MCA POINT REYES, CA VOR/DME , N BND		
POINT REYES, CA VOR/DME	*FREES, CA FIX	3500
*10200 - MCA FREES, CA FIX , N BND		
FREES, CA FIX	*GETER, CA FIX	**6000
*12000 - MCA GETER, CA FIX , N BND		
**6000 - GNSS MEA		

FROM TO MEA

**95.6025 VOR FEDERAL AIRWAY V25 - CONTINUED**

GETER, CA FIX	*LAPED, CA FIX	**12000
*9000 - MRA		
*12000 - MCA LAPED, CA FIX , S BND		
**6500 - MOCA		
LAPED, CA FIX	*GRENY, CA FIX	9000
*9000 - MCA GRENY, CA FIX , S BND		
GRENY, CA FIX	RED BLUFF, CA VORTAC	
	N BND	3200
	S BND	9000
RED BLUFF, CA VORTAC	HOMAN, CA FIX	4000
HOMAN, CA FIX	*ITMOR, CA FIX	**5000
*7000 - MCA ITMOR, CA FIX , N BND		
**4000 - MOCA		
**4000 - GNSS MEA		
ITMOR, CA FIX	MUREX, CA FIX	*11000
*9600 - MOCA		
*10000 - GNSS MEA		
MUREX, CA FIX	KLAMATH FALLS, OR VORTAC	
	N BND	*8500
	S BND	*11000
*8500 - MOCA		
KLAMATH FALLS, OR VORTAC	SPRAG, OR FIX	*12000
*9500 - MOCA		
*10000 - GNSS MEA		
SPRAG, OR FIX	OCTAD, OR FIX	*12000
*9500 - MOCA		
*10000 - GNSS MEA		
OCTAD, OR FIX	DESCHUTES, OR VORTAC	
	N BND	*7000
	S BND	*12000
*7000 - GNSS MEA		
DESCHUTES, OR VORTAC	*GASHE, OR FIX	**7000
*10000 - MRA		
**6500 - MOCA		
GASHE, OR FIX	*KCLICKITAT, OR VOR/DME	**7000
*5400 - MCA KCLICKITAT, OR VOR/DME , N BND		
**6500 - MOCA		
KCLICKITAT, OR VOR/DME	GUBSE, WA FIX	7800
GUBSE, WA FIX	YAKIMA, WA VORTAC	
	N BND	*5000
	S BND	*7800
*4500 - MOCA		
YAKIMA, WA VORTAC	*ELLENSBURG, WA VOR/DME	5900
*6800 - MCA ELLENSBURG, WA VOR/DME , N BND		
ELLENSBURG, WA VOR/DME	*WENATCHEE, WA VOR/DME	8900
*7400 - MCA WENATCHEE, WA VOR/DME , BND		

**95.6026 VOR FEDERAL AIRWAY V26**

BLUE MESA, CO VOR/DME	MONTROSE, CO VOR/DME	12500
MONTROSE, CO VOR/DME	GRAND JUNCTION, CO VOR/DME	11000
GRAND JUNCTION, CO VOR/DME	RAYMN, CO FIX	
	NE BND	11000
	SW BND	10000
RAYMN, CO FIX	MEEKER, CO VOR/DME	11000
MEEKER, CO VOR/DME	STRIM, CO FIX	11000
STRIM, CO FIX	CHEROKEE, WY VOR/DME	10000
CHEROKEE, WY VOR/DME	ALCOS, WY FIX	11700
ALCOS, WY FIX	MUDDY MOUNTAIN, WY VOR/DME	*10000
*9400 - MOCA		

FROM TO MEA

**95.6026 VOR FEDERAL AIRWAY V26 - CONTINUED**

MUDDY MOUNTAIN, WY VOR/DME	SALON, WY FIX	
	NE BND	13000
	SW BND	8000
SALON, WY FIX	RULER, SD FIX	*13000
*9500 - MOCA		
RULER, SD FIX	*RAPID CITY, SD VORTAC	
	NE BND	8300
	SW BND	13000
*11300 - MCA RAPID CITY, SD VORTAC , SW BND		
RAPID CITY, SD VORTAC	PHILIP, SD VOR/DME	5000
PHILIP, SD VOR/DME	PIERRE, SD VORTAC	*4400
*3700 - MOCA		
REDWOOD FALLS, MN VOR/DME	BEEGR, MN FIX	*3000
*2500 - MOCA		
BEEGR, MN FIX	LYDIA, MN FIX	*5500
*2400 - MOCA		
LYDIA, MN FIX	FARMINGTON, MN VORTAC	*3500
*2500 - MOCA		
FARMINGTON, MN VORTAC	PRESS, WI FIX	*3500
*2800 - MOCA		
PRESS, WI FIX	ELPAS, WI FIX	*5500
*2600 - MOCA		
ELPAS, WI FIX	EAU CLAIRE, WI VORTAC	*3500
*2800 - MOCA		

**95.6027 VOR FEDERAL AIRWAY V27**

MISSION BAY, CA VORTAC	REDIN, CA FIX	3000
REDIN, CA FIX	PACIF, CA FIX	*6000
*2000 - MOCA		
PACIF, CA FIX	AVOLS, CA FIX	*3000
*2000 - MOCA		
AVOLS, CA FIX	SANTA CATALINA, CA VORTAC	4000
SANTA CATALINA, CA VORTAC	EXERT, CA FIX	4000
EXERT, CA FIX	VENTURA, CA VOR/DME	5000
VENTURA, CA VOR/DME	KWANG, CA FIX	5000
KWANG, CA FIX	*GOLET, CA FIX	**4000
*5000 - MCA GOLET, CA FIX , NW BND		
**2300 - MOCA		
GOLET, CA FIX	GAVIOTA, CA VORTAC	6400
GAVIOTA, CA VORTAC	*ORCUT, CA FIX	6000
*6000 - MCA ORCUT, CA FIX , SE BND		
ORCUT, CA FIX	MORRO BAY, CA VORTAC	4000
MORRO BAY, CA VORTAC	BLANC, CA FIX	4000
BLANC, CA FIX	BIG SUR, CA VORTAC	7000
BIG SUR, CA VORTAC	CARME, CA FIX	7000
CARME, CA FIX	SHOEY, CA FIX	*6000
*5200 - MOCA		
SHOEY, CA FIX	*EUGEN, CA FIX	**6000
*7000 - MRA		
**3000 - MOCA		
EUGEN, CA FIX	*TAILS, CA FIX	**6000
*7000 - MRA		
**3000 - MOCA		
TAILS, CA FIX	HADLY, CA FIX	*6000
*3000 - MOCA		
HADLY, CA FIX	SEEMS, CA FIX	*4000
*3000 - MOCA		
SEEMS, CA FIX	STINS, CA FIX	*3500
*3000 - MOCA		

FROM TO MEA

**95.6027 VOR FEDERAL AIRWAY V27 - CONTINUED**

STINS, CA FIX	POINT REYES, CA VOR/DME	3700
POINT REYES, CA VOR/DME	FREES, CA FIX	3500
FREES, CA FIX	MENDOCINO, CA VORTAC	6000
MENDOCINO, CA VORTAC	OLRIO, CA FIX	6700
OLRIO, CA FIX	FORTUNA, CA VORTAC	
	NW BND	4000
	SE BND	6700
FORTUNA, CA VORTAC	CRESCENT CITY, CA VORTAC	3000
CRESCENT CITY, CA VORTAC	*ROOTY, OR FIX	6400
*11000 - MRA		
ROOTY, OR FIX	LEDGE, OR FIX	6400
LEDGE, OR FIX	NORTH BEND, OR VOR/DME	
	S BND	6400
	N BND	4000
NORTH BEND, OR VOR/DME	*GAMMA, OR FIX	
	S BND	4000
	N BND	4500
*6200 - MRA		
GAMMA, OR FIX	NEWPORT, OR VORTAC	4500
NEWPORT, OR VORTAC	CUTEL, OR FIX	
	S BND	3300
	N BND	8000
CUTEL, OR FIX	DANES, OR FIX	
	N BND	*8000
	S BND	*5000
*3600 - MOCA		
*4000 - GNSS MEA		
DANES, OR FIX	ASTORIA, OR VOR/DME	*8000
*5000 - MOCA		
*5000 - GNSS MEA		
ASTORIA, OR VOR/DME	HOQUIAM, WA VORTAC	3700
HOQUIAM, WA VORTAC	*CARRO, WA FIX	3200
*4000 - MRA		
CARRO, WA FIX	SEATTLE, WA VORTAC	3000

**95.6028 VOR FEDERAL AIRWAY V28**

OAKLAND, CA VOR/DME	*SALAD, CA FIX	4000
*4700 - MCA SALAD, CA FIX , NE BND		
SALAD, CA FIX	ALTAM, CA FIX	5000
ALTAM, CA FIX	HAIRE, CA FIX	4500
HAIRE, CA FIX	*LINDEN, CA VOR/DME	**3000
*4000 - MCA LINDEN, CA VOR/DME , NE BND		
**2100 - MOCA		
LINDEN, CA VOR/DME	*KATSO, CA FIX	5000
*12400 - MCA KATSO, CA FIX , NE BND		
KATSO, CA FIX	*SPOOK, CA FIX	**13000
*15000 - MCA SPOOK, CA FIX , N BND		
**12100 - MOCA		
SPOOK, CA FIX	RICHY, CA FIX	*15000
*12000 - MOCA		
RICHY, CA FIX	*MUSTANG, NV VORTAC	13000
*10500 - MCA MUSTANG, NV VORTAC , BND		

**95.6029 VOR FEDERAL AIRWAY V29**

SNOW HILL, MD VORTAC	*SALISBURY, MD VORTAC	**2000
*5000 - MCA SALISBURY, MD VORTAC , N BND		
**1500 - MOCA		

FROM TO MEA

**95.6029 VOR FEDERAL AIRWAY V29 - CONTINUED**

SALISBURY, MD VORTAC	*EZIZI, DE FIX	5000
*7000 - MCA EZIZI, DE FIX , N BND		
EZIZI, DE FIX	*LAFLN, DE FIX	**7000
*7000 - MCA LAFLN, DE FIX , S BND		
**5000 - GNSS MEA		
LAFNL, DE FIX	SMYRNA, DE VORTAC	1800
SMYRNA, DE VORTAC	DUPONT, DE VORTAC	*1800
*DUPONT R-181 UNUSABLE BELOW 10000 USE SMYRNA R-360		
DUPONT, DE VORTAC	MODENA, PA VORTAC	*3000
*1800 - MOCA		
*2000 - GNSS MEA		
MODENA, PA VORTAC	POTTSTOWN, PA VORTAC	2400
POTTSTOWN, PA VORTAC	*HIKES, PA FIX	2900
*4000 - MRA		
HIKES, PA FIX	EAST TEXAS, PA VOR/DME	2900
EAST TEXAS, PA VOR/DME	SLATT, PA FIX	4000
SLATT, PA FIX	*WILKES-BARRE, PA VORTAC	4000
*4400 - MCA WILKES-BARRE, PA VORTAC , N BND		
WILKES-BARRE, PA VORTAC	*SCOFF, PA FIX	4800
*4400 - MCA SCOFF, PA FIX , S BND		
SCOFF, PA FIX	BINGHAMTON, NY VOR/DME	3600
BINGHAMTON, NY VOR/DME	CORTA, NY FIX	*4000
*3600 - MOCA		
CORTA, NY FIX	VESPE, NY FIX	4500
VESPE, NY FIX	SYRACUSE, NY VORTAC	
	N BND	4000
	S BND	4500

**95.6030 VOR FEDERAL AIRWAY V30**

BADGER, WI VOR/DME	SQUIB, MI FIX	2900
SQUIB, MI FIX	PULLMAN, MI VOR/DME	3500
PULLMAN, MI VOR/DME	LITCHFIELD, MI VOR/DME	2800
PHILIPSBURG, PA VORTAC	SELINGSGROVE, PA VOR/DME	4100
SELINGSGROVE, PA VOR/DME	EAST TEXAS, PA VOR/DME	4000
EAST TEXAS, PA VOR/DME	SOLBERG, NJ VOR/DME	2700

**95.6032 VOR FEDERAL AIRWAY V32**

MUSTANG, NV VORTAC	HAZEN, NV VORTAC	*10000
*9200 - MOCA		
HAZEN, NV VORTAC	LOVELOCK, NV VORTAC	8000
LOVELOCK, NV VORTAC	BATTLE MOUNTAIN, NV VORTAC	11000
BATTLE MOUNTAIN, NV VORTAC	*BULLION, NV VOR/DME	**10000
*10800 - MCA BULLION, NV VOR/DME , E BND		
**9400 - MOCA		
BULLION, NV VOR/DME	SPATS, NV FIX	13000
SPATS, NV FIX	BONNEVILLE, UT VORTAC	*11000
*10000 - MOCA		
BONNEVILLE, UT VORTAC	*WASATCH, UT VORTAC	9000
*10400 - MCA WASATCH, UT VORTAC , NE BND		
WASATCH, UT VORTAC	FORT BRIDGER, WY VOR/DME	12000

**95.6033 VOR FEDERAL AIRWAY V33**

HARCUM, VA VORTAC	*COLIN, VA FIX	**4000
*10000 - MCA COLIN, VA FIX , N BND		
**1600 - MOCA		
**2000 - GNSS MEA		

FROM TO MEA

**95.6033 VOR FEDERAL AIRWAY V33 - CONTINUED**

COLIN, VA FIX	NOTTINGHAM, MD VORTAC	*10000
*1800 - MOCA		
*2000 - GNSS MEA		
BALTIMORE, MD VORTAC	VINNY, PA FIX	3000
VINNY, PA FIX	GRAMO, PA FIX	*7000
*5000 - GNSS MEA		
GRAMO, PA FIX	*HARRISBURG, PA VORTAC	**7000
*3600 - MCA HARRISBURG, PA VORTAC , NW BND		
*4600 - MCA HARRISBURG, PA VORTAC , SE BND		
**5000 - GNSS MEA		
HARRISBURG, PA VORTAC	*PHILIPSBURG, PA VORTAC	4900
*4800 - MCA PHILIPSBURG, PA VORTAC , SE BND		
PHILIPSBURG, PA VORTAC	KEATING, PA VORTAC	4000

**95.6034 VOR FEDERAL AIRWAY V34**

ROCHESTER, NY VOR/DME	HANCOCK, NY VOR/DME	4000
HANCOCK, NY VOR/DME	WEETS, NY FIX	6400
WEETS, NY FIX	PAWLING, NY VOR/DME	
	W BND	6000
	E BND	4000
PAWLING, NY VOR/DME	MADISON, CT VOR/DME	3000
MADISON, CT VOR/DME	SANDY POINT, RI VOR/DME	*2000
*1400 - MOCA		
SANDY POINT, RI VOR/DME	NANTUCKET, MA VOR/DME	2000

**95.6035 VOR FEDERAL AIRWAY V35**

DOLPHIN, FL VORTAC	CURVE, FL FIX	*2000
*1500 - MOCA		
CURVE, FL FIX	*DEEDS, FL FIX	**5000
*4000 - MRA		
**1300 - MOCA		
DEEDS, FL FIX	LEE COUNTY, FL VORTAC	2200
LEE COUNTY, FL VORTAC	ST PETERSBURG, FL VORTAC	2000
ST PETERSBURG, FL VORTAC	ENDED, FL FIX	2500
ENDED, FL FIX	CROSS CITY, FL VORTAC	*3000
*1500 - MOCA		
CROSS CITY, FL VORTAC	GREENVILLE, FL VORTAC	2000
GREENVILLE, FL VORTAC	*SALER, GA FIX	UNUSABLE
*3000 - MRA		
SALER, GA FIX	PECAN, GA VOR/DME	*2000
*1700 - MOCA		
SINCA, GA FIX	ATHENS, GA VOR/DME	*3000
*2200 - MOCA		
ATHENS, GA VOR/DME	ELECTRIC CITY, SC VORTAC	*2800
*2300 - MOCA		
ELECTRIC CITY, SC VORTAC	ELLID, SC FIX	3000
ELLID, SC FIX	CLEVA, SC FIX	3400
CLEVA, SC FIX	TUXDO, SC FIX	5000
TUXDO, SC FIX	SUGARLOAF MOUNTAIN, NC VORTAC	6200
SUGARLOAF MOUNTAIN, NC VORTAC	*BUSIC, NC FIX	8800
*9000 - MCA BUSIC, NC FIX , N BND		
BUSIC, NC FIX	*ROANS, TN FIX	9000
*9000 - MCA ROANS, TN FIX , S BND		
ROANS, TN FIX	HOLSTON MOUNTAIN, TN VORTAC	7000
HOLSTON MOUNTAIN, TN VORTAC	GLADE SPRING, VA VOR/DME	6700
GLADE SPRING, VA VOR/DME	MACET, WV FIX	*6500
*GZG TO COP UNUSABLE EXCEPT FOR AIRCRAFT WITH SUITABLE RNAV SYSTEM WITH GPS.		



FROM TO MEA

**95.6035 VOR FEDERAL AIRWAY V35 - CONTINUED**

MACET, WV FIX	CHARLESTON, WV VOR/DME	
	N BND	4500
	S BND	6500
CHARLESTON, WV VOR/DME	CARLA, WV FIX	*4000
*3000 - MOCA		
CARLA, WV FIX	BENZO, WV FIX	*4000
*3300 - MOCA		
BENZO, WV FIX	CLARKSBURG, WV VOR/DME	3300
CLARKSBURG, WV VOR/DME	MORGANTOWN, WV VOR/DME	4000
PHILIPSBURG, PA VORTAC	STONYFORK, PA VOR/DME	4500
STONYFORK, PA VOR/DME	ELMIRA, NY VOR/DME	*4500
*3900 - MOCA		
ELMIRA, NY VOR/DME	SCIPO, NY FIX	3700
SCIPO, NY FIX	SYRACUSE, NY VORTAC	3500

**95.6036 VOR FEDERAL AIRWAY V36**

U.S. CANADIAN BORDER	U.S. CANADIAN BORDER	*8000
*3000 - MOCA		
U.S. CANADIAN BORDER	SAULT STE MARIE, MI VOR/DME	*4600
*3100 - MOCA		
ELMIRA, NY VOR/DME	HAWLY, PA FIX	*GNSS - 4500
*ELMIRA R-122 UNUSABLE BELOW FL180 BEYOND 40 NM		
HAWLY, PA FIX	HOPCE, NJ FIX	*15500
*3600 - MOCA		
*4000 - GNSS MEA		
HOPCE, NJ FIX	NEION, NJ FIX	*13500
*3600 - MOCA		
*4000 - GNSS MEA		

**95.6037 VOR FEDERAL AIRWAY V37**

CRAIG, FL VORTAC	CARVL, FL FIX	2100
CARVL, FL FIX	BRUNSWICK, GA VORTAC	2000
BRUNSWICK, GA VORTAC	*BROUN, GA FIX	**3000
*11000 - MRA		
**2200 - MOCA		
BROUN, GA FIX	*HARPS, GA FIX	**3000
*3800 - MRA		
**2200 - MOCA		
HARPS, GA FIX	SAVANNAH, GA VORTAC	*3000
*2200 - MOCA		
SAVANNAH, GA VORTAC	ALLENDALE, SC VOR	*6000
*1600 - MOCA		
*4000 - GNSS MEA		
ALLENDALE, SC VOR	COLUMBIA, SC VORTAC	*3000
*2000 - GNSS MEA		
COLUMBIA, SC VORTAC	RICHE, SC FIX	*4000
*2400 - MOCA		
*2400 - GNSS MEA		
RICHE, SC FIX	CHARLOTTE, NC VOR/DME	2500
CHARLOTTE, NC VOR/DME	OWALT, NC FIX	3000
OWALT, NC FIX	JOTTA, NC FIX	*6000
*3500 - MOCA		
JOTTA, NC FIX	DOILY, VA FIX	*7000
*5100 - MOCA		
DOILY, VA FIX	PULASKI, VA VORTAC	*6000
*5000 - MOCA		
PULASKI, VA VORTAC	HAWKI, WV FIX	8000

FROM	TO	MEA
------	----	-----

**95.6037 VOR FEDERAL AIRWAY V37 - CONTINUED**

HAWKI, WV FIX	ELKINS, WV VORTAC	6000
ELKINS, WV VORTAC	CLARKSBURG, WV VOR/DME	*5000
*3900 - MOCA		
CLARKSBURG, WV VOR/DME	TEDDS, WV FIX	*4000
*3400 - MOCA		
TEDDS, WV FIX	CETPU, PA FIX	*5000
*3400 - MOCA		
*4000 - GNSS MEA		
CETPU, PA FIX	ELLWOOD CITY, PA VOR/DME	*4000
*3200 - MOCA		

**95.6038 VOR FEDERAL AIRWAY V38**

MOLINE, IL VOR/DME	TRIDE, IL FIX	
	W BND	3300
	E BND	4000
TRIDE, IL FIX	MEDAN, IL FIX	*4000
*2200 - MOCA		
MEDAN, IL FIX	PEOTONE, IL VORTAC	2400
PEOTONE, IL VORTAC	LUCIT, IN FIX	2500
LUCIT, IN FIX	CLEFT, IN FIX	*4000
*2400 - MOCA		
CLEFT, IN FIX	FORT WAYNE, IN VORTAC	2800
FORT WAYNE, IN VORTAC	WINES, OH FIX	2500
APPLETON, OH VORTAC	ZANESVILLE, OH VOR/DME	3000
ZANESVILLE, OH VOR/DME	PARKERSBURG, WV VOR/DME	3000
PARKERSBURG, WV VOR/DME	SACKY, WV FIX	3000
SACKY, WV FIX	*JULEA, WV FIX	3000
*5000 - MRA		
JULEA, WV FIX	BENZO, WV FIX	3300
BENZO, WV FIX	ELKINS, WV VORTAC	4000
ELKINS, WV VORTAC	*DEKAY, WV FIX	9000
*9500 - MRA		
DEKAY, WV FIX	CEROL, VA FIX	9000
CEROL, VA FIX	GORDONSVILLE, VA VORTAC	6000
GORDONSVILLE, VA VORTAC	*ROOKY, VA FIX	2500
*2500 - MRA		
ROOKY, VA FIX	RICHMOND, VA VORTAC	2100
RICHMOND, VA VORTAC	HARCUM, VA VORTAC	2000
HARCUM, VA VORTAC	CAPE CHARLES, VA VORTAC	2000

**95.6039 VOR FEDERAL AIRWAY V39**

SANDHILLS, NC VORTAC	SOUTH BOSTON, VA VORTAC	2500
SOUTH BOSTON, VA VORTAC	SHEPS, VA FIX	*3000
*2000 - MOCA		
SHEPS, VA FIX	GORDONSVILLE, VA VORTAC	3000
GORDONSVILLE, VA VORTAC	LURAY, VA FIX	6100
LURAY, VA FIX	*KERRE, VA FIX	**6000
*7000 - MRA		
**5000 - MOCA		
KERRE, VA FIX	MARTINSBURG, WV VORTAC	*6000
*5000 - MOCA		
MARTINSBURG, WV VORTAC	HYPER, MD FIX	*5000
*3900 - MOCA		
HYPER, MD FIX	BINNS, PA FIX	*9000
*2600 - MOCA		
*4000 - GNSS MEA		
BINNS, PA FIX	DELRO, PA FIX	*9000
*4500 - GNSS MEA		

FROM TO MEA

**95.6039 VOR FEDERAL AIRWAY V39 - CONTINUED**

DELRO, PA FIX	LANCASTER, PA VOR/DME	3000
LANCASTER, PA VOR/DME	BOYER, PA FIX	2900
BOYER, PA FIX	EAST TEXAS, PA VOR/DME	*3000
*2400 - MOCA		
EAST TEXAS, PA VOR/DME	SPARTA, NJ VORTAC	2700
SPARTA, NJ VORTAC	CARMEL, NY VOR/DME	2600
CARMEL, NY VOR/DME	SOARS, CT FIX	*3000
*CARMEL R-057 UNUSABLE		
SOARS, CT FIX	*MOONI, CT FIX	
	N BND	**12000
	S BND	**6000
*12000 - MCA MOONI, CT FIX , N BND		
*6000 - MCA MOONI, CT FIX , S BND		
**6000 - GNSS MEA		
MOONI, CT FIX	*STUBY, CT FIX	**12000
*12000 - MRA		
*12000 - MCA STUBY, CT FIX , S BND		
**4900 - MOCA		
**6000 - GNSS MEA		
STUBY, CT FIX	CHESTER, MA VOR/DME	4000
AUGUSTA, ME VOR/DME	RINTH, ME FIX	*3000
*2000 - MOCA		
RINTH, ME FIX	MILLINOCKET, ME VOR/DME	*3000
*2400 - MOCA		
MILLINOCKET, ME VOR/DME	PRESQUE ISLE, ME VOR/DME	*3000
*2500 - MOCA		
PRESQUE ISLE, ME VOR/DME	U.S. CANADIAN BORDER	*5000
*3000 - MOCA		

**95.6041 VOR FEDERAL AIRWAY V41**

CUTTA, OH FIX	YOUNGSTOWN, OH VORTAC	*5000
*3600 - GNSS MEA		

**95.6044 VOR FEDERAL AIRWAY V44**

COLUMBIA, MO VOR/DME	HODGS, MO FIX	2800
HODGS, MO FIX	FORISTELL, MO VORTAC	*2800
*2200 - MOCA		
FORISTELL, MO VORTAC	MOODS, IL FIX	2700
MOODS, IL FIX	CENTRALIA, IL VORTAC	2300
FALMOUTH, KY VOR/DME	YORK, KY VORTAC	3300
YORK, KY VORTAC	PARKERSBURG, WV VOR/DME	3300
PARKERSBURG, WV VOR/DME	BENDS, WV FIX	3000
BENDS, WV FIX	MORGANTOWN, WV VOR/DME	4000
MORGANTOWN, WV VOR/DME	KEYER, WV FIX	5000
KEYER, WV FIX	MARTINSBURG, WV VORTAC	*5000
*4100 - MOCA		
MARTINSBURG, WV VORTAC	WOOLY, MD FIX	3200
WOOLY, MD FIX	BALTIMORE, MD VORTAC	2600
BALTIMORE, MD VORTAC	PALEO, MD FIX	*2200
*1700 - MOCA		
PALEO, MD FIX	SPEAK, MD FIX	*13500
*2000 - GNSS MEA		
SPEAK, MD FIX	SEA ISLE, NJ VORTAC	*7000
*2000 - GNSS MEA		
SEA ISLE, NJ VORTAC	*KARRS, NJ FIX	**6000
*7000 - MCA KARRS, NJ FIX , NE BND		
**1800 - MOCA		
**2000 - GNSS MEA		

FROM TO MEA

**95.6044 VOR FEDERAL AIRWAY V44 - CONTINUED**

KARRS, NJ FIX	GAMBY, NJ FIX	*7000
*1300 - MOCA		
*2500 - GNSS MEA		
GAMBY, NJ FIX	DEER PARK, NY VOR/DME	*5000
*1600 - MOCA		
*2500 - GNSS MEA		
DEER PARK, NY VOR/DME	NESSI, CT FIX	2000
NESSI, CT FIX	BRIDGEPORT, CT VOR/DME	2000
BRIDGEPORT, CT VOR/DME	PAWLING, NY VOR/DME	3000
PAWLING, NY VOR/DME	*ATHOS, NY FIX	3100
*8000 - MCA ATHOS, NY FIX , N BND		
ATHOS, NY FIX	GROUP, NY FIX	*8000
*3000 - GNSS MEA		
GROUP, NY FIX	*ALBANY, NY VORTAC	**6000
*6000 - MCA ALBANY, NY VORTAC , BND		
**2800 - GNSS MEA		

**95.6045 VOR FEDERAL AIRWAY V45**

NEW BERN, NC VOR/DME	KINSTON, NC VORTAC	*2900
*KINSTON R-130 UNUSABLE USE NEWBERN R-313		
KINSTON, NC VORTAC	BRADY, NC FIX	UNUSABLE
BRADY, NC FIX	RALEIGH/DURHAM, NC VORTAC	2600
RALEIGH/DURHAM, NC VORTAC	*CHAPL, NC FIX	**2400
*2800 - MCA CHAPL, NC FIX , W BND		
**1900 - MOCA		
CHAPL, NC FIX	GREENSBORO, NC VORTAC	3100
GREENSBORO, NC VORTAC	*PROVE, NC FIX	2700
*3500 - MCA PROVE, NC FIX , NW BND		
PROVE, NC FIX	*FREON, NC FIX	4300
*4800 - MCA FREON, NC FIX , NW BND		
FREON, NC FIX	PULASKI, VA VORTAC	6200
PULASKI, VA VORTAC	BLUEFIELD, WV VOR/DME	6000
BLUEFIELD, WV VOR/DME	CHARLESTON, WV VOR/DME	6000
SAGINAW, MI VOR/DME	SEEKS, MI FIX	2200
SEEKS, MI FIX	ALPENA, MI VORTAC	*3500
*2600 - MOCA		
ALPENA, MI VORTAC	SAULT STE MARIE, MI VOR/DME	2900

**95.6046 VOR FEDERAL AIRWAY V46**

DEER PARK, NY VOR/DME	CALVERTON, NY VOR/DME	1900
CALVERTON, NY VOR/DME	HAMPTON, NY VORTAC	1900
HAMPTON, NY VORTAC	LIBBE, NY FIX	UNUSABLE
LIBBE, NY FIX	CLAMY, MA FIX	*3000
*2000 - MOCA		
CLAMY, MA FIX	NANTUCKET, MA VOR/DME	2000

**95.6047 VOR FEDERAL AIRWAY V47**

CUNNINGHAM, KY VOR/DME	POCKET CITY, IN VORTAC	2600
CINCINNATI, KY VORTAC	ROSEWOOD, OH VORTAC	3100
ROSEWOOD, OH VORTAC	FLAG CITY, OH VORTAC	3000

**95.6048 VOR FEDERAL AIRWAY V48**

OTTUMWA, IA VOR/DME	BURLINGTON, IA VOR/DME	2500
BURLINGTON, IA VOR/DME	PEORIA, IL VORTAC	2500
PEORIA, IL VORTAC	MAROC, IL FIX	*3000
*2400 - MOCA		

FROM TO MEA

**95.6048 VOR FEDERAL AIRWAY V48 - CONTINUED**

MAROC, IL FIX PONTIAC, IL VOR/DME 2500

**95.6050 VOR FEDERAL AIRWAY V50**

HASTINGS, NE VOR/DME	PAWNEE CITY, NE VORTAC	4000
PAWNEE CITY, NE VORTAC	ST JOSEPH, MO VORTAC	4000
ST JOSEPH, MO VORTAC	KIRKSVILLE, MO VORTAC	3000
KIRKSVILLE, MO VORTAC	QUINCY, IL VORTAC	2700
QUINCY, IL VORTAC	SPINNER, IL VORTAC	*3000
*2100 - MOCA		
SPINNER, IL VORTAC	ADDERS, IL VORTAC	3000
ADDERS, IL VORTAC	TERRE HAUTE, IN VORTAC	2500
TERRE HAUTE, IN VORTAC	BRICKYARD, IN VORTAC	2700
BRICKYARD, IN VORTAC	DAYTON, OH VOR/DME	3000

**95.6051 VOR FEDERAL AIRWAY V51**

PAHOKEE, FL VOR/DME	*SHEDS, FL FIX	2000
*3000 - MRA		
SHEDS, FL FIX	TREASURE, FL VORTAC	*2000
*1400 - MOCA		
TREASURE, FL VORTAC	OVIDO, FL FIX	*4000
*2800 - MOCA		
OVIDO, FL FIX	ORMOND BEACH, FL VORTAC	3000
ORMOND BEACH, FL VORTAC	BULLI, FL FIX	*2000
*1400 - MOCA		
BULLI, FL FIX	*ASTOR, FL FIX	**2000
*3000 - MRA		
**1400 - MOCA		
ASTOR, FL FIX	CRAIG, FL VORTAC	2100
CRAIG, FL VORTAC	ALMA, GA VORTAC	*5000
*1700 - MOCA		
*4000 - GNSS MEA		
*ALMA R-144 NA BELOW 10000		
ALMA, GA VORTAC	DUBLIN, GA VORTAC	*3000
*2000 - GNSS MEA		
*ALMA R-345 UNUSABLE, USE DUBLIN R-170		
DUBLIN, GA VORTAC	ATHENS, GA VOR/DME	*3000
*2200 - MOCA		
ATHENS, GA VOR/DME	IRMOS, GA FIX	3100
IRMOS, GA FIX	CORCE, GA FIX	3800
CORCE, GA FIX	TALLE, GA FIX	5300
TALLE, GA FIX	HARRIS, GA VORTAC	7000
HARRIS, GA VORTAC	ETOWA, TN FIX	7000
ETOWA, TN FIX	HINCH MOUNTAIN, TN VOR/DME	5000
HINCH MOUNTAIN, TN VOR/DME	LIVINGSTON, TN VOR/DME	5000
LIVINGSTON, TN VOR/DME	LOUISVILLE, KY VORTAC	3200
SHELBYVILLE, IN VOR/DME	*OCKEL, IN FIX	**5000
*4700 - MCA OCKEL, IN FIX , SE BND		
**2900 - MOCA		
OCKEL, IN FIX	BOILER, IN VORTAC	2600
BOILER, IN VORTAC	CHICAGO HEIGHTS, IL VORTAC	2800

**95.6052 VOR FEDERAL AIRWAY V52**

DES MOINES, IA VORTAC	BUSSY, IA FIX	*4500
*2400 - MOCA		
*2700 - GNSS MEA		
*DES MOINES R-105 UNUSABLE, USE OTTUMWA R-287		

FROM TO MEA

**95.6052 VOR FEDERAL AIRWAY V52 - CONTINUED**

BUSSY, IA FIX	OTTUMWA, IA VOR/DME	2700
OTTUMWA, IA VOR/DME	QUINCY, IL VORTAC	2600
QUINCY, IL VORTAC	*RIVRS, IL FIX	2600
*6000 - MRA		
RIVRS, IL FIX	ST LOUIS, MO VORTAC	2600
ST LOUIS, MO VORTAC	TROY, IL VORTAC	2400
TROY, IL VORTAC	KENBE, IL FIX	3000
KENBE, IL FIX	*CRATS, IL FIX	**4000
*5000 - MCA CRATS, IL FIX , SE BND		
**2600 - MOCA		
CRATS, IL FIX	OFEND, IL FIX	*5000
*1900 - MOCA		
OFEND, IL FIX	POCKET CITY, IN VORTAC	*4500
*2100 - MOCA		

**95.6053 VOR FEDERAL AIRWAY V53**

CHARLESTON, SC VORTAC	COLUMBIA, SC VORTAC	2100
COLUMBIA, SC VORTAC	WILLS, SC FIX	UNUSABLE
WILLS, SC FIX	*SPARTANBURG, SC VORTAC	2700
*5200 - MCA SPARTANBURG, SC VORTAC , NW BND		
SPARTANBURG, SC VORTAC	CARTT, SC FIX	
	NW BND	6200
	SE BND	3000
CARTT, SC FIX	SUGARLOAF MOUNTAIN, NC VORTAC	6200
SUGARLOAF MOUNTAIN, NC VORTAC	*BUSIC, NC FIX	8800
*9000 - MCA BUSIC, NC FIX , N BND		
BUSIC, NC FIX	*ROANS, TN FIX	9000
*9000 - MCA ROANS, TN FIX , S BND		
ROANS, TN FIX	HOLSTON MOUNTAIN, TN VORTAC	7000
LEXINGTON, KY VOR/DME	*LOUISVILLE, KY VORTAC	2800
*7000 - MCA LOUISVILLE, KY VORTAC , NW BND		
LOUISVILLE, KY VORTAC	HOUSE, IN FIX	*10000
*3000 - MOCA		
HOUSE, IN FIX	MOUTH, IN FIX	*2800
*2300 - MOCA		
MOUTH, IN FIX	BRICKYARD, IN VORTAC	2700

**95.6054 VOR FEDERAL AIRWAY V54**

WACO, TX VORTAC	CEDAR CREEK, TX VORTAC	2500
TEXARKANA, AR VORTAC	*WASHO, AR FIX	2200
*4000 - MRA		
WASHO, AR FIX	CANEY, AR FIX	*3500
*1800 - MOCA		
CANEY, AR FIX	MALVE, AR FIX	*3500
*1900 - MOCA		
MALVE, AR FIX	LITTLE ROCK, AR VORTAC	2000
SANDHILLS, NC VORTAC	*RAEFO, NC FIX	**6000
*6000 - MRA		
**2000 - MOCA		
**3000 - GNSS MEA		
RAEFO, NC FIX	FAYETTEVILLE, NC VOR/DME	*5000
*1900 - MOCA		
FAYETTEVILLE, NC VOR/DME	KINSTON, NC VORTAC	2000

**95.6055 VOR FEDERAL AIRWAY V55**

DAYTON, OH VOR/DME	FORT WAYNE, IN VORTAC	2800
--------------------	-----------------------	------

FROM TO MEA

**95.6055 VOR FEDERAL AIRWAY V55 - CONTINUED**

FORT WAYNE, IN VORTAC	GOSHEN, IN VORTAC	2700
GOSHEN, IN VORTAC	GIPPER, MI VORTAC	3000
GIPPER, MI VORTAC	KEELER, MI VOR/DME	*4000
*2300 - MOCA		
KEELER, MI VOR/DME	PULLMAN, MI VOR/DME	4000
GRAND FORKS, ND VOR/DME	*BEHQY, ND FIX	**8000
*12000 - MRA		
**3600 - MOCA		
BEHQY, ND FIX	BISMARCK, ND VOR/DME	3900

**95.6056 VOR FEDERAL AIRWAY V56**

COLLIERS, SC VORTAC	COLUMBIA, SC VORTAC	3000
COLUMBIA, SC VORTAC	FLORENCE, SC VORTAC	2000
FLORENCE, SC VORTAC	FAYETTEVILLE, NC VOR/DME	2300
FAYETTEVILLE, NC VOR/DME	*ROZBO, NC FIX	
	E BND	7000
	W BND	2000
*5000 - MRA		
ROZBO, NC FIX	WALLO, NC FIX	
	E BND	7000
	W BND	2000
WALLO, NC FIX	KROVE, NC FIX	*7000
*2400 - MOCA		
*3000 - GNSS MEA		
KROVE, NC FIX	*NEW BERN, NC VOR/DME	
	E BND	**2400
	W BND	**7000
*3000 - MCA NEW BERN, NC VOR/DME , BND		
**1800 - MOCA		

**95.6057 VOR FEDERAL AIRWAY V57**

LEXINGTON, KY VOR/DME	FALMOUTH, KY VOR/DME	3000
-----------------------	----------------------	------

**95.6059 VOR FEDERAL AIRWAY V59**

PULASKI, VA VORTAC	SOFTY, WV FIX	6400
SOFTY, WV FIX	BECKLEY, WV VOR/DME	*6000
*BECKLEY R-161 UNUSABLE		
BECKLEY, WV VOR/DME	WARDO, WV FIX	5100
WARDO, WV FIX	*EDSOE, WV FIX	3000
*3500 - MRA		
EDSOE, WV FIX	PARKERSBURG, WV VOR/DME	3000

**95.6060 VOR FEDERAL AIRWAY V60**

GALLUP, NM VORTAC	*CUBBA, NM FIX	11000
*10000 - MCA CUBBA, NM FIX , W BND		
CUBBA, NM FIX	ALBUQUERQUE, NM VORTAC	8600
ALBUQUERQUE, NM VORTAC	OTTO, NM VOR	10000
OTTO, NM VOR	FORT UNION, NM VORTAC	10000

**95.6062 VOR FEDERAL AIRWAY V62**

GALLUP, NM VORTAC	CABZO, NM FIX	11000
CABZO, NM FIX	ZIASE, NM FIX	10000
ZIASE, NM FIX	SANTA FE, NM VORTAC	9000
SANTA FE, NM VORTAC	ANTON CHICO, NM VORTAC	10000

FROM TO MEA

**95.6062 VOR FEDERAL AIRWAY V62 - CONTINUED**

ANTON CHICO, NM VORTAC	FLUTY, NM FIX	8000
FLUTY, NM FIX	TEXICO, TX VORTAC	6500
TEXICO, TX VORTAC	SPADE, TX FIX	5900
SPADE, TX FIX	LUBBOCK, TX VORTAC	5000
LUBBOCK, TX VORTAC	ROTAN, TX FIX	*6000
*5000 - MOCA		
ROTAN, TX FIX	ABILENE, TX VORTAC	
	SE BND	3700
	NW BND	6000

**95.6063 VOR FEDERAL AIRWAY V63**

RAZORBACK, AR VORTAC	BILIE, MO FIX	*4000
*3200 - MOCA		
BILIE, MO FIX	SPRINGFIELD, MO VORTAC	3000
SPRINGFIELD, MO VORTAC	PLADD, MO FIX	3000
PLADD, MO FIX	BARTI, MO FIX	*6000
*2600 - MOCA		
BARTI, MO FIX	HALLSVILLE, MO VORTAC	3100
HALLSVILLE, MO VORTAC	QUINCY, IL VORTAC	2900
QUINCY, IL VORTAC	BURLINGTON, IA VOR/DME	2600
BURLINGTON, IA VOR/DME	MOLINE, IL VOR/DME	3100
MOLINE, IL VOR/DME	DAVENPORT, IA VORTAC	3100
JANESVILLE, WI VOR/DME	*DEBOW, WI FIX	**4000
*10000 - MRA		
**3000 - GNSS MEA		
**JANESVILLE R-044 UNUSABLE, USE BADGER R-226		

DEBOW, WI FIX	RASTT, WI FIX	*4000
*4000 - GNSS MEA		
RASTT, WI FIX	BADGER, WI VOR/DME	*3000
*3000 - GNSS MEA		
BADGER, WI VOR/DME	OSHKOSH, WI VORTAC	3000
RHINELANDER, WI VOR/DME	HOUGHTON, MI VOR/DME	3600

**95.6064 VOR FEDERAL AIRWAY V64**

LOS ANGELES, CA VORTAC	LIMBO, CA FIX	3000
LIMBO, CA FIX	*WILMA, CA FIX	3200
*2800 - MCA WILMA, CA FIX , W BND		
WILMA, CA FIX	SEAL BEACH, CA VORTAC	2300
SEAL BEACH, CA VORTAC	*TUSTI, CA FIX	3000
*6200 - MCA TUSTI, CA FIX , E BND		
TUSTI, CA FIX	COREL, CA FIX	
	W BND	6200
	E BND	8000
COREL, CA FIX	PERIS, CA FIX	
	W BND	8000
	E BND	11000
PERIS, CA FIX	HEMET, CA FIX	*11000
*6700 - MOCA		
HEMET, CA FIX	HAPPE, CA FIX	*11000
*10200 - MOCA		
HAPPE, CA FIX	BALDI, CA FIX	10500
BALDI, CA FIX	CORLA, CA FIX	
	W BND	9700
	E BND	8000
CORLA, CA FIX	*THERMAL, CA VORTAC	
	W BND	8400
	E BND	6000
*7700 - MCA THERMAL, CA VORTAC , W BND		



FROM TO MEA

**95.6064 VOR FEDERAL AIRWAY V64 - CONTINUED**

THERMAL, CA VORTAC BLYTHE, CA VORTAC 7000

**95.6066 VOR FEDERAL AIRWAY V66**

MISSION BAY, CA VORTAC \*RYAHH, CA FIX  
E BND 7000  
W BND 4000

\*6400 - MCA RYAHH, CA FIX , E BND  
RYAHH, CA FIX BARET, CA FIX  
E BND \*8400  
W BND \*7000

\*6100 - MOCA  
BARET, CA FIX \*KUMBA, CA FIX 8400

\*6700 - MCA KUMBA, CA FIX , W BND  
KUMBA, CA FIX IMPERIAL, CA VORTAC 4300  
IMPERIAL, CA VORTAC BARD, CA VORTAC 3600  
BARD, CA VORTAC \*MOHAK, AZ FIX

W BND 4000  
E BND 6000

\*6000 - MCA MOHAK, AZ FIX , E BND  
MOHAK, AZ FIX \*JUDTH, AZ FIX \*\*6000

\*6000 - MCA JUDTH, AZ FIX , W BND  
\*\*4000 - MOCA  
JUDTH, AZ FIX

GILA BEND, AZ VORTAC GILA BEND, AZ VORTAC  
W BND 6000  
E BND 4000

FLIER, AZ FIX FLIER, AZ FIX 6500  
TUCSON, AZ VORTAC \*8000

\*6700 - MOCA  
TUCSON, AZ VORTAC \*SULLI, AZ FIX \*\*8000

\*9200 - MCA SULLI, AZ FIX , E BND  
\*\*7200 - MOCA

SULLI, AZ FIX DOUGLAS, AZ VORTAC 10000  
DOUGLAS, AZ VORTAC ANIMA, NM FIX \*11000

\*8700 - MOCA  
ANIMA, NM FIX DARCE, NM FIX 9000  
DARCE, NM FIX COLUMBUS, NM VOR/DME \*9000

\*8200 - MOCA

COLUMBUS, NM VOR/DME EL PASO, TX VORTAC 9000  
EL PASO, TX VORTAC HUDSPETH, TX VORTAC 7500

HUDSPETH, TX VORTAC PECOS, TX VOR/DME \*9000  
\*8000 - MOCA

PECOS, TX VOR/DME MIDLAND, TX VORTAC 5000  
MIDLAND, TX VORTAC BYPAS, TX FIX \*5000

\*4400 - MOCA  
BYPAS, TX FIX \*HYMAN, TX FIX \*\*6000

\*5000 - MRA  
\*\*4400 - MOCA  
HYMAN, TX FIX TYEES, TX FIX \*7000

\*4500 - MOCA  
TYEES, TX FIX ABILENE, TX VORTAC \*7000

\*4300 - MOCA  
ABILENE, TX VORTAC TRUSS, TX FIX 3500

TRUSS, TX FIX MILLSAP, TX VORTAC 3700

BROOKWOOD, AL VORTAC LAGRANGE, GA VORTAC 3400

SANDHILLS, NC VORTAC RALEIGH/DURHAM, NC VORTAC 2500

RALEIGH/DURHAM, NC VORTAC FRANKLIN, VA VORTAC 2600

**95.6067 VOR FEDERAL AIRWAY V67**

CHOO CHOO, TN VORTAC SHELBYVILLE, TN VOR/DME 4000

FROM TO MEA

**95.6067 VOR FEDERAL AIRWAY V67 - CONTINUED**

CORKI, IL FIX	VANDALIA, IL VOR/DME	2500
VANDALIA, IL VOR/DME	SPINNER, IL VORTAC	2500
SPINNER, IL VORTAC	BURLINGTON, IA VOR/DME	2500
BURLINGTON, IA VOR/DME	IOWA CITY, IA VOR/DME	*2600
*2100 - MOCA		
IOWA CITY, IA VOR/DME	CEDAR RAPIDS, IA VOR/DME	2700
CEDAR RAPIDS, IA VOR/DME	*LYERS, IA FIX	3300
*4000 - MRA		
LYERS, IA FIX	WATERLOO, IA VOR/DME	3300
WATERLOO, IA VOR/DME	FOYDE, IA FIX	3000
FOYDE, IA FIX	ROCHESTER, MN VOR/DME	3500

**95.6068 VOR FEDERAL AIRWAY V68**

MONTROSE, CO VOR/DME	CONES, CO VOR/DME	12000
CONES, CO VOR/DME	DOVE CREEK, CO VORTAC	12000
DOVE CREEK, CO VORTAC	CORTEZ, CO VOR/DME	9800
CORTEZ, CO VOR/DME	PLATA, NM FIX	10600
PLATA, NM FIX	RATTLESNAKE, NM VORTAC	10000
RATTLESNAKE, NM VORTAC	OTINS, NM FIX	9000
OTINS, NM FIX	PEDRA, NM FIX	*11500
*10000 - MOCA		
PEDRA, NM FIX	*ALBUQUERQUE, NM VORTAC	9000
*10000 - MCA ALBUQUERQUE, NM VORTAC , SE BND		
ALBUQUERQUE, NM VORTAC	CORONA, NM VORTAC	12000
CORONA, NM VORTAC	HONDS, NM FIX	9000
HONDS, NM FIX	CHISUM, NM VORTAC	
	NW BND	9000
	SE BND	6500
CHISUM, NM VORTAC	HAGER, NM FIX	
	W BND	6000
	E BND	6500
HAGER, NM FIX	HOBBS, NM VORTAC	6500
HOBBS, NM VORTAC	ANEEL, TX FIX	5200
ANEEL, TX FIX	MIDLAND, TX VORTAC	5000
MIDLAND, TX VORTAC	JOKES, TX FIX	4500
JOKES, TX FIX	STEEP, TX FIX	*5000
*4200 - MOCA		
STEEP, TX FIX	TANKR, TX FIX	4400
TANKR, TX FIX	SAN ANGELO, TX VORTAC	3700
SAN ANGELO, TX VORTAC	JUNCTION, TX VORTAC	4000
JUNCTION, TX VORTAC	CENTER POINT, TX VORTAC	4000
CENTER POINT, TX VORTAC	SAN ANTONIO, TX VORTAC	4100
SAN ANTONIO, TX VORTAC	*BRAUN, TX FIX	3100
*5500 - MRA		
BRAUN, TX FIX	MARCS, TX FIX	3100
MARCS, TX FIX	CRAYS, TX FIX	*2900
*2000 - MOCA		
CRAYS, TX FIX	INDUSTRY, TX VORTAC	2600

**95.6069 VOR FEDERAL AIRWAY V69**

EL DORADO, AR VOR/DME	PINE BLUFF, AR VOR/DME	2000
PINE BLUFF, AR VOR/DME	BILLI, AR FIX	2000
BILLI, AR FIX	*HILLE, AR FIX	**6000
*6000 - MRA		
**1500 - MOCA		
HILLE, AR FIX	WALNUT RIDGE, AR VORTAC	*4000
*3000 - MOCA		

FROM TO MEA

**95.6069 VOR FEDERAL AIRWAY V69 - CONTINUED**

WALNUT RIDGE, AR VORTAC	FARMINGTON, MO VORTAC	3000
FARMINGTON, MO VORTAC	TROY, IL VORTAC	*3000
*2500 - MOCA		
TROY, IL VORTAC	SPINNER, IL VORTAC	2500
SPINNER, IL VORTAC	PONTIAC, IL VOR/DME	*3000
*2300 - MOCA		
PONTIAC, IL VOR/DME	JOLIET, IL VOR/DME	*3000
*2300 - MOCA		

**95.6070 VOR FEDERAL AIRWAY V70**

U.S. MEXICAN BORDER	BROWNSVILLE, TX VORTAC	*5000
*1600 - MOCA		
BROWNSVILLE, TX VORTAC	RAYMO, TX FIX	
	N BND	*3800
	S BND	*1600
*1600 - GNSS MEA		
RAYMO, TX FIX	JIMIE, TX FIX	
	N BND	*6000
	S BND	*4000
*1600 - MOCA		
*2000 - GNSS MEA		
JIMIE, TX FIX	JETTY, TX FIX	*6000
*1800 - MOCA		
*2000 - GNSS MEA		
JETTY, TX FIX	CORPUS CHRISTI, TX VORTAC	
	N BND	*2100
	S BND	*3800
*2100 - GNSS MEA		
CORPUS CHRISTI, TX VORTAC	BETZY, TX FIX	1800
BETZY, TX FIX	PALACIOS, TX VORTAC	2000
PALACIOS, TX VORTAC	SCHOLES, TX VOR/DME	2600
SCHOLES, TX VOR/DME	SABINE PASS, TX VOR/DME	2000
SABINE PASS, TX VOR/DME	LAKE CHARLES, LA VORTAC	1700
LAKE CHARLES, LA VORTAC	LAFAYETTE, LA VORTAC	1800
LAFAYETTE, LA VORTAC	*ROSEY, LA FIX	2100
*5000 - MRA		
ROSEY, LA FIX	FIGHTING TIGER, LA VORTAC	2100
FIGHTING TIGER, LA VORTAC	PICAYUNE, MS VOR/DME	2000
PICAYUNE, MS VOR/DME	GREENE COUNTY, MS VORTAC	2000
GREENE COUNTY, MS VORTAC	MONROEVILLE, AL VORTAC	2000
MONROEVILLE, AL VORTAC	CHAFF, AL FIX	2000
CHAFF, AL FIX	*RUTEL, AL FIX	**2500
*4500 - MCA RUTEL, AL FIX , NE BND		
**1800 - MOCA		
RUTEL, AL FIX	*CRENS, AL FIX	**4500
*4500 - MCA CRENS, AL FIX , SW BND		
**1800 - MOCA		
CRENS, AL FIX	BANBI, AL FIX	2400
BANBI, AL FIX	EUFULA, AL VORTAC	2400
EUFULA, AL VORTAC	VIENNA, GA VORTAC	2400
VIENNA, GA VORTAC	OCONE, GA FIX	*3000
*2100 - MOCA		
OCONE, GA FIX	MILEN, GA FIX	*3000
		MAA - 9000
*1900 - MOCA		
MILEN, GA FIX	ALLENDALE, SC VOR	*3000
*1800 - MOCA		
GRAND STRAND, SC VORTAC	WILMINGTON, NC VORTAC	UNUSABLE

FROM TO MEA

**95.6070 VOR FEDERAL AIRWAY V70 - CONTINUED**

WILMINGTON, NC VORTAC	BEULA, NC FIX	UNUSABLE
BEULA, NC FIX	KINSTON, NC VORTAC	UNUSABLE
KINSTON, NC VORTAC	PEARS, NC FIX	UNUSABLE
PEARS, NC FIX	COFIELD, NC VORTAC	*3000
*2000 - MOCA		

**95.6071 VOR FEDERAL AIRWAY V71**

FIGHTING TIGER, LA VORTAC	WRACK, LA FIX	*2200
*1800 - MOCA		
WRACK, LA FIX	NATCHEZ, MS VOR/DME	*3500
*2200 - MOCA		
*2200 - GNSS MEA		
NATCHEZ, MS VOR/DME	MONROE, LA VORTAC	2000
MONROE, LA VORTAC	EL DORADO, AR VOR/DME	2200
EL DORADO, AR VOR/DME	SPARO, AR FIX	
	S BND	*2500
	N BND	*4000
*1800 - MOCA		
SPARO, AR FIX	CANEY, AR FIX	*4000
*1700 - MOCA		
CANEY, AR FIX	HOT SPRINGS, AR VOR/DME	
	N BND	3000
	S BND	3500
HOT SPRINGS, AR VOR/DME	OLLAS, AR FIX	*3600
*3100 - MOCA		
OLLAS, AR FIX	*HAAWK, AR FIX	**4500
*10000 - MCA HAAWK, AR FIX , N BND		
**2500 - MOCA		
HAAWK, AR FIX	HARRISON, AR VOR/DME	*10000
*3700 - MOCA		
*4000 - GNSS MEA		
HARRISON, AR VOR/DME	REEDS, MO FIX	3300
REEDS, MO FIX	SPRINGFIELD, MO VORTAC	3000
SPRINGFIELD, MO VORTAC	BUTLER, MO VORTAC	*3000
*2500 - MOCA		
BUTLER, MO VORTAC	TOPEKA, KS VORTAC	3100
TOPEKA, KS VORTAC	PAWNEE CITY, NE VORTAC	*4000
*2900 - MOCA		
PAWNEE CITY, NE VORTAC	LINCOLN, NE VORTAC	3000
LINCOLN, NE VORTAC	DWELL, NE FIX	*3300
*2600 - MOCA		
DWELL, NE FIX	COLUMBUS, NE VOR/DME	*3500
*3000 - MOCA		
COLUMBUS, NE VOR/DME	O'NEILL, NE VORTAC	4000
PIERRE, SD VORTAC	LINTN, ND FIX	*5500
*3600 - MOCA		
LINTN, ND FIX	BISMARCK, ND VOR/DME	
	S BND	5500
	N BND	3600
BISMARCK, ND VOR/DME	CENTR, ND FIX	
	W BND	5600
	E BND	4000
CENTR, ND FIX	WILLISTON, ND VOR/DME	*5600
*3900 - MOCA		

**95.6072 VOR FEDERAL AIRWAY V72**

RAZORBACK, AR VORTAC	EDUGE, AR FIX	*4000
*3200 - MOCA		

FROM	TO	MEA
------	----	-----

**95.6072 VOR FEDERAL AIRWAY V72 - CONTINUED**

EDUGE, AR FIX *2900 - MOCA	REEDS, MO FIX	*4000
REEDS, MO FIX *2900 - MOCA	DOGWOOD, MO VORTAC	*3400
FARMINGTON, MO VORTAC *2500 - MOCA	CENTRALIA, IL VORTAC	*3000
CENTRALIA, IL VORTAC	BIBLE GROVE, IL VORTAC	2600

**95.6073 VOR FEDERAL AIRWAY V73**

TULSA, OK VORTAC	FRAKS, OK FIX	3000
FRAKS, OK FIX	WICHITA, KS VORTAC	4000
WICHITA, KS VORTAC	HUTCHINSON, KS VOR/DME	3600
HUTCHINSON, KS VOR/DME	SALINA, KS VORTAC	3400

**95.6074 VOR FEDERAL AIRWAY V74**

GARDEN CITY, KS VORTAC	DODGE CITY, KS VORTAC	4600
PIONEER, OK VORTAC	MANON, OK FIX	2700
MANON, OK FIX	TULSA, OK VORTAC	2500
TULSA, OK VORTAC	OWETA, OK FIX	3200
OWETA, OK FIX *1900 - MOCA	MALTS, OK FIX	*2800
MALTS, OK FIX	FORT SMITH, AR VORTAC	3000
FORT SMITH, AR VORTAC	MAGGA, AR FIX E BND	4500
	W BND	4000
MAGGA, AR FIX *4000 - MOCA	DANIL, AR FIX	*4500
DANIL, AR FIX *2600 - MOCA	OLLAS, AR FIX	*4500
OLLAS, AR FIX *2700 - MOCA	MAUME, AR FIX	*4500
MAUME, AR FIX	LITTLE ROCK, AR VORTAC	3500
LITTLE ROCK, AR VORTAC	PINE BLUFF, AR VOR/DME	2500
PINE BLUFF, AR VOR/DME	GREENVILLE, MS VOR/DME	2000
GREENVILLE, MS VOR/DME	MAGNOLIA, MS VORTAC	2000

**95.6075 VOR FEDERAL AIRWAY V75**

MORGANTOWN, WV VOR/DME	BELLAIRE, OH VOR/DME	4000
BELLAIRE, OH VOR/DME *3000 - MOCA	ATWOO, OH FIX	*6000
ATWOO, OH FIX *3100 - MOCA *3100 - GNSS MEA	BRIGGS, OH VOR/DME	*4000

**95.6076 VOR FEDERAL AIRWAY V76**

LUBBOCK, TX VORTAC *7000 - MRA	*WELCH, TX FIX	5200
WELCH, TX FIX *5200 - MOCA	PATTS, TX FIX	*6100
PATTS, TX FIX	BIG SPRING, TX VORTAC	4700
BIG SPRING, TX VORTAC *5000 - MRA	*HYMAN, TX FIX	4500
HYMAN, TX FIX *7000 - MRA	*WATOR, TX FIX	4500
WATOR, TX FIX	SAN ANGELO, TX VORTAC	4500

FROM TO MEA

**95.6076 VOR FEDERAL AIRWAY V76 - CONTINUED**

SAN ANGELO, TX VORTAC	EVILE, TX FIX	3700
EVILE, TX FIX	BREDY, TX FIX	3800
BREDY, TX FIX	LLANO, TX VORTAC	3500
LLANO, TX VORTAC	CENTEX, TX VORTAC	3200
CENTEX, TX VORTAC	MOUZE, TX FIX	2200
MOUZE, TX FIX	INDUSTRY, TX VORTAC	2100

**95.6077 VOR FEDERAL AIRWAY V77**

SAN ANGELO, TX VORTAC	ABILENE, TX VORTAC	4000
ABILENE, TX VORTAC	WICHITA FALLS, TX VORTAC	*3900
*3400 - MOCA		
WICHITA FALLS, TX VORTAC	FOYER, OK FIX	2900
FOYER, OK FIX	*FLECH, OK FIX	3000
*4900 - MRA		
FLECH, OK FIX	*NEADS, OK FIX	**3800
*5400 - MRA		
*3800 - MCA NEADS, OK FIX , S BND		
**3000 - MOCA		
NEADS, OK FIX	WILL ROGERS, OK VORTAC	3000
WILL ROGERS, OK VORTAC	PIONEER, OK VORTAC	*4000
*3200 - MOCA		
PIONEER, OK VORTAC	WICHITA, KS VORTAC	3600
WICHITA, KS VORTAC	*FLOSS, KS FIX	3600
*5000 - MRA		
FLOSS, KS FIX	HEYDN, KS FIX	*5000
*2900 - MOCA		
HEYDN, KS FIX	TOPEKA, KS VORTAC	3700
TOPEKA, KS VORTAC	ST JOSEPH, MO VORTAC	3000
ST JOSEPH, MO VORTAC	LAMONI, IA VOR/DME	2900
LAMONI, IA VOR/DME	*WIVEY, IA FIX	3000
*4300 - MRA		
WIVEY, IA FIX	DES MOINES, IA VORTAC	3000
DES MOINES, IA VORTAC	*MIXIN, IA FIX	3100
*5000 - MRA		
MIXIN, IA FIX	NEWTON, IA VOR/DME	3000
NEWTON, IA VOR/DME	WATERLOO, IA VOR/DME	2800

**95.6078 VOR FEDERAL AIRWAY V78**

DARWIN, MN VORTAC	GOPHER, MN VORTAC	3000
GOPHER, MN VORTAC	EAU CLAIRE, WI VORTAC	3400
EAU CLAIRE, WI VORTAC	RHINELANDER, WI VOR/DME	3700
RHINELANDER, WI VOR/DME	IRON MOUNTAIN, MI VOR/DME	4400
IRON MOUNTAIN, MI VOR/DME	VUKFI, MI FIX	3300
VUKFI, MI FIX	ESCANABA, MI VOR/DME	*3000
*2300 - MOCA		
PELLSTON, MI VORTAC	ALPENA, MI VORTAC	2700
ALPENA, MI VORTAC	*ZABLE, MI FIX	3000
*5000 - MCA ZABLE, MI FIX , S BND		
ZABLE, MI FIX	BANJO, MI FIX	*5000
*2900 - MOCA		
BANJO, MI FIX	BENNY, MI FIX	*3000
*2300 - MOCA		
BENNY, MI FIX	SAGINAW, MI VOR/DME	2400

**95.6079 VOR FEDERAL AIRWAY V79**

HASTINGS, NE VOR/DME	LINCOLN, NE VORTAC	4000
----------------------	--------------------	------

FROM	TO	MEA
<b>95.6080 VOR FEDERAL AIRWAY V80</b>		
AKRON, CO VOR/DME	HOLYO, CO FIX	6400
HOLYO, CO FIX	NORTH PLATTE, NE VOR/DME	*6500
*5000 - MOCA		
NORTH PLATTE, NE VOR/DME	O'NEILL, NE VORTAC	*5400
*4400 - MOCA		
O'NEILL, NE VORTAC	TYNDA, SD FIX	*4000
*3500 - MOCA		
TYNDA, SD FIX	DOLTS, SD FIX	*4000
*3200 - MOCA		
DOLTS, SD FIX	SIoux FALLS, SD VORTAC	3400
<b>95.6081 VOR FEDERAL AIRWAY V81</b>		
U.S. MEXICAN BORDER	MARFA, TX VOR/DME	10000
MARFA, TX VOR/DME	FORT STOCKTON, TX VORTAC	9000
FORT STOCKTON, TX VORTAC	MIDLAND, TX VORTAC	4500
MIDLAND, TX VORTAC	PATTS, TX FIX	4500
PATTS, TX FIX	*WELCH, TX FIX	**6100
*7000 - MRA		
**5200 - MOCA		
WELCH, TX FIX	LUBBOCK, TX VORTAC	5200
LUBBOCK, TX VORTAC	PLAINVIEW, TX VOR/DME	5000
PLAINVIEW, TX VOR/DME	*YOCAN, TX FIX	**5400
*6500 - MRA		
**4900 - MOCA		
YOCAN, TX FIX	PANHANDLE, TX VORTAC	5400
PANHANDLE, TX VORTAC	DALHART, TX VORTAC	6100
DALHART, TX VORTAC	TOBE, CO VOR/DME	8800
TOBE, CO VOR/DME	PUEBLO, CO VORTAC	7700
PUEBLO, CO VORTAC	*BLACK FOREST, CO VOR/DME	9500
*10000 - MCA BLACK FOREST, CO VOR/DME , NW BND		
BLACK FOREST, CO VOR/DME	HOHUM, CO FIX	*10000
*10000 - GNSS MEA		
*BLACK FOREST R-330 UNUSABLE		
HOHUM, CO FIX	SIGNE, CO FIX	9200
SIGNE, CO FIX	JEFFCO, CO VOR/DME	*9200
*8600 - MOCA		
JEFFCO, CO VOR/DME	WISER, CO FIX	8000
WISER, CO FIX	CHEYENNE, WY VORTAC	9000
CHEYENNE, WY VORTAC	SCOTTSBLUFF, NE VORTAC	8000
SCOTTSBLUFF, NE VORTAC	TOADSTOOL, NE VOR/DME	7000
<b>95.6082 VOR FEDERAL AIRWAY V82</b>		
GOPHER, MN VORTAC	FARMINGTON, MN VORTAC	*3500
*2800 - MOCA		
FARMINGTON, MN VORTAC	ROCHESTER, MN VOR/DME	3000
ROCHESTER, MN VOR/DME	NODINE, MN VORTAC	3000
NODINE, MN VORTAC	DELLS, WI VORTAC	3000
<b>95.6083 VOR FEDERAL AIRWAY V83</b>		
CARLSBAD, NM VORTAC	*NELON, NM FIX	5900
*7000 - MRA		
NELON, NM FIX	CHISUM, NM VORTAC	5900
CHISUM, NM VORTAC	HONDS, NM FIX	
	NW BND	9000
	SE BND	6500

FROM TO MEA

**95.6083 VOR FEDERAL AIRWAY V83 - CONTINUED**

HONDS, NM FIX	CORONA, NM VORTAC	9000
CORONA, NM VORTAC	OTTO, NM VOR	9000
OTTO, NM VOR	LACRO, NM FIX	9000
LACRO, NM FIX	SANTA FE, NM VORTAC	9000
SANTA FE, NM VORTAC	NAMBE, NM FIX	
	N BND	11000
	S BND	9000
NAMBE, NM FIX	TAOS, NM VORTAC	11000
TAOS, NM VORTAC	*ALAMOSA, CO VORTAC	11600
*10400 - MCA ALAMOSA, CO VORTAC , S BND		
ALAMOSA, CO VORTAC	BLOKE, CO FIX	
	E BND	14000
	W BND	10400
BLOKE, CO FIX	*GOSIP, CO FIX	14000
*14000 - MCA GOSIP, CO FIX , SW BND		
GOSIP, CO FIX	PUEBLO, CO VORTAC	8700
PUEBLO, CO VORTAC	DRAKE, CO FIX	7600
DRAKE, CO FIX	BLACK FOREST, CO VOR/DME	9000

**95.6084 VOR FEDERAL AIRWAY V84**

NORTHBROOK, IL VOR/DME	*KUBBS, IL FIX	**3000
*4000 - MRA		
**2000 - MOCA		
KUBBS, IL FIX	*STORY, IL FIX	**3000
*3500 - MRA		
**2000 - MOCA		
STORY, IL FIX	PIVOT, IL FIX	*3000
*2000 - MOCA		
PIVOT, IL FIX	JYBEE, MI FIX	*4000
*1900 - MOCA		
JYBEE, MI FIX	PULLMAN, MI VOR/DME	*4000
*2200 - MOCA		
GENESE0, NY VOR/DME	BEEPS, NY FIX	*4000
*3300 - MOCA		
BEEPS, NY FIX	SYRACUSE, NY VORTAC	*3500
*2600 - MOCA		

**95.6085 VOR FEDERAL AIRWAY V85**

FALCON, CO VORTAC	HYGEN, CO FIX	
	SE BND	9400
	NW BND	16000
HYGEN, CO FIX	LARAMIE, WY VOR/DME	16000
LARAMIE, WY VOR/DME	MEDICINE BOW, WY VOR/DME	9400
MEDICINE BOW, WY VOR/DME	MULTI, WY FIX	10800
MULTI, WY FIX	MUDDY MOUNTAIN, WY VOR/DME	
	N BND	8000
	S BND	10800
MUDDY MOUNTAIN, WY VOR/DME	RIVERTON, WY VOR/DME	8500
RIVERTON, WY VOR/DME	BOYSEN RESERVOIR, WY VOR/DME	9600
BOYSEN RESERVOIR, WY VOR/DME	CODY, WY VOR/DME	9600
CODY, WY VOR/DME	EDDAR, MT FIX	8400
EDDAR, MT FIX	BILLINGS, MT VORTAC	
	S BND	8400
	N BND	7000

**95.6086 VOR FEDERAL AIRWAY V86**

MISSOULA, MT VOR/DME	COPPERTOWN, MT VOR/DME	*13000
*11300 - MOCA		
*12000 - GNSS MEA		



FROM TO MEA

**95.6086 VOR FEDERAL AIRWAY V86 - CONTINUED**

COPPERTOWN, MT VOR/DME	*WHITEHALL, MT VOR/DME	10500
*9100 - MCA WHITEHALL, MT VOR/DME , W BND		
WHITEHALL, MT VOR/DME	*BOZEMAN, MT VOR/DME	8500
*10200 - MCA BOZEMAN, MT VOR/DME , SE BND		
BOZEMAN, MT VOR/DME	LIVINGSTON, MT VOR/DME	10900
LIVINGSTON, MT VOR/DME	REEPO, MT FIX	9700
REEPO, MT FIX	COLUS, MT FIX	
	W BND	9700
	E BND	7000
COLUS, MT FIX	BILLINGS, MT VORTAC	
	W BND	9700
	E BND	6400
BILLINGS, MT VORTAC	KRONA, MT FIX	
	NW BND	6200
	SE BND	8000
KRONA, MT FIX	SHERIDAN, WY VOR/DME	8000
SHERIDAN, WY VOR/DME	WETON, WY FIX	*10900
*7000 - MOCA		
*7000 - GNSS MEA		
*MEA IS ESTABLISHED WITH A GAP IN NAVIGATION SIGNAL COVERAGE		
WETON, WY FIX	*KOCYE, WY FIX	**13000
*15000 - MRA		
**7000 - MOCA		
**7000 - GNSS MEA		
KOCYE, WY FIX	KARAS, WY FIX	*13000
*8600 - MOCA		
*9000 - GNSS MEA		
KARAS, WY FIX	*PACTO, SD FIX	**11100
*9700 - MRA		
**9400 - MOCA		
**10000 - GNSS MEA		
PACTO, SD FIX	RAPID CITY, SD VORTAC	
	E BND	*8000
	W BND	*9700
*7100 - MOCA		

**95.6087 VOR FEDERAL AIRWAY V87**

PANOCHÉ, CA VORTAC	SALINAS, CA VORTAC	6200
SALINAS, CA VORTAC	SANTY, CA FIX	*5000
*4000 - MOCA		
SANTY, CA FIX	WOODSIDE, CA VOR/DME	5100
WOODSIDE, CA VOR/DME	SAN FRANCISCO, CA VOR/DME	4700
SAN FRANCISCO, CA VOR/DME	SCAGGS ISLAND, CA VORTAC	4000

**95.6088 VOR FEDERAL AIRWAY V88**

TULSA, OK VORTAC	*VINTA, OK FIX	2700
*6200 - MCA VINTA, OK FIX , NE BND		
VINTA, OK FIX	SPRINGFIELD, MO VORTAC	*6200
*3100 - MOCA		
*4000 - GNSS MEA		
SPRINGFIELD, MO VORTAC	VICHY, MO VOR/DME	3100
VICHY, MO VOR/DME	STEER, MO FIX	*3000
*2300 - MOCA		
STEER, MO FIX	TROY, IL VORTAC	2700

**95.6089 VOR FEDERAL AIRWAY V89**

GILL, CO VOR/DME	HAMER, WY FIX	8000
------------------	---------------	------

FROM TO MEA

**95.6089 VOR FEDERAL AIRWAY V89 - CONTINUED**

HAMER, WY FIX	CHEYENNE, WY VORTAC	8500
CHEYENNE, WY VORTAC	LITER, WY FIX	8300
LITER, WY FIX	TOADSTOOL, NE VOR/DME	7800

**95.6091 VOR FEDERAL AIRWAY V91**

SARDI, NY FIX	CALVERTON, NY VOR/DME	*2500
*1900 - MOCA		
CALVERTON, NY VOR/DME	NESSI, CT FIX	2000
NESSI, CT FIX	*BRIDGEPORT, CT VOR/DME	2000
*8800 - MCA BRIDGEPORT, CT VOR/DME , N BND		
BRIDGEPORT, CT VOR/DME	*MOONI, CT FIX	
	N BND	**12000
	S BND	**6000
*12000 - MCA MOONI, CT FIX , N BND		
*6000 - MCA MOONI, CT FIX , S BND		
**5500 - MOCA		
**6000 - GNSS MEA		
MOONI, CT FIX	*BOWAN, NY FIX	**12000
*12000 - MCA BOWAN, NY FIX , S BND		
*12000 - MCA BOWAN, NY FIX , N BND		
**4900 - MOCA		
**6000 - GNSS MEA		
BOWAN, NY FIX	CIRRU, NY FIX	*12000
*4900 - MOCA		
*6000 - GNSS MEA		
CIRRU, NY FIX	*ALBANY, NY VORTAC	
	N BND	**6000
	S BND	**12000
*9700 - MCA ALBANY, NY VORTAC , BND		
**6000 - GNSS MEA		

**95.6092 VOR FEDERAL AIRWAY V92**

CHICAGO HEIGHTS, IL VORTAC	HALIE, IN FIX	2600
HALIE, IN FIX	INKEN, IN FIX	*4000
*2300 - MOCA		
INKEN, IN FIX	GOSHEN, IN VORTAC	2600

**95.6093 VOR FEDERAL AIRWAY V93**

PATUXENT, MD VORTAC	*GRACO, MD FIX	**2500
*10000 - MRA		
**1700 - MOCA		
GRACO, MD FIX	PALEO, MD FIX	*10000
*1600 - MOCA		
PALEO, MD FIX	BALTIMORE, MD VORTAC	*2200
*1700 - MOCA		
BALTIMORE, MD VORTAC	VINNY, PA FIX	3000
VINNY, PA FIX	*ROAST, PA FIX	**9000
*10000 - MRA		
**4500 - GNSS MEA		
ROAST, PA FIX	LANCASTER, PA VOR/DME	
	SW BND	*9000
	NE BND	*4500
*2600 - MOCA		
*4500 - GNSS MEA		
LANCASTER, PA VOR/DME	HAILS, PA FIX	3400
HAILS, PA FIX	SNOWY, PA FIX	4000

FROM TO MEA

**95.6093 VOR FEDERAL AIRWAY V93 - CONTINUED**

SNOWY, PA FIX	LYTEL, PA FIX	4000
LYTEL, PA FIX	WILKES-BARRE, PA VORTAC	4000
WILKES-BARRE, PA VORTAC	LAAYK, PA FIX	
	NE BND	*5000
	SW BND	*4000
*4000 - MOCA		
HELON, NY FIX	KINGSTON, NY VOR/DME	4000
KINGSTON, NY VOR/DME	PAWLING, NY VOR/DME	3000
PAWLING, NY VOR/DME	CHESTER, MA VOR/DME	4000

**95.6094 VOR FEDERAL AIRWAY V94**

BLYTHE, CA VORTAC	*VICKO, AZ FIX	6000
*9000 - MRA		
VICKO, AZ FIX	GILA BEND, AZ VORTAC	*9000
*5200 - MOCA		
GILA BEND, AZ VORTAC	*POTER, AZ FIX	5000
*8000 - MRA		
POTER, AZ FIX	STANFIELD, AZ VORTAC	5000
STANFIELD, AZ VORTAC	*TOTEC, AZ FIX	**5000
*5500 - MCA TOTEC, AZ FIX , E BND		
**4300 - MOCA		
TOTEC, AZ FIX	CROME, AZ FIX	
	E BND	8000
	W BND	6500
CROME, AZ FIX	SAN SIMON, AZ VORTAC	10000
SAN SIMON, AZ VORTAC	DEMING, NM VORTAC	*9000
*8100 - MOCA		
DEMING, NM VORTAC	*MOLLY, NM FIX	**9000
*10000 - MRA		
**7700 - MOCA		
MOLLY, NM FIX	NEWMAN, TX VORTAC	9000
NEWMAN, TX VORTAC	SALT FLAT, TX VORTAC	8800
SALT FLAT, TX VORTAC	DILLI, TX FIX	8000
DILLI, TX FIX	CAVRN, TX FIX	*10000
*7500 - MOCA		
CAVRN, TX FIX	WINK, TX VORTAC	*10000
*5300 - MOCA		
WINK, TX VORTAC	YOGSU, TX FIX	5500
YOGSU, TX FIX	MIDLAND, TX VORTAC	5000
MIDLAND, TX VORTAC	BYPAS, TX FIX	*5000
*4400 - MOCA		
BYPAS, TX FIX	*HYMAN, TX FIX	**6000
*5000 - MRA		
**4400 - MOCA		
HYMAN, TX FIX	TUSCOLA, TX VOR/DME	*7500
*4200 - MOCA		
CEDAR CREEK, TX VORTAC	GREGG COUNTY, TX VORTAC	2500
GREGG COUNTY, TX VORTAC	ELM GROVE, LA VORTAC	2000
ELM GROVE, LA VORTAC	*WETER, LA FIX	2400
*3000 - MRA		
WETER, LA FIX	MONROE, LA VORTAC	*2400
*1800 - MOCA		
MONROE, LA VORTAC	GREENVILLE, MS VOR/DME	2100
GREENVILLE, MS VOR/DME	HOLLY SPRINGS, MS VORTAC	*3000
*2100 - MOCA		

**95.6095 VOR FEDERAL AIRWAY V95**

GILA BEND, AZ VORTAC	*POTER, AZ FIX	5000
*8000 - MRA		

FROM	TO	MEA
------	----	-----

**95.6095 VOR FEDERAL AIRWAY V95 - CONTINUED**

POTER, AZ FIX	PHOENIX, AZ VORTAC	8000
PHOENIX, AZ VORTAC	WINSLOW, AZ VORTAC	10000
WINSLOW, AZ VORTAC	*BUTTE, AZ FIX	
	NE BND	11000
	SW BND	8700
*9600 - MRA		
BUTTE, AZ FIX	CASTI, AZ FIX	
	NE BND	11000
	SW BND	8700
CASTI, AZ FIX	DERMA, NM FIX	*13000
*11400 - MOCA		
DERMA, NM FIX	RATTLESNAKE, NM VORTAC	
	E BND	8300
	W BND	13000
RATTLESNAKE, NM VORTAC	*DURANGO, CO VOR/DME	9700
*13200 - MCA DURANGO, CO VOR/DME , N BND		
DURANGO, CO VOR/DME	ZEANS, CO FIX	
	S BND	12300
	N BND	16500
ZEANS, CO FIX	LAZON, CO FIX	16500
LAZON, CO FIX	POWES, CO FIX	
	N BND	15000
	S BND	16500
POWES, CO FIX	BLUE MESA, CO VOR/DME	
	S BND	16500
	N BND	12800
BLUE MESA, CO VOR/DME	ROMLY, CO FIX	
	E BND	17000
	W BND	12000
ROMLY, CO FIX	*HOHUM, CO FIX	**17000
*13100 - MCA HOHUM, CO FIX , S BND		
**16200 - MOCA		
HOHUM, CO FIX	FALCON, CO VORTAC	9000

**95.6096 VOR FEDERAL AIRWAY V96**

BRICKYARD, IN VORTAC	KOKOMO, IN VORTAC	2700
KOKOMO, IN VORTAC	FORT WAYNE, IN VORTAC	2600
FORT WAYNE, IN VORTAC	*TWERP, OH FIX	**5000
*5000 - MRA		
**2400 - MOCA		

**95.6097 VOR FEDERAL AIRWAY V97**

DOLPHIN, FL VORTAC	LA BELLE, FL VORTAC	*3000
*1500 - MOCA		
LA BELLE, FL VORTAC	ROGAN, FL FIX	
	SE BND	*2000
	NW BND	*4000
*2000 - GNSS MEA		
ROGAN, FL FIX	*BRDGE, FL FIX	**5000
*4300 - MCA BRDGE, FL FIX , SE BND		
**1400 - MOCA		
**2000 - GNSS MEA		
BRDGE, FL FIX	*ST PETERSBURG, FL VORTAC	2000
*3600 - MCA ST PETERSBURG, FL VORTAC , NW BND		
ST PETERSBURG, FL VORTAC	DARBS, FL FIX	
	SE BND	*2100
	NW BND	*6000
*2100 - GNSS MEA		

FROM TO MEA

**95.6097 VOR FEDERAL AIRWAY V97 - CONTINUED**

DARBS, FL FIX *1400 - MOCA *4000 - GNSS MEA	PLYER, FL FIX	*8000
PLYER, FL FIX *1400 - MOCA *4000 - GNSS MEA	CLAMP, FL FIX	*8000
CLAMP, FL FIX  *1400 - MOCA *4000 - GNSS MEA	HEVVN, FL FIX NW BND SE BND	*6000 *8000
HEVVN, FL FIX  *1400 - MOCA *2000 - GNSS MEA	ADDAX, FL FIX NW BND SE BND	*3000 *6000
ADDAX, FL FIX  *2000 - GNSS MEA	SEMINOLE, FL VORTAC NW BND SE BND	*2000 *5000
SEMINOLE, FL VORTAC PECAN, GA VOR/DME *1900 - MOCA	PECAN, GA VOR/DME AMAPO, GA FIX	2100 *2300
AMAPO, GA FIX *3000 - MRA *4000 - MCA PRATZ, GA FIX , N BND **2300 - MOCA	*PRATZ, GA FIX	**3000
NELLO, GA FIX *6300 - GNSS MEA	MELLS, GA FIX	*10000
MELLS, GA FIX *6600 - MCA HINDE, TN FIX , S BND	*HINDE, TN FIX	7400
HINDE, TN FIX TALLA, TN FIX VOLUNTEER, TN VORTAC NOISE, TN FIX *4200 - MOCA	TALLA, TN FIX VOLUNTEER, TN VORTAC NOISE, TN FIX LONDON, KY VOR/DME	6600 4200 3800 *5000
LONDON, KY VOR/DME *2900 - MOCA	REBEL, KY FIX	*3400
REBEL, KY FIX LEXINGTON, KY VOR/DME DARKS, KY FIX CINCINNATI, KY VORTAC SHELBYVILLE, IN VOR/DME *4700 - MCA OCKEL, IN FIX , SE BND **2900 - MOCA	LEXINGTON, KY VOR/DME DARKS, KY FIX CINCINNATI, KY VORTAC SHELBYVILLE, IN VOR/DME *OCKEL, IN FIX	2800 3000 2700 2800 **5000
OCKEL, IN FIX BOILER, IN VORTAC CHICAGO HEIGHTS, IL VORTAC NODINE, MN VORTAC PEGGS, MN FIX	BOILER, IN VORTAC CHICAGO HEIGHTS, IL VORTAC NILES, IL FIX PEGGS, MN FIX GOPHER, MN VORTAC	2600 2800 3500 3000 3400

**95.6099 VOR FEDERAL AIRWAY V99**

LA GUARDIA, NY VOR/DME *1700 - MOCA	OUTTE, CT FIX	*4000
OUTTE, CT FIX *2600 - MOCA	SORRY, CT FIX	*4000
SORRY, CT FIX	HARTFORD, CT VOR/DME	3000

**95.6100 VOR FEDERAL AIRWAY V100**

MEDICINE BOW, WY VOR/DME	SCOTTSBLUFF, NE VORTAC	9500
--------------------------	------------------------	------

FROM TO MEA

**95.6100 VOR FEDERAL AIRWAY V100 - CONTINUED**

SCOTTSBLUFF, NE VORTAC	ALLIANCE, NE VOR/DME	6300
ALLIANCE, NE VOR/DME	AINSWORTH, NE VOR/DME	*7500
*5600 - MOCA		
AINSWORTH, NE VOR/DME	O'NEILL, NE VORTAC	4500
WATERLOO, IA VOR/DME	DUBUQUE, IA VORTAC	2900
NORTHBROOK, IL VOR/DME	*MINCE, MI FIX	2500
*3500 - MRA		
MINCE, MI FIX	MUSKY, MI FIX	2500
MUSKY, MI FIX	KEELER, MI VOR/DME	2400
KEELER, MI VOR/DME	LITCHFIELD, MI VOR/DME	2600

**95.6101 VOR FEDERAL AIRWAY V101**

GILL, CO VOR/DME	*LIBEL, CO FIX	**10000
*13500 - MCA LIBEL, CO FIX , W BND		
**8900 - MOCA		
LIBEL, CO FIX	BROCC, CO FIX	16000
BROCC, CO FIX	ECHOA, CO FIX	13200
ECHOA, CO FIX	*HAYDEN, CO VOR/DME	
	E BND	13200
	W BND	11500
*11500 - MCA HAYDEN, CO VOR/DME , E BND		
HAYDEN, CO VOR/DME	STRIM, CO FIX	10000
STRIM, CO FIX	*RENAE, CO FIX	11000
*13000 - MRA		
RENAE, CO FIX	VERNAL, UT VOR/DME	11000
VERNAL, UT VOR/DME	*NEOLA, UT FIX	10000
*12000 - MCA NEOLA, UT FIX , W BND		
NEOLA, UT FIX	*WASATCH, UT VORTAC	15000
*11000 - MCA WASATCH, UT VORTAC , E BND		
WASATCH, UT VORTAC	OGDEN, UT VORTAC	7000
OGDEN, UT VORTAC	*KREBS, UT FIX	9400
*13000 - MRA		
KREBS, UT FIX	BLIDA, UT FIX	9400
BLIDA, UT FIX	MALTT, ID FIX	11400
MALTT, ID FIX	*BURLEY, ID VOR/DME	
	NW BND	**8000
	SE BND	**11400
*9300 - MCA BURLEY, ID VOR/DME , SE BND		
**7400 - MOCA		
BURLEY, ID VOR/DME	REAPS, ID FIX	
	S BND	7000
	N BND	9500
REAPS, ID FIX	HAILEY, ID NDB/DME	*9500
*8900 - MOCA		
HAILEY, ID NDB/DME	SOLDE, ID FIX	
	NE BND	9000
	SW BND	17000

**95.6102 VOR FEDERAL AIRWAY V102**

*SALT FLAT, TX VORTAC	**CARLSBAD, NM VORTAC	10800
*10000 - MCA SALT FLAT, TX VORTAC , NE BND		
**7000 - MCA CARLSBAD, NM VORTAC , SW BND		
CARLSBAD, NM VORTAC	HOBBS, NM VORTAC	5600
HOBBS, NM VORTAC	LUBBOCK, TX VORTAC	*6000
*5400 - MOCA		

**95.6103 VOR FEDERAL AIRWAY V103**

CHESTERFIELD, SC VOR/DME	GREENSBORO, NC VORTAC	2500
--------------------------	-----------------------	------

FROM TO MEA

**95.6103 VOR FEDERAL AIRWAY V103 - CONTINUED**

GREENSBORO, NC VORTAC	HENBY, VA FIX	3500
HENBY, VA FIX	TABER, VA FIX	5100
TABER, VA FIX	ROANOKE, VA VOR/DME	5600
ROANOKE, VA VOR/DME	NATTS, WV FIX	6000
NATTS, WV FIX	VELLI, WV FIX	7000
VELLI, WV FIX	ELKINS, WV VORTAC	*7000
*6400 - MOCA		
ELKINS, WV VORTAC	CLARKSBURG, WV VOR/DME	*5000
*3900 - MOCA		
CLARKSBURG, WV VOR/DME	BELLAIRE, OH VOR/DME	*3400
*CKB R-335 UNUSABLE BELOW 9000, USE AIR R-158.		
BELLAIRE, OH VOR/DME	ATWOO, OH FIX	*6000
*3000 - MOCA		
ATWOO, OH FIX	AKRON, OH VOR/DME	3000

**95.6105 VOR FEDERAL AIRWAY V105**

TUCSON, AZ VORTAC	STANFIELD, AZ VORTAC	*8000
*6700 - MOCA		
STANFIELD, AZ VORTAC	PHOENIX, AZ VORTAC	5000
PHOENIX, AZ VORTAC	KARLO, AZ FIX	10000
KARLO, AZ FIX	DRAKE, AZ VORTAC	*12000
*10000 - MOCA		
*10000 - GNSS MEA		
DRAKE, AZ VORTAC	WINDS, AZ FIX	10000
WINDS, AZ FIX	BOULDER CITY, NV VORTAC	*7000
*6000 - MOCA		
BOULDER CITY, NV VORTAC	*LAS VEGAS, NV VORTAC	6000
*10500 - MCA LAS VEGAS, NV VORTAC , W BND		
LAS VEGAS, NV VORTAC	HARLS, NV FIX	
	E BND	7000
	W BND	14000
HARLS, NV FIX	LUCKY, NV FIX	
	E BND	11000
	W BND	14000
LUCKY, NV FIX	*HIDEN, CA FIX	14000
*14000 - MRA		
*14000 - MCA HIDEN, CA FIX , E BND		
HIDEN, CA FIX	BEATTY, NV VORTAC	*12000
*8600 - MOCA		
BEATTY, NV VORTAC	COALDALE, NV VORTAC	*11000
*9600 - MOCA		
COALDALE, NV VORTAC	*YERIN, NV FIX	**14000
*12500 - MCA YERIN, NV FIX , SE BND		
**11200 - MOCA		
YERIN, NV FIX	CHIME, NV FIX	
	NW BND	10000
	SE BND	11500
CHIME, NV FIX	MUSTANG, NV VORTAC	10000

**95.6106 VOR FEDERAL AIRWAY V106**

JOHNSTOWN, PA VOR/DME	HUDON, PA FIX	5300
HUDON, PA FIX	RASHE, PA FIX	*7000
*4600 - MOCA		
*4600 - GNSS MEA		

**95.6107 VOR FEDERAL AIRWAY V107**

LOS ANGELES, CA VORTAC	STABO, CA FIX	2800
------------------------	---------------	------

FROM TO MEA

**95.6107 VOR FEDERAL AIRWAY V107 - CONTINUED**

STABO, CA FIX	*SANTA MONICA, CA VOR/DME	3000
*3700 - MCA SANTA MONICA, CA VOR/DME , W BND		
SANTA MONICA, CA VOR/DME	*FILLMORE, CA VORTAC	5000
*7500 - MCA FILLMORE, CA VORTAC , NW BND		
FILLMORE, CA VORTAC	PIRUE, CA FIX	
	SE BND	*8000
	NW BND	*9000
*7200 - MOCA		
PIRUE, CA FIX	REYES, CA FIX	*11000
*9200 - MOCA		
REYES, CA FIX	DERBB, CA FIX	11000
DERBB, CA FIX	AVENAL, CA VOR/DME	*7000
*6500 - MOCA		
AVENAL, CA VOR/DME	PANOCHÉ, CA VORTAC	8000
PANOCHÉ, CA VORTAC	*CATHE, CA FIX	**7000
*7000 - MCA CATHE, CA FIX , NW BND		
**5700 - MOCA		
CATHE, CA FIX	VINCO, CA FIX	*7000
*6400 - MOCA		
VINCO, CA FIX	MABRY, CA FIX	
	S BND	7000
	N BND	6000
MABRY, CA FIX	MISON, CA FIX	
	N BND	5500
	S BND	7000
MISON, CA FIX	OAKLAND, CA VOR/DME	
	SE BND	7000
	NW BND	4500
OAKLAND, CA VOR/DME	COMMO, CA FIX	*5000
*4000 - MOCA		
COMMO, CA FIX	POINT REYES, CA VOR/DME	5000
POINT REYES, CA VOR/DME	BOARS, CA FIX	5000

**95.6108 VOR FEDERAL AIRWAY V108**

ROZZA, CA FIX	SCAGGS ISLAND, CA VORTAC	4700
SCAGGS ISLAND, CA VORTAC	CONCORD, CA VOR/DME	3000
CONCORD, CA VOR/DME	OAKEY, CA FIX	3500
OAKEY, CA FIX	LINDEN, CA VOR/DME	2300
MEEKER, CO VOR/DME	RED TABLE, CO VOR/DME	*14000
*12800 - MOCA		
RED TABLE, CO VOR/DME	*STAMY, CO FIX	16400
*12300 - MCA STAMY, CO FIX , W BND		
STAMY, CO FIX	*BLACK FOREST, CO VOR/DME	12000
*10700 - MCA BLACK FOREST, CO VOR/DME , W BND		
BLACK FOREST, CO VOR/DME	ADANE, CO FIX	9500
ADANE, CO FIX	*HUGO, CO VOR/DME	9000
*7100 - MCA HUGO, CO VOR/DME , W BND		
HUGO, CO VOR/DME	GOODLAND, KS VORTAC	7000
GOODLAND, KS VORTAC	HILL CITY, KS VORTAC	5500

**95.6110 VOR FEDERAL AIRWAY V110**

DEMING, NM VORTAC	TRUTH OR CONSEQUENCES, NM VORTAC	8000
-------------------	----------------------------------	------

**95.6111 VOR FEDERAL AIRWAY V111**

BIG SUR, CA VORTAC	SALINAS, CA VORTAC	7000
SALINAS, CA VORTAC	CATHE, CA FIX	5500



FROM TO MEA

**95.6111 VOR FEDERAL AIRWAY V111 - CONTINUED**

CATHE, CA FIX	KARNN, CA FIX	5500
KARNN, CA FIX	PATYY, CA FIX	5000
PATYY, CA FIX	MODESTO, CA VOR/DME	*3000
*1500 - MOCA		

**95.6112 VOR FEDERAL AIRWAY V112**

HOQUIAM, WA VORTAC	ILWAC, WA FIX	2500
ILWAC, WA FIX	ASTORIA, OR VOR/DME	3000
ASTORIA, OR VOR/DME	PITER, OR FIX	5000
PITER, OR FIX	*BATTLE GROUND, WA VORTAC	4400
*5000 - MCA BATTLE GROUND, WA VORTAC , E BND		
BATTLE GROUND, WA VORTAC	KLICKITAT, OR VOR/DME	*7000
*6500 - MOCA		
KLICKITAT, OR VOR/DME	*OGPAY, OR FIX	5400
*6000 - MRA		
OGPAY, OR FIX	*LOAMS, OR FIX	5400
*6000 - MRA		
LOAMS, OR FIX	*ECHOD, OR FIX	4100
*6000 - MRA		
ECHOD, OR FIX	PENDLETON, OR VORTAC	4100
PENDLETON, OR VORTAC	LYLES, WA FIX	4000
LYLES, WA FIX	*RODNA, WA FIX	**5000
*6000 - MRA		
**4400 - MOCA		
RODNA, WA FIX	SPOKANE, WA VORTAC	5000
SPOKANE, WA VORTAC	DIANN, WA FIX	
	SW BND	*7000
	NE BND	*11000
*5500 - MOCA		
DIANN, WA FIX	U.S. CANADIAN BORDER	*11000
*9700 - MOCA		

**95.6113 VOR FEDERAL AIRWAY V113**

MORRO BAY, CA VORTAC	PASO ROBLES, CA VORTAC	5000
PANOCH, CA VORTAC	*PATYY, CA FIX	5000
*5000 - MCA PATYY, CA FIX , SE BND		
PATYY, CA FIX	MODESTO, CA VOR/DME	*3000
*1500 - MOCA		
MODESTO, CA VOR/DME	*LINDEN, CA VOR/DME	2000
*4000 - MCA LINDEN, CA VOR/DME , NE BND		
LINDEN, CA VOR/DME	*KATSO, CA FIX	5000
*12400 - MCA KATSO, CA FIX , NE BND		
KATSO, CA FIX	*SPOOK, CA FIX	**13000
*15000 - MCA SPOOK, CA FIX , N BND		
**12100 - MOCA		
SPOOK, CA FIX	RICHY, CA FIX	*15000
*12000 - MOCA		
RICHY, CA FIX	*MUSTANG, NV VORTAC	13000
*10500 - MCA MUSTANG, NV VORTAC , S BND		
MUSTANG, NV VORTAC	NICER, NV FIX	10300
NICER, NV FIX	ROBUD, NV FIX	*12000
*10600 - MOCA		
ROBUD, NV FIX	SOD HOUSE, NV VORTAC	*10000
*9000 - MOCA		
SOD HOUSE, NV VORTAC	ROME, OR VOR/DME	10000
ROME, OR VOR/DME	*RENOL, ID FIX	9400
*7300 - MCA RENOL, ID FIX , SW BND		

FROM TO MEA

**95.6113 VOR FEDERAL AIRWAY V113 - CONTINUED**

RENOL, ID FIX	*BOISE, ID VORTAC	6000
*8200 - MCA BOISE, ID VORTAC , NE BND		
BOISE, ID VORTAC	SALMON, ID VOR/DME	16500
SALMON, ID VOR/DME	SLIPP, MT FIX	13000
SLIPP, MT FIX	*COPPERTOWN, MT VOR/DME	
	SW BND	13000
	NE BND	11000
*10200 - MCA COPPERTOWN, MT VOR/DME , SW BND		
COPPERTOWN, MT VOR/DME	HELENA, MT VORTAC	*13000
*10800 - MOCA		
HELENA, MT VORTAC	LEWISTOWN, MT VOR/DME	11100

**95.6114 VOR FEDERAL AIRWAY V114**

PANHANDLE, TX VORTAC	*DOGIN, TX FIX	**5400
*6500 - MRA		
**5000 - MOCA		
DOGIN, TX FIX	CHILDRESS, TX VORTAC	5000
CHILDRESS, TX VORTAC	VASTY, TX FIX	3700
VASTY, TX FIX	WICHITA FALLS, TX VORTAC	3200
WICHITA FALLS, TX VORTAC	BONHAM, TX VORTAC	3000
GREGG COUNTY, TX VORTAC	CARTH, TX FIX	*2300
*1900 - MOCA		
CARTH, TX FIX	EXITE, LA FIX	*3000
*1700 - MOCA		
EXITE, LA FIX	COVEX, LA FIX	*3500
*1700 - MOCA		
COVEX, LA FIX	NUBOY, LA FIX	*5000
*1900 - MOCA		
NUBOY, LA FIX	ALEXANDRIA, LA VORTAC	
	W BND	5000
	E BND	2000
ALEXANDRIA, LA VORTAC	*MIKLE, LA FIX	2000
*3000 - MRA		
MIKLE, LA FIX	FIGHTING TIGER, LA VORTAC	2000
FIGHTING TIGER, LA VORTAC	VEILS, LA FIX	2800
VEILS, LA FIX	RESERVE, LA VOR/DME	2000
RESERVE, LA VOR/DME	GULFPORT, MS VORTAC	2000
GULFPORT, MS VORTAC	*MINDO, MS FIX	**6000
*6000 - MRA		
**2000 - GNSS MEA		
MINDO, MS FIX	EATON, MS VORTAC	*6000
*2000 - GNSS MEA		

**95.6115 VOR FEDERAL AIRWAY V115**

CRESTVIEW, FL VORTAC	PIGON, AL FIX	2500
PIGON, AL FIX	*REDDI, AL FIX	2500
*5500 - MRA		
REDDI, AL FIX	MONTGOMERY, AL VORTAC	2500
MONTGOMERY, AL VORTAC	VULCAN, AL VORTAC	3000
VULCAN, AL VORTAC	CHOO CHOO, TN VORTAC	4000
CHOO CHOO, TN VORTAC	ETOWA, TN FIX	3000
ETOWA, TN FIX	GROSS, TN FIX	3100
GROSS, TN FIX	VOLUNTEER, TN VORTAC	3000
CHARLESTON, WV VOR/DME	PARKERSBURG, WV VOR/DME	3000

**95.6116 VOR FEDERAL AIRWAY V116**

STONYFORK, PA VOR/DME	WILKES-BARRE, PA VORTAC	4000
-----------------------	-------------------------	------

FROM TO MEA

**95.6116 VOR FEDERAL AIRWAY V116 - CONTINUED**

WILKES-BARRE, PA VORTAC SPARTA, NJ VORTAC 4000

**95.6117 VOR FEDERAL AIRWAY V117**

PARKERSBURG, WV VOR/DME BELLAIRE, OH VOR/DME 3000  
 BELLAIRE, OH VOR/DME WISKE, WV FIX 3300

**95.6118 VOR FEDERAL AIRWAY V118**

MEDICINE BOW, WY VOR/DME LARAMIE, WY VOR/DME 9400  
 LARAMIE, WY VOR/DME \*SENSE, WY FIX 11000  
 \*9900 - MCA SENSE, WY FIX , W BND  
 SENSE, WY FIX CHEYENNE, WY VORTAC 8800

**95.6119 VOR FEDERAL AIRWAY V119**

PARKERSBURG, WV VOR/DME ANTIO, OH FIX 3000  
 ANTIO, OH FIX INDIAN HEAD, PA VORTAC 5000

**95.6120 VOR FEDERAL AIRWAY V120**

\*SEATTLE, WA VORTAC TAGOR, WA FIX  
 E BND \*\*8500  
 W BND \*\*5000  
 \*6300 - MCA SEATTLE, WA VORTAC , E BND  
 \*\*5000 - MOCA  
 TAGOR, WA FIX CASHS, WA FIX \*12000  
 \*11400 - MOCA  
 CASHS, WA FIX \*WENATCHEE, WA VOR/DME  
 E BND \*\*7500  
 W BND \*\*12000  
 \*8200 - MCA WENATCHEE, WA VOR/DME , W BND  
 \*\*6700 - MOCA  
 WENATCHEE, WA VOR/DME EPHRATA, WA VORTAC 5500  
 EPHRATA, WA VORTAC WIPES, WA FIX 4000  
 WIPES, WA FIX \*SPOKANE, WA VORTAC 5000  
 \*5200 - MCA SPOKANE, WA VORTAC , E BND  
 SPOKANE, WA VORTAC KARPS, ID FIX \*9000  
 \*7600 - MOCA  
 KARPS, ID FIX MULLAN PASS, ID VOR/DME 9100  
 MULLAN PASS, ID VOR/DME CHARL, MT FIX \*13000  
 \*9600 - MOCA  
 CHARL, MT FIX \*SHIMY, MT FIX \*\*13000  
 \*7000 - MRA  
 \*7900 - MCA SHIMY, MT FIX , W BND  
 \*\*12100 - MOCA  
 SHIMY, MT FIX GREAT FALLS, MT VORTAC 6800  
 GREAT FALLS, MT VORTAC LEWISTOWN, MT VOR/DME 8400  
 LEWISTOWN, MT VOR/DME ESTRO, MT FIX 7700  
 ESTRO, MT FIX MILES CITY, MT VOR/DME \*9000  
 \*7500 - MOCA  
 MILES CITY, MT VOR/DME DUPREE, SD VOR/DME \*10000  
 \*6600 - MOCA  
 DUPREE, SD VOR/DME PIERRE, SD VORTAC \*4300  
 \*3700 - MOCA  
 PIERRE, SD VORTAC MITCHELL, SD VOR/DME \*3900  
 \*3400 - MOCA  
 MITCHELL, SD VOR/DME FRYRE, SD FIX 3700  
 FRYRE, SD FIX SIOUX FALLS, SD VORTAC 3700

FROM TO MEA

**95.6120 VOR FEDERAL AIRWAY V120 - CONTINUED**

SIoux FALLS, SD VORTAC	BILOO, IA FIX	*5000
*3600 - MOCA		
BILOO, IA FIX	*GRUVE, IA FIX	**6800
*8000 - MRA		
**3100 - MOCA		
GRUVE, IA FIX	BANCO, IA FIX	*6800
*3100 - MOCA		
BANCO, IA FIX	MASON CITY, IA VOR/DME	3000
MASON CITY, IA VOR/DME	AREDA, IA FIX	3000
AREDA, IA FIX	*SEATS, IA FIX	3000
*4500 - MRA		
SEATS, IA FIX	WATERLOO, IA VOR/DME	3000

**95.6121 VOR FEDERAL AIRWAY V121**

FORT JONES, CA VOR/DME	*BAYTS, OR FIX	**10000
*10000 - MRA		
*9000 - MCA BAYTS, OR FIX , S BND		
**9400 - MOCA		
BAYTS, OR FIX	ROGUE VALLEY, OR VORTAC	*8000
*7500 - MOCA		
ROGUE VALLEY, OR VORTAC	MOURN, OR FIX	7000
MOURN, OR FIX	ROSEBURG, OR VOR/DME	
	W BND	6000
	E BND	7000
ROSEBURG, OR VOR/DME	NORTH BEND, OR VOR/DME	6000
NORTH BEND, OR VOR/DME	SCOTY, OR FIX	
	NE BND	5000
	SW BND	4400
SCOTY, OR FIX	*VAUGN, OR FIX	5000
*7000 - MRA		
VAUGN, OR FIX	*EUGENE, OR VORTAC	
	NE BND	4100
	SW BND	5000
*9000 - MCA EUGENE, OR VORTAC , E BND		
EUGENE, OR VORTAC	DOSEE, OR FIX	
	E BND	10000
	W BND	5200
DOSEE, OR FIX	VIDAS, OR FIX	
	E BND	11600
	W BND	6000
VIDAS, OR FIX	WHIFF, OR FIX	*13000
*7500 - MOCA		
*12000 - GNSS MEA		
WHIFF, OR FIX	SNOKY, OR FIX	*13000
*12300 - MOCA		
SNOKY, OR FIX	*DESCHUTES, OR VORTAC	
	E BND	8000
	W BND	13000
*10400 - MCA DESCHUTES, OR VORTAC , W BND		
DESCHUTES, OR VORTAC	JABOT, OR FIX	
	NE BND	9000
	SW BND	7000
JABOT, OR FIX	KIMBERLY, OR VOR/DME	9000
KIMBERLY, OR VOR/DME	*BAKER CITY, OR VOR/DME	12000
*10000 - MCA BAKER CITY, OR VOR/DME , SW BND		
BAKER CITY, OR VOR/DME	DONNELLY, ID VOR/DME	11000
DONNELLY, ID VOR/DME	SALMON, ID VOR/DME	12000
SALMON, ID VOR/DME	NOSEY, MT FIX	12000

FROM TO MEA

**95.6121 VOR FEDERAL AIRWAY V121 - CONTINUED**

NOSEY, MT FIX	DILLON, MT VOR/DME	
	E BND	*10000
	W BND	*12000
*9100 - MOCA		

**95.6122 VOR FEDERAL AIRWAY V122**

CRESCENT CITY, CA VORTAC	REFIX, CA FIX	
	SW BND	4000
	NE BND	8000
REFIX, CA FIX	OBRIN, CA FIX	
	NE BND	8000
	SW BND	6000
OBRIN, CA FIX	*PAPLE, OR FIX	8000
*10100 - MRA		
PAPLE, OR FIX	GNATS, OR FIX	8000
GNATS, OR FIX	ROGUE VALLEY, OR VORTAC	
	SW BND	8000
	NE BND	5500
ROGUE VALLEY, OR VORTAC	BRUTE, OR FIX	
	E BND	9000
	W BND	5000
BRUTE, OR FIX	LANKS, OR FIX	
	W BND	*6500
	E BND	*9000
*5800 - MOCA		
LANKS, OR FIX	KLAMATH FALLS, OR VORTAC	*9000
*8500 - MOCA		
KLAMATH FALLS, OR VORTAC	LAKEVIEW, OR VORTAC	9600
LAKEVIEW, OR VORTAC	ROME, OR VOR/DME	12000

**95.6123 VOR FEDERAL AIRWAY V123**

MITCH, MD FIX	SWANN, MD FIX	*7000
*3000 - GNSS MEA		
SWANN, MD FIX	*TACKS, MD FIX	**7000
*7000 - MCA TACKS, MD FIX , W BND		
**4000 - GNSS MEA		
TACKS, MD FIX	WOODSTOWN, NJ VORTAC	*2000
*1500 - MOCA		
WOODSTOWN, NJ VORTAC	ROBBINSVILLE, NJ VORTAC	*3000
*2000 - MOCA		
ROBBINSVILLE, NJ VORTAC	MINKS, NJ FIX	2000
MINKS, NJ FIX	LA GUARDIA, NY VOR/DME	2900
LA GUARDIA, NY VOR/DME	FAMMA, NY FIX	2000
FAMMA, NY FIX	HAARP, CT FIX	3000
HAARP, CT FIX	*RYMES, CT FIX	**5000
*5000 - MRA		
**2000 - MOCA		
**3000 - GNSS MEA		
RYMES, CT FIX	CARMEL, NY VOR/DME	2500
CARMEL, NY VOR/DME	CASSH, NY FIX	3000
CASSH, NY FIX	*WIGAN, NY FIX	3100
*8000 - MCA WIGAN, NY FIX , N BND		
WIGAN, NY FIX	GROUP, NY FIX	*8000
*3000 - GNSS MEA		
GROUP, NY FIX	*ALBANY, NY VORTAC	**6000
*6000 - MCA ALBANY, NY VORTAC , S BND		
**2800 - GNSS MEA		

FROM TO MEA

**95.6123 VOR FEDERAL AIRWAY V123 - CONTINUED**

ALBANY, NY VORTAC \*CAMBRIDGE, NY VOR/DME \*\*4000  
 \*4500 - MCA CAMBRIDGE, NY VOR/DME , BND  
 \*\*3000 - MOCA  
 \*\*ALBANY R-067 UNUSABLE.

**95.6124 VOR FEDERAL AIRWAY V124**

BONHAM, TX VORTAC	PARIS, TX VOR/DME	2400
PARIS, TX VOR/DME	DEENS, AR FIX	*4000
*2000 - MOCA		
DEENS, AR FIX	HOT SPRINGS, AR VOR/DME	*5000
*2700 - MOCA		
HOT SPRINGS, AR VOR/DME	LITTLE ROCK, AR VORTAC	3000
LITTLE ROCK, AR VORTAC	TAFTE, AR FIX	*4000
*1700 - MOCA		
TAFTE, AR FIX	*HILLE, AR FIX	**6000
*6000 - MRA		
**1600 - MOCA		
HILLE, AR FIX	GILMORE, AR VOR/DME	*4000
*1700 - MOCA		

**95.6126 VOR FEDERAL AIRWAY V126**

BEARZ, IN FIX	HALIE, IN FIX	3000
HALIE, IN FIX	INKEN, IN FIX	*4000
*2300 - MOCA		
INKEN, IN FIX	GOSHEN, IN VORTAC	2600
GOSHEN, IN VORTAC	ILTON, IN FIX	*5000
*2400 - MOCA		

**95.6128 VOR FEDERAL AIRWAY V128**

BRICKYARD, IN VORTAC	DECEE, IN FIX	2600
DECEE, IN FIX	CINCINNATI, KY VORTAC	2800
CINCINNATI, KY VORTAC	CALIF, KY FIX	2600
CALIF, KY FIX	YORK, KY VORTAC	4000
YORK, KY VORTAC	CROUP, OH FIX	*3300
*2300 - MOCA		
CROUP, OH FIX	RULEY, WV FIX	
	NW BND	3600
	SE BND	3300
RULEY, WV FIX	CHARLESTON, WV VOR/DME	3600
CHARLESTON, WV VOR/DME	SWIFT, WV FIX	3400
SWIFT, WV FIX	BITES, WV FIX	
	W BND	5000
	E BND	7000
BITES, WV FIX	VELLI, WV FIX	7000
VELLI, WV FIX	BOIER, WV FIX	*8000
*7100 - MOCA		
*7100 - GNSS MEA		
BOIER, WV FIX	LURAY, VA FIX	*10000
*6900 - MOCA		
*6900 - GNSS MEA		
LURAY, VA FIX	CASANOVA, VA VORTAC	6300

**95.6129 VOR FEDERAL AIRWAY V129**

SPINNER, IL VORTAC	PEORIA, IL VORTAC	2500
PEORIA, IL VORTAC	GENSO, IL FIX	2600

FROM TO MEA

**95.6129 VOR FEDERAL AIRWAY V129 - CONTINUED**

GENSO, IL FIX	DAVENPORT, IA VORTAC	3000
DAVENPORT, IA VORTAC	DUBUQUE, IA VORTAC	2900
DUBUQUE, IA VORTAC	QUEST, WI FIX	*3100
*2600 - MOCA		
QUEST, WI FIX	NODINE, MN VORTAC	3100
NODINE, MN VORTAC	EAU CLAIRE, WI VORTAC	3000
EAU CLAIRE, WI VORTAC	DULUTH, MN VORTAC	*4000
*3100 - MOCA		
DULUTH, MN VORTAC	HIBBING, MN VOR/DME	3300
HIBBING, MN VOR/DME	INTERNATIONAL FALLS, MN VOR/DME	*3600
*3100 - MOCA		
INTERNATIONAL FALLS, MN VOR/DME	U.S. CANADIAN BORDER	2500

**95.6131 VOR FEDERAL AIRWAY V131**

OKMULGEE, OK VOR/DME	TULSA, OK VORTAC	3200
TULSA, OK VORTAC	TYROE, KS FIX	3000
TYROE, KS FIX	CHANUTE, KS VOR/DME	2800
CHANUTE, KS VOR/DME	TOPEKA, KS VORTAC	2900

**95.6132 VOR FEDERAL AIRWAY V132**

MEDICINE BOW, WY VOR/DME	MOIST, WY FIX	9500
MOIST, WY FIX	CHEYENNE, WY VORTAC	9000
CHEYENNE, WY VORTAC	RAYME, CO FIX	8500
RAYME, CO FIX	AKRON, CO VOR/DME	6800
AKRON, CO VOR/DME	GOODLAND, KS VORTAC	6400
GOODLAND, KS VORTAC	ORION, KS FIX	5700
ORION, KS FIX	*RANSO, KS FIX	**10000
*10000 - MRA		
**4200 - MOCA		
RANSO, KS FIX	DISKS, KS FIX	*10000
*4400 - MOCA		
DISKS, KS FIX	*SPELT, KS FIX	**5000
*5000 - MRA		
**3300 - MOCA		
SPELT, KS FIX	HUTCHINSON, KS VOR/DME	3200
HUTCHINSON, KS VOR/DME	WAIVE, KS FIX	4000
WAIVE, KS FIX	*FLOSS, KS FIX	3300
*5000 - MRA		
*5000 - MCA FLOSS, KS FIX , SE BND		
FLOSS, KS FIX	CHANUTE, KS VOR/DME	*5000
*2800 - MOCA		
CHANUTE, KS VOR/DME	NALLY, KS FIX	
	W BND	2800
	E BND	4500
NALLY, KS FIX	SPRINGFIELD, MO VORTAC	*4500
*2800 - MOCA		
*3000 - GNSS MEA		
SPRINGFIELD, MO VORTAC	FORNEY, MO VOR	3100
FORNEY, MO VOR	LENOX, MO FIX	3000

**95.6133 VOR FEDERAL AIRWAY V133**

LINCO, NC FIX	BARRETT'S MOUNTAIN, NC VOR/DME	4000
BARRETT'S MOUNTAIN, NC VOR/DME	MULBE, NC FIX	
	S BND	5400
	N BND	7200
MULBE, NC FIX	*STOVE, VA FIX	7200
*11000 - MCA STOVE, VA FIX , N BND		

FROM TO MEA

**95.6133 VOR FEDERAL AIRWAY V133 - CONTINUED**

STOVE, VA FIX *7000 - MOCA	PINEE, WV FIX	*13000
PINEE, WV FIX	*CHARLESTON, WV VOR/DME N BND S BND	**7000 **13000
*8500 - MCA CHARLESTON, WV VOR/DME , S BND **5600 - MOCA **5600 - GNSS MEA		
CHARLESTON, WV VOR/DME	ZANESVILLE, OH VOR/DME	3000
SAGINAW, MI VOR/DME	WHIPP, MI FIX	2400
WHIPP, MI FIX *5000 - MRA **2800 - MOCA	*LADIN, MI FIX	**5000
LADIN, MI FIX *2800 - MOCA	TRAVERSE CITY, MI VOR/DME	*5000
TRAVERSE CITY, MI VOR/DME	ESCANABA, MI VOR/DME	5000
ESCANABA, MI VOR/DME	SAWYER, MI VOR/DME	2800
SAWYER, MI VOR/DME *3400 - MOCA	HOUGHTON, MI VOR/DME	*4500
HOUGHTON, MI VOR/DME *2500 - MOCA	U.S. CANADIAN BORDER	*3100
U.S. CANADIAN BORDER *2500 - MOCA	INTERNATIONAL FALLS, MN VOR/DME	*3000
INTERNATIONAL FALLS, MN VOR/DME *2800 - MOCA	U.S. CANADIAN BORDER	*6500

**95.6134 VOR FEDERAL AIRWAY V134**

*FAIRFIELD, UT VORTAC *10800 - MCA FAIRFIELD, UT VORTAC , E BND **10200 - MCA CARBON, UT VOR/DME , W BND ***MEA IS ESTABLISHED WITH A GAP IN NAVIGATION SIGNAL COVERAGE	**CARBON, UT VOR/DME	***13000
CARBON, UT VOR/DME	GRAND JUNCTION, CO VOR/DME	11900
GRAND JUNCTION, CO VOR/DME *13000 - MRA	*PACES, CO FIX	11500
PACES, CO FIX *MTA V134 NE TO V220 NW 12900	*SLOLM, CO FIX	13000
SLOLM, CO FIX *16000 - MRA	*GLENO, CO FIX	14000
GLENO, CO FIX	RED TABLE, CO VOR/DME	14000
RED TABLE, CO VOR/DME	HERLS, CO FIX E BND W BND	16000 14000
HERLS, CO FIX *16500 - MRA	*FUNDS, CO FIX	16000
FUNDS, CO FIX	BREWS, CO FIX	16500
BREWS, CO FIX	*FALCON, CO VORTAC W BND E BND	16500 10000
*11600 - MCA FALCON, CO VORTAC , BND		

**95.6135 VOR FEDERAL AIRWAY V135**

SAYUL, CA FIX *2700 - MOCA	BARD, CA VORTAC	*4000
BARD, CA VORTAC *3900 - MOCA	BLYTHE, CA VORTAC	*5000
BLYTHE, CA VORTAC	PARKER, CA VORTAC	5400
PARKER, CA VORTAC	NEEDLES, CA VORTAC	6000



FROM TO MEA

**95.6135 VOR FEDERAL AIRWAY V135 - CONTINUED**

NEEDLES, CA VORTAC	*GOFFS, CA VORTAC	**8000
*9600 - MCA GOFFS, CA VORTAC , NW BND		
**7100 - MOCA		
GOFFS, CA VORTAC	*WHIGG, CA FIX	**12000
*12000 - MRA		
**10000 - MOCA		
WHIGG, CA FIX	CLARR, CA FIX	*12000
*10500 - MOCA		
CLARR, CA FIX	*HIDEN, CA FIX	**12000
*14000 - MRA		
**9100 - MOCA		
HIDEN, CA FIX	BEATTY, NV VORTAC	*12000
*8600 - MOCA		
BEATTY, NV VORTAC	TEZUM, NV FIX	*11000
*9600 - MOCA		
TEZUM, NV FIX	TONOPAH, NV VORTAC	11000

**95.6136 VOR FEDERAL AIRWAY V136**

HINCH MOUNTAIN, TN VOR/DME	SWELL, TN FIX	5000
SWELL, TN FIX	*VOLUNTEER, TN VORTAC	3000
*5000 - MCA VOLUNTEER, TN VORTAC , E BND		
VOLUNTEER, TN VORTAC	AUBRY, TN FIX	
	W BND	5000
	E BND	6000
AUBRY, TN FIX	*PITTE, TN FIX	6000
*8000 - MCA PITTE, TN FIX , E BND		
PITTE, TN FIX	SNOWBIRD, TN VORTAC	8000
SNOWBIRD, TN VORTAC	AFTEN, TN FIX	7000
AFTEN, TN FIX	HOLSTON MOUNTAIN, TN VORTAC	6000
HOLSTON MOUNTAIN, TN VORTAC	DAMAS, TN FIX	6000
DAMAS, TN FIX	*STOVE, VA FIX	7500
*7500 - MCA STOVE, VA FIX , SW BND		
STOVE, VA FIX	SPEEL, VA FIX	6000
SPEEL, VA FIX	PULASKI, VA VORTAC	5400
PULASKI, VA VORTAC	PIGGS, VA FIX	5500
PIGGS, VA FIX	DUNCE, VA FIX	3500
DUNCE, VA FIX	SOUTH BOSTON, VA VORTAC	2800
SOUTH BOSTON, VA VORTAC	*ALDAN, NC FIX	2600
*3000 - MRA		
ALDAN, NC FIX	RALEIGH/DURHAM, NC VORTAC	2600
RALEIGH/DURHAM, NC VORTAC	LANHO, NC FIX	3100
LANHO, NC FIX	FAYETTEVILLE, NC VOR/DME	2100
FAYETTEVILLE, NC VOR/DME	GRAND STRAND, SC VORTAC	*3000
*2200 - MOCA		
*V136 WITHIN GAMECOCK A MOA 7000 AND ABOVE FROM 17-38 NM S OF FAY VOR		
DOES NOT EXIST WHEN MOA IS ACTIVATED		

**95.6137 VOR FEDERAL AIRWAY V137**

NOVOS, CA FIX	IMPERIAL, CA VORTAC	*3000
*1900 - MOCA		
IMPERIAL, CA VORTAC	*BRAWL, CA FIX	**3700
*4500 - MRA		
**2300 - MOCA		
BRAWL, CA FIX	HENOM, CA FIX	3700
HENOM, CA FIX	THERMAL, CA VORTAC	3900
THERMAL, CA VORTAC	*PALM SPRINGS, CA VORTAC	4000
*11200 - MCA PALM SPRINGS, CA VORTAC , NW BND		

FROM TO MEA

**95.6137 VOR FEDERAL AIRWAY V137 - CONTINUED**

PALM SPRINGS, CA VORTAC	*WHETO, CA FIX	
	NW BND	**12000
	SE BND	**7000
*12400 - MCA WHETO, CA FIX , NW BND		
**6000 - MOCA		
WHETO, CA FIX	MORON, CA FIX	
	SE BND	12000
	NW BND	13500
MORON, CA FIX	*ARRAN, CA FIX	13500
*12000 - MCA ARRAN, CA FIX , E BND		
ARRAN, CA FIX	*PALMDALE, CA VORTAC	10700
*7000 - MCA PALMDALE, CA VORTAC , E BND		
PALMDALE, CA VORTAC	VICKY, CA FIX	*8000
*5800 - MOCA		
VICKY, CA FIX	JEFFY, CA FIX	
	E BND	8000
	W BND	9000
JEFFY, CA FIX	GORMAN, CA VORTAC	
	E BND	8000
	W BND	10100
GORMAN, CA VORTAC	*TAFTO, CA FIX	10000
*9000 - MCA TAFTO, CA FIX , SE BND		
TAFTO, CA FIX	AVENAL, CA VOR/DME	
	SE BND	5500
	NW BND	4500

**95.6138 VOR FEDERAL AIRWAY V138**

RIVERTON, WY VOR/DME	HUNTZ, WY FIX	9000
HUNTZ, WY FIX	MEDICINE BOW, WY VOR/DME	11200
MEDICINE BOW, WY VOR/DME	MILKY, WY FIX	10600
MILKY, WY FIX	CHEYENNE, WY VORTAC	9200
CHEYENNE, WY VORTAC	PIETY, WY FIX	8000
PIETY, WY FIX	SIDNEY, NE VOR/DME	*7600
*7000 - MOCA		
GRAND ISLAND, NE VOR/DME	BRADY, NE FIX	3600
BRADY, NE FIX	GAMBL, NE FIX	4100
GAMBL, NE FIX	LINCOLN, NE VORTAC	3300
LINCOLN, NE VORTAC	OMAHA, IA VORTAC	4000

**95.6139 VOR FEDERAL AIRWAY V139**

FLORENCE, SC VORTAC	MOKKA, NC FIX	2000
MOKKA, NC FIX	WILMINGTON, NC VORTAC	*8000
*2100 - MOCA		
*2100 - GNSS MEA		
*WILMINGTON R-273 UNUSABLE. USE FLORENCE R-088		
WILMINGTON, NC VORTAC	NEW BERN, NC VOR/DME	*6000
*1800 - MOCA		
*2000 - GNSS MEA		
*WILMINGTON R-050 UNUSABLE. USE NEW BERN R-232		
NEW BERN, NC VOR/DME	PEARS, NC FIX	
	S BND	*4000
	N BND	*6000
*1800 - MOCA		
*2000 - GNSS MEA		
PEARS, NC FIX	SUNNS, NC FIX	*6000
*2100 - MOCA		
*2100 - GNSS MEA		

FROM	TO	MEA
<b>95.6139 VOR FEDERAL AIRWAY V139 - CONTINUED</b>		
SUNNS, NC FIX	NORFOLK, VA VORTAC	
	NE BND	*2500
	SW BND	*4800
*1600 - MOCA		
*2000 - GNSS MEA		
NORFOLK, VA VORTAC	CAPE CHARLES, VA VORTAC	*2500
*1800 - MOCA		
CAPE CHARLES, VA VORTAC	DUNFE, VA FIX	
	NE BND	*4000
	SW BND	*2000
*1600 - MOCA		
DUNFE, VA FIX	SNOW HILL, MD VORTAC	*4000
*1600 - MOCA		
SNOW HILL, MD VORTAC	CBEAV, MD FIX	2000
CBEAV, MD FIX	SEA ISLE, NJ VORTAC	*2500
*1700 - MOCA		
SEA ISLE, NJ VORTAC	AVALO, NJ FIX	*4500
*4000 - GNSS MEA		
AVALO, NJ FIX	HARBO, NJ FIX	*6000
*4000 - GNSS MEA		
HARBO, NJ FIX	*DRIFT, NJ FIX	**7500
*6000 - MRA		
**3000 - GNSS MEA		
DRIFT, NJ FIX	MANTA, NJ FIX	*12000
*3000 - GNSS MEA		
MANTA, NJ FIX	PLUME, NJ FIX	*7000
*2000 - MOCA		
*3000 - GNSS MEA		
PLUME, NJ FIX	*KOPPY, NY FIX	**4000
*5000 - MRA		
**3000 - MOCA		
**3000 - GNSS MEA		
KOPPY, NY FIX	BEADS, NY FIX	*4000
*3000 - MOCA		
*3000 - GNSS MEA		
BEADS, NY FIX	HAMPTON, NY VORTAC	*2500
*1600 - MOCA		
HAMPTON, NY VORTAC	TRAIT, RI FIX	UNUSABLE
TRAIT, RI FIX	PROVIDENCE, RI VOR/DME	*3000
*2100 - MOCA		
PROVIDENCE, RI VOR/DME	INNDY, MA FIX	*3000
*2000 - GNSS MEA		
INNDY, MA FIX	*TONNI, MA FIX	6000
*6000 - MRA		
TONNI, MA FIX	SEEDY, NH FIX	*5000
*4000 - GNSS MEA		
SEEDY, NH FIX	KENNEBUNK, ME VOR/DME	*5000
*2000 - MOCA		
*2500 - GNSS MEA		

**95.6140 VOR FEDERAL AIRWAY V140**

PANHANDLE, TX VORTAC	BURNS FLAT, OK VORTAC	5300
TULSA, OK VORTAC	PRYOR, OK FIX	*3400
*2300 - MOCA		
PRYOR, OK FIX	RAZORBACK, AR VORTAC	*3400
*2900 - MOCA		
RAZORBACK, AR VORTAC	SPRAY, AR FIX	*4000
*2900 - MOCA		

FROM TO MEA

**95.6140 VOR FEDERAL AIRWAY V140 - CONTINUED**

SPRAY, AR FIX *3500 - MOCA	HARRISON, AR VOR/DME	*4000
HARRISON, AR VOR/DME	VILLO, AR FIX	3000
VILLO, AR FIX	WALNUT RIDGE, AR VORTAC	
	W BND	3000
	E BND	2500
NASHVILLE, TN VORTAC	HARME, TN FIX	
	W BND	*3000
	E BND	*6000
*2400 - MOCA		
HARME, TN FIX	LIVINGSTON, TN VOR/DME	*6000
*2900 - MOCA		
LIVINGSTON, TN VOR/DME	LONDON, KY VOR/DME	3900
BLUEFIELD, WV VOR/DME	SOFTY, WV FIX	*7000
*5600 - MOCA		
SOFTY, WV FIX	CASTE, VA FIX	6300
CASTE, VA FIX	MONTEBELLO, VA VOR/DME	6000
MONTEBELLO, VA VOR/DME	HOODE, VA FIX	6100
HOODE, VA FIX	CASANOVA, VA VORTAC	3200

**95.6141 VOR FEDERAL AIRWAY V141**

NANTUCKET, MA VOR/DME	GAILS, MA FIX	1700
GAILS, MA FIX	*CELTS, MA FIX	**3000
*2500 - MRA		
**2000 - MOCA		
CELTS, MA FIX	BOSTON, MA VOR/DME	2000

**95.6142 VOR FEDERAL AIRWAY V142**

*TWIN FALLS, ID VORTAC	MURTH, ID FIX	
	E BND	13000
	W BND	7800
*12000 - MCA TWIN FALLS, ID VORTAC	E BND	
MURTH, ID FIX	OCLEY, ID FIX	
	E BND	15000
	W BND	9500
OCLEY, ID FIX	*SHEAR, UT FIX	**16500
*16500 - MCA SHEAR, UT FIX , W BND		
**12400 - MOCA		
SHEAR, UT FIX	*MALAD CITY, ID VOR/DME	
	SW BND	11000
	NE BND	10000
*13500 - MCA MALAD CITY, ID VOR/DME , SW BND		
MALAD CITY, ID VOR/DME	*ORNEY, UT FIX	10400
*11200 - MCA ORNEY, UT FIX , E BND		
ORNEY, UT FIX	FORT BRIDGER, WY VOR/DME	12200
FORT BRIDGER, WY VOR/DME	ROCK SPRINGS, WY VOR/DME	10000

**95.6143 VOR FEDERAL AIRWAY V143**

GIZMO, NC FIX	GREENSBORO, NC VORTAC	3000
GREENSBORO, NC VORTAC	LEAKS, NC FIX	3000
LEAKS, NC FIX	LYNCHBURG, VA VOR/DME	3000
LYNCHBURG, VA VOR/DME	ELLON, VA FIX	
	N BND	5700
	S BND	3200
ELLON, VA FIX	*CLYFF, VA FIX	5700
*6300 - MCA CLYFF, VA FIX , N BND		

FROM TO MEA

**95.6143 VOR FEDERAL AIRWAY V143 - CONTINUED**

CLYFF, VA FIX	MONTEBELLO, VA VOR/DME	6400
MONTEBELLO, VA VOR/DME	LURAY, VA FIX	6000
LURAY, VA FIX	*KERRE, VA FIX	**6000
*7000 - MRA		
**5000 - MOCA		
KERRE, VA FIX	MARTINSBURG, WV VORTAC	*6000
*5000 - MOCA		
MARTINSBURG, WV VORTAC	HYPER, MD FIX	*5000
*3900 - MOCA		
HYPER, MD FIX	BINNS, PA FIX	*9000
*2600 - MOCA		
*4000 - GNSS MEA		
BINNS, PA FIX	DELRO, PA FIX	*9000
*4500 - GNSS MEA		
DELRO, PA FIX	LANCASTER, PA VOR/DME	3000
LANCASTER, PA VOR/DME	POTTSTOWN, PA VORTAC	4500
POTTSTOWN, PA VORTAC	YARDLEY, PA VOR/DME	*6900
*4000 - GNSS MEA		

**95.6144 VOR FEDERAL AIRWAY V144**

FORT WAYNE, IN VORTAC	BUZZI, OH FIX	*6000
*3000 - MOCA		
BUZZI, OH FIX	APPLETON, OH VORTAC	*4000
*2600 - MOCA		
APPLETON, OH VORTAC	ZANESVILLE, OH VOR/DME	3000
ZANESVILLE, OH VOR/DME	BEALL, OH FIX	3000
BEALL, OH FIX	*MORGANTOWN, WV VOR/DME	4000
*4600 - MCA MORGANTOWN, WV VOR/DME , SE BND		
MORGANTOWN, WV VOR/DME	KESSEL, WV VOR/DME	5700
KESSEL, WV VOR/DME	LINDEN, VA VORTAC	5500

**95.6146 VOR FEDERAL AIRWAY V146**

ALBANY, NY VORTAC	CHESTER, MA VOR/DME	4100
CHESTER, MA VOR/DME	BARNES, MA VORTAC	*4000
*3200 - MOCA		
BARNES, MA VORTAC	PUTNAM, CT VOR/DME	*3000
*2500 - MOCA		
PUTNAM, CT VOR/DME	PROVIDENCE, RI VOR/DME	*3000
*2100 - MOCA		
PROVIDENCE, RI VOR/DME	MARTHAS VINEYARD, MA VOR/DME	2100
MARTHAS VINEYARD, MA VOR/DME	NANTUCKET, MA VOR/DME	2000

**95.6147 VOR FEDERAL AIRWAY V147**

YARDLEY, PA VOR/DME	*SPUDS, PA FIX	5000
*6000 - MRA		
SPUDS, PA FIX	EAST TEXAS, PA VOR/DME	*4100
*2500 - MOCA		
EAST TEXAS, PA VOR/DME	SLATT, PA FIX	4000
SLATT, PA FIX	*WILKES-BARRE, PA VORTAC	4000
*4400 - MCA WILKES-BARRE, PA VORTAC , NW BND		
WILKES-BARRE, PA VORTAC	ELMIRA, NY VOR/DME	4000
ELMIRA, NY VOR/DME	GENESE0, NY VOR/DME	4000
GENESE0, NY VOR/DME	ROCHESTER, NY VOR/DME	2800

**95.6148 VOR FEDERAL AIRWAY V148**

FALCON, CO VORTAC	*LIMEX, CO FIX	8500
*10000 - MRA		

FROM TO MEA

**95.6148 VOR FEDERAL AIRWAY V148 - CONTINUED**

LIMEX, CO FIX	THURMAN, CO VORTAC	7500
THURMAN, CO VORTAC	MCJEF, NE FIX	*7000
*6500 - MOCA		
MCJEF, NE FIX	HAYES CENTER, NE VORTAC	*7000
*5600 - MOCA		
HAYES CENTER, NE VORTAC	NORTH PLATTE, NE VOR/DME	*4900
*4500 - MOCA		
NORTH PLATTE, NE VOR/DME	O'NEILL, NE VORTAC	*5400
*4400 - MOCA		
O'NEILL, NE VORTAC	TYNDA, SD FIX	*4000
*3500 - MOCA		
TYNDA, SD FIX	DOLTS, SD FIX	*4000
*3200 - MOCA		
DOLTS, SD FIX	SIOUX FALLS, SD VORTAC	3400
SIOUX FALLS, SD VORTAC	REDWOOD FALLS, MN VOR/DME	3700
REDWOOD FALLS, MN VOR/DME	MAYER, MN FIX	2800
MAYER, MN FIX	GOPHER, MN VORTAC	3000
IRONWOOD, MI VOR/DME	HOUGHTON, MI VOR/DME	*3700
*3200 - MOCA		

**95.6150 VOR FEDERAL AIRWAY V150**

SAN FRANCISCO, CA VOR/DME	SUTRO, CA FIX	3500
SUTRO, CA FIX	GOBBS, CA FIX	3000
GOBBS, CA FIX	SAUSALITO, CA VOR/DME	4000
SAUSALITO, CA VOR/DME	COMMO, CA FIX	4000
COMMO, CA FIX	REBAS, CA FIX	
	SW BND	4000
	NE BND	3000
REBAS, CA FIX	EMBER, CA FIX	3000
EMBER, CA FIX	SACRAMENTO, CA VORTAC	
	NE BND	2000
	SW BND	3000

**95.6152 VOR FEDERAL AIRWAY V152**

ST PETERSBURG, FL VORTAC	JENSN, FL FIX	*4000
*2500 - MOCA		
*2500 - GNSS MEA		
JENSN, FL FIX	KIZER, FL FIX	*GNSS - 2800
*ORMOND BEACH R-211 UNUSABLE BYD 26NM		
KIZER, FL FIX	ORMOND BEACH, FL VORTAC	
	NE BND	*3600
	SW BND	*5000
*2800 - MOCA		

**95.6154 VOR FEDERAL AIRWAY V154**

ROME, GA VORTAC	*TIROE, GA FIX	4000
		MAA - 7000
*4000 - MRA		
DUBLIN, GA VORTAC	OCONE, GA FIX	UNUSABLE
OCONE, GA FIX	*LOTTTS, GA FIX	UNUSABLE
*11000 - MRA		
LOTTTS, GA FIX	SAVANNAH, GA VORTAC	*3000
*1800 - MOCA		

**95.6155 VOR FEDERAL AIRWAY V155**

COLUMBUS, GA VORTAC	SINCA, GA FIX	*4500
*2500 - MOCA		

FROM TO MEA

**95.6155 VOR FEDERAL AIRWAY V155 - CONTINUED**

SINCA, GA FIX	BEYLO, GA FIX	*5000
*2400 - MOCA		
*2400 - GNSS MEA		
BEYLO, GA FIX	COLLIERS, SC VORTAC	*3000
*2100 - MOCA		
COLLIERS, SC VORTAC	*WIDER, SC FIX	2500
*4000 - MRA		
WIDER, SC FIX	*BLOTS, SC FIX	2500
*4000 - MRA		
BLOTS, SC FIX	CHESTERFIELD, SC VOR/DME	2300
CHESTERFIELD, SC VOR/DME	LILLS, NC FIX	2300
LILLS, NC FIX	SANDHILLS, NC VORTAC	*8000
*2000 - MOCA		
*2400 - GNSS MEA		
SANDHILLS, NC VORTAC	RALEIGH/DURHAM, NC VORTAC	2500
RALEIGH/DURHAM, NC VORTAC	WIPER, NC FIX	2300
WIPER, NC FIX	LAWRENCEVILLE, VA VORTAC	*8000
*2000 - MOCA		
*2300 - GNSS MEA		
*LAWRENCEVILLE R-225 UNUSABLE, USE RALEIGH/DURHAM R-046		
LAWRENCEVILLE, VA VORTAC	*MANGE, VA FIX	**4000
*5000 - MRA		
**2000 - GNSS MEA		
**LAWRENCEVILLE R-042 UNUSABLE, USE RICHMOND R-223		
MANGE, VA FIX	FLAT ROCK, VA VORTAC	*5000
*1800 - MOCA		
*2000 - GNSS MEA		
FLAT ROCK, VA VORTAC	FALKO, VA FIX	2000
FALKO, VA FIX	BROOKE, VA VORTAC	*6000
*1700 - MOCA		
*2000 - GNSS MEA		

**95.6156 VOR FEDERAL AIRWAY V156**

CEDAR RAPIDS, IA VOR/DME	MOSCO, IA FIX	3200
MOSCO, IA FIX	MOLINE, IL VOR/DME	2600
MOLINE, IL VOR/DME	BRADFORD, IL VORTAC	2800
BRADFORD, IL VORTAC	PEOTONE, IL VORTAC	2700
PEOTONE, IL VORTAC	LUCIT, IN FIX	2500
LUCIT, IN FIX	MAPPS, IN FIX	*4000
*2400 - MOCA		
MAPPS, IN FIX	KNOX, IN VOR/DME	*3000
*2200 - MOCA		
KNOX, IN VOR/DME	GIPPER, MI VORTAC	2600
GIPPER, MI VORTAC	KALAMAZOO, MI VOR/DME	3000

**95.6157 VOR FEDERAL AIRWAY V157**

KEY WEST, FL VORTAC	DVALL, FL FIX	*5000
*1400 - MOCA		
*3000 - GNSS MEA		
DVALL, FL FIX	*FAMIN, FL FIX	**5000
*5700 - MRA		
**1300 - MOCA		
**3000 - GNSS MEA		
FAMIN, FL FIX	DOLPHIN, FL VORTAC	*5000
*1600 - MOCA		
*3000 - GNSS MEA		
DOLPHIN, FL VORTAC	THNDR, FL FIX	*3000
*1500 - MOCA		

FROM TO MEA

**95.6157 VOR FEDERAL AIRWAY V157 - CONTINUED**

THNDR, FL FIX *1600 - MOCA	LA BELLE, FL VORTAC	*3000
LA BELLE, FL VORTAC *1500 - MOCA	RINSE, FL FIX	*2000
RINSE, FL FIX	LAKELAND, FL VORTAC	2300
LAKELAND, FL VORTAC	OCALA, FL VORTAC	2000
OCALA, FL VORTAC	TAYLOR, FL VORTAC	2000
TAYLOR, FL VORTAC	WAYCROSS, GA VORTAC	2300
WAYCROSS, GA VORTAC *ALMA R-189 UNUSABLE USE WAYCROSS R-009.	ALMA, GA VORTAC	*2000
ALMA, GA VORTAC *11000 - MRA *11000 - MCA LOTTTS, GA FIX , NE BND **2000 - GNSS MEA	*LOTTTS, GA FIX	**10000
LOTTTS, GA FIX *1800 - MOCA *2000 - GNSS MEA	ALLENDALE, SC VOR	*11000
ALLENDALE, SC VOR *13000 - MCA VANCE, SC VORTAC , NE BND **2000 - GNSS MEA	*VANCE, SC VORTAC	**6000
VANCE, SC VORTAC *12000 - MCA FLORENCE, SC VORTAC , SW BND **2000 - GNSS MEA **VANCE R-047 UNUSABLE, USE FLORENCE R-224.	*FLORENCE, SC VORTAC	**13000
FLORENCE, SC VORTAC	FAYETTEVILLE, NC VOR/DME	2300
FAYETTEVILLE, NC VOR/DME *1900 - MOCA	KINSTON, NC VORTAC	*2000
KINSTON, NC VORTAC	TAR RIVER, NC VORTAC	2200
TAR RIVER, NC VORTAC *2500 - MOCA *LAWRENCEVILLE R-177 UNUSABLE BELOW 6000, USE TAR RIVER R-354.	LAWRENCEVILLE, VA VORTAC	*4500
LAWRENCEVILLE, VA VORTAC *2000 - GNSS MEA *LAWRENCEVILLE R-042 UNUSABLE.	DALTO, VA FIX	*4000
DALTO, VA FIX	RICHMOND, VA VORTAC	2000
RICHMOND, VA VORTAC *5000 - MCA TAPPA, VA FIX , NE BND	*TAPPA, VA FIX	2000
TAPPA, VA FIX *1500 - MOCA *2000 - GNSS MEA	PATUXENT, MD VORTAC	*5000
PATUXENT, MD VORTAC *8000 - MRA **1500 - MOCA **4000 - GNSS MEA	*GARED, MD FIX	**4500
GARED, MD FIX *1500 - MOCA *4000 - GNSS MEA	CHOPS, MD FIX	*4500
CHOPS, MD FIX *1500 - MOCA	SMYRNA, DE VORTAC	*2000
SMYRNA, DE VORTAC *1500 - MOCA	WOODSTOWN, NJ VORTAC	*1900
WOODSTOWN, NJ VORTAC *2000 - MOCA	ROBBINSVILLE, NJ VORTAC	*3000
ROBBINSVILLE, NJ VORTAC	MINKS, NJ FIX	2000
MINKS, NJ FIX	LA GUARDIA, NY VOR/DME	2900
LA GUARDIA, NY VOR/DME	FAMMA, NY FIX	2000
FAMMA, NY FIX	HAARP, CT FIX	3000
HAARP, CT FIX *2800 - MOCA *4000 - GNSS MEA	KINGSTON, NY VOR/DME	*7000



FROM TO MEA

**95.6157 VOR FEDERAL AIRWAY V157 - CONTINUED**

KINGSTON, NY VOR/DME	*WIGAN, NY FIX	3100
*8000 - MCA WIGAN, NY FIX , N BND		
WIGAN, NY FIX	GROUP, NY FIX	*8000
*3000 - GNSS MEA		
GROUP, NY FIX	*ALBANY, NY VORTAC	**6000
*6000 - MCA ALBANY, NY VORTAC , BND		
**2800 - GNSS MEA		

**95.6158 VOR FEDERAL AIRWAY V158**

MASON CITY, IA VOR/DME	POUND, IA FIX	3000
POUND, IA FIX	DUBUQUE, IA VORTAC	*6000
*3100 - MOCA		
DUBUQUE, IA VORTAC	POLO, IL VOR/DME	2800
POLO, IL VOR/DME	SHOOF, IL FIX	2700

**95.6159 VOR FEDERAL AIRWAY V159**

VIRGINIA KEY, FL VOR/DME	*NITNY, FL FIX	2100
*3000 - MCA NITNY, FL FIX , N BND		
NITNY, FL FIX	JUPEM, FL FIX	3000
JUPEM, FL FIX	TREASURE, FL VORTAC	2600
TREASURE, FL VORTAC	*PRESK, FL FIX	3000
*2500 - MRA		
PRESK, FL FIX	ORLANDO, FL VORTAC	2000
ORLANDO, FL VORTAC	*SHIMM, FL FIX	2000
*3000 - MRA		
SHIMM, FL FIX	OCALA, FL VORTAC	2000
OCALA, FL VORTAC	*PERSE, FL FIX	2000
*3000 - MRA		
PERSE, FL FIX	*WILON, FL FIX	2000
*3000 - MRA		
WILON, FL FIX	CROSS CITY, FL VORTAC	2000
CROSS CITY, FL VORTAC	GREENVILLE, FL VORTAC	2000
GREENVILLE, FL VORTAC	*SALER, GA FIX	UNUSABLE
*3000 - MRA		
SALER, GA FIX	PECAN, GA VOR/DME	*2000
*1700 - MOCA		
PECAN, GA VOR/DME	*SHANY, GA FIX	2200
*4000 - MRA		
SHANY, GA FIX	EUFAULA, AL VORTAC	2200
EUFAULA, AL VORTAC	TUSKEGEE, AL VOR/DME	2000
TUSKEGEE, AL VOR/DME	KENTT, AL FIX	*2600
*1900 - MOCA		
KENTT, AL FIX	KYLEE, AL FIX	3800
KYLEE, AL FIX	VULCAN, AL VORTAC	3800
HOLLY SPRINGS, MS VORTAC	GILMORE, AR VOR/DME	2500
GILMORE, AR VOR/DME	WALNUT RIDGE, AR VORTAC	2800
WALNUT RIDGE, AR VORTAC	DOGWOOD, MO VORTAC	*3400
*3000 - MOCA		
DOGWOOD, MO VORTAC	SPRINGFIELD, MO VORTAC	4300
SPRINGFIELD, MO VORTAC	TRALE, MO FIX	3000
TRALE, MO FIX	HODEN, MO FIX	*4000
*2400 - MOCA		
HODEN, MO FIX	NAPOLEON, MO VORTAC	3000
NAPOLEON, MO VORTAC	ST JOSEPH, MO VORTAC	2900
ST JOSEPH, MO VORTAC	VIKKI, IA FIX	3000
VIKKI, IA FIX	OMAHA, IA VORTAC	3400

**95.6160 VOR FEDERAL AIRWAY V160**

*BLUE MESA, CO VOR/DME	MURFE, CO FIX	16400
*13100 - MCA BLUE MESA, CO VOR/DME , NE BND		

FROM TO MEA

**95.6160 VOR FEDERAL AIRWAY V160 - CONTINUED**

MURFE, CO FIX	*LARKS, CO FIX	**15000
*15600 - MRA		
**14400 - MOCA		
LARKS, CO FIX	*SIGNE, CO FIX	**14400
*11500 - MCA SIGNE, CO FIX , SW BND		
**13800 - MOCA		
SIGNE, CO FIX	FALCON, CO VORTAC	8800
FALCON, CO VORTAC	WITNE, CO FIX	8000
WITNE, CO FIX	SAYGE, CO FIX	*8000
*7200 - MOCA		
SAYGE, CO FIX	TUMBL, CO FIX	*8000
*6800 - MOCA		
TUMBL, CO FIX	SIDNEY, NE VOR/DME	*8000
*6800 - MOCA		

**95.6161 VOR FEDERAL AIRWAY V161**

THREE RIVERS, TX VORTAC	LEMIG, TX FIX	2000
LEMIG, TX FIX	CENTER POINT, TX VORTAC	4100
CENTER POINT, TX VORTAC	LLANO, TX VORTAC	4000
LLANO, TX VORTAC	BUILT, TX FIX	*6000
*3400 - MOCA		
BUILT, TX FIX	*DUFFA, TX FIX	**6000
*6000 - MRA		
**2900 - MOCA		
DUFFA, TX FIX	MILLSAP, TX VORTAC	3000
MILLSAP, TX VORTAC	BOWIE, TX VORTAC	3000
BOWIE, TX VORTAC	ARDMORE, OK VORTAC	3000
ARDMORE, OK VORTAC	OKMULGEE, OK VOR/DME	3000
OKMULGEE, OK VOR/DME	TULSA, OK VORTAC	3200
BUTLER, MO VORTAC	NAPOLEON, MO VORTAC	2900
NAPOLEON, MO VORTAC	LAMONI, IA VOR/DME	2900
LAMONI, IA VOR/DME	*WIVEY, IA FIX	3000
*4300 - MRA		
WIVEY, IA FIX	DES MOINES, IA VORTAC	3000
DES MOINES, IA VORTAC	*ANKEN, IA FIX	2700
*3500 - MCA ANKEN, IA FIX , N BND		
ANKEN, IA FIX	NEVAD, IA FIX	4000
NEVAD, IA FIX	ALOCK, IA FIX	*3300
*2800 - MOCA		
ALOCK, IA FIX	MASON CITY, IA VOR/DME	3000
MASON CITY, IA VOR/DME	ROCHESTER, MN VOR/DME	3000
ROCHESTER, MN VOR/DME	FARMINGTON, MN VORTAC	3000
FARMINGTON, MN VORTAC	GOPHER, MN VORTAC	*3500
*2800 - MOCA		
INTERNATIONAL FALLS, MN VOR/DME	U.S. CANADIAN BORDER	3000
U.S. CANADIAN BORDER	U.S. CANADIAN BORDER	*11000
*2400 - MOCA		

**95.6162 VOR FEDERAL AIRWAY V162**

HARRISBURG, PA VORTAC	BOBSS, PA FIX	UNUSABLE
BOBSS, PA FIX	EAST TEXAS, PA VOR/DME	3000
EAST TEXAS, PA VOR/DME	ALLENTOWN, PA VORTAC	*3000
*ALLENTOWN R-240 UNUSABLE BELOW 9000 USE EAST TEXAS R-059		
ALLENTOWN, PA VORTAC	HUGUENOT, NY VOR/DME	3500

**95.6163 VOR FEDERAL AIRWAY V163**

U.S. MEXICAN BORDER	BROWNSVILLE, TX VORTAC	*2000
*1400 - MOCA		

FROM TO MEA

**95.6163 VOR FEDERAL AIRWAY V163 - CONTINUED**

BROWNSVILLE, TX VORTAC	RELAX, TX FIX	1800
RELAX, TX FIX	MANNY, TX FIX	*5000
*1800 - MOCA		
*1800 - GNSS MEA		
MANNY, TX FIX	ASCOT, TX FIX	*5000
*1500 - MOCA		
ASCOT, TX FIX	SOLON, TX FIX	
	N BND	*4000
	S BND	*5000
*1600 - MOCA		
SOLON, TX FIX	CORPUS CHRISTI, TX VORTAC	1800
CORPUS CHRISTI, TX VORTAC	SINTO, TX FIX	1800
SINTO, TX FIX	THREE RIVERS, TX VORTAC	2000
THREE RIVERS, TX VORTAC	YENNS, TX FIX	
	S BND	2000
	N BND	3000
YENNS, TX FIX	SAN ANTONIO, TX VORTAC	*3000
*2500 - MOCA		
SAN ANTONIO, TX VORTAC	SLIMM, TX FIX	*3500
*2900 - MOCA		
SLIMM, TX FIX	GOOCH SPRINGS, TX VORTAC	*3500
*3000 - MOCA		

**95.6164 VOR FEDERAL AIRWAY V164**

STONYFORK, PA VOR/DME	WILLIAMSPORT, PA VOR/DME	4000
WILLIAMSPORT, PA VOR/DME	DIANO, PA FIX	4000
DIANO, PA FIX	EAST TEXAS, PA VOR/DME	*4000
*3500 - MOCA		

**95.6165 VOR FEDERAL AIRWAY V165**

MISSION BAY, CA VORTAC	SARGS, CA FIX	3000
SARGS, CA FIX	OCEANSIDE, CA VORTAC	2500
OCEANSIDE, CA VORTAC	BALBO, CA FIX	4000
BALBO, CA FIX	SEAL BEACH, CA VORTAC	
	NW BND	3000
	SE BND	4000
SEAL BEACH, CA VORTAC	LOS ANGELES, CA VORTAC	2500
LOS ANGELES, CA VORTAC	*VALEY, CA FIX	4000
*5600 - MCA VALEY, CA FIX , N BND		
VALEY, CA FIX	*SAUGS, CA FIX	6200
*6700 - MCA SAUGS, CA FIX , NW BND		
SAUGS, CA FIX	LAKE HUGHES, CA VORTAC	8000
LAKE HUGHES, CA VORTAC	JEFFY, CA FIX	8000
JEFFY, CA FIX	*LOPES, CA FIX	9000
*8600 - MCA LOPES, CA FIX , S BND		
LOPES, CA FIX	*ARVIN, CA FIX	8500
*7300 - MCA ARVIN, CA FIX , SE BND		
ARVIN, CA FIX	SHAFTER, CA VORTAC	3000
SHAFTER, CA VORTAC	TULE, CA VOR/DME	3000
TULE, CA VOR/DME	EXTRA, CA FIX	3500
MARRI, CA FIX	*MUSTANG, NV VORTAC	**13000
*10000 - MCA MUSTANG, NV VORTAC , S BND		
**11000 - MOCA		
MUSTANG, NV VORTAC	PYRAM, NV FIX	*11000
*9700 - MOCA		
*10000 - GNSS MEA		
PYRAM, NV FIX	BINNZ, NV FIX	
	NW BND	*14000
	SE BND	*12000
*11000 - MOCA		
*11000 - GNSS MEA		

FROM TO MEA

**95.6165 VOR FEDERAL AIRWAY V165 - CONTINUED**

BINNZ, NV FIX *12200 - MOCA	CHOIR, CA FIX	*14000
CHOIR, CA FIX	LAKEVIEW, OR VORTAC SE BND	*14000
*10500 - MOCA	NW BND	*11000
LAKEVIEW, OR VORTAC	URBIA, OR FIX	9500
URBIA, OR FIX	*DESCHUTES, OR VORTAC SE BND	9500
	NW BND	7000
*9300 - MCA DESCHUTES, OR VORTAC , NW BND		
DESCHUTES, OR VORTAC	BOTTL, OR FIX NW BND	12500
	SE BND	7000
BOTTL, OR FIX	WALDO, OR FIX	12500
WALDO, OR FIX	ELKES, OR FIX NW BND	7800
	SE BND	12500
ELKES, OR FIX	*MAVER, OR FIX SE BND	12500
	NW BND	7000
*9400 - MCA MAVER, OR FIX , SE BND		
MAVER, OR FIX	RAWER, OR FIX	*5000
*3600 - MOCA		
RAWER, OR FIX	NEWBERG, OR VOR/DME	4000
NEWBERG, OR VOR/DME	PITER, OR FIX	4400
PITER, OR FIX	CETRA, WA FIX	6000
CETRA, WA FIX	OLYMPIA, WA VORTAC N BND	4000
	S BND	6000
OLYMPIA, WA VORTAC	*CARRO, WA FIX	**4000
*4000 - MRA		
**2000 - MOCA		
CARRO, WA FIX	DIGGN, WA FIX	*6000
*5000 - MOCA		
DIGGN, WA FIX	PENN COVE, WA VOR/DME	*5000
*2600 - MOCA		
PENN COVE, WA VOR/DME	ISLND, WA FIX	*5000
*1500 - MOCA		
ISLND, WA FIX	CANDL, WA FIX	*5000
*2800 - MOCA		
CANDL, WA FIX	WHATCOM, WA VORTAC	*4000
*1900 - MOCA		

**95.6166 VOR FEDERAL AIRWAY V166**

PARKERSBURG, WV VOR/DME	MOSIC, WV FIX	3000
MOSIC, WV FIX	CLARKSBURG, WV VOR/DME	*3600
*3100 - MOCA		
CLARKSBURG, WV VOR/DME	TYGAR, WV FIX	3600
TYGAR, WV FIX	UGJOB, WV FIX	4700
UGJOB, WV FIX	KESSEL, WV VOR/DME	6300
KESSEL, WV VOR/DME	CAPON, WV FIX	*5000
*4500 - MOCA		
CAPON, WV FIX	MARTINSBURG, WV VORTAC	*5000
*3500 - MOCA		
MARTINSBURG, WV VORTAC	WESTMINSTER, MD VORTAC	*4000
*3300 - MOCA		
WESTMINSTER, MD VORTAC	BELAY, MD FIX	*3000
*2500 - MOCA		

FROM TO MEA

**95.6166 VOR FEDERAL AIRWAY V166 - CONTINUED**

BELAY, MD FIX *6000 - MRA	*BAINS, MD FIX	2000
BAINS, MD FIX	DUPONT, DE VORTAC	2000
DUPONT, DE VORTAC	WOODSTOWN, NJ VORTAC	2000
		MAA - 8000
WOODSTOWN, NJ VORTAC	BRIEF, NJ FIX	1900
BRIEF, NJ FIX	SEA ISLE, NJ VORTAC	3000

**95.6167 VOR FEDERAL AIRWAY V167**

HANCOCK, NY VOR/DME	HELON, NY FIX	4100
HELON, NY FIX	KINGSTON, NY VOR/DME	4000
KINGSTON, NY VOR/DME	HARTFORD, CT VOR/DME	3200
HARTFORD, CT VOR/DME *2100 - MOCA	JEWIT, CT FIX	*2600
JEWIT, CT FIX	PROVIDENCE, RI VOR/DME	2500
PROVIDENCE, RI VOR/DME *1800 - MOCA	ZUNUX, MA FIX	*2500
ZUNUX, MA FIX *1800 - MOCA	PEAKE, MA FIX	*3000
PEAKE, MA FIX *1600 - MOCA	MARCONI, MA VOR/DME	*3000
MARCONI, MA VOR/DME *1600 - MOCA *4000 - GNSS MEA	KENNEBUNK, ME VOR/DME	*6000

**95.6168 VOR FEDERAL AIRWAY V168**

VULCAN, AL VORTAC	LAGRANGE, GA VORTAC	4000
LAGRANGE, GA VORTAC *6000 - MCA MILER, AL FIX , S BND *2600 - MCA MILER, AL FIX , N BND	*MILER, AL FIX	2600
MILER, AL FIX *6000 - MCA WIREGRASS, AL VORTAC , BND **3000 - GNSS MEA	*WIREGRASS, AL VORTAC	**6000

**95.6169 VOR FEDERAL AIRWAY V169**

TOBE, CO VOR/DME	HUGO, CO VOR/DME	8100
HUGO, CO VOR/DME	THURMAN, CO VORTAC	7300
THURMAN, CO VORTAC *6200 - MOCA	AKRON, CO VOR/DME	*7000
AKRON, CO VOR/DME	SIDNEY, NE VOR/DME	6400
SIDNEY, NE VOR/DME *6000 - MOCA	SCOTTSBLUFF, NE VORTAC	*7000
SCOTTSBLUFF, NE VORTAC	TOADSTOOL, NE VOR/DME	7000
TOADSTOOL, NE VOR/DME	WAXER, NE FIX	7000
WAXER, NE FIX	RAPID CITY, SD VORTAC	6000
RAPID CITY, SD VORTAC	DUPREE, SD VOR/DME	5000
DUPREE, SD VOR/DME	BISMARCK, ND VOR/DME	4700
BISMARCK, ND VOR/DME	DEVILS LAKE, ND VOR/DME	4000

**95.6170 VOR FEDERAL AIRWAY V170**

DEVILS LAKE, ND VOR/DME	JAMESTOWN, ND VOR/DME	3500
JAMESTOWN, ND VOR/DME	ABERDEEN, SD VOR/DME	3300
ABERDEEN, SD VOR/DME *3400 - MOCA	SIOUX FALLS, SD VORTAC	*5000
ROCHESTER, MN VOR/DME	NODINE, MN VORTAC	3000

FROM TO MEA

**95.6170 VOR FEDERAL AIRWAY V170 - CONTINUED**

NODINE, MN VORTAC	DELLS, WI VORTAC	3000
DELLS, WI VORTAC	BADGER, WI VOR/DME	3000
BADGER, WI VOR/DME	PETTY, WI FIX	2700
PETTY, WI FIX	RAINE, MI WP	UNUSABLE
RAINE, MI WP	PULLMAN, MI VOR/DME	UNUSABLE
PULLMAN, MI VOR/DME	HEBEL, MI FIX	UNUSABLE
HEBEL, MI FIX	LESSY, MI FIX	UNUSABLE
LESSY, MI FIX	SALEM, MI VORTAC	3000
SLATE RUN, PA VORTAC	SELINGROVE, PA VOR/DME	4000
SELINGROVE, PA VOR/DME	RAVINE, PA VORTAC	*4000
*3400 - MOCA		
RAVINE, PA VORTAC	BOYER, PA FIX	3500
BOYER, PA FIX	MODENA, PA VORTAC	*3000
*2400 - MOCA		
MODENA, PA VORTAC	DUPONT, DE VORTAC	*3000
*1800 - MOCA		
*2000 - GNSS MEA		
DUPONT, DE VORTAC	ODESA, MD FIX	*2000
*2000 - GNSS MEA		
*DUPONT R 233 UNUSABLE BEYOND 22 NM.		
ODESA, MD FIX	SWANN, MD FIX	UNUSABLE
SWANN, MD FIX	PALEO, MD FIX	UNUSABLE
PALEO, MD FIX	POLLA, MD FIX	2200
		MAA - 13000

**95.6171 VOR FEDERAL AIRWAY V171**

LEXINGTON, KY VOR/DME	MCREE, KY FIX	3000
MCREE, KY FIX	LOUISVILLE, KY VORTAC	2600
LOUISVILLE, KY VORTAC	SCOTO, IN FIX	*10000
*3000 - MOCA		
SCOTO, IN FIX	TERRE HAUTE, IN VORTAC	*4000
*3000 - MOCA		
TERRE HAUTE, IN VORTAC	DANVILLE, IL VORTAC	2500
DANVILLE, IL VORTAC	PEOTONE, IL VORTAC	2500
PEOTONE, IL VORTAC	MEDAN, IL FIX	2400
MEDAN, IL FIX	JOLIET, IL VOR/DME	2400
NODINE, MN VORTAC	EMILS, MN FIX	3000
EMILS, MN FIX	FARMINGTON, MN VORTAC	*5500
*3000 - GNSS MEA		
FARMINGTON, MN VORTAC	JONNA, MN FIX	*3500
*2500 - MOCA		
*3000 - GNSS MEA		
JONNA, MN FIX	DARWIN, MN VORTAC	2900
DARWIN, MN VORTAC	ALEXANDRIA, MN VOR/DME	3000
ALEXANDRIA, MN VOR/DME	STARR, MN FIX	*3500
*3000 - MOCA		
STARR, MN FIX	*SHELS, MN FIX	**6000
*4000 - MRA		
**3500 - MOCA		
SHELS, MN FIX	GRAND FORKS, ND VOR/DME	3000
GRAND FORKS, ND VOR/DME	ROSEAU, MN VOR/DME	2900

**95.6172 VOR FEDERAL AIRWAY V172**

NORTH PLATTE, NE VOR/DME	WOLBACH, NE VORTAC	*5400
*4500 - MOCA		
WOLBACH, NE VORTAC	COLUMBUS, NE VOR/DME	3800
COLUMBUS, NE VOR/DME	OMAHA, IA VORTAC	3700

FROM TO MEA

**95.6172 VOR FEDERAL AIRWAY V172 - CONTINUED**

OMAHA, IA VORTAC	WUNOT, IA FIX	
	NE BND	5500
	SW BND	4000
WUNOT, IA FIX	*LINDE, IA FIX	**5500
*5500 - MRA		
**3800 - MOCA		
LINDE, IA FIX	GUMBO, IA FIX	3500
GUMBO, IA FIX	NEWTON, IA VOR/DME	3300
NEWTON, IA VOR/DME	CEDAR RAPIDS, IA VOR/DME	2800
CEDAR RAPIDS, IA VOR/DME	LISBO, IA FIX	2700
LISBO, IA FIX	LOTTE, IA FIX	3300
LOTTE, IA FIX	MIHAL, IL FIX	2700
MIHAL, IL FIX	POLO, IL VOR/DME	2700
POLO, IL VOR/DME	DUPAGE, IL VOR/DME	2600

**95.6173 VOR FEDERAL AIRWAY V173**

SPINNER, IL VORTAC	PEOTONE, IL VORTAC	4500
--------------------	--------------------	------

**95.6175 VOR FEDERAL AIRWAY V175**

VICHY, MO VOR/DME	ZIPUR, MO FIX	*3000
*2500 - MOCA		
ZIPUR, MO FIX	HALLSVILLE, MO VORTAC	2700
KIRKSVILLE, MO VORTAC	OHGEE, IA FIX	2800
OHGEE, IA FIX	DES MOINES, IA VORTAC	*7000
*2500 - MOCA		
*DES MOINES R-141 UNUSABLE, USE KIRKSVILLE R-323		
REDWOOD FALLS, MN VOR/DME	ALEXANDRIA, MN VOR/DME	3600

**95.6178 VOR FEDERAL AIRWAY V178**

HALLSVILLE, MO VORTAC	BNTON, MO FIX	2800
BNTON, MO FIX	VICHY, MO VOR/DME	*2800
*2200 - MOCA		
VICHY, MO VOR/DME	FARMINGTON, MO VORTAC	3300
NEW HOPE, KY VOR/DME	MAUDD, KY FIX	2700
MAUDD, KY FIX	MCREE, KY FIX	5000
MCREE, KY FIX	LEXINGTON, KY VOR/DME	3000
LEXINGTON, KY VOR/DME	TRENT, KY FIX	
	W BND	3400
	E BND	8000
TRENT, KY FIX	SLINK, WV FIX	*8000
*4200 - GNSS MEA		
SLINK, WV FIX	BLUEFIELD, WV VOR/DME	
	E BND	6300
	W BND	8000

**95.6179 VOR FEDERAL AIRWAY V179**

BRUNSWICK, GA VORTAC	DUBLIN, GA VORTAC	2000
DUBLIN, GA VORTAC	HUSKY, GA FIX	*3000
*2200 - MOCA		

**95.6181 VOR FEDERAL AIRWAY V181**

KIRKSVILLE, MO VORTAC	LAMONI, IA VOR/DME	2900
LAMONI, IA VOR/DME	OMAHA, IA VORTAC	3000
OMAHA, IA VORTAC	NORFOLK, NE VOR/DME	3600

FROM TO MEA

**95.6181 VOR FEDERAL AIRWAY V181 - CONTINUED**

NORFOLK, NE VOR/DME	YANKTON, SD VOR/DME	3700
YANKTON, SD VOR/DME	SIoux FALLS, SD VORTAC	3400
FARGO, ND VOR/DME	GRAND FORKS, ND VOR/DME	2600

**95.6182 VOR FEDERAL AIRWAY V182**

NORTH BEND, OR VOR/DME	*GAMMA, OR FIX	
	S BND	4000
	N BND	4500
*6200 - MRA		
GAMMA, OR FIX	NEWPORT, OR VORTAC	4500
NEWPORT, OR VORTAC	NEWBERG, OR VOR/DME	6000
NEWBERG, OR VOR/DME	*BATTLE GROUND, WA VORTAC	4100
*5000 - MCA BATTLE GROUND, WA VORTAC , E BND		
BATTLE GROUND, WA VORTAC	KLICKITAT, OR VOR/DME	*7000
*6500 - MOCA		
KLICKITAT, OR VOR/DME	*BREED, OR FIX	5300
*5700 - MRA		
BREED, OR FIX	*UKIAH, OR FIX	8000
*9400 - MCA UKIAH, OR FIX , E BND		
UKIAH, OR FIX	*BAKER CITY, OR VOR/DME	**13000
*10000 - MCA BAKER CITY, OR VOR/DME , W BND		
**11000 - MOCA		
BAKER CITY, OR VOR/DME	*IBEAM, OR FIX	9000
*12000 - MCA IBEAM, OR FIX , NE BND		
IBEAM, OR FIX	LEZLE, WA FIX	*12000
*8100 - MOCA		
LEZLE, WA FIX	NEZ PERCE, ID VOR/DME	*7000
*6200 - MOCA		

**95.6183 VOR FEDERAL AIRWAY V183**

*SAN MARCUS, CA VORTAC	**TAFTO, CA FIX	9000
*7500 - MCA SAN MARCUS, CA VORTAC , N BND		
**6000 - MCA TAFTO, CA FIX , S BND		
TAFTO, CA FIX	*MARIC, CA FIX	**6000
*5000 - MCA MARIC, CA FIX , S BND		
**4500 - MOCA		
MARIC, CA FIX	*SHAFTER, CA VORTAC	3000
*5000 - MCA SHAFTER, CA VORTAC , BND		

**95.6184 VOR FEDERAL AIRWAY V184**

*PHILIPSBURG, PA VORTAC	*HARRISBURG, PA VORTAC	4900
*3600 - MCA HARRISBURG, PA VORTAC , NW BND		
*4800 MCA PHILIPSBURG, PA VORTAC, SE BND		
HARRISBURG, PA VORTAC	*DELRO, PA FIX	3000
*10000 - MCA DELRO, PA FIX , E BND		
DELRO, PA FIX	*MODENA, PA VORTAC	**10000
*10000 - MCA MODENA, PA VORTAC , W BND		
**4000 - GNSS MEA		
MODENA, PA VORTAC	WOODSTOWN, NJ VORTAC	2000
WOODSTOWN, NJ VORTAC	CEDAR LAKE, NJ VOR/DME	1900
CEDAR LAKE, NJ VOR/DME	ATLANTIC CITY, NJ VORTAC	1800
ATLANTIC CITY, NJ VORTAC	PANZE, NJ FIX	2100
PANZE, NJ FIX	FALON, NJ FIX	*5000
*1500 - MOCA		
*2000 - GNSS MEA		
FALON, NJ FIX	ZIGGI, NJ FIX	*2500
*1600 - MOCA		



FROM	TO	MEA
<b>95.6185 VOR FEDERAL AIRWAY V185</b>		
SAVANNAH, GA VORTAC	*SPONG, GA FIX	**3000
*5000 - MRA		
**2200 - MOCA		
SPONG, GA FIX	COLLIERS, SC VORTAC	*3000
*2200 - MOCA		
COLLIERS, SC VORTAC	GREENWOOD, SC VORTAC	2400
GREENWOOD, SC VORTAC	*UNMAN, SC FIX	3000
*4000 - MCA UNMAN, SC FIX , N BND		
UNMAN, SC FIX	SUGARLOAF MOUNTAIN, NC VORTAC	6000
SUGARLOAF MOUNTAIN, NC VORTAC	MUMMI, NC FIX	7000
MUMMI, NC FIX	SNOWBIRD, TN VORTAC	8000
SNOWBIRD, TN VORTAC	*PENGE, TN FIX	7000
*4000 - MCA PENGE, TN FIX , SE BND		
PENGE, TN FIX	VOLUNTEER, TN VORTAC	3000
<b>95.6186 VOR FEDERAL AIRWAY V186</b>		
SAN MARCUS, CA VORTAC	DEANO, CA FIX	6200
DEANO, CA FIX	*HENGER, CA FIX	5000
*5100 - MCA HENER, CA FIX , E BND		
HENER, CA FIX	FILLMORE, CA VORTAC	6300
FILLMORE, CA VORTAC	VAN NUYS, CA VOR/DME	6000
VAN NUYS, CA VOR/DME	TIFNI, CA FIX	5500
TIFNI, CA FIX	PARADISE, CA VORTAC	4000
PARADISE, CA VORTAC	TANNR, CA FIX	6000
TANNR, CA FIX	POGGL, CA VORTAC	5000
<b>95.6187 VOR FEDERAL AIRWAY V187</b>		
SOCORRO, NM VORTAC	ALBUQUERQUE, NM VORTAC	8000
ALBUQUERQUE, NM VORTAC	*CURLY, NM FIX	9000
*9500 - MCA CURLY, NM FIX , NW BND		
CURLY, NM FIX	MISSY, NM FIX	11000
MISSY, NM FIX	RATTLESNAKE, NM VORTAC	
	NW BND	9100
	SE BND	11000
RATTLESNAKE, NM VORTAC	RIZAL, CO FIX	9200
RIZAL, CO FIX	*MANCA, CO FIX	10900
*11200 - MCA MANCA, CO FIX , N BND		
MANCA, CO FIX	HERRM, CO FIX	*15000
*12800 - MOCA		
*MEA IS ESTABLISHED WITH A GAP IN NAVIGATION SIGNAL COVERAGE		
HERRM, CO FIX	*GRAND JUNCTION, CO VOR/DME	**15000
*10700 - MCA GRAND JUNCTION, CO VOR/DME , S BND		
**12100 - MOCA		
GRAND JUNCTION, CO VOR/DME	*TESSY, CO FIX	10000
*10500 - MRA		
*10700 - MCA TESSY, CO FIX , N BND		
TESSY, CO FIX	*RACER, CO FIX	**12000
*12000 - MRA		
**11000 - MOCA		
RACER, CO FIX	*RENAE, CO FIX	**13000
*13000 - MRA		
**10700 - MOCA		
RENAE, CO FIX	ROCK SPRINGS, WY VOR/DME	*13000
*11700 - MOCA		
ROCK SPRINGS, WY VOR/DME	RIVERTON, WY VOR/DME	*12000
*10000 - MOCA		
*10000 - GNSS MEA		

FROM TO MEA

**95.6187 VOR FEDERAL AIRWAY V187 - CONTINUED**

RIVERTON, WY VOR/DME	BOYSEN RESERVOIR, WY VOR/DME	9600
BOYSEN RESERVOIR, WY VOR/DME	PRYER, MT FIX	11000
PRYER, MT FIX	*BILLINGS, MT VORTAC	
	SE BND	11000
	NW BND	7000
*6500 - MCA BILLINGS, MT VORTAC , S BND		
BILLINGS, MT VORTAC	TASSE, MT FIX	
	NW BND	8000
	SE BND	6200
TASSE, MT FIX	*JUGAP, MT FIX	8000
*11200 - MCA JUGAP, MT FIX , NW BND		
JUGAP, MT FIX	GREAT FALLS, MT VORTAC	13000
GREAT FALLS, MT VORTAC	ROSOE, MT FIX	
	NE BND	8000
	SW BND	10000
ROSOE, MT FIX	MISSOULA, MT VOR/DME	*13000
*11400 - MOCA		
MISSOULA, MT VOR/DME	LOLLO, MT FIX	
	NE BND	*10000
	SW BND	*13000
*9300 - MOCA		
LOLLO, MT FIX	RIVAL, MT FIX	
	NE BND	*12000
	SW BND	*13000
*9000 - MOCA		
RIVAL, MT FIX	OFINO, ID FIX	*13000
*9900 - MOCA		
OFINO, ID FIX	NEZ PERCE, ID VOR/DME	
	SW BND	5500
	NE BND	10000
NEZ PERCE, ID VOR/DME	POTOR, WA FIX	*6000
*5400 - MOCA		
POTOR, WA FIX	*DATES, WA FIX	7200
*4500 - MCA DATES, WA FIX , E BND		
DATES, WA FIX	PASCO, WA VOR/DME	4000
PASCO, WA VOR/DME	NIALS, WA FIX	2900
NIALS, WA FIX	FEBUS, WA FIX	4400
FEBUS, WA FIX	*ELLENSBURG, WA VOR/DME	6000
*6700 - MCA ELLENSBURG, WA VOR/DME , W BND		
ELLENSBURG, WA VOR/DME	THICK, WA FIX	
	E BND	7700
	W BND	10000
OLYMPIA, WA VORTAC	RINDS, WA FIX	4000
RINDS, WA FIX	ASTORIA, OR VOR/DME	5000

**95.6188 VOR FEDERAL AIRWAY V188**

SLATE RUN, PA VORTAC	WILLIAMSPORT, PA VOR/DME	4000
WILLIAMSPORT, PA VOR/DME	SWANK, PA FIX	4500
SWANK, PA FIX	WILKES-BARRE, PA VORTAC	
	E BND	*4000
	W BND	*4500
*3700 - MOCA		
WILKES-BARRE, PA VORTAC	SPARTA, NJ VORTAC	4000
SPARTA, NJ VORTAC	CARMEL, NY VOR/DME	*3000
*2500 - MOCA		
CARMEL, NY VOR/DME	GROTON, CT VOR/DME	3000

**95.6189 VOR FEDERAL AIRWAY V189**

WRIGHT BROTHERS, NC VOR/DME	*DAREZ, NC FIX	**8000
*8000 - MCA DAREZ, NC FIX , E BND		
**3000 - GNSS MEA		

FROM TO MEA

**95.6189 VOR FEDERAL AIRWAY V189 - CONTINUED**

DAREZ, NC FIX	TAR RIVER, NC VORTAC	*6000
*3000 - MOCA		
*4000 - GNSS MEA		
TAR RIVER, NC VORTAC	FRANKLIN, VA VORTAC	2000
FRANKLIN, VA VORTAC	HOPEWELL, VA VORTAC	3000

**95.6190 VOR FEDERAL AIRWAY V190**

PHOENIX, AZ VORTAC	*LAKEY, AZ FIX	5000
*7800 - MCA LAKEY, AZ FIX , NE BND		
LAKEY, AZ FIX	GRINE, AZ FIX	
	NE BND	*9000
	SW BND	*6000
*5300 - MOCA		
GRINE, AZ FIX	PEAKS, AZ FIX	*10000
*6700 - MOCA		
PEAKS, AZ FIX	TEDDI, AZ FIX	
	NE BND	13000
	SW BND	10000
TEDDI, AZ FIX	ST JOHNS, AZ VORTAC	*13000
*11000 - MOCA		
*11000 - GNSS MEA		
ST JOHNS, AZ VORTAC	ACOMA, NM FIX	11500
ACOMA, NM FIX	*ALBUQUERQUE, NM VORTAC	9000
*11500 - MCA ALBUQUERQUE, NM VORTAC , NE BND		
ALBUQUERQUE, NM VORTAC	RENCO, NM FIX	13000
RENCO, NM FIX	*FORT UNION, NM VORTAC	12000
*11300 - MCA FORT UNION, NM VORTAC , SW BND		
FORT UNION, NM VORTAC	DALHART, TX VORTAC	*10000
*9200 - MOCA		
DALHART, TX VORTAC	MITBEE, OK VORTAC	*7000
*5400 - MOCA		
MITBEE, OK VORTAC	CARON, OK FIX	
	SW BND	*5000
	NE BND	*8000
*3700 - MOCA		
CARON, OK FIX	FIRET, OK FIX	*8000
*2800 - MOCA		
FIRET, OK FIX	PIONEER, OK VORTAC	
	E BND	3000
	W BND	8000
PIONEER, OK VORTAC	BARTLESVILLE, OK VOR/DME	3000

**95.6191 VOR FEDERAL AIRWAY V191**

TROY, IL VORTAC	ADDERS, IL VORTAC	2500
ADDERS, IL VORTAC	ROBERTS, IL VOR/DME	2800
ROBERTS, IL VOR/DME	NEWTT, IL FIX	2500
NEWTT, IL FIX	*BOJAK, IL FIX	**5000
*5000 - MRA		
**2200 - MOCA		
BOJAK, IL FIX	NORTHBROOK, IL VOR/DME	2500
NORTHBROOK, IL VOR/DME	BADGER, WI VOR/DME	2900
BADGER, WI VOR/DME	OSHKOSH, WI VORTAC	3000
OSHKOSH, WI VORTAC	RHINELANDER, WI VOR/DME	*4500
*3100 - MOCA		
RHINELANDER, WI VOR/DME	IRONWOOD, MI VOR/DME	*8000
*3200 - MOCA		
IRONWOOD, MI VOR/DME	DULUTH, MN VORTAC	*3500
*3100 - MOCA		

FROM TO MEA

**95.6191 VOR FEDERAL AIRWAY V191 - CONTINUED**

DULUTH, MN VORTAC	HIBBING, MN VOR/DME	3300
HIBBING, MN VOR/DME	GRAND RAPIDS, MN VOR/DME	3000

**95.6192 VOR FEDERAL AIRWAY V192**

CHAMPAIGN, IL VORTAC	TERRE HAUTE, IN VORTAC	2500
TERRE HAUTE, IN VORTAC	BRICKYARD, IN VORTAC	2700
BRICKYARD, IN VORTAC	MUNCIE, IN VOR/DME	2900
MUNCIE, IN VOR/DME	DAYTON, OH VOR/DME	2800

**95.6193 VOR FEDERAL AIRWAY V193**

TRAVERSE CITY, MI VOR/DME	PELLSTON, MI VORTAC	3000
PELLSTON, MI VORTAC	SAULT STE MARIE, MI VOR/DME	3000

**95.6194 VOR FEDERAL AIRWAY V194**

CEDAR CREEK, TX VORTAC	KISER, TX FIX	2300
KISER, TX FIX	COLLEGE STATION, TX VORTAC	4000
SABINE PASS, TX VOR/DME	GUSTI, LA FIX	*4000
*1600 - MOCA		
GUSTI, LA FIX	LAFAYETTE, LA VORTAC	2800
LAFAYETTE, LA VORTAC	*ROSEY, LA FIX	2100
*5000 - MRA		
ROSEY, LA FIX	FIGHTING TIGER, LA VORTAC	2100
FIGHTING TIGER, LA VORTAC	MC COMB, MS VORTAC	2300
MC COMB, MS VORTAC	MIZZE, MS FIX	*3000
*2000 - MOCA		
MIZZE, MS FIX	*PAULD, MS FIX	3000
*5000 - MRA		
*3000 - MCA PAULD, MS FIX , SW BND		
PAULD, MS FIX	MERIDIAN, MS VORTAC	2100
LIBERTY, NC VORTAC	RALEIGH/DURHAM, NC VORTAC	3100
RALEIGH/DURHAM, NC VORTAC	TAR RIVER, NC VORTAC	2600
TAR RIVER, NC VORTAC	COFIELD, NC VORTAC	1800
COFIELD, NC VORTAC	SUNNS, NC FIX	*2000
*1600 - MOCA		

**95.6195 VOR FEDERAL AIRWAY V195**

OAKLAND, CA VOR/DME	CROIT, CA FIX	4000
CROIT, CA FIX	*CORDD, CA FIX	**5000
*7200 - MCA CORDD, CA FIX , N BND		
**3400 - MOCA		
CORDD, CA FIX	RAGGS, CA FIX	*8500
*5000 - MOCA		
RAGGS, CA FIX	*BESSA, CA FIX	**8500
*8500 - MCA BESSA, CA FIX , S BND		
**4800 - MOCA		
BESSA, CA FIX	WILLIAMS, CA VORTAC	5300
WILLIAMS, CA VORTAC	RED BLUFF, CA VORTAC	*3000
*1700 - MOCA		
RED BLUFF, CA VORTAC	BURRS, CA FIX	3000
BURRS, CA FIX	*TOMAD, CA FIX	**6000
*7300 - MCA TOMAD, CA FIX , W BND		
**4600 - MOCA		
TOMAD, CA FIX	*YAGER, CA FIX	**11000
*7700 - MCA YAGER, CA FIX , E BND		
**8300 - MOCA		

FROM TO MEA

**95.6195 VOR FEDERAL AIRWAY V195 - CONTINUED**

YAGER, CA FIX FORTUNA, CA VORTAC 6000

**95.6197 VOR FEDERAL AIRWAY V197**

PARADISE, CA VORTAC \*POMONA, CA VORTAC 4500  
 \*10500 - MCA POMONA, CA VORTAC , NW BND  
 POMONA, CA VORTAC HASSA, CA FIX  
 NW BND 10500  
 SE BND 6600  
 HASSA, CA FIX \*PALMDALE, CA VORTAC 10500  
 \*8700 - MCA PALMDALE, CA VORTAC , SE BND  
 PALMDALE, CA VORTAC \*FISCH, CA FIX 5000  
 \*8300 - MCA FISCH, CA FIX , NW BND  
 FISCH, CA FIX \*KELEN, CA FIX \*\*10200  
 \*9300 - MCA KELEN, CA FIX , SE BND  
 \*\*10200 - MOCA  
 KELEN, CA FIX \*ARVIN, CA FIX 8500  
 \*7300 - MCA ARVIN, CA FIX , SE BND  
 ARVIN, CA FIX SHAFTER, CA VORTAC 3000

**95.6198 VOR FEDERAL AIRWAY V198**

SAN SIMON, AZ VORTAC COLUMBUS, NM VOR/DME 8700  
 COLUMBUS, NM VOR/DME EL PASO, TX VORTAC 9000  
 EL PASO, TX VORTAC HUDSPETH, TX VORTAC 7500  
 HUDSPETH, TX VORTAC AGAZY, TX FIX \*11000  
 \*8900 - MOCA  
 AGAZY, TX FIX DOWES, TX FIX \*9000  
 \*6400 - MOCA  
 DOWES, TX FIX FORT STOCKTON, TX VORTAC 5100  
 FORT STOCKTON, TX VORTAC KEMPL, TX FIX \*8000  
 \*5500 - MOCA  
 \*MEA IS ESTABLISHED WITH A GAP IN NAVIGATION SIGNAL COVERAGE  
 KEMPL, TX FIX JUNCTION, TX VORTAC \*6000  
 \*4000 - MOCA  
 JUNCTION, TX VORTAC SAN ANTONIO, TX VORTAC 4100  
 SABINE PASS, TX VOR/DME WHITE LAKE, LA VOR/DME \*4000  
 \*1700 - MOCA  
 \*2000 - GNSS MEA  
 WHITE LAKE, LA VOR/DME TIBBY, LA VOR/DME 2000  
 TIBBY, LA VOR/DME HARVEY, LA VORTAC 2100  
 HARVEY, LA VORTAC PEARL, LA FIX 2000  
 PEARL, LA FIX MINNI, MS FIX \*2300  
 \*1300 - MOCA  
 MINNI, MS FIX ELSIE, MS FIX \*3500  
 \*1300 - MOCA  
 ELSIE, MS FIX \*ROMMY, MS FIX \*\*2800  
 \*4000 - MRA  
 \*\*1300 - MOCA  
 ROMMY, MS FIX BROOKLEY, AL VORTAC 2000  
 BROOKLEY, AL VORTAC CRESTVIEW, FL VORTAC 3100  
 CRESTVIEW, FL VORTAC DEFUN, FL FIX  
 W BND 2000  
 E BND 3000  
 DEFUN, FL FIX \*CHEWS, FL FIX \*\*3000  
 \*2500 - MCA CHEWS, FL FIX , W BND  
 \*\*1800 - MOCA  
 CHEWS, FL FIX MARIANNA, FL VORTAC 2000  
 MARIANNA, FL VORTAC \*SNEAD, FL FIX 2000  
 \*3000 - MRA

FROM TO MEA

**95.6198 VOR FEDERAL AIRWAY V198 - CONTINUED**

SNEAD, FL FIX	SEMINOLE, FL VORTAC	2000
SEMINOLE, FL VORTAC	GREENVILLE, FL VORTAC	*2100
*GREENVILLE R-270 UNUSABLE USE SEMINOLE R-088		
GREENVILLE, FL VORTAC	TAYLOR, FL VORTAC	2000
TAYLOR, FL VORTAC	CRAIG, FL VORTAC	*3000
*2100 - MOCA		

**95.6199 VOR FEDERAL AIRWAY V199**

SAN FRANCISCO, CA VOR/DME	SUTRO, CA FIX	3500
SUTRO, CA FIX	GOBBS, CA FIX	3000
GOBBS, CA FIX	STINS, CA FIX	3500
STINS, CA FIX	DUBRY, CA FIX	4500
DUBRY, CA FIX	MENDOCINO, CA VORTAC	6000
MENDOCINO, CA VORTAC	*HENLE, CA FIX	9000
*9000 - MCA HENLE, CA FIX , S BND		
HENLE, CA FIX	RED BLUFF, CA VORTAC	
	N BND	3200
	S BND	9000

**95.6200 VOR FEDERAL AIRWAY V200**

MENDOCINO, CA VORTAC	WILLIAMS, CA VORTAC	6200
WILLIAMS, CA VORTAC	YUBBA, CA FIX	4000
YUBBA, CA FIX	*RANGO, CA FIX	5000
*8500 - MCA RANGO, CA FIX , E BND		
RANGO, CA FIX	SIGNA, CA FIX	*11000
*10000 - MOCA		
SIGNA, CA FIX	MUSTANG, NV VORTAC	11500
BONNEVILLE, UT VORTAC	*STACO, UT FIX	9000
*11000 - MCA STACO, UT FIX , SE BND		
STACO, UT FIX	*FAIRFIELD, UT VORTAC	12100
*10700 - MCA FAIRFIELD, UT VORTAC , NW BND		
*12500 - MCA FAIRFIELD, UT VORTAC , E BND		
FAIRFIELD, UT VORTAC	PANEL, UT FIX	
	W BND	*11000
	E BND	*13300
*9900 - MOCA		
PANEL, UT FIX	MYTON, UT VOR/DME	13300
MYTON, UT VOR/DME	*RACER, CO FIX	
	W BND	**10000
	E BND	**10500
*12000 - MRA		
**8700 - MOCA		
RACER, CO FIX	*MEEKER, CO VOR/DME	10500
*11300 - MCA MEEKER, CO VOR/DME , E BND		
MEEKER, CO VOR/DME	*KREMMLING, CO VOR/DME	14600
*12500 - MCA KREMMLING, CO VOR/DME , BND		

**95.6201 VOR FEDERAL AIRWAY V201**

LOS ANGELES, CA VORTAC	*BERRI, CA FIX	5000
*7600 - MCA BERRI, CA FIX , N BND		
BERRI, CA FIX	*SOLED, CA FIX	8800
*8400 - MCA SOLED, CA FIX , S BND		
SOLED, CA FIX	PALMDALE, CA VORTAC	7500

**95.6202 VOR FEDERAL AIRWAY V202**

SAN SIMON, AZ VORTAC	SILVER CITY, NM VOR/DME	10300
----------------------	-------------------------	-------

FROM TO MEA

**95.6202 VOR FEDERAL AIRWAY V202 - CONTINUED**

SILVER CITY, NM VOR/DME	*KEAPS, NM FIX	10300
*11600 - MCA KEAPS, NM FIX , NE BND		
KEAPS, NM FIX	TRUTH OR CONSEQUENCES, NM VORTAC	12300

**95.6204 VOR FEDERAL AIRWAY V204**

HOQUIAM, WA VORTAC	*OLYMPIA, WA VORTAC	4500
*3200 - MCA OLYMPIA, WA VORTAC , W BND		
OLYMPIA, WA VORTAC	*MCKEN, WA FIX	4000
*5000 - MCA MCKEN, WA FIX , E BND		
MCKEN, WA FIX	*ALDER, WA FIX	5800
*5800 - MCA ALDER, WA FIX , E BND		
ALDER, WA FIX	TAMPO, WA FIX	10000
TAMPO, WA FIX	*YAKIMA, WA VORTAC	
	W BND	8000
	E BND	6000
*5300 - MCA YAKIMA, WA VORTAC , W BND		
YAKIMA, WA VORTAC	*PAIDS, WA FIX	6000
*5300 - MCA PAIDS, WA FIX , W BND		
PAIDS, WA FIX	PASCO, WA VOR/DME	4000
PASCO, WA VOR/DME	WATSY, WA FIX	3500
WATSY, WA FIX	SPOKANE, WA VORTAC	5000

**95.6206 VOR FEDERAL AIRWAY V206**

NAPOLEON, MO VORTAC	KIRKSVILLE, MO VORTAC	3000
KIRKSVILLE, MO VORTAC	OTTUMWA, IA VOR/DME	3100

**95.6207 VOR FEDERAL AIRWAY V207**

GILL, CO VOR/DME	SCOTTSBLUFF, NE VORTAC	7500
------------------	------------------------	------

**95.6208 VOR FEDERAL AIRWAY V208**

VENTURA, CA VOR/DME	WEEZL, CA FIX	5000
WEEZL, CA FIX	SANTA CATALINA, CA VORTAC	4000
SANTA CATALINA, CA VORTAC	AVOLS, CA FIX	4000
AVOLS, CA FIX	PACIF, CA FIX	*3000
*2000 - MOCA		
PACIF, CA FIX	OCEANSIDE, CA VORTAC	3000
OCEANSIDE, CA VORTAC	*VISTA, CA FIX	3000
*5000 - MCA VISTA, CA FIX , E BND		
VISTA, CA FIX	JULIAN, CA VORTAC	7700
JULIAN, CA VORTAC	THERMAL, CA VORTAC	9000
THERMAL, CA VORTAC	TWENTYNINE PALMS, CA VORTAC	7000
TWENTYNINE PALMS, CA VORTAC	NEEDLES, CA VORTAC	7800
NEEDLES, CA VORTAC	PEACH SPRINGS, AZ VOR/DME	9000
PEACH SPRINGS, AZ VOR/DME	GRAND CANYON, AZ VOR/DME	10000
GRAND CANYON, AZ VOR/DME	TUBA CITY, AZ VORTAC	9500
TUBA CITY, AZ VORTAC	PAGE, AZ VOR/DME	9000
PAGE, AZ VOR/DME	*HANKSVILLE, UT VORTAC	14000
*11500 - MCA HANKSVILLE, UT VORTAC , S BND		
HANKSVILLE, UT VORTAC	CARBON, UT VOR/DME	10000
CARBON, UT VOR/DME	MYTON, UT VOR/DME	11300
MYTON, UT VOR/DME	VERNAL, UT VOR/DME	8400
VERNAL, UT VOR/DME	CHEROKEE, WY VOR/DME	11700

**95.6209 VOR FEDERAL AIRWAY V209**

SEMMES, AL VORTAC	YARBO, AL FIX	*3000
*1800 - MOCA		
*2000 - GNSS MEA		

FROM TO MEA

**95.6209 VOR FEDERAL AIRWAY V209 - CONTINUED**

EUTAW, AL FIX	BROOKWOOD, AL VORTAC	*5000
*2300 - MOCA		
*2500 - GNSS MEA		
BROOKWOOD, AL VORTAC	VULCAN, AL VORTAC	2500
VULCAN, AL VORTAC	TRUST, AL FIX	3500
TRUST, AL FIX	GADSDEN, AL VOR/DME	3600
GADSDEN, AL VOR/DME	*MENLA, AL FIX	**5000
*5000 - MCA MENLA, AL FIX , SW BND		
**3700 - MOCA		
MENLA, AL FIX	CHOO CHOO, TN VORTAC	4000

**95.6210 VOR FEDERAL AIRWAY V210**

LOS ANGELES, CA VORTAC	PIRRO, CA FIX	3500
PIRRO, CA FIX	*POMONA, CA VORTAC	4500
*10400 - MCA POMONA, CA VORTAC , NE BND		
POMONA, CA VORTAC	CALBE, CA FIX	
	SW BND	5700
	NE BND	10800
CALBE, CA FIX	MEANT, CA FIX	
	SW BND	10700
	NE BND	11500
MEANT, CA FIX	*APLES, CA FIX	11800
*9200 - MCA APLES, CA FIX , SW BND		
APLES, CA FIX	HECTOR, CA VORTAC	7900
HECTOR, CA VORTAC	GOFFS, CA VORTAC	*9000
*8200 - MOCA		
GOFFS, CA VORTAC	UNPAS, NV FIX	8000
UNPAS, NV FIX	PEACH SPRINGS, AZ VOR/DME	10500
PEACH SPRINGS, AZ VOR/DME	*GRAND CANYON, AZ VOR/DME	10000
*14500 - MCA GRAND CANYON, AZ VOR/DME , E BND		
GRAND CANYON, AZ VOR/DME	*TUBA CITY, AZ VORTAC	**14500
*14500 - MCA TUBA CITY, AZ VORTAC , W BND		
**9600 - MOCA		
TUBA CITY, AZ VORTAC	FULLY, NM FIX	12000
FULLY, NM FIX	RATTLESNAKE, NM VORTAC	
	NE BND	9000
	SW BND	12000
RATTLESNAKE, NM VORTAC	RESER, NM FIX	9000
RESER, NM FIX	MRKKO, CO FIX	15000
MRKKO, CO FIX	*ALAMOSA, CO VORTAC	
	W BND	14800
	E BND	10000
*11200 - MCA ALAMOSA, CO VORTAC , W BND		
ALAMOSA, CO VORTAC	BLOKE, CO FIX	
	E BND	14000
	W BND	10400
BLOKE, CO FIX	*GOSIP, CO FIX	14000
*14000 - MCA GOSIP, CO FIX , SW BND		
GOSIP, CO FIX	*RADIO, CO FIX	**12000
*10900 - MCA RADIO, CO FIX , SW BND		
**8500 - MOCA		
RADIO, CO FIX	BLOOM, CO FIX	*9400
*8000 - MOCA		
BLOOM, CO FIX	LAMAR, CO VOR/DME	7000
WILL ROGERS, OK VORTAC	MINGG, OK FIX	*4000
*3100 - MOCA		
MINGG, OK FIX	OKMULGEE, OK VOR/DME	*4000
*2600 - MOCA		



FROM TO MEA

**95.6210 VOR FEDERAL AIRWAY V210 - CONTINUED**

BRICKYARD, IN VORTAC	MUNCIE, IN VOR/DME	2900
MUNCIE, IN VOR/DME	ROSEWOOD, OH VORTAC	2800
REVLOC, PA VOR/DME	BLINK, PA FIX	4500
BLINK, PA FIX	HARRISBURG, PA VORTAC	4000
HARRISBURG, PA VORTAC	LANCASTER, PA VOR/DME	3000
LANCASTER, PA VOR/DME	SPERY, PA FIX	2800
SPERY, PA FIX	YARDLEY, PA VOR/DME	*3000
*2200 - MOCA		

**95.6211 VOR FEDERAL AIRWAY V211**

BRAZO, NM FIX	DURANGO, CO VOR/DME	
	W BND	11300
	E BND	13000
DURANGO, CO VOR/DME	CORTEZ, CO VOR/DME	11300

**95.6212 VOR FEDERAL AIRWAY V212**

INDUSTRY, TX VORTAC	NAVASOTA, TX VOR/DME	2200
NAVASOTA, TX VOR/DME	OSKER, TX FIX	3000
OSKER, TX FIX	LUFKIN, TX VORTAC	*4000
*2000 - MOCA		
LUFKIN, TX VORTAC	COSGO, LA FIX	*4000
*1900 - MOCA		
COSGO, LA FIX	COCOS, LA FIX	*4000
*1800 - MOCA		
COCOS, LA FIX	ALEXANDRIA, LA VORTAC	*3000
*1900 - MOCA		
ALEXANDRIA, LA VORTAC	JOHON, LA FIX	2000
JOHON, LA FIX	SETTA, MS FIX	*4000
*2000 - MOCA		
SETTA, MS FIX	MC COMB, MS VORTAC	*3000
*2000 - MOCA		

**95.6213 VOR FEDERAL AIRWAY V213**

GRAND STRAND, SC VORTAC	WILMINGTON, NC VORTAC	UNUSABLE
WILMINGTON, NC VORTAC	WALLO, NC FIX	UNUSABLE
WALLO, NC FIX	JOSCH, NC FIX	*6000
*1700 - MOCA		
*2000 - GNSS MEA		
JOSCH, NC FIX	ESTER, NC FIX	*6000
*1700 - MOCA		
*2000 - GNSS MEA		
ESTER, NC FIX	TAR RIVER, NC VORTAC	*6000
*2000 - GNSS MEA		
TAR RIVER, NC VORTAC	GUMBE, NC FIX	2000
GUMBE, NC FIX	HOPEWELL, VA VORTAC	*2000
*1500 - MOCA		
HOPEWELL, VA VORTAC	*TAPPA, VA FIX	2000
*5000 - MCA TAPPA, VA FIX , NE BND		
TAPPA, VA FIX	PATUXENT, MD VORTAC	*5000
*1500 - MOCA		
*2000 - GNSS MEA		
PATUXENT, MD VORTAC	*GARED, MD FIX	**4500
*8000 - MRA		
**1500 - MOCA		
**4000 - GNSS MEA		
GARED, MD FIX	CHOPS, MD FIX	*4500
*1500 - MOCA		
*4000 - GNSS MEA		

FROM TO MEA

**95.6213 VOR FEDERAL AIRWAY V213 - CONTINUED**

CHOPS, MD FIX *1500 - MOCA	SMYRNA, DE VORTAC	*2000
SMYRNA, DE VORTAC *1600 - MOCA	HOLEY, NJ FIX	*3000
HOLEY, NJ FIX *2000 - MOCA	ROBBINSVILLE, NJ VORTAC	*3000
ROBBINSVILLE, NJ VORTAC *1900 - MOCA	WARRD, NJ FIX	*3000 MAA - 10000
WARRD, NJ FIX *2500 - MOCA	SHOTT, NJ FIX	*3000 MAA - 10000
SHOTT, NJ FIX *2600 - MOCA	SPARTA, NJ VORTAC	*3500 MAA - 10000
SPARTA, NJ VORTAC *3200 - MOCA	FLOSI, NY FIX	*4000
FLOSI, NY FIX *4000 - MOCA	WEETS, NY FIX	*5500
WEETS, NY FIX *6100 - MOCA *8000 - GNSS MEA	ALBANY, NY VORTAC	*10000

**95.6214 VOR FEDERAL AIRWAY V214**

KOKOMO, IN VORTAC	MARION, IN VOR/DME	2600
MARION, IN VOR/DME	MUNCIE, IN VOR/DME	2800
*GLOOM, OH FIX *4000 - MRA **2600 - MOCA **3000 - GNSS MEA	ZANESVILLE, OH VOR/DME	**4000
ZANESVILLE, OH VOR/DME	BELLAIRE, OH VOR/DME	3000

**95.6216 VOR FEDERAL AIRWAY V216**

LAMAR, CO VOR/DME *5200 - MOCA	ORION, KS FIX	*6300
ORION, KS FIX *4300 - MOCA	HILL CITY, KS VORTAC	*5000
HILL CITY, KS VORTAC *3900 - MOCA	MANKATO, KS VORTAC	*4500
MANKATO, KS VORTAC	PAWNEE CITY, NE VORTAC	3600
PAWNEE CITY, NE VORTAC	LAMONI, IA VOR/DME	3400
LAMONI, IA VOR/DME	OTTUMWA, IA VOR/DME	2900
OTTUMWA, IA VOR/DME	IOWA CITY, IA VOR/DME	3000
IOWA CITY, IA VOR/DME *2600 - MOCA	LOTTE, IA FIX	*3500
LOTTE, IA FIX *2200 - MOCA	WACKS, IL FIX	*4000
WACKS, IL FIX	JANESVILLE, WI VOR/DME	2800

**95.6217 VOR FEDERAL AIRWAY V217**

*BESIE, IL FIX *10000 - MRA	BADGER, WI VOR/DME	2900
BADGER, WI VOR/DME	CHING, WI FIX	3000
CHING, WI FIX	SHOOD, WI FIX	2700
SHOOD, WI FIX	GREEN BAY, WI VORTAC	2500
GREEN BAY, WI VORTAC	WISOM, WI FIX	
	SE BND	*2700
*2400 - MOCA	NW BND	*3600

FROM TO MEA

**95.6217 VOR FEDERAL AIRWAY V217 - CONTINUED**

WISOM, WI FIX	RHINELANDER, WI VOR/DME	3600
RHINELANDER, WI VOR/DME	DULUTH, MN VORTAC	*6000
*4100 - MOCA		
DULUTH, MN VORTAC	HIBBING, MN VOR/DME	3300

**95.6218 VOR FEDERAL AIRWAY V218**

*INTERNATIONAL FALLS, MN VOR/DME	JIBDU, MN FIX	
	N BND	4000
	S BND	10000
*7800 - MCA INTERNATIONAL FALLS, MN VOR/DME , S BND		
JIBDU, MN FIX	BEBEL, MN FIX	
	N BND	7000
	S BND	10000
BEBEL, MN FIX	SQEAK, MN FIX	10000
SQEAK, MN FIX	GRAND RAPIDS, MN VOR/DME	*5000
*3100 - MOCA		
GRAND RAPIDS, MN VOR/DME	GOPHER, MN VORTAC	*5500
*3000 - MOCA		

**95.6219 VOR FEDERAL AIRWAY V219**

HAYES CENTER, NE VORTAC	*YOZLE, NE FIX	**7000
*7000 - MRA		
**4500 - MOCA		
**5000 - GNSS MEA		
YOZLE, NE FIX	WOLBACH, NE VORTAC	
	NE BND	*5000
	SW BND	*7000
*4500 - MOCA		
*5000 - GNSS MEA		
WOLBACH, NE VORTAC	NORFOLK, NE VOR/DME	4000

**95.6220 VOR FEDERAL AIRWAY V220**

GRAND JUNCTION, CO VOR/DME	*PACES, CO FIX	11500
*13000 - MRA		
PACES, CO FIX	*SLOLM, CO FIX	13000
*MTA V220 NE TO V220 NW 12900		
SLOLM, CO FIX	RIFLE, CO VOR/DME	12400
RIFLE, CO VOR/DME	MEEKER, CO VOR/DME	12400
MEEKER, CO VOR/DME	AXIAL, CO FIX	11000
AXIAL, CO FIX	HAYDEN, CO VOR/DME	
	SW BND	11000
	NE BND	10000
HAYDEN, CO VOR/DME	HABRO, CO FIX	10000
HABRO, CO FIX	KREMMLING, CO VOR/DME	13000
KREMMLING, CO VOR/DME	NIWOT, CO FIX	*17000
*15900 - MOCA		
NIWOT, CO FIX	*GILL, CO VOR/DME	
	NE BND	7400
	SW BND	17000
*14500 - MCA GILL, CO VOR/DME , SW BND		
GILL, CO VOR/DME	AKRON, CO VOR/DME	7000
AKRON, CO VOR/DME	MCJEF, NE FIX	*7000
*6000 - MOCA		
MCJEF, NE FIX	MC COOK, NE VOR/DME	*7500
*5000 - MOCA		
MC COOK, NE VOR/DME	SPRIT, NE FIX	*5000
*4100 - MOCA		

FROM	TO	MEA
<b>95.6220 VOR FEDERAL AIRWAY V220 - CONTINUED</b>		
SPRIT, NE FIX *3700 - MOCA	KEARNEY, NE VOR	*5000
KEARNEY, NE VOR	HASTINGS, NE VOR/DME	4300
HASTINGS, NE VOR/DME	COLUMBUS, NE VOR/DME	4000
<b>95.6221 VOR FEDERAL AIRWAY V221</b>		
BIBLE GROVE, IL VORTAC	HOOSIER, IN VORTAC	3000
HOOSIER, IN VORTAC *3100 - MOCA *4000 - GNSS MEA *HOOSIER R-053 UNUSABLE	SHELBYVILLE, IN VOR/DME	*6000
SHELBYVILLE, IN VOR/DME *2600 - MOCA	MUNCIE, IN VOR/DME	*2800
MUNCIE, IN VOR/DME	FORT WAYNE, IN VORTAC	2700
FORT WAYNE, IN VORTAC *4500 - MRA	*GAREN, IN FIX	3000
GAREN, IN FIX *2400 - MOCA	ILTON, IN FIX	*3000
<b>95.6222 VOR FEDERAL AIRWAY V222</b>		
EL PASO, TX VORTAC *7400 - MOCA	SALT FLAT, TX VORTAC	*8000
SALT FLAT, TX VORTAC *7900 - MOCA	HOBAN, TX FIX	*9000
HOBAN, TX FIX	FORT STOCKTON, TX VORTAC	5100
FORT STOCKTON, TX VORTAC *5500 - MOCA *MEA IS ESTABLISHED WITH A GAP IN NAVIGATION SIGNAL COVERAGE	KEMPL, TX FIX	*8000
KEMPL, TX FIX *4000 - MOCA	JUNCTION, TX VORTAC	*6000
JUNCTION, TX VORTAC	STONEWALL, TX VORTAC	4000
STONEWALL, TX VORTAC	MARCS, TX FIX	4500
MARCS, TX FIX *2000 - MOCA	CRAYS, TX FIX	*2900
CRAYS, TX FIX	INDUSTRY, TX VORTAC	2600
INDUSTRY, TX VORTAC	SEALY, TX FIX	2100
SEALY, TX FIX	HUMBLE, TX VORTAC	2000
HUMBLE, TX VORTAC	BEAUMONT, TX VOR/DME	3100
BEAUMONT, TX VOR/DME	LAKE CHARLES, LA VORTAC	2000
LAKE CHARLES, LA VORTAC	MAXON, LA FIX	2000
MAXON, LA FIX *1800 - MOCA *2000 - GNSS MEA	WRACK, LA FIX	*6000
WRACK, LA FIX *2000 - MOCA *2000 - GNSS MEA	MC COMB, MS VORTAC	*4000
MC COMB, MS VORTAC	EATON, MS VORTAC	2000
EATON, MS VORTAC	PICAN, MS FIX	
	W BND	2300
	E BND	3000
PICAN, MS FIX *1900 - MOCA	MONROEVILLE, AL VORTAC	*3000
MONROEVILLE, AL VORTAC	MONTGOMERY, AL VORTAC	2300
MONTGOMERY, AL VORTAC *3500 - MRA	*MARST, AL FIX	2300
MARST, AL FIX	KENTT, AL FIX	2100
KENTT, AL FIX	LAGRANGE, GA VORTAC	2500

FROM	TO	MEA
<b>95.6222 VOR FEDERAL AIRWAY V222 - CONTINUED</b>		
LAGRANGE, GA VORTAC *4000 - MRA	*TIROE, GA FIX	2600
<b>95.6223 VOR FEDERAL AIRWAY V223</b>		
FLAT ROCK, VA VORTAC *7000 - MRA	*HANEY, VA FIX	2800
HANEY, VA FIX	FLUKY, VA FIX	2600
<b>95.6225 VOR FEDERAL AIRWAY V225</b>		
KEY WEST, FL VORTAC RIGOR, FL FIX *1400 - MOCA *1700 - GNSS MEA	RIGOR, FL FIX MARCI, FL FIX	1700 *4000
MARCI, FL FIX	LEE COUNTY, FL VORTAC N BND S BND	2100 4000
LEE COUNTY, FL VORTAC *1500 - MOCA	LA BELLE, FL VORTAC	*2000
LA BELLE, FL VORTAC *1500 - MOCA	DIDDY, FL FIX	*2000
DIDDY, FL FIX	TREASURE, FL VORTAC	2000
<b>95.6226 VOR FEDERAL AIRWAY V226</b>		
KEATING, PA VORTAC *3900 - MOCA	WILLIAMSPORT, PA VOR/DME	*4500
WILLIAMSPORT, PA VOR/DME SWANK, PA FIX	SWANK, PA FIX WILKES-BARRE, PA VORTAC E BND W BND	4500 *4000 *4500
*3700 - MOCA WILKES-BARRE, PA VORTAC	STILLWATER, NJ VOR/DME	4000
<b>95.6227 VOR FEDERAL AIRWAY V227</b>		
BOILER, IN VORTAC ROBERTS, IL VOR/DME PONTIAC, IL VOR/DME	ROBERTS, IL VOR/DME PONTIAC, IL VOR/DME PLANO, IL FIX	2600 3000 3000
<b>95.6228 VOR FEDERAL AIRWAY V228</b>		
DELLS, WI VORTAC MADISON, WI VORTAC *10000 - MRA	MADISON, WI VORTAC *DEBOW, WI FIX	3300 10000
DEBOW, WI FIX *10000 - MRA	*BESIE, IL FIX	10000
FARMM, IL FIX NORTHBROOK, IL VOR/DME *3000 - MRA	NORTHBROOK, IL VOR/DME *NEPTS, MI FIX	2700 2500
NEPTS, MI FIX	GIPPER, MI VORTAC	2600
<b>95.6229 VOR FEDERAL AIRWAY V229</b>		
PATUXENT, MD VORTAC *8000 - MRA **1500 - MOCA **4000 - GNSS MEA	*GARED, MD FIX	**4500

FROM TO MEA

**95.6229 VOR FEDERAL AIRWAY V229 - CONTINUED**

GARED, MD FIX	DONIL, DE FIX	*8000
*1600 - MOCA		
*4000 - GNSS MEA		
DONIL, DE FIX	ATLANTIC CITY, NJ VORTAC	*2000
*1500 - MOCA		
ATLANTIC CITY, NJ VORTAC	PANZE, NJ FIX	2100
PANZE, NJ FIX	DIXIE, NJ FIX	2500
DIXIE, NJ FIX	KENNEDY, NY VOR/DME	*2500
*1700 - MOCA		
KENNEDY, NY VOR/DME	KEEPM, NY FIX	2000
KEEPM, NY FIX	TRANZ, NY FIX	2000
TRANZ, NY FIX	PUGGS, NY FIX	*2500
*2000 - GNSS MEA		
PUGGS, NY FIX	BRIDGEPORT, CT VOR/DME	*2500
*2000 - GNSS MEA		
BRIDGEPORT, CT VOR/DME	HARTFORD, CT VOR/DME	2000

**95.6230 VOR FEDERAL AIRWAY V230**

SHOEY, CA FIX	*SALINAS, CA VORTAC	**5000
*6000 - MCA SALINAS, CA VORTAC , E BND		
**4100 - MOCA		
SALINAS, CA VORTAC	*PANOS, CA FIX	**6500
*8000 - MCA PANOS, CA FIX , E BND		
**5500 - MOCA		
PANOS, CA FIX	FIDDO, CA FIX	9000
FIDDO, CA FIX	*PANOCHÉ, CA VORTAC	**7000
*8500 - MCA PANOCHÉ, CA VORTAC , W BND		
**5800 - MOCA		
PANOCHÉ, CA VORTAC	MENDO, CA FIX	4500
MENDO, CA FIX	BLEAR, CA FIX	*4000
*1600 - MOCA		
BLEAR, CA FIX	*FRIANT, CA VORTAC	**5500
*10400 - MCA FRIANT, CA VORTAC , NE BND		
**4700 - MOCA		
FRIANT, CA VORTAC	CAINS, CA FIX	
	NE BND	14300
	SW BND	11000
CAINS, CA FIX	NIKOL, CA FIX	14300
NIKOL, CA FIX	MINA, NV VORTAC	
	NE BND	11000
	SW BND	13000

**95.6231 VOR FEDERAL AIRWAY V231**

BURLEY, ID VOR/DME	*MENIN, ID FIX	
	S BND	**7000
	N BND	**9500
*10600 - MCA MENIN, ID FIX , N BND		
**7000 - MOCA		
MENIN, ID FIX	SALMON, ID VOR/DME	14000
SALMON, ID VOR/DME	TUFFY, MT FIX	*12000
*11300 - MOCA		
TUFFY, MT FIX	*MISSOULA, MT VOR/DME	
	S BND	12000
	N BND	9000
*10000 - MCA MISSOULA, MT VOR/DME , S BND		
MISSOULA, MT VOR/DME	ARLEE, MT FIX	9700
ARLEE, MT FIX	*JESSY, MT FIX	**11000
*13000 - MCA JESSY, MT FIX , N BND		
**9400 - MOCA		

FROM TO MEA

**95.6231 VOR FEDERAL AIRWAY V231 - CONTINUED**

JESSY, MT FIX	*SKOTT, MT FIX	**13000
*12000 - MRA		
**8700 - MOCA		
SKOTT, MT FIX	KALISPELL, MT VOR/DME	
	N BND	8600
	S BND	10000

**95.6232 VOR FEDERAL AIRWAY V232**

KEATING, PA VORTAC	WATSO, PA FIX	4700
WATSO, PA FIX	MILTON, PA VORTAC	*4000
*2900 - MOCA		
MILTON, PA VORTAC	SOLBERG, NJ VOR/DME	4000
SOLBERG, NJ VOR/DME	TYKES, NJ FIX	2300
TYKES, NJ FIX	COLTS NECK, NJ VOR/DME	2000

**95.6233 VOR FEDERAL AIRWAY V233**

SPINNER, IL VORTAC	ROBERTS, IL VOR/DME	2600
ROBERTS, IL VOR/DME	KNOX, IN VOR/DME	*3000
*2200 - MOCA		
KNOX, IN VOR/DME	GOSHEN, IN VORTAC	2600
GOSHEN, IN VORTAC	LITCHFIELD, MI VOR/DME	3000
MOUNT PLEASANT, MI VOR/DME	CARGA, MI FIX	5500
CARGA, MI FIX	GAYLORD, MI VOR/DME	4000
GAYLORD, MI VOR/DME	PELLSTON, MI VORTAC	3200

**95.6234 VOR FEDERAL AIRWAY V234**

ST JOHNS, AZ VORTAC	*STONY, NM FIX	**12000
*9500 - MCA STONY, NM FIX , SW BND		
**10500 - MOCA		
STONY, NM FIX	ALBUQUERQUE, NM VORTAC	9000
ALBUQUERQUE, NM VORTAC	ANTON CHICO, NM VORTAC	10000
ANTON CHICO, NM VORTAC	DALHART, TX VORTAC	*8500
*7500 - MOCA		
HUTCHINSON, KS VOR/DME	WAIVE, KS FIX	4000
WAIVE, KS FIX	*FLOSS, KS FIX	3300
*5000 - MRA		
FLOSS, KS FIX	EMPORIA, KS VORTAC	3300
EMPORIA, KS VORTAC	BUTLER, MO VORTAC	3000
BUTLER, MO VORTAC	AUGIE, MO FIX	2700
AUGIE, MO FIX	VICHY, MO VOR/DME	*3200
*2400 - MOCA		
VICHY, MO VOR/DME	DELMA, MO FIX	3000
DELMA, MO FIX	GLASS, MO FIX	*3500
*2800 - MOCA		
GLASS, MO FIX	CENTRALIA, IL VORTAC	*3000
*2200 - MOCA		

**95.6235 VOR FEDERAL AIRWAY V235**

PEACH SPRINGS, AZ VOR/DME	MORMON MESA, NV VORTAC	10000
MORMON MESA, NV VORTAC	MATZO, UT FIX	
	NE BND	12000
	SW BND	9000
MATZO, UT FIX	*ENOCH, UT VOR/DME	12400
*11400 - MCA ENOCH, UT VOR/DME , S BND		
ENOCH, UT VOR/DME	MILFORD, UT VORTAC	10000

FROM TO MEA

**95.6235 VOR FEDERAL AIRWAY V235 - CONTINUED**

MILFORD, UT VORTAC	DELTA, UT VORTAC	9600
DELTA, UT VORTAC	*FAIRFIELD, UT VORTAC	10300
*12500 - MCA FAIRFIELD, UT VORTAC , NE BND		
FAIRFIELD, UT VORTAC	GRODI, WY FIX	14000
GRODI, WY FIX	FORT BRIDGER, WY VOR/DME	11000
ROCK SPRINGS, WY VOR/DME	BORGG, WY FIX	9500
BORGG, WY FIX	OILLY, WY FIX	11200
OILLY, WY FIX	MUDDY MOUNTAIN, WY VOR/DME	9000
MUDDY MOUNTAIN, WY VOR/DME	NEWCASTLE, WY VOR	8300

**95.6236 VOR FEDERAL AIRWAY V236**

CEVAR, UT FIX	EMONT, UT FIX	9000
EMONT, UT FIX	OGDEN, UT VORTAC	*8000
*7000 - MOCA		

**95.6237 VOR FEDERAL AIRWAY V237**

NEEDLES, CA VORTAC	BOULDER CITY, NV VORTAC	7600
BOULDER CITY, NV VORTAC	LAS VEGAS, NV VORTAC	6000

**95.6239 VOR FEDERAL AIRWAY V239**

FORNEY, MO VOR	BNTON, MO FIX	2900
BNTON, MO FIX	HALLSVILLE, MO VORTAC	2800

**95.6240 VOR FEDERAL AIRWAY V240**

HARVEY, LA VORTAC	PEARL, LA FIX	2000
PEARL, LA FIX	MINNI, MS FIX	*2300
*1300 - MOCA		
MINNI, MS FIX	ELSIE, MS FIX	*3500
*1300 - MOCA		
ELSIE, MS FIX	*ROMMY, MS FIX	**2800
*4000 - MRA		
**1300 - MOCA		
ROMMY, MS FIX	SEMMES, AL VORTAC	2000

**95.6241 VOR FEDERAL AIRWAY V241**

SEMMES, AL VORTAC	CRESTVIEW, FL VORTAC	3100
CRESTVIEW, FL VORTAC	*WIREGRASS, AL VORTAC	2000
*3000 - MCA WIREGRASS, AL VORTAC , N BND		
WIREGRASS, AL VORTAC	EUFULA, AL VORTAC	*3000
*2000 - MOCA		
*WIREGRASS R-019 UNSABLE BELOW 6000 USE EUFAULA R-199		
EUFULA, AL VORTAC	COLUMBUS, GA VORTAC	2400
COLUMBUS, GA VORTAC	*TIROE, GA FIX	3000
*4000 - MRA		

**95.6243 VOR FEDERAL AIRWAY V243**

CRAIG, FL VORTAC	WAYCROSS, GA VORTAC	*3000
*2300 - MOCA		
WAYCROSS, GA VORTAC	VIENNA, GA VORTAC	2300
VIENNA, GA VORTAC	*PRATZ, GA FIX	**3000
*3000 - MRA		
**2000 - MOCA		
PRATZ, GA FIX	LAGRANGE, GA VORTAC	3500



FROM TO MEA

**95.6243 VOR FEDERAL AIRWAY V243 - CONTINUED**

LAGRANGE, GA VORTAC *3400 - MOCA	HEFIN, AL FIX	*4000
HEFIN, AL FIX *3400 - MOCA	FELTO, GA FIX	*6000
FELTO, GA FIX *4000 - MOCA	GORGO, GA FIX	*5000
GORGO, GA FIX	CHOO CHOO, TN VORTAC	4000

**95.6244 VOR FEDERAL AIRWAY V244**

OAKLAND, CA VOR/DME *4700 - MCA SALAD, CA FIX , NE BND	*SALAD, CA FIX	4000
SALAD, CA FIX	ALTAM, CA FIX	5000
ALTAM, CA FIX	HAIRE, CA FIX	4500
HAIRE, CA FIX *3300 - MCA LINDEN, CA VOR/DME , E BND **2100 - MOCA	*LINDEN, CA VOR/DME	**3000
LINDEN, CA VOR/DME	*MERPH, CA FIX W BND E BND	6400 15300
*9800 - MCA MERPH, CA FIX , E BND		
MERPH, CA FIX *13100 - MCA NIKOL, CA FIX , W BND	*NIKOL, CA FIX	15300
NIKOL, CA FIX	COALDALE, NV VORTAC	12500
COALDALE, NV VORTAC	TONOPAH, NV VORTAC	11000
TONOPAH, NV VORTAC	WILSON CREEK, NV VORTAC	12200
WILSON CREEK, NV VORTAC *12000 - MCA MILFORD, UT VORTAC , E BND	*MILFORD, UT VORTAC	12000
MILFORD, UT VORTAC	DETAN, UT FIX	14000
DETAN, UT FIX *14200 - MOCA	HANKSVILLE, UT VORTAC	*16000
HANKSVILLE, UT VORTAC *12300 - MCA ANIUM, UT FIX , E BND **8500 - MOCA	*ANIUM, UT FIX	**10500
ANIUM, UT FIX *13300 - MCA PAROX, CO FIX , W BND **14800 - MOCA	*PAROX, CO FIX	**15500
PAROX, CO FIX *12000 - MCA NADIN, CO FIX , W BND **12000 - MOCA	*NADIN, CO FIX	**13000
NADIN, CO FIX	MONTROSE, CO VOR/DME	11000
MONTROSE, CO VOR/DME	BLUE MESA, CO VOR/DME	12500
BLUE MESA, CO VOR/DME	DUFEL, CO FIX E BND W BND	16000 12000
DUFEL, CO FIX *10000 - MRA	*FLOOD, CO FIX	16000
FLOOD, CO FIX	STANO, CO FIX W BND E BND	12000 9000
STANO, CO FIX	PUEBLO, CO VORTAC	7800
PUEBLO, CO VORTAC	LAMAR, CO VOR/DME	7000
LAMAR, CO VOR/DME *9000 - MRA *9000 - MCA COFFE, KS FIX , SW BND *9700 - MCA COFFE, KS FIX , NE BND **5400 - MOCA	*COFFE, KS FIX	**9000
COFFE, KS FIX *10000 - MRA **4700 - MOCA	*RANSO, KS FIX	**10000

FROM TO MEA

**95.6244 VOR FEDERAL AIRWAY V244 - CONTINUED**

RANSO, KS FIX *3900 - MOCA	HAYS, KS VORTAC	*5000
HAYS, KS VORTAC *4500 - MRA	*GLIDE, KS FIX	3900
GLIDE, KS FIX *3200 - MOCA	SALINA, KS VORTAC	*3900

**95.6245 VOR FEDERAL AIRWAY V245**

ALEXANDRIA, LA VORTAC	NATCHEZ, MS VOR/DME	2000
NATCHEZ, MS VOR/DME	MAGNOLIA, MS VORTAC	3500
MAGNOLIA, MS VORTAC *2000 - MOCA *3000 - GNSS MEA	BIGBEE, MS VORTAC	*5000

**95.6246 VOR FEDERAL AIRWAY V246**

JANESVILLE, WI VOR/DME	DUBUQUE, IA VORTAC	3000
------------------------	--------------------	------

**95.6247 VOR FEDERAL AIRWAY V247**

SCOTTSBLUFF, NE VORTAC	HIPSHER, WY VOR/DME	8100
HIPSHER, WY VOR/DME *9000 - MCA WAPAP, WY FIX , SE BND **8300 - MOCA **8000 - GNSS MEA	*WAPAP, WY FIX	**9000
WAPAP, WY FIX	CRAZY WOMAN, WY VOR/DME	8000
CRAZY WOMAN, WY VOR/DME	SHERIDAN, WY VOR/DME	7000
SHERIDAN, WY VOR/DME	ARDMO, MT FIX	8000
ARDMO, MT FIX	BILLINGS, MT VORTAC E BND	8000
	W BND	6000
BILLINGS, MT VORTAC	PELJE, MT FIX W BND	10500
	E BND	6400
PELJE, MT FIX	BAXTA, MT FIX E BND	7000
	W BND	10500
BAXTA, MT FIX *11200 - MOCA	WAUTS, MT FIX	*13000
WAUTS, MT FIX	HELENA, MT VORTAC W BND	9600
	E BND	13000

**95.6248 VOR FEDERAL AIRWAY V248**

SALINAS, CA VORTAC *7000 - MRA **5500 - MOCA	*SARDO, CA FIX	**6000
SARDO, CA FIX *5500 - MOCA	FIKDU, CA FIX	*6000
FIKDU, CA FIX	PASO ROBLES, CA VORTAC SE BND	5000
	NW BND	6000
PASO ROBLES, CA VORTAC	AVENAL, CA VOR/DME	4500
AVENAL, CA VOR/DME	SCRAP, CA FIX	4000
SCRAP, CA FIX	SHAFTER, CA VORTAC W BND	*4000
	E BND	*3000
*3000 - MOCA		

FROM	TO	MEA
<b>95.6249 VOR FEDERAL AIRWAY V249</b>		
ROBBINSVILLE, NJ VORTAC	JERYY, NJ FIX	4000
JERYY, NJ FIX	SOLBERG, NJ VOR/DME	*3000
*2000 - MOCA		
SOLBERG, NJ VOR/DME	SPARTA, NJ VORTAC	3000
SPARTA, NJ VORTAC	FLOSI, NY FIX	*4000
*3200 - MOCA		
FLOSI, NY FIX	WEETS, NY FIX	*5500
*4000 - MOCA		
WEETS, NY FIX	RIMBA, NY FIX	6400
RIMBA, NY FIX	DELANCEY, NY VOR/DME	5500
<b>95.6250 VOR FEDERAL AIRWAY V250</b>		
O'NEILL, NE VORTAC	YANKTON, SD VOR/DME	3700
<b>95.6251 VOR FEDERAL AIRWAY V251</b>		
ADDERS, IL VORTAC	CHAMPAIGN, IL VORTAC	2500
CHAMPAIGN, IL VORTAC	DANVILLE, IL VORTAC	2500
DANVILLE, IL VORTAC	BOILER, IN VORTAC	2500
<b>95.6252 VOR FEDERAL AIRWAY V252</b>		
AIRCO, NY FIX	GENESE0, NY VOR/DME	*4000
*2800 - MOCA		
GENESE0, NY VOR/DME	GIBBE, NY FIX	4000
GIBBE, NY FIX	BINGHAMTON, NY VOR/DME	3800
BINGHAMTON, NY VOR/DME	HUGIE, PA FIX	4000
HUGIE, PA FIX	RAGER, NY FIX	4400
RAGER, NY FIX	HUGUENOT, NY VOR/DME	4000
HUGUENOT, NY VOR/DME	COATE, NJ FIX	*4000
*3300 - MOCA		
COATE, NJ FIX	SLYNG, NJ FIX	*5000
*2700 - MOCA		
SLYNG, NJ FIX	ROBBINSVILLE, NJ VORTAC	2600
ROBBINSVILLE, NJ VORTAC	DUPONT, DE VORTAC	2000
<b>95.6253 VOR FEDERAL AIRWAY V253</b>		
LUCIN, UT VORTAC	ROGET, ID FIX	11000
ROGET, ID FIX	*TWIN FALLS, ID VORTAC	
	NW BND	9000
	SE BND	11000
*9000 - MCA TWIN FALLS, ID VORTAC , SE BND		
TWIN FALLS, ID VORTAC	LITKE, ID FIX	6200
LITKE, ID FIX	ALKAL, ID FIX	
	SE BND	6000
	NW BND	9500
ALKAL, ID FIX	CANEK, ID FIX	*9500
*8500 - MOCA		
CANEK, ID FIX	*BOISE, ID VORTAC	
	NW BND	7000
	SE BND	9500
*7500 - MCA BOISE, ID VORTAC , N BND		
BOISE, ID VORTAC	BANGS, ID FIX	
	S BND	9100
	N BND	10500
BANGS, ID FIX	DONNELLY, ID VOR/DME	10500

FROM TO MEA

**95.6253 VOR FEDERAL AIRWAY V253 - CONTINUED**

DONNELLY, ID VOR/DME	OXLEY, ID FIX	12000
OXLEY, ID FIX	*NEZ PERCE, ID VOR/DME	
	SE BND	12000
	NW BND	7400
*6400 - MCA NEZ PERCE, ID VOR/DME , SE BND		
NEZ PERCE, ID VOR/DME	PULLMAN, WA VOR/DME	6000
PULLMAN, WA VOR/DME	SPOKANE, WA VORTAC	*6000
*5600 - MOCA		

**95.6254 VOR FEDERAL AIRWAY V254**

HIPSHER, WY VOR/DME	TOOKE, WY FIX	*10000
*7500 - MOCA		
TOOKE, WY FIX	GILLETTE, WY VOR/DME	7000
GILLETTE, WY VOR/DME	MILES CITY, MT VOR/DME	*9000
*6900 - MOCA		
MILES CITY, MT VOR/DME	GLASGOW, MT VOR/DME	6000

**95.6255 VOR FEDERAL AIRWAY V255**

GARDEN CITY, KS VORTAC	HAYS, KS VORTAC	4600
------------------------	-----------------	------

**95.6256 VOR FEDERAL AIRWAY V256**

TULSA, OK VORTAC	PIONEER, OK VORTAC	3000
PIONEER, OK VORTAC	HUTCHINSON, KS VOR/DME	3300

**95.6257 VOR FEDERAL AIRWAY V257**

**PHOENIX, AZ VORTAC	*AVENT, AZ FIX	
	NW BND	14000
	SE BND	5000
*8000 - MRA		
**9400 - MCA PHOENIX, AZ VORTAC , NW BND		
AVENT, AZ FIX	*BANYO, AZ FIX	
	NW BND	14000
	SE BND	5000
*6000 - MRA		
BANYO, AZ FIX	COYOT, AZ FIX	
	NW BND	*14000
	SE BND	*9000
*8100 - MOCA		
COYOT, AZ FIX	*MAIER, AZ FIX	**14000
*14000 - MCA MAIER, AZ FIX , SE BND		
**9000 - GNSS MEA		
MAIER, AZ FIX	*DRAKE, AZ VORTAC	
	NW BND	10000
	SE BND	14000
*12000 - MCA DRAKE, AZ VORTAC , SE BND		
DRAKE, AZ VORTAC	*KACEE, AZ FIX	**10000
*11000 - MCA KACEE, AZ FIX , W BND		
*11000 - MCA KACEE, AZ FIX , E BND		
**8600 - MOCA		
**9000 - GNSS MEA		
KACEE, AZ FIX	*BISOP, AZ FIX	**10000
*11000 - MRA		
**8400 - MOCA		
**9000 - GNSS MEA		
BISOP, AZ FIX	*GRAND CANYON, AZ VOR/DME	10000
*14500 - MCA GRAND CANYON, AZ VOR/DME , N BND		

FROM TO MEA

**95.6257 VOR FEDERAL AIRWAY V257 - CONTINUED**

GRAND CANYON, AZ VOR/DME	*DOZIT, AZ FIX	**14500
*14500 - MCA DOZIT, AZ FIX , S BND		
**11200 - MOCA		
DOZIT, AZ FIX	JALMA, AZ FIX	*14500
*11200 - MOCA		
JALMA, AZ FIX	KACIR, AZ FIX	*13000
*11000 - MOCA		
KACIR, AZ FIX	BRYCE CANYON, UT VORTAC	11600
BRYCE CANYON, UT VORTAC	DELTA, UT VORTAC	12000
DELTA, UT VORTAC	*VERNE, UT FIX	11500
*12200 - MCA VERNE, UT FIX , N BND		
VERNE, UT FIX	*STACO, UT FIX	13000
*10500 - MCA STACO, UT FIX , S BND		
STACO, UT FIX	MOINT, UT FIX	*13000
*8900 - MOCA		
MOINT, UT FIX	*KREBS, UT FIX	**13000
*13000 - MRA		
**9600 - MOCA		
KREBS, UT FIX	MALAD CITY, ID VOR/DME	*11000
*10000 - MOCA		
MALAD CITY, ID VOR/DME	BANNO, ID FIX	10000
BANNO, ID FIX	*POCATELLO, ID VOR/DME	9000
*8000 - MCA POCATELLO, ID VOR/DME , SE BND		
POCATELLO, ID VOR/DME	ROCCA, ID FIX	7000
ROCCA, ID FIX	*DUBOIS, ID VORTAC	7500
*8600 - MCA DUBOIS, ID VORTAC , N BND		
DUBOIS, ID VORTAC	DILLON, MT VOR/DME	*12000
*11200 - MOCA		
DILLON, MT VOR/DME	DIVID, MT FIX	11000
DIVID, MT FIX	*COPPERTOWN, MT VOR/DME	10000
*10000 - MCA COPPERTOWN, MT VOR/DME , SE BND		
COPPERTOWN, MT VOR/DME	GLUES, MT FIX	9200
GLUES, MT FIX	SCAAT, MT FIX	*16000
*9200 - MOCA		
SCAAT, MT FIX	SIEBE, MT FIX	*13000
*9800 - MOCA		
*9800 - GNSS MEA		
SIEBE, MT FIX	WOKEN, MT FIX	9000
WOKEN, MT FIX	GREAT FALLS, MT VORTAC	8800
GREAT FALLS, MT VORTAC	SHONK, MT FIX	6200
SHONK, MT FIX	HAVRE, MT VOR/DME	6000

**95.6258 VOR FEDERAL AIRWAY V258**

CHARLESTON, WV VOR/DME	BECKLEY, WV VOR/DME	5500
BECKLEY, WV VOR/DME	ZOOMS, WV FIX	UNUSABLE
ZOOMS, WV FIX	ROANOKE, VA VOR/DME	6400
ROANOKE, VA VOR/DME	PIGGS, VA FIX	5400
PIGGS, VA FIX	ENTUK, VA FIX	*4000
*3400 - MOCA		
ENTUK, VA FIX	DANVILLE, VA VOR	3000

**95.6259 VOR FEDERAL AIRWAY V259**

GRAND STRAND, SC VORTAC	*CLETA, SC FIX	2000
*3000 - MRA		
CLETA, SC FIX	FLORENCE, SC VORTAC	2000
FLORENCE, SC VORTAC	CHESTERFIELD, SC VOR/DME	2000
CHESTERFIELD, SC VOR/DME	HUSTN, NC FIX	2500

FROM TO MEA

**95.6259 VOR FEDERAL AIRWAY V259 - CONTINUED**

MOPED, NC FIX	BARRETT'S MOUNTAIN, NC VOR/DME	4000
BARRETT'S MOUNTAIN, NC VOR/DME	GOWBE, NC FIX	
	SE BND	5000
	NW BND	7500
GOWBE, NC FIX	*HOLSTON MOUNTAIN, TN VORTAC	7500
*6600 - MCA HOLSTON MOUNTAIN, TN VORTAC , BND		

**95.6260 VOR FEDERAL AIRWAY V260**

CHARLESTON, WV VOR/DME	MONTS, WV FIX	3400
MONTS, WV FIX	RAINELLE, WV VOR	5100
RAINELLE, WV VOR	ROANOKE, VA VOR/DME	*6000
*5400 - MOCA		
ROANOKE, VA VOR/DME	GOOZE, VA FIX	5000
GOOZE, VA FIX	LYNCHBURG, VA VOR/DME	
	W BND	*5000
	E BND	*3000
*2900 - MOCA		
LYNCHBURG, VA VOR/DME	FLAT ROCK, VA VORTAC	3000
FLAT ROCK, VA VORTAC	RICHMOND, VA VORTAC	2600
RICHMOND, VA VORTAC	HOPEWELL, VA VORTAC	1900
HOPEWELL, VA VORTAC	WAIKS, VA FIX	3000
WAIKS, VA FIX	FRANKLIN, VA VORTAC	3000
FRANKLIN, VA VORTAC	COFIELD, NC VORTAC	1800

**95.6261 VOR FEDERAL AIRWAY V261**

WICHITA, KS VORTAC	CEKIS, KS FIX	3600
CEKIS, KS FIX	MANHATTAN, KS VOR/DME	3000

**95.6262 VOR FEDERAL AIRWAY V262**

PEORIA, IL VORTAC	*DULAP, IL FIX	2700
*3000 - MRA		
DULAP, IL FIX	BRADFORD, IL VORTAC	2700
BRADFORD, IL VORTAC	MOTIF, IL FIX	2700
MOTIF, IL FIX	JOLIET, IL VOR/DME	*3000
*2300 - MOCA		

**95.6263 VOR FEDERAL AIRWAY V263**

CORONA, NM VORTAC	ENCIA, NM FIX	9700
ENCIA, NM FIX	ALBUQUERQUE, NM VORTAC	8000
ALBUQUERQUE, NM VORTAC	*SANTA FE, NM VORTAC	9000
*11600 - MCA SANTA FE, NM VORTAC , E BND		
SANTA FE, NM VORTAC	*FORT UNION, NM VORTAC	12500
*10900 - MCA FORT UNION, NM VORTAC , N BND		
*11300 - MCA FORT UNION, NM VORTAC , W BND		
FORT UNION, NM VORTAC	CIMARRON, NM VORTAC	*12000
*11100 - MOCA		
CIMARRON, NM VORTAC	TOBE, CO VOR/DME	*11600
*10700 - MOCA		
TOBE, CO VOR/DME	LAMAR, CO VOR/DME	*7400
*6700 - MOCA		
LAMAR, CO VOR/DME	HUGO, CO VOR/DME	*6900
*6200 - MOCA		
HUGO, CO VOR/DME	KANDO, CO FIX	*10000
*8500 - MOCA		
*9000 - GNSS MEA		

FROM TO MEA

**95.6263 VOR FEDERAL AIRWAY V263 - CONTINUED**

KANDO, CO FIX	AKRON, CO VOR/DME	
	NE BND	*8500
	SW BND	*10000
*7500 - MOCA		
PIERRE, SD VORTAC	ABERDEEN, SD VOR/DME	4000

**95.6264 VOR FEDERAL AIRWAY V264**

LOS ANGELES, CA VORTAC	*STABO, CA FIX	2800
*3300 - MCA STABO, CA FIX , NE BND		
STABO, CA FIX	*AMTRA, CA FIX	3400
*3700 - MCA AMTRA, CA FIX , E BND		
AMTRA, CA FIX	*POMONA, CA VORTAC	4800
*5600 - MCA POMONA, CA VORTAC , E BND		
*MTA V264 E TO V197 NW 11800		
POMONA, CA VORTAC	*RAVON, CA FIX	6000
*11400 - MCA RAVON, CA FIX , E BND		
RAVON, CA FIX	REANS, CA FIX	
	E BND	12800
	W BND	9000
REANS, CA FIX	*YUCCA, CA FIX	13700
*12300 - MCA YUCCA, CA FIX , W BND		
YUCCA, CA FIX	TWENTYNINE PALMS, CA VORTAC	*8500
*7700 - MOCA		
TWENTYNINE PALMS, CA VORTAC	PARKER, CA VORTAC	6000
DRAKE, AZ VORTAC	OATES, AZ FIX	10100
OATES, AZ FIX	WINSLOW, AZ VORTAC	10800
WINSLOW, AZ VORTAC	ST JOHNS, AZ VORTAC	8900
ST JOHNS, AZ VORTAC	*SOCORRO, NM VORTAC	**12000
*10000 - MCA SOCORRO, NM VORTAC , W BND		
**11100 - MOCA		
SOCORRO, NM VORTAC	CORONA, NM VORTAC	9500
CORONA, NM VORTAC	TUCUMCARI, NM VORTAC	*11000
*9000 - MOCA		

**95.6265 VOR FEDERAL AIRWAY V265**

KRANT, MD FIX	WESTMINSTER, MD VORTAC	2600
WESTMINSTER, MD VORTAC	*HARRISBURG, PA VORTAC	3400
*3600 - MCA HARRISBURG, PA VORTAC , NW BND		
HARRISBURG, PA VORTAC	*PHILIPSBURG, PA VORTAC	4900
*4800 - MCA PHILIPSBURG, PA VORTAC , SE BND		
PHILIPSBURG, PA VORTAC	KEATING, PA VORTAC	4000

**95.6266 VOR FEDERAL AIRWAY V266**

ELECTRIC CITY, SC VORTAC	PELZE, SC FIX	2800
PELZE, SC FIX	SPARTANBURG, SC VORTAC	2900
GREENSBORO, NC VORTAC	SOUTH BOSTON, VA VORTAC	2700
SOUTH BOSTON, VA VORTAC	LAWRENCEVILLE, VA VORTAC	*3000
*2000 - MOCA		
*2300 - GNSS MEA		
*LAWRENCEVILLE R-269 UNUSABLE, USE SOUTH BOSTON R-086		
LAWRENCEVILLE, VA VORTAC	FRANKLIN, VA VORTAC	UNUSABLE
FRANKLIN, VA VORTAC	*SUNNS, NC FIX	UNUSABLE
*5000 - MCA SUNNS, NC FIX , SE BND		
SUNNS, NC FIX	ELIZABETH CITY, NC VOR/DME	*5000
*4000 - MOCA		
ELIZABETH CITY, NC VOR/DME	WRIGHT BROTHERS, NC VOR/DME	4000

FROM	TO	MEA
<b>95.6267 VOR FEDERAL AIRWAY V267</b>		
DOLPHIN, FL VORTAC *1500 - MOCA	PAHOKEE, FL VOR/DME	*2000
PAHOKEE, FL VOR/DME *1500 - MOCA	DIDDY, FL FIX	*2000
DIDDY, FL FIX	ORLANDO, FL VORTAC	2700
ORLANDO, FL VORTAC	PAOLA, FL FIX	
	N BND	*2800
	S BND	*1900
*1600 - MOCA		
PAOLA, FL FIX	WORMS, FL FIX	2800
WORMS, FL FIX *2100 - MOCA	CRAIG, FL VORTAC	*3000
CRAIG, FL VORTAC *10000 - MRA **3000 - GNSS MEA	*BAXLY, GA FIX	**5000
BAXLY, GA FIX	DUBLIN, GA VORTAC	
	N BND	*3000
	S BND	*5000
*2300 - MOCA		
*2500 - GNSS MEA		
DUBLIN, GA VORTAC *2200 - MOCA	ATHENS, GA VOR/DME	*3000
ATHENS, GA VOR/DME	IRMOS, GA FIX	3100
IRMOS, GA FIX	CORCE, GA FIX	3800
CORCE, GA FIX	TALLE, GA FIX	5300
TALLE, GA FIX	HARRIS, GA VORTAC	7000
HARRIS, GA VORTAC	FORMS, NC FIX	7800
FORMS, NC FIX *6200 - MCA KNITS, TN FIX , S BND	*KNITS, TN FIX	7500
KNITS, TN FIX	VOLUNTEER, TN VORTAC	4200
<b>95.6268 VOR FEDERAL AIRWAY V268</b>		
NESTO, PA FIX *3100 - MOCA	PLEEZ, PA FIX	*4000
PLEEZ, PA FIX *4500 - MOCA	INDIAN HEAD, PA VORTAC	*5000
INDIAN HEAD, PA VORTAC *4600 - MOCA *4700 - GNSS MEA	HAGERSTOWN, MD VOR	*12000
HAGERSTOWN, MD VOR	KEMAR, MD FIX	5000
KEMAR, MD FIX *2600 - MOCA *2700 - GNSS MEA	WESTMINSTER, MD VORTAC	*4000
WESTMINSTER, MD VORTAC	BALTIMORE, MD VORTAC	2500
BALTIMORE, MD VORTAC	SMYRNA, DE VORTAC	2000
SMYRNA, DE VORTAC *1300 - MOCA	LEEAH, NJ FIX	*1800
LEEAH, NJ FIX	AVALO, NJ FIX	2000
AVALO, NJ FIX *4000 - GNSS MEA	HARBO, NJ FIX	*6000
HARBO, NJ FIX *6000 - MRA **3000 - GNSS MEA	*DRIFT, NJ FIX	**7500
DRIFT, NJ FIX *3000 - GNSS MEA	MANTA, NJ FIX	*12000
MANTA, NJ FIX *2000 - MOCA *3000 - GNSS MEA	PLUME, NJ FIX	*7000



FROM TO MEA

**95.6268 VOR FEDERAL AIRWAY V268 - CONTINUED**

PLUME, NJ FIX	*KOPPY, NY FIX	**4000
*5000 - MRA		
**3000 - MOCA		
**3000 - GNSS MEA		
KOPPY, NY FIX	BEADS, NY FIX	*4000
*3000 - MOCA		
*3000 - GNSS MEA		
BEADS, NY FIX	HAMPTON, NY VORTAC	*2500
*1600 - MOCA		
HAMPTON, NY VORTAC	SANDY POINT, RI VOR/DME	2000
SANDY POINT, RI VOR/DME	INNDY, MA FIX	2000
INNDY, MA FIX	*TONNI, MA FIX	6000
*6000 - MRA		
TONNI, MA FIX	*MESH, ME FIX	**5000
*5000 - MRA		
**4000 - GNSS MEA		
MESH, ME FIX	SAPPE, ME FIX	3000
SAPPE, ME FIX	AUGUSTA, ME VOR/DME	*3000
*1800 - MOCA		

**95.6269 VOR FEDERAL AIRWAY V269**

ELY, NV VOR/DME	*SPATS, NV FIX	**13000
*13000 - MCA SPATS, NV FIX , S BND		
**12200 - MOCA		
SPATS, NV FIX	WELLS, NV VOR/DME	11000
WELLS, NV VOR/DME	*TWIN FALLS, ID VORTAC	**13000
*7700 - MCA TWIN FALLS, ID VORTAC , S BND		
**11000 - MOCA		
**11000 - GNSS MEA		
TWIN FALLS, ID VORTAC	BURLEY, ID VOR/DME	7000
BURLEY, ID VOR/DME	POCATELLO, ID VOR/DME	7000
POCATELLO, ID VOR/DME	*JATTS, ID FIX	8000
*9700 - MCA JATTS, ID FIX , NW BND		
JATTS, ID FIX	YOYYU, ID FIX	*16000
*13300 - MOCA		
*13300 - GNSS MEA		
YOYYU, ID FIX	SALMON, ID VOR/DME	*14000
*13500 - MOCA		
*13500 - GNSS MEA		
SALMON, ID VOR/DME	DONNELLY, ID VOR/DME	12000
DONNELLY, ID VOR/DME	HOVEL, ID FIX	12000
HOVEL, ID FIX	FONNA, OR FIX	*12000
*8700 - MOCA		
*9000 - GNSS MEA		
FONNA, OR FIX	WILDHORSE, OR VOR/DME	9000
WILDHORSE, OR VOR/DME	DESCHUTES, OR VORTAC	9500
DESCHUTES, OR VORTAC	MANTE, OR FIX	10000
MANTE, OR FIX	MOBIL, OR FIX	*10000
*7600 - MOCA		
*8000 - GNSS MEA		
MOBIL, OR FIX	COBUR, OR FIX	
	NE BND	7000
	SW BND	5200
COBUR, OR FIX	*EUGENE, OR VORTAC	
	NE BND	5000
	SW BND	4400
*3800 - MCA EUGENE, OR VORTAC , BND		

**95.6270 VOR FEDERAL AIRWAY V270**

ELMIRA, NY VOR/DME	BINGHAMTON, NY VOR/DME	3500
--------------------	------------------------	------

FROM TO MEA

**95.6270 VOR FEDERAL AIRWAY V270 - CONTINUED**

BINGHAMTON, NY VOR/DME	DELANCEY, NY VOR/DME	
	W BND	4500
	E BND	4800
DELANCEY, NY VOR/DME	*ACOVE, NY FIX	6300
*8000 - MRA		
ACOVE, NY FIX	*ATHOS, NY FIX	6300
*6000 - MCA ATHOS, NY FIX , W BND		
ATHOS, NY FIX	CHESTER, MA VOR/DME	4500
CHESTER, MA VOR/DME	GLYDE, MA FIX	4000
GLYDE, MA FIX	BOSTON, MA VOR/DME	*4000
*3000 - MOCA		

**95.6272 VOR FEDERAL AIRWAY V272**

BURNS FLAT, OK VORTAC	WILL ROGERS, OK VORTAC	4500
-----------------------	------------------------	------

**95.6273 VOR FEDERAL AIRWAY V273**

FALLZ, NJ FIX	HUGUENOT, NY VOR/DME	3200
HUGUENOT, NY VOR/DME	HANCOCK, NY VOR/DME	4000

**95.6274 VOR FEDERAL AIRWAY V274**

PULLMAN, MI VOR/DME	VICTORY, MI VOR/DME	3000
VICTORY, MI VOR/DME	SAGINAW, MI VOR/DME	2600

**95.6275 VOR FEDERAL AIRWAY V275**

CINCINNATI, KY VORTAC	DAYTON, OH VOR/DME	3000
DAYTON, OH VOR/DME	KLOEE, OH FIX	*6000
*2500 - MOCA		

**95.6276 VOR FEDERAL AIRWAY V276**

RASHE, PA FIX	MORTO, PA FIX	4000
MORTO, PA FIX	RAVINE, PA VORTAC	4000
RAVINE, PA VORTAC	*HIKES, PA FIX	**4000
*4000 - MRA		
**3500 - MOCA		
HIKES, PA FIX	YARDLEY, PA VOR/DME	*4000
*2400 - MOCA		
YARDLEY, PA VOR/DME	ROBBINSVILLE, NJ VORTAC	2100
ROBBINSVILLE, NJ VORTAC	CASVI, NJ FIX	1900
CASVI, NJ FIX	*GAMBY, NJ FIX	**3000
*6000 - MCA GAMBY, NJ FIX , SE BND		
**1500 - MOCA		
GAMBY, NJ FIX	*PREPI, OA FIX	**6000
*8000 - MRA		
**2000 - MOCA		
**3000 - GNSS MEA		

**95.6277 VOR FEDERAL AIRWAY V277**

ROSEWOOD, OH VORTAC	FORT WAYNE, IN VORTAC	3000
FORT WAYNE, IN VORTAC	BAGEL, IN FIX	2800
BAGEL, IN FIX	KEELER, MI VOR/DME	4000

**95.6278 VOR FEDERAL AIRWAY V278**

TEXICO, TX VORTAC	PLAINVIEW, TX VOR/DME	5800
-------------------	-----------------------	------

FROM TO MEA

**95.6278 VOR FEDERAL AIRWAY V278 - CONTINUED**

BOWIE, TX VORTAC	BONHAM, TX VORTAC	4000
BONHAM, TX VORTAC	PARIS, TX VOR/DME	2400
PARIS, TX VOR/DME	TEXARKANA, AR VORTAC	2000
TEXARKANA, AR VORTAC	WEEBR, AR FIX	2200
WEEBR, AR FIX	WARLO, AR FIX	4000
WARLO, AR FIX	HAMPT, AR FIX	*9000
*1700 - MOCA		
GREENVILLE, MS VOR/DME	SIDON, MS VORTAC	2000
SIDON, MS VORTAC	BIGBEE, MS VORTAC	2400
BIGBEE, MS VORTAC	MINIM, AL FIX	2000
MINIM, AL FIX	VULCAN, AL VORTAC	2600

**95.6279 VOR FEDERAL AIRWAY V279**

GUNNE, OH FIX	FLAG CITY, OH VORTAC	3000
---------------	----------------------	------

**95.6280 VOR FEDERAL AIRWAY V280**

U.S. MEXICAN BORDER	EL PASO, TX VORTAC	*8000
*6300 - MOCA		
EL PASO, TX VORTAC	PINON, NM VOR/DME	8800
PINON, NM VOR/DME	*HOPET, NM FIX	8800
*7400 - MCA HOPET, NM FIX , SW BND		
HOPET, NM FIX	CHISUM, NM VORTAC	7000
CHISUM, NM VORTAC	FRAIZ, NM FIX	
	NE BND	7500
	SW BND	6500
FRAIZ, NM FIX	DEBRA, NM FIX	*7500
*6000 - MOCA		
DEBRA, NM FIX	TEXICO, TX VORTAC	
	NE BND	*6500
	SW BND	*7500
*6000 - MOCA		
TEXICO, TX VORTAC	PANHANDLE, TX VORTAC	*5900
*5600 - MOCA		
PANHANDLE, TX VORTAC	MITBEE, OK VORTAC	5500
MITBEE, OK VORTAC	*CARKO, KS FIX	4000
*5000 - MCA CARKO, KS FIX , NE BND		
CARKO, KS FIX	WIPET, KS FIX	*8000
*3500 - MOCA		
WIPET, KS FIX	HUTCHINSON, KS VOR/DME	
	E BND	3400
	W BND	8000
HUTCHINSON, KS VOR/DME	BUHLS, KS FIX	4000
BUHLS, KS FIX	STONS, KS FIX	*4500
*2900 - MOCA		
STONS, KS FIX	HEYDN, KS FIX	*5000
*2900 - MOCA		
HEYDN, KS FIX	TOPEKA, KS VORTAC	3700

**95.6281 VOR FEDERAL AIRWAY V281**

PASCO, WA VOR/DME	MOSES LAKE, WA VOR/DME	4000
-------------------	------------------------	------

**95.6283 VOR FEDERAL AIRWAY V283**

SEAL BEACH, CA VORTAC	*JOGIT, CA FIX	4000
*6800 - MCA JOGIT, CA FIX , E BND		
JOGIT, CA FIX	KAYOH, CA FIX	
	W BND	6200
	E BND	8000

FROM TO MEA

**95.6283 VOR FEDERAL AIRWAY V283 - CONTINUED**

KAYOH, CA FIX	HOMELAND, CA VOR	8000
HOMELAND, CA VOR	*LUCER, CA FIX	10500
*9300 - MCA LUCER, CA FIX , SW BND		
LUCER, CA FIX	BULGY, CA FIX	*9000
*8000 - MOCA		
BULGY, CA FIX	*HECTOR, CA VORTAC	**9000
*8200 - MCA HECTOR, CA VORTAC , NE BND		
**7000 - MOCA		
HECTOR, CA VORTAC	*WHIGG, CA FIX	10500
*12000 - MRA		
WHIGG, CA FIX	BOULDER CITY, NV VORTAC	10500

**95.6284 VOR FEDERAL AIRWAY V284**

SEA ISLE, NJ VORTAC	CEDAR LAKE, NJ VOR/DME	*2500
*1800 - MOCA		

**95.6285 VOR FEDERAL AIRWAY V285**

BRICKYARD, IN VORTAC	KOKOMO, IN VORTAC	2700
KOKOMO, IN VORTAC	GOSHEN, IN VORTAC	2600
GOSHEN, IN VORTAC	KALAMAZOO, MI VOR/DME	2600
KALAMAZOO, MI VOR/DME	VICTORY, MI VOR/DME	3000

**95.6286 VOR FEDERAL AIRWAY V286**

ELKINS, WV VORTAC	DERIN, WV FIX	
	W BND	5700
	E BND	6200
DERIN, WV FIX	TEAKK, VA FIX	6900
TEAKK, VA FIX	CASANOVA, VA VORTAC	
	W BND	*6900
	E BND	*6500
*5800 - MOCA		
CASANOVA, VA VORTAC	FLUKY, VA FIX	*3000
*2300 - MOCA		
FLUKY, VA FIX	BROOKE, VA VORTAC	2000
BROOKE, VA VORTAC	*ZUNAR, VA FIX	**3000
*5000 - MCA ZUNAR, VA FIX , SE BND		
**2000 - GNSS MEA		
ZUNAR, VA FIX	FAGED, VA FIX	*5000
*2000 - GNSS MEA		
FAGED, VA FIX	GWYNN, VA FIX	2000
GWYNN, VA FIX	CAPE CHARLES, VA VORTAC	*2000
*1500 - MOCA		

**95.6287 VOR FEDERAL AIRWAY V287**

FORT JONES, CA VOR/DME	KLAMA, OR FIX	*12000
*9800 - MOCA		
KLAMA, OR FIX	*ROGUE VALLEY, OR VORTAC	
	SE BND	12000
	NW BND	8000
*7000 - MCA ROGUE VALLEY, OR VORTAC , SE BND		
ROGUE VALLEY, OR VORTAC	KOLER, OR FIX	*8000
*7400 - MOCA		
KOLER, OR FIX	CAMAS, OR FIX	*8500
*6000 - MOCA		
CAMAS, OR FIX	DEROY, OR FIX	
	NW BND	5500
	SE BND	8000

FROM TO MEA

**95.6287 VOR FEDERAL AIRWAY V287 - CONTINUED**

DEROY, OR FIX	NORTH BEND, OR VOR/DME	
	NW BND	4000
	SE BND	8000
NORTH BEND, OR VOR/DME	*RARES, OR FIX	
	N BND	6000
	S BND	3700
*5500 - MRA		
RARES, OR FIX	CRAAF, OR FIX	6000
CRAAF, OR FIX	MCCOY, OR FIX	*4000
*3400 - MOCA		
MCCOY, OR FIX	NEWBERG, OR VOR/DME	3600
NEWBERG, OR VOR/DME	BATTLE GROUND, WA VORTAC	4000
BATTLE GROUND, WA VORTAC	*MALAY, WA FIX	
	NW BND	6000
	SE BND	5000
*9500 - MRA		
MALAY, WA FIX	*TONNO, WA FIX	6000
*5000 - MRA		
TONNO, WA FIX	OLYMPIA, WA VORTAC	4000
OLYMPIA, WA VORTAC	*CARRO, WA FIX	**4000
*4000 - MRA		
**2000 - MOCA		
CARRO, WA FIX	*LOFAL, WA FIX	**6000
*5000 - MCA LOFAL, WA FIX , SW BND		
**5000 - MOCA		
LOFAL, WA FIX	PAINE, WA VOR/DME	*3000
*1900 - MOCA		
PAINE, WA VOR/DME	PENN COVE, WA VOR/DME	*3000
*1800 - MOCA		

**95.6288 VOR FEDERAL AIRWAY V288**

LUCIN, UT VORTAC	*CORIN, UT FIX	**13000
*13000 - MRA		
*16000 - MCA CORIN, UT FIX , E BND		
**9400 - MOCA		
CORIN, UT FIX	FORT BRIDGER, WY VOR/DME	*16000
*11600 - MOCA		
*12000 - GNSS MEA		

**95.6289 VOR FEDERAL AIRWAY V289**

BEAUMONT, TX VOR/DME	HONEE, TX FIX	2000
HONEE, TX FIX	LUFKIN, TX VORTAC	*3000
*2000 - MOCA		
LUFKIN, TX VORTAC	*PIPES, TX FIX	2400
*2400 - MRA		
PIPES, TX FIX	GREGG COUNTY, TX VORTAC	2000
GREGG COUNTY, TX VORTAC	TEXARKANA, AR VORTAC	2000
TEXARKANA, AR VORTAC	*PROVO, AR FIX	
	N BND	4300
	S BND	2200
*4500 - MRA		
PROVO, AR FIX	UMPIR, AR FIX	
	N BND	*4300
	S BND	*3900
*3400 - MOCA		
UMPIR, AR FIX	BATEZ, AR FIX	*4300
*3800 - MOCA		

FROM TO MEA

**95.6289 VOR FEDERAL AIRWAY V289 - CONTINUED**

BATEZ, AR FIX *3600 - MOCA	FORT SMITH, AR VORTAC	*4100
FORT SMITH, AR VORTAC	MULBY, AR FIX	
	SW BND	3300
	NE BND	4000
MULBY, AR FIX	HARRISON, AR VOR/DME	4000
HARRISON, AR VOR/DME	DOGWOOD, MO VORTAC	3400
DOGWOOD, MO VORTAC	PEKLE, MO FIX	*3900
*3000 - MOCA		
PEKLE, MO FIX	VICHY, MO VOR/DME	3000

**95.6290 VOR FEDERAL AIRWAY V290**

RAINELLE, WV VOR *6000 - MCA MONTEBELLO, VA VOR/DME , SE BND	*MONTEBELLO, VA VOR/DME	6500
MONTEBELLO, VA VOR/DME	ROMAN, VA FIX	6300
ROMAN, VA FIX	ARVON, VA FIX	4000
ARVON, VA FIX	FLAT ROCK, VA VORTAC	*5000
*2200 - GNSS MEA		
*FLAT ROCK R-297 UNUSABLE.		
TAR RIVER, NC VORTAC	KENIR, NC FIX	*4000
*1600 - MOCA		
*2000 - GNSS MEA		
KENIR, NC FIX	PUNGO, NC FIX	*5000
*1500 - MOCA		
*2000 - GNSS MEA		

**95.6291 VOR FEDERAL AIRWAY V291**

HOBBS, NM VORTAC *5500 - MOCA	CHISUM, NM VORTAC	*6000
CHISUM, NM VORTAC	DUPAL, NM FIX	
	NW BND	9000
	SE BND	6000
DUPAL, NM FIX	CORONA, NM VORTAC	9000
CORONA, NM VORTAC	ALBUQUERQUE, NM VORTAC	10000
ALBUQUERQUE, NM VORTAC	AROYO, NM FIX	8300
AROYO, NM FIX	*LORAT, NM FIX	9500
*12400 - MCA LORAT, NM FIX , W BND		
LORAT, NM FIX	BLINI, NM FIX	13300
BLINI, NM FIX	GALLUP, NM VORTAC	11000
GALLUP, NM VORTAC	FORAN, AZ FIX	9400
FORAN, AZ FIX	*WINSLOW, AZ VORTAC	9000
*MTA V327 N TO V291 E 11000		
*WINSLOW, AZ VORTAC	*FLAGSTAFF, AZ VOR/DME	10100
*11000 - MCA FLAGSTAFF, AZ VOR/DME , NE BND		
FLAGSTAFF, AZ VOR/DME	KACEE, AZ FIX	11000
KACEE, AZ FIX	PEACH SPRINGS, AZ VOR/DME	*11000
*10000 - MOCA		

**95.6292 VOR FEDERAL AIRWAY V292**

HANCOCK, NY VOR/DME	SAGES, NY FIX	6400
SAGES, NY FIX	WIGAN, NY FIX	UNUSABLE
WIGAN, NY FIX	BARNES, MA VORTAC	*10000
*4900 - MOCA		
*BARNES R-279 UNUSABLE BYD 50 NM		
BARNES, MA VORTAC	GLYDE, MA FIX	*7000
*2700 - MOCA		
*4000 - GNSS MEA		

FROM TO MEA

**95.6292 VOR FEDERAL AIRWAY V292 - CONTINUED**

GLYDE, MA FIX BOSTON, MA VOR/DME \*4000  
 \*3000 - MOCA

**95.6293 VOR FEDERAL AIRWAY V293**

\*GRAND CANYON, AZ VOR/DME \*\*KLIFF, AZ FIX \*\*\*14500  
 \*14500 - MCA GRAND CANYON, AZ VOR/DME , N BND  
 \*\*14500 - MCA KLIFF, AZ FIX , S BND  
 \*\*\*10900 - MOCA  
 KLIFF, AZ FIX PAGE, AZ VOR/DME 8700  
 PAGE, AZ VOR/DME CABER, UT FIX 8500  
 CABER, UT FIX BRYCE CANYON, UT VORTAC 11000  
 BRYCE CANYON, UT VORTAC \*ENOCH, UT VOR/DME 13300  
 \*12100 - MCA ENOCH, UT VOR/DME , E BND  
 ENOCH, UT VOR/DME BERYL, UT FIX 9000  
 BERYL, UT FIX WILSON CREEK, NV VORTAC 11600  
 WILSON CREEK, NV VORTAC ELY, NV VOR/DME 12000  
 ELY, NV VOR/DME \*BULLION, NV VOR/DME \*\*14000  
 \*12000 - MCA BULLION, NV VOR/DME , S BND  
 \*\*13100 - MOCA  
 \*\*MEA IS ESTABLISHED WITH A GAP IN NAVIGATION SIGNAL COVERAGE  
 BULLION, NV VOR/DME SAMAN, ID FIX 10600  
 SAMAN, ID FIX \*TWIN FALLS, ID VORTAC  
 N BND 7500  
 S BND 8600  
 \*6500 - MCA TWIN FALLS, ID VORTAC , S BND  
 TWIN FALLS, ID VORTAC GOODE, ID FIX 6000  
 GOODE, ID FIX \*TORIN, ID FIX 6600  
 \*8700 - MCA TORIN, ID FIX , NW BND  
 TORIN, ID FIX DERSO, ID FIX  
 NW BND 11500  
 SE BND 9200  
 DERSO, ID FIX DONNELLY, ID VOR/DME 11700

**95.6294 VOR FEDERAL AIRWAY V294**

DES MOINES, IA VORTAC CEDAR RAPIDS, IA VOR/DME 2700  
 CEDAR RAPIDS, IA VOR/DME DAVENPORT, IA VORTAC 2600

**95.6295 VOR FEDERAL AIRWAY V295**

VIRGINIA KEY, FL VOR/DME HEATT, FL FIX \*5000  
 \*2100 - MOCA  
 HEATT, FL FIX \*BLUFI, FL FIX \*\*6000  
 \*6000 - MCA BLUFI, FL FIX , S BND  
 \*\*2000 - MOCA  
 BLUFI, FL FIX STOOP, FL FIX \*5000  
 \*2000 - MOCA  
 STOOP, FL FIX TREASURE, FL VORTAC 2000  
 TREASURE, FL VORTAC BAIRN, FL FIX 2600  
 BAIRN, FL FIX ORLANDO, FL VORTAC 2700  
 ORLANDO, FL VORTAC \*SHIMM, FL FIX 2000  
 \*3000 - MRA  
 SHIMM, FL FIX OCALA, FL VORTAC 2000  
 OCALA, FL VORTAC \*PERSE, FL FIX 2000  
 \*3000 - MRA  
 PERSE, FL FIX \*WILON, FL FIX 2000  
 \*3000 - MRA  
 WILON, FL FIX CROSS CITY, FL VORTAC 2000

FROM TO MEA

**95.6295 VOR FEDERAL AIRWAY V295 - CONTINUED**

CROSS CITY, FL VORTAC SEMINOLE, FL VORTAC 2000

**95.6296 VOR FEDERAL AIRWAY V296**

HUSTN, NC FIX	*RAEFO, NC FIX	**5000
*6000 - MRA		
**2300 - MOCA		
**2400 - GNSS MEA		
RAEFO, NC FIX	FAYETTEVILLE, NC VOR/DME	*5000
*1900 - MOCA		
FAYETTEVILLE, NC VOR/DME	WILMINGTON, NC VORTAC	*3000
*2100 - MOCA		

**95.6298 VOR FEDERAL AIRWAY V298**

*SEATTLE, WA VORTAC	VAMPS, WA FIX	
	W BND	**4000
	E BND	**8400
*4300 - MCA SEATTLE, WA VORTAC , E BND		
**3100 - MOCA		
**5300 - GNSS MEA		
VAMPS, WA FIX	BANDR, WA FIX	
	E BND	*8400
	W BND	*7700
*7700 - GNSS MEA		
BANDR, WA FIX	*BEEZR, WA FIX	8400
*9000 - MRA		
BEEZR, WA FIX	PERTT, WA FIX	*9000
*7500 - MOCA		
PERTT, WA FIX	YAKIMA, WA VORTAC	6600
YAKIMA, WA VORTAC	*SUNED, WA FIX	**5000
*5500 - MRA		
**4300 - MOCA		
SUNED, WA FIX	BENTY, WA FIX	*5000
*4300 - MOCA		
BENTY, WA FIX	PASCO, WA VOR/DME	*4000
*3500 - MOCA		
PASCO, WA VOR/DME	PENDLETON, OR VORTAC	4000
PENDLETON, OR VORTAC	CABAN, OR FIX	6000
CABAN, OR FIX	IBEAM, OR FIX	8300
IBEAM, OR FIX	DONNELLY, ID VOR/DME	12000
DONNELLY, ID VOR/DME	*DUBOIS, ID VORTAC	**16000
*9800 - MCA DUBOIS, ID VORTAC , W BND		
**13600 - MOCA		
DUBOIS, ID VORTAC	*SABAT, ID FIX	
	W BND	**9000
	E BND	**13000
*10000 - MRA		
*11100 - MCA SABAT, ID FIX , E BND		
**8100 - MOCA		
SABAT, ID FIX	LAMON, ID FIX	
	W BND	*10000
	E BND	*13000
*8100 - MOCA		
LAMON, ID FIX	*QUIRT, WY FIX	15000
*14100 - MCA QUIRT, WY FIX , W BND		
QUIRT, WY FIX	DUNOIR, WY VOR/DME	*12000
*10800 - MOCA		
DUNOIR, WY VOR/DME	*BOYSEN RESERVOIR, WY VOR/DME	14000
*11000 - MCA BOYSEN RESERVOIR, WY VOR/DME , W BND		



FROM TO MEA

**95.6298 VOR FEDERAL AIRWAY V298 - CONTINUED**

BOYSEN RESERVOIR, WY VOR/DME *10300 - MOCA	MUDDY MOUNTAIN, WY VOR/DME	*11000
MUDDY MOUNTAIN, WY VOR/DME	CHANG, WY FIX	8500
CHANG, WY FIX	GILLETTE, WY VOR/DME	7200

**95.6299 VOR FEDERAL AIRWAY V299**

*LOS ANGELES, CA VORTAC *3200 - MCA LOS ANGELES, CA VORTAC , W BND	VENTURA, CA VOR/DME	5000
VENTURA, CA VOR/DME	*FILLMORE, CA VORTAC	5000
*7200 - MCA FILLMORE, CA VORTAC , N BND		
FILLMORE, CA VORTAC	GORMAN, CA VORTAC	9500

**95.6300 VOR FEDERAL AIRWAY V300**

U.S. CANADIAN BORDER *2400 - MOCA	AVALE, MI FIX	*9000
AVALE, MI FIX *2400 - MOCA	U.S. CANADIAN BORDER	*3000
U.S. CANADIAN BORDER *2400 - MOCA	SAULT STE MARIE, MI VOR/DME	*3000
SAULT STE MARIE, MI VOR/DME *2500 - MOCA	U.S. CANADIAN BORDER	*3000
U.S. CANADIAN BORDER *2500 - MOCA	NAASH, MI FIX	*3000
NAASH, MI FIX *2500 - MOCA	U.S. CANADIAN BORDER	*6000
U.S. CANADIAN BORDER *5900 - MOCA *5900 - GNSS MEA	CAMPO, ME FIX	*9000
CAMPO, ME FIX *6000 - MOCA *6000 - GNSS MEA	WRAPT, ME FIX	*9000
WRAPT, ME FIX *5900 - MOCA *5900 - GNSS MEA	MILLINOCKET, ME VOR/DME	*7000
MILLINOCKET, ME VOR/DME *2200 - MOCA	U.S. CANADIAN BORDER	*3000

**95.6301 VOR FEDERAL AIRWAY V301**

PANOCHE, CA VORTAC *6500 - MCA SUNOL, CA FIX , SE BND	*SUNOL, CA FIX	6500
SUNOL, CA FIX	OAKLAND, CA VOR/DME	4000
OAKLAND, CA VOR/DME *4000 - MOCA	COMMO, CA FIX	*5000
COMMO, CA FIX	POINT REYES, CA VOR/DME	5000
POINT REYES, CA VOR/DME *11000 - MCA ROZZA, CA FIX , N BND	*ROZZA, CA FIX	3500
ROZZA, CA FIX *4500 - MOCA *5000 - GNSS MEA	KLOGE, CA FIX	*11000
KLOGE, CA FIX *6600 - MOCA *7000 - GNSS MEA	RUMSY, CA FIX	*11000
RUMSY, CA FIX	WILLIAMS, CA VORTAC	
	SW BND	11000
	NE BND	5300

**95.6302 VOR FEDERAL AIRWAY V302**

AUGUSTA, ME VOR/DME *3000 - GNSS MEA	ANCOR, ME FIX	*5000
---	---------------	-------

FROM	TO	MEA
<b>95.6303 VOR FEDERAL AIRWAY V303</b>		
HOT SPRINGS, AR VOR/DME *5000 - MRA **3000 - MOCA	*BLURB, AR FIX	**3500
BLURB, AR FIX *3600 - MOCA	BLIMP, AR FIX	*4100
BLIMP, AR FIX *2400 - MOCA	FORT SMITH, AR VORTAC	*2900
<b>95.6305 VOR FEDERAL AIRWAY V305</b>		
EL DORADO, AR VOR/DME LITTLE ROCK, AR VORTAC	LITTLE ROCK, AR VORTAC DUMPI, AR FIX S BND N BND	3300 2000 4000
DUMPI, AR FIX *2200 - MOCA	WALNUT RIDGE, AR VORTAC	*4000
CUNNINGHAM, KY VOR/DME POCKET CITY, IN VORTAC	POCKET CITY, IN VORTAC AUGUS, IN FIX N BND S BND	2600 2400 3500
AUGUS, IN FIX *1900 - MOCA	WEGEE, IN FIX	*3500
WEGEE, IN FIX HOOSIER, IN VORTAC *2700 - GNSS MEA *HOOSIER R-027 UNUSABLE.	HOOSIER, IN VORTAC BRICKYARD, IN VORTAC	2700 *2700
BRICKYARD, IN VORTAC WELDO, IN FIX	WELDO, IN FIX KOKOMO, IN VORTAC	2900 2700
<b>95.6306 VOR FEDERAL AIRWAY V306</b>		
JUNCTION, TX VORTAC *5000 - MCA AMUSE, TX FIX , W BND **5000 - MOCA	*AMUSE, TX FIX	**7000
AMUSE, TX FIX CENTEX, TX VORTAC NAVASOTA, TX VOR/DME ZMSKL, TX FIX *2400 - MOCA	CENTEX, TX VORTAC NAVASOTA, TX VOR/DME ZMSKL, TX FIX CLEEP, TX FIX	3300 2400 2000 *5000
CLEEP, TX FIX DAISETTA, TX VORTAC	DAISETTA, TX VORTAC KUUPR, TX FIX W BND E BND	3100 2300 2800
KUUPR, TX FIX OFERS, LA FIX	OFERS, LA FIX LAKE CHARLES, LA VORTAC	2800 2000
<b>95.6307 VOR FEDERAL AIRWAY V307</b>		
CHANUTE, KS VOR/DME EMPORIA, KS VORTAC *5000 - MCA ALMAS, KS FIX , N BND	EMPORIA, KS VORTAC *ALMAS, KS FIX	3000 3300
ALMAS, KS FIX *3000 - MOCA	PAWNEE CITY, NE VORTAC	*5000
PAWNEE CITY, NE VORTAC	OMAHA, IA VORTAC	3000
<b>95.6308 VOR FEDERAL AIRWAY V308</b>		
NOTTINGHAM, MD VORTAC *6000 - MCA BILIT, MD FIX , W BND **1600 - MOCA **2000 - GNSS MEA	*BILIT, MD FIX	**6000

FROM	TO	MEA
<b>95.6308 VOR FEDERAL AIRWAY V308 - CONTINUED</b>		
BILIT, MD FIX *1500 - MOCA	WATERLOO, DE VOR/DME	*2000
WATERLOO, DE VOR/DME *1500 - MOCA	SEA ISLE, NJ VORTAC	*2000
SEA ISLE, NJ VORTAC *4000 - GNSS MEA	AVALO, NJ FIX	*4500
AVALO, NJ FIX *4000 - GNSS MEA	HARBO, NJ FIX	*6000
HARBO, NJ FIX *6000 - MRA **3000 - GNSS MEA	*DRIFT, NJ FIX	**7500
DRIFT, NJ FIX *3000 - GNSS MEA	MANTA, NJ FIX	*12000
MANTA, NJ FIX *2000 - MOCA *3000 - GNSS MEA	PLUME, NJ FIX	*7000
PLUME, NJ FIX *5000 - MRA **3000 - MOCA **3000 - GNSS MEA	*KOPPY, NY FIX	**4000
KOPPY, NY FIX *3000 - MOCA *3000 - GNSS MEA	BEADS, NY FIX	*4000
BEADS, NY FIX *1600 - MOCA	HAMPTON, NY VORTAC	*2500
HAMPTON, NY VORTAC	GROTON, CT VOR/DME	2000
GROTON, CT VOR/DME	NORWICH, CT VOR/DME	2000

**95.6309 VOR FEDERAL AIRWAY V309**

CHARLESTON, WV VOR/DME *5000 - MRA *5700 - MCA JULEA, WV FIX , NE BND **3200 - MOCA **3200 - GNSS MEA	*JULEA, WV FIX	**5000
JULEA, WV FIX *3200 - MOCA *3200 - GNSS MEA	RANDE, WV FIX	*7000
RANDE, WV FIX *3300 - MOCA *3400 - GNSS MEA	BURGS, WV FIX	*7000
BURGS, WV FIX	BELLAIRE, OH VOR/DME	3400

**95.6310 VOR FEDERAL AIRWAY V310**

LOUISVILLE, KY VORTAC *5000 - MRA **2900 - MOCA	*DARBY, KY FIX	**3300
DARBY, KY FIX *3000 - MOCA	LONDON, KY VOR/DME	*3300
LONDON, KY VOR/DME *4100 - MOCA	ROSAR, KY FIX SE BND NW BND	*6900 *5500
ROSAR, KY FIX *6900 - MCA HOLSTON MOUNTAIN, TN VORTAC , E BND	*HOLSTON MOUNTAIN, TN VORTAC	6900
HOLSTON MOUNTAIN, TN VORTAC	STAIN, TN FIX	6900
STAIN, TN FIX *8500 - MCA BURCH, NC FIX , W BND	*BURCH, NC FIX	8500

FROM	TO	MEA
------	----	-----

**95.6310 VOR FEDERAL AIRWAY V310 - CONTINUED**

BURCH, NC FIX	GREENSBORO, NC VORTAC	3500
GREENSBORO, NC VORTAC	*CHAPL, NC FIX	3100
*2800 - MCA CHAPL, NC FIX , W BND		
CHAPL, NC FIX	RALEIGH/DURHAM, NC VORTAC	*2400
*1900 - MOCA		
RALEIGH/DURHAM, NC VORTAC	TAR RIVER, NC VORTAC	2600
TAR RIVER, NC VORTAC	ELIZABETH CITY, NC VOR/DME	*4000
*1600 - MOCA		
*2000 - GNSS MEA		

**95.6311 VOR FEDERAL AIRWAY V311**

HINCH MOUNTAIN, TN VOR/DME	DUBBS, TN FIX	5000
DUBBS, TN FIX	MADOL, GA FIX	*7000
*6400 - MOCA		
MADOL, GA FIX	*NELLO, GA FIX	**8000
*8000 - MCA NELLO, GA FIX , N BND		
*7000 - MCA NELLO, GA FIX , E BND		
**6400 - MOCA		
NELLO, GA FIX	AWSON, GA FIX	*7000
*5500 - MOCA		
AWSON, GA FIX	CORCE, GA FIX	*5400
*4600 - MOCA		
CORCE, GA FIX	ELECTRIC CITY, SC VORTAC	3800
ELECTRIC CITY, SC VORTAC	GREENWOOD, SC VORTAC	2500
GREENWOOD, SC VORTAC	COLUMBIA, SC VORTAC	2400
COLUMBIA, SC VORTAC	*ERNIE, SC FIX	2000
*2500 - MRA		
ERNIE, SC FIX	SACKS, SC FIX	2000
SACKS, SC FIX	CHARLESTON, SC VORTAC	2100

**95.6312 VOR FEDERAL AIRWAY V312**

POLLA, MD FIX	TACKS, MD FIX	2200
		MAA - 13000
TACKS, MD FIX	WOODSTOWN, NJ VORTAC	*2000
*1500 - MOCA		
WOODSTOWN, NJ VORTAC	COYLE, NJ VORTAC	2100
COYLE, NJ VORTAC	*DRIFT, NJ FIX	2000
*6000 - MRA		
DRIFT, NJ FIX	*PREPI, OA FIX	**4800
*8000 - MRA		
**2500 - GNSS MEA		

**95.6313 VOR FEDERAL AIRWAY V313**

CENTRALIA, IL VORTAC	ADDERS, IL VORTAC	2500
ADDERS, IL VORTAC	PONTIAC, IL VOR/DME	3000

**95.6314 VOR FEDERAL AIRWAY V314**

U.S. CANADIAN BORDER	PATTA, ME WP	*6000
*3900 - MOCA		
PATTA, ME WP	MILLINOCKET, ME VOR/DME	*6000
*3900 - MOCA		

**95.6315 VOR FEDERAL AIRWAY V315**

PARIS, TX VOR/DME	RICH MOUNTAIN, OK VORTAC	4200
-------------------	--------------------------	------

FROM	TO	MEA
<b>95.6316 VOR FEDERAL AIRWAY V316</b>		
IRONWOOD, MI VOR/DME *3700 - MOCA	SAWYER, MI VOR/DME	*6000
<b>95.6317 VOR FEDERAL AIRWAY V317</b>		
MISSION BAY, CA VORTAC	POGGI, CA VORTAC	4500
POGGI, CA VORTAC	IMPERIAL, CA VORTAC	7000
<b>95.6319 VOR FEDERAL AIRWAY V319</b>		
BOYSEN RESERVOIR, WY VOR/DME	WORLAND, WY VOR/DME	9600
WORLAND, WY VOR/DME	ALVIL, WY FIX	7000
ALVIL, WY FIX	CODY, WY VOR/DME	8500
<b>95.6320 VOR FEDERAL AIRWAY V320</b>		
PELLSTON, MI VORTAC	TRAVERSE CITY, MI VOR/DME	3000
TRAVERSE CITY, MI VOR/DME	MOUNT PLEASANT, MI VOR/DME	5000
MOUNT PLEASANT, MI VOR/DME	SAGINAW, MI VOR/DME	2600
<b>95.6321 VOR FEDERAL AIRWAY V321</b>		
PECAN, GA VOR/DME	KUTVE, GA FIX	2000
KUTVE, GA FIX	*PREST, GA FIX	2600
*5000 - MCA PREST, GA FIX , NW BND		
PREST, GA FIX	*COLUMBUS, GA VORTAC	**5000
*5000 - MCA COLUMBUS, GA VORTAC , SE BND		
**3300 - MOCA		
COLUMBUS, GA VORTAC	LAGRANGE, GA VORTAC	2500
LAGRANGE, GA VORTAC	HEFIN, AL FIX	*4000
*3400 - MOCA		
HEFIN, AL FIX	GADSDEN, AL VOR/DME	4000
GADSDEN, AL VOR/DME	ALBER, AL FIX	3100
ALBER, AL FIX	ROCKET, AL VORTAC	3700
ROCKET, AL VORTAC	SHELBYVILLE, TN VOR/DME	3000
SHELBYVILLE, TN VOR/DME	LIVINGSTON, TN VOR/DME	3800
<b>95.6323 VOR FEDERAL AIRWAY V323</b>		
MONTGOMERY, AL VORTAC	EUFAULA, AL VORTAC	2400
EUFAULA, AL VORTAC	WILMS, GA FIX	*3000
*2100 - MOCA		
<b>95.6324 VOR FEDERAL AIRWAY V324</b>		
GILLETTE, WY VOR/DME	*CRAZY WOMAN, WY VOR/DME	7500
*9500 - MCA CRAZY WOMAN, WY VOR/DME , W BND		
CRAZY WOMAN, WY VOR/DME	CHAPY, WY FIX	12000
CHAPY, WY FIX	WORLAND, WY VOR/DME	
	E BND	12000
	W BND	8000
<b>95.6325 VOR FEDERAL AIRWAY V325</b>		
COLUMBIA, SC VORTAC	*VESTO, GA FIX	8000
*8000 - MCA VESTO, GA FIX , E BND		
VESTO, GA FIX	ATHENS, GA VOR/DME	
	W BND	2500
	E BND	8000

FROM TO MEA

**95.6325 VOR FEDERAL AIRWAY V325 - CONTINUED**

DALAS, GA FIX	CARAN, GA FIX	*GNSS - 5000
*3700 - MOCA		
*GADSDEN R-089 UNUSABLE BYD 47NM EXCEPT FOR ACFT EQUIPPED WITH SUITABLE RNAV SYSTEM WITH GPS		
CARAN, GA FIX	GADSDEN, AL VOR/DME	*5000
*4200 - MOCA		
GADSDEN, AL VOR/DME	FEWER, AL FIX	3500
		MAA - 17500

**95.6326 VOR FEDERAL AIRWAY V326**

FILLMORE, CA VORTAC	VAN NUYS, CA VOR/DME	5000
---------------------	----------------------	------

**95.6327 VOR FEDERAL AIRWAY V327**

PHOENIX, AZ VORTAC	KNOBB, AZ FIX	8000
KNOBB, AZ FIX	RADOM, AZ FIX	
	S BND	8000
	N BND	11000
RADOM, AZ FIX	*FERER, AZ FIX	
	N BND	**12000
	S BND	**11000
*12000 - MRA		
*11000 - MCA FERER, AZ FIX , S BND		
**8400 - MOCA		
**9000 - GNSS MEA		
FERER, AZ FIX	OATES, AZ FIX	*12000
*9400 - MOCA		
*10000 - GNSS MEA		
OATES, AZ FIX	*FLAGSTAFF, AZ VOR/DME	10500
*11000 - MCA FLAGSTAFF, AZ VOR/DME , BND		

**95.6328 VOR FEDERAL AIRWAY V328**

JACKSON, WY VOR/DME	BIG PINEY, WY VOR/DME	13500
MTA V328 NW TO V465 SW 15100		
BIG PINEY, WY VOR/DME	ROCK SPRINGS, WY VOR/DME	*10000
*9700 - MOCA		
ROCK SPRINGS, WY VOR/DME	SNAKY, WY FIX	11000
SNAKY, WY FIX	CELIA, CO FIX	*12000
*10000 - GNSS MEA		
CELIA, CO FIX	HAYDEN, CO VOR/DME	10000
HAYDEN, CO VOR/DME	HABRO, CO FIX	10000
HABRO, CO FIX	KREMMLING, CO VOR/DME	13000
KREMMLING, CO VOR/DME	*SKEED, CO FIX	**16500
*16500 - MRA		
**15800 - MOCA		
SKEED, CO FIX	*POWDR, CO FIX	14500
*15600 - MRA		
POWDR, CO FIX	MILE HIGH, CO VORTAC	14000

**95.6330 VOR FEDERAL AIRWAY V330**

WILDHORSE, OR VOR/DME	BOISE, ID VORTAC	8000
BOISE, ID VORTAC	CANEK, ID FIX	
	NW BND	7000
	SE BND	9500
CANEK, ID FIX	ALKAL, ID FIX	*9500
*8500 - MOCA		

FROM TO MEA

**95.6330 VOR FEDERAL AIRWAY V330 - CONTINUED**

ALKAL, ID FIX	TORIN, ID FIX	
	E BND	*8000
	W BND	*9500
*6700 - MOCA		
TORIN, ID FIX	*KINZE, ID FIX	8000
*8000 - MCA KINZE, ID FIX , W BND		
IDAHO FALLS, ID VOR/DME	*OSITY, ID FIX	8000
*9500 - MCA OSITY, ID FIX , E BND		
OSITY, ID FIX	*JACKSON, WY VOR/DME	14000
*13400 - MCA JACKSON, WY VOR/DME , W BND		
*MTA V330 E TO V520 W 16000		
*		
JACKSON, WY VOR/DME	DUNOIR, WY VOR/DME	13000
DUNOIR, WY VOR/DME	*ROWEY, WY FIX	**14000
*11000 - MCA ROWEY, WY FIX , W BND		
**13500 - MOCA		
ROWEY, WY FIX	RIVERTON, WY VOR/DME	8800
RIVERTON, WY VOR/DME	MUDDY MOUNTAIN, WY VOR/DME	8500

**95.6332 VOR FEDERAL AIRWAY V332**

FRIANT, CA VORTAC	HANGTOWN, CA VOR/DME	8500
HANGTOWN, CA VOR/DME	RED BLUFF, CA VORTAC	6000

**95.6333 VOR FEDERAL AIRWAY V333**

DALAS, GA FIX	ROME, GA VORTAC	*4000
*3200 - MOCA		
ROME, GA VORTAC	CHOO CHOO, TN VORTAC	4000
CHOO CHOO, TN VORTAC	*BOOPS, TN FIX	3500
*4500 - MRA		
BOOPS, TN FIX	HINCH MOUNTAIN, TN VOR/DME	5000
HINCH MOUNTAIN, TN VOR/DME	JELLO, TN FIX	5000
JELLO, TN FIX	*WNSOR, KY FIX	**5100
*5100 - MCA WNSOR, KY FIX , S BND		
*5100 - MCA WNSOR, KY FIX , N BND		
**4000 - MOCA		
**4000 - GNSS MEA		
WNSOR, KY FIX	DOLLY, KY FIX	*5100
*4000 - MOCA		
*4000 - GNSS MEA		
DOLLY, KY FIX	LEXINGTON, KY VOR/DME	3800

**95.6334 VOR FEDERAL AIRWAY V334**

SAN JOSE, CA VOR/DME	*OAKEY, CA FIX	5000
*3000 - MCA OAKEY, CA FIX , S BND		
OAKEY, CA FIX	SACRAMENTO, CA VORTAC	2500

**95.6336 VOR FEDERAL AIRWAY V336**

ELLENSBURG, WA VOR/DME	*QUINT, WA FIX	7100
*6500 - MCA QUINT, WA FIX , SW BND		
QUINT, WA FIX	EPHRATA, WA VORTAC	5000

**95.6338 VOR FEDERAL AIRWAY V338**

LINDEN, CA VOR/DME	*HANGTOWN, CA VOR/DME	5000
*7000 - MCA HANGTOWN, CA VOR/DME , NE BND		

FROM TO MEA

**95.6338 VOR FEDERAL AIRWAY V338 - CONTINUED**

HANGTOWN, CA VOR/DME SQUAW VALLEY, CA VOR/DME 11000

**95.6340 VOR FEDERAL AIRWAY V340**

BEARZ, IN FIX KNOX, IN VOR/DME 3000  
 KNOX, IN VOR/DME FORT WAYNE, IN VORTAC 3000

**95.6341 VOR FEDERAL AIRWAY V341**

CEDAR RAPIDS, IA VOR/DME DUBUQUE, IA VORTAC 2900  
 DUBUQUE, IA VORTAC MADISON, WI VORTAC 4000  
 MADISON, WI VORTAC OSHKOSH, WI VORTAC 3000  
 OSHKOSH, WI VORTAC GREEN BAY, WI VORTAC \*3000  
 \*2300 - MOCA  
 IRON MOUNTAIN, MI VOR/DME SAWYER, MI VOR/DME 3100  
 SAWYER, MI VOR/DME HOUGHTON, MI VOR/DME \*4500  
 \*3400 - MOCA

**95.6343 VOR FEDERAL AIRWAY V343**

\*DUBOIS, ID VORTAC RANEY, MT FIX \*\*15000  
 \*8500 - MCA DUBOIS, ID VORTAC , N BND  
 \*\*13200 - MOCA  
 RANEY, MT FIX \*GATEY, MT FIX  
 S BND 14000  
 N BND 10200  
 \*11500 - MCA GATEY, MT FIX , S BND  
 GATEY, MT FIX \*BOZEMAN, MT VOR/DME  
 S BND 11500  
 N BND 8000  
 \*10500 - MCA BOZEMAN, MT VOR/DME , S BND  
 BOZEMAN, MT VOR/DME THESE, MT FIX 8000  
 THESE, MT FIX SUZZY, MT FIX  
 E BND 8300  
 W BND 10800  
 SUZZY, MT FIX EVVER, MT FIX 11000

**95.6344 VOR FEDERAL AIRWAY V344**

DUPREE, SD VOR/DME ABERDEEN, SD VOR/DME \*6500  
 \*4100 - MOCA  
 ABERDEEN, SD VOR/DME FARGO, ND VOR/DME \*3900  
 \*3000 - MOCA

**95.6345 VOR FEDERAL AIRWAY V345**

DELLS, WI VORTAC \*MILTO, WI FIX \*\*3500  
 \*4700 - MCA MILTO, WI FIX , NW BND  
 \*\*2800 - MOCA  
 MILTO, WI FIX EAU CLAIRE, WI VORTAC \*4700  
 \*3500 - MOCA  
 \*3500 - GNSS MEA

**95.6347 VOR FEDERAL AIRWAY V347**

LONDON, KY VOR/DME HINCH MOUNTAIN, TN VOR/DME 4700

**95.6348 VOR FEDERAL AIRWAY V348**

U.S. CANADIAN BORDER U.S. CANADIAN BORDER \*15000  
 \*2800 - MOCA



FROM	TO	MEA
<b>95.6348 VOR FEDERAL AIRWAY V348 - CONTINUED</b>		
U.S. CANADIAN BORDER *2800 - MOCA	U.S. CANADIAN BORDER	*15000
U.S. CANADIAN BORDER *2800 - MOCA	SAULT STE MARIE, MI VOR/DME	*15000
SAULT STE MARIE, MI VOR/DME *3000 - MOCA	U.S. CANADIAN BORDER	*7000
<b>95.6349 VOR FEDERAL AIRWAY V349</b>		
WHATCOM, WA VORTAC *2600 - MOCA	U.S. CANADIAN BORDER	*3000
<b>95.6350 VOR FEDERAL AIRWAY V350</b>		
WICHITA, KS VORTAC	CHANUTE, KS VOR/DME	3600
<b>95.6354 VOR FEDERAL AIRWAY V354</b>		
WILL ROGERS, OK VORTAC	PIONEER, OK VORTAC	4000
PIONEER, OK VORTAC	EMPORIA, KS VORTAC	3500
<b>95.6355 VOR FEDERAL AIRWAY V355</b>		
BOWIE, TX VORTAC	WICHITA FALLS, TX VORTAC	3100
<b>95.6356 VOR FEDERAL AIRWAY V356</b>		
RED TABLE, CO VOR/DME	FISTR, CO FIX	
	NE BND	15200
	SW BND	14200
FISTR, CO FIX	FIDLE, CO FIX	15200
FIDLE, CO FIX	*ELORE, CO FIX	**16500
*12400 - MCA ELORE, CO FIX , W BND		
**15600 - MOCA		
ELORE, CO FIX	MILE HIGH, CO VORTAC	7800
<b>95.6357 VOR FEDERAL AIRWAY V357</b>		
LAKEVIEW, OR VORTAC *9500 - MOCA	WILDHORSE, OR VOR/DME	*10000
WILDHORSE, OR VOR/DME *15000 - MRA	*POTSY, OR FIX	10000
POTSY, OR FIX	BAKER CITY, OR VOR/DME	12000
BAKER CITY, OR VOR/DME *7000 - MCA TOLGA, OR FIX , SE BND	*TOLGA, OR FIX	9000
TOLGA, OR FIX	*WALLA WALLA, WA VOR/DME	6700
*5300 - MCA WALLA WALLA, WA VOR/DME , SE BND		
WALLA WALLA, WA VOR/DME	MOSES LAKE, WA VOR/DME	4000
MOSES LAKE, WA VOR/DME	QUINT, WA FIX	4000
QUINT, WA FIX	WENATCHEE, WA VOR/DME	5500
<b>95.6358 VOR FEDERAL AIRWAY V358</b>		
SAN ANTONIO, TX VORTAC *2800 - MOCA	GUADA, TX FIX	*4000
GUADA, TX FIX	STONEWALL, TX VORTAC	4000
STONEWALL, TX VORTAC *3200 - MOCA	GOOCH SPRINGS, TX VORTAC	*3800

FROM	TO	MEA
<b>95.6358 VOR FEDERAL AIRWAY V358 - CONTINUED</b>		
GOOCH SPRINGS, TX VORTAC	SONET, TX FIX	3000
SONET, TX FIX	WACO, TX VORTAC	2700
<b>95.6359 VOR FEDERAL AIRWAY V359</b>		
U.S. MEXICAN BORDER *2500 - MOCA	LAREDO, TX VORTAC	*3000
<b>95.6360 VOR FEDERAL AIRWAY V360</b>		
SAULT STE MARIE, MI VOR/DME *2600 - MOCA	U.S. CANADIAN BORDER	*6000
<b>95.6361 VOR FEDERAL AIRWAY V361</b>		
RATTLESNAKE, NM VORTAC	MARKE, CO FIX	
	NE BND	16300
	SW BND	9500
MARKE, CO FIX	UNLAP, CO FIX	
	NE BND	*16300
	SW BND	*11000
*10400 - MOCA		
UNLAP, CO FIX	SCRUB, CO FIX	16300
SCRUB, CO FIX	LYZZA, CO FIX	
	SW BND	16300
	NE BND	12400
LYZZA, CO FIX	MONTROSE, CO VOR/DME	
	SW BND	16300
	NE BND	9600
MONTROSE, CO VOR/DME	ICIES, CO FIX	
	S BND	10600
	N BND	15000
ICIES, CO FIX	RED TABLE, CO VOR/DME	15000
RED TABLE, CO VOR/DME	KREMMLING, CO VOR/DME	14000
KREMMLING, CO VOR/DME	BARGR, CO FIX	*16000
*15600 - MOCA		
BARGR, CO FIX	CHEYENNE, WY VORTAC	
	NE BND	9200
	SW BND	16000
<b>95.6363 VOR FEDERAL AIRWAY V363</b>		
MISSION BAY, CA VORTAC	HURSI, CA FIX	3000
HURSI, CA FIX	OORAH, CA FIX	*4000
*2600 - MOCA		
OORAH, CA FIX	OFREE, CA FIX	*4000
*2300 - MOCA		
OFREE, CA FIX	EL TORO, CA VOR/DME	4000
EL TORO, CA VOR/DME	POMONA, CA VORTAC	4000
<b>95.6364 VOR FEDERAL AIRWAY V364</b>		
LINCO, NC FIX	SUGARLOAF MOUNTAIN, NC VORTAC	6000
SUGARLOAF MOUNTAIN, NC VORTAC	WEAKS, NC FIX	8000
WEAKS, NC FIX	UNICO, TN FIX	*9000
*7700 - MOCA		
*7700 - GNSS MEA		
UNICO, TN FIX	HOLSTON MOUNTAIN, TN VORTAC	7000
<b>95.6365 VOR FEDERAL AIRWAY V365</b>		
BURLEY, ID VOR/DME	IDAHO FALLS, ID VOR/DME	8000

FROM TO MEA

**95.6365 VOR FEDERAL AIRWAY V365 - CONTINUED**

IDAHO FALLS, ID VOR/DME	RIGBY, ID FIX	7600
RIGBY, ID FIX	*SABAT, ID FIX	8000
*10000 - MRA		
LIVINGSTON, MT VOR/DME	*BOZEMAN, MT VOR/DME	10900
*10200 - MCA BOZEMAN, MT VOR/DME , E BND		
BOZEMAN, MT VOR/DME	*MENAR, MT FIX	8700
*9200 - MCA MENAR, MT FIX , NW BND		
MENAR, MT FIX	SWEDD, MT FIX	*10000
*9400 - MOCA		
SWEDD, MT FIX	HELENA, MT VORTAC	10000
HELENA, MT VORTAC	WOKEN, MT FIX	9000
WOKEN, MT FIX	*SHIMY, MT FIX	**9500
*7000 - MRA		
**7500 - MOCA		
SHIMY, MT FIX	CHOTE, MT FIX	*9500
*7000 - MOCA		
CHOTE, MT FIX	CUT BANK, MT VOR/DME	7000

**95.6366 VOR FEDERAL AIRWAY V366**

HUGO, CO VOR/DME	FALCON, CO VORTAC	8500
------------------	-------------------	------

**95.6367 VOR FEDERAL AIRWAY V367**

INTERNATIONAL FALLS, MN VOR/DME	U.S. CANADIAN BORDER	3000
---------------------------------	----------------------	------

**95.6368 VOR FEDERAL AIRWAY V368**

ALAMOSA, CO VORTAC	RODDS, CO FIX	
	W BND	13000
	E BND	10000
RODDS, CO FIX	MANUL, NM FIX	13000
MANUL, NM FIX	TURLY, NM FIX	
	E BND	11000
	W BND	9700
TURLY, NM FIX	RATTLESNAKE, NM VORTAC	9000

**95.6370 VOR FEDERAL AIRWAY V370**

LOS ANGELES, CA VORTAC	PRADO, CA FIX	4000
PRADO, CA FIX	PARADISE, CA VORTAC	5000
PARADISE, CA VORTAC	*SETER, CA FIX	5500
*12100 - MCA SETER, CA FIX , E BND		
SETER, CA FIX	BANDS, CA FIX	
	E BND	13000
	W BND	9000
BANDS, CA FIX	*PALM SPRINGS, CA VORTAC	13000
*11800 - MCA PALM SPRINGS, CA VORTAC , W BND		
*6200 - MCA PALM SPRINGS, CA VORTAC , N BND		
PALM SPRINGS, CA VORTAC	TWENTYNINE PALMS, CA VORTAC	7600

**95.6371 VOR FEDERAL AIRWAY V371**

BOILER, IN VORTAC	KNOX, IN VOR/DME	2500
-------------------	------------------	------

**95.6372 VOR FEDERAL AIRWAY V372**

SEAL BEACH, CA VORTAC	*JOGIT, CA FIX	4000
*6800 - MCA JOGIT, CA FIX , E BND		

FROM TO MEA

**95.6372 VOR FEDERAL AIRWAY V372 - CONTINUED**

JOGIT, CA FIX	KAYOH, CA FIX	
	W BND	6200
	E BND	8000
KAYOH, CA FIX	*HOMELAND, CA VOR	8000
*11200 - MCA HOMELAND, CA VOR , NE BND		
HOMELAND, CA VOR	BANDS, CA FIX	
	E BND	13000
	W BND	8000
BANDS, CA FIX	*PALM SPRINGS, CA VORTAC	13000
*11800 - MCA PALM SPRINGS, CA VORTAC , W BND		
PALM SPRINGS, CA VORTAC	BLYTHE, CA VORTAC	8000

**95.6373 VOR FEDERAL AIRWAY V373**

GREENSBORO, NC VORTAC	SANDHILLS, NC VORTAC	3600
-----------------------	----------------------	------

**95.6374 VOR FEDERAL AIRWAY V374**

BINGHAMTON, NY VOR/DME	*GAYEL, NY FIX	**10000
*10000 - MCA GAYEL, NY FIX , NW BND		
**4400 - MOCA		
**4400 - GNSS MEA		
GAYEL, NY FIX	VOLLU, NY FIX	*5000
*3200 - MOCA		
VOLLU, NY FIX	CARMEL, NY VOR/DME	2600
CARMEL, NY VOR/DME	*BETHA, CT FIX	2500
*8000 - MRA		
BETHA, CT FIX	CREAM, NY FIX	2500
CREAM, NY FIX	KURTY, CT FIX	2500
KURTY, CT FIX	GROTON, CT VOR/DME	3000
GROTON, CT VOR/DME	MINNK, RI FIX	*3000
*1500 - MOCA		
MINNK, RI FIX	MARTHAS VINEYARD, MA VOR/DME	*3000
*1600 - MOCA		

**95.6375 VOR FEDERAL AIRWAY V375**

ROANOKE, VA VOR/DME	PROSE, VA FIX	
	E BND	6500
	W BND	5400
PROSE, VA FIX	ROMAN, VA FIX	6500
ROMAN, VA FIX	GORDONSVILLE, VA VORTAC	4000
GORDONSVILLE, VA VORTAC	*HANEY, VA FIX	2800
*7000 - MRA		
HANEY, VA FIX	FLUKY, VA FIX	2600

**95.6376 VOR FEDERAL AIRWAY V376**

RICHMOND, VA VORTAC	*GRUBY, VA FIX	2000
*3000 - MCA GRUBY, VA FIX , N BND		
GRUBY, VA FIX	IRONS, MD FIX	*4500
*1700 - MOCA		

**95.6377 VOR FEDERAL AIRWAY V377**

MONTEBELLO, VA VOR/DME	KESSEL, WV VOR/DME	*6000
*5500 - MOCA		
KESSEL, WV VOR/DME	*TOMAC, WV FIX	4900
*4300 - MCA TOMAC, WV FIX , SW BND		

FROM TO MEA

**95.6377 VOR FEDERAL AIRWAY V377 - CONTINUED**

TOMAC, WV FIX	HAGERSTOWN, MD VOR	4000
HAGERSTOWN, MD VOR	HARRISBURG, PA VORTAC	*5000
*3800 - MOCA		
*4000 - GNSS MEA		

**95.6378 VOR FEDERAL AIRWAY V378**

BALTIMORE, MD VORTAC	*BELAY, MD FIX	2300
*9500 - MCA BELAY, MD FIX , NE BND		
BELAY, MD FIX	TROYZ, MD FIX	*9500
*4000 - GNSS MEA		
TROYZ, MD FIX	NUGGY, PA FIX	*7500
*4000 - GNSS MEA		
NUGGY, PA FIX	MODENA, PA VORTAC	*6000
*2000 - MOCA		
*4000 - GNSS MEA		

**95.6379 VOR FEDERAL AIRWAY V379**

NOTTINGHAM, MD VORTAC	JETTA, MD FIX	1900
JETTA, MD FIX	*GRACO, MD FIX	**3000
*10000 - MRA		
**1600 - MOCA		
GRACO, MD FIX	SMYRNA, DE VORTAC	1800

**95.6380 VOR FEDERAL AIRWAY V380**

O'NEILL, NE VORTAC	WOLBACH, NE VORTAC	*4000
*3500 - MOCA		
WOLBACH, NE VORTAC	GRAND ISLAND, NE VOR/DME	*4000
*3300 - MOCA		
GRAND ISLAND, NE VOR/DME	HASTINGS, NE VOR/DME	4000
HASTINGS, NE VOR/DME	MANKATO, KS VORTAC	3900

**95.6381 VOR FEDERAL AIRWAY V381**

BISHOP, CA VOR/DME	*NIKOL, CA FIX	**13000
*13000 - MCA NIKOL, CA FIX , BND		
**12300 - MOCA		

**95.6382 VOR FEDERAL AIRWAY V382**

GRAND JUNCTION, CO VOR/DME	*CONES, CO VOR/DME	12100
*14200 - MCA CONES, CO VOR/DME , SE BND		
CONES, CO VOR/DME	*DURANGO, CO VOR/DME	15500
*12500 - MCA DURANGO, CO VOR/DME , BND		

**95.6384 VOR FEDERAL AIRWAY V384**

LIVINGSTON, TN VOR/DME	VOLUNTEER, TN VORTAC	6100
------------------------	----------------------	------

**95.6385 VOR FEDERAL AIRWAY V385**

LUBBOCK, TX VORTAC	WAGUN, TX FIX	*8000
*4700 - MOCA		
WAGUN, TX FIX	ABILENE, TX VORTAC	*8000
*3900 - MOCA		

**95.6386 VOR FEDERAL AIRWAY V386**

SAN MARCUS, CA VORTAC	*OHIGH, CA FIX	8000
*9000 - MRA		

FROM TO MEA

**95.6386 VOR FEDERAL AIRWAY V386 - CONTINUED**

OHIGH, CA FIX	*FILLMORE, CA VORTAC	8000
*6100 - MCA FILLMORE, CA VORTAC , W BND		
FILLMORE, CA VORTAC	*SAUGS, CA FIX	6000
*6300 - MCA SAUGS, CA FIX , NE BND		
SAUGS, CA FIX	PALMDALE, CA VORTAC	7000
PALMDALE, CA VORTAC	APLES, CA FIX	7000
APLES, CA FIX	SOGGI, CA FIX	
	E BND	11000
	W BND	9000
SOGGI, CA FIX	YUCCA, CA FIX	*11000
*9400 - MOCA		
YUCCA, CA FIX	*PALM SPRINGS, CA VORTAC	**9000
*7600 - MCA PALM SPRINGS, CA VORTAC , BND		
**8200 - MOCA		

**95.6387 VOR FEDERAL AIRWAY V387**

MC ALLEN, TX VOR/DME	U.S. MEXICAN BORDER	2000
----------------------	---------------------	------

**95.6388 VOR FEDERAL AIRWAY V388**

PARADISE, CA VORTAC	ACINS, CA FIX	
	E BND	7000
	W BND	5000
ACINS, CA FIX	DEWAY, CA FIX	9500
DEWAY, CA FIX	*PALM SPRINGS, CA VORTAC	9500
*6300 - MCA PALM SPRINGS, CA VORTAC , BND		

**95.6389 VOR FEDERAL AIRWAY V389**

CIMARRON, NM VORTAC	*FOGLE, NM FIX	**11600
*15600 - MCA FOGLE, NM FIX , N BND		
**10700 - MOCA		
FOGLE, NM FIX	*EARLS, CO FIX	**15600
*11600 - MRA		
**12000 - MOCA		
EARLS, CO FIX	RADIO, CO FIX	*11600
*8500 - MOCA		
RADIO, CO FIX	PUEBLO, CO VORTAC	8200
PUEBLO, CO VORTAC	DRAKE, CO FIX	7600
DRAKE, CO FIX	FALCON, CO VORTAC	9000

**95.6391 VOR FEDERAL AIRWAY V391**

RATTLESNAKE, NM VORTAC	PLATA, NM FIX	10000
PLATA, NM FIX	CORTEZ, CO VOR/DME	10600
CORTEZ, CO VOR/DME	DOVE CREEK, CO VORTAC	9800
DOVE CREEK, CO VORTAC	PAROX, CO FIX	*12000
*10500 - MOCA		
PAROX, CO FIX	*GRAND JUNCTION, CO VOR/DME	12000
*10700 - MCA GRAND JUNCTION, CO VOR/DME , S BND		
GRAND JUNCTION, CO VOR/DME	BONGO, UT FIX	10800
BONGO, UT FIX	*VERNAL, UT VOR/DME	8400
*9500 - MCA VERNAL, UT VOR/DME , N BND		
VERNAL, UT VOR/DME	ROCK SPRINGS, WY VOR/DME	11800

**95.6392 VOR FEDERAL AIRWAY V392**

OAKLAND, CA VOR/DME	*SALAD, CA FIX	4000
*4700 - MCA SALAD, CA FIX , NE BND		

FROM TO MEA

**95.6392 VOR FEDERAL AIRWAY V392 - CONTINUED**

SALAD, CA FIX	*OAKEY, CA FIX	5000
*3000 - MCA OAKEY, CA FIX , S BND		
OAKEY, CA FIX	SACRAMENTO, CA VORTAC	2500
SACRAMENTO, CA VORTAC	ROZZY, CA FIX	*3500
*2300 - MOCA		
ROZZY, CA FIX	HAGAN, CA FIX	4000
HAGAN, CA FIX	*AUDIO, CA FIX	**6000
*9000 - MCA AUDIO, CA FIX , NE BND		
**4500 - MOCA		
AUDIO, CA FIX	CONYO, CA FIX	
	N BND	10000
	S BND	8000
CONYO, CA FIX	SIGNA, CA FIX	11000
SIGNA, CA FIX	MUSTANG, NV VORTAC	11500

**95.6393 VOR FEDERAL AIRWAY V393**

*TUCSON, AZ VORTAC	NOGALES, AZ VOR/DME	11500
*9000 - MCA TUCSON, AZ VORTAC , S BND		
NOGALES, AZ VOR/DME	U.S. MEXICAN BORDER	*13000
*8800 - MOCA		

**95.6394 VOR FEDERAL AIRWAY V394**

SEAL BEACH, CA VORTAC	AHEIM, CA FIX	*3000
*2200 - MOCA		
AHEIM, CA FIX	*POMONA, CA VORTAC	4000
*10400 - MCA POMONA, CA VORTAC , NE BND		
POMONA, CA VORTAC	CALBE, CA FIX	
	SW BND	5700
	NE BND	10800
CALBE, CA FIX	MEANT, CA FIX	
	SW BND	10700
	NE BND	11500
MEANT, CA FIX	*APLES, CA FIX	11800
*9200 - MCA APLES, CA FIX , SW BND		
APLES, CA FIX	BASAL, CA FIX	7900
BASAL, CA FIX	DAGGETT, CA VORTAC	7500
DAGGETT, CA VORTAC	*OASYS, NV FIX	**12000
*10400 - MCA OASYS, NV FIX , SW BND		
**9500 - MOCA		
**10000 - GNSS MEA		
OASYS, NV FIX	LAS VEGAS, NV VORTAC	9000
LAS VEGAS, NV VORTAC	MORMON MESA, NV VORTAC	*7500
*6500 - MOCA		

**95.6395 VOR FEDERAL AIRWAY V395**

*TUCSON, AZ VORTAC	NOGALES, AZ VOR/DME	10000
*9000 - MCA TUCSON, AZ VORTAC , S BND		
NOGALES, AZ VOR/DME	U.S. MEXICAN BORDER	*10000
*6500 - MOCA		

**95.6398 VOR FEDERAL AIRWAY V398**

REDWOOD FALLS, MN VOR/DME	*ALMAY, MN FIX	**3400
*5000 - MRA		
**2900 - MOCA		
ALMAY, MN FIX	KASPR, MN FIX	3400

FROM TO MEA

**95.6398 VOR FEDERAL AIRWAY V398 - CONTINUED**

KASPR, MN FIX ROCHESTER, MN VOR/DME 3000

**95.6399 VOR FEDERAL AIRWAY V399**

BRICKYARD, IN VORTAC	JAKKS, IN FIX	2700
JAKKS, IN FIX	BOILER, IN VORTAC	2500
BOILER, IN VORTAC	KENLA, IL FIX	2600
KENLA, IL FIX	PEOTONE, IL VORTAC	2400

**95.6401 VOR FEDERAL AIRWAY V401**

WORLAND, WY VOR/DME	RANKK, WY FIX	
	SE BND	11000
	NW BND	7000
RANKK, WY FIX	MUDDY MOUNTAIN, WY VOR/DME	11000

**95.6402 VOR FEDERAL AIRWAY V402**

TUCUMCARI, NM VORTAC	MOSER, TX FIX	6300
MOSER, TX FIX	PANHANDLE, TX VORTAC	*6000
*5500 - MOCA		
PANHANDLE, TX VORTAC	*BRISC, TX FIX	**8000
*8000 - MCA BRISC, TX FIX , NE BND		
**5000 - MOCA		
BRISC, TX FIX	*MITBEE, OK VORTAC	**8000
*8000 - MCA MITBEE, OK VORTAC , BND		
**4500 - MOCA		

**95.6403 VOR FEDERAL AIRWAY V403**

BELAY, MD FIX	SPERY, PA FIX	*10000
*2100 - MOCA		
*3000 - GNSS MEA		
SPERY, PA FIX	POTTSTOWN, PA VORTAC	*3000
*2100 - MOCA		
POTTSTOWN, PA VORTAC	SOLBERG, NJ VOR/DME	*6000
*2200 - MOCA		

**95.6404 VOR FEDERAL AIRWAY V404**

CHILDRESS, TX VORTAC	*SNEED, TX FIX	4700
*5000 - MRA		
SNEED, TX FIX	WICHITA FALLS, TX VORTAC	
	E BND	3000
	W BND	4700

**95.6405 VOR FEDERAL AIRWAY V405**

BELAY, MD FIX	SPERY, PA FIX	*10000
*2100 - MOCA		
*3000 - GNSS MEA		
SPERY, PA FIX	POTTSTOWN, PA VORTAC	*3000
*2100 - MOCA		
POTTSTOWN, PA VORTAC	*LANNA, NJ FIX	6000
*5000 - MRA		
*6000 - MCA LANNA, NJ FIX , SW BND		
LANNA, NJ FIX	SOLBERG, NJ VOR/DME	2700
SOLBERG, NJ VOR/DME	CARMEL, NY VOR/DME	*3000
*2500 - MOCA		



FROM TO MEA

**95.6405 VOR FEDERAL AIRWAY V405 - CONTINUED**

CARMEL, NY VOR/DME	CASSH, NY FIX	3000
CASSH, NY FIX	PAWLING, NY VOR/DME	3100
PAWLING, NY VOR/DME	COBOL, MA FIX	*4000
*3500 - MOCA		
COBOL, MA FIX	BARNES, MA VORTAC	3500
BARNES, MA VORTAC	PUTNAM, CT VOR/DME	*3000
*2500 - MOCA		
PUTNAM, CT VOR/DME	PROVIDENCE, RI VOR/DME	*3000
*2100 - MOCA		
PROVIDENCE, RI VOR/DME	FALMA, RI FIX	*3000
*1700 - MOCA		
*2000 - GNSS MEA		
FALMA, RI FIX	MARTHAS VINEYARD, MA VOR/DME	*3000
*1600 - MOCA		

**95.6407 VOR FEDERAL AIRWAY V407**

BROWNSVILLE, TX VORTAC	HARLINGEN, TX VOR/DME	1600
HARLINGEN, TX VOR/DME	JIMIE, TX FIX	
	N BND	*6000
	S BND	*1700
*1700 - GNSS MEA		
JIMIE, TX FIX	JETTY, TX FIX	*6000
*1800 - MOCA		
*2000 - GNSS MEA		
JETTY, TX FIX	CORPUS CHRISTI, TX VORTAC	
	N BND	*2100
	S BND	*3800
*2100 - GNSS MEA		
CORPUS CHRISTI, TX VORTAC	PALACIOS, TX VORTAC	1700
PALACIOS, TX VORTAC	GLAND, TX FIX	*4000
*1600 - MOCA		
GLAND, TX FIX	HUMBLE, TX VORTAC	*2500
*1900 - MOCA		
HUMBLE, TX VORTAC	DAISETTA, TX VORTAC	2000
DAISETTA, TX VORTAC	LUFKIN, TX VORTAC	2000
LUFKIN, TX VORTAC	ELM GROVE, LA VORTAC	*4000
*2000 - MOCA		
ELM GROVE, LA VORTAC	EL DORADO, AR VOR/DME	2000

**95.6408 VOR FEDERAL AIRWAY V408**

ROBRT, MD FIX	VINNY, PA FIX	5000
VINNY, PA FIX	MODENA, PA VORTAC	3500
MODENA, PA VORTAC	POTTSTOWN, PA VORTAC	2400
POTTSTOWN, PA VORTAC	*HIKES, PA FIX	2900
*4000 - MRA		
HIKES, PA FIX	EAST TEXAS, PA VOR/DME	2900
EAST TEXAS, PA VOR/DME	ALLENTOWN, PA VORTAC	*3000
*ALLENTOWN R-240 UNUSABLE BELOW 9000 USE EAST TEXAS R-059		

**95.6409 VOR FEDERAL AIRWAY V409**

CHARLOTTE, NC VOR/DME	LOCAS, NC FIX	3100
LOCAS, NC FIX	LIBERTY, NC VORTAC	*3000
*2400 - MOCA		
LIBERTY, NC VORTAC	RALEIGH/DURHAM, NC VORTAC	3100

**95.6412 VOR FEDERAL AIRWAY V412**

REDWOOD FALLS, MN VOR/DME	FLYING CLOUD, MN VOR/DME	*4000
*2800 - MOCA		

FROM	TO	MEA
<b>95.6413 VOR FEDERAL AIRWAY V413</b>		
GOPHER, MN VORTAC	BITLR, WI FIX	3500
BITLR, WI FIX	EAU CLAIRE, WI VORTAC	*3500
*2800 - MOCA		
EAU CLAIRE, WI VORTAC	RUSSH, WI FIX	
	SW BND	*6000
	NE BND	*8000
		MAA - 17500
*2900 - MOCA		
RUSSH, WI FIX	IRONWOOD, MI VOR/DME	8000
<b>95.6415 VOR FEDERAL AIRWAY V415</b>		
MONTGOMERY, AL VORTAC	SEMAN, AL FIX	2300
SEMAN, AL FIX	GIFFY, AL FIX	*4000
*3300 - MOCA		
GIFFY, AL FIX	FELTO, GA FIX	*6000
*3400 - MOCA		
FELTO, GA FIX	GORGO, GA FIX	*5000
*4000 - MOCA		
GORGO, GA FIX	ROME, GA VORTAC	4000
ROME, GA VORTAC	*NELLO, GA FIX	5600
*6000 - MCA NELLO, GA FIX , E BND		
NELLO, GA FIX	ANNYE, GA FIX	6000
ANNYE, GA FIX	FOOTHILLS, SC VOR/DME	5000
FOOTHILLS, SC VOR/DME	PELAM, SC FIX	4000
PELAM, SC FIX	SPARTANBURG, SC VORTAC	*3000
*2400 - MOCA		
SPARTANBURG, SC VORTAC	LOCKS, SC FIX	2300
<b>95.6417 VOR FEDERAL AIRWAY V417</b>		
VULCAN, AL VORTAC	ROME, GA VORTAC	4000
ROME, GA VORTAC	NELLO, GA FIX	5600
ATHENS, GA VOR/DME	COLLIERS, SC VORTAC	2500
COLLIERS, SC VORTAC	ALLENDALE, SC VOR	3000
ALLENDALE, SC VOR	*STOAS, SC FIX	**6000
*6000 - MCA STOAS, SC FIX , W BND		
**2000 - GNSS MEA		
STOAS, SC FIX	CHARLESTON, SC VORTAC	2000
<b>95.6419 VOR FEDERAL AIRWAY V419</b>		
WESTMINSTER, MD VORTAC	MODENA, PA VORTAC	*3000
*2400 - MOCA		
MODENA, PA VORTAC	*MAZIE, PA FIX	3000
*5000 - MRA		
MAZIE, PA FIX	*HARRS, PA FIX	2500
*5000 - MRA		
HARRS, PA FIX	*BIGGY, NJ FIX	2500
*5000 - MRA		
BIGGY, NJ FIX	SOLBERG, NJ VOR/DME	2500
SOLBERG, NJ VOR/DME	CARMEL, NY VOR/DME	*3000
*2500 - MOCA		
CARMEL, NY VOR/DME	BRISS, CT FIX	*3000
*CARMEL R-057 UNUSABLE		
<b>95.6420 VOR FEDERAL AIRWAY V420</b>		
GREEN BAY, WI VORTAC	TRAVERSE CITY, MI VOR/DME	3500

FROM TO MEA

**95.6420 VOR FEDERAL AIRWAY V420 - CONTINUED**

TRAVERSE CITY, MI VOR/DME	GAYLORD, MI VOR/DME	*3000
*TRAVERSE CITY R-062 UNUSABLE USE GAYLORD R-247		
*		
GAYLORD, MI VOR/DME	ALPENA, MI VORTAC	3200

**95.6421 VOR FEDERAL AIRWAY V421**

ZUNI, NM VORTAC	GALLUP, NM VORTAC	9000
GALLUP, NM VORTAC	RATTLESNAKE, NM VORTAC	10000
RATTLESNAKE, NM VORTAC	*DURANGO, CO VOR/DME	9700
*13200 - MCA DURANGO, CO VOR/DME , N BND		
DURANGO, CO VOR/DME	ZEANS, CO FIX	
	N BND	16500
	S BND	12300
ZEANS, CO FIX	LAZON, CO FIX	16500
LAZON, CO FIX	POWES, CO FIX	
	S BND	16500
	N BND	15000
POWES, CO FIX	BLUE MESA, CO VOR/DME	
	S BND	16500
	N BND	12800
BLUE MESA, CO VOR/DME	*WENDT, CO FIX	
	N BND	16300
	S BND	13400
*13900 - MCA WENDT, CO FIX , N BND		
WENDT, CO FIX	CAZUU, CO FIX	*16300
*14700 - MOCA		
CAZUU, CO FIX	SKIER, CO FIX	16300
SKIER, CO FIX	RED TABLE, CO VOR/DME	*16300
*14900 - MOCA		
RED TABLE, CO VOR/DME	KREMMLING, CO VOR/DME	14000
KREMMLING, CO VOR/DME	ROBERT, CO VOR/DME	12900
ROBERT, CO VOR/DME	HAHNS, CO FIX	*13000
*12300 - MOCA		

**95.6422 VOR FEDERAL AIRWAY V422**

NILES, IL FIX	CHICAGO HEIGHTS, IL VORTAC	3500
CHICAGO HEIGHTS, IL VORTAC	KNOX, IN VOR/DME	2800
KNOX, IN VOR/DME	WEBSTER LAKE, IN VOR	2700
WEBSTER LAKE, IN VOR	FLAG CITY, OH VORTAC	2700

**95.6423 VOR FEDERAL AIRWAY V423**

WILLIAMSPORT, PA VOR/DME	BINGHAMTON, NY VOR/DME	*4300
*3800 - MOCA		

**95.6425 VOR FEDERAL AIRWAY V425**

BROOKLEY, AL VORTAC	AXSIS, AL FIX	2000
---------------------	---------------	------

**95.6429 VOR FEDERAL AIRWAY V429**

CHAMPAIGN, IL VORTAC	ROBERTS, IL VOR/DME	2600
ROBERTS, IL VOR/DME	MEDAN, IL FIX	2500
MEDAN, IL FIX	JOLIET, IL VOR/DME	2400

**95.6430 VOR FEDERAL AIRWAY V430**

CUT BANK, MT VOR/DME	HAVRE, MT VOR/DME	6800
----------------------	-------------------	------

FROM TO MEA

**95.6430 VOR FEDERAL AIRWAY V430 - CONTINUED**

HAVRE, MT VOR/DME *5500 - MOCA	GLASGOW, MT VOR/DME	*6500
GLASGOW, MT VOR/DME *5000 - MOCA	WILLISTON, ND VOR/DME	*6000
WILLISTON, ND VOR/DME *3900 - MOCA	MINOT, ND VOR/DME	*6000
MINOT, ND VOR/DME	DEVILS LAKE, ND VOR/DME	3600
DEVILS LAKE, ND VOR/DME	GRAND FORKS, ND VOR/DME	3300
GRAND FORKS, ND VOR/DME	THIEF RIVER FALLS, MN VOR/DME	2900
THIEF RIVER FALLS, MN VOR/DME *3400 - GNSS MEA	GRAND RAPIDS, MN VOR/DME	*7000
GRAND RAPIDS, MN VOR/DME	DULUTH, MN VORTAC	3000
DULUTH, MN VORTAC	IRONWOOD, MI VOR/DME	3500
IRONWOOD, MI VOR/DME	DINER, MI FIX	3600
DINER, MI FIX *4000 - GNSS MEA	IRON MOUNTAIN, MI VOR/DME	*5000
IRON MOUNTAIN, MI VOR/DME	VUKFI, MI FIX	3300
VUKFI, MI FIX *2300 - MOCA	ESCANABA, MI VOR/DME	*3000

**95.6431 VOR FEDERAL AIRWAY V431**

REVER, MA FIX	LOBBY, MA FIX	2000
LOBBY, MA FIX	GARDNER, MA VOR/DME	3500

**95.6432 VOR FEDERAL AIRWAY V432**

*THERMAL, CA VORTAC *4500 - MCA THERMAL, CA VORTAC , NE BND	**PARKER, CA VORTAC	***9000
**4500 - MCA PARKER, CA VORTAC , BND		
***7300 - MOCA		

**95.6433 VOR FEDERAL AIRWAY V433**

NOTTINGHAM, MD VORTAC	SWANN, MD FIX	UNUSABLE
SWANN, MD FIX	ODESA, MD FIX	UNUSABLE
ODESA, MD FIX *2000 - GNSS MEA	DUPONT, DE VORTAC	*2000
*DUPONT R-233 UNUSABLE BEYOND 22NM.		
DUPONT, DE VORTAC *3000 - GNSS MEA	YARDLEY, PA VOR/DME	*6000
YARDLEY, PA VOR/DME	METRO, NJ FIX	*3000
*2000 - MOCA		MAA - 10000
METRO, NJ FIX *1700 - MOCA	GRITY, NJ FIX	*4000
GRITY, NJ FIX	TICKL, NY FIX	4000
TICKL, NY FIX	LA GUARDIA, NY VOR/DME	2900
LA GUARDIA, NY VOR/DME	DUNBO, NY FIX	2000
DUNBO, NY FIX *1500 - MOCA	BRIDGEPORT, CT VOR/DME	*2000
BRIDGEPORT, CT VOR/DME *5700 - MCA PAWLING, NY VOR/DME , NW BND	*PAWLING, NY VOR/DME	3000
PAWLING, NY VOR/DME	*CYPEN, NY FIX	
	SE BND	6100
	NW BND	10000
*15000 - MRA		
CYPEN, NY FIX *10000 - MCA PETER, NY FIX , NW BND	*PETER, NY FIX	**10000
*10000 - MCA PETER, NY FIX , SE BND		
**6100 - GNSS MEA		

FROM TO MEA

**95.6433 VOR FEDERAL AIRWAY V433 - CONTINUED**

PETER, NY FIX	*ROCKDALE, NY VOR/DME	**10000
*10000 - MCA ROCKDALE, NY VOR/DME , SE BND		
**6100 - GNSS MEA		
**ROCKDALE R-127 UNUSABLE BELOW 10000		
ROCKDALE, NY VOR/DME	STODA, NY FIX	4000
STODA, NY FIX	SYRACUSE, NY VORTAC	2400

**95.6434 VOR FEDERAL AIRWAY V434**

OTTUMWA, IA VOR/DME	MOLINE, IL VOR/DME	*3000
*2500 - MOCA		
MOLINE, IL VOR/DME	PEORIA, IL VORTAC	2600
PEORIA, IL VORTAC	CHAMPAIGN, IL VORTAC	2800
CHAMPAIGN, IL VORTAC	BRICKYARD, IN VORTAC	2700

**95.6436 VOR FEDERAL AIRWAY V436**

HOBART, OK VORTAC	*NEADS, OK FIX	**5400
*5400 - MRA		
*5400 - MCA NEADS, OK FIX , W BND		
**3600 - MOCA		
NEADS, OK FIX	WILL ROGERS, OK VORTAC	3000
WILL ROGERS, OK VORTAC	JABDO, OK FIX	*4500
*3000 - MOCA		
JABDO, OK FIX	SAPPA, OK FIX	*4000
*2400 - MOCA		
SAPPA, OK FIX	TULSA, OK VORTAC	2500

**95.6437 VOR FEDERAL AIRWAY V437**

DOLPHIN, FL VORTAC	PAHOKEE, FL VOR/DME	*2000
*1500 - MOCA		
PAHOKEE, FL VOR/DME	MELBOURNE, FL VOR/DME	*2100
*1600 - MOCA		
MELBOURNE, FL VOR/DME	AWINY, FL FIX	*3000
*1600 - MOCA		
AWINY, FL FIX	OVIDO, FL FIX	
	NW BND	5000
	SE BND	3000
OVIDO, FL FIX	KIZER, FL FIX	*5000
*2800 - MOCA		
KIZER, FL FIX	ORMOND BEACH, FL VORTAC	
	SW BND	*5000
	NE BND	*3600
*2800 - MOCA		
ORMOND BEACH, FL VORTAC	JETSO, FL FIX	*3000
*1400 - MOCA		
JETSO, FL FIX	*SUBER, FL FIX	**5000
*8000 - MCA SUBER, FL FIX , N BND		
**1300 - MOCA		
SUBER, FL FIX	HOTAR, FL FIX	*8000
*1300 - MOCA		
HOTAR, FL FIX	STARY, GA FIX	*8000
*1200 - MOCA		
STARY, GA FIX	SAVANNAH, GA VORTAC	*3000
*1900 - MOCA		
SAVANNAH, GA VORTAC	CHARLESTON, SC VORTAC	2000
CHARLESTON, SC VORTAC	WESEL, SC FIX	
	S BND	1800
	N BND	4000

FROM	TO	MEA
<b>95.6437 VOR FEDERAL AIRWAY V437 - CONTINUED</b>		
WESEL, SC FIX *4500 - MRA **1900 - MOCA	*FILLI, SC FIX	**4000
FILLI, SC FIX	FLORENCE, SC VORTAC	4000
<b>95.6438 VOR FEDERAL AIRWAY V438</b>		
HAGERSTOWN, MD VOR *3300 - MOCA	LUCKE, VA FIX	*3800
<b>95.6439 VOR FEDERAL AIRWAY V439</b>		
DICKINSON, ND VORTAC	WILLISTON, ND VOR/DME	4500
<b>95.6440 VOR FEDERAL AIRWAY V440</b>		
PANHANDLE, TX VORTAC *11000 - MCA BRISC, TX FIX , E BND **5000 - MOCA	*BRISC, TX FIX	**8000
BRISC, TX FIX *4500 - MOCA *5000 - GNSS MEA	BURNS FLAT, OK VORTAC	*11000
BURNS FLAT, OK VORTAC	CARFF, OK FIX	3600
CARFF, OK FIX	WILL ROGERS, OK VORTAC	3000
<b>95.6441 VOR FEDERAL AIRWAY V441</b>		
MELBOURNE, FL VOR/DME	LAKELAND, FL VORTAC	2600
LAKELAND, FL VORTAC	ST PETERSBURG, FL VORTAC	2000
ST PETERSBURG, FL VORTAC	BAYPO, FL FIX	2000
BAYPO, FL FIX *1500 - MOCA	NITTS, FL FIX	*4000
NITTS, FL FIX	OCALA, FL VORTAC NE BND	2000
	SW BND	4000
OCALA, FL VORTAC *3000 - MRA	*LEJKO, FL FIX	2000
LEJKO, FL FIX	GATORS, FL VORTAC	2000
GATORS, FL VORTAC	BRUNSWICK, GA VORTAC	3000
BRUNSWICK, GA VORTAC *1500 - MOCA	STARY, GA FIX	*3000
STARY, GA FIX *1900 - MOCA	SAVANNAH, GA VORTAC	*3000
<b>95.6442 VOR FEDERAL AIRWAY V442</b>		
PARADISE, CA VORTAC *8100 - MOCA *9000 - GNSS MEA	APLES, CA FIX	*10000
APLES, CA FIX *8500 - MOCA	HECTOR, CA VORTAC	*10000
HECTOR, CA VORTAC	CLIPP, CA FIX	9000
CLIPP, CA FIX	PARKER, CA VORTAC	8000
<b>95.6444 VOR FEDERAL AIRWAY V444</b>		
SPOKANE, WA VORTAC	DATES, WA FIX	5000
DATES, WA FIX	WALLA WALLA, WA VOR/DME	4000
BAKER CITY, OR VOR/DME	PAYET, ID FIX	9000

FROM	TO	MEA
<b>95.6444 VOR FEDERAL AIRWAY V444 - CONTINUED</b>		
PAYET, ID FIX	*EMETT, ID FIX	
	SE BND	5900
	NW BND	9000
*9400 - MRA		
EMETT, ID FIX	*BOISE, ID VORTAC	5900
*7400 - MCA BOISE, ID VORTAC , E BND		
BOISE, ID VORTAC	AROWS, ID FIX	
	W BND	8000
	E BND	9000
AROWS, ID FIX	*DERSO, ID FIX	**12500
*15200 - MCA DERSO, ID FIX , E BND		
**10000 - MOCA		
DERSO, ID FIX	SOLDE, ID FIX	*17000
*10400 - MOCA		
SOLDE, ID FIX	*KINZE, ID FIX	
	SE BND	8000
	NW BND	17000
*15900 - MCA KINZE, ID FIX , NW BND		
KINZE, ID FIX	BURLEY, ID VOR/DME	*8000
*7000 - MOCA		
<b>95.6448 VOR FEDERAL AIRWAY V448</b>		
ROGUE VALLEY, OR VORTAC	ROSEBURG, OR VOR/DME	7000
ROSEBURG, OR VOR/DME	*DRAIN, OR FIX	5000
*6000 - MRA		
DRAIN, OR FIX	EUGENE, OR VORTAC	
	N BND	*4000
	S BND	*5000
*3900 - MOCA		
EUGENE, OR VORTAC	GLORR, OR FIX	4000
GLORR, OR FIX	MAVER, OR FIX	6000
MAVER, OR FIX	*BATTLE GROUND, WA VORTAC	5000
*9400 - MCA BATTLE GROUND, WA VORTAC , NE BND		
BATTLE GROUND, WA VORTAC	LEARN, WA FIX	
	SW BND	*10500
	NE BND	*14500
*8000 - MOCA		
LEARN, WA FIX	ANGOO, WA FIX	14500
ANGOO, WA FIX	SIMCO, WA FIX	
	SW BND	*14500
	NE BND	*8500
*7500 - MOCA		
SIMCO, WA FIX	*YAKIMA, WA VORTAC	
	SW BND	12000
	NE BND	6300
*9500 - MCA YAKIMA, WA VORTAC , SW BND		
YAKIMA, WA VORTAC	RUBEL, WA FIX	6000
RUBEL, WA FIX	MOSES LAKE, WA VOR/DME	
	SW BND	6000
	NE BND	4000
MOSES LAKE, WA VOR/DME	BATUM, WA FIX	4000
BATUM, WA FIX	*SPOKANE, WA VORTAC	5000
*5200 - MCA SPOKANE, WA VORTAC , NE BND		
SPOKANE, WA VORTAC	CLASS, ID FIX	*9000
*7600 - MOCA		
CLASS, ID FIX	KILLY, MT FIX	*13000
*9900 - MOCA		
*10000 - GNSS MEA		

FROM TO MEA

**95.6448 VOR FEDERAL AIRWAY V448 - CONTINUED**

KILLY, MT FIX KALISPELL, MT VOR/DME \*12000  
 \*8600 - MOCA  
 \*8600 - GNSS MEA

**95.6452 VOR FEDERAL AIRWAY V452**

NEWPORT, OR VORTAC \*HORTE, OR FIX 6000  
 \*4300 - MCA HORTE, OR FIX , W BND  
 HORTE, OR FIX EUGENE, OR VORTAC 4000  
 EUGENE, OR VORTAC CHEEZ, OR FIX  
 SE BND 7000  
 NW BND 5200  
 CHEEZ, OR FIX MANSN, OR FIX  
 SE BND \*11000  
 NW BND \*8000  
 \*7400 - MOCA  
 \*MEA IS ESTABLISHED WITH A GAP IN NAVIGATION SIGNAL COVERAGE  
 MANSN, OR FIX MIXUP, OR FIX \*11000  
 \*9800 - MOCA  
 MIXUP, OR FIX KLAMATH FALLS, OR VORTAC  
 NW BND 11000  
 SE BND 9100  
 KLAMATH FALLS, OR VORTAC TULIP, CA FIX 9000  
 TULIP, CA FIX BACHS, CA FIX  
 S BND \*14000  
 N BND \*9000  
 \*11000 - GNSS MEA  
 BACHS, CA FIX HALLE, NV FIX \*14000  
 \*10200 - MOCA  
 \*11000 - GNSS MEA  
 HALLE, NV FIX MUSTANG, NV VORTAC \*11000  
 \*9600 - MOCA

**95.6453 VOR FEDERAL AIRWAY V453**

GORDONSVILLE, VA VORTAC CASANOVA, VA VORTAC 4500  
 CASANOVA, VA VORTAC LINDEN, VA VORTAC 5000

**95.6454 VOR FEDERAL AIRWAY V454**

BROOKLEY, AL VORTAC MONROEVILLE, AL VORTAC 2000  
 GIZMO, NC FIX LIBERTY, NC VORTAC 3000  
 LIBERTY, NC VORTAC NOKIY, VA FIX \*6000  
 \*3000 - GNSS MEA  
 NOKIY, VA FIX LAWRENCEVILLE, VA VORTAC \*8000  
 \*3000 - GNSS MEA  
 \*LAWRENCEVILLE R-242 UNUSABLE, USE LIBERTY R-056  
 LAWRENCEVILLE, VA VORTAC JUNKI, VA FIX \*6000  
 \*1900 - MOCA  
 \*2000 - GNSS MEA  
 \*LAWRENCEVILLE R-059 UNUSABLE, USE HOPEWELL R-237  
 JUNKI, VA FIX HOPEWELL, VA VORTAC 2000

**95.6455 VOR FEDERAL AIRWAY V455**

RESERVE, LA VOR/DME PICAYUNE, MS VOR/DME 2000  
 PICAYUNE, MS VOR/DME \*PLUGG, MS FIX 2000  
 \*5000 - MRA  
 PLUGG, MS FIX EATON, MS VORTAC 2000



FROM	TO	MEA
<b>95.6455 VOR FEDERAL AIRWAY V455 - CONTINUED</b>		
EATON, MS VORTAC	MERIDIAN, MS VORTAC	2300
<b>95.6456 VOR FEDERAL AIRWAY V456</b>		
MANKATO, MN VOR/DME *2400 - MOCA	FLYING CLOUD, MN VOR/DME	*2900
<b>95.6457 VOR FEDERAL AIRWAY V457</b>		
BROADWAY, NJ VOR/DME LANCASTER, PA VOR/DME	LANCASTER, PA VOR/DME *ROAST, PA FIX SW BND NE BND	3000  **9000 **4500
*10000 - MRA **2600 - MOCA **4500 - GNSS MEA		
ROAST, PA FIX *4500 - GNSS MEA	VINNY, PA FIX	*9000
VINNY, PA FIX WESTMINSTER, MD VORTAC *3300 - MOCA	WESTMINSTER, MD VORTAC MARTINSBURG, WV VORTAC	3000 *4000
<b>95.6458 VOR FEDERAL AIRWAY V458</b>		
SANTA CATALINA, CA VORTAC AVOLS, CA FIX *2000 - MOCA	AVOLS, CA FIX PACIF, CA FIX	4000 *3000
PACIF, CA FIX OCEANSIDE, CA VORTAC *5000 - MCA VISTA, CA FIX , E BND	OCEANSIDE, CA VORTAC *VISTA, CA FIX	3000 3000
VISTA, CA FIX JULIAN, CA VORTAC *5600 - MCA KUMBA, CA FIX , NW BND	JULIAN, CA VORTAC *KUMBA, CA FIX	7700 7900
KUMBA, CA FIX IMPERIAL, CA VORTAC	IMPERIAL, CA VORTAC BARD, CA VORTAC	4300 3600
<b>95.6459 VOR FEDERAL AIRWAY V459</b>		
SEAL BEACH, CA VORTAC	DARTS, CA FIX SE BND NW BND	 4000 6000
DARTS, CA FIX *6600 - MCA SAUGS, CA FIX , NW BND	*SAUGS, CA FIX	7000
SAUGS, CA FIX LAKE HUGHES, CA VORTAC JEFFY, CA FIX *8600 - MCA LOPES, CA FIX , S BND	LAKE HUGHES, CA VORTAC JEFFY, CA FIX *LOPES, CA FIX	8000 8000 9000
LOPES, CA FIX *5800 - MCA WRING, CA FIX , SE BND	*WRING, CA FIX	8500
WRING, CA FIX TULE, CA VOR/DME EXTRA, CA FIX FRIANT, CA VORTAC *6600 - MOCA	TULE, CA VOR/DME EXTRA, CA FIX FRIANT, CA VORTAC BAGBY, CA FIX	5000 3500 5700 *8500
BAGBY, CA FIX	LINDEN, CA VOR/DME	7000
<b>95.6460 VOR FEDERAL AIRWAY V460</b>		
MISSION BAY, CA VORTAC	*RYAHH, CA FIX E BND W BND	 7000 4000
*6400 - MCA RYAHH, CA FIX , E BND		

FROM TO MEA

**95.6460 VOR FEDERAL AIRWAY V460 - CONTINUED**

RYAHH, CA FIX	BARET, CA FIX	
	E BND	*8400
	W BND	*7000
*6100 - MOCA		
BARET, CA FIX	CANNO, CA FIX	8400
CANNO, CA FIX	JULIAN, CA VORTAC	8800
JULIAN, CA VORTAC	*MOMAR, CA FIX	8500
*7300 - MCA MOMAR, CA FIX , SW BND		
MOMAR, CA FIX	BLYTHE, CA VORTAC	7000

**95.6461 VOR FEDERAL AIRWAY V461**

GILA BEND, AZ VORTAC	BUCKEYE, AZ VORTAC	4000
----------------------	--------------------	------

**95.6463 VOR FEDERAL AIRWAY V463**

WOMAC, GA FIX	*ANNYE, GA FIX	**5000
*5900 - MCA ANNYE, GA FIX , N BND		
**4100 - MOCA		
ANNYE, GA FIX	HARRIS, GA VORTAC	7000

**95.6465 VOR FEDERAL AIRWAY V465**

BULLION, NV VOR/DME	*WELLS, NV VOR/DME	13000
*11800 - MCA WELLS, NV VOR/DME , SW BND		
WELLS, NV VOR/DME	SHEAR, UT FIX	12000
SHEAR, UT FIX	*MALAD CITY, ID VOR/DME	
	SW BND	11000
	NE BND	10000
*10700 - MCA MALAD CITY, ID VOR/DME , NE BND		
MALAD CITY, ID VOR/DME	LUNDI, ID FIX	11500
LUNDI, ID FIX	*JACKSON, WY VOR/DME	**15000
**13300 - MOCA		
**13300 - GNSS MEA		
*MTA V465 NE TO V520 W OR V330 W 16000		
**MEA IS ESTABLISHED WITH A GAP IN NAVIGATION SIGNAL COVERAGE		
JACKSON, WY VOR/DME	DUNOIR, WY VOR/DME	13000
DUNOIR, WY VOR/DME	REDLO, MT FIX	*17000
*14500 - MOCA		
REDLO, MT FIX	LAREI, MT FIX	
	N BND	7200
	S BND	17000
LAREI, MT FIX	*BILLINGS, MT VORTAC	
	S BND	17000
	N BND	6000
*7000 - MCA BILLINGS, MT VORTAC , S BND		
BILLINGS, MT VORTAC	MILES CITY, MT VOR/DME	6000
MILES CITY, MT VOR/DME	WILLISTON, ND VOR/DME	*7000
*5200 - MOCA		
*6000 - GNSS MEA		

**95.6466 VOR FEDERAL AIRWAY V466**

VOLUNTEER, TN VORTAC	TAMPI, TN FIX	3500
TAMPI, TN FIX	YUMMY, VA FIX	4500
YUMMY, VA FIX	GLADE SPRING, VA VOR/DME	6000
GLADE SPRING, VA VOR/DME	*DORFF, VA FIX	6600
*7000 - MRA		
DORFF, VA FIX	PULASKI, VA VORTAC	6000

FROM TO MEA

**95.6468 VOR FEDERAL AIRWAY V468**

*BATTLE GROUND, WA VORTAC	**TROTS, WA FIX	***10000
*5300 - MCA BATTLE GROUND, WA VORTAC , NE BND		
**11500 - MCA TROTS, WA FIX , NE BND		
***7200 - MOCA		
***8000 - GNSS MEA		
TROTS, WA FIX	*SWANY, WA FIX	**11500
*11500 - MCA SWANY, WA FIX , SW BND		
**6800 - MOCA		
**7000 - GNSS MEA		
SWANY, WA FIX	HITCH, WA FIX	*8500
*6800 - MOCA		
*7000 - GNSS MEA		
HITCH, WA FIX	YAKIMA, WA VORTAC	
	SW BND	*8500
	NE BND	*5000
*4400 - MOCA		
*5000 - GNSS MEA		
YAKIMA, WA VORTAC	GLEED, WA FIX	
	NW BND	5500
	SE BND	5000
GLEED, WA FIX	ELLENSBURG, WA VOR/DME	6000

**95.6469 VOR FEDERAL AIRWAY V469**

DANVILLE, VA VOR	LYNCHBURG, VA VOR/DME	3000
LYNCHBURG, VA VOR/DME	RADIA, VA FIX	*
*LYNCHBURG R-352 UNUSABLE		
RELEE, VA FIX	EXRAS, VA FIX	*GNSS - 5200
*LYNCHBURG R-352 UNUSABLE		
EXRAS, VA FIX	BRUCY, VA FIX	*GNSS - 6900
*LYNCHBURG R-352 UNUSABLE		
BRUCY, VA FIX	BOIER, WV FIX	*10000
*6900 - MOCA		
*6900 - GNSS MEA		
BOIER, WV FIX	ELKINS, WV VORTAC	6800
ELKINS, WV VORTAC	TYGAR, WV FIX	*5000
*4400 - MOCA		
TYGAR, WV FIX	MORGANTOWN, WV VOR/DME	4000
MORGANTOWN, WV VOR/DME	*NESTO, PA FIX	**5000
*10000 - MCA NESTO, PA FIX , E BND		
**4300 - MOCA		
NESTO, PA FIX	*JOHNSTOWN, PA VOR/DME	10000
*10000 - MCA JOHNSTOWN, PA VOR/DME , W BND		
JOHNSTOWN, PA VOR/DME	ST THOMAS, PA VORTAC	*5000
*JOHNSTOWN R-125 UNUSABLE USE ST THOMAS R-307		
ST THOMAS, PA VORTAC	BADDI, PA FIX	*5000
*4000 - MOCA		
BADDI, PA FIX	HARRISBURG, PA VORTAC	4000
HARRISBURG, PA VORTAC	JOANE, PA FIX	4000
JOANE, PA FIX	DUPONT, DE VORTAC	3000
DUPONT, DE VORTAC	WOODSTOWN, NJ VORTAC	2000
		MAA - 8000

**95.6470 VOR FEDERAL AIRWAY V470**

PULASKI, VA VORTAC	TABER, VA FIX	5500
TABER, VA FIX	*MONAT, VA FIX	**5600
*4000 - MRA		
**5100 - MOCA		

FROM	TO	MEA
<b>95.6470 VOR FEDERAL AIRWAY V470 - CONTINUED</b>		
MONAT, VA FIX	LYNCHBURG, VA VOR/DME	
	W BND	*4000
	E BND	*3000
*2900 - MOCA		
<b>95.6471 VOR FEDERAL AIRWAY V471</b>		
BANGOR, ME VORTAC	MILLINOCKET, ME VOR/DME	*2500
*2100 - MOCA		
<b>95.6472 VOR FEDERAL AIRWAY V472</b>		
ELIZABETH CITY, NC VOR/DME	BERTI, NC FIX	*4000
*1600 - MOCA		
BERTI, NC FIX	*ZAGGY, NC FIX	**7000
*7000 - MCA ZAGGY, NC FIX , NE BND		
**2100 - MOCA		
**2100 - GNSS MEA		
ZAGGY, NC FIX	KINSTON, NC VORTAC	UNUSABLE
<b>95.6473 VOR FEDERAL AIRWAY V473</b>		
ROANOKE, VA VOR/DME	HOBOS, VA FIX	*6000
*5100 - MOCA		
HOBOS, VA FIX	MONTEBELLO, VA VOR/DME	6000
MONTEBELLO, VA VOR/DME	GORDONSVILLE, VA VORTAC	*6000
*5500 - MOCA		
<b>95.6474 VOR FEDERAL AIRWAY V474</b>		
NESTO, PA FIX	PLEEZ, PA FIX	*4000
*3100 - MOCA		
PLEEZ, PA FIX	INDIAN HEAD, PA VORTAC	*5000
*4500 - MOCA		
INDIAN HEAD, PA VORTAC	ST THOMAS, PA VORTAC	*5000
*4500 - MOCA		
ST THOMAS, PA VORTAC	NOENO, PA FIX	*5000
*4000 - MOCA		
NOENO, PA FIX	DELRO, PA FIX	*5000
*3400 - MOCA		
*3400 - GNSS MEA		
DELRO, PA FIX	*MODENA, PA VORTAC	**10000
*10000 - MCA MODENA, PA VORTAC , BND		
**4000 - GNSS MEA		
<b>95.6476 VOR FEDERAL AIRWAY V476</b>		
LYNCHBURG, VA VOR/DME	GORDONSVILLE, VA VORTAC	3300
<b>95.6477 VOR FEDERAL AIRWAY V477</b>		
HUMBLE, TX VORTAC	LEONA, TX VORTAC	*3000
*2100 - MOCA		
LEONA, TX VORTAC	CEDAR CREEK, TX VORTAC	2100
<b>95.6479 VOR FEDERAL AIRWAY V479</b>		
DUPONT, DE VORTAC	WILJR, NJ FIX	2100

FROM TO MEA

**95.6479 VOR FEDERAL AIRWAY V479 - CONTINUED**

WILJR, NJ FIX	MENGE, NJ FIX	*4000
*1600 - MOCA		
*2000 - GNSS MEA		
MENGE, NJ FIX	YARDLEY, PA VOR/DME	2000

**95.6481 VOR FEDERAL AIRWAY V481**

EUGENE, OR VORTAC	CORVALLIS, OR VOR/DME	3500
CORVALLIS, OR VOR/DME	CRAAF, OR FIX	4000

**95.6483 VOR FEDERAL AIRWAY V483**

DEER PARK, NY VOR/DME	*RYMES, CT FIX	**2500
*5000 - MRA		
**2000 - MOCA		
RYMES, CT FIX	CARMEL, NY VOR/DME	2500
CARMEL, NY VOR/DME	KINGSTON, NY VOR/DME	3000
KINGSTON, NY VOR/DME	WEETS, NY FIX	
	NW BND	*6000
	SE BND	*4000
*3200 - MOCA		
WEETS, NY FIX	RIMBA, NY FIX	6400
RIMBA, NY FIX	DELANCEY, NY VOR/DME	5500
DELANCEY, NY VOR/DME	ROCKDALE, NY VOR/DME	4200
ROCKDALE, NY VOR/DME	STODA, NY FIX	4000
STODA, NY FIX	SYRACUSE, NY VORTAC	2400
SYRACUSE, NY VORTAC	*LYSAN, NY FIX	2300
*3000 - MRA		
LYSAN, NY FIX	ROCHESTER, NY VOR/DME	2300

**95.6484 VOR FEDERAL AIRWAY V484**

HAILEY, ID NDB/DME	KINZE, ID FIX	9300
KINZE, ID FIX	*TWIN FALLS, ID VORTAC	7000
*8000 - MCA TWIN FALLS, ID VORTAC , E BND		
TWIN FALLS, ID VORTAC	WODEN, ID FIX	8800
WODEN, ID FIX	*DRYAD, ID FIX	**12000
*13000 - MCA DRYAD, ID FIX , SE BND		
**9500 - MOCA		
DRYAD, ID FIX	SWITZ, UT FIX	*16000
*11900 - MOCA		
*MEA IS ESTABLISHED WITH A GAP IN NAVIGATION SIGNAL COVERAGE		
SWITZ, UT FIX	CAUSE, UT FIX	*11500
*8600 - MOCA		
CAUSE, UT FIX	*WASATCH, UT VORTAC	8600
*11000 - MCA WASATCH, UT VORTAC , E BND		
WASATCH, UT VORTAC	PARLE, UT FIX	11500
PARLE, UT FIX	MYTON, UT VOR/DME	13000
MYTON, UT VOR/DME	*WINDO, UT FIX	**10500
*13000 - MRA		
**9000 - MOCA		
WINDO, UT FIX	GRAND JUNCTION, CO VOR/DME	10500
GRAND JUNCTION, CO VOR/DME	BATTZ, CO FIX	12300
BATTZ, CO FIX	BLUE MESA, CO VOR/DME	14000
BLUE MESA, CO VOR/DME	HOMME, CO FIX	14600
HOMME, CO FIX	ALAMOSA, CO VORTAC	
	S BND	10000
	N BND	14600

**95.6485 VOR FEDERAL AIRWAY V485**

VENTURA, CA VOR/DME	*HENER, CA FIX	5000
*6500 - MCA HENER, CA FIX , NW BND		

FROM TO MEA

**95.6485 VOR FEDERAL AIRWAY V485 - CONTINUED**

HENER, CA FIX FELLOWS, CA VOR/DME 9000

**95.6487 VOR FEDERAL AIRWAY V487**

LA GUARDIA, NY VOR/DME	DUNBO, NY FIX	2000
DUNBO, NY FIX	*BRIDGEPORT, CT VOR/DME	**2000
*8800 - MCA BRIDGEPORT, CT VOR/DME , N BND		
**1500 - MOCA		
BRIDGEPORT, CT VOR/DME	*MOONI, CT FIX	
	N BND	**12000
	S BND	**6000
*12000 - MCA MOONI, CT FIX , N BND		
*6000 - MCA MOONI, CT FIX , S BND		
**5500 - MOCA		
**6000 - GNSS MEA		
MOONI, CT FIX	*BOWAN, NY FIX	**12000
*12000 - MCA BOWAN, NY FIX , S BND		
**4900 - MOCA		
**6000 - GNSS MEA		
BOWAN, NY FIX	CAMBRIDGE, NY VOR/DME	
	N BND	5000
	S BND	6000
CAMBRIDGE, NY VOR/DME	WEIGH, VT FIX	4600
WEIGH, VT FIX	BURLINGTON, VT VOR/DME	
	N BND	3000
	S BND	4600

**95.6489 VOR FEDERAL AIRWAY V489**

COATE, NJ FIX	HUGUENOT, NY VOR/DME	*4000
*3300 - MOCA		
HUGUENOT, NY VOR/DME	*WEARD, NY FIX	**4000
*15000 - MCA WEARD, NY FIX , NE BND		
**3500 - MOCA		
WEARD, NY FIX	*FILPS, NY FIX	**15000
*15000 - MRA		
*15000 - MCA FILPS, NY FIX , NE BND		
*15000 - MCA FILPS, NY FIX , SW BND		
**6000 - MOCA		
**7000 - GNSS MEA		
FILPS, NY FIX	*SAGES, NY FIX	**15000
*15000 - MCA SAGES, NY FIX , NE BND		
*15000 - MCA SAGES, NY FIX , SW BND		
**6400 - MOCA		
**7000 - GNSS MEA		
SAGES, NY FIX	*CYPER, NY FIX	**15000
*15000 - MRA		
*15000 - MCA CYPER, NY FIX , NE BND		
*15000 - MCA CYPER, NY FIX , SW BND		
**6100 - GNSS MEA		
CYPER, NY FIX	*AGNEZ, NY FIX	**15000
*15000 - MRA		
*15000 - MCA AGNEZ, NY FIX , SW BND		
*15000 - MCA AGNEZ, NY FIX , NE BND		
**6300 - GNSS MEA		
AGNEZ, NY FIX	*ALBANY, NY VORTAC	**15000
*13300 - MCA ALBANY, NY VORTAC , BND		
**6200 - GNSS MEA		

**95.6491 VOR FEDERAL AIRWAY V491**

RAPID CITY, SD VORTAC BFFLO, SD FIX 5000

FROM TO MEA

**95.6491 VOR FEDERAL AIRWAY V491 - CONTINUED**

BFFLO, SD FIX *5000 - MOCA	HAYNI, ND FIX	*9000
HAYNI, ND FIX *4500 - MOCA	DICKINSON, ND VORTAC	*5000
DICKINSON, ND VORTAC *4400 - MOCA	MINOT, ND VOR/DME	*6000

**95.6492 VOR FEDERAL AIRWAY V492**

LA BELLE, FL VORTAC *1500 - MOCA	PAHOKEE, FL VOR/DME	*2000
PAHOKEE, FL VOR/DME *1500 - MOCA	PALM BEACH, FL VORTAC	*2000
PALM BEACH, FL VORTAC *2000 - MOCA	STOOP, FL FIX	*3000
STOOP, FL FIX	MELBOURNE, FL VOR/DME	3000

**95.6493 VOR FEDERAL AIRWAY V493**

LIVINGSTON, TN VOR/DME	LEXINGTON, KY VOR/DME	3600
LEXINGTON, KY VOR/DME	BEAER, KY FIX	3000
BEAER, KY FIX	YORK, KY VORTAC	3300
YORK, KY VORTAC	TARTO, OH FIX	3300
TARTO, OH FIX	APPLETON, OH VORTAC	3000

**95.6494 VOR FEDERAL AIRWAY V494**

CRESCENT CITY, CA VORTAC *3500 - MOCA	FORTUNA, CA VORTAC	*6000
FORTUNA, CA VORTAC *6100 - MOCA	MENDOCINO, CA VORTAC	*13000
MENDOCINO, CA VORTAC *7000 - MCA ROZZA, CA FIX , E BND	*ROZZA, CA FIX	6000
ROZZA, CA FIX *5000 - MOCA *5000 - GNSS MEA	POPES, CA FIX	*7000
POPES, CA FIX	RAGGS, CA FIX	5000
RAGGS, CA FIX	SACRAMENTO, CA VORTAC	5000
SACRAMENTO, CA VORTAC *2300 - MOCA	ROZZY, CA FIX	*3500
ROZZY, CA FIX	HAGAN, CA FIX	4000
HAGAN, CA FIX *9000 - MCA AUDIO, CA FIX , NE BND **4500 - MOCA	*AUDIO, CA FIX	**6000
AUDIO, CA FIX	SQUAW VALLEY, CA VOR/DME	11000
SQUAW VALLEY, CA VOR/DME *11000 - MCA VIKES, NV FIX , SW BND	*VIKES, NV FIX	12000
VIKES, NV FIX *9000 - MCA HAZEN, NV VORTAC , BND **9300 - MOCA	*HAZEN, NV VORTAC	**10000

**95.6495 VOR FEDERAL AIRWAY V495**

U.S. CANADIAN BORDER *1900 - MOCA	WHATCOM, WA VORTAC	*3000
WHATCOM, WA VORTAC	U.S. CANADIAN BORDER	3000
U.S. CANADIAN BORDER **4300 - MOCA *MTA V495 SE TO V4 W 8000	*JAWBN, WA FIX	**5400

FROM TO MEA

**95.6495 VOR FEDERAL AIRWAY V495 - CONTINUED**

JAWBN, WA FIX	LOFAL, WA FIX	*5400
*4300 - MOCA		
LOFAL, WA FIX	*SEATTLE, WA VORTAC	**4000
*4700 - MCA SEATTLE, WA VORTAC , S BND		
**2800 - MOCA		
SEATTLE, WA VORTAC	CIDUG, WA FIX	
	S BND	*9000
	N BND	*5000
*3000 - GNSS MEA		
CIDUG, WA FIX	*ALDER, WA FIX	
	S BND	**9000
	N BND	**5000
*9000 - MCA ALDER, WA FIX , S BND		
**4200 - GNSS MEA		
ALDER, WA FIX	*TOUTL, WA FIX	**9000
*9000 - MCA TOUTL, WA FIX , N BND		
**7000 - GNSS MEA		
TOUTL, WA FIX	BATTLE GROUND, WA VORTAC	
	N BND	*9000
	S BND	*5300
*5300 - GNSS MEA		
BATTLE GROUND, WA VORTAC	NEWBERG, OR VOR/DME	4000
NEWBERG, OR VOR/DME	CORVALLIS, OR VOR/DME	*4000
*3400 - MOCA		
CORVALLIS, OR VOR/DME	HORTE, OR FIX	4000
HORTE, OR FIX	*VAUGN, OR FIX	
	S BND	7000
	N BND	4000
*7000 - MRA		
VAUGN, OR FIX	ROSEBURG, OR VOR/DME	*7000
*4400 - MOCA		
ROSEBURG, OR VOR/DME	MERLI, OR FIX	*8000
*7500 - MOCA		
MERLI, OR FIX	*PAPLE, OR FIX	**9000
*10100 - MRA		
**6500 - MOCA		
PAPLE, OR FIX	*BAYTS, OR FIX	**10100
*10000 - MRA		
**7300 - MOCA		
BAYTS, OR FIX	FORT JONES, CA VOR/DME	*10000
*9400 - MOCA		

**95.6497 VOR FEDERAL AIRWAY V497**

ROME, OR VOR/DME	WILDHORSE, OR VOR/DME	9000
WILDHORSE, OR VOR/DME	KIMBERLY, OR VOR/DME	9000
KIMBERLY, OR VOR/DME	KLICKITAT, OR VOR/DME	7300
KLICKITAT, OR VOR/DME	*SUNED, WA FIX	7000
*5500 - MRA		
SUNED, WA FIX	MOSES LAKE, WA VOR/DME	6000
MOSES LAKE, WA VOR/DME	EPHRATA, WA VORTAC	4000

**95.6499 VOR FEDERAL AIRWAY V499**

BALTIMORE, MD VORTAC	BELAY, MD FIX	2300
BELAY, MD FIX	LANCASTER, PA VOR/DME	2500
LANCASTER, PA VOR/DME	CHLSE, PA FIX	*8000
*4000 - MOCA		
CHLSE, PA FIX	*MEGSS, PA FIX	**8000
*8000 - MCA MEGSS, PA FIX , S BND		
**4300 - MOCA		



FROM TO MEA

**95.6499 VOR FEDERAL AIRWAY V499 - CONTINUED**

MEGSS, PA FIX BINGHAMTON, NY VOR/DME 4900

**95.6500 VOR FEDERAL AIRWAY V500**

BATTLE GROUND, WA VORTAC NEWBERG, OR VOR/DME 4000

NEWBERG, OR VOR/DME GLARA, OR FIX 4000

GLARA, OR FIX HARZL, OR FIX

W BND \*7200

E BND \*10000

\*6700 - MOCA

\*7000 - GNSS MEA

HARZL, OR FIX RATZZ, OR FIX

E BND \*10000

W BND \*8000

\*7400 - MOCA

\*8000 - GNSS MEA

RATZZ, OR FIX \*GASHE, OR FIX \*\*10000

\*10000 - MRA

\*\*8000 - MOCA

\*\*8000 - GNSS MEA

GASHE, OR FIX \*KIMBERLY, OR VOR/DME \*\*9200

\*8500 - MCA KIMBERLY, OR VOR/DME , E BND

\*\*8200 - MOCA

KIMBERLY, OR VOR/DME \*POTSY, OR FIX

E BND 15000

W BND 11100

\*15000 - MRA

POTSY, OR FIX FONNA, OR FIX \*15000

\*10000 - MOCA

FONNA, OR FIX \*HOSTS, OR FIX

E BND \*\*11000

W BND \*\*15000

\*11700 - MRA

\*\*7800 - MOCA

HOSTS, OR FIX PARMO, ID FIX

E BND 7200

W BND 15000

PARMO, ID FIX \*BOISE, ID VORTAC

E BND 5400

W BND 15000

\*7400 - MCA BOISE, ID VORTAC , E BND

BOISE, ID VORTAC AROWS, ID FIX

E BND 9000

W BND 8000

AROWS, ID FIX \*DERSO, ID FIX \*\*12500

\*15200 - MCA DERSO, ID FIX , E BND

\*\*10000 - MOCA

DERSO, ID FIX SOLDE, ID FIX \*17000

\*10400 - MOCA

SOLDE, ID FIX \*REAPS, ID FIX

E BND \*\*14000

W BND \*\*17000

\*15400 - MCA REAPS, ID FIX , W BND

\*\*8200 - MOCA

REAPS, ID FIX BETRE, ID FIX \*9500

\*7000 - MOCA

BETRE, ID FIX POCATELLO, ID VOR/DME 7500

**95.6501 VOR FEDERAL AIRWAY V501**

MARTINSBURG, WV VORTAC HAGERSTOWN, MD VOR 3500

FROM TO MEA

**95.6501 VOR FEDERAL AIRWAY V501 - CONTINUED**

HAGERSTOWN, MD VOR	ST THOMAS, PA VORTAC	4000
ST THOMAS, PA VORTAC	PHILIPSBURG, PA VORTAC	*4500
*4000 - MOCA		

**95.6502 VOR FEDERAL AIRWAY V502**

DODGE CITY, KS VORTAC	*DISKS, KS FIX	**4500
*5000 - MCA DISKS, KS FIX , E BND		
**4000 - MOCA		
DISKS, KS FIX	*SPELT, KS FIX	**5000
*5000 - MRA		
**3300 - MOCA		
SPELT, KS FIX	HUTCHINSON, KS VOR/DME	3200
HUTCHINSON, KS VOR/DME	WAIVE, KS FIX	4000
WAIVE, KS FIX	*FLOSS, KS FIX	3300
*5000 - MRA		
FLOSS, KS FIX	EMPORIA, KS VORTAC	3300
EMPORIA, KS VORTAC	KANSAS CITY, MO VORTAC	3100
KANSAS CITY, MO VORTAC	BRAYMER, MO VOR/DME	2600
BRAYMER, MO VOR/DME	KIRKSVILLE, MO VORTAC	2900

**95.6503 VOR FEDERAL AIRWAY V503**

ROCHESTER, MN VOR/DME	CEDAR RAPIDS, IA VOR/DME	*4500
*3600 - MOCA		

**95.6505 VOR FEDERAL AIRWAY V505**

MASON CITY, IA VOR/DME	FREED, MN FIX	3000
FREED, MN FIX	*ALMAY, MN FIX	**4600
*5000 - MRA		
**2800 - MOCA		
ALMAY, MN FIX	PRAGS, MN FIX	*5000
*2500 - MOCA		
PRAGS, MN FIX	GOPHER, MN VORTAC	3000
DULUTH, MN VORTAC	HIBBING, MN VOR/DME	3300
HIBBING, MN VOR/DME	SQEAK, MN FIX	*5000
*3100 - MOCA		
SQEAK, MN FIX	BEBEL, MN FIX	10000
BEBEL, MN FIX	JIBDU, MN FIX	
	N BND	7000
	S BND	10000
JIBDU, MN FIX	*INTERNATIONAL FALLS, MN VOR/DME	
	N BND	4000
	S BND	10000
*7800 - MCA INTERNATIONAL FALLS, MN VOR/DME , BND		

**95.6507 VOR FEDERAL AIRWAY V507**

ARDMORE, OK VORTAC	WILL ROGERS, OK VORTAC	3100
WILL ROGERS, OK VORTAC	WAXEY, OK FIX	
	W BND	*9300
	E BND	*5000
*3400 - MOCA		
*4000 - GNSS MEA		
WAXEY, OK FIX	ROLLS, OK FIX	
	W BND	*11000
	E BND	*9300
*3800 - MOCA		
*4000 - GNSS MEA		

FROM TO MEA

**95.6507 VOR FEDERAL AIRWAY V507 - CONTINUED**

ROLLS, OK FIX	MITBEE, OK VORTAC	
	N BND	*4000
	S BND	*9300
*4000 - GNSS MEA		

**95.6508 VOR FEDERAL AIRWAY V508**

HILL CITY, KS VORTAC	HAYS, KS VORTAC	*4500
*3900 - MOCA		
HAYS, KS VORTAC	*GLIDE, KS FIX	3900
*4500 - MRA		
GLIDE, KS FIX	SALINA, KS VORTAC	*3900
*3200 - MOCA		
SALINA, KS VORTAC	*VASCO, KS FIX	3000
*5000 - MRA		
VASCO, KS FIX	MANHATTAN, KS VOR/DME	3000
MANHATTAN, KS VOR/DME	TOPEKA, KS VORTAC	3000
TOPEKA, KS VORTAC	RUGBB, KS FIX	2800

**95.6509 VOR FEDERAL AIRWAY V509**

ST PETERSBURG, FL VORTAC	*CROWD, FL FIX	**5000
*5000 - MRA		
**2700 - MOCA		
CROWD, FL FIX	HALLR, FL FIX	*6000
*1800 - MOCA		

**95.6510 VOR FEDERAL AIRWAY V510**

DICKINSON, ND VORTAC	BISMARCK, ND VOR/DME	4600
BISMARCK, ND VOR/DME	*BEHQY, ND FIX	3900
*12000 - MRA		
BEHQY, ND FIX	JAMESTOWN, ND VOR/DME	3900
JAMESTOWN, ND VOR/DME	*CHAFE, ND FIX	3300
*6000 - MRA		
CHAFE, ND FIX	FARGO, ND VOR/DME	
	W BND	3300
	E BND	2700
FARGO, ND VOR/DME	ALEXANDRIA, MN VOR/DME	
	E BND	*3600
	NW BND	*6000
*3100 - MOCA		
ALEXANDRIA, MN VOR/DME	*DAYLE, MN FIX	5000
*5000 - MCA DAYLE, MN FIX , NW BND		
DAYLE, MN FIX	GOPHER, MN VORTAC	4000
GOPHER, MN VORTAC	*BITLR, WI FIX	3500
*5500 - MCA BITLR, WI FIX , SE BND		
BITLR, WI FIX	NODINE, MN VORTAC	5500
NODINE, MN VORTAC	DELLS, WI VORTAC	3000

**95.6511 VOR FEDERAL AIRWAY V511**

LAKELAND, FL VORTAC	HALLR, FL FIX	*4000
*2300 - MOCA		
HALLR, FL FIX	THNDR, FL FIX	*7000
*1700 - MOCA		
*5000 - GNSS MEA		
THNDR, FL FIX	DOLPHIN, FL VORTAC	*3000
*1500 - MOCA		

FROM	TO	MEA
<b>95.6512 VOR FEDERAL AIRWAY V512</b>		
POCKET CITY, IN VORTAC	HOLAN, IN FIX	2600
HOLAN, IN FIX	*SACKO, IN FIX	**3500
*10000 - MCA SACKO, IN FIX , E BND		
**2100 - MOCA		
**3000 - GNSS MEA		
SACKO, IN FIX	LOUISVILLE, KY VORTAC	10000
LOUISVILLE, KY VORTAC	*CLEGG, KY FIX	10000
*10000 - MCA CLEGG, KY FIX , W BND		
CLEGG, KY FIX	LEXINGTON, KY VOR/DME	2800
<b>95.6513 VOR FEDERAL AIRWAY V513</b>		
LIVINGSTON, TN VOR/DME	NEW HOPE, KY VOR/DME	4000
NEW HOPE, KY VOR/DME	LOUISVILLE, KY VORTAC	2700
<b>95.6514 VOR FEDERAL AIRWAY V514</b>		
MISSION BAY, CA VORTAC	*RYAHH, CA FIX	
	E BND	7000
	W BND	4000
*6400 - MCA RYAHH, CA FIX , E BND		
RYAHH, CA FIX	BARET, CA FIX	
	E BND	*8400
	W BND	*7000
*6100 - MOCA		
BARET, CA FIX	CANNO, CA FIX	8400
CANNO, CA FIX	JULIAN, CA VORTAC	8800
JULIAN, CA VORTAC	THERMAL, CA VORTAC	9000
THERMAL, CA VORTAC	*TWENTYNINE PALMS, CA VORTAC	7000
*10200 - MCA TWENTYNINE PALMS, CA VORTAC , NE BND		
TWENTYNINE PALMS, CA VORTAC	GOFFS, CA VORTAC	*12000
*7900 - MOCA		
*8000 - GNSS MEA		
GOFFS, CA VORTAC	BOULDER CITY, NV VORTAC	7600
<b>95.6517 VOR FEDERAL AIRWAY V517</b>		
SNOWBIRD, TN VORTAC	MIAMI, TN FIX	6900
MIAMI, TN FIX	*LONDON, KY VOR/DME	5500
*6000 - MCA LONDON, KY VOR/DME , N BND		
LONDON, KY VOR/DME	*LOGIC, KY FIX	**6000
*6000 - MCA LOGIC, KY FIX , S BND		
**3700 - MOCA		
LOGIC, KY FIX	*CODEL, KY FIX	2800
*3000 - MRA		
CODEL, KY FIX	FALMOUTH, KY VOR/DME	2800
FALMOUTH, KY VOR/DME	CINCINNATI, KY VORTAC	2700
<b>95.6518 VOR FEDERAL AIRWAY V518</b>		
LANGE, CA FIX	*PALMDALE, CA VORTAC	7000
*6300 - MCA PALMDALE, CA VORTAC , BND		
<b>95.6519 VOR FEDERAL AIRWAY V519</b>		
VOLUNTEER, TN VORTAC	TAMPI, TN FIX	3500
TAMPI, TN FIX	YUMMY, VA FIX	4500
YUMMY, VA FIX	GLADE SPRING, VA VOR/DME	6000

FROM TO MEA

**95.6519 VOR FEDERAL AIRWAY V519 - CONTINUED**

GLADE SPRING, VA VOR/DME *13000 - MRA	*TELOC, VA FIX	6900
TELOC, VA FIX	BLUEFIELD, WV VOR/DME NE BND	6100
	SW BND	6900
BLUEFIELD, WV VOR/DME *5900 - MOCA *5900 - GNSS MEA *BECKLEY R-193 UNUSABLE USE BLUEFIELD R-010	BECKLEY, WV VOR/DME	*9000

**95.6520 VOR FEDERAL AIRWAY V520**

*BATTLE GROUND, WA VORTAC *4700 - MCA BATTLE GROUND, WA VORTAC , E BND	KLICKITAT, OR VOR/DME	7000
KLICKITAT, OR VOR/DME AMPLE, WA FIX	AMPLE, WA FIX VIRTU, WA FIX	6000
	NE BND	4000
	SW BND	5000
VIRTU, WA FIX	PASCO, WA VOR/DME	4000
PASCO, WA VOR/DME *5800 - MCA WALLA WALLA, WA VOR/DME , NE BND	*WALLA WALLA, WA VOR/DME	3200
WALLA WALLA, WA VOR/DME CLOVA, WA FIX	CLOVA, WA FIX	8000
CLOVA, WA FIX	*NEZ PERCE, ID VOR/DME NE BND	6000
	SW BND	8000
*10000 - MCA NEZ PERCE, ID VOR/DME , E BND		
NEZ PERCE, ID VOR/DME	ZATIP, ID FIX E BND	12000
	W BND	6800
ZATIP, ID FIX	SALMON, ID VOR/DME	12000
SALMON, ID VOR/DME *9000 - MCA DUBOIS, ID VORTAC , E BND *10600 - MCA DUBOIS, ID VORTAC , W BND	*DUBOIS, ID VORTAC	13600
DUBOIS, ID VORTAC *15200 - MCA JACKSON, WY VOR/DME , BND	*JACKSON, WY VOR/DME	15300

**95.6521 VOR FEDERAL AIRWAY V521**

DOLPHIN, FL VORTAC *1500 - MOCA	RUTHY, FL FIX	*3000
RUTHY, FL FIX	LEE COUNTY, FL VORTAC	2300
LEE COUNTY, FL VORTAC	QUNCY, FL FIX	2600
QUNCY, FL FIX	LAKELAND, FL VORTAC	2300
LAKELAND, FL VORTAC *5000 - MRA **1800 - MOCA	*DADES, FL FIX	**2300
DADES, FL FIX *1800 - MOCA	NITTS, FL FIX	*2300
NITTS, FL FIX *3000 - MRA **1700 - MOCA	*ORATE, FL FIX	**3000
ORATE, FL FIX *1500 - MOCA	CROSS CITY, FL VORTAC	*2000
CROSS CITY, FL VORTAC *1400 - MOCA *2000 - GNSS MEA *CROSS CITY R-289 UNUSABLE BEYOND 60 NM.	HEVVN, FL FIX	*5000
HEVVN, FL FIX *7000 - MRA **1300 - MOCA **GNSS REQUIRED	*TERES, FL FIX	**GNSS - 2000

FROM TO MEA

**95.6521 VOR FEDERAL AIRWAY V521 - CONTINUED**

TERES, FL FIX *1400 - MOCA *2000 - GNSS MEA	CRESS, FL FIX	*4000
CRESS, FL FIX MARIANNA, FL VORTAC WIREGRASS, AL VORTAC SKIPO, AL FIX *4000 - MCA BANBI, AL FIX , SE BND **1900 - MOCA **2300 - GNSS MEA	MARIANNA, FL VORTAC WIREGRASS, AL VORTAC SKIPO, AL FIX *BANBI, AL FIX	2000 2000 2300 **4000
BANBI, AL FIX MONTGOMERY, AL VORTAC KYLEE, AL FIX	MONTGOMERY, AL VORTAC KYLEE, AL FIX VULCAN, AL VORTAC	2400 3000 3800

**95.6524 VOR FEDERAL AIRWAY V524**

HAYDEN, CO VOR/DME LARAMIE, WY VOR/DME *10900 - MOCA *11000 - GNSS MEA	LARAMIE, WY VOR/DME SCOTTSBLUFF, NE VORTAC	14200 *12000
SCOTTSBLUFF, NE VORTAC	NORTH PLATTE, NE VOR/DME	7000

**95.6526 VOR FEDERAL AIRWAY V526**

NORTHBROOK, IL VOR/DME *3500 - MRA	*MINCE, MI FIX	2500
MINCE, MI FIX MUSKY, MI FIX *1700 - MOCA *2600 - GNSS MEA	MUSKY, MI FIX MAPER, MI FIX	2500 *3500
MAPER, MI FIX	GIPPER, MI VORTAC	2600

**95.6527 VOR FEDERAL AIRWAY V527**

*HOT SPRINGS, AR VOR/DME  *5700 - MCA HOT SPRINGS, AR VOR/DME , NW BND	HIDER, AR FIX SE BND NW BND	3200 9500
HIDER, AR FIX  *3200 - MOCA	ROVER, AR FIX SE BND NW BND	*5500 *9500
ROVER, AR FIX *6500 - MRA *9500 - MCA SCRAN, AR FIX , SE BND **3600 - MOCA	*SCRAN, AR FIX	**9500
SCRAN, AR FIX *3700 - MOCA	CASKS, AR FIX	*6500
CASKS, AR FIX RAZORBACK, AR VORTAC *3200 - MOCA	RAZORBACK, AR VORTAC BILIE, MO FIX	4000 *4000
BILIE, MO FIX	SPRINGFIELD, MO VORTAC	3000

**95.6528 VOR FEDERAL AIRWAY V528**

*PHOENIX, AZ VORTAC *8000 - MCA PHOENIX, AZ VORTAC , NE BND **9400 - MOCA **10000 - GNSS MEA	EAGUL, AZ FIX	**14500
---	---------------	---------

FROM TO MEA

**95.6528 VOR FEDERAL AIRWAY V528 - CONTINUED**

EAGUL, AZ FIX	*PAYSO, AZ FIX	**16000
*16000 - MCA PAYSO, AZ FIX , SW BND		
**10000 - MOCA		
PAYSO, AZ FIX	ST JOHNS, AZ VORTAC	*13000
*9800 - MOCA		

**95.6529 VOR FEDERAL AIRWAY V529**

*FAMIN, FL FIX	SWAGS, FL FIX	**5700
*5700 - MRA		
**1500 - MOCA		
SWAGS, FL FIX	LA BELLE, FL VORTAC	*2000
*1400 - MOCA		

**95.6530 VOR FEDERAL AIRWAY V530**

TEXICO, TX VORTAC	CHILDRESS, TX VORTAC	6000
-------------------	----------------------	------

**95.6531 VOR FEDERAL AIRWAY V531**

PALM BEACH, FL VORTAC	*SHEDS, FL FIX	3000
*3000 - MRA		
SHEDS, FL FIX	CUSMO, FL FIX	*6000
*2000 - MOCA		
*2000 - GNSS MEA		
CUSMO, FL FIX	BAIRN, FL FIX	*6000
*2000 - MOCA		
*2000 - GNSS MEA		
*PALM BEACH R-327 UNUSABLE CUSMO-BAIRN		
BAIRN, FL FIX	ORLANDO, FL VORTAC	2700

**95.6532 VOR FEDERAL AIRWAY V532**

LITTLE ROCK, AR VORTAC	*PARON, AR FIX	2600
*3500 - MRA		
PARON, AR FIX	*GATZY, AR FIX	**3700
*4800 - MCA GATZY, AR FIX , W BND		
**3100 - MOCA		
GATZY, AR FIX	*BLURB, AR FIX	**5500
*5000 - MRA		
*5500 - MCA BLURB, AR FIX , E BND		
**3200 - MOCA		
BLURB, AR FIX	BLIMP, AR FIX	*4100
*3600 - MOCA		
BLIMP, AR FIX	FORT SMITH, AR VORTAC	*2900
*2400 - MOCA		
FORT SMITH, AR VORTAC	*AKINS, OK FIX	2500
*3000 - MRA		
AKINS, OK FIX	OKMULGEE, OK VOR/DME	*3000
*2200 - MOCA		
OKMULGEE, OK VOR/DME	PIONEER, OK VORTAC	3000
PIONEER, OK VORTAC	WICHITA, KS VORTAC	3600
WICHITA, KS VORTAC	SALINA, KS VORTAC	3600
SALINA, KS VORTAC	LINCOLN, NE VORTAC	*5000
*3000 - MOCA		

**95.6533 VOR FEDERAL AIRWAY V533**

ST PETERSBURG, FL VORTAC	LAKELAND, FL VORTAC	2000
--------------------------	---------------------	------

FROM TO MEA

**95.6533 VOR FEDERAL AIRWAY V533 - CONTINUED**

LAKELAND, FL VORTAC *4000 - MRA	*CAMBE, FL FIX	2000
CAMBE, FL FIX	ORLANDO, FL VORTAC	2000
ORLANDO, FL VORTAC	OAKIE, FL FIX	2000
OAKIE, FL FIX *1600 - MOCA	ORMOND BEACH, FL VORTAC	*4000

**95.6534 VOR FEDERAL AIRWAY V534**

LITTLE ROCK, AR VORTAC	BIBBS, AR FIX	3500
BIBBS, AR FIX *2500 - MOCA	HAAWK, AR FIX	*4500
HAAWK, AR FIX *6500 - MRA **3100 - MOCA	*SCRAN, AR FIX	**4500
SCRAN, AR FIX  *3000 - MOCA	FORT SMITH, AR VORTAC W BND E BND	*3500 *4500

**95.6535 VOR FEDERAL AIRWAY V535**

SIDON, MS VORTAC *2100 - MOCA	HOLLY SPRINGS, MS VORTAC	*3000
----------------------------------	--------------------------	-------

**95.6536 VOR FEDERAL AIRWAY V536**

NORTH BEND, OR VOR/DME  *5500 - MRA	*RARES, OR FIX N BND S BND	6000 3700
RARES, OR FIX	CORVALLIS, OR VOR/DME	6000
CORVALLIS, OR VOR/DME	SHEDD, OR FIX	3000
SHEDD, OR FIX	LATHE, OR FIX	4000
LATHE, OR FIX *8300 - MCA JAIME, OR FIX , E BND	*JAIME, OR FIX	6000
JAIME, OR FIX *7800 - MOCA	MANTE, OR FIX	*10000
MANTE, OR FIX	DESCHUTES, OR VORTAC	10000
DESCHUTES, OR VORTAC	ZORNS, OR FIX NE BND SW BND	10000 7000
ZORNS, OR FIX *10000 - MRA **7700 - MOCA	*RENCE, OR FIX	**10000
RENCE, OR FIX *7700 - MOCA	HEPPE, OR FIX	*10000
HEPPE, OR FIX	PENDLETON, OR VORTAC NE BND SW BND	6000 10000
PENDLETON, OR VORTAC	WALLA WALLA, WA VOR/DME	4100
WALLA WALLA, WA VOR/DME *5700 - MOCA	PULLMAN, WA VOR/DME	*6000
PULLMAN, WA VOR/DME	MULLAN PASS, ID VOR/DME	9100
MULLAN PASS, ID VOR/DME *9700 - MOCA *10000 - GNSS MEA	KALISPELL, MT VOR/DME	*11500
KALISPELL, MT VOR/DME *10900 - MOCA	GAPAR, MT FIX	*13000



FROM TO MEA

**95.6536 VOR FEDERAL AIRWAY V536 - CONTINUED**

GAPAR, MT FIX	*PIKUN, MT FIX	**12000
*10600 - MCA PIKUN, MT FIX , W BND		
**11400 - MOCA		
PIKUN, MT FIX	*CHOTE, MT FIX	
	W BND	**10000
	E BND	**9000
*9200 - MCA CHOTE, MT FIX , W BND		
**6900 - MOCA		
CHOTE, MT FIX	GREAT FALLS, MT VORTAC	7000
GREAT FALLS, MT VORTAC	SWEDD, MT FIX	*12000
*9700 - MOCA		
SWEDD, MT FIX	*MENAR, MT FIX	**10000
*9200 - MCA MENAR, MT FIX , NW BND		
**9400 - MOCA		
MENAR, MT FIX	*BOZEMAN, MT VOR/DME	8700
*9300 - MCA BOZEMAN, MT VOR/DME , SE BND		
SHERIDAN, WY VOR/DME	GILLETTE, WY VOR/DME	7000
GILLETTE, WY VOR/DME	NEWCASTLE, WY VOR	7500
NEWCASTLE, WY VOR	*ZAMBI, SD FIX	9300
*9300 - MRA		
ZAMBI, SD FIX	*RAPID CITY, SD VORTAC	
	E BND	8000
	W BND	9300
*6500 - MCA RAPID CITY, SD VORTAC , BND		

**95.6537 VOR FEDERAL AIRWAY V537**

PALM BEACH, FL VORTAC	STOOP, FL FIX	*3000
*2000 - MOCA		
STOOP, FL FIX	TREASURE, FL VORTAC	2000
TREASURE, FL VORTAC	*PRESK, FL FIX	3000
*2500 - MRA		
PRESK, FL FIX	CERMO, FL FIX	*8000
*2000 - MOCA		
CERMO, FL FIX	OCALA, FL VORTAC	
	NW BND	2000
	SE BND	8000
OCALA, FL VORTAC	*LEJKO, FL FIX	2000
*3000 - MRA		
LEJKO, FL FIX	GATORS, FL VORTAC	2000
GATORS, FL VORTAC	ALVIN, FL FIX	*3000
*2000 - MOCA		
ALVIN, FL FIX	GREENVILLE, FL VORTAC	2000

**95.6538 VOR FEDERAL AIRWAY V538**

*TWENTYNINE PALMS, CA VORTAC	GOFFS, CA VORTAC	**12000
*10200 - MCA TWENTYNINE PALMS, CA VORTAC , NE BND		
**7900 - MOCA		
**8000 - GNSS MEA		
GOFFS, CA VORTAC	LAS VEGAS, NV VORTAC	9000

**95.6539 VOR FEDERAL AIRWAY V539**

KEY WEST, FL VORTAC	CORGI, FL FIX	1500
CORGI, FL FIX	GOODY, FL FIX	*4000
*1200 - MOCA		
GOODY, FL FIX	LEE COUNTY, FL VORTAC	
	N BND	2100
	S BND	4000

FROM	TO	MEA
<b>95.6540 VOR FEDERAL AIRWAY V540</b>		
CUNNINGHAM, KY VOR/DME	TAMMS, IL FIX	
	NW BND	3500
	SE BND	2800
TAMMS, IL FIX	FARMINGTON, MO VORTAC	3500
<b>95.6541 VOR FEDERAL AIRWAY V541</b>		
GADSDEN, AL VOR/DME	EDDIE, AL FIX	3600
<b>95.6543 VOR FEDERAL AIRWAY V543</b>		
LEEVILLE, LA VORTAC	SAFES, LA FIX	*2000
*1400 - MOCA		
SAFES, LA FIX	WAVEZ, LA FIX	*4000
*1600 - MOCA		
WAVEZ, LA FIX	OYSTY, LA FIX	*3000
*1800 - MOCA		
OYSTY, LA FIX	*RYTHM, LA FIX	2000
*4200 - MCA RYTHM, LA FIX , NE BND		
RYTHM, LA FIX	EATON, MS VORTAC	*4200
*2000 - MOCA		
EATON, MS VORTAC	BAING, MS FIX	*3000
*2000 - MOCA		
BAING, MS FIX	*PAULD, MS FIX	3000
*5000 - MRA		
*3000 - MCA PAULD, MS FIX , SW BND		
PAULD, MS FIX	MERIDIAN, MS VORTAC	2100
<b>95.6545 VOR FEDERAL AIRWAY V545</b>		
MILES CITY, MT VOR/DME	WILLISTON, ND VOR/DME	*7000
*5300 - MOCA		
*6000 - GNSS MEA		
<b>95.6546 VOR FEDERAL AIRWAY V546</b>		
WINK, TX VORTAC	YOGSU, TX FIX	5500
YOGSU, TX FIX	MIDLAND, TX VORTAC	5000
MIDLAND, TX VORTAC	BIG SPRING, TX VORTAC	4400
<b>95.6547 VOR FEDERAL AIRWAY V547</b>		
CHEYENNE, WY VORTAC	HIPSHER, WY VOR/DME	9000
HIPSHER, WY VOR/DME	MUDDY MOUNTAIN, WY VOR/DME	7900
<b>95.6548 VOR FEDERAL AIRWAY V548</b>		
COLLEGE STATION, TX VORTAC	BARBA, TX FIX	2500
BARBA, TX FIX	BOSEL, TX FIX	3600
BOSEL, TX FIX	WACO, TX VORTAC	
	N BND	2800
	S BND	3600
<b>95.6549 VOR FEDERAL AIRWAY V549</b>		
HAYS, KS VORTAC	MANKATO, KS VORTAC	4100
<b>95.6550 VOR FEDERAL AIRWAY V550</b>		
COTULLA, TX VORTAC	LEMIG, TX FIX	2500

FROM	TO	MEA
<b>95.6550 VOR FEDERAL AIRWAY V550 - CONTINUED</b>		
LEMIG, TX FIX	SAN ANTONIO, TX VORTAC	3000
SAN ANTONIO, TX VORTAC	CENTEX, TX VORTAC	3300
<b>95.6551 VOR FEDERAL AIRWAY V551</b>		
SALINA, KS VORTAC	MANKATO, KS VORTAC	6000
<b>95.6552 VOR FEDERAL AIRWAY V552</b>		
BEAUMONT, TX VOR/DME	LAKE CHARLES, LA VORTAC	2000
LAKE CHARLES, LA VORTAC	HATHA, LA FIX	2000
HATHA, LA FIX	LAFAYETTE, LA VORTAC	2800
LAFAYETTE, LA VORTAC	*GRICE, LA FIX	**2000
*4000 - MRA		
**1500 - MOCA		
GRICE, LA FIX	TIBBY, LA VOR/DME	2000
TIBBY, LA VOR/DME	HARVEY, LA VORTAC	2100
HARVEY, LA VORTAC	PICAYUNE, MS VOR/DME	2000
PICAYUNE, MS VOR/DME	*MINDO, MS FIX	2000
*6000 - MRA		
MINDO, MS FIX	SEMMES, AL VORTAC	2000
SEMMES, AL VORTAC	MONROEVILLE, AL VORTAC	2000
<b>95.6553 VOR FEDERAL AIRWAY V553</b>		
SALINA, KS VORTAC	PAWNEE CITY, NE VORTAC	3400
<b>95.6554 VOR FEDERAL AIRWAY V554</b>		
NATCHEZ, MS VOR/DME	*TULLO, LA FIX	**6000
*6000 - MCA TULLO, LA FIX , SE BND		
**1800 - MOCA		
TULLO, LA FIX	MONROE, LA VORTAC	2000
<b>95.6555 VOR FEDERAL AIRWAY V555</b>		
PICAYUNE, MS VOR/DME	MC COMB, MS VORTAC	2000
<b>95.6556 VOR FEDERAL AIRWAY V556</b>		
SAN ANGELO, TX VORTAC	CHILD, TX FIX	4000
CHILD, TX FIX	JUNCTION, TX VORTAC	*5000
*4000 - MOCA		
JUNCTION, TX VORTAC	STONEWALL, TX VORTAC	4000
SCHOLES, TX VOR/DME	SABINE PASS, TX VOR/DME	2000
<b>95.6558 VOR FEDERAL AIRWAY V558</b>		
LLANO, TX VORTAC	SLIMM, TX FIX	3100
SLIMM, TX FIX	CENTEX, TX VORTAC	4100
CENTEX, TX VORTAC	MOUZE, TX FIX	2200
MOUZE, TX FIX	INDUSTRY, TX VORTAC	2100
<b>95.6559 VOR FEDERAL AIRWAY V559</b>		
LAFAYETTE, LA VORTAC	FIGHTING TIGER, LA VORTAC	2100
<b>95.6560 VOR FEDERAL AIRWAY V560</b>		
NEWMAN, TX VORTAC	MAYFY, TX FIX	9000

FROM TO MEA

**95.6560 VOR FEDERAL AIRWAY V560 - CONTINUED**

MAYFY, TX FIX	*CONNE, TX FIX	**10500
*10500 - MRA		
**9000 - MOCA		
CONNE, TX FIX	SALT FLAT, TX VORTAC	9000
SALT FLAT, TX VORTAC	CARLSBAD, NM VORTAC	8000

**95.6561 VOR FEDERAL AIRWAY V561**

GRAND FORKS, ND VOR/DME	JAMESTOWN, ND VOR/DME	*4000
*3000 - MOCA		
JAMESTOWN, ND VOR/DME	PIERRE, SD VORTAC	*10000
*3400 - MOCA		

**95.6562 VOR FEDERAL AIRWAY V562**

PHOENIX, AZ VORTAC	KNOBB, AZ FIX	8000
KNOBB, AZ FIX	RADOM, AZ FIX	
	S BND	8000
	N BND	11000
RADOM, AZ FIX	*FERER, AZ FIX	
	N BND	**12000
	S BND	**11000
*12000 - MRA		
*11000 - MCA FERER, AZ FIX , S BND		
**8400 - MOCA		
**9000 - GNSS MEA		
FERER, AZ FIX	DRAKE, AZ VORTAC	*10000
*9200 - MOCA		
DRAKE, AZ VORTAC	PEACH SPRINGS, AZ VOR/DME	9200
PEACH SPRINGS, AZ VOR/DME	*MEADS, NV FIX	9000
*9000 - MCA MEADS, NV FIX , SE BND		
MEADS, NV FIX	LAS VEGAS, NV VORTAC	6000

**95.6563 VOR FEDERAL AIRWAY V563**

LUBBOCK, TX VORTAC	BIG SPRING, TX VORTAC	5200
--------------------	-----------------------	------

**95.6564 VOR FEDERAL AIRWAY V564**

YERIN, NV FIX	CHIME, NV FIX	
	NW BND	10000
	SE BND	11500
CHIME, NV FIX	MUSTANG, NV VORTAC	10000

**95.6565 VOR FEDERAL AIRWAY V565**

LLANO, TX VORTAC	AMUSE, TX FIX	3500
AMUSE, TX FIX	CENTEX, TX VORTAC	*3300
*2900 - MOCA		
CENTEX, TX VORTAC	COLLEGE STATION, TX VORTAC	2400
COLLEGE STATION, TX VORTAC	LUFKIN, TX VORTAC	*4000
*2000 - MOCA		

**95.6566 VOR FEDERAL AIRWAY V566**

GREGG COUNTY, TX VORTAC	*WORKS, TX FIX	2300
*3000 - MRA		
WORKS, TX FIX	BELCHER, LA VORTAC	3100
BELCHER, LA VORTAC	KNELT, LA FIX	2300

FROM TO MEA

**95.6566 VOR FEDERAL AIRWAY V566 - CONTINUED**

KNELT, LA FIX *1800 - MOCA	COVEX, LA FIX	*3500
COVEX, LA FIX *1900 - MOCA	NUBOY, LA FIX	*5000
NUBOY, LA FIX	ALEXANDRIA, LA VORTAC W BND	5000
	E BND	2000
ALEXANDRIA, LA VORTAC *1700 - MOCA *ALEXANDRIA R-106 UNUSABLE BEYOND 48 NM	MUSHE, LA FIX	*3000
MUSHE, LA FIX *1700 - MOCA	FISTY, LA FIX	*4000
FISTY, LA FIX	WRACK, LA FIX	UNUSABLE
WRACK, LA FIX *2100 - MOCA	VEILS, LA FIX	*3000
VEILS, LA FIX	RESERVE, LA VOR/DME	2000

**95.6567 VOR FEDERAL AIRWAY V567**

RADOM, AZ FIX	*FERER, AZ FIX N BND	**12000
	S BND	**11000
*12000 - MRA		
*14000 - MCA FERER, AZ FIX , NE BND		
*11000 - MCA FERER, AZ FIX , S BND		
**8400 - MOCA		
**9000 - GNSS MEA		
FERER, AZ FIX *10000 - GNSS MEA	WINSLOW, AZ VORTAC	*14000

**95.6568 VOR FEDERAL AIRWAY V568**

CORPUS CHRISTI, TX VORTAC	THREE RIVERS, TX VORTAC	1800
THREE RIVERS, TX VORTAC	LEMIG, TX FIX	2000
LEMIG, TX FIX	SAN ANTONIO, TX VORTAC	3000
SAN ANTONIO, TX VORTAC *2800 - MOCA	GUADA, TX FIX	*4000
GUADA, TX FIX	STONEWALL, TX VORTAC	4000
STONEWALL, TX VORTAC	LLANO, TX VORTAC	3700
MILLSAP, TX VORTAC	KARYN, TX FIX	3000
KARYN, TX FIX	WICHITA FALLS, TX VORTAC	3100

**95.6569 VOR FEDERAL AIRWAY V569**

BEAUMONT, TX VOR/DME	SILBE, TX FIX	2000
SILBE, TX FIX	LUFKIN, TX VORTAC	2500
LUFKIN, TX VORTAC	FRANKSTON, TX VOR/DME	2300
FRANKSTON, TX VOR/DME	CEDAR CREEK, TX VORTAC	2500

**95.6570 VOR FEDERAL AIRWAY V570**

ALEXANDRIA, LA VORTAC	NATCHEZ, MS VOR/DME	2000
NATCHEZ, MS VOR/DME	MC COMB, MS VORTAC	2000

**95.6571 VOR FEDERAL AIRWAY V571**

HUMBLE, TX VORTAC	NAVASOTA, TX VOR/DME	2000
NAVASOTA, TX VOR/DME	LEONA, TX VORTAC	3000
LEONA, TX VORTAC	CEDAR CREEK, TX VORTAC	2300

FROM	TO	MEA
<b>95.6572 VOR FEDERAL AIRWAY V572</b>		
WINSLOW, AZ VORTAC	*FRISY, AZ FIX	10000
*10500 - MCA FRISY, AZ FIX , W BND		
FRISY, AZ FIX	FLAGSTAFF, AZ VOR/DME	11500
<b>95.6573 VOR FEDERAL AIRWAY V573</b>		
WILL ROGERS, OK VORTAC	*ALEXX, OK FIX	3100
*7000 - MRA		
ALEX, OK FIX	ARDMORE, OK VORTAC	UNUSABLE
ARDMORE, OK VORTAC	BONHAM, TX VORTAC	3600
BONHAM, TX VORTAC	SULPHUR SPRINGS, TX VOR/DME	2500
SULPHUR SPRINGS, TX VOR/DME	TEXARKANA, AR VORTAC	2000
TEXARKANA, AR VORTAC	ELMMO, AR FIX	
	SW BND	*3500
	NE BND	*5500
*2600 - MOCA		
ELMMO, AR FIX	MARKI, AR FIX	*5500
*2600 - MOCA		
MARKI, AR FIX	HOT SPRINGS, AR VOR/DME	
	NE BND	*3500
	SW BND	*5500
*2700 - MOCA		
HOT SPRINGS, AR VOR/DME	LITTLE ROCK, AR VORTAC	3000
<b>95.6574 VOR FEDERAL AIRWAY V574</b>		
CEN, TX VORTAC	MOUZE, TX FIX	2200
MOUZE, TX FIX	NAVASOTA, TX VOR/DME	2100
NAVASOTA, TX VOR/DME	HUMBLE, TX VORTAC	2000
HUMBLE, TX VORTAC	DAISETTA, TX VORTAC	2000
DAISETTA, TX VORTAC	BEAUMONT, TX VOR/DME	2300
BEAUMONT, TX VOR/DME	LAKE CHARLES, LA VORTAC	2000
<b>95.6575 VOR FEDERAL AIRWAY V575</b>		
LARAMIE, WY VOR/DME	*NIWOT, CO FIX	11300
*9500 - MCA NIWOT, CO FIX , NW BND		
NIWOT, CO FIX	MILE HIGH, CO VORTAC	8000
<b>95.6576 VOR FEDERAL AIRWAY V576</b>		
PHILIPSBURG, PA VORTAC	WILLIAMSPORT, PA VOR/DME	4000
WILLIAMSPORT, PA VOR/DME	HANCOCK, NY VOR/DME	4000
HANCOCK, NY VOR/DME	DELANCEY, NY VOR/DME	4000
<b>95.6577 VOR FEDERAL AIRWAY V577</b>		
CEDAR LAKE, NJ VOR/DME	BRIGS, NJ FIX	
	E BND	6000
	W BND	1700
<b>95.6578 VOR FEDERAL AIRWAY V578</b>		
PECAN, GA VOR/DME	TIFT MYERS, GA VOR	*2500
*2300 - MOCA		
TIFT MYERS, GA VOR	ALMA, GA VORTAC	*3000
*2100 - MOCA		
*2100 - GNSS MEA		
*ALMA R-263 UNUSABLE USE TIFT MYERS R-083.		

FROM TO MEA

**95.6578 VOR FEDERAL AIRWAY V578 - CONTINUED**

ALMA, GA VORTAC SAVANNAH, GA VORTAC \*10000  
 \*2600 - MOCA  
 \*3000 - GNSS MEA

**95.6579 VOR FEDERAL AIRWAY V579**

LEE COUNTY, FL VORTAC VIOLA, FL FIX 2000  
 VIOLA, FL FIX SARASOTA, FL VOR/DME \*3000  
 \*1600 - MOCA  
 SARASOTA, FL VOR/DME ST PETERSBURG, FL VORTAC 2000  
 ST PETERSBURG, FL VORTAC BAYPO, FL FIX 2000  
 BAYPO, FL FIX NITTS, FL FIX \*4000  
 \*1500 - MOCA  
 NITTS, FL FIX GATORS, FL VORTAC  
 S BND \*4000  
 N BND \*3000  
 \*2100 - MOCA  
 GATORS, FL VORTAC CROSS CITY, FL VORTAC 2000  
 CROSS CITY, FL VORTAC VALDOSTA, GA VOR/DME 2000  
 VALDOSTA, GA VOR/DME TIFT MYERS, GA VOR 2200  
 TIFT MYERS, GA VOR VIENNA, GA VORTAC 2100

**95.6580 VOR FEDERAL AIRWAY V580**

ST LOUIS, MO VORTAC LEBOY, IL FIX \*3000  
 \*2200 - MOCA  
 LEBOY, IL FIX SEXTN, IL FIX 4500  
 SEXTN, IL FIX BURLINGTON, IA VOR/DME \*3000  
 \*2200 - MOCA

**95.6581 VOR FEDERAL AIRWAY V581**

ST PETERSBURG, FL VORTAC TUMPY, FL FIX 2000  
 TUMPY, FL FIX \*DADES, FL FIX \*\*5000  
 \*5000 - MRA  
 \*\*2000 - GNSS MEA  
 DADES, FL FIX OCALA, FL VORTAC 2000

**95.6582 VOR FEDERAL AIRWAY V582**

ST LOUIS, MO VORTAC LEBOY, IL FIX \*3000  
 \*2200 - MOCA  
 LEBOY, IL FIX QUINCY, IL VORTAC 3000

**95.6583 VOR FEDERAL AIRWAY V583**

CENTEX, TX VORTAC COLLEGE STATION, TX VORTAC 2200  
 COLLEGE STATION, TX VORTAC LEONA, TX VORTAC 2000  
 LEONA, TX VORTAC FRANKSTON, TX VOR/DME 2300

**95.6586 VOR FEDERAL AIRWAY V586**

QUINCY, IL VORTAC PEORIA, IL VORTAC 2500  
 PEORIA, IL VORTAC MAROC, IL FIX \*3000  
 \*2400 - MOCA  
 MAROC, IL FIX PONTIAC, IL VOR/DME 2500  
 PONTIAC, IL VOR/DME JOLIET, IL VOR/DME \*3000  
 \*2300 - MOCA

**95.6587 VOR FEDERAL AIRWAY V587**

HOMELAND, CA VOR \*LUCER, CA FIX 10500  
 \*9300 - MCA LUCER, CA FIX , SW BND

FROM	TO	MEA
------	----	-----

**95.6587 VOR FEDERAL AIRWAY V587 - CONTINUED**

LUCER, CA FIX *8000 - MOCA	BULGY, CA FIX	*9000
BULGY, CA FIX	DAGGETT, CA VORTAC	8000
DAGGETT, CA VORTAC *12000 - MRA	*WHIGG, CA FIX	10500
WHIGG, CA FIX	BOULDER CITY, NV VORTAC	10500

**95.6589 VOR FEDERAL AIRWAY V589**

MEDICINE BOW, WY VOR/DME	ALCOS, WY FIX	10100
ALCOS, WY FIX *9400 - MOCA	MUDDY MOUNTAIN, WY VOR/DME	*10000

**95.6591 VOR FEDERAL AIRWAY V591**

GRAND JUNCTION, CO VOR/DME *13000 - MRA	*PACES, CO FIX	11500
PACES, CO FIX *MTA V591 NE TO V220 NW 12900	*SLOLM, CO FIX	13000
SLOLM, CO FIX *16000 - MRA	*GLENO, CO FIX	14000
GLENO, CO FIX	SNOW, CO VOR/DME	14000
SNOW, CO VOR/DME *12500 - MCA KREMMLING, CO VOR/DME , BND	*KREMMLING, CO VOR/DME	14600

**95.6595 VOR FEDERAL AIRWAY V595**

*ROGUE VALLEY, OR VORTAC	CUTTR, OR FIX NE BND	10500
	SW BND	6100
*5100 - MCA ROGUE VALLEY, OR VORTAC , NE BND		
CUTTR, OR FIX	COPPR, OR FIX	10500
COPPR, OR FIX	DRACK, OR FIX NE BND	9900
	SW BND	10500
DRACK, OR FIX	*DESCHUTES, OR VORTAC NE BND	6200
	SW BND	10500
*7900 - MCA DESCHUTES, OR VORTAC , BND		

**95.6597 VOR FEDERAL AIRWAY V597**

SAN MARCUS, CA VORTAC *9000 - MRA	*OHIGH, CA FIX	8000
OHIGH, CA FIX *6100 - MCA FILLMORE, CA VORTAC , W BND	*FILLMORE, CA VORTAC	8000
FILLMORE, CA VORTAC	VAN NUYS, CA VOR/DME	6000
VAN NUYS, CA VOR/DME	DARTS, CA FIX	5500
DARTS, CA FIX	SEAL BEACH, CA VORTAC NW BND	6000
	SE BND	4000
SEAL BEACH, CA VORTAC	BALBO, CA FIX NW BND	3000
	SE BND	4000
BALBO, CA FIX	OCEANSIDE, CA VORTAC	4000
OCEANSIDE, CA VORTAC	MISSION BAY, CA VORTAC	3000

**95.6599 VOR FEDERAL AIRWAY V599**

LEE COUNTY, FL VORTAC *1500 - MOCA	THNDR, FL FIX	*3000
---------------------------------------	---------------	-------



FROM TO MEA

**95.6599 VOR FEDERAL AIRWAY V599 - CONTINUED**

THNDR, FL FIX DOLPHIN, FL VORTAC \*3000  
 \*1500 - MOCA

**95.6601 VOR FEDERAL AIRWAY V601**

PAHOKEE, FL VOR/DME \*DEEDS, FL FIX \*\*4000  
 \*4000 - MRA  
 \*7000 - MCA DEEDS, FL FIX , S BND  
 \*\*1600 - MOCA  
 \*\*2000 - GNSS MEA  
 DEEDS, FL FIX KEY WEST, FL VORTAC \*7000  
 \*1400 - MOCA  
 \*2000 - GNSS MEA

**95.6605 VOR FEDERAL AIRWAY V605**

SPARTANBURG, SC VORTAC \*GENOD, NC FIX \*\*7000  
 \*10000 - MCA GENOD, NC FIX , N BND  
 \*\*6000 - MOCA  
 \*\*6000 - GNSS MEA  
 \*\*5200 - MCA SPARTANBURG, SC VORTAC , N BND  
 \*\*  
 GENOD, NC FIX \*HOLSTON MOUNTAIN, TN VORTAC \*\*10000  
 \*8500 - MCA HOLSTON MOUNTAIN, TN VORTAC , BND  
 \*\*8500 - MOCA

**95.6607 VOR FEDERAL AIRWAY V607**

MENDOCINO, CA VORTAC YAGER, CA FIX 9000  
 YAGER, CA FIX ARCATA, CA VOR/DME 8000

**95.6609 VOR FEDERAL AIRWAY V609**

SAGINAW, MI VOR/DME BENNY, MI FIX 2400  
 BENNY, MI FIX BANJO, MI FIX \*3000  
 \*2300 - MOCA  
 BANJO, MI FIX \*ZABLE, MI FIX \*\*5000  
 \*5000 - MCA ZABLE, MI FIX , S BND  
 \*\*2900 - MOCA  
 ZABLE, MI FIX \*RONDO, MI FIX 3200  
 \*5000 - MRA  
 RONDO, MI FIX PELLSTON, MI VORTAC \*3200  
 \*2500 - MOCA

**95.6611 VOR FEDERAL AIRWAY V611**

NEWMAN, TX VORTAC \*MOLLY, NM FIX 9000  
 \*10000 - MRA  
 MOLLY, NM FIX TRUTH OR CONSEQUENCES, NM VORTAC 10000  
 TRUTH OR CONSEQUENCES, NM VORTAC SOCORRO, NM VORTAC 9000  
 SOCORRO, NM VORTAC ALBUQUERQUE, NM VORTAC 8000  
 ALBUQUERQUE, NM VORTAC \*SANTA FE, NM VORTAC 9000  
 \*11600 - MCA SANTA FE, NM VORTAC , E BND  
 SANTA FE, NM VORTAC \*FORT UNION, NM VORTAC 12500  
 \*10900 - MCA FORT UNION, NM VORTAC , N BND  
 \*11300 - MCA FORT UNION, NM VORTAC , W BND  
 FORT UNION, NM VORTAC CIMARRON, NM VORTAC \*12000  
 \*11100 - MOCA  
 CIMARRON, NM VORTAC GOSIP, CO FIX \*11000  
 \*10200 - MOCA

FROM TO MEA

**95.6611 VOR FEDERAL AIRWAY V611 - CONTINUED**

GOSIP, CO FIX	PUEBLO, CO VORTAC	8700
PUEBLO, CO VORTAC	*BLACK FOREST, CO VOR/DME	9500
*10000 - MCA BLACK FOREST, CO VOR/DME , NE BND		
BLACK FOREST, CO VOR/DME	LUFSE, CO FIX	*GNSS - 10000
*BLACK FOREST R-028 UNUSABLE		
LUFSE, CO FIX	JEFEL, CO FIX	GNSS - 10500
JEFEL, CO FIX	*LIMEX, CO FIX	GNSS - 8500
*10000 - MRA		
LIMEX, CO FIX	GILL, CO VOR/DME	7900
GILL, CO VOR/DME	CHEYENNE, WY VORTAC	8500
CHEYENNE, WY VORTAC	MOIST, WY FIX	9000
MOIST, WY FIX	DEALT, WY FIX	11500
DEALT, WY FIX	MUDDY MOUNTAIN, WY VOR/DME	
	NW BND	9000
	SE BND	10000
MUDDY MOUNTAIN, WY VOR/DME	CRAZY WOMAN, WY VOR/DME	7600
CRAZY WOMAN, WY VOR/DME	SHERIDAN, WY VOR/DME	9000
SHERIDAN, WY VOR/DME	KRONA, MT FIX	8000
KRONA, MT FIX	BILLINGS, MT VORTAC	
	SE BND	8000
	NW BND	6200
BILLINGS, MT VORTAC	SHELA, MT FIX	
	S BND	*6100
	N BND	*7700
*6000 - MOCA		
SHELA, MT FIX	LEWISTOWN, MT VOR/DME	7700
LEWISTOWN, MT VOR/DME	SHONK, MT FIX	7700
SHONK, MT FIX	HAVRE, MT VOR/DME	6000

**95.6613 VOR FEDERAL AIRWAY V613**

ALLENTOWN, PA VORTAC	WILKES-BARRE, PA VORTAC	4000
----------------------	-------------------------	------

**95.6615 VOR FEDERAL AIRWAY V615**

RALEIGH/DURHAM, NC VORTAC	DUFFI, NC FIX	2600
DUFFI, NC FIX	HOPEWELL, VA VORTAC	*5000
*2500 - MOCA		
*2500 - GNSS MEA		

**95.6623 VOR FEDERAL AIRWAY V623**

SPARTA, NJ VORTAC	CARMEL, NY VOR/DME	3000
-------------------	--------------------	------

**95.6625 VOR FEDERAL AIRWAY V625**

U.S. MEXICAN BORDER	NOGALES, AZ VOR/DME	*10000
*9500 - MOCA		

**95.6626 VOR FEDERAL AIRWAY V626**

YMONT, UT FIX	MYTON, UT VOR/DME	*15000
*12600 - MOCA		
*12600 - GNSS MEA		

**95.6629 VOR FEDERAL AIRWAY V629**

SHUSS, NV FIX	BOULDER CITY, NV VORTAC	7600
---------------	-------------------------	------

FROM

TO

MEA

**§95.6301 ALASKA VOR FEDERAL AIRWAYS****95.6301 ALASKA VOR FEDERAL AIRWAY V301**

FAIRBANKS, AK VORTAC	DIFER, AK FIX	*8000
*7300 - MOCA		
DIFER, AK FIX	FORT YUKON, AK VORTAC	
	SE BND	8000
	NW BND	2300

**95.6302 ALASKA VOR FEDERAL AIRWAY V302**

FAIRBANKS, AK VORTAC	MAYPO, AK FIX	7000
MAYPO, AK FIX	FORT YUKON, AK VORTAC	
	SW BND	7000
	NE BND	2300

**95.6308 ALASKA VOR FEDERAL AIRWAY V308**

BETHEL, AK VORTAC	FISHH, AK FIX	
	E BND	*8000
	W BND	*2000
*1400 - MOCA		
FISHH, AK FIX	SPARREVOHN, AK VOR/DME	*8000
*6000 - MOCA		
*6000 - GNSS MEA		

**95.6309 ALASKA VOR FEDERAL AIRWAY V309**

U.S. CANADIAN BORDER	ANNETTE ISLAND, AK VOR/DME	*5000
*4900 - MOCA		

**95.6311 ALASKA VOR FEDERAL AIRWAY V311**

ANNETTE ISLAND, AK VOR/DME	*TOKEE, AK FIX	6000
*9000 - MCA TOKEE, AK FIX , NW BND		
TOKEE, AK FIX	WIBTA, AK FIX	*9000
*4700 - MOCA		
WIBTA, AK FIX	FLIPS, AK FIX	
	W BND	*7500
	E BND	*9000
*6300 - MOCA		
FLIPS, AK FIX	BIORKA ISLAND, AK VORTAC	
	W BND	6100
	E BND	7500

**95.6317 ALASKA VOR FEDERAL AIRWAY V317**

U.S. CANADIAN BORDER	ANNETTE ISLAND, AK VOR/DME	5000
ANNETTE ISLAND, AK VOR/DME	GESTI, AK FIX	
	SE BND	5000
	NW BND	7000
GESTI, AK FIX	LEVEL ISLAND, AK VOR/DME	*7000
*5300 - MOCA		
LEVEL ISLAND, AK VOR/DME	HOODS, AK FIX	*10000
*6000 - MOCA		
HOODS, AK FIX	SISTERS ISLAND, AK VORTAC	
	SE BND	*10000
	NW BND	*7000
*5500 - MOCA		

FROM TO MEA

**95.6317 ALASKA VOR FEDERAL AIRWAY V317 - CONTINUED**

SISTERS ISLAND, AK VORTAC	CSPER, AK FIX	
	NE BND	*7000
	SW BND	*15000
*5300 - MOCA		
CSPER, AK FIX	*HAPIT, AK FIX	**15000
*15000 - MRA		
**4000 - MOCA		

**95.6318 ALASKA VOR FEDERAL AIRWAY V318**

ANNETTE ISLAND, AK VOR/DME	LEVEL ISLAND, AK VOR/DME	6000
----------------------------	--------------------------	------

**95.6319 ALASKA VOR FEDERAL AIRWAY V319**

YAKUTAT, AK VOR/DME	MALAS, AK FIX	
	E BND	2400
	W BND	10000
MALAS, AK FIX	KATAT, AK FIX	*10000
*5600 - MOCA		
*MEA IS ESTABLISHED WITH A GAP IN NAVIGATION SIGNAL COVERAGE		
KATAT, AK FIX	CASEL, AK FIX	*7000
*3400 - MOCA		
CASEL, AK FIX	*JOHNSTONE POINT, AK VOR/DME	4800
*4800 - MCA JOHNSTONE POINT, AK VOR/DME , E BND		
JOHNSTONE POINT, AK VOR/DME	EDELE, AK FIX	
	E BND	4400
	W BND	10000
EDELE, AK FIX	SNRIS, AK FIX	10000
SNRIS, AK FIX	*ANCHORAGE, AK VOR/DME	
	W BND	8200
	E BND	10000
*8000 - MCA ANCHORAGE, AK VOR/DME , E BND		
ANCHORAGE, AK VOR/DME	YONEK, AK FIX	3000
YONEK, AK FIX	*TORTE, AK FIX	
	W BND	12000
	E BND	7000
*11400 - MCA TORTE, AK FIX , W BND		
TORTE, AK FIX	*VEILL, AK FIX	12000
*8000 - MCA VEILL, AK FIX , E BND		
VEILL, AK FIX	SPARREVOHN, AK VOR/DME	
	E BND	12000
	W BND	6600
SPARREVOHN, AK VOR/DME	ACRAN, AK FIX	
	W BND	*6000
	E BND	*5200
*5200 - MOCA		
ACRAN, AK FIX	VIDDA, AK FIX	6000
VIDDA, AK FIX	WEEKE, AK FIX	
	SW BND	*3000
	NE BND	*6000
*2100 - MOCA		
WEEKE, AK FIX	BETHEL, AK VORTAC	2000
BETHEL, AK VORTAC	ARSEN, AK FIX	2000
ARSEN, AK FIX	FANCI, AK FIX	*4000
*2000 - MOCA		
*2000 - GNSS MEA		
FANCI, AK FIX	HOOPER BAY, AK VOR/DME	2000

**95.6320 ALASKA VOR FEDERAL AIRWAY V320**

MC GRATH, AK VORTAC	ERLAN, AK FIX	
	E BND	10000
	W BND	5000

FROM TO MEA

**95.6320 ALASKA VOR FEDERAL AIRWAY V320 - CONTINUED**

ERLAN, AK FIX	WINOR, AK FIX	
	E BND	10000
	W BND	8000
WINOR, AK FIX	*FRIDA, AK FIX	**10000
*9500 - MRA		
*7600 - MCA FRIDA, AK FIX , W BND		
**MEA IS ESTABLISHED WITH A GAP IN NAVIGATION SIGNAL COVERAGE		
FRIDA, AK FIX	RUNTL, AK FIX	8500
RUNTL, AK FIX	KAYTI, AK FIX	6400
KAYTI, AK FIX	*ANCHORAGE, AK VOR/DME	3700
*6000 - MCA ANCHORAGE, AK VOR/DME , SE BND		
ANCHORAGE, AK VOR/DME	HOPER, AK FIX	
	SE BND	10000
	NW BND	6500
HOPER, AK FIX	NELLI, AK FIX	10000
NELLI, AK FIX	KEBAB, AK FIX	
	NW BND	10000
	SE BND	5000
KEBAB, AK FIX	JOHNSTONE POINT, AK VOR/DME	5000

**95.6321 ALASKA VOR FEDERAL AIRWAY V321**

CAPE NEWENHAM, AK NDB/DME	KING SALMON, AK VORTAC	*5000
*4300 - MOCA		
KING SALMON, AK VORTAC	BATTY, AK FIX	
	NE BND	7000
	SW BND	6000
BATTY, AK FIX	AUGEY, AK FIX	7000
AUGEY, AK FIX	HOMER, AK VOR/DME	*4000
*3000 - MOCA		

**95.6322 ALASKA VOR FEDERAL AIRWAY V322**

KING SALMON, AK VORTAC	KONIC, AK FIX	
	W BND	5000
	E BND	9000
KONIC, AK FIX	WORRI, AK FIX	*9000
*7700 - MOCA		
*7700 - GNSS MEA		
WORRI, AK FIX	MALLT, AK FIX	*9000
*8500 - MOCA		
MALLT, AK FIX	HOMER, AK VOR/DME	
	SW BND	9000
	NE BND	4000

**95.6333 ALASKA VOR FEDERAL AIRWAY V333**

HOOPER BAY, AK VOR/DME	HALEM, AK FIX	4500
HALEM, AK FIX	FAIRE, AK FIX	*8000
*2300 - MOCA		
FAIRE, AK FIX	NOME, AK VOR/DME	3000
NOME, AK VOR/DME	GAITS, AK FIX	
	N BND	10000
	S BND	4000
GAITS, AK FIX	SHISHMAREF, AK NDB	*10000
*6700 - MOCA		

**95.6334 ALASKA VOR FEDERAL AIRWAY V334**

AUGEY, AK FIX	CLAMS, AK FIX	*7000
*2000 - MOCA		
*2000 - GNSS MEA		

FROM	TO	MEA
------	----	-----

**95.6334 ALASKA VOR FEDERAL AIRWAY V334 - CONTINUED**

CLAMS, AK FIX	KENAI, AK VOR/DME	2000
KENAI, AK VOR/DME	ANCHORAGE, AK VOR/DME	2000

**95.6350 ALASKA VOR FEDERAL AIRWAY V350**

DILLINGHAM, AK VOR/DME	TOGIAC, AK NDB/DME	5000
TOGIAC, AK NDB/DME	BAFIN, AK FIX	5400
BAFIN, AK FIX	BETHEL, AK VORTAC	
	SE BND	5400
	NW BND	2000
BETHEL, AK VORTAC	DAHLS, AK FIX	
	W BND	3600
	E BND	2000
DAHLS, AK FIX	EMMONAK, AK VOR/DME	*3600
*3000 - MOCA		
*3000 - GNSS MEA		
EMMONAK, AK VOR/DME	NOME, AK VOR/DME	3000

**95.6351 ALASKA VOR FEDERAL AIRWAY V351**

DILLINGHAM, AK VOR/DME	PORT HEIDEN, AK NDB/DME	3000
------------------------	-------------------------	------

**95.6357 ALASKA VOR FEDERAL AIRWAY V357**

KODIAK, AK VOR/DME	INNOL, AK FIX	3500
INNOL, AK FIX	MOCHO, AK FIX	*4000
*3000 - MOCA		
MOCHO, AK FIX	GERKS, AK FIX	*7500
*2300 - MOCA		
*7000 - GNSS MEA		
GERKS, AK FIX	SANER, AK FIX	*9000
*3700 - MOCA		
*7000 - GNSS MEA		
SANER, AK FIX	HOMER, AK VOR/DME	
	N BND	6000
	S BND	9000

**95.6385 ALASKA VOR FEDERAL AIRWAY V385**

HOOPER BAY, AK VOR/DME	EMMONAK, AK VOR/DME	4500
EMMONAK, AK VOR/DME	UNALAKLEET, AK VOR/DME	*3500
*2800 - MOCA		
*3000 - GNSS MEA		

**95.6388 ALASKA VOR FEDERAL AIRWAY V388**

ANCHORAGE, AK VOR/DME	NAPTO, AK FIX	2300
NAPTO, AK FIX	KENAI, AK VOR/DME	2400

**95.6401 ALASKA VOR FEDERAL AIRWAY V401**

AMBLER, AK NDB	FARME, AK FIX	*5500
*4700 - MOCA		
FARME, AK FIX	KOTZEBUE, AK VOR/DME	2000
KOTZEBUE, AK VOR/DME	SHISHMAREF, AK NDB	*2500
*2000 - MOCA		

**95.6414 ALASKA VOR FEDERAL AIRWAY V414**

GAMBELL, AK NDB/DME	KUKULIAK, AK VOR/DME	3000
---------------------	----------------------	------

FROM TO MEA

**95.6427 ALASKA VOR FEDERAL AIRWAY V427**

*KING SALMON, AK VORTAC	TOMMY, AK FIX	
	SW BND	**3000
	NE BND	**16000
*7200 - MCA KING SALMON, AK VORTAC , NE BND		
**3000 - GNSS MEA		
TOMMY, AK FIX	NUTUW, AK FIX	
	SW BND	*7000
	NE BND	*16000
*5300 - MOCA		
*6000 - GNSS MEA		
NUTUW, AK FIX	RINGO, AK FIX	
	SW BND	*9000
	NE BND	*16000
*5300 - MOCA		
*6000 - GNSS MEA		
RINGO, AK FIX	*NONDA, AK FIX	**16000
*16000 - MCA NONDA, AK FIX , BND		
**9000 - MOCA		
**9000 - GNSS MEA		

**95.6428 ALASKA VOR FEDERAL AIRWAY V428**

BIORKA ISLAND, AK VORTAC	SISTERS ISLAND, AK VORTAC	*7000
*6000 - MOCA		
*6000 - GNSS MEA		
SISTERS ISLAND, AK VORTAC	HAINES, AK NDB	*10000
*8500 - MOCA		
*8500 - GNSS MEA		
*MEA IS ESTABLISHED WITH A GAP IN NAVIGATION SIGNAL COVERAGE		
HAINES, AK NDB	U.S. CANADIAN BORDER	*10000
*9600 - MOCA		

**95.6435 ALASKA VOR FEDERAL AIRWAY V435**

HOMER, AK VOR/DME	KASSI, AK FIX	4400
KASSI, AK FIX	KENAI, AK VOR/DME	
	S BND	*4400
	N BND	*2000
*1700 - MOCA		
*2000 - GNSS MEA		

**95.6436 ALASKA VOR FEDERAL AIRWAY V436**

ANCHORAGE, AK VOR/DME	TAGER, AK FIX	2200
TAGER, AK FIX	*TALKEETNA, AK VOR/DME	3000
*3800 - MCA TALKEETNA, AK VOR/DME , N BND		
TALKEETNA, AK VOR/DME	*EGRAM, AK FIX	6000
*7000 - MCA EGRAM, AK FIX , N BND		
EGRAM, AK FIX	*AILEE, AK FIX	10000
*9000 - MCA AILEE, AK FIX , S BND		
AILEE, AK FIX	*DATAY, AK FIX	
	N BND	8400
	S BND	10000
*7500 - MCA DATAY, AK FIX , S BND		
DATAY, AK FIX	*ENTTA, AK FIX	
	N BND	6400
	S BND	8400
*5100 - MCA ENTTA, AK FIX , S BND		

FROM TO MEA

**95.6436 ALASKA VOR FEDERAL AIRWAY V436 - CONTINUED**

ENTTA, AK FIX FAIRBANKS, AK VORTAC 3400

**95.6438 ALASKA VOR FEDERAL AIRWAY V438**

KODIAK, AK VOR/DME SHUYA, AK FIX 4000  
 SHUYA, AK FIX HOMER, AK VOR/DME \*6000

\*5900 - MOCA

HOMER, AK VOR/DME SKILA, AK FIX 5000

SKILA, AK FIX NAPTO, AK FIX 2400

NAPTO, AK FIX ANCHORAGE, AK VOR/DME 2300

ANCHORAGE, AK VOR/DME \*BIG LAKE, AK VORTAC 2000

\*2600 - MCA BIG LAKE, AK VORTAC , N BND

BIG LAKE, AK VORTAC \*SURES, AK FIX 7500

\*10000 - MRA

SURES, AK FIX LIBER, AK FIX \*11000

\*8900 - MOCA

\*MEA IS ESTABLISHED WITH A GAP IN NAVIGATION SIGNAL COVERAGE

LIBER, AK FIX \*GLOWS, AK FIX 7500

\*4800 - MCA GLOWS, AK FIX , S BND

GLOWS, AK FIX FAIRBANKS, AK VORTAC 3400

FAIRBANKS, AK VORTAC CHATA, AK FIX

N BND \*8000

S BND \*7000

\*5000 - MOCA

CHATA, AK FIX BURMA, AK FIX \*8000

\*7200 - MOCA

BURMA, AK FIX BIJOU, AK FIX 5000

BIJOU, AK FIX FORT YUKON, AK VORTAC 2300

FORT YUKON, AK VORTAC \*UVALL, AK FIX 10000

\*10000 - MCA UVALL, AK FIX , SE BND

UVALL, AK FIX DEADHORSE, AK VOR/DME

NW BND 2300

SE BND 10000

DEADHORSE, AK VOR/DME OOSIK, AK FIX

W BND \*6000

E BND \*2000

\*1300 - MOCA

OOSIK, AK FIX TUNDA, AK FIX \*6000

\*1300 - MOCA

TUNDA, AK FIX BARROW, AK VOR/DME

E BND \*6000

W BND \*3000

\*1500 - MOCA

**95.6439 ALASKA VOR FEDERAL AIRWAY V439**

KODIAK, AK VOR/DME BAREL, AK FIX \*6000

\*4300 - MOCA

BAREL, AK FIX HOMER, AK VOR/DME \*6000

\*5300 - MOCA

**95.6440 ALASKA VOR FEDERAL AIRWAY V440**

NOME, AK VOR/DME \*GOLOS, AK FIX 3000

\*4500 - MRA

GOLOS, AK FIX UNALAKLEET, AK VOR/DME 3000

UNALAKLEET, AK VOR/DME YUCON, AK FIX

W BND 4600

E BND 8000



FROM TO MEA

**95.6440 ALASKA VOR FEDERAL AIRWAY V440 - CONTINUED**

YUCON, AK FIX *5600 - MOCA *7000 - GNSS MEA	GANES, AK FIX	*8000
GANES, AK FIX	MC GRATH, AK VORTAC E BND W BND	6000 8000
MC GRATH, AK VORTAC	ERLAN, AK FIX E BND W BND	10000 5000
ERLAN, AK FIX	WINOR, AK FIX E BND W BND	10000 8000
WINOR, AK FIX *9500 - MRA *7600 - MCA FRIDA, AK FIX , W BND **MEA IS ESTABLISHED WITH A GAP IN NAVIGATION SIGNAL COVERAGE	*FRIDA, AK FIX	**10000
FRIDA, AK FIX *5900 - MCA IVANN, AK FIX , W BND	*IVANN, AK FIX	6600
IVANN, AK FIX *6000 - MCA ANCHORAGE, AK VOR/DME , SE BND	*ANCHORAGE, AK VOR/DME	2200
ANCHORAGE, AK VOR/DME	HOPER, AK FIX SE BND NW BND	10000 6500
HOPER, AK FIX MODDS, AK FIX	MODDS, AK FIX MIDDLETON ISLAND, AK VOR/DME SE BND NW BND	10000 6000 10000
MIDDLETON ISLAND, AK VOR/DME *2000 - MOCA *7000 - GNSS MEA	OCULT, AK FIX	*8000
OCULT, AK FIX YAKUTAT, AK VOR/DME	YAKUTAT, AK VOR/DME CENTA, AK FIX SE BND NW BND	2000 9000 2000
CENTA, AK FIX *2000 - MOCA *MEA IS ESTABLISHED WITH A GAP IN NAVIGATION SIGNAL COVERAGE	SALIS, AK FIX	*9000
SALIS, AK FIX	BIORKA ISLAND, AK VORTAC NW BND SE BND	9000 5100
BIORKA ISLAND, AK VORTAC	LATCH, AK FIX NW BND SE BND	4500 12000
LATCH, AK FIX *4200 - MOCA *8000 - GNSS MEA	U.S. CANADIAN BORDER	*12000

**95.6441 ALASKA VOR FEDERAL AIRWAY V441**

MIDDLETON ISLAND, AK VOR/DME DEALS, AK FIX *10000 - MRA **8400 - MOCA	DEALS, AK FIX *SEWAR, AK FIX	6000 **9000
SEWAR, AK FIX *7700 - MOCA *7700 - GNSS MEA	BROIL, AK FIX	*10000
BROIL, AK FIX *5600 - MCA HATUL, AK FIX , SE BND	*HATUL, AK FIX	7100
HATUL, AK FIX *4200 - MCA ANCHORAGE, AK VOR/DME , BND	*ANCHORAGE, AK VOR/DME	4600

FROM TO MEA

**95.6444 ALASKA VOR FEDERAL AIRWAY V444**

BARROW, AK VOR/DME *1200 - MOCA	CHIPS, AK FIX	*2000
CHIPS, AK FIX *1200 - MOCA	BRONX, AK FIX	*5000
BRONX, AK FIX *9100 - MOCA	EVANSVILLE, AK NDB	*10000
EVANSVILLE, AK NDB	BETTLES, AK VOR/DME	3500
BETTLES, AK VOR/DME *4400 - MCA CYCLE, AK FIX , SE BND	*CYCLE, AK FIX	3500
CYCLE, AK FIX *5200 - MOCA	BRION, AK FIX	*6000
BRION, AK FIX *5200 - MOCA	LIVEN, AK FIX	*9000
LIVEN, AK FIX *4400 - MOCA	HESSE, AK FIX	*5000
HESSE, AK FIX *4900 - MOCA	FAIRBANKS, AK VORTAC	*5000
FAIRBANKS, AK VORTAC *4200 - MOCA	BIG DELTA, AK VORTAC	*5000
BIG DELTA, AK VORTAC *7800 - MOCA	NORTHWAY, AK VORTAC	*8000
NORTHWAY, AK VORTAC *5800 - MOCA	U.S. CANADIAN BORDER	*8400

**95.6445 ALASKA VOR FEDERAL AIRWAY V445**

*FAIRBANKS, AK VORTAC *4000 - MCA FAIRBANKS, AK VORTAC , W BND	WILTS, AK FIX	5000
WILTS, AK FIX *4200 - MOCA	TOLLO, AK FIX	*5000
TOLLO, AK FIX	KANUT, AK FIX	7000
KANUT, AK FIX	BETTLES, AK VOR/DME SE BND	7000
	NW BND	3500

**95.6447 ALASKA VOR FEDERAL AIRWAY V447**

FAIRBANKS, AK VORTAC *7000 - MRA **4400 - MOCA	*DOMEY, AK FIX	**5000
DOMEY, AK FIX	TATTA, AK FIX NW BND	*11000
*5400 - MOCA	SE BND	*7000
TATTA, AK FIX *8000 - MOCA	CHANDALAR LAKE, AK NDB	*11000
*MEA IS ESTABLISHED WITH A GAP IN NAVIGATION SIGNAL COVERAGE		

**95.6452 ALASKA VOR FEDERAL AIRWAY V452**

KUKULIAK, AK VOR/DME	NOME, AK VOR/DME	3000
NOME, AK VOR/DME *4200 - MOCA	MOSES POINT, AK VOR/DME	*5000
MOSES POINT, AK VOR/DME *6000 - MRA **5200 - MOCA	*DIBVY, AK FIX	**6000
DIBVY, AK FIX	GALENA, AK VOR/DME	3000
GALENA, AK VOR/DME	HORSI, AK FIX E BND	*8000
	W BND	*4000
*4000 - GNSS MEA		

FROM TO MEA

**95.6452 ALASKA VOR FEDERAL AIRWAY V452 - CONTINUED**

HORSI, AK FIX	BONET, AK FIX	*8000
*4000 - MOCA		
*4000 - GNSS MEA		
BONET, AK FIX	NENANA, AK VORTAC	*7000
*4400 - MOCA		
*4400 - GNSS MEA		

**95.6453 ALASKA VOR FEDERAL AIRWAY V453**

KING SALMON, AK VORTAC	*DILLINGHAM, AK VOR/DME	2100
*2500 - MCA DILLINGHAM, AK VOR/DME , NW BND		
DILLINGHAM, AK VOR/DME	ALTEY, AK FIX	
	SE BND	*7000
	NW BND	*8000
*6500 - MOCA		
*3600 - GNSS MEA		
ALTEY, AK FIX	*EDUCE, AK FIX	**8000
*3600 - MCA EDUCE, AK FIX , SE BND		
**6500 - MOCA		
EDUCE, AK FIX	BETHEL, AK VORTAC	
	NW BND	*4000
	SE BND	*8000
*2500 - MOCA		
*3000 - GNSS MEA		
BETHEL, AK VORTAC	WAPRO, AK FIX	*9000
*4300 - MOCA		
WAPRO, AK FIX	UNALAKLEET, AK VOR/DME	*11000
*5100 - MOCA		

**95.6454 ALASKA VOR FEDERAL AIRWAY V454**

KING SALMON, AK VORTAC	DILLINGHAM, AK VOR/DME	*5000
*4300 - MOCA		

**95.6456 ALASKA VOR FEDERAL AIRWAY V456**

COLD BAY, AK VORTAC	BINAL, AK FIX	
	SW BND	*4000
	NE BND	*14000
*3400 - MOCA		
BINAL, AK FIX	TANIE, AK FIX	*14000
*3400 - MOCA		
*MEA IS ESTABLISHED WITH A GAP IN NAVIGATION SIGNAL COVERAGE		
TANIE, AK FIX	*KING SALMON, AK VORTAC	**3000
*5400 - MCA KING SALMON, AK VORTAC , NW BND		
**1600 - MOCA		
**MEA 14000 SW WHEN DLG FSS SHUT DOWN		
KING SALMON, AK VORTAC	STREW, AK FIX	
	SW BND	*3000
	NE BND	*11000
*2300 - MOCA		
STREW, AK FIX	BITOP, AK FIX	
	SW BND	*5000
	NE BND	*11000
*5000 - MOCA		
*6000 - GNSS MEA		
BITOP, AK FIX	*NOSKY, AK FIX	**11000
*15000 - MCA NOSKY, AK FIX , NE BND		
**5900 - MOCA		
**6000 - GNSS MEA		

FROM TO MEA

**95.6456 ALASKA VOR FEDERAL AIRWAY V456 - CONTINUED**

NOSKY, AK FIX	*TUCKS, AK FIX	**15000
*10300 - MCA TUCKS, AK FIX , SW BND		
**12300 - MOCA		
**13000 - GNSS MEA		
TUCKS, AK FIX	KENAI, AK VOR/DME	*5000
*3300 - MOCA		
KENAI, AK VOR/DME	ANCHORAGE, AK VOR/DME	2000
ANCHORAGE, AK VOR/DME	*BIG LAKE, AK VORTAC	2000
*5000 - MCA BIG LAKE, AK VORTAC , NE BND		
BIG LAKE, AK VORTAC	MATTA, AK FIX	7000
MATTA, AK FIX	*UREKA, AK FIX	**10000
*7200 - MCA UREKA, AK FIX , SW BND		
**9400 - MOCA		
UREKA, AK FIX	SMOKY, AK FIX	
	NE BND	*7000
	SW BND	*10000
*6300 - MOCA		
*7000 - GNSS MEA		
SMOKY, AK FIX	GULKANA, AK VOR/DME	
	NE BND	*5000
	SW BND	*10000
*5000 - GNSS MEA		
GULKANA, AK VOR/DME	*SANKA, AK FIX	
	NE BND	11000
	SW BND	6000
*8000 - MCA SANKA, AK FIX , NE BND		
SANKA, AK FIX	NORTHWAY, AK VORTAC	*11000
*10500 - MOCA		

**95.6457 ALASKA VOR FEDERAL AIRWAY V457**

ILIAMNA, AK NDB/DME	*AWOMY, AK FIX	
	W BND	5700
	E BND	9000
*7000 - MCA AWOMY, AK FIX , E BND		
AWOMY, AK FIX	*MOFOF, AK FIX	9000
*7000 - MCA MOFOF, AK FIX , W BND		
MOFOF, AK FIX	KENAI, AK VOR/DME	
	W BND	9000
	E BND	3000

**95.6459 ALASKA VOR FEDERAL AIRWAY V459**

EMMONAK, AK VOR/DME	ST MARYS, AK NDB	3000
---------------------	------------------	------

**95.6462 ALASKA VOR FEDERAL AIRWAY V462**

CAPE NEWENHAM, AK NDB/DME	DILLINGHAM, AK VOR/DME	*5000
*4300 - MOCA		
DILLINGHAM, AK VOR/DME	KOWOK, AK FIX	*3000
*2500 - MOCA		
KOWOK, AK FIX	SAHOK, AK FIX	*5000
*3800 - MOCA		
SAHOK, AK FIX	NONDA, AK FIX	*14000
*8800 - MOCA		
*MEA IS ESTABLISHED WITH A GAP IN NAVIGATION SIGNAL COVERAGE		
NONDA, AK FIX	*BLUGA, AK FIX	**14000
*10000 - MCA BLUGA, AK FIX , SW BND		
**12400 - MOCA		

FROM TO MEA

**95.6462 ALASKA VOR FEDERAL AIRWAY V462 - CONTINUED**

BLUGA, AK FIX	*AMOTT, AK FIX	7000
*7400 - MCA AMOTT, AK FIX , SW BND		
AMOTT, AK FIX	ANCHORAGE, AK VOR/DME	4000

**95.6473 ALASKA VOR FEDERAL AIRWAY V473**

LEVEL ISLAND, AK VOR/DME	*FLIPS, AK FIX	**9000
*9000 - MCA FLIPS, AK FIX , E BND		
**6300 - MOCA		
FLIPS, AK FIX	BIORKA ISLAND, AK VORTAC	
	W BND	6100
	E BND	7500

**95.6477 ALASKA VOR FEDERAL AIRWAY V477**

GALENA, AK VOR/DME	HUSLIA, AK VOR/DME	3000
HUSLIA, AK VOR/DME	ATAGO, AK FIX	
	W BND	*4000
	E BND	*3500
*2500 - MOCA		
ATAGO, AK FIX	DESOY, AK FIX	4000
DESOY, AK FIX	SELAWIK, AK VOR/DME	
	W BND	2500
	E BND	4000
SELAWIK, AK VOR/DME	JELLE, AK FIX	3500
JELLE, AK FIX	AMBLER, AK NDB	
	NE BND	5000
	SW BND	4000

**95.6480 ALASKA VOR FEDERAL AIRWAY V480**

MOUNT MOFFETT, AK NDB/DME	ST PAUL ISLAND, AK NDB/DME	6000
ST PAUL ISLAND, AK NDB/DME	ZESKA, AK FIX	*10000
*1800 - MOCA		
ZESKA, AK FIX	BETHEL, AK VORTAC	
	NE BND	*2000
	SW BND	*10000
*1500 - MOCA		
BETHEL, AK VORTAC	CABOT, AK FIX	
	NE BND	*8000
	SW BND	*2000
*1400 - MOCA		
CABOT, AK FIX	ANIAK, AK FIX	
	NE BND	*9000
	SW BND	*8000
*2400 - MOCA		
ANIAK, AK FIX	JOANY, AK FIX	*9000
*5600 - MOCA		
*MEA IS ESTABLISHED WITH A GAP IN NAVIGATION SIGNAL COVERAGE		
JOANY, AK FIX	MC GRATH, AK VORTAC	
	NE BND	*6000
	SW BND	*9000
*4700 - MOCA		
MC GRATH, AK VORTAC	MEFRA, AK FIX	
	W BND	4000
	E BND	8000
MEFRA, AK FIX	NENANA, AK VORTAC	*8000
*5000 - MOCA		
NENANA, AK VORTAC	FAIRBANKS, AK VORTAC	*4000
*3000 - MOCA		

FROM TO MEA

**95.6481 ALASKA VOR FEDERAL AIRWAY V481**

*JOHNSTONE POINT, AK VOR/DME	FIDAL, AK FIX	14000
*14000 - MCA JOHNSTONE POINT, AK VOR/DME , N BND		
FIDAL, AK FIX	ROBES, AK FIX	14000
ROBES, AK FIX	*KLUNG, AK FIX	14000
*11200 - MCA KLUNG, AK FIX , S BND		
KLUNG, AK FIX	GULKANA, AK VOR/DME	
	S BND	10000
	N BND	7000
GULKANA, AK VOR/DME	DOZEY, AK FIX	
	N BND	12000
	S BND	4000
DOZEY, AK FIX	PAXON, AK FIX	
	S BND	7000
	N BND	12000
PAXON, AK FIX	*DONEL, AK FIX	**12000
*10500 - MCA DONEL, AK FIX , S BND		
**11500 - MOCA		
DONEL, AK FIX	*BIG DELTA, AK VORTAC	
	N BND	7000
	S BND	12000
*7800 - MCA BIG DELTA, AK VORTAC , S BND		
BIG DELTA, AK VORTAC	FORT YUKON, AK VORTAC	*7000
*MEA IS ESTABLISHED WITH A GAP IN NAVIGATION SIGNAL COVERAGE		

**95.6488 ALASKA VOR FEDERAL AIRWAY V488**

HOOPER BAY, AK VOR/DME	AKELT, AK FIX	
	NE BND	10000
	SW BND	4000
AKELT, AK FIX	ALMOT, AK FIX	*10000
*4000 - MOCA		
ALMOT, AK FIX	UNALAKLEET, AK VOR/DME	
	SW BND	10000
	NE BND	3000
UNALAKLEET, AK VOR/DME	EDMON, AK FIX	
	NE BND	*5500
	SW BND	*4000
*4000 - MOCA		
EDMON, AK FIX	VENCE, AK FIX	*5500
*4900 - MOCA		
VENCE, AK FIX	GALENA, AK VOR/DME	
	SW BND	*5500
	NE BND	*3000
*2500 - MOCA		
GALENA, AK VOR/DME	KUHZE, AK FIX	*5000
*4400 - MOCA		
KUHZE, AK FIX	CHOKK, AK FIX	6000
CHOKK, AK FIX	TANANA, AK VOR/DME	
	SW BND	6000
	NE BND	3000
TANANA, AK VOR/DME	*REEBA, AK FIX	
	E BND	**7000
	W BND	**4000
*7000 - MRA		
**4000 - MOCA		
REEBA, AK FIX	GOLLY, AK FIX	*7000
*5000 - MOCA		
GOLLY, AK FIX	*FAIRBANKS, AK VORTAC	5000
*4700 - MCA FAIRBANKS, AK VORTAC , BND		

FROM	TO	MEA
<b>95.6489 ALASKA VOR FEDERAL AIRWAY V489</b>		
GALENA, AK VOR/DME	HORSI, AK FIX	
	E BND	*8000
	W BND	*4000
*4000 - GNSS MEA		
HORSI, AK FIX	ROSII, AK FIX	
	NE BND	*6000
	SW BND	*8000
*4000 - MOCA		
ROSII, AK FIX	TANANA, AK VOR/DME	
	NE BND	3400
	SW BND	6000
<b>95.6491 ALASKA VOR FEDERAL AIRWAY V491</b>		
BIG LAKE, AK VORTAC	TALKEETNA, AK VOR/DME	3000
<b>95.6496 ALASKA VOR FEDERAL AIRWAY V496</b>		
HOOPER BAY, AK VOR/DME	ST MARYS, AK NDB	3500
<b>95.6498 ALASKA VOR FEDERAL AIRWAY V498</b>		
MC GRATH, AK VORTAC	NIXON, AK FIX	
	NW BND	*6000
	SE BND	*4500
*4500 - MOCA		
NIXON, AK FIX	AHVUH, AK FIX	*6000
*5500 - MOCA		
AHVUH, AK FIX	*KATEL, AK FIX	
	SE BND	**6000
	NW BND	**4000
*8000 - MRA		
**4000 - MOCA		
KATEL, AK FIX	BALIN, AK FIX	*8000
*5300 - MOCA		
BALIN, AK FIX	KOTZEBUE, AK VOR/DME	
	SE BND	*8000
	NW BND	*2000
*2000 - MOCA		
<b>95.6504 ALASKA VOR FEDERAL AIRWAY V504</b>		
NENANA, AK VORTAC	KANUT, AK FIX	7000
KANUT, AK FIX	BETTLES, AK VOR/DME	
	NW BND	3500
	SE BND	7000
BETTLES, AK VOR/DME	EVANSVILLE, AK NDB	3500
EVANSVILLE, AK NDB	DERIK, AK FIX	*10000
*9500 - MOCA		
DERIK, AK FIX	MUKTU, AK FIX	
	S BND	*10000
	N BND	*7000
*3800 - MOCA		
MUKTU, AK FIX	SHELO, AK FIX	
	S BND	*10000
	N BND	*5000
*3000 - MOCA		
SHELO, AK FIX	DEADHORSE, AK VOR/DME	
	S BND	10000
	N BND	2000

FROM	TO	MEA
<b>95.6506 ALASKA VOR FEDERAL AIRWAY V506</b>		
CJAYY, AK FIX	KODIAK, AK VOR/DME	4000
KODIAK, AK VOR/DME	BREMI, AK FIX	*12000
*9900 - MOCA		
*10000 - GNSS MEA		
BREMI, AK FIX	KING SALMON, AK VORTAC	
	E BND	12000
	W BND	5000
KING SALMON, AK VORTAC	KOWOK, AK FIX	*3000
*2400 - MOCA		
KOWOK, AK FIX	CAYON, AK FIX	*8000
*7000 - MOCA		
*7000 - GNSS MEA		
CAYON, AK FIX	BETHEL, AK VORTAC	
	E BND	8000
	W BND	4000
BETHEL, AK VORTAC	MARSI, AK FIX	
	W BND	16000
	E BND	2000
MARSI, AK FIX	JOHNI, AK FIX	*16000
*3200 - MOCA		
*4000 - GNSS MEA		
*MEA IS ESTABLISHED WITH A GAP IN NAVIGATION SIGNAL COVERAGE		
JOHNI, AK FIX	DACIA, AK FIX	*8000
*3200 - MOCA		
*4000 - GNSS MEA		
DACIA, AK FIX	NOME, AK VOR/DME	
	S BND	*8000
	N BND	*4000
*3200 - MOCA		
NOME, AK VOR/DME	BAIME, AK FIX	
	N BND	7000
	S BND	6000
BAIME, AK FIX	SETUP, AK FIX	*7000
*5700 - MOCA		
*6000 - GNSS MEA		
SETUP, AK FIX	KOTZEBUE, AK VOR/DME	
	S BND	7000
	N BND	2000
KOTZEBUE, AK VOR/DME	HOTHAM, AK NDB	2000
HOTHAM, AK NDB	SHOKK, AK FIX	*6000
*5000 - MOCA		
*5000 - GNSS MEA		
SHOKK, AK FIX	MEADE, AK FIX	*10000
*7000 - MOCA		
*8000 - GNSS MEA		
MEADE, AK FIX	BARROW, AK VOR/DME	
	S BND	*10000
	N BND	*2000
*1100 - MOCA		

**95.6507 ALASKA VOR FEDERAL AIRWAY V507**

NOME, AK VOR/DME	PHOTO, AK FIX	
	NW BND	*13000
	SE BND	*6000
*5700 - MOCA		
PHOTO, AK FIX	ESKAR, AK FIX	*13000
*6000 - MOCA		
*6000 - GNSS MEA		



FROM TO MEA

**95.6507 ALASKA VOR FEDERAL AIRWAY V507 - CONTINUED**

ESKAR, AK FIX	KOTZEBUE, AK VOR/DME	
	SW BND	*13000
	NE BND	*2100
*2100 - MOCA		

**95.6508 ALASKA VOR FEDERAL AIRWAY V508**

MIDDLETON ISLAND, AK VOR/DME	DEALS, AK FIX	6000
DEALS, AK FIX	*SEWAR, AK FIX	**9000
*10000 - MRA		
**8400 - MOCA		
SEWAR, AK FIX	*SKILA, AK FIX	**9000
*5100 - MCA SKILA, AK FIX , E BND		
**7800 - MOCA		
**8000 - GNSS MEA		
SKILA, AK FIX	ROJAR, AK FIX	2400
ROJAR, AK FIX	KENAI, AK VOR/DME	2000
KENAI, AK VOR/DME	*NEARR, AK FIX	**3000
*7600 - MCA NEARR, AK FIX , W BND		
**2500 - MOCA		
NEARR, AK FIX	AKGAS, AK FIX	12000
AKGAS, AK FIX	SPARREVOHN, AK VOR/DME	
	W BND	6000
	E BND	12000
SPARREVOHN, AK VOR/DME	ANIAK, AK NDB	6000

**95.6510 ALASKA VOR FEDERAL AIRWAY V510**

EMMONAK, AK VOR/DME	ANVIK, AK NDB	3900
ANVIK, AK NDB	SABOC, AK FIX	
	E BND	*10000
	W BND	*9000
*6200 - MOCA		
*7000 - GNSS MEA		
SABOC, AK FIX	MC GRATH, AK VORTAC	*10000
*6200 - MOCA		
*7000 - GNSS MEA		
MC GRATH, AK VORTAC	ERLAN, AK FIX	
	E BND	10000
	W BND	5000
ERLAN, AK FIX	WINOR, AK FIX	
	E BND	10000
	W BND	8000
WINOR, AK FIX	FFITZ, AK FIX	10000
FFITZ, AK FIX	ROHHN, AK FIX	*10000
*8800 - MOCA		
*9000 - GNSS MEA		
ROHHN, AK FIX	BIG LAKE, AK VORTAC	*4000
*3400 - MOCA		

**95.6515 ALASKA VOR FEDERAL AIRWAY V515**

MERIE, AK FIX	*BIG DELTA, AK VORTAC	12000
*8100 - MCA BIG DELTA, AK VORTAC , BND		

**95.6531 ALASKA VOR FEDERAL AIRWAY V531**

*FAIRBANKS, AK VORTAC	GOLLY, AK FIX	5000
*4700 - MCA FAIRBANKS, AK VORTAC , W BND		

FROM	TO	MEA
<b>95.6531 ALASKA VOR FEDERAL AIRWAY V531 - CONTINUED</b>		
GOLLY, AK FIX	*REEBA, AK FIX	**7000
*7000 - MRA		
**5000 - MOCA		
REEBA, AK FIX	TANANA, AK VOR/DME	
	E BND	*7000
	W BND	*4000
*4000 - MOCA		
TANANA, AK VOR/DME	ELCON, AK FIX	
	W BND	*6500
	E BND	*5400
*5400 - MOCA		
ELCON, AK FIX	CENSE, AK FIX	*6500
*5700 - MOCA		
CENSE, AK FIX	HUSLIA, AK VOR/DME	
	W BND	*3500
	E BND	*6500
*3000 - MOCA		
HUSLIA, AK VOR/DME	ATAGO, AK FIX	
	W BND	*4000
	E BND	*3500
*2500 - MOCA		
ATAGO, AK FIX	DESOY, AK FIX	*4000
*3900 - MOCA		
DESOY, AK FIX	SELAWIK, AK VOR/DME	
	W BND	*2500
	E BND	*4000
*2500 - MOCA		
SELAWIK, AK VOR/DME	KOTZEBUE, AK VOR/DME	2500
KOTZEBUE, AK VOR/DME	BERJO, AK FIX	
	SE BND	*2500
	NW BND	*8000
*2500 - MOCA		
BERJO, AK FIX	POINT HOPE, AK NDB	*8000
*4000 - MOCA		

**95.6593 ALASKA VOR FEDERAL AIRWAY V593**

BIORKA ISLAND, AK VORTAC	LYRIC, AK FIX	
	SE BND	*6000
	NW BND	*8000
*4800 - MOCA		
LYRIC, AK FIX	SISTERS ISLAND, AK VORTAC	*8000
*5800 - MOCA		
*5800 - GNSS MEA		

**95.6603 ALASKA VOR FEDERAL AIRWAY V603**

ELFEE, AK NDB	DILLINGHAM, AK VOR/DME	2700
---------------	------------------------	------

**95.6617 ALASKA VOR FEDERAL AIRWAY V617**

HOMER, AK VOR/DME	JOHNSTONE POINT, AK VOR/DME	*12000
*8600 - MOCA		
*9000 - GNSS MEA		

**95.6619 ALASKA VOR FEDERAL AIRWAY V619**

PORT HEIDEN, AK NDB/DME	CHINOOK, AK NDB	4000
CHINOOK, AK NDB	DILLINGHAM, AK VOR/DME	3000

FROM

TO

MEA

**95.6621 ALASKA VOR FEDERAL AIRWAY V621**

BARROW, AK VOR/DME

ATQASUK, AK NDB

2000

FROM

TO

MEA

**§95.6401 HAWAII VOR FEDERAL AIRWAYS****95.6401 HAWAII VOR FEDERAL AIRWAY V1**

KONA, HI VORTAC	*REEFS, HI FIX	5000
*4100 - MCA REEFS, HI FIX , SE BND		
REEFS, HI FIX	MOANA, HI FIX	*2000
*1300 - MOCA		
MOANA, HI FIX	ROWIN, HI FIX	*4000
*1300 - MOCA		
ROWIN, HI FIX	*LAVAS, HI FIX	**8000
*7000 - MRA		
**1300 - MOCA		
LAVAS, HI FIX	MAKEN, HI FIX	*7000
*5000 - MOCA		
MAKEN, HI FIX	HARPO, HI FIX	6300
HARPO, HI FIX	MAUI, HI VORTAC	6000

**95.6402 HAWAII VOR FEDERAL AIRWAY V2**

HONOLULU, HI VORTAC	PALAY, HI FIX	3500
PALAY, HI FIX	LANAI, HI VORTAC	4000
LANAI, HI VORTAC	KEIKI, HI FIX	5500
KEIKI, HI FIX	*HARPO, HI FIX	**5000
*5600 - MCA HARPO, HI FIX , SE BND		
**2500 - MOCA		
HARPO, HI FIX	UPOLU POINT, HI VORTAC	6300
UPOLU POINT, HI VORTAC	WAPIO, HI FIX	*7000
*6000 - MOCA		
WAPIO, HI FIX	PARIS, HI FIX	
	E BND	*4500
	W BND	*6000
*4000 - MOCA		
PARIS, HI FIX	*ARBOR, HI FIX	**4000
*8000 - MRA		
**3000 - MOCA		
ARBOR, HI FIX	HILO, HI VORTAC	3000

**95.6403 HAWAII VOR FEDERAL AIRWAY V3**

MYNAH, HI FIX	*JASON, HI FIX	3500
*5400 - MCA JASON, HI FIX , NE BND		
JASON, HI FIX	KAMUELA, HI VOR/DME	6700
KAMUELA, HI VOR/DME	TIGAH, HI FIX	6500
TIGAH, HI FIX	PARIS, HI FIX	5000

**95.6404 HAWAII VOR FEDERAL AIRWAY V4**

HONOLULU, HI VORTAC	*GECKO, HI FIX	**4000
*10000 - MRA		
**2800 - MOCA		
GECKO, HI FIX	*ZUKEY, HI FIX	
	W BND	16000
	E BND	4000
*16000 - MRA		
ZUKEY, HI FIX	BINJO, HI FIX	
	W BND	29000
	E BND	16000

FROM TO MEA

**95.6405 HAWAII VOR FEDERAL AIRWAY V5**

KONA, HI VORTAC	*MYNAH, HI FIX	5200
*4400 - MCA MYNAH, HI FIX , SE BND		
MYNAH, HI FIX	*HEFTI, HI FIX	**2000
*4100 - MCA HEFTI, HI FIX , NW BND		
**1300 - MOCA		
HEFTI, HI FIX	MAKEN, HI FIX	7600

**95.6406 HAWAII VOR FEDERAL AIRWAY V6**

BLUSH, HI FIX	PLUMB, HI FIX	*5000
*1200 - MOCA		
PLUMB, HI FIX	MAUI, HI VORTAC	4400

**95.6407 HAWAII VOR FEDERAL AIRWAY V7**

KONA, HI VORTAC	*REEFS, HI FIX	5000
*4100 - MCA REEFS, HI FIX , SE BND		
REEFS, HI FIX	MOANA, HI FIX	*2000
*1300 - MOCA		
MOANA, HI FIX	ROWIN, HI FIX	*4000
*1300 - MOCA		
ROWIN, HI FIX	LANAI, HI VORTAC	4000
LANAI, HI VORTAC	MOLOKAI, HI VORTAC	4000
JOELE, OP FIX	ATINE, HI FIX	4000
ATINE, HI FIX	BERLE, HI FIX	7000
BERLE, HI FIX	ZIGIE, OP FIX	22000

**95.6408 HAWAII VOR FEDERAL AIRWAY V8**

HONOLULU, HI VORTAC	*ALANA, HI FIX	3000
*5000 - MRA		
ALANA, HI FIX	HAUNA, HI FIX	3000
HAUNA, HI FIX	LOKIE, HI FIX	2000
LOKIE, HI FIX	MOLOKAI, HI VORTAC	3500
MOLOKAI, HI VORTAC	BLUSH, HI FIX	5000
BLUSH, HI FIX	FISHE, HI FIX	*4000
*1200 - MOCA		

**95.6411 HAWAII VOR FEDERAL AIRWAY V11**

REEFS, HI FIX	*FLITT, HI FIX	**3000
*4600 - MCA FLITT, HI FIX , N BND		
**2000 - MOCA		
**2000 - GNSS MEA		
FLITT, HI FIX	UPOLO POINT, HI VORTAC	5700
UPOLO POINT, HI VORTAC	LNBRG, HI FIX	5400
LNBRG, HI FIX	BARBY, HI FIX	5500
BARBY, HI FIX	*SWEEP, HI FIX	5400
*5400 - MCA SWEEP, HI FIX , S BND		
SWEEP, HI FIX	MAUI, HI VORTAC	5000

**95.6412 HAWAII VOR FEDERAL AIRWAY V12**

KATHS, HI FIX	*NONNI, OP FIX	29000
*29000 - MRA		
NONNI, OP FIX	*LEANE, HI FIX	
	W BND	29000
	E BND	16000
*16000 - MRA		

FROM TO MEA

**95.6412 HAWAII VOR FEDERAL AIRWAY V12 - CONTINUED**

LEANE, HI FIX	*KEOLA, HI FIX	
	W BND	16000
	E BND	5000
*10000 - MRA		
KEOLA, HI FIX	*SHIGI, HI FIX	4000
*5000 - MRA		
SHIGI, HI FIX	HONOLULU, HI VORTAC	4000
HONOLULU, HI VORTAC	*KOKO HEAD, HI VORTAC	5000
*4500 - MCA KOKO HEAD, HI VORTAC , W BND		
KOKO HEAD, HI VORTAC	BAMBO, OP FIX	4500
BAMBO, OP FIX	MAGGI, OP FIX	5000
MAGGI, OP FIX	*SHARK, HI FIX	
	NE BND	**16000
	SW BND	**5000
*16000 - MRA		
**1200 - MOCA		

**95.6413 HAWAII VOR FEDERAL AIRWAY V13**

KOKO HEAD, HI VORTAC	BAMBO, OP FIX	4500
BAMBO, OP FIX	TOADS, OP FIX	5000

**95.6415 HAWAII VOR FEDERAL AIRWAY V15**

CANON, HI FIX	LILIA, OP FIX	
	W BND	32000
	E BND	8000
LILIA, OP FIX	SOUTH KAUAI, HI VORTAC	*8000
*4800 - MOCA		
SOUTH KAUAI, HI VORTAC	LIHUE, HI VORTAC	5000
LIHUE, HI VORTAC	BOOKE, HI FIX	4000
BOOKE, HI FIX	*SHIGI, HI FIX	5000
*5000 - MRA		
SHIGI, HI FIX	HONOLULU, HI VORTAC	4000
HONOLULU, HI VORTAC	*KOKO HEAD, HI VORTAC	5000
*4500 - MCA KOKO HEAD, HI VORTAC , W BND		
KOKO HEAD, HI VORTAC	MABBL, HI FIX	
	E BND	3500
	W BND	4500
MABBL, HI FIX	*MOLOKAI, HI VORTAC	
	E BND	3500
	W BND	4500
*5000 - MCA MOLOKAI, HI VORTAC , E BND		
MOLOKAI, HI VORTAC	*LORET, HI FIX	7000
*7800 - MCA LORET, HI FIX , E BND		
LORET, HI FIX	*MAUI, HI VORTAC	8000
*6800 - MCA MAUI, HI VORTAC , W BND		
MAUI, HI VORTAC	*BARBY, HI FIX	8400
*9800 - MCA BARBY, HI FIX , E BND		
BARBY, HI FIX	*RABAT, HI FIX	**10000
*10000 - MCA RABAT, HI FIX , W BND		
**2700 - MOCA		
RABAT, HI FIX	*PUMIC, HI FIX	6000
*10000 - MRA		
PUMIC, HI FIX	PARIS, HI FIX	4000
PARIS, HI FIX	*ARBOR, HI FIX	**4000
*8000 - MRA		
**3000 - MOCA		
ARBOR, HI FIX	HILO, HI VORTAC	3000

FROM TO MEA

**95.6415 HAWAII VOR FEDERAL AIRWAY V15 - CONTINUED**

HILO, HI VORTAC	HODAY, HI FIX	2000
HODAY, HI FIX	EELIC, HI FIX	10000
EELIC, HI FIX	KUMME, HI FIX	
	W BND	10000
	E BND	31000
KUMME, HI FIX	MAITI, HI FIX	31000

**95.6416 HAWAII VOR FEDERAL AIRWAY V16**

*SYVAD, OP FIX	**PUPPI, OP FIX	
	W BND	32000
	E BND	14000
*32000 - MRA		
**11000 - MRA		
PUPPI, OP FIX	*OHANA, HI FIX	
	W BND	14000
	E BND	5000
*5000 - MRA		
OHANA, HI FIX	SOUTH KAUAI, HI VORTAC	
	W BND	14000
	SE BND	5000
SOUTH KAUAI, HI VORTAC	MORKE, HI FIX	
	NW BND	5000
	SE BND	3000
MORKE, HI FIX	*NAPUA, HI FIX	3000
*6000 - MRA		
NAPUA, HI FIX	*GRAIL, HI FIX	6000
*9000 - MRA		
GRAIL, HI FIX	*KEOLA, HI FIX	9000
*10000 - MRA		
KEOLA, HI FIX	*GECKO, HI FIX	10000
*10000 - MRA		
GECKO, HI FIX	*ALANA, HI FIX	7000
*5000 - MRA		
ALANA, HI FIX	JULLE, HI FIX	5000
JULLE, HI FIX	GRAMY, HI FIX	2000
GRAMY, HI FIX	LANAI, HI VORTAC	4000
LANAI, HI VORTAC	*LAVAS, HI FIX	4300
*7000 - MRA		
LAVAS, HI FIX	*UPOLU POINT, HI VORTAC	6000
*5800 - MCA UPOLU POINT, HI VORTAC	E BND	
UPOLU POINT, HI VORTAC	TIGAH, HI FIX	7000
TIGAH, HI FIX	*OKALA, HI FIX	**8000
*6500 - MCA OKALA, HI FIX , W BND		
**5500 - MOCA		
OKALA, HI FIX	*ARBOR, HI FIX	**8000
*8000 - MRA		
**5500 - MOCA		
ARBOR, HI FIX	HILO, HI VORTAC	3000

**95.6417 HAWAII VOR FEDERAL AIRWAY V17**

HARPO, HI FIX	MAUI, HI VORTAC	6000
STAIT, HI FIX	FREDI, HI FIX	*17000
*1200 - MOCA		
FREDI, HI FIX	REXIE, OP FIX	*28000
*1200 - MOCA		

**95.6420 HAWAII VOR FEDERAL AIRWAY V20**

HONOLULU, HI VORTAC	HAUNA, HI FIX	3000
---------------------	---------------	------

FROM TO MEA

**95.6420 HAWAII VOR FEDERAL AIRWAY V20 - CONTINUED**

HAUNA, HI FIX	JULLE, HI FIX	4000
JULLE, HI FIX	JORDA, HI FIX	5000
JORDA, HI FIX	*FIRES, HI FIX	
	NW BND	**10000
	SE BND	**13000
*13000 - MRA		
**1300 - MOCA		
FIRES, HI FIX	*HOKLA, HI FIX	**13000
*13000 - MRA		
**1300 - MOCA		
HOKLA, HI FIX	TYPHO, HI FIX	*8000
*1300 - MOCA		
TYPHO, HI FIX	*ROBYN, HI FIX	
	SE BND	**3000
	NW BND	**8000
*3900 - MCA ROBYN, HI FIX , SE BND		
**1300 - MOCA		
ROBYN, HI FIX	KONA, HI VORTAC	5000

**95.6421 HAWAII VOR FEDERAL AIRWAY V21**

HONOLULU, HI VORTAC	*ALANA, HI FIX	3000
*5000 - MRA		
ALANA, HI FIX	JULLE, HI FIX	5000
JULLE, HI FIX	GRAMY, HI FIX	2000
GRAMY, HI FIX	LANAI, HI VORTAC	4000
LANAI, HI VORTAC	KEIKI, HI FIX	5500
KEIKI, HI FIX	*HARPO, HI FIX	**5000
*8200 - MCA HARPO, HI FIX , E BND		
**2500 - MOCA		
HARPO, HI FIX	FUNKI, HI FIX	*10000
*9000 - MOCA		
FUNKI, HI FIX	*PUMIC, HI FIX	10000
*10000 - MRA		
PUMIC, HI FIX	BISEN, HI FIX	14000
BISEN, HI FIX	CUTLE, HI FIX	21000
CUTLE, HI FIX	OSTAH, HI FIX	24000
OSTAH, HI FIX	SCOON, OP FIX	22000

**95.6422 HAWAII VOR FEDERAL AIRWAY V22**

*MOLOKAI, HI VORTAC	PLUMB, HI FIX	7000
*5000 - MCA MOLOKAI, HI VORTAC , E BND		
PLUMB, HI FIX	*MAUI, HI VORTAC	4400
*6300 - MCA MAUI, HI VORTAC , E BND		
MAUI, HI VORTAC	*BARBY, HI FIX	8400
*12000 - MCA BARBY, HI FIX , SE BND		
BARBY, HI FIX	SARDS, HI FIX	12000
SARDS, HI FIX	BONUS, HI FIX	8000
BONUS, HI FIX	HILO, HI VORTAC	6000
HILO, HI VORTAC	SESAW, HI FIX	2000
SESAW, HI FIX	BATES, HI FIX	8000
BATES, HI FIX	OSTAH, HI FIX	10000
OSTAH, HI FIX	SCOON, OP FIX	22000

**95.6423 HAWAII VOR FEDERAL AIRWAY V23**

UPOLU POINT, HI VORTAC	JESSI, HI FIX	*6000
*5000 - MOCA		



FROM TO MEA

**95.6423 HAWAII VOR FEDERAL AIRWAY V23 - CONTINUED**

JESSI, HI FIX \*FIRES, HI FIX 8000  
\*13000 - MRA

**95.6424 HAWAII VOR FEDERAL AIRWAY V24**

\*LANAI, HI VORTAC \*\*MAUI, HI VORTAC \*\*\*9000  
\*5100 - MCA LANAI, HI VORTAC , NE BND  
\*\*5100 - MCA MAUI, HI VORTAC , BND  
\*\*\*7800 - MOCA

**95.6425 HAWAII VOR FEDERAL AIRWAY V25**

HILO, HI VORTAC COOKE, HI FIX 3000  
COOKE, HI FIX BASSY, HI FIX 6000  
BASSY, HI FIX CODDY, OP FIX 9000  
CODDY, OP FIX ARROW, HI FIX 26000  
ARROW, HI FIX CLUTS, OP FIX \*26000  
\*1200 - MOCA

FROM	TO	MEA	MAA
------	----	-----	-----

**§95.7001 JET ROUTES**

**95.7001 JET ROUTE J1**

U.S. MEXICAN BORDER	MISSION BAY, CA VORTAC	18000	45000
MISSION BAY, CA VORTAC	OCEANSIDE, CA VORTAC	18000	45000
OCEANSIDE, CA VORTAC	LOS ANGELES, CA VORTAC	18000	45000
LOS ANGELES, CA VORTAC	FILLMORE, CA VORTAC	18000	45000
FILLMORE, CA VORTAC	AVENAL, CA VOR/DME	18000	45000
AVENAL, CA VOR/DME	OAKLAND, CA VOR/DME	18000	45000
OAKLAND, CA VOR/DME	RED BLUFF, CA VORTAC	18000	45000
RED BLUFF, CA VORTAC	ROGUE VALLEY, OR VORTAC	18000	45000
ROGUE VALLEY, OR VORTAC	BATTLE GROUND, WA VORTAC	18000	45000
BATTLE GROUND, WA VORTAC	SEATTLE, WA VORTAC	18000	45000

**95.7002 JET ROUTE J2**

MISSION BAY, CA VORTAC	IMPERIAL, CA VORTAC	18000	45000
IMPERIAL, CA VORTAC	BARD, CA VORTAC	18000	45000
BARD, CA VORTAC	GILA BEND, AZ VORTAC	18000	45000
GILA BEND, AZ VORTAC	TUCSON, AZ VORTAC	18000	45000
TUCSON, AZ VORTAC	EL PASO, TX VORTAC	*25000	45000

\*MEA IS ESTABLISHED WITH A GAP IN NAVIGATION SIGNAL COVERAGE

EL PASO, TX VORTAC	FORT STOCKTON, TX VORTAC	18000	45000
FORT STOCKTON, TX VORTAC	JUNCTION, TX VORTAC	18000	45000
JUNCTION, TX VORTAC	SAN ANTONIO, TX VORTAC	18000	45000
SAN ANTONIO, TX VORTAC	HUMBLE, TX VORTAC	18000	45000
HUMBLE, TX VORTAC	LAKE CHARLES, LA VORTAC	18000	45000
LAKE CHARLES, LA VORTAC	FIGHTING TIGER, LA VORTAC	18000	45000
FIGHTING TIGER, LA VORTAC	SEMMES, AL VORTAC	18000	45000
SEMMES, AL VORTAC	CRESTVIEW, FL VORTAC	18000	45000
CRESTVIEW, FL VORTAC	DEFUN, FL FIX	18000	45000

**95.7003 JET ROUTE J3**

OAKLAND, CA VOR/DME	RED BLUFF, CA VORTAC	18000	45000
RED BLUFF, CA VORTAC	LAKEVIEW, OR VORTAC	18000	45000
LAKEVIEW, OR VORTAC	KIMBERLY, OR VOR/DME	18000	45000
KIMBERLY, OR VOR/DME	SPOKANE, WA VORTAC	18000	45000

**95.7004 JET ROUTE J4**

LOS ANGELES, CA VORTAC	TWENTYNINE PALMS, CA VORTAC	18000	45000
TWENTYNINE PALMS, CA VORTAC	PARKER, CA VORTAC	18000	45000
PARKER, CA VORTAC	BUCKEYE, AZ VORTAC	18000	45000
BUCKEYE, AZ VORTAC	SAN SIMON, AZ VORTAC	18000	45000
SAN SIMON, AZ VORTAC	NEWMAN, TX VORTAC	18000	45000
NEWMAN, TX VORTAC	WINK, TX VORTAC	18000	45000
WINK, TX VORTAC	ABILENE, TX VORTAC	18000	45000
ABILENE, TX VORTAC	RANGER, TX VORTAC	18000	45000
RANGER, TX VORTAC	BELCHER, LA VORTAC	18000	45000
BELCHER, LA VORTAC	MAGNOLIA, MS VORTAC	18000	45000

**95.7005 JET ROUTE J5**

LOS ANGELES, CA VORTAC	SHAFTER, CA VORTAC	18000	45000
SHAFTER, CA VORTAC	MUSTANG, NV VORTAC	*18000	45000

\*MEA IS ESTABLISHED WITH A GAP IN NAVIGATION SIGNAL COVERAGE

FROM	TO	MEA	MAA
<b>95.7005 JET ROUTE J5 - CONTINUED</b>			
MUSTANG, NV VORTAC	LAKEVIEW, OR VORTAC	18000	45000
LAKEVIEW, OR VORTAC	POWEL, OR FIX	18000	45000
POWEL, OR FIX	SUMMA, WA FIX	24000	45000
SUMMA, WA FIX	SEATTLE, WA VORTAC	18000	45000
SEATTLE, WA VORTAC	U.S. CANADIAN BORDER	18000	45000
U.S. CANADIAN BORDER	U.S. CANADIAN BORDER	18000	45000
<b>95.7006 JET ROUTE J6</b>			
SALINAS, CA VORTAC	AVENAL, CA VOR/DME	18000	45000
AVENAL, CA VOR/DME	PALMDALE, CA VORTAC	18000	45000
PALMDALE, CA VORTAC	HECTOR, CA VORTAC	18000	45000
HECTOR, CA VORTAC	NEEDLES, CA VORTAC	18000	45000
NEEDLES, CA VORTAC	DRAKE, AZ VORTAC	18000	45000
DRAKE, AZ VORTAC	PYRIT, AZ FIX	22000	45000
PYRIT, AZ FIX	ZUNI, NM VORTAC	18000	45000
ZUNI, NM VORTAC	ALBUQUERQUE, NM VORTAC	18000	45000
ALBUQUERQUE, NM VORTAC	TUCUMCARI, NM VORTAC	18000	45000
TUCUMCARI, NM VORTAC	PANHANDLE, TX VORTAC	18000	45000
PANHANDLE, TX VORTAC	WILL ROGERS, OK VORTAC	18000	45000
WILL ROGERS, OK VORTAC	LITTLE ROCK, AR VORTAC	18000	45000
CHARLESTON, WV VOR/DME	MARTINSBURG, WV VORTAC	18000	45000
MARTINSBURG, WV VORTAC	LANCASTER, PA VOR/DME	18000	32000
LANCASTER, PA VOR/DME	BROADWAY, NJ VOR/DME	18000	45000
BROADWAY, NJ VOR/DME	SPARTA, NJ VORTAC	18000	45000
SPARTA, NJ VORTAC	ALBANY, NY VORTAC	18000	45000
<b>95.7007 JET ROUTE J7</b>			
LOS ANGELES, CA VORTAC	FILLMORE, CA VORTAC	18000	45000
FILLMORE, CA VORTAC	FRIANT, CA VORTAC	18000	45000
FRIANT, CA VORTAC	MUSTANG, NV VORTAC	18000	45000
MUSTANG, NV VORTAC	ROME, OR VOR/DME	*19000	45000
*MEA IS ESTABLISHED WITH A GAP IN NAVIGATION SIGNAL COVERAGE			
ROME, OR VOR/DME	BOISE, ID VORTAC	18000	45000
BOISE, ID VORTAC	SALMON, ID VOR/DME	18000	45000
SALMON, ID VOR/DME	GREAT FALLS, MT VORTAC	18000	45000
GREAT FALLS, MT VORTAC	U.S. CANADIAN BORDER	18000	45000
<b>95.7008 JET ROUTE J8</b>			
NEEDLES, CA VORTAC	FLAGSTAFF, AZ VOR/DME	18000	45000
FLAGSTAFF, AZ VOR/DME	GALLUP, NM VORTAC	18000	45000
GALLUP, NM VORTAC	FORT UNION, NM VORTAC	18000	45000
SPRINGFIELD, MO VORTAC	ST LOUIS, MO VORTAC	18000	45000
ST LOUIS, MO VORTAC	LOUISVILLE, KY VORTAC	18000	45000
LOUISVILLE, KY VORTAC	CHARLESTON, WV VOR/DME	18000	45000
CHARLESTON, WV VOR/DME	CASANOVA, VA VORTAC	18000	45000
<b>95.7009 JET ROUTE J9</b>			
LOS ANGELES, CA VORTAC	DAGGETT, CA VORTAC	18000	45000
DAGGETT, CA VORTAC	LAS VEGAS, NV VORTAC	18000	45000
LAS VEGAS, NV VORTAC	MILFORD, UT VORTAC	18000	45000
MILFORD, UT VORTAC	FAIRFIELD, UT VORTAC	18000	45000
FAIRFIELD, UT VORTAC	WASATCH, UT VORTAC	18000	45000
WASATCH, UT VORTAC	DUBOIS, ID VORTAC	18000	45000
DUBOIS, ID VORTAC	DILLON, MT VOR/DME	18000	45000
DILLON, MT VOR/DME	GREAT FALLS, MT VORTAC	18000	45000

FROM	TO	MEA	MAA
<b>95.7010 JET ROUTE J10</b>			
LOS ANGELES, CA VORTAC	TWENTYNINE PALMS, CA VORTAC	18000	45000
TWENTYNINE PALMS, CA VORTAC	HIPPI, AZ FIX	23000	40000
HIPPI, AZ FIX	FLAGSTAFF, AZ VOR/DME	23000	40000
FLAGSTAFF, AZ VOR/DME	RATTLESNAKE, NM VORTAC	18000	40000
RATTLESNAKE, NM VORTAC	BLUE MESA, CO VOR/DME	18000	45000
BLUE MESA, CO VOR/DME	FALCON, CO VORTAC	18000	45000
FALCON, CO VORTAC	NORTH PLATTE, NE VOR/DME	18000	45000
NORTH PLATTE, NE VOR/DME	WOLBACH, NE VORTAC	18000	41000
WOLBACH, NE VORTAC	DES MOINES, IA VORTAC	18000	45000
DES MOINES, IA VORTAC	IOWA CITY, IA VOR/DME	18000	45000
<b>95.7011 JET ROUTE J11</b>			
TUCSON, AZ VORTAC	PHOENIX, AZ VORTAC	18000	45000
PHOENIX, AZ VORTAC	DRAKE, AZ VORTAC	18000	45000
DRAKE, AZ VORTAC	BRYCE CANYON, UT VORTAC	18000	45000
BRYCE CANYON, UT VORTAC	FAIRFIELD, UT VORTAC	18000	45000
FAIRFIELD, UT VORTAC	WASATCH, UT VORTAC	18000	45000
<b>95.7012 JET ROUTE J12</b>			
SEATTLE, WA VORTAC	EPHRATA, WA VORTAC	18000	45000
EPHRATA, WA VORTAC	DONNELLY, ID VOR/DME	18000	45000
DONNELLY, ID VOR/DME	TWIN FALLS, ID VORTAC	18000	45000
TWIN FALLS, ID VORTAC	WASATCH, UT VORTAC	22000	45000
WASATCH, UT VORTAC	FAIRFIELD, UT VORTAC	18000	45000
FAIRFIELD, UT VORTAC	GRAND JUNCTION, CO VOR/DME	18000	45000
<b>95.7013 JET ROUTE J13</b>			
U.S. MEXICAN BORDER	TRUTH OR CONSEQUENCES, NM VORTAC	18000	45000
TRUTH OR CONSEQUENCES, NM VORTAC	ALBUQUERQUE, NM VORTAC	18000	45000
ALBUQUERQUE, NM VORTAC	ALAMOSA, CO VORTAC	18000	45000
ALAMOSA, CO VORTAC	FALCON, CO VORTAC	23000	45000
FALCON, CO VORTAC	CHEYENNE, WY VORTAC	18000	45000
CHEYENNE, WY VORTAC	MUDDY MOUNTAIN, WY VOR/DME	18000	45000
MUDDY MOUNTAIN, WY VOR/DME	BILLINGS, MT VORTAC	18000	45000
BILLINGS, MT VORTAC	GREAT FALLS, MT VORTAC	18000	45000
GREAT FALLS, MT VORTAC	U.S. CANADIAN BORDER	18000	45000
<b>95.7014 JET ROUTE J14</b>			
PANHANDLE, TX VORTAC	WILL ROGERS, OK VORTAC	18000	45000
WILL ROGERS, OK VORTAC	LITTLE ROCK, AR VORTAC	18000	45000
LITTLE ROCK, AR VORTAC	VULCAN, AL VORTAC	18000	45000
<b>95.7015 JET ROUTE J15</b>			
HUMBLE, TX VORTAC	MARCS, TX FIX	19000	45000
MARCS, TX FIX	JUNCTION, TX VORTAC	18000	45000
JUNCTION, TX VORTAC	WINK, TX VORTAC	18000	45000
WINK, TX VORTAC	CHISUM, NM VORTAC	18000	45000
CHISUM, NM VORTAC	CORONA, NM VORTAC	18000	45000
CORONA, NM VORTAC	ALBUQUERQUE, NM VORTAC	18000	45000
ALBUQUERQUE, NM VORTAC	RATTLESNAKE, NM VORTAC	18000	45000
RATTLESNAKE, NM VORTAC	GRAND JUNCTION, CO VOR/DME	18000	45000
GRAND JUNCTION, CO VOR/DME	WASATCH, UT VORTAC	*18000	45000

\*MEA IS ESTABLISHED WITH A GAP IN NAVIGATION SIGNAL COVERAGE

FROM	TO	MEA	MAA
<b>95.7015 JET ROUTE J15 - CONTINUED</b>			
WASATCH, UT VORTAC	TWIN FALLS, ID VORTAC	22000	45000
TWIN FALLS, ID VORTAC	BOISE, ID VORTAC	18000	45000
BOISE, ID VORTAC	KIMBERLY, OR VOR/DME	18000	45000
KIMBERLY, OR VOR/DME	BATTLE GROUND, WA VORTAC	18000	45000
<b>95.7016 JET ROUTE J16</b>			
BATTLE GROUND, WA VORTAC	PENDLETON, OR VORTAC	18000	45000
PENDLETON, OR VORTAC	WHITEHALL, MT VOR/DME	*29000	45000
*MEA IS ESTABLISHED WITH A GAP IN NAVIGATION SIGNAL COVERAGE			
WHITEHALL, MT VOR/DME	BILLINGS, MT VORTAC	18000	45000
BILLINGS, MT VORTAC	DUPREE, SD VOR/DME	*20000	45000
*MEA IS ESTABLISHED WITH A GAP IN NAVIGATION SIGNAL COVERAGE			
DUPREE, SD VOR/DME	SIOUX FALLS, SD VORTAC	18000	45000
SIOUX FALLS, SD VORTAC	MASON CITY, IA VOR/DME	18000	45000
MASON CITY, IA VOR/DME	BADGER, WI VOR/DME	18000	45000
<b>95.7017 JET ROUTE J17</b>			
SAN ANTONIO, TX VORTAC	ABILENE, TX VORTAC	18000	45000
ABILENE, TX VORTAC	PANHANDLE, TX VORTAC	18000	45000
PANHANDLE, TX VORTAC	TOBE, CO VOR/DME	18000	45000
TOBE, CO VOR/DME	PUEBLO, CO VORTAC	18000	45000
PUEBLO, CO VORTAC	FALCON, CO VORTAC	18000	45000
FALCON, CO VORTAC	CHEYENNE, WY VORTAC	18000	45000
CHEYENNE, WY VORTAC	RAPID CITY, SD VORTAC	18000	45000
<b>95.7018 JET ROUTE J18</b>			
MISSION BAY, CA VORTAC	IMPERIAL, CA VORTAC	18000	45000
IMPERIAL, CA VORTAC	BARD, CA VORTAC	18000	45000
BARD, CA VORTAC	GILA BEND, AZ VORTAC	18000	45000
GILA BEND, AZ VORTAC	PHOENIX, AZ VORTAC	18000	45000
PHOENIX, AZ VORTAC	ST JOHNS, AZ VORTAC	18000	45000
ST JOHNS, AZ VORTAC	ALBUQUERQUE, NM VORTAC	18000	45000
ALBUQUERQUE, NM VORTAC	FORT UNION, NM VORTAC	18000	45000
FORT UNION, NM VORTAC	GARDEN CITY, KS VORTAC	18000	45000
GARDEN CITY, KS VORTAC	SALINA, KS VORTAC	18000	45000
SALINA, KS VORTAC	ST JOSEPH, MO VORTAC	18000	45000
ST JOSEPH, MO VORTAC	MOLINE, IL VOR/DME	18000	35000
MOLINE, IL VOR/DME	JOLIET, IL VOR/DME	18000	35000
<b>95.7019 JET ROUTE J19</b>			
ST LOUIS, MO VORTAC	ROBERTS, IL VOR/DME	18000	35000
ROBERTS, IL VOR/DME	NORTHBROOK, IL VOR/DME	18000	35000
<b>95.7020 JET ROUTE J20</b>			
SEATTLE, WA VORTAC	YAKIMA, WA VORTAC	18000	45000
YAKIMA, WA VORTAC	PENDLETON, OR VORTAC	18000	45000
PENDLETON, OR VORTAC	DONNELLY, ID VOR/DME	18000	45000
DONNELLY, ID VOR/DME	POCATELLO, ID VOR/DME	18000	45000
POCATELLO, ID VOR/DME	ROCK SPRINGS, WY VOR/DME	21000	45000
ROCK SPRINGS, WY VOR/DME	FALCON, CO VORTAC	*22000	45000
*MEA IS ESTABLISHED WITH A GAP IN NAVIGATION SIGNAL COVERAGE			
FALCON, CO VORTAC	HUGO, CO VOR/DME	18000	45000
HUGO, CO VOR/DME	LAMAR, CO VOR/DME	18000	45000
WILL ROGERS, OK VORTAC	BELCHER, LA VORTAC	18000	45000

FROM	TO	MEA	MAA
<b>95.7020 JET ROUTE J20 - CONTINUED</b>			
BELCHER, LA VORTAC	MAGNOLIA, MS VORTAC	18000	45000
MAGNOLIA, MS VORTAC	MERIDIAN, MS VORTAC	18000	45000
MERIDIAN, MS VORTAC	MONTGOMERY, AL VORTAC	18000	45000
<b>95.7021 JET ROUTE J21</b>			
U.S. MEXICAN BORDER	LAREDO, TX VORTAC	18000	45000
LAREDO, TX VORTAC	SAN ANTONIO, TX VORTAC	18000	45000
SAN ANTONIO, TX VORTAC	CENTEX, TX VORTAC	18000	45000
CENTEX, TX VORTAC	WACO, TX VORTAC	18000	45000
WACO, TX VORTAC	RANGER, TX VORTAC	18000	45000
RANGER, TX VORTAC	ARDMORE, OK VORTAC	18000	45000
ARDMORE, OK VORTAC	WILL ROGERS, OK VORTAC	18000	45000
WILL ROGERS, OK VORTAC	WICHITA, KS VORTAC	18000	45000
WICHITA, KS VORTAC	OMAHA, IA VORTAC	18000	45000
OMAHA, IA VORTAC	GOPHER, MN VORTAC	18000	45000
GOPHER, MN VORTAC	DULUTH, MN VORTAC	18000	45000
<b>95.7022 JET ROUTE J22</b>			
U.S. MEXICAN BORDER	LAREDO, TX VORTAC	18000	45000
LAREDO, TX VORTAC	CORPUS CHRISTI, TX VORTAC	18000	45000
CORPUS CHRISTI, TX VORTAC	PALACIOS, TX VORTAC	18000	45000
PALACIOS, TX VORTAC	LAKE CHARLES, LA VORTAC	18000	45000
LAKE CHARLES, LA VORTAC	MC COMB, MS VORTAC	18000	45000
MC COMB, MS VORTAC	MERIDIAN, MS VORTAC	18000	45000
<b>95.7023 JET ROUTE J23</b>			
SAN ANTONIO, TX VORTAC	MILLSAP, TX VORTAC	18000	45000
MILLSAP, TX VORTAC	WILL ROGERS, OK VORTAC	18000	45000
WILL ROGERS, OK VORTAC	PIONEER, OK VORTAC	18000	45000
PIONEER, OK VORTAC	WICHITA, KS VORTAC	18000	45000
<b>95.7024 JET ROUTE J24</b>			
MYTON, UT VOR/DME	HAYDEN, CO VOR/DME	18000	45000
HUGO, CO VOR/DME	HAYS, KS VORTAC	18000	45000
HAYS, KS VORTAC	SALINA, KS VORTAC	18000	45000
SALINA, KS VORTAC	KANSAS CITY, MO VORTAC	18000	45000
KANSAS CITY, MO VORTAC	ST LOUIS, MO VORTAC	18000	45000
ST LOUIS, MO VORTAC	BRICKYARD, IN VORTAC	18000	45000
BRICKYARD, IN VORTAC	FALMOUTH, KY VOR/DME	18000	45000
FALMOUTH, KY VOR/DME	CHARLESTON, WV VOR/DME	18000	45000
CHARLESTON, WV VOR/DME	MONTEBELLO, VA VOR/DME	18000	41000
<b>95.7025 JET ROUTE J25</b>			
U.S. MEXICAN BORDER	BROWNSVILLE, TX VORTAC	18000	45000
BROWNSVILLE, TX VORTAC	CORPUS CHRISTI, TX VORTAC	18000	45000
CORPUS CHRISTI, TX VORTAC	SAN ANTONIO, TX VORTAC	18000	45000
SAN ANTONIO, TX VORTAC	CENTEX, TX VORTAC	18000	45000
CENTEX, TX VORTAC	WACO, TX VORTAC	18000	45000
WACO, TX VORTAC	RANGER, TX VORTAC	18000	45000
RANGER, TX VORTAC	TULSA, OK VORTAC	18000	45000
TULSA, OK VORTAC	KANSAS CITY, MO VORTAC	18000	45000
KANSAS CITY, MO VORTAC	DES MOINES, IA VORTAC	18000	45000
DES MOINES, IA VORTAC	MASON CITY, IA VOR/DME	18000	45000
MASON CITY, IA VOR/DME	GOPHER, MN VORTAC	18000	45000

FROM	TO	MEA	MAA
<b>95.7026 JET ROUTE J26</b>			
U.S. MEXICAN BORDER	EL PASO, TX VORTAC	18000	45000
EL PASO, TX VORTAC	CHISUM, NM VORTAC	18000	45000
CHISUM, NM VORTAC	PANHANDLE, TX VORTAC	18000	45000
PANHANDLE, TX VORTAC	MITBEE, OK VORTAC	18000	45000
MITBEE, OK VORTAC	WICHITA, KS VORTAC	18000	45000
WICHITA, KS VORTAC	KANSAS CITY, MO VORTAC	18000	45000
KANSAS CITY, MO VORTAC	KIRKSVILLE, MO VORTAC	18000	45000
KIRKSVILLE, MO VORTAC	BRADFORD, IL VORTAC	18000	45000
BRADFORD, IL VORTAC	JOLIET, IL VOR/DME	18000	45000
<b>95.7027 JET ROUTE J27</b>			
SAN ANTONIO, TX VORTAC	LUFKIN, TX VORTAC	18000	45000
<b>95.7028 JET ROUTE J28</b>			
MILFORD, UT VORTAC	HANKSVILLE, UT VORTAC	18000	45000
HANKSVILLE, UT VORTAC	BLUE MESA, CO VOR/DME	18000	45000
BLUE MESA, CO VOR/DME	PUEBLO, CO VORTAC	18000	45000
PUEBLO, CO VORTAC	GARDEN CITY, KS VORTAC	18000	45000
GARDEN CITY, KS VORTAC	WICHITA, KS VORTAC	18000	45000
<b>95.7029 JET ROUTE J29</b>			
U.S. MEXICAN BORDER	CORPUS CHRISTI, TX VORTAC	24000	45000
CORPUS CHRISTI, TX VORTAC	PALACIOS, TX VORTAC	18000	45000
PALACIOS, TX VORTAC	HUMBLE, TX VORTAC	18000	45000
HUMBLE, TX VORTAC	EL DORADO, AR VOR/DME	18000	45000
EL DORADO, AR VOR/DME	MEMPHIS, TN VORTAC	18000	45000
MEMPHIS, TN VORTAC	POCKET CITY, IN VORTAC	18000	45000
<b>95.7030 JET ROUTE J30</b>			
NODINE, MN VORTAC	JOLIET, IL VOR/DME	18000	45000
JOLIET, IL VOR/DME	APPLETON, OH VORTAC	18000	45000
APPLETON, OH VORTAC	BUCKO, WV FIX	20000	39000
BUCKO, WV FIX	KESSEL, WV VOR/DME	18000	45000
KESSEL, WV VOR/DME	TRIXY, VA FIX	19000	29000
<b>95.7031 JET ROUTE J31</b>			
LEEVILLE, LA VORTAC	HARVEY, LA VORTAC	18000	45000
HARVEY, LA VORTAC	MERIDIAN, MS VORTAC	18000	45000
<b>95.7032 JET ROUTE J32</b>			
OAKLAND, CA VOR/DME	SACRAMENTO, CA VORTAC	18000	45000
SACRAMENTO, CA VORTAC	MUSTANG, NV VORTAC	18000	45000
MUSTANG, NV VORTAC	LOVELOCK, NV VORTAC	18000	45000
LOVELOCK, NV VORTAC	BATTLE MOUNTAIN, NV VORTAC	18000	45000
BATTLE MOUNTAIN, NV VORTAC	MALAD CITY, ID VOR/DME	*18000	45000
*MEA IS ESTABLISHED WITH A GAP IN NAVIGATION SIGNAL COVERAGE			
MALAD CITY, ID VOR/DME	BOYSEN RESERVOIR, WY VOR/DME	18000	45000
BOYSEN RESERVOIR, WY VOR/DME	CRAZY WOMAN, WY VOR/DME	18000	45000
CRAZY WOMAN, WY VOR/DME	DUPREE, SD VOR/DME	18000	45000
DUPREE, SD VOR/DME	ABERDEEN, SD VOR/DME	18000	45000
ABERDEEN, SD VOR/DME	DULUTH, MN VORTAC	18000	45000

FROM	TO	MEA	MAA
<b>95.7033 JET ROUTE J33</b>			
HUMBLE, TX VORTAC	DONIE, TX FIX	18000	45000
DONIE, TX FIX	RANGER, TX VORTAC	18000	45000
<b>95.7034 JET ROUTE J34</b>			
HOQUIAM, WA VORTAC	OLYMPIA, WA VORTAC	18000	45000
OLYMPIA, WA VORTAC	MOSES LAKE, WA VOR/DME	18000	45000
MOSES LAKE, WA VOR/DME	HELENA, MT VORTAC	*28000	45000
*MEA IS ESTABLISHED WITH A GAP IN NAVIGATION SIGNAL COVERAGE			
HELENA, MT VORTAC	BILLINGS, MT VORTAC	18000	45000
BILLINGS, MT VORTAC	DUPREE, SD VOR/DME	*20000	45000
*MEA IS ESTABLISHED WITH A GAP IN NAVIGATION SIGNAL COVERAGE			
DUPREE, SD VOR/DME	REDWOOD FALLS, MN VOR/DME	18000	45000
REDWOOD FALLS, MN VOR/DME	NODINE, MN VORTAC	18000	45000
NODINE, MN VORTAC	DELLS, WI VORTAC	18000	45000
DELLS, WI VORTAC	BADGER, WI VOR/DME	18000	45000
BADGER, WI VOR/DME	VICTORY, MI VOR/DME	18000	45000
VICTORY, MI VOR/DME	CARLETON, MI VOR/DME	18000	45000
CARLETON, MI VOR/DME	DRYER, OH VOR/DME	18000	45000
DRYER, OH VOR/DME	BELLAIRE, OH VOR/DME	18000	45000
BELLAIRE, OH VOR/DME	BUCKO, WV FIX	18000	45000
BUCKO, WV FIX	KESSEL, WV VOR/DME	18000	45000
KESSEL, WV VOR/DME	TRIXY, VA FIX	19000	29000
<b>95.7035 JET ROUTE J35</b>			
LEEVILLE, LA VORTAC	MC COMB, MS VORTAC	18000	45000
MC COMB, MS VORTAC	SIDON, MS VORTAC	18000	45000
SIDON, MS VORTAC	MEMPHIS, TN VORTAC	18000	45000
MEMPHIS, TN VORTAC	FARMINGTON, MO VORTAC	18000	45000
FARMINGTON, MO VORTAC	ST LOUIS, MO VORTAC	18000	45000
ST LOUIS, MO VORTAC	SPINNER, IL VORTAC	18000	45000
SPINNER, IL VORTAC	PONTIAC, IL VOR/DME	18000	31000
PONTIAC, IL VOR/DME	JOLIET, IL VOR/DME	18000	35000
JOLIET, IL VOR/DME	NORTHBROOK, IL VOR/DME	18000	45000
<b>95.7036 JET ROUTE J36</b>			
MULLAN PASS, ID VOR/DME	GREAT FALLS, MT VORTAC	18000	45000
GREAT FALLS, MT VORTAC	HILGR, MT FIX	18000	45000
HILGR, MT FIX	DICKINSON, ND VORTAC	*28000	45000
*MEA IS ESTABLISHED WITH A GAP IN NAVIGATION SIGNAL COVERAGE			
DICKINSON, ND VORTAC	FARGO, ND VOR/DME	18000	45000
FARGO, ND VOR/DME	GOPHER, MN VORTAC	18000	45000
GOPHER, MN VORTAC	NODINE, MN VORTAC	18000	45000
NODINE, MN VORTAC	BADGER, WI VOR/DME	18000	45000
BADGER, WI VOR/DME	FLINT, MI VORTAC	18000	45000
<b>95.7037 JET ROUTE J37</b>			
HARVEY, LA VORTAC	SEMMES, AL VORTAC	18000	45000
SEMMES, AL VORTAC	MONTGOMERY, AL VORTAC	18000	45000
LYNCHBURG, VA VOR/DME	GORDONSVILLE, VA VORTAC	18000	45000
GORDONSVILLE, VA VORTAC	BROOKE, VA VORTAC	18000	45000
BROOKE, VA VORTAC	NALES, DE FIX	18000	31000
NALES, DE FIX	COYLE, NJ VORTAC	18000	45000
KENNEDY, NY VOR/DME	KINGSTON, NY VOR/DME	18000	45000
KINGSTON, NY VOR/DME	ALBANY, NY VORTAC	18000	45000



FROM	TO	MEA	MAA
<b>95.7041 JET ROUTE J41</b>			
MONTGOMERY, AL VORTAC	VULCAN, AL VORTAC	18000	45000
VULCAN, AL VORTAC	MEMPHIS, TN VORTAC	18000	45000
MEMPHIS, TN VORTAC	SPRINGFIELD, MO VORTAC	18000	45000
SPRINGFIELD, MO VORTAC	KANSAS CITY, MO VORTAC	18000	45000
KANSAS CITY, MO VORTAC	OMAHA, IA VORTAC	18000	45000
<b>95.7042 JET ROUTE J42</b>			
U.S. MEXICAN BORDER	FORT STOCKTON, TX VORTAC	18000	45000
FORT STOCKTON, TX VORTAC	ABILENE, TX VORTAC	18000	45000
ABILENE, TX VORTAC	RANGER, TX VORTAC	18000	45000
RANGER, TX VORTAC	TEXARKANA, AR VORTAC	18000	45000
<b>95.7043 JET ROUTE J43</b>			
VOLUNTEER, TN VORTAC	FALMOUTH, KY VOR/DME	18000	45000
FALMOUTH, KY VOR/DME	ROSEWOOD, OH VORTAC	18000	45000
ROSEWOOD, OH VORTAC	CARLETON, MI VOR/DME	18000	45000
<b>95.7044 JET ROUTE J44</b>			
PHOENIX, AZ VORTAC	WINSLOW, AZ VORTAC	18000	45000
WINSLOW, AZ VORTAC	RATTLESNAKE, NM VORTAC	18000	45000
RATTLESNAKE, NM VORTAC	ALAMOSA, CO VORTAC	18000	45000
ALAMOSA, CO VORTAC	FALCON, CO VORTAC	23000	45000
FALCON, CO VORTAC	MC COOK, NE VOR/DME	18000	45000
MC COOK, NE VOR/DME	LINCOLN, NE VORTAC	18000	41000
<b>95.7045 JET ROUTE J45</b>			
NASHVILLE, TN VORTAC	ST LOUIS, MO VORTAC	18000	45000
ST LOUIS, MO VORTAC	KIRKSVILLE, MO VORTAC	18000	45000
KIRKSVILLE, MO VORTAC	DES MOINES, IA VORTAC	*18000	45000
*DES MOINES R-141 UNUSABLE, USE KIRKSVILLE R-323			
DES MOINES, IA VORTAC	SIOUX FALLS, SD VORTAC	18000	45000
SIOUX FALLS, SD VORTAC	ABERDEEN, SD VOR/DME	18000	45000
<b>95.7046 JET ROUTE J46</b>			
TULSA, OK VORTAC	WALNUT RIDGE, AR VORTAC	18000	45000
WALNUT RIDGE, AR VORTAC	NASHVILLE, TN VORTAC	18000	45000
NASHVILLE, TN VORTAC	VOLUNTEER, TN VORTAC	18000	45000
<b>95.7048 JET ROUTE J48</b>			
*LANNA, NJ FIX	POTTSTOWN, PA VORTAC	18000	45000
*5000 - MRA			
POTTSTOWN, PA VORTAC	WESTMINSTER, MD VORTAC	18000	45000
WESTMINSTER, MD VORTAC	CASANOVA, VA VORTAC	18000	45000
CASANOVA, VA VORTAC	MONTEBELLO, VA VOR/DME	18000	41000
<b>95.7049 JET ROUTE J49</b>			
PHILIPSBURG, PA VORTAC	HANCOCK, NY VOR/DME	18000	45000
HANCOCK, NY VOR/DME	ALBANY, NY VORTAC	18000	45000
ALBANY, NY VORTAC	BANGOR, ME VORTAC	18000	45000
BANGOR, ME VORTAC	PRESQUE ISLE, ME VOR/DME	18000	45000

FROM	TO	MEA	MAA
<b>95.7050 JET ROUTE J50</b>			
SHAFTER, CA VORTAC	PARADISE, CA VORTAC	18000	45000
PARADISE, CA VORTAC	BLYTHE, CA VORTAC	18000	45000
BLYTHE, CA VORTAC	GILA BEND, AZ VORTAC	18000	45000
GILA BEND, AZ VORTAC	STANFIELD, AZ VORTAC	18000	45000
STANFIELD, AZ VORTAC	SAN SIMON, AZ VORTAC	18000	45000
SAN SIMON, AZ VORTAC	EL PASO, TX VORTAC	18000	45000
EL PASO, TX VORTAC	WINK, TX VORTAC	18000	45000
WINK, TX VORTAC	ABILENE, TX VORTAC	18000	45000
ABILENE, TX VORTAC	WACO, TX VORTAC	18000	45000
WACO, TX VORTAC	LUFKIN, TX VORTAC	18000	45000
LUFKIN, TX VORTAC	ALEXANDRIA, LA VORTAC	18000	45000
ALEXANDRIA, LA VORTAC	MC COMB, MS VORTAC	18000	45000
MC COMB, MS VORTAC	CRESTVIEW, FL VORTAC	18000	45000
<b>95.7052 JET ROUTE J52</b>			
U.S. CANADIAN BORDER	SPOKANE, WA VORTAC	18000	45000
SPOKANE, WA VORTAC	SALMON, ID VOR/DME	18000	45000
SALMON, ID VOR/DME	DUBOIS, ID VORTAC	18000	45000
DUBOIS, ID VORTAC	ROCK SPRINGS, WY VOR/DME	18000	45000
ROCK SPRINGS, WY VOR/DME	FALCON, CO VORTAC	*22000	45000
*MEA IS ESTABLISHED WITH A GAP IN NAVIGATION SIGNAL COVERAGE			
FALCON, CO VORTAC	HUGO, CO VOR/DME	18000	45000
HUGO, CO VOR/DME	LAMAR, CO VOR/DME	18000	45000
ARDMORE, OK VORTAC	TEXARKANA, AR VORTAC	18000	45000
TEXARKANA, AR VORTAC	SIDON, MS VORTAC	18000	45000
<b>95.7054 JET ROUTE J54</b>			
TATOOSH, WA VORTAC	OLYMPIA, WA VORTAC	18000	45000
OLYMPIA, WA VORTAC	BAKER CITY, OR VOR/DME	*24000	45000
*MEA IS ESTABLISHED WITH A GAP IN NAVIGATION SIGNAL COVERAGE			
BAKER CITY, OR VOR/DME	BOISE, ID VORTAC	18000	45000
BOISE, ID VORTAC	POCATELLO, ID VOR/DME	18000	45000
POCATELLO, ID VOR/DME	CHEROKEE, WY VOR/DME	25000	45000
CHEROKEE, WY VOR/DME	LARAMIE, WY VOR/DME	18000	45000
<b>95.7055 JET ROUTE J55</b>			
TUBAS, NC FIX	RALEIGH/DURHAM, NC VORTAC	18000	45000
RALEIGH/DURHAM, NC VORTAC	HOPEWELL, VA VORTAC	18000	45000
HOPEWELL, VA VORTAC	HUBBS, VA FIX	18000	20000
SEA ISLE, NJ VORTAC	HAMPTON, NY VORTAC	18000	45000
HAMPTON, NY VORTAC	PROVIDENCE, RI VOR/DME	18000	45000
PROVIDENCE, RI VOR/DME	BOSTON, MA VOR/DME	18000	45000
BOSTON, MA VOR/DME	KENNEBUNK, ME VOR/DME	18000	45000
KENNEBUNK, ME VOR/DME	PRESQUE ISLE, ME VOR/DME	19000	45000
<b>95.7056 JET ROUTE J56</b>			
MINA, NV VORTAC	WASATCH, UT VORTAC	*33000	45000
*MEA IS ESTABLISHED WITH A GAP IN NAVIGATION SIGNAL COVERAGE			
WASATCH, UT VORTAC	HAYDEN, CO VOR/DME	25000	45000
HAYDEN, CO VOR/DME	FALCON, CO VORTAC	18000	45000
<b>95.7057 JET ROUTE J57</b>			
TRUTH OR CONSEQUENCES, NM VORTAC	SOCORRO, NM VORTAC	18000	45000

FROM	TO	MEA	MAA
<b>95.7057 JET ROUTE J57 - CONTINUED</b>			
SOCORRO, NM VORTAC	ALBUQUERQUE, NM VORTAC	18000	45000
<b>95.7058 JET ROUTE J58</b>			
COALDALE, NV VORTAC	WILSON CREEK, NV VORTAC	18000	45000
WILSON CREEK, NV VORTAC	MILFORD, UT VORTAC	18000	45000
MILFORD, UT VORTAC	RATTLESNAKE, NM VORTAC	33000	45000
RATTLESNAKE, NM VORTAC	FORT UNION, NM VORTAC	18000	45000
FORT UNION, NM VORTAC	PANHANDLE, TX VORTAC	18000	45000
PANHANDLE, TX VORTAC	WICHITA FALLS, TX VORTAC	18000	45000
WICHITA FALLS, TX VORTAC	RANGER, TX VORTAC	18000	45000
RANGER, TX VORTAC	ALEXANDRIA, LA VORTAC	18000	45000
ALEXANDRIA, LA VORTAC	HARVEY, LA VORTAC	18000	45000
<b>95.7059 JET ROUTE J59</b>			
PHILIPSBURG, PA VORTAC	SYRACUSE, NY VORTAC	18000	45000
<b>95.7060 JET ROUTE J60</b>			
LOS ANGELES, CA VORTAC	PARADISE, CA VORTAC	18000	45000
PARADISE, CA VORTAC	HECTOR, CA VORTAC	18000	45000
HECTOR, CA VORTAC	BOULDER CITY, NV VORTAC	18000	45000
BOULDER CITY, NV VORTAC	BRYCE CANYON, UT VORTAC	18000	45000
BRYCE CANYON, UT VORTAC	HANKSVILLE, UT VORTAC	18000	45000
HANKSVILLE, UT VORTAC	RED TABLE, CO VOR/DME	18000	45000
RED TABLE, CO VOR/DME	MILE HIGH, CO VORTAC	18000	45000
MILE HIGH, CO VORTAC	HAYES CENTER, NE VORTAC	18000	45000
HAYES CENTER, NE VORTAC	LINCOLN, NE VORTAC	18000	45000
LINCOLN, NE VORTAC	IOWA CITY, IA VOR/DME	18000	45000
IOWA CITY, IA VOR/DME	JOLIET, IL VOR/DME	18000	45000
JOLIET, IL VOR/DME	GOSHEN, IN VORTAC	18000	45000
GOSHEN, IN VORTAC	DRYER, OH VOR/DME	18000	45000
DRYER, OH VOR/DME	PHILIPSBURG, PA VORTAC	18000	45000
PHILIPSBURG, PA VORTAC	SPARTA, NJ VORTAC	18000	45000
<b>95.7061 JET ROUTE J61</b>			
WESTMINSTER, MD VORTAC	PHILIPSBURG, PA VORTAC	18000	45000
<b>95.7064 JET ROUTE J64</b>			
LOS ANGELES, CA VORTAC	HECTOR, CA VORTAC	18000	45000
HECTOR, CA VORTAC	PEACH SPRINGS, AZ VOR/DME	18000	45000
PEACH SPRINGS, AZ VOR/DME	TUBA CITY, AZ VORTAC	18000	45000
TUBA CITY, AZ VORTAC	RATTLESNAKE, NM VORTAC	18000	45000
RATTLESNAKE, NM VORTAC	PUEBLO, CO VORTAC	20000	45000
PUEBLO, CO VORTAC	HILL CITY, KS VORTAC	18000	45000
HILL CITY, KS VORTAC	PAWNEE CITY, NE VORTAC	18000	45000
PAWNEE CITY, NE VORTAC	LAMONI, IA VOR/DME	18000	45000
LAMONI, IA VOR/DME	BRADFORD, IL VORTAC	18000	45000
BRADFORD, IL VORTAC	FORT WAYNE, IN VORTAC	18000	45000
FORT WAYNE, IN VORTAC	ELLWOOD CITY, PA VOR/DME	18000	45000
ELLWOOD CITY, PA VOR/DME	RAVINE, PA VORTAC	18000	45000
RAVINE, PA VORTAC	SARAA, PA FIX	18000	45000
<b>95.7065 JET ROUTE J65</b>			
SAN ANTONIO, TX VORTAC	ABILENE, TX VORTAC	18000	45000

FROM	TO	MEA	MAA
<b>95.7065 JET ROUTE J65 - CONTINUED</b>			
ABILENE, TX VORTAC	CHISUM, NM VORTAC	25000	45000
CHISUM, NM VORTAC	TRUTH OR CONSEQUENCES, NM VORTAC	24000	45000
TRUTH OR CONSEQUENCES, NM VORTAC	PHOENIX, AZ VORTAC	*23000	45000
*MEA IS ESTABLISHED WITH A GAP IN NAVIGATION SIGNAL COVERAGE			
PHOENIX, AZ VORTAC	BLYTHE, CA VORTAC	18000	45000
BLYTHE, CA VORTAC	PALMDALE, CA VORTAC	18000	45000
PALMDALE, CA VORTAC	SHAFTER, CA VORTAC	18000	45000
SACRAMENTO, CA VORTAC	RED BLUFF, CA VORTAC	18000	45000
RED BLUFF, CA VORTAC	KLAMATH FALLS, OR VORTAC	18000	45000
KLAMATH FALLS, OR VORTAC	SEATTLE, WA VORTAC	*31000	45000
*MEA IS ESTABLISHED WITH A GAP IN NAVIGATION SIGNAL COVERAGE			
<b>95.7066 JET ROUTE J66</b>			
NEWMAN, TX VORTAC	BIG SPRING, TX VORTAC	*19000	45000
*MEA IS ESTABLISHED WITH A GAP IN NAVIGATION SIGNAL COVERAGE			
BIG SPRING, TX VORTAC	ABILENE, TX VORTAC	18000	45000
ABILENE, TX VORTAC	RANGER, TX VORTAC	18000	45000
RANGER, TX VORTAC	BONHAM, TX VORTAC	18000	45000
BONHAM, TX VORTAC	LITTLE ROCK, AR VORTAC	18000	45000
LITTLE ROCK, AR VORTAC	MEMPHIS, TN VORTAC	18000	45000
MEMPHIS, TN VORTAC	ROME, GA VORTAC	18000	45000
<b>95.7067 JET ROUTE J67</b>			
LINDEN, CA VOR/DME	LAKEVIEW, OR VORTAC	18000	45000
LAKEVIEW, OR VORTAC	BATTLE GROUND, WA VORTAC	18000	45000
<b>95.7068 JET ROUTE J68</b>			
GOPHER, MN VORTAC	DELLS, WI VORTAC	18000	45000
DELLS, WI VORTAC	BADGER, WI VOR/DME	18000	45000
BADGER, WI VOR/DME	FLINT, MI VORTAC	18000	45000
<b>95.7070 JET ROUTE J70</b>			
HOQUIAM, WA VORTAC	SEATTLE, WA VORTAC	18000	45000
SEATTLE, WA VORTAC	EPHRATA, WA VORTAC	18000	45000
EPHRATA, WA VORTAC	MULLAN PASS, ID VOR/DME	18000	45000
MULLAN PASS, ID VOR/DME	LEWISTOWN, MT VOR/DME	18000	45000
LEWISTOWN, MT VOR/DME	DICKINSON, ND VORTAC	18000	45000
DICKINSON, ND VORTAC	ABERDEEN, SD VOR/DME	24000	45000
ABERDEEN, SD VOR/DME	GOPHER, MN VORTAC	18000	45000
GOPHER, MN VORTAC	NICKL, WI FIX	18000	45000
NICKL, WI FIX	*AUGER, WI FIX	25000	45000
*25000 - MCA AUGER, WI FIX , W BND			
AUGER, WI FIX	BADGER, WI VOR/DME	18000	45000
BADGER, WI VOR/DME	PULLMAN, MI VOR/DME	18000	45000
PULLMAN, MI VOR/DME	SALEM, MI VORTAC	18000	45000
SALEM, MI VORTAC	U.S. CANADIAN BORDER	18000	45000
U.S. CANADIAN BORDER	JAMESTOWN, NY VOR/DME	18000	45000
JAMESTOWN, NY VOR/DME	WILKES-BARRE, PA VORTAC	18000	45000
WILKES-BARRE, PA VORTAC	STILLWATER, NJ VOR/DME	18000	45000
STILLWATER, NJ VOR/DME	LA GUARDIA, NY VOR/DME	18000	24000
LA GUARDIA, NY VOR/DME	KENNEDY, NY VOR/DME	18000	45000
<b>95.7071 JET ROUTE J71</b>			
MEMPHIS, TN VORTAC	CENTRALIA, IL VORTAC	18000	45000

FROM	TO	MEA	MAA
<b>95.7071 JET ROUTE J71 - CONTINUED</b>			
CENTRALIA, IL VORTAC	ROBERTS, IL VOR/DME	18000	35000
ROBERTS, IL VOR/DME	NORTHBROOK, IL VOR/DME	18000	35000
<b>95.7072 JET ROUTE J72</b>			
BOULDER CITY, NV VORTAC	PEACH SPRINGS, AZ VOR/DME	18000	45000
PEACH SPRINGS, AZ VOR/DME	GALLUP, NM VORTAC	*18000	45000
*MEA IS ESTABLISHED WITH A GAP IN NAVIGATION SIGNAL COVERAGE			
GALLUP, NM VORTAC	ALBUQUERQUE, NM VORTAC	18000	45000
ALBUQUERQUE, NM VORTAC	TEXICO, TX VORTAC	18000	45000
TEXICO, TX VORTAC	WICHITA FALLS, TX VORTAC	18000	45000
<b>95.7073 JET ROUTE J73</b>			
LAGRANGE, GA VORTAC	NASHVILLE, TN VORTAC	18000	45000
NASHVILLE, TN VORTAC	POCKET CITY, IN VORTAC	18000	45000
POCKET CITY, IN VORTAC	NORTHBROOK, IL VOR/DME	18000	45000
<b>95.7074 JET ROUTE J74</b>			
LOS ANGELES, CA VORTAC	PARADISE, CA VORTAC	18000	45000
PARADISE, CA VORTAC	PARKER, CA VORTAC	18000	45000
PARKER, CA VORTAC	NABOB, AZ FIX	21000	45000
NABOB, AZ FIX	ST JOHNS, AZ VORTAC	18000	45000
ST JOHNS, AZ VORTAC	CORONA, NM VORTAC	18000	45000
CORONA, NM VORTAC	TEXICO, TX VORTAC	18000	45000
TEXICO, TX VORTAC	WILL ROGERS, OK VORTAC	18000	45000
<b>95.7076 JET ROUTE J76</b>			
LAS VEGAS, NV VORTAC	TUBA CITY, AZ VORTAC	18000	45000
TUBA CITY, AZ VORTAC	FORT UNION, NM VORTAC	*27000	45000
*MEA GAP			
*MEA IS ESTABLISHED WITH A GAP IN NAVIGATION SIGNAL COVERAGE			
FORT UNION, NM VORTAC	TUCUMCARI, NM VORTAC	18000	45000
TUCUMCARI, NM VORTAC	WICHITA FALLS, TX VORTAC	18000	45000
<b>95.7078 JET ROUTE J78</b>			
LOS ANGELES, CA VORTAC	SEAL BEACH, CA VORTAC	18000	45000
SEAL BEACH, CA VORTAC	THERMAL, CA VORTAC	18000	45000
THERMAL, CA VORTAC	PARKER, CA VORTAC	18000	45000
PARKER, CA VORTAC	DRAKE, AZ VORTAC	18000	45000
DRAKE, AZ VORTAC	PYRIT, AZ FIX	22000	45000
PYRIT, AZ FIX	ZUNI, NM VORTAC	18000	45000
ZUNI, NM VORTAC	ALBUQUERQUE, NM VORTAC	18000	45000
ALBUQUERQUE, NM VORTAC	TUCUMCARI, NM VORTAC	18000	45000
TUCUMCARI, NM VORTAC	PANHANDLE, TX VORTAC	18000	45000
PANHANDLE, TX VORTAC	WILL ROGERS, OK VORTAC	18000	45000
WILL ROGERS, OK VORTAC	TULSA, OK VORTAC	18000	45000
TULSA, OK VORTAC	FARMINGTON, MO VORTAC	18000	45000
FARMINGTON, MO VORTAC	POCKET CITY, IN VORTAC	18000	45000
POCKET CITY, IN VORTAC	LOUISVILLE, KY VORTAC	18000	45000
LOUISVILLE, KY VORTAC	CHARLESTON, WV VOR/DME	18000	45000
<b>95.7079 JET ROUTE J79</b>			
CHARLESTON, SC VORTAC	TAR RIVER, NC VORTAC	18000	45000
TAR RIVER, NC VORTAC	FRANKLIN, VA VORTAC	18000	45000

FROM	TO	MEA	MAA
<b>95.7079 JET ROUTE J79 - CONTINUED</b>			
FRANKLIN, VA VORTAC	SALISBURY, MD VORTAC	18000	45000
SALISBURY, MD VORTAC	KENNEDY, NY VOR/DME	18000	45000
KENNEDY, NY VOR/DME	CUJKE, MA FIX	18000	45000
CUJKE, MA FIX	MARCONI, MA VOR/DME	UNUSABLE	
MARCONI, MA VOR/DME	BANGOR, ME VORTAC	18000	45000
<b>95.7080 JET ROUTE J80</b>			
COALDALE, NV VORTAC	WILSON CREEK, NV VORTAC	18000	45000
WILSON CREEK, NV VORTAC	MILFORD, UT VORTAC	18000	45000
MILFORD, UT VORTAC	GRAND JUNCTION, CO VOR/DME	18000	45000
GRAND JUNCTION, CO VOR/DME	RED TABLE, CO VOR/DME	18000	45000
RED TABLE, CO VOR/DME	FALCON, CO VORTAC	18000	45000
FALCON, CO VORTAC	GOODLAND, KS VORTAC	18000	45000
GOODLAND, KS VORTAC	HILL CITY, KS VORTAC	18000	45000
HILL CITY, KS VORTAC	KANSAS CITY, MO VORTAC	18000	45000
KANSAS CITY, MO VORTAC	SPINNER, IL VORTAC	18000	45000
SPINNER, IL VORTAC	BRICKYARD, IN VORTAC	18000	45000
BRICKYARD, IN VORTAC	BELLAIRE, OH VOR/DME	18000	45000
<b>95.7082 JET ROUTE J82</b>			
BATTLE GROUND, WA VORTAC	DONNELLY, ID VOR/DME	22000	45000
DONNELLY, ID VOR/DME	DUBOIS, ID VORTAC	18000	45000
DUBOIS, ID VORTAC	CRAZY WOMAN, WY VOR/DME	*25000	45000
*MEA IS ESTABLISHED WITH A GAP IN NAVIGATION SIGNAL COVERAGE			
CRAZY WOMAN, WY VOR/DME	RAPID CITY, SD VORTAC	18000	45000
RAPID CITY, SD VORTAC	SIOUX FALLS, SD VORTAC	18000	45000
DUBUQUE, IA VORTAC	JOLIET, IL VOR/DME	18000	45000
JOLIET, IL VOR/DME	GOSHEN, IN VORTAC	18000	45000
<b>95.7083 JET ROUTE J83</b>			
SPARTANBURG, SC VORTAC	APPLETON, OH VORTAC	23000	45000
APPLETON, OH VORTAC	DRYER, OH VOR/DME	*18000	45000
*APPLETON R-021 UNUSABLE.			
<b>95.7084 JET ROUTE J84</b>			
OAKLAND, CA VOR/DME	LINDEN, CA VOR/DME	18000	45000
LINDEN, CA VOR/DME	MINA, NV VORTAC	18000	45000
MINA, NV VORTAC	DELTA, UT VORTAC	*20000	45000
*MEA IS ESTABLISHED WITH A GAP IN NAVIGATION SIGNAL COVERAGE			
DELTA, UT VORTAC	MEEKER, CO VOR/DME	*20000	45000
*MEA IS ESTABLISHED WITH A GAP IN NAVIGATION SIGNAL COVERAGE			
MEEKER, CO VOR/DME	SIDNEY, NE VOR/DME	*22000	45000
*MEA IS ESTABLISHED WITH A GAP IN NAVIGATION SIGNAL COVERAGE			
SIDNEY, NE VOR/DME	WOLBACH, NE VORTAC	18000	45000
WOLBACH, NE VORTAC	DUBUQUE, IA VORTAC	*21000	45000
*MEA IS ESTABLISHED WITH A GAP IN NAVIGATION SIGNAL COVERAGE			
DUBUQUE, IA VORTAC	NORTHBROOK, IL VOR/DME	18000	45000
NORTHBROOK, IL VOR/DME	DANVILLE, IL VORTAC	18000	35000
<b>95.7085 JET ROUTE J85</b>			
SPARTANBURG, SC VORTAC	CHARLESTON, WV VOR/DME	18000	45000
CHARLESTON, WV VOR/DME	DRYER, OH VOR/DME	18000	45000
<b>95.7086 JET ROUTE J86</b>			
BEATTY, NV VORTAC	FUZZY, NV FIX	18000	45000

FROM	TO	MEA	MAA
<b>95.7086 JET ROUTE J86 - CONTINUED</b>			
FUZZY, NV FIX	BOULDER CITY, NV VORTAC	29000	45000
BOULDER CITY, NV VORTAC	PEACH SPRINGS, AZ VOR/DME	18000	45000
PEACH SPRINGS, AZ VOR/DME	BAVPE, AZ FIX	18000	45000
BAVPE, AZ FIX	WINSLOW, AZ VORTAC	18000	45000
WINSLOW, AZ VORTAC	EL PASO, TX VORTAC	*27000	45000
*MEA IS ESTABLISHED WITH A GAP IN NAVIGATION SIGNAL COVERAGE			
EL PASO, TX VORTAC	FORT STOCKTON, TX VORTAC	18000	45000
FORT STOCKTON, TX VORTAC	JUNCTION, TX VORTAC	18000	45000
JUNCTION, TX VORTAC	HUMBLE, TX VORTAC	18000	45000
HUMBLE, TX VORTAC	LEEVILLE, LA VORTAC	18000	45000
<b>95.7087 JET ROUTE J87</b>			
HUMBLE, TX VORTAC	NAVASOTA, TX VOR/DME	18000	45000
NAVASOTA, TX VOR/DME	TORN, TX FIX	18000	45000
TORN, TX FIX	COWBOY, TX VOR/DME	18000	45000
COWBOY, TX VOR/DME	TULSA, OK VORTAC	18000	45000
TULSA, OK VORTAC	BUTLER, MO VORTAC	18000	45000
BUTLER, MO VORTAC	KIRKSVILLE, MO VORTAC	18000	45000
KIRKSVILLE, MO VORTAC	MOLINE, IL VOR/DME	18000	35000
MOLINE, IL VOR/DME	JOLIET, IL VOR/DME	18000	35000
JOLIET, IL VOR/DME	NORTHBROOK, IL VOR/DME	18000	45000
<b>95.7088 JET ROUTE J88</b>			
LOS ANGELES, CA VORTAC	SAN MARCUS, CA VORTAC	18000	45000
SAN MARCUS, CA VORTAC	SALINAS, CA VORTAC	18000	45000
SALINAS, CA VORTAC	POINT REYES, CA VOR/DME	18000	45000
<b>95.7089 JET ROUTE J89</b>			
LOUISVILLE, KY VORTAC	BOILER, IN VORTAC	18000	45000
BOILER, IN VORTAC	NORTHBROOK, IL VOR/DME	18000	45000
NORTHBROOK, IL VOR/DME	BADGER, WI VOR/DME	18000	45000
BADGER, WI VOR/DME	DULUTH, MN VORTAC	*18000	45000
*BADGER R-322 UNUSABLE			
DULUTH, MN VORTAC	U.S. CANADIAN BORDER	18000	45000
<b>95.7090 JET ROUTE J90</b>			
SEATTLE, WA VORTAC	MOSES LAKE, WA VOR/DME	18000	45000
MOSES LAKE, WA VOR/DME	HELENA, MT VORTAC	*28000	45000
*MEA IS ESTABLISHED WITH A GAP IN NAVIGATION SIGNAL COVERAGE			
HELENA, MT VORTAC	MILES CITY, MT VOR/DME	28000	45000
MILES CITY, MT VOR/DME	ABERDEEN, SD VOR/DME	*20000	45000
*MEA IS ESTABLISHED WITH A GAP IN NAVIGATION SIGNAL COVERAGE			
ABERDEEN, SD VOR/DME	REDWOOD FALLS, MN VOR/DME	18000	45000
REDWOOD FALLS, MN VOR/DME	MASON CITY, IA VOR/DME	18000	45000
MASON CITY, IA VOR/DME	NORTHBROOK, IL VOR/DME	18000	45000
<b>95.7092 JET ROUTE J92</b>			
KLAMATH FALLS, OR VORTAC	MUSTANG, NV VORTAC	18000	45000
MUSTANG, NV VORTAC	COALDALE, NV VORTAC	18000	45000
COALDALE, NV VORTAC	BEATTY, NV VORTAC	18000	45000
BEATTY, NV VORTAC	BOULDER CITY, NV VORTAC	24000	45000
BOULDER CITY, NV VORTAC	DRAKE, AZ VORTAC	18000	45000
DRAKE, AZ VORTAC	PHOENIX, AZ VORTAC	18000	45000
PHOENIX, AZ VORTAC	STANFIELD, AZ VORTAC	18000	45000

FROM	TO	MEA	MAA
<b>95.7092 JET ROUTE J92 - CONTINUED</b>			
STANFIELD, AZ VORTAC	TUCSON, AZ VORTAC	18000	45000
TUCSON, AZ VORTAC	U.S. MEXICAN BORDER	18000	45000
<b>95.7093 JET ROUTE J93</b>			
U.S. MEXICAN BORDER	JULIAN, CA VORTAC	18000	37000
JULIAN, CA VORTAC	PARADISE, CA VORTAC	18000	45000
PARADISE, CA VORTAC	LOS ANGELES, CA VORTAC	18000	45000
<b>95.7094 JET ROUTE J94</b>			
MUSTANG, NV VORTAC	LOVELOCK, NV VORTAC	18000	45000
LOVELOCK, NV VORTAC	BATTLE MOUNTAIN, NV VORTAC	18000	45000
BATTLE MOUNTAIN, NV VORTAC	LUCIN, UT VORTAC	18000	45000
LUCIN, UT VORTAC	ROCK SPRINGS, WY VOR/DME	*18000	45000
*MEA IS ESTABLISHED WITH A GAP IN NAVIGATION SIGNAL COVERAGE			
ROCK SPRINGS, WY VOR/DME	SCOTTSBLUFF, NE VORTAC	18000	45000
SCOTTSBLUFF, NE VORTAC	O'NEILL, NE VORTAC	18000	45000
DUBUQUE, IA VORTAC	NORTHBROOK, IL VOR/DME	18000	45000
NORTHBROOK, IL VOR/DME	PULLMAN, MI VOR/DME	18000	45000
PULLMAN, MI VOR/DME	FLINT, MI VORTAC	18000	45000
<b>95.7095 JET ROUTE J95</b>			
DEER PARK, NY VOR/DME	GAYEL, NY FIX	18000	45000
GAYEL, NY FIX	BINGHAMTON, NY VOR/DME	18000	45000
<b>95.7096 JET ROUTE J96</b>			
LOS ANGELES, CA VORTAC	PARADISE, CA VORTAC	18000	45000
PARADISE, CA VORTAC	PARKER, CA VORTAC	18000	45000
PARKER, CA VORTAC	DRAKE, AZ VORTAC	18000	45000
DRAKE, AZ VORTAC	GALLUP, NM VORTAC	18000	45000
GALLUP, NM VORTAC	CIMARRON, NM VORTAC	*23000	45000
*MEA IS ESTABLISHED WITH A GAP IN NAVIGATION SIGNAL COVERAGE			
CIMARRON, NM VORTAC	GARDEN CITY, KS VORTAC	18000	45000
GARDEN CITY, KS VORTAC	SALINA, KS VORTAC	18000	45000
SALINA, KS VORTAC	KIRKSVILLE, MO VORTAC	18000	45000
KIRKSVILLE, MO VORTAC	PEORIA, IL VORTAC	18000	35000
PEORIA, IL VORTAC	JOLIET, IL VOR/DME	18000	35000
<b>95.7098 JET ROUTE J98</b>			
MITBEE, OK VORTAC	WILL ROGERS, OK VORTAC	18000	45000
WILL ROGERS, OK VORTAC	TULSA, OK VORTAC	18000	45000
TULSA, OK VORTAC	SPRINGFIELD, MO VORTAC	18000	45000
SPRINGFIELD, MO VORTAC	FARMINGTON, MO VORTAC	18000	45000
<b>95.7099 JET ROUTE J99</b>			
COLLIERS, SC VORTAC	VOLUNTEER, TN VORTAC	18000	45000
VOLUNTEER, TN VORTAC	LOUISVILLE, KY VORTAC	18000	45000
<b>95.7100 JET ROUTE J100</b>			
LOS ANGELES, CA VORTAC	DAGGETT, CA VORTAC	18000	45000
DAGGETT, CA VORTAC	LAS VEGAS, NV VORTAC	18000	45000
LAS VEGAS, NV VORTAC	BRYCE CANYON, UT VORTAC	18000	45000



FROM	TO	MEA	MAA
<b>95.7100 JET ROUTE J100 - CONTINUED</b>			
BRYCE CANYON, UT VORTAC	MEEKER, CO VOR/DME	*20000	45000
*MEA IS ESTABLISHED WITH A GAP IN NAVIGATION SIGNAL COVERAGE			
MEEKER, CO VOR/DME	SIDNEY, NE VOR/DME	*22000	45000
*MEA IS ESTABLISHED WITH A GAP IN NAVIGATION SIGNAL COVERAGE			
SIDNEY, NE VOR/DME	WOLBACH, NE VORTAC	18000	45000
WOLBACH, NE VORTAC	DUBUQUE, IA VORTAC	*21000	45000
*MEA IS ESTABLISHED WITH A GAP IN NAVIGATION SIGNAL COVERAGE			
DUBUQUE, IA VORTAC	NORTHBROOK, IL VOR/DME	18000	45000
<b>95.7101 JET ROUTE J101</b>			
HUMBLE, TX VORTAC	LUFKIN, TX VORTAC	18000	45000
LUFKIN, TX VORTAC	LITTLE ROCK, AR VORTAC	18300	45000
LITTLE ROCK, AR VORTAC	ST LOUIS, MO VORTAC	18000	45000
ST LOUIS, MO VORTAC	SPINNER, IL VORTAC	18000	45000
SPINNER, IL VORTAC	PONTIAC, IL VOR/DME	18000	31000
PONTIAC, IL VOR/DME	JOLIET, IL VOR/DME	18000	35000
JOLIET, IL VOR/DME	NORTHBROOK, IL VOR/DME	18000	45000
NORTHBROOK, IL VOR/DME	BADGER, WI VOR/DME	18000	45000
BADGER, WI VOR/DME	GREEN BAY, WI VORTAC	18000	45000
GREEN BAY, WI VORTAC	SAULT STE MARIE, MI VOR/DME	18000	45000
<b>95.7102 JET ROUTE J102</b>			
PHOENIX, AZ VORTAC	ZUNI, NM VORTAC	18000	45000
ZUNI, NM VORTAC	GALLUP, NM VORTAC	18000	45000
GALLUP, NM VORTAC	ALAMOSA, CO VORTAC	18000	45000
ALAMOSA, CO VORTAC	LAMAR, CO VOR/DME	18000	45000
LAMAR, CO VOR/DME	SALINA, KS VORTAC	18000	45000
<b>95.7104 JET ROUTE J104</b>			
LOS ANGELES, CA VORTAC	TWENTYNINE PALMS, CA VORTAC	18000	45000
TWENTYNINE PALMS, CA VORTAC	PARKER, CA VORTAC	18000	45000
PARKER, CA VORTAC	GILA BEND, AZ VORTAC	18000	45000
GILA BEND, AZ VORTAC	TUCSON, AZ VORTAC	18000	45000
TUCSON, AZ VORTAC	SAN SIMON, AZ VORTAC	18000	45000
SAN SIMON, AZ VORTAC	SOCORRO, NM VORTAC	20000	45000
SOCORRO, NM VORTAC	FORT UNION, NM VORTAC	18000	45000
FORT UNION, NM VORTAC	PUEBLO, CO VORTAC	18000	45000
<b>95.7106 JET ROUTE J106</b>			
JAMESTOWN, NY VOR/DME	WILKES-BARRE, PA VORTAC	18000	45000
WILKES-BARRE, PA VORTAC	STILLWATER, NJ VOR/DME	18000	45000
STILLWATER, NJ VOR/DME	LA GUARDIA, NY VOR/DME	18000	24000
<b>95.7107 JET ROUTE J107</b>			
LOS ANGELES, CA VORTAC	HECTOR, CA VORTAC	18000	45000
HECTOR, CA VORTAC	BOULDER CITY, NV VORTAC	18000	45000
BOULDER CITY, NV VORTAC	MILFORD, UT VORTAC	18000	45000
MILFORD, UT VORTAC	ROCK SPRINGS, WY VOR/DME	*33000	45000
*MEA IS ESTABLISHED WITH A GAP IN NAVIGATION SIGNAL COVERAGE			
ROCK SPRINGS, WY VOR/DME	MUDDY MOUNTAIN, WY VOR/DME	18000	45000
MUDDY MOUNTAIN, WY VOR/DME	DUPREE, SD VOR/DME	18000	45000
<b>95.7108 JET ROUTE J108</b>			
WINSLOW, AZ VORTAC	ST JOHNS, AZ VORTAC	18000	45000

FROM	TO	MEA	MAA
<b>95.7108 JET ROUTE J108 - CONTINUED</b>			
ST JOHNS, AZ VORTAC	TRUTH OR CONSEQUENCES, NM VORTAC	18000	45000
TRUTH OR CONSEQUENCES, NM VORTAC	WINK, TX VORTAC	24000	45000
<b>95.7110 JET ROUTE J110</b>			
BOULDER CITY, NV VORTAC	RATTLESNAKE, NM VORTAC	*28000	45000
*MEA IS ESTABLISHED WITH A GAP IN NAVIGATION SIGNAL COVERAGE			
RATTLESNAKE, NM VORTAC	ALAMOSA, CO VORTAC	18000	45000
ALAMOSA, CO VORTAC	GARDEN CITY, KS VORTAC	*19000	45000
*MEA IS ESTABLISHED WITH A GAP IN NAVIGATION SIGNAL COVERAGE			
GARDEN CITY, KS VORTAC	BUTLER, MO VORTAC	*22000	45000
*MEA IS ESTABLISHED WITH A GAP IN NAVIGATION SIGNAL COVERAGE			
BUTLER, MO VORTAC	ST LOUIS, MO VORTAC	18000	45000
ST LOUIS, MO VORTAC	BRICKYARD, IN VORTAC	18000	45000
BRICKYARD, IN VORTAC	BELLAIRE, OH VOR/DME	18000	45000
BELLAIRE, OH VOR/DME	VINSE, PA FIX	18000	45000
VINSE, PA FIX	KIPPI, PA FIX	26000	45000
KIPPI, PA FIX	COYLE, NJ VORTAC	22000	45000
<b>95.7111 JET ROUTE J111</b>			
NOME, AK VOR/DME	UNALAKLEET, AK VOR/DME	18000	45000
UNALAKLEET, AK VOR/DME	MC GRATH, AK VORTAC	18000	45000
MC GRATH, AK VORTAC	ANCHORAGE, AK VOR/DME	18000	45000
<b>95.7112 JET ROUTE J112</b>			
BUTLER, MO VORTAC	FARMINGTON, MO VORTAC	18000	45000
FARMINGTON, MO VORTAC	POCKET CITY, IN VORTAC	18000	45000
POCKET CITY, IN VORTAC	LOUISVILLE, KY VORTAC	18000	45000
<b>95.7114 JET ROUTE J114</b>			
MILE HIGH, CO VORTAC	SIDNEY, NE VOR/DME	18000	45000
SIDNEY, NE VOR/DME	O'NEILL, NE VORTAC	23000	45000
O'NEILL, NE VORTAC	SIOUX FALLS, SD VORTAC	18000	45000
SIOUX FALLS, SD VORTAC	GOPHER, MN VORTAC	18000	45000
<b>95.7115 JET ROUTE J115</b>			
SHEMYA, AK NDB	MOUNT MOFFETT, AK NDB/DME	18000	45000
MOUNT MOFFETT, AK NDB/DME	DUTCH HARBOR, AK NDB/DME	18000	45000
DUTCH HARBOR, AK NDB/DME	COLD BAY, AK VORTAC	18000	45000
COLD BAY, AK VORTAC	KING SALMON, AK VORTAC	*18000	45000
*MEA IS ESTABLISHED WITH A GAP IN NAVIGATION SIGNAL COVERAGE			
KING SALMON, AK VORTAC	KENAI, AK VOR/DME	18000	45000
KENAI, AK VOR/DME	ANCHORAGE, AK VOR/DME	18000	45000
ANCHORAGE, AK VOR/DME	BIG LAKE, AK VORTAC	18000	45000
BIG LAKE, AK VORTAC	FAIRBANKS, AK VORTAC	18000	45000
FAIRBANKS, AK VORTAC	CHANDALAR LAKE, AK NDB	18000	45000
CHANDALAR LAKE, AK NDB	DEADHORSE, AK VOR/DME	18000	45000
<b>95.7116 JET ROUTE J116</b>			
WASATCH, UT VORTAC	FAIRFIELD, UT VORTAC	18000	45000
FAIRFIELD, UT VORTAC	MEEKER, CO VOR/DME	18000	45000
MEEKER, CO VOR/DME	FALCON, CO VORTAC	20000	45000
<b>95.7117 JET ROUTE J117</b>			
MC GRATH, AK VORTAC	GALENA, AK VOR/DME	18000	45000

FROM	TO	MEA	MAA
<b>95.7117 JET ROUTE J117 - CONTINUED</b>			
GALENA, AK VOR/DME	KOTZEBUE, AK VOR/DME	18000	45000
<b>95.7120 JET ROUTE J120</b>			
MOUNT MOFFETT, AK NDB/DME	ST PAUL ISLAND, AK NDB/DME	18000	45000
ST PAUL ISLAND, AK NDB/DME	BETHEL, AK VORTAC	28000	45000
BETHEL, AK VORTAC	MC GRATH, AK VORTAC	18000	45000
MC GRATH, AK VORTAC	FAIRBANKS, AK VORTAC	18000	45000
FAIRBANKS, AK VORTAC	FORT YUKON, AK VORTAC	18000	45000
<b>95.7121 JET ROUTE J121</b>			
CHARLESTON, SC VORTAC	KINSTON, NC VORTAC	18000	45000
KINSTON, NC VORTAC	NORFOLK, VA VORTAC	18000	45000
NORFOLK, VA VORTAC	SNOW HILL, MD VORTAC	18000	45000
SNOW HILL, MD VORTAC	SEA ISLE, NJ VORTAC	18000	45000
SEA ISLE, NJ VORTAC	BRIGS, NJ FIX	18000	45000
<b>95.7122 JET ROUTE J122</b>			
FAIRBANKS, AK VORTAC	GALENA, AK VOR/DME	18000	45000
GALENA, AK VOR/DME	NOME, AK VOR/DME	18000	45000
<b>95.7123 JET ROUTE J123</b>			
CJAYY, AK FIX	KODIAK, AK VOR/DME	18000	45000
KODIAK, AK VOR/DME	KING SALMON, AK VORTAC	18000	45000
KING SALMON, AK VORTAC	BETHEL, AK VORTAC	18000	45000
BETHEL, AK VORTAC	NOME, AK VOR/DME	18000	45000
NOME, AK VOR/DME	KOTZEBUE, AK VOR/DME	18000	45000
KOTZEBUE, AK VOR/DME	BARROW, AK VOR/DME	*21000	45000
*MEA IS ESTABLISHED WITH A GAP IN NAVIGATION SIGNAL COVERAGE			
<b>95.7124 JET ROUTE J124</b>			
BIG LAKE, AK VORTAC	GULKANA, AK VOR/DME	18000	45000
GULKANA, AK VOR/DME	NORTHWAY, AK VORTAC	18000	45000
<b>95.7125 JET ROUTE J125</b>			
KODIAK, AK VOR/DME	ANCHORAGE, AK VOR/DME	18000	45000
<b>95.7126 JET ROUTE J126</b>			
LOS ANGELES, CA VORTAC	SAN MARCUS, CA VORTAC	18000	45000
SAN MARCUS, CA VORTAC	SALINAS, CA VORTAC	18000	45000
SALINAS, CA VORTAC	SACRAMENTO, CA VORTAC	18000	45000
SACRAMENTO, CA VORTAC	RED BLUFF, CA VORTAC	18000	45000
RED BLUFF, CA VORTAC	ROGUE VALLEY, OR VORTAC	18000	45000
ROGUE VALLEY, OR VORTAC	EUGENE, OR VORTAC	18000	45000
EUGENE, OR VORTAC	NEWBERG, OR VOR/DME	18000	45000
NEWBERG, OR VOR/DME	OLYMPIA, WA VORTAC	18000	45000
OLYMPIA, WA VORTAC	U.S. CANADIAN BORDER	18000	45000
U.S. CANADIAN BORDER	U.S. CANADIAN BORDER	18000	45000
<b>95.7127 JET ROUTE J127</b>			
KING SALMON, AK VORTAC	RINGO, AK FIX	18000	45000

FROM	TO	MEA	MAA
<b>95.7127 JET ROUTE J127 - CONTINUED</b>			
RINGO, AK FIX	NONDA, AK FIX	18000	45000
<b>95.7128 JET ROUTE J128</b>			
LOS ANGELES, CA VORTAC	RUSTT, CA FIX	18000	45000
RUSTT, CA FIX	PEACH SPRINGS, AZ VOR/DME	25000	45000
PEACH SPRINGS, AZ VOR/DME	TUBA CITY, AZ VORTAC	18000	45000
TUBA CITY, AZ VORTAC	BLUE MESA, CO VOR/DME	*20000	45000
*MEA IS ESTABLISHED WITH A GAP IN NAVIGATION SIGNAL COVERAGE			
BLUE MESA, CO VOR/DME	FALCON, CO VORTAC	18000	45000
FALCON, CO VORTAC	HAYES CENTER, NE VORTAC	18000	45000
HAYES CENTER, NE VORTAC	WOLBACH, NE VORTAC	18000	45000
WOLBACH, NE VORTAC	DUBUQUE, IA VORTAC	*21000	45000
*MEA IS ESTABLISHED WITH A GAP IN NAVIGATION SIGNAL COVERAGE			
DUBUQUE, IA VORTAC	NORTHBROOK, IL VOR/DME	18000	45000
<b>95.7129 JET ROUTE J129</b>			
NOME, AK VOR/DME	KOTZEBUE, AK VOR/DME	18000	45000
<b>95.7130 JET ROUTE J130</b>			
MC COOK, NE VOR/DME	PAWNEE CITY, NE VORTAC	18000	41000
<b>95.7131 JET ROUTE J131</b>			
SAN ANTONIO, TX VORTAC	EDNAS, TX FIX	18000	45000
EDNAS, TX FIX	RANGER, TX VORTAC	18000	45000
RANGER, TX VORTAC	TEXARKANA, AR VORTAC	18000	45000
TEXARKANA, AR VORTAC	LITTLE ROCK, AR VORTAC	18000	45000
LITTLE ROCK, AR VORTAC	POCKET CITY, IN VORTAC	*18000	45000
*MEA IS ESTABLISHED WITH A GAP IN NAVIGATION SIGNAL COVERAGE			
<b>95.7132 JET ROUTE J132</b>			
ELMIRA, NY VOR/DME	HUGUENOT, NY VOR/DME	18000	45000
<b>95.7133 JET ROUTE J133</b>			
SITKA, AK NDB	ORCA BAY, AK NDB	18000	45000
ORCA BAY, AK NDB	JOHNSTONE POINT, AK VOR/DME	18000	45000
JOHNSTONE POINT, AK VOR/DME	ANCHORAGE, AK VOR/DME	18000	45000
ANCHORAGE, AK VOR/DME	GALENA, AK VOR/DME	18000	45000
<b>95.7134 JET ROUTE J134</b>			
LOS ANGELES, CA VORTAC	SEAL BEACH, CA VORTAC	18000	45000
SEAL BEACH, CA VORTAC	THERMAL, CA VORTAC	18000	45000
THERMAL, CA VORTAC	PARKER, CA VORTAC	18000	45000
PARKER, CA VORTAC	DRAKE, AZ VORTAC	18000	45000
DRAKE, AZ VORTAC	GALLUP, NM VORTAC	18000	45000
GALLUP, NM VORTAC	CIMARRON, NM VORTAC	*23000	45000
*MEA IS ESTABLISHED WITH A GAP IN NAVIGATION SIGNAL COVERAGE			
WICHITA, KS VORTAC	BUTLER, MO VORTAC	18000	45000
BUTLER, MO VORTAC	ST LOUIS, MO VORTAC	18000	45000
ST LOUIS, MO VORTAC	FALMOUTH, KY VOR/DME	18000	45000
<b>95.7135 JET ROUTE J135</b>			
BETHEL, AK VORTAC	UNALAKLEET, AK VOR/DME	18000	45000

FROM	TO	MEA	MAA
<b>95.7136 JET ROUTE J136</b>			
NEWPORT, OR VORTAC	BATTLE GROUND, WA VORTAC	18000	45000
BATTLE GROUND, WA VORTAC	YAKIMA, WA VORTAC	18000	45000
YAKIMA, WA VORTAC	SPOKANE, WA VORTAC	18000	45000
SPOKANE, WA VORTAC	MULLAN PASS, ID VOR/DME	18000	45000
MULLAN PASS, ID VOR/DME	HELENA, MT VORTAC	18000	45000
HELENA, MT VORTAC	BILLINGS, MT VORTAC	18000	45000
BILLINGS, MT VORTAC	MEDICINE BOW, WY VOR/DME	28000	45000
<b>95.7137 JET ROUTE J137</b>			
SPINNER, IL VORTAC	FARMINGTON, MO VORTAC	18000	45000
FARMINGTON, MO VORTAC	WALNUT RIDGE, AR VORTAC	18000	45000
WALNUT RIDGE, AR VORTAC	LITTLE ROCK, AR VORTAC	18000	45000
<b>95.7138 JET ROUTE J138</b>			
FORT STOCKTON, TX VORTAC	CENTER POINT, TX VORTAC	18000	45000
CENTER POINT, TX VORTAC	SAN ANTONIO, TX VORTAC	18000	45000
LAKE CHARLES, LA VORTAC	FIGHTING TIGER, LA VORTAC	18000	45000
FIGHTING TIGER, LA VORTAC	SEMMES, AL VORTAC	18000	45000
<b>95.7139 JET ROUTE J139</b>			
BETTLES, AK VOR/DME	DEADHORSE, AK VOR/DME	18000	45000
<b>95.7140 JET ROUTE J140</b>			
FARGO, ND VOR/DME	DULUTH, MN VORTAC	18000	45000
DULUTH, MN VORTAC	SAULT STE MARIE, MI VOR/DME	18000	45000
<b>95.7141 JET ROUTE J141</b>			
EL PASO, TX VORTAC	U.S. MEXICAN BORDER	18000	45000
<b>95.7143 JET ROUTE J143</b>			
POINT REYES, CA VOR/DME	MENDOCINO, CA VORTAC	18000	45000
MENDOCINO, CA VORTAC	ROSEBURG, OR VOR/DME	18000	45000
ROSEBURG, OR VOR/DME	EUGENE, OR VORTAC	18000	45000
EUGENE, OR VORTAC	KLICKITAT, OR VOR/DME	18000	45000
KLICKITAT, OR VOR/DME	SPOKANE, WA VORTAC	18000	45000
<b>95.7144 JET ROUTE J144</b>			
WOLBACH, NE VORTAC	DES MOINES, IA VORTAC	18000	45000
DES MOINES, IA VORTAC	DUBUQUE, IA VORTAC	18000	45000
<b>95.7146 JET ROUTE J146</b>			
LOS ANGELES, CA VORTAC	DAGGETT, CA VORTAC	18000	45000
DAGGETT, CA VORTAC	LAS VEGAS, NV VORTAC	18000	45000
LAS VEGAS, NV VORTAC	NOOTN, AZ FIX	18000	45000
NOOTN, AZ FIX	DOVE CREEK, CO VORTAC	*25000	45000
*MEA IS ESTABLISHED WITH A GAP IN NAVIGATION SIGNAL COVERAGE			
DOVE CREEK, CO VORTAC	BLUE MESA, CO VOR/DME	18000	45000
BLUE MESA, CO VOR/DME	GOODLAND, KS VORTAC	*23000	45000
*MEA IS ESTABLISHED WITH A GAP IN NAVIGATION SIGNAL COVERAGE			

FROM	TO	MEA	MAA
------	----	-----	-----

**95.7146 JET ROUTE J146 - CONTINUED**

GOODLAND, KS VORTAC	LINCOLN, NE VORTAC	18000	45000
LINCOLN, NE VORTAC	IOWA CITY, IA VOR/DME	18000	45000
IOWA CITY, IA VOR/DME	JOLIET, IL VOR/DME	18000	45000
JOLIET, IL VOR/DME	GIPPER, MI VORTAC	18000	45000
GIPPER, MI VORTAC	CHARDON, OH VOR/DME	18000	45000
CHARDON, OH VOR/DME	KEATING, PA VORTAC	18000	45000
KEATING, PA VORTAC	MILTON, PA VORTAC	18000	45000
MILTON, PA VORTAC	ALLENTOWN, PA VORTAC	18000	45000
ALLENTOWN, PA VORTAC	KENNEDY, NY VOR/DME	*18000	45000

\*ALLENTOWN R-104 UNUSABLE. USE KENNEDY R-287.

**95.7148 JET ROUTE J148**

COALDALE, NV VORTAC	DELTA, UT VORTAC	27000	45000
DELTA, UT VORTAC	MYTON, UT VOR/DME	18000	45000
MYTON, UT VOR/DME	CHEYENNE, WY VORTAC	*21000	45000
*MEA IS ESTABLISHED WITH A GAP IN NAVIGATION SIGNAL COVERAGE			
CHEYENNE, WY VORTAC	O'NEILL, NE VORTAC	*21000	45000
*MEA IS ESTABLISHED WITH A GAP IN NAVIGATION SIGNAL COVERAGE			
O'NEILL, NE VORTAC	MASON CITY, IA VOR/DME	18000	45000

**95.7149 JET ROUTE J149**

ARMEL, VA VOR/DME	EYTEE, WV FIX	*31000	41000
*18000 - GNSS MEA			
*ARMEL R-281 UNUSABLE BYD 119 NM. NA EXCEPT FOR AIRCRAFT EQUIPPED WITH SUITABLE RNAV SYSTEM WITH GPS.			
EYTEE, WV FIX	GEFFS, WV FIX	*31000	41000
*18000 - GNSS MEA			
*GNSS REQUIRED			
GEFFS, WV FIX	HACKS, WV FIX	*29000	41000
*18000 - GNSS MEA			
HACKS, WV FIX	ROSEWOOD, OH VORTAC	*23000	45000
*18000 - GNSS MEA			
ROSEWOOD, OH VORTAC	FORT WAYNE, IN VORTAC	18000	45000

**95.7151 JET ROUTE J151**

VULCAN, AL VORTAC	FARMINGTON, MO VORTAC	25000	41000
FARMINGTON, MO VORTAC	ST LOUIS, MO VORTAC	18000	45000
ST LOUIS, MO VORTAC	KIRKSVILLE, MO VORTAC	18000	45000
KIRKSVILLE, MO VORTAC	OMAHA, IA VORTAC	18000	45000
OMAHA, IA VORTAC	O'NEILL, NE VORTAC	18000	45000
O'NEILL, NE VORTAC	RAPID CITY, SD VORTAC	18000	45000
RAPID CITY, SD VORTAC	BILLINGS, MT VORTAC	*22000	45000
*MEA IS ESTABLISHED WITH A GAP IN NAVIGATION SIGNAL COVERAGE			
BILLINGS, MT VORTAC	WHITEHALL, MT VOR/DME	18000	45000

**95.7152 JET ROUTE J152**

ROSEWOOD, OH VORTAC	JOHNSTOWN, PA VOR/DME	18000	45000
JOHNSTOWN, PA VOR/DME	HARRISBURG, PA VORTAC	18000	40000

**95.7153 JET ROUTE J153**

ROME, OR VOR/DME	BAKER CITY, OR VOR/DME	18000	45000
BAKER CITY, OR VOR/DME	SPOKANE, WA VORTAC	18000	45000

**95.7154 JET ROUTE J154**

BATTLE MOUNTAIN, NV VORTAC	BONNEVILLE, UT VORTAC	18000	45000
----------------------------	-----------------------	-------	-------

FROM	TO	MEA	MAA
<b>95.7154 JET ROUTE J154 - CONTINUED</b>			
BONNEVILLE, UT VORTAC	WASATCH, UT VORTAC	18000	45000
WASATCH, UT VORTAC	ROCK SPRINGS, WY VOR/DME	18000	45000
ROCK SPRINGS, WY VOR/DME	MILE HIGH, CO VORTAC	*21000	45000
*MEA IS ESTABLISHED WITH A GAP IN NAVIGATION SIGNAL COVERAGE			
MILE HIGH, CO VORTAC	GARDEN CITY, KS VORTAC	21000	45000
<b>95.7155 JET ROUTE J155</b>			
CHANDALAR LAKE, AK NDB	NENANA, AK VORTAC	18000	45000
<b>95.7156 JET ROUTE J156</b>			
WILSON CREEK, NV VORTAC	MEEKER, CO VOR/DME	*18000	45000
*MEA IS ESTABLISHED WITH A GAP IN NAVIGATION SIGNAL COVERAGE			
<b>95.7157 JET ROUTE J157</b>			
MYTON, UT VOR/DME	LARAMIE, WY VOR/DME	*23000	45000
*MEA IS ESTABLISHED WITH A GAP IN NAVIGATION SIGNAL COVERAGE			
LARAMIE, WY VOR/DME	SCOTTSBLUFF, NE VORTAC	18000	45000
SCOTTSBLUFF, NE VORTAC	RAPID CITY, SD VORTAC	18000	45000
<b>95.7158 JET ROUTE J158</b>			
MINA, NV VORTAC	LUCIN, UT VORTAC	*23000	45000
*MEA IS ESTABLISHED WITH A GAP IN NAVIGATION SIGNAL COVERAGE			
LUCIN, UT VORTAC	MALAD CITY, ID VOR/DME	18000	45000
MALAD CITY, ID VOR/DME	BIG PINEY, WY VOR/DME	18000	45000
BIG PINEY, WY VOR/DME	MUDDY MOUNTAIN, WY VOR/DME	18000	45000
MUDDY MOUNTAIN, WY VOR/DME	RAPID CITY, SD VORTAC	18000	45000
RAPID CITY, SD VORTAC	ABERDEEN, SD VOR/DME	18000	45000
<b>95.7159 JET ROUTE J159</b>			
BATTLE GROUND, WA VORTAC	DESCHUTES, OR VORTAC	18000	45000
<b>95.7160 JET ROUTE J160</b>			
FAIRBANKS, AK VORTAC	FORT YUKON, AK VORTAC	18000	45000
FORT YUKON, AK VORTAC	ADREW, AK FIX	18000	45000
<b>95.7161 JET ROUTE J161</b>			
ZUNI, NM VORTAC	RATTLESNAKE, NM VORTAC	18000	45000
<b>95.7162 JET ROUTE J162</b>			
DRYER, OH VOR/DME	BELLAIRE, OH VOR/DME	18000	45000
BELLAIRE, OH VOR/DME	MORGANTOWN, WV VOR/DME	18000	45000
MORGANTOWN, WV VOR/DME	MARTINSBURG, WV VORTAC	18000	29000
<b>95.7163 JET ROUTE J163</b>			
BAKER CITY, OR VOR/DME	BOISE, ID VORTAC	18000	45000
BOISE, ID VORTAC	POCATELLO, ID VOR/DME	18000	45000
POCATELLO, ID VOR/DME	ROCK SPRINGS, WY VOR/DME	21000	45000
ROCK SPRINGS, WY VOR/DME	HAYDEN, CO VOR/DME	18000	45000
<b>95.7166 JET ROUTE J166</b>			
SAN SIMON, AZ VORTAC	TRUTH OR CONSEQUENCES, NM VORTAC	18000	45000

FROM	TO	MEA	MAA
<b>95.7166 JET ROUTE J166 - CONTINUED</b>			
TRUTH OR CONSEQUENCES, NM VORTAC	CHISUM, NM VORTAC	24000	45000
CHISUM, NM VORTAC	WICHITA FALLS, TX VORTAC	*18000	45000
*MEA IS ESTABLISHED WITH A GAP IN NAVIGATION SIGNAL COVERAGE			
<b>95.7167 JET ROUTE J167</b>			
JOHNSTONE POINT, AK VOR/DME	GULKANA, AK VOR/DME	18000	45000
GULKANA, AK VOR/DME	BIG DELTA, AK VORTAC	18000	45000
BIG DELTA, AK VORTAC	FORT YUKON, AK VORTAC	18000	45000
FORT YUKON, AK VORTAC	U.S. CANADIAN BORDER	18000	45000
<b>95.7168 JET ROUTE J168</b>			
WICHITA FALLS, TX VORTAC	LAMAR, CO VOR/DME	*22000	45000
*MEA IS ESTABLISHED WITH A GAP IN NAVIGATION SIGNAL COVERAGE			
<b>95.7169 JET ROUTE J169</b>			
LOS ANGELES, CA VORTAC	SEAL BEACH, CA VORTAC	18000	45000
SEAL BEACH, CA VORTAC	THERMAL, CA VORTAC	18000	45000
THERMAL, CA VORTAC	BLYTHE, CA VORTAC	18000	45000
BLYTHE, CA VORTAC	STANFIELD, AZ VORTAC	18000	45000
<b>95.7170 JET ROUTE J170</b>			
CRAZY WOMAN, WY VOR/DME	MUDDY MOUNTAIN, WY VOR/DME	18000	45000
MUDDY MOUNTAIN, WY VOR/DME	MEDICINE BOW, WY VOR/DME	18000	45000
<b>95.7171 JET ROUTE J171</b>			
TOBE, CO VOR/DME	HUGO, CO VOR/DME	18000	45000
<b>95.7173 JET ROUTE J173</b>			
WASATCH, UT VORTAC	MEEKER, CO VOR/DME	18000	45000
<b>95.7174 JET ROUTE J174</b>			
CHARLESTON, SC VORTAC	WILMINGTON, NC VORTAC	18000	45000
WILMINGTON, NC VORTAC	DIXON, NC NDB	18000	45000
DIXON, NC NDB	NORFOLK, VA VORTAC	18000	45000
NORFOLK, VA VORTAC	SNOW HILL, MD VORTAC	18000	45000
SNOW HILL, MD VORTAC	YAZUU, NJ FIX	18000	45000
YAZUU, NJ FIX	HAMPTON, NY VORTAC	UNUSABLE	
HAMPTON, NY VORTAC	MARCONI, MA VOR/DME	UNUSABLE	
MARCONI, MA VOR/DME	HERIN, MA FIX	UNUSABLE	
<b>95.7175 JET ROUTE J175</b>			
CHEYENNE, WY VORTAC	LARAMIE, WY VOR/DME	18000	45000
LARAMIE, WY VOR/DME	DUBOIS, ID VORTAC	*29000	45000
*MEA IS ESTABLISHED WITH A GAP IN NAVIGATION SIGNAL COVERAGE			
<b>95.7177 JET ROUTE J177</b>			
PALACIOS, TX VORTAC	U.S. MEXICAN BORDER	31000	45000
<b>95.7178 JET ROUTE J178</b>			
FORT WAYNE, IN VORTAC	APPLETON, OH VORTAC	18000	45000



FROM	TO	MEA	MAA
<b>95.7179 JET ROUTE J179</b>			
MIDDLETON ISLAND, AK VOR/DME	KENAI, AK VOR/DME	18000	45000
KENAI, AK VOR/DME	SPARREVOHN, AK VOR/DME	18000	45000
SPARREVOHN, AK VOR/DME	ANIAK, AK NDB	18000	45000
ANIAK, AK NDB	ST MARYS, AK NDB	18000	45000
ST MARYS, AK NDB	EMMONAK, AK VOR/DME	18000	45000
<b>95.7180 JET ROUTE J180</b>			
HUMBLE, TX VORTAC	DAISETTA, TX VORTAC	18000	45000
DAISETTA, TX VORTAC	CIDOR, LA FIX	18000	45000
CIDOR, LA FIX	FOSIN, LA FIX	19000	45000
FOSIN, LA FIX	SAWMILL, LA VOR/DME	18000	45000
SAWMILL, LA VOR/DME	LITTLE ROCK, AR VORTAC	18000	45000
LITTLE ROCK, AR VORTAC	FORISTELL, MO VORTAC	18000	45000
<b>95.7181 JET ROUTE J181</b>			
RANGER, TX VORTAC	OKMULGEE, OK VOR/DME	18000	45000
HALLSVILLE, MO VORTAC	BAYLI, IL FIX	18000	23000
BAYLI, IL FIX	BRADFORD, IL VORTAC	18000	45000
<b>95.7182 JET ROUTE J182</b>			
GOODLAND, KS VORTAC	WICHITA, KS VORTAC	18000	45000
WICHITA, KS VORTAC	RAZORBACK, AR VORTAC	18000	45000
<b>95.7183 JET ROUTE J183</b>			
EL PASO, TX VORTAC	PECOS, TX VOR/DME	18000	45000
PECOS, TX VOR/DME	LLANO, TX VORTAC	20000	45000
LLANO, TX VORTAC	COLLEGE STATION, TX VORTAC	18000	45000
<b>95.7184 JET ROUTE J184</b>			
BUCKEYE, AZ VORTAC	DEMING, NM VORTAC	23000	45000
DEMING, NM VORTAC	NEWMAN, TX VORTAC	18000	45000
<b>95.7187 JET ROUTE J187</b>			
MEMPHIS, TN VORTAC	FORISTELL, MO VORTAC	18000	45000
<b>95.7188 JET ROUTE J188</b>			
BETHEL, AK VORTAC	SPARREVOHN, AK VOR/DME	18000	45000
<b>95.7189 JET ROUTE J189</b>			
AVENAL, CA VOR/DME	LINDEN, CA VOR/DME	18000	45000
LINDEN, CA VOR/DME	KLAMATH FALLS, OR VORTAC	*18000	45000
*MEA IS ESTABLISHED WITH A GAP IN NAVIGATION SIGNAL COVERAGE			
KLAMATH FALLS, OR VORTAC	BATTLE GROUND, WA VORTAC	*19000	45000
*MEA IS ESTABLISHED WITH A GAP IN NAVIGATION SIGNAL COVERAGE			
BATTLE GROUND, WA VORTAC	SEATTLE, WA VORTAC	18000	45000
<b>95.7190 JET ROUTE J190</b>			
CARLETON, MI VOR/DME	SLATE RUN, PA VORTAC	*18000	45000
*FOR THAT AIRSPACE OVER U.S. TERRITORY			

FROM	TO	MEA	MAA
<b>95.7190 JET ROUTE J190 - CONTINUED</b>			
SLATE RUN, PA VORTAC	BINGHAMTON, NY VOR/DME	*18000	45000
*USE SLATE RUN R-072 TO BINGHAMTON			
BINGHAMTON, NY VOR/DME	ROCKDALE, NY VOR/DME	18000	45000
ROCKDALE, NY VOR/DME	ALBANY, NY VORTAC	18000	45000
<b>95.7191 JET ROUTE J191</b>			
HOPEWELL, VA VORTAC	WILMINGTON, NC VORTAC	18000	45000
<b>95.7192 JET ROUTE J192</b>			
GOODLAND, KS VORTAC	PAWNEE CITY, NE VORTAC	18000	45000
PAWNEE CITY, NE VORTAC	IOWA CITY, IA VOR/DME	18000	45000
<b>95.7195 JET ROUTE J195</b>			
ANNETTE ISLAND, AK VOR/DME	BIORKA ISLAND, AK VORTAC	18000	45000
<b>95.7196 JET ROUTE J196</b>			
BRYCE CANYON, UT VORTAC	MEEKER, CO VOR/DME	33000	45000
<b>95.7197 JET ROUTE J197</b>			
DOVE CREEK, CO VORTAC	HUGO, CO VOR/DME	33000	45000
HUGO, CO VOR/DME	GOODLAND, KS VORTAC	18000	45000
GOODLAND, KS VORTAC	WOLBACH, NE VORTAC	18000	45000
WOLBACH, NE VORTAC	SIoux FALLS, SD VORTAC	18000	45000
<b>95.7198 JET ROUTE J198</b>			
MINA, NV VORTAC	WILSON CREEK, NV VORTAC	18000	45000
WILSON CREEK, NV VORTAC	MEEKER, CO VOR/DME	33000	45000
<b>95.7199 JET ROUTE J199</b>			
WILSON CREEK, NV VORTAC	DELTA, UT VORTAC	18000	45000
DELTA, UT VORTAC	MEEKER, CO VOR/DME	33000	45000
<b>95.7202 JET ROUTE J202</b>			
FAIRFIELD, UT VORTAC	ROCK SPRINGS, WY VOR/DME	20000	45000
ROCK SPRINGS, WY VOR/DME	MUDDY MOUNTAIN, WY VOR/DME	18000	45000
<b>95.7203 JET ROUTE J203</b>			
BILLINGS, MT VORTAC	GREAT FALLS, MT VORTAC	18000	45000
<b>95.7204 JET ROUTE J204</b>			
DUPREE, SD VOR/DME	MILES CITY, MT VOR/DME	18000	45000
MILES CITY, MT VOR/DME	HILGR, MT FIX	19000	45000
HILGR, MT FIX	GREAT FALLS, MT VORTAC	18000	45000
<b>95.7206 JET ROUTE J206</b>			
ALAMOSA, CO VORTAC	BLUE MESA, CO VOR/DME	18000	45000
BLUE MESA, CO VOR/DME	RED TABLE, CO VOR/DME	18000	45000

FROM	TO	MEA	MAA
<b>95.7206 JET ROUTE J206 - CONTINUED</b>			
RED TABLE, CO VOR/DME	ROCK SPRINGS, WY VOR/DME	18000	45000
<b>95.7209 JET ROUTE J209</b>			
RALEIGH/DURHAM, NC VORTAC	TAR RIVER, NC VORTAC	18000	45000
TAR RIVER, NC VORTAC	NORFOLK, VA VORTAC	18000	45000
NORFOLK, VA VORTAC	SALISBURY, MD VORTAC	18000	45000
SALISBURY, MD VORTAC	COYLE, NJ VORTAC	18000	45000
COYLE, NJ VORTAC	WHITE, NJ FIX	18000	45000
<b>95.7211 JET ROUTE J211</b>			
YOUNGSTOWN, OH VORTAC	JOHNSTOWN, PA VOR/DME	18000	45000
JOHNSTOWN, PA VOR/DME	WESTMINSTER, MD VORTAC	18000	45000
<b>95.7212 JET ROUTE J212</b>			
STANFIELD, AZ VORTAC	BUCKEYE, AZ VORTAC	18000	45000
BUCKEYE, AZ VORTAC	PALM SPRINGS, CA VORTAC	26000	45000
<b>95.7213 JET ROUTE J213</b>			
BECKLEY, WV VOR/DME	ARMEL, VA VOR/DME	*18000	45000
*BECKLEY R-072 UNUSABLE			
<b>95.7217 JET ROUTE J217</b>			
HANCOCK, NY VOR/DME	KEATING, PA VORTAC	18000	45000
<b>95.7220 JET ROUTE J220</b>			
ARMEL, VA VOR/DME	STONYFORK, PA VOR/DME	*18000	23000
*ARMEL R-009 UNUSABLE BEYOND 74 NM			
<b>95.7223 JET ROUTE J223</b>			
LA GUARDIA, NY VOR/DME	CORDS, PA FIX	18000	25000
<b>95.7227 JET ROUTE J227</b>			
ARMEL, VA VOR/DME	ELMIRA, NY VOR/DME	*18000	23000
*ARMEL R-009 UNUSABLE BYD 74 NM			
*ELMIRA R-205 UNUSABLE BYD 73 NM			
<b>95.7231 JET ROUTE J231</b>			
TWENTYNINE PALMS, CA VORTAC	HIPPI, AZ FIX	23000	40000
HIPPI, AZ FIX	DRAKE, AZ VORTAC	18000	45000
DRAKE, AZ VORTAC	ST JOHNS, AZ VORTAC	18000	45000
ST JOHNS, AZ VORTAC	ANTON CHICO, NM VORTAC	18000	45000
<b>95.7232 JET ROUTE J232</b>			
MOLINE, IL VOR/DME	KIRKSVILLE, MO VORTAC	18000	35000
<b>95.7233 JET ROUTE J233</b>			
ST LOUIS, MO VORTAC	KIRKSVILLE, MO VORTAC	18000	45000

FROM	TO	MEA	MAA
<b>95.7233 JET ROUTE J233 - CONTINUED</b>			
KIRKSVILLE, MO VORTAC	WATERLOO, IA VOR/DME	18000	27000
<b>95.7236 JET ROUTE J236</b>			
THERMAL, CA VORTAC	NEEDLES, CA VORTAC	18000	45000
NEEDLES, CA VORTAC	TUBA CITY, AZ VORTAC	18000	45000
<b>95.7240 JET ROUTE J240</b>			
MYTON, UT VOR/DME	BLUE MESA, CO VOR/DME	19000	45000
<b>95.7244 JET ROUTE J244</b>			
FORT UNION, NM VORTAC	ZUNI, NM VORTAC	21000	45000
ZUNI, NM VORTAC	PHOENIX, AZ VORTAC	19000	45000
<b>95.7478 JET ROUTE J478</b>			
GLASGOW, MT VOR/DME	U.S. CANADIAN BORDER	18000	45000
<b>95.7483 JET ROUTE J483</b>			
MINOT, ND VOR/DME	U.S. CANADIAN BORDER	18000	45000
<b>95.7501 JET ROUTE J501</b>			
SAN MARCUS, CA VORTAC	BIG SUR, CA VORTAC	18000	45000
BIG SUR, CA VORTAC	POINT REYES, CA VOR/DME	18000	45000
POINT REYES, CA VOR/DME	ROGUE VALLEY, OR VORTAC	*22000	45000
*MEA IS ESTABLISHED WITH A GAP IN NAVIGATION SIGNAL COVERAGE			
ROGUE VALLEY, OR VORTAC	HOQUIAM, WA VORTAC	*22000	45000
*MEA IS ESTABLISHED WITH A GAP IN NAVIGATION SIGNAL COVERAGE			
HOQUIAM, WA VORTAC	TATOOSH, WA VORTAC	18000	45000
TATOOSH, WA VORTAC	U.S. CANADIAN BORDER	18000	45000
U.S. CANADIAN BORDER	BIORKA ISLAND, AK VORTAC	18000	45000
BIORKA ISLAND, AK VORTAC	YAKUTAT, AK VOR/DME	18000	45000
YAKUTAT, AK VOR/DME	JOHNSTONE POINT, AK VOR/DME	18000	45000
JOHNSTONE POINT, AK VOR/DME	ANCHORAGE, AK VOR/DME	18000	45000
ANCHORAGE, AK VOR/DME	SPARREVOHN, AK VOR/DME	18000	45000
SPARREVOHN, AK VOR/DME	BETHEL, AK VORTAC	18000	45000
<b>95.7502 JET ROUTE J502</b>			
SEATTLE, WA VORTAC	U.S. CANADIAN BORDER	18000	45000
U.S. CANADIAN BORDER	ANNETTE ISLAND, AK VOR/DME	22000	45000
ANNETTE ISLAND, AK VOR/DME	LEVEL ISLAND, AK VOR/DME	18000	45000
LEVEL ISLAND, AK VOR/DME	SISTERS ISLAND, AK VORTAC	18000	45000
NORTHWAY, AK VORTAC	FAIRBANKS, AK VORTAC	18000	45000
FAIRBANKS, AK VORTAC	KOTZEBUE, AK VOR/DME	*27000	45000
*MEA IS ESTABLISHED WITH A GAP IN NAVIGATION SIGNAL COVERAGE			
<b>95.7503 JET ROUTE J503</b>			
SEATTLE, WA VORTAC	U.S. CANADIAN BORDER	18000	45000
<b>95.7505 JET ROUTE J505</b>			
SEATTLE, WA VORTAC	U.S. CANADIAN BORDER	*24000	45000
*MEA IS ESTABLISHED WITH A GAP IN NAVIGATION SIGNAL COVERAGE			

FROM	TO	MEA	MAA
<b>95.7507 JET ROUTE J507</b>			
BARROW, AK VOR/DME	DEADHORSE, AK VOR/DME	18000	45000
DEADHORSE, AK VOR/DME	FORT YUKON, AK VORTAC	18000	45000
FORT YUKON, AK VORTAC	NORTHWAY, AK VORTAC	18000	45000
NORTHWAY, AK VORTAC	U.S. CANADIAN BORDER	21000	45000
U.S. CANADIAN BORDER	YAKUTAT, AK VOR/DME	22000	45000
<b>95.7511 JET ROUTE J511</b>			
DILLINGHAM, AK VOR/DME	ANCHORAGE, AK VOR/DME	21000	45000
ANCHORAGE, AK VOR/DME	GULKANA, AK VOR/DME	18000	45000
<b>95.7512 JET ROUTE J512</b>			
EMMONAK, AK VOR/DME	UNALAKLEET, AK VOR/DME	18000	45000
UNALAKLEET, AK VOR/DME	GALENA, AK VOR/DME	18000	45000
<b>95.7515 JET ROUTE J515</b>			
U.S. CANADIAN BORDER	NORTHWAY, AK VORTAC	18000	45000
NORTHWAY, AK VORTAC	FAIRBANKS, AK VORTAC	18000	45000
FAIRBANKS, AK VORTAC	BETTLES, AK VOR/DME	18000	45000
BETTLES, AK VOR/DME	BARROW, AK VOR/DME	*20000	45000
*MEA IS ESTABLISHED WITH A GAP IN NAVIGATION SIGNAL COVERAGE			
<b>95.7516 JET ROUTE J516</b>			
GREAT FALLS, MT VORTAC	U.S. CANADIAN BORDER	18000	45000
<b>95.7517 JET ROUTE J517</b>			
BOISE, ID VORTAC	SPOKANE, WA VORTAC	18000	45000
SPOKANE, WA VORTAC	U.S. CANADIAN BORDER	18000	45000
<b>95.7518 JET ROUTE J518</b>			
DRYER, OH VOR/DME	INDIAN HEAD, PA VORTAC	*18000	45000
*INDIAN HEAD R-310 UNUSABLE			
*J518 UNUSABLE FROM KOZAR TO INDIAN HEAD			
INDIAN HEAD, PA VORTAC	BALTIMORE, MD VORTAC	18000	35000
<b>95.7523 JET ROUTE J523</b>			
BRYCE CANYON, UT VORTAC	ELY, NV VOR/DME	18000	45000
ELY, NV VOR/DME	ROME, OR VOR/DME	29000	45000
ROME, OR VOR/DME	KIMBERLY, OR VOR/DME	18000	45000
KIMBERLY, OR VOR/DME	KLICKITAT, OR VOR/DME	18000	45000
KLICKITAT, OR VOR/DME	SEATTLE, WA VORTAC	18000	45000
SEATTLE, WA VORTAC	TATOOSH, WA VORTAC	18000	45000
TATOOSH, WA VORTAC	U.S. CANADIAN BORDER	18000	45000
U.S. CANADIAN BORDER	ANNETTE ISLAND, AK VOR/DME	18000	45000
<b>95.7526 JET ROUTE J526</b>			
BECKLEY, WV VOR/DME	LOUISVILLE, KY VORTAC	18000	45000
<b>95.7530 JET ROUTE J530</b>			
GREAT FALLS, MT VORTAC	U.S. CANADIAN BORDER	18000	45000

FROM	TO	MEA	MAA
<b>95.7533 JET ROUTE J533</b>			
DULUTH, MN VORTAC	U.S. CANADIAN BORDER	18000	45000
<b>95.7534 JET ROUTE J534</b>			
IWACK, WA FIX	WHATCOM, WA VORTAC	18000	45000
WHATCOM, WA VORTAC	U.S. CANADIAN BORDER	18000	45000
<b>95.7536 JET ROUTE J536</b>			
SISTERS ISLAND, AK VORTAC	U.S. CANADIAN BORDER	*21000	45000
*MEA IS ESTABLISHED WITH A GAP IN NAVIGATION SIGNAL COVERAGE			
<b>95.7537 JET ROUTE J537</b>			
ROME, OR VOR/DME	MULLAN PASS, ID VOR/DME	22000	45000
MULLAN PASS, ID VOR/DME	U.S. CANADIAN BORDER	*GNSS - 18000	45000
*GNSS REQUIRED			
*MULLAN PASS R-002 UNUSABLE			
<b>95.7538 JET ROUTE J538</b>			
U.S. CANADIAN BORDER	DULUTH, MN VORTAC	18000	45000
DULUTH, MN VORTAC	DELLS, WI VORTAC	18000	45000
DELLS, WI VORTAC	BADGER, WI VOR/DME	18000	45000
<b>95.7539 JET ROUTE J539</b>			
GLASGOW, MT VOR/DME	U.S. CANADIAN BORDER	18000	45000
<b>95.7540 JET ROUTE J540</b>			
MULLAN PASS, ID VOR/DME	U.S. CANADIAN BORDER	18000	45000
<b>95.7541 JET ROUTE J541</b>			
YAKUTAT, AK VOR/DME	SISTERS ISLAND, AK VORTAC	18000	45000
<b>95.7547 JET ROUTE J547</b>			
NORTHBROOK, IL VOR/DME	PULLMAN, MI VOR/DME	18000	45000
PULLMAN, MI VOR/DME	FLINT, MI VORTAC	18000	45000
<b>95.7548 JET ROUTE J548</b>			
PULLMAN, MI VOR/DME	TRAVERSE CITY, MI VOR/DME	18000	45000
<b>95.7549 JET ROUTE J549</b>			
WILLISTON, ND VOR/DME	U.S. CANADIAN BORDER	18000	45000
<b>95.7554 JET ROUTE J554</b>			
GIPPER, MI VORTAC	CARLETON, MI VOR/DME	18000	45000
CARLETON, MI VOR/DME	U.S. CANADIAN BORDER	18000	45000
U.S. CANADIAN BORDER	JAMESTOWN, NY VOR/DME	18000	45000
<b>95.7562 JET ROUTE J562</b>			
DICKINSON, ND VORTAC	U.S. CANADIAN BORDER	18000	45000

FROM	TO	MEA	MAA
<b>95.7569 JET ROUTE J569</b>			
GREAT FALLS, MT VORTAC	U.S. CANADIAN BORDER	18000	45000
<b>95.7584 JET ROUTE J584</b>			
NORTHBROOK, IL VOR/DME	CARLETON, MI VOR/DME	18000	45000
CARLETON, MI VOR/DME	SLATE RUN, PA VORTAC	*18000	45000
*FOR THAT AIRSPACE OVER U.S. TERRITORY			
SLATE RUN, PA VORTAC	WILLIAMSPORT, PA VOR/DME	18000	33000
WILLIAMSPORT, PA VOR/DME	BROADWAY, NJ VOR/DME	18000	31000
<b>95.7589 JET ROUTE J589</b>			
ROSEBURG, OR VOR/DME	CORVALLIS, OR VOR/DME	18000	45000
CORVALLIS, OR VOR/DME	U.S. CANADIAN BORDER	28000	45000
<b>95.7590 JET ROUTE J590</b>			
LAKE CHARLES, LA VORTAC	FIGHTING TIGER, LA VORTAC	18000	45000
FIGHTING TIGER, LA VORTAC	GREENE COUNTY, MS VORTAC	18000	45000
GREENE COUNTY, MS VORTAC	MONTGOMERY, AL VORTAC	18000	45000
<b>95.7599 JET ROUTE J599</b>			
MULLAN PASS, ID VOR/DME	U.S. CANADIAN BORDER	18000	45000
<b>95.7603 JET ROUTE J603</b>			
ELFEE, AK NDB	DILLINGHAM, AK VOR/DME	18000	45000
<b>95.7606 JET ROUTE J606</b>			
ST PAUL ISLAND, AK NDB/DME	CHINOOK, AK NDB	18000	45000
<b>95.7617 JET ROUTE J617</b>			
HOMER, AK VOR/DME	JOHNSTONE POINT, AK VOR/DME	18000	45000
<b>95.7618 JET ROUTE J618</b>			
MOUNT MOFFETT, AK NDB/DME	ELFEE, AK NDB	18000	45000
<b>95.7619 JET ROUTE J619</b>			
CAPE NEWENHAM, AK NDB/DME	ST PAUL ISLAND, AK NDB/DME	18000	45000
<b>95.7623 JET ROUTE J623</b>			
PORT HEIDEN, AK NDB/DME	COLD BAY, AK VORTAC	18000	45000
COLD BAY, AK VORTAC	ST PAUL ISLAND, AK NDB/DME	18000	45000
<b>95.7713 JET ROUTE J713</b>			
BILLINGS, MT VORTAC	BOYSEN RESERVOIR, WY VOR/DME	18000	45000
BOYSEN RESERVOIR, WY VOR/DME	BIG PINEY, WY VOR/DME	18000	45000
BIG PINEY, WY VOR/DME	WASATCH, UT VORTAC	26000	45000

AIRWAY SEGMENT		CHANGEOVER POINTS	
FROM	TO	DISTANCE	FROM

**§95.8003 VOR FEDERAL AIRWAYS CHANGEOVER POINTS**

**V1**

CRAIG, FL VORTAC	CHARLESTON, SC VORTAC	96	CRAIG
CHARLESTON, SC VORTAC	GRAND STRAND, SC VORTAC	46	CHARLESTON

**V2**

SEATTLE, WA VORTAC	ELLENSBURG, WA VOR/DME	47	SEATTLE
ELLENSBURG, WA VOR/DME	MOSES LAKE, WA VOR/DME	28	ELLENSBURG
SPOKANE, WA VORTAC	MULLAN PASS, ID VOR/DME	32	SPOKANE
MISSOULA, MT VOR/DME	HELENA, MT VORTAC	35	MISSOULA
MILES CITY, MT VOR/DME	DICKINSON, ND VORTAC	60	MILES CITY
GOPHER, MN VORTAC	NODINE, MN VORTAC	50	GOPHER

**V3**

FORT LAUDERDALE, FL VOR/DME	PALM BEACH, FL VORTAC	24	FORT LAUDERDALE
FLORENCE, SC VORTAC	SANDHILLS, NC VORTAC	20	FLORENCE
SANDHILLS, NC VORTAC	RALEIGH/DURHAM, NC VORTAC	10	SANDHILLS
MODENA, PA VORTAC	SOLBERG, NJ VOR/DME	10	MODENA

**V4**

YAKIMA, WA VORTAC	PENDLETON, OR VORTAC	26	YAKIMA
BAKER CITY, OR VOR/DME	BOISE, ID VORTAC	25	BAKER CITY
CHARLESTON, WV VOR/DME	ELKINS, WV VORTAC	27	CHARLESTON

**V5**

DUBLIN, GA VORTAC	ATHENS, GA VOR/DME	47	DUBLIN
LOUISVILLE, KY VORTAC	CINCINNATI, KY VORTAC	38	LOUISVILLE
CINCINNATI, KY VORTAC	APPLETON, OH VORTAC	64	CINCINNATI

**V6**

OAKLAND, CA VOR/DME	SACRAMENTO, CA VORTAC	34	OAKLAND
SACRAMENTO, CA VORTAC	SQUAW VALLEY, CA VOR/DME	40	SACRAMENTO
OGDEN, UT VORTAC	FORT BRIDGER, WY VOR/DME	25	OGDEN
GRAND ISLAND, NE VOR/DME	OMAHA, IA VORTAC	52	GRAND ISLAND

**V7**

SEMINOLE, FL VORTAC	WIREGRASS, AL VORTAC	53	SEMINOLE
---------------------	----------------------	----	----------

**V8**

SEAL BEACH, CA VORTAC	PARADISE, CA VORTAC	13	SEAL BEACH
PARADISE, CA VORTAC	HECTOR, CA VORTAC	44	PARADISE
HECTOR, CA VORTAC	GOFFS, CA VORTAC	38	HECTOR
HANKSVILLE, UT VORTAC	GRAND JUNCTION, CO VOR/DME	40	HANKSVILLE
GRAND JUNCTION, CO VOR/DME	RIFLE, CO VOR/DME	37	GRAND JUNCTION
RIFLE, CO VOR/DME	KREMMLING, CO VOR/DME	20	RIFLE
GRAND ISLAND, NE VOR/DME	OMAHA, IA VORTAC	52	GRAND ISLAND
MARTINSBURG, WV VORTAC	WASHINGTON, DC VOR/DME	29	MARTINSBURG



AIRWAY SEGMENT		CHANGEOVER POINTS	
FROM	TO	DISTANCE	FROM
<b>V12</b>			
PALMDALE, CA VORTAC	HECTOR, CA VORTAC	60	PALMDALE
HECTOR, CA VORTAC	NEEDLES, CA VORTAC	41	HECTOR
DRAKE, AZ VORTAC	WINSLOW, AZ VORTAC	39	DRAKE
ALBUQUERQUE, NM VORTAC	OTTO, NM VOR	23	ALBUQUERQUE
ANTON CHICO, NM VORTAC	TUCUMCARI, NM VORTAC	30	ANTON CHICO
PANHANDLE, TX VORTAC	MITBEE, OK VORTAC	46	PANHANDLE
BIBLE GROVE, IL VORTAC	SHELBYVILLE, IN VOR/DME	70	BIBLE GROVE
JOHNSTOWN, PA VOR/DME	HARRISBURG, PA VORTAC	62	JOHNSTOWN
<b>V13</b>			
CORPUS CHRISTI, TX VORTAC	BROWNSVILLE, TX VORTAC	47	CORPUS CHRISTI
LUFKIN, TX VORTAC	BELCHER, LA VORTAC	64	LUFKIN
NAPOLEON, MO VORTAC	LAMONI, IA VOR/DME	40	NAPOLEON
<b>V14</b>			
MUNCIE, IN VOR/DME	FLAG CITY, OH VORTAC	44	MUNCIE
<b>V15</b>			
CEDAR CREEK, TX VORTAC	BONHAM, TX VORTAC	20	CEDAR CREEK
<b>V16</b>			
LOS ANGELES, CA VORTAC	PARADISE, CA VORTAC	25	LOS ANGELES
PARADISE, CA VORTAC	PALM SPRINGS, CA VORTAC	34	PARADISE
BLYTHE, CA VORTAC	BUCKEYE, AZ VORTAC	44	BLYTHE
SALT FLAT, TX VORTAC	WINK, TX VORTAC	42	SALT FLAT
TEXARKANA, AR VORTAC	PINE BLUFF, AR VOR/DME	62	TEXARKANA
VOLUNTEER, TN VORTAC	HOLSTON MOUNTAIN, TN VORTAC	38	VOLUNTEER
<b>V20</b>			
MONTGOMERY, AL VORTAC	TUSKEGEE, AL VOR/DME	30	MONTGOMERY
ATHENS, GA VOR/DME	ELECTRIC CITY, SC VORTAC	20	ATHENS
<b>V21</b>			
SEAL BEACH, CA VORTAC	PARADISE, CA VORTAC	13	SEAL BEACH
PARADISE, CA VORTAC	HECTOR, CA VORTAC	44	PARADISE
HECTOR, CA VORTAC	BOULDER CITY, NV VORTAC	23	HECTOR
DUBOIS, ID VORTAC	DILLON, MT VOR/DME	46	DUBOIS
CUT BANK, MT VOR/DME	LETHBRIDGE, CA VOR/DME	39	CUT BANK
<b>V23</b>			
LOS ANGELES, CA VORTAC	GORMAN, CA VORTAC	36	LOS ANGELES
GORMAN, CA VORTAC	SHAFTER, CA VORTAC	10	GORMAN
RED BLUFF, CA VORTAC	FORT JONES, CA VOR/DME	53	RED BLUFF
ROGUE VALLEY, OR VORTAC	EUGENE, OR VORTAC	40	ROGUE VALLEY
EUGENE, OR VORTAC	BATTLE GROUND, WA VORTAC	57	EUGENE
WHATCOM, WA VORTAC	VANCOUVER, CA VOR/DME	10	WHATCOM

AIRWAY SEGMENT		CHANGEOVER POINTS	
FROM	TO	DISTANCE	FROM
<b>V25</b>			
MISSION BAY, CA VORTAC	LOS ANGELES, CA VORTAC	40	MISSION BAY
KLAMATH FALLS, OR VORTAC	DESCHUTES, OR VORTAC	23	KLAMATH FALLS
<b>V26</b>			
MONTROSE, CO VOR/DME	GRAND JUNCTION, CO VOR/DME	23	MONTROSE
MEEKER, CO VOR/DME	CHEROKEE, WY VOR/DME	35	MEEKER
MUDDY MOUNTAIN, WY VOR/DME	RAPID CITY, SD VORTAC	92	MUDDY MOUNTAIN
<b>V27</b>			
SANTA CATALINA, CA VORTAC	OCEANSIDE, CA VORTAC	31	SANTA CATALINA
GAVIOTA, CA VORTAC	MORRO BAY, CA VORTAC	20	GAVIOTA
MENDOCINO, CA VORTAC	FORTUNA, CA VORTAC	67	MENDOCINO
NEWPORT, OR VORTAC	ASTORIA, OR VOR/DME	66	NEWPORT
<b>V30</b>			
SELINGROVE, PA VOR/DME	EAST TEXAS, PA VOR/DME	20	SELINGROVE
<b>V32</b>			
BATTLE MOUNTAIN, NV VORTAC	BULLION, NV VOR/DME	24	BATTLE MOUNTAIN
BULLION, NV VOR/DME	BONNEVILLE, UT VORTAC	40	BULLION
WASATCH, UT VORTAC	FORT BRIDGER, WY VOR/DME	17	WASATCH
<b>V33</b>			
HARRISBURG, PA VORTAC	PHILIPSBURG, PA VORTAC	35	HARRISBURG
<b>V34</b>			
ROCHESTER, NY VOR/DME	HANCOCK, NY VOR/DME	60	ROCHESTER
<b>V35</b>			
ATHENS, GA VOR/DME	ELECTRIC CITY, SC VORTAC	20	ATHENS
PHILIPSBURG, PA VORTAC	STONYFORK, PA VOR/DME	25	PHILIPSBURG
<b>V37</b>			
SAVANNAH, GA VORTAC	ALLENDALE, SC VOR	36	SAVANNAH
COLUMBIA, SC VORTAC	CHARLOTTE, NC VOR/DME	26	COLUMBIA
CHARLOTTE, NC VOR/DME	PULASKI, VA VORTAC	74	CHARLOTTE
<b>V38</b>			
ELKINS, WV VORTAC	GORDONSVILLE, VA VORTAC	46	ELKINS

AIRWAY SEGMENT		CHANGEOVER POINTS	
FROM	TO	DISTANCE	FROM
<b>V39</b>			
MARTINSBURG, WV VORTAC SOARS, CT FIX	LANCASTER, PA VOR/DME ALBANY, NY VORTAC	34 8	MARTINSBURG SOARS
<b>V44</b>			
MORGANTOWN, WV VOR/DME	MARTINSBURG, WV VORTAC	53	MORGANTOWN
<b>V51</b>			
CRAIG, FL VORTAC DUBLIN, GA VORTAC	ALMA, GA VORTAC ATHENS, GA VOR/DME	48 47	CRAIG DUBLIN
<b>V59</b>			
BECKLEY, WV VOR/DME	PARKERSBURG, WV VOR/DME	46	BECKLEY
<b>V62</b>			
SANTA FE, NM VORTAC ANTON CHICO, NM VORTAC	ANTON CHICO, NM VORTAC TEXICO, TX VORTAC	30 61	SANTA FE ANTON CHICO
<b>V64</b>			
SEAL BEACH, CA VORTAC THERMAL, CA VORTAC	THERMAL, CA VORTAC BLYTHE, CA VORTAC	59 29	SEAL BEACH THERMAL
<b>V66</b>			
MISSION BAY, CA VORTAC GILA BEND, AZ VORTAC DOUGLAS, AZ VORTAC	IMPERIAL, CA VORTAC TUCSON, AZ VORTAC COLUMBUS, NM VOR/DME	39 48 *44	MISSION BAY GILA BEND DOUGLAS
*UTILIZE DEMING VORTAC 233 M MIDLAND, TX VORTAC SANDHILLS, NC VORTAC	RAD FROM COP TO ANIMA FIX ABILENE, TX VORTAC RALEIGH/DURHAM, NC VORTAC	51 10	MIDLAND SANDHILLS
<b>V67</b>			
CEDAR RAPIDS, IA VOR DME	WATERLOO, IA VOR/DME	37	CEDAR RAPIDS
<b>V68</b>			
CORONA, NM VORTAC SAN ANGELO, TX VORTAC	CHISUM, NM VORTAC JUNCTION, TX VORTAC	33 25	CORONA SAN ANGELO
<b>V71</b>			
EL DORADO, AR VOR/DME HOT SPRINGS, AR VOR/DME	HOT SPRINGS, AR VOR/DME HARRISON, AR VOR/DME	49 47	EL DORADO HOT SPRINGS
<b>V74</b>			
TULSA, OK VORTAC	FORT SMITH, AR VORTAC	48	TULSA

AIRWAY SEGMENT		CHANGEOVER POINTS	
FROM	TO	DISTANCE	FROM
<b>V77</b>			
ABILENE, TX VORTAC	WICHITA FALLS, TX VORTAC	56	ABILENE
<b>V83</b>			
CARLSBAD, NM VORTAC	CHISUM, NM VORTAC	31	CARLSBAD
CHISUM, NM VORTAC	CORONA, NM VORTAC	48	CHISUM
CORONA, NM VORTAC	OTTO, NM VOR	20	CORONA
<b>V86</b>			
MISSOULA, MT VOR/DME	COPPERTOWN, MT VOR/DME	35	MISSOULA
SHERIDAN, WY VOR/DME	RAPID CITY, SD VORTAC	100	SHERIDAN
<b>V87</b>			
SAN FRANCISCO, CA VOR DME	SCAGGS ISLAND, CA VORTAC	19	SAN FRANCISCO
<b>V91</b>			
BRIDGEPORT, CT VOR/DME	ALBANY, NY VORTAC	30	BRIDGEPORT
<b>V94</b>			
STANFIELD, AZ VORTAC	SAN SIMON, AZ VORTAC	82	STANFIELD
DEMING, NM VORTAC	NEWMAN, TX VORTAC	35	DEMING
SALT FLAT, TX VORTAC	WINK, TX VORTAC	42	SALT FLAT
MIDLAND, TX VORTAC	TUSCOLA, TX VOR/DME	51	MIDLAND
<b>V95</b>			
WINSLOW, AZ VORTAC	RATTLESNAKE, NM VORTAC	91	WINSLOW
BLUE MESA, CO VOR/DME	FALCON, CO VORTAC	*77	BLUE MESA
*USE THE HUGO (HGO) VORTAC FROM THE COP TO THE GORJE INT			
<b>V97</b>			
ST PETERSBURG, FL VORTAC	SEMINOLE, FL VORTAC	97	ST PETERSBURG
CINCINNATI, KY VORTAC	SHELBYVILLE, IN VOR/DME	39	CINCINNATI
NODINE, MN VORTAC	GOPHER, MN VORTAC	60	NODINE
<b>V101</b>			
GILL, CO VOR/DME	HAYDEN, CO VOR/DME	71	GILL
HAYDEN, CO VOR/DME	VERNAL, UT VOR/DME	56	HAYDEN
VERNAL, UT VOR/DME	WASATCH, UT VORTAC	75	VERNAL
OGDEN, UT VORTAC	BURLEY, ID VOR/DME	61	OGDEN
<b>V102</b>			
SALT FLAT, TX VORTAC	CARLSBAD, NM VORTAC	24	SALT FLAT

AIRWAY SEGMENT		CHANGEOVER POINTS	
FROM	TO	DISTANCE	FROM
<b>V103</b>			
GREENSBORO, NC VORTAC	ROANOKE, VA VOR/DME	28	GREENSBORO
<b>V105</b>			
DRAKE, AZ VORTAC	BOULDER CITY, NV VORTAC	55	DRAKE
BEATTY, NV VORTAC	COALDALE, NV VORTAC	34	BEATTY
COALDALE, NV VORTAC	MUSTANG, NV VORTAC	55	COALDALE
<b>V107</b>			
FILLMORE, CA VORTAC	AVENAL, CA VOR/DME	31	FILLMORE
AVENAL, CA VOR/DME	PANOCHÉ, CA VORTAC	45	AVENAL
<b>V111</b>			
BIG SUR, CA VORTAC	SALINAS, CA VORTAC	21	BIG SUR
SALINAS, CA VORTAC	MODESTO, CA VOR/DME	22	SALINAS
<b>V112</b>			
PENDLETON, OR VORTAC	SPOKANE, WA VORTAC	57	PENDLETON
<b>V113</b>			
MORRO BAY, CA VORTAC	PASO ROBLES, CA VORTAC	7	MORRO BAY
MUSTANG, NV VORTAC	SOD HOUSE, NV VORTAC	48	MUSTANG
BOISE, ID VORTAC	SALMON, ID VOR/DME	45	BOISE
SALMON, ID VOR/DME	COPPERTOWN, MT VOR/DME	60	SALMON
HELENA, MT VORTAC	LEWISTOWN, MT VOR/DME	40	HELENA
<b>V115</b>			
VULCAN, AL VORTAC	CHOO CHOO, TN VORTAC	59	VULCAN
<b>V120</b>			
SEATTLE, WA VORTAC	WENATCHEE, WA VOR/DME	51	SEATTLE
WENATCHEE, WA VOR/DME	EPHRATA, WA VORTAC	10	WENATCHEE
MULLAN PASS, ID VOR/DME	GREAT FALLS, MT VORTAC	80	MULLAN PASS
LEWISTOWN, MT VOR/DME	MILES CITY, MT VOR/DME	74	LEWISTOWN
MILES CITY, MT VOR/DME	DUPREE, SD VOR/DME	90	MILES CITY
SIOUX FALLS, SD VORTAC	MASON CITY, IA VOR/DME	82	SIOUX FALLS
<b>V121</b>			
KIMBERLY, OR VOR/DME	BAKER CITY, OR VOR/DME	67	KIMBERLY
<b>V123</b>			
WOODSTOWN, NJ VORTAC	ROBBINSVILLE, NJ VORTAC	19	WOODSTOWN
<b>V124</b>			
PARIS, TX VOR/DME	HOT SPRINGS, AR VOR/DME	75	PARIS
HOT SPRINGS, AR VOR/DME	LITTLE ROCK, AR VORTAC	14	HOT SPRINGS

AIRWAY SEGMENT		CHANGEOVER POINTS	
FROM	TO	DISTANCE	FROM
<b>V128</b>			
CINCINNATI, KY VORTAC	YORK, KY VORTAC	38	CINCINNATI
YORK, KY VORTAC	CHARLESTON, WV VOR/DME	29	YORK
CHARLESTON, WV VOR/DME	CASANOVA, VA VORTAC	114	CHARLESTON
<b>V133</b>			
BARRETT'S MOUNTAIN, NC VOR/DME	CHARLESTON, WV VOR/DME	77	BARRETT'S MOUNTAIN
CHARLESTON, WV VOR/DME	ZANESVILLE, OH VOR/DME	52	CHARLESTON
<b>V134</b>			
FAIRFIELD, UT VORTAC	CARBON, UT VOR/DME	20	FAIRFIELD
CARBON, UT VOR/DME	GRAND JUNCTION, CO VOR/DME	*25	CARBON
*THE COP IS AT THE SLOLM INT.			
GRAND JUNCTION, CO VOR DME	RED TABLE, CO VOR/DME	*56	GRAND JUNCTION
*THE COP IS AT THE SLOLM INT.			
<b>V135</b>			
GOFFS, CA VORTAC	BEATTY, NV VORTAC	31	GOFFS
BEATTY, NV VORTAC	COALDALE, NV VORTAC	*34	BEATTY
*COP 53 NM FROM AND UTILIZES	COALDALE, NV VORTAC ON THE 129 M RAD.		
<b>V136</b>			
VOLUNTEER, TN VORTAC	SNOWBIRD, TN VORTAC	25	VOLUNTEER
<b>V137</b>			
PALM SPRINGS, CA VORTAC	PALMDALE, CA VORTAC	30	PALM SPRINGS
GORMAN, CA VORTAC	AVENAL, CA VOR/DME	31	GORMAN
<b>V139</b>			
CAPE CHARLES, VA VORTAC	SNOW HILL, MD VORTAC	38	CAPE CHARLES
SNOW HILL, MD VORTAC	SEA ISLE, NJ VORTAC	25	SNOW HILL
HAMPTON, NY VORTAC	PROVIDENCE, RI VOR/DME	28	HAMPTON
<b>V140</b>			
PANHANDLE, TX VORTAC	BURNS FLAT, OK VORTAC	56	PANHANDLE
<b>V142</b>			
MALAD CITY, ID VOR/DME	FORT BRIDGER, WY VOR/DME	32	MALAD CITY
<b>V143</b>			
MARTINSBURG, WV VORTAC	LANCASTER, PA VOR/DME	34	MARTINSBURG

AIRWAY SEGMENT		CHANGEOVER POINTS	
FROM	TO	DISTANCE	FROM
<b>V146</b>			
ALBANY, NY VORTAC	CHESTER, MA VOR/DME	8	ALBANY
<b>V148</b>			
THURMAN, CO VORTAC	HAYES CENTER, NE VORTAC	65	THURMAN
<b>V155</b>			
SANDHILLS, NC VORTAC	RALEIGH/DURHAM, NC VORTAC	10	SANDHILLS
FLAT ROCK, VA VORTAC	BROOKE, VA VORTAC	43	FLAT ROCK
<b>V157</b>			
ALMA, GA VORTAC	ALLENDALE, SC VOR	58	ALMA
VANCE, SC VORTAC	FLORENCE, SC VORTAC	21	VANCE
WOODSTOWN, NJ VORTAC	ROBBINSVILLE, NJ VORTAC	19	WOODSTOWN
<b>V159</b>			
OCALA, FL VORTAC	CROSS CITY, FL VORTAC	28	OCALA
SPRINGFIELD, MO VORTAC	NAPOLEON, MO VORTAC	57	SPRINGFIELD
<b>V161</b>			
NAPOLEON, MO VORTAC	LAMONI, IA VOR/DME	40	NAPOLEON
INTERNATIONAL FALLS, MN VOR/DME	WINNIPEG, CA VORTAC	77	INTERNATIONAL FALLS
<b>V162</b>			
ALLENTOWN, PA VORTAC	HUGUENOT, NY VOR/DME	10	ALLENTOWN
<b>V163</b>			
BROWNSVILLE, TX VORTAC	CORPUS CHRISTI, TX VORTAC	71	BROWNSVILLE
<b>V165</b>			
MUSTANG, NV VORTAC	LAKEVIEW, OR VORTAC	70	MUSTANG
LAKEVIEW, OR VORTAC	DESCHUTES, OR VORTAC	73	LAKEVIEW
DESCHUTES, OR VORTAC	NEWBERG, OR VOR/DME	43	DESCHUTES
<b>V166</b>			
WESTMINSTER, MD VORTAC	DUPONT, DE VORTAC	40	WESTMINSTER
WOODSTOWN, NJ VORTAC	SEA ISLE, NJ VORTAC	28	WOODSTOWN
<b>V168</b>			
LAGRANGE, GA VORTAC	VULCAN, AL VORTAC	45	LAGRANGE
<b>V170</b>			
PULLMAN, MI VOR/DME	SALEM, MI VORTAC	61	PULLMAN

AIRWAY SEGMENT		CHANGEOVER POINTS	
FROM	TO	DISTANCE	FROM
<b>V181</b>			
OMAHA, IA VORTAC	NORFOLK, NE VOR/DME	51	OMAHA
<b>V182</b>			
NEWPORT, OR VORTAC	NEWBERG, OR VOR/DME	29	NEWPORT
KLICKITAT, OR VOR/DME	BAKER CITY, OR VOR/DME	119	KLICKITAT
<b>V183</b>			
SAN MARCUS, CA VORTAC	SHAFTER, CA VORTAC	20	SAN MARCUS
<b>V186</b>			
VAN NUYS, CA VOR/DME	PARADISE, CA VORTAC	39	VAN NUYS
<b>V187</b>			
ALBUQUERQUE, NM VORTAC	RATTLESNAKE, NM VORTAC	58	ALBUQUERQUE
RATTLESNAKE, NM VORTAC	GRAND JUNCTION, CO VOR/DME	90	RATTLESNAKE
GRAND JUNCTION, CO VOR/DME	ROCK SPRINGS, WY VOR/DME	86	GRAND JUNCTION
BOYSEN RESERVOIR, WY VOR/DME	BILLINGS, MT VORTAC	97	BOYSEN RESERVOIR
GREAT FALLS, MT VORTAC	MISSOULA, MT VOR/DME	84	GREAT FALLS
MISSOULA, MT VOR/DME	NEZ PERCE, ID VOR/DME	30	MISSOULA
<b>V189</b>			
WRIGHT BROTHERS, NC VOR/DME	TAR RIVER, NC VORTAC	25	WRIGHT BROTHERS
<b>V190</b>			
PHOENIX, AZ VORTAC	ST JOHNS, AZ VORTAC	67	PHOENIX
ALBUQUERQUE, NM VORTAC	FORT UNION, NM VORTAC	38	ALBUQUERQUE
<b>V191</b>			
IRONWOOD, MI VOR/DME	DULUTH, MN VORTAC	32	IRONWOOD
<b>V194</b>			
SABINE PASS, TX VOR/DME	LAFAYETTE, LA VORTAC	50	SABINE PASS
<b>V198</b>			
FORT STOCKTON, TX VORTAC	JUNCTION, TX VORTAC	*64	FORT STOCKTON
*MEA GAP AT COP HARVEY, LA VORTAC	BROOKLEY, AL VORTAC	61	HARVEY
<b>V200</b>			
WILLIAMS, CA VORTAC	MUSTANG, NV VORTAC	84	WILLIAMS
FAIRFIELD, UT VORTAC	MYTON, UT VOR/DME	32	FAIRFIELD



AIRWAY SEGMENT		CHANGEOVER POINTS	
FROM	TO	DISTANCE	FROM
<b>V201</b>			
LOS ANGELES, CA VORTAC	PALMDALE, CA VORTAC	19	LOS ANGELES
<b>V204</b>			
HOQUIAM, WA VORTAC	OLYMPIA, WA VORTAC	31	HOQUIAM
<b>V208</b>			
SANTA CATALINA, CA VORTAC	OCEANSIDE, CA VORTAC	31	SANTA CATALINA
THERMAL, CA VORTAC	TWENTYNINE PALMS, CA VORTAC	20	THERMAL
NEEDLES, CA VORTAC	PEACH SPRINGS, AZ VOR/DME	39	NEEDLES
PEACH SPRINGS, AZ VOR/DME	GRAND CANYON, AZ VOR/DME	57	PEACH SPRINGS
PAGE, AZ VOR/DME	HANKSVILLE, UT VORTAC	61	PAGE
CARBON, UT VOR/DME	MYTON, UT VOR/DME	17	CARBON
VERNAL, UT VOR/DME	CHEROKEE, WY VOR/DME	54	VERNAL
<b>V210</b>			
POMONA, CA VORTAC	HECTOR, CA VORTAC	16	POMONA
HECTOR, CA VORTAC	GOFFS, CA VORTAC	38	HECTOR
GOFFS, CA VORTAC	PEACH SPRINGS, AZ VOR/DME	42	GOFFS
PEACH SPRINGS, AZ VOR/DME	GRAND CANYON, AZ VOR/DME	57	PEACH SPRINGS
<b>V212</b>			
LUFKIN, TX VORTAC	ALEXANDRIA, LA VORTAC	65	LUFKIN
<b>V213</b>			
TAR RIVER, NC VORTAC	HOPEWELL, VA VORTAC	43	TAR RIVER
<b>V217</b>			
RHINELANDER, WI VOR/DME	DULUTH, MN VORTAC	49	RHINELANDER
<b>V218</b>			
GRAND RAPIDS, MN VOR/DME	GOPHER, MN VORTAC	46	GRAND RAPIDS
<b>V220</b>			
GRAND JUNCTION, CO VOR/DME	RIFLE, CO VOR/DME	*56	GRAND JUNCTION
*COP - THE COP IS AT THE SLOLM INT			
<b>V222</b>			
SALT FLAT, TX VORTAC	FORT STOCKTON, TX VORTAC	52	SALT FLAT
FORT STOCKTON, TX VORTAC	JUNCTION, TX VORTAC	*64	FORT STOCKTON
*MEA GAP AT COP			

AIRWAY SEGMENT		CHANGEOVER POINTS	
FROM	TO	DISTANCE	FROM
<b>V229</b>			
BRIDGEPORT, CT VOR/DME	HARTFORD, CT VOR/DME	19	BRIDGEPORT
<b>V230</b>			
SALINAS, CA VORTAC	PANOCHÉ, CA VORTAC	30	SALINAS
FRIANT, CA VORTAC	MINA, NV VORTAC	40	FRIANT
<b>V231</b>			
MISSOULA, MT VOR/DME	KALISPELL, MT VOR/DME	29	MISSOULA
<b>V235</b>			
FAIRFIELD, UT VORTAC	FORT BRIDGER, WY VOR/DME	32	FAIRFIELD
ROCK SPRINGS, WY VOR/DME	MUDDY MOUNTAIN, WY VOR/DME	65	ROCK SPRINGS
<b>V237</b>			
NEEDLES, CA VORTAC	BOULDER CITY, NV VORTAC	60	NEEDLES
<b>V240</b>			
HARVEY, LA VORTAC	BROOKLEY, AL VORTAC	61	HARVEY
<b>V243</b>			
WAYCROSS, GA VORTAC	VIENNA, GA VORTAC	30	WAYCROSS
<b>V244</b>			
COALDALE, NV VORTAC	TONOPAĤ, NV VORTAC	14	COALDALE
TONOPAĤ, NV VORTAC	WILSON CREEK, NV VORTAC	50	TONOPAĤ
WILSON CREEK, NV VORTAC	MILFORD, UT VORTAC	40	WILSON CREEK
MILFORD, UT VORTAC	HANKSVILLE, UT VORTAC	40	MILFORD
BLUE MESA, CO VOR/DME	PUEBLO, CO VORTAC	53	BLUE MESA
<b>V245</b>			
NATCHEZ, MS VOR/DME	MAGNOLIA, MS VORTAC	25	NATCHEZ
<b>V252</b>			
GENESE0, NY VOR/DME	BINGHAMTON, NY VOR/DME	34	GENESE0
<b>V253</b>			
LUCIN, UT VORTAC	TWIN FALLS, ID VORTAC	40	LUCIN
TWIN FALLS, ID VORTAC	BOISE, ID VORTAC	48	TWIN FALLS
NEZ PERCE, ID VOR/DME	PULLMAN, WA VOR/DME	13	NEZ PERCE
<b>V257</b>			
GRAND CANYON, AZ VOR/DME	BRYCE CANYON, UT VORTAC	36	GRAND CANYON
DELTA, UT VORTAC	MALAD CITY, ID VOR/DME	63	DELTA
DUBOIS, ID VORTAC	DILLON, MT VOR/DME	46	DUBOIS
DILLON, MT VOR/DME	COPPERTOWN, MT VOR/DME	27	DILLON

AIRWAY SEGMENT		CHANGEOVER POINTS	
FROM	TO	DISTANCE	FROM
<b>V258</b>			
CHARLESTON, WV VOR/DME	BECKLEY, WV VOR/DME	20	CHARLESTON
<b>V259</b>			
GRAND STRAND, SC VORTAC	FLORENCE, SC VORTAC	25	GRAND STRAND
<b>V263</b>			
SANTA FE, NM VORTAC	FORT UNION, NM VORTAC	21	SANTA FE
FORT UNION, NM VORTAC	CIMARRON, NM VORTAC	28	FORT UNION
<b>V264</b>			
POMONA, CA VORTAC	TWENTYNINE PALMS, CA VORTAC	37	POMONA
DRAKE, AZ VORTAC	WINSLOW, AZ VORTAC	39	DRAKE
<b>V265</b>			
HARRISBURG, PA VORTAC	PHILIPSBURG, PA VORTAC	35	HARRISBURG
<b>V267</b>			
DUBLIN, GA VORTAC	ATHENS, GA VOR/DME	47	DUBLIN
<b>V268</b>			
WESTMINSTER, MD VORTAC	BALTIMORE, MD VORTAC	12	WESTMINSTER
<b>V269</b>			
WELLS, NV VOR/DME	TWIN FALLS, ID VORTAC	33	WELLS
<b>V277</b>			
FORT WAYNE, IN VORTAC	KEELER, MI VOR/DME	38	FORT WAYNE
<b>V280</b>			
PANHANDLE, TX VORTAC	MITBEE, OK VORTAC	46	PANHANDLE
<b>V283</b>			
SEAL BEACH, CA VORTAC	HOMELAND, CA VOR	24	SEAL BEACH
HECTOR, CA VORTAC	BOULDER CITY, NV VORTAC	23	HECTOR
<b>V286</b>			
ELKINS, WV VORTAC	CASANOVA, VA VORTAC	43	ELKINS
BROOKE, VA VORTAC	CAPE CHARLES, VA VORTAC	22	BROOKE
<b>V287</b>			
BATTLE GROUND, WA VORTAC	OLYMPIA, WA VORTAC	41	BATTLE GROUND

AIRWAY SEGMENT		CHANGEOVER POINTS	
FROM	TO	DISTANCE	FROM
<b>V291</b>			
ALBUQUERQUE, NM VORTAC	GALLUP, NM VORTAC	44	ALBUQUERQUE
FLAGSTAFF, AZ VOR/DME	PEACH SPRINGS, AZ VOR/DME	39	FLAGSTAFF
<b>V293</b>			
ELY, NV VOR/DME	BULLION, NV VOR/DME	26	ELY
BULLION, NV VOR/DME	TWIN FALLS, ID VORTAC	66	BULLION
<b>V295</b>			
OCALA, FL VORTAC	CROSS CITY, FL VORTAC	28	OCALA
<b>V298</b>			
SEATTLE, WA VORTAC	ELLENSBURG, WA VOR/DME	47	SEATTLE
DONNELLY, ID VOR/DME	DUBOIS, ID VORTAC	109	DONNELLY
DUBOIS, ID VORTAC	DUNOIR, WY VOR/DME	68	DUBOIS
DUNOIR, WY VOR/DME	BOYSEN RESERVOIR, WY VOR/DME	15	DUNOIR
<b>V299</b>			
LOS ANGELES, CA VORTAC	VENTURA, CA VOR/DME	18	LOS ANGELES
<b>V300</b>			
SAULT STE MARIE, MI VOR/DME	THUNDER BAY, CA VOR/DME	94	SAULT STE MARIE
<b>V306</b>			
DAISETTA, TX VORTAC	LAKE CHARLES, LA VORTAC	30	DAISETTA
<b>V316</b>			
IRONWOOD, MI VOR/DME	SAWYER, MI VOR/DME	94	IRONWOOD
<b>V317</b>			
POGGI, CA VORTAC	IMPERIAL, CA VORTAC	25	POGGI
<b>V319</b>			
WORLAND, WY VOR/DME	CODY, WY VOR/DME	39	WORLAND
<b>V321</b>			
SHELBYVILLE, TN VOR/DME	LIVINGSTON, TN VOR/DME	40	SHELBYVILLE
<b>V323</b>			
MONTGOMERY, AL VORTAC	EUFAULA, AL VORTAC	32	MONTGOMERY

AIRWAY SEGMENT		CHANGEOVER POINTS	
FROM	TO	DISTANCE	FROM
<b>V324</b>			
CRAZY WOMAN, WY VOR/DME	WORLAND, WY VOR/DME	15	CRAZY WOMAN
<b>V325</b>			
COLUMBIA, SC VORTAC	ATHENS, GA VOR/DME	90	COLUMBIA
<b>V328</b>			
JACKSON, WY VOR/DME	BIG PINEY, WY VOR/DME	20	JACKSON
<b>V330</b>			
IDAHO FALLS, ID VOR/DME	JACKSON, WY VOR/DME	48	IDAHO FALLS
DUNOIR, WY VOR/DME	RIVERTON, WY VOR/DME	15	DUNOIR
<b>V336</b>			
ELLENSBURG, WA VOR/DME	EPHRATA, WA VORTAC	19	ELLENSBURG
<b>V343</b>			
DUBOIS, ID VORTAC	BOZEMAN, MT VOR/DME	60	DUBOIS
<b>V361</b>			
RATTLESNAKE, NM VORTAC	MONTROSE, CO VOR/DME	61	RATTLESNAKE
<b>V365</b>			
HELENA, MT VORTAC	CUT BANK, MT VOR/DME	51	HELENA
<b>V370</b>			
LOS ANGELES, CA VORTAC	PARADISE, CA VORTAC	25	LOS ANGELES
PARADISE, CA VORTAC	PALM SPRINGS, CA VORTAC	34	PARADISE
<b>V372</b>			
SEAL BEACH, CA VORTAC	HOMELAND, CA VOR	24	SEAL BEACH
<b>V373</b>			
GREENSBORO, NC VORTAC	SANDHILLS, NC VORTAC	43	GREENSBORO
<b>V375</b>			
ROANOKE, VA VOR/DME	GORDONSVILLE, VA VORTAC	48	ROANOKE
<b>V376</b>			
RICHMOND, VA VORTAC	WASHINGTON, DC VOR/DME	53	RICHMOND

AIRWAY SEGMENT		CHANGEOVER POINTS	
FROM	TO	DISTANCE	FROM
<b>V393</b>			
NOGALES, AZ VOR/DME	HERMOSILLO, MX VOR/DME	64	NOGALES
<b>V394</b>			
POMONA, CA VORTAC	DAGGETT, CA VORTAC	16	POMONA
DAGGETT, CA VORTAC	LAS VEGAS, NV VORTAC	59	DAGGETT
<b>V401</b>			
WORLAND, WY VOR/DME	MUDDY MOUNTAIN, WY VOR/DME	35	WORLAND
<b>V413</b>			
EAU CLAIRE, WI VORTAC	IRONWOOD, MI VOR/DME	45	EAU CLAIRE
<b>V417</b>			
ATHENS, GA VOR/DME	COLLIERS, SC VORTAC	24	ATHENS
<b>V419</b>			
MODENA, PA VORTAC	SOLBERG, NJ VOR/DME	10	MODENA
<b>V430</b>			
DEVILS LAKE, ND VOR/DME	MINOT, ND VOR/DME	40	DEVILS LAKE
DULUTH, MN VORTAC	IRONWOOD, MI VOR/DME	55	DULUTH
IRONWOOD, MI VOR/DME	IRON MOUNTAIN, MI VOR/DME	44	IRONWOOD
<b>V432</b>			
THERMAL, CA VORTAC	PARKER, CA VORTAC	30	THERMAL
<b>V433</b>			
LA GUARDIA, NY VOR/DME	BRIDGEPORT, CT VOR/DME	9	LA GUARDIA
<b>V437</b>			
ORMOND BEACH, FL VORTAC	SAVANNAH, GA VORTAC	80	ORMOND BEACH
<b>V442</b>			
HECTOR, CA VORTAC	PARKER, CA VORTAC	*41	HECTOR
*USE THE NEEDLES (EED) VORTAC FROM THE COP TO THE CLIPP INT.			
<b>V444</b>			
BAKER CITY, OR VOR/DME	BOISE, ID VORTAC	25	BAKER CITY
BOISE, ID VORTAC	POCATELLO, ID VOR/DME	66	BOISE

AIRWAY SEGMENT		CHANGEOVER POINTS	
FROM	TO	DISTANCE	FROM
<b>V448</b>			
YAKIMA, WA VORTAC	MOSES LAKE, WA VOR/DME	15	YAKIMA
SPOKANE, WA VORTAC	KALISPELL, MT VOR/DME	105	SPOKANE
<b>V452</b>			
EUGENE, OR VORTAC	KLAMATH FALLS, OR VORTAC	67	EUGENE
<b>V454</b>			
LIBERTY, NC VORTAC	LAWRENCEVILLE, VA VORTAC	82	LIBERTY
<b>V458</b>			
SANTA CATALINA, CA VORTAC	OCEANSIDE, CA VORTAC	31	SANTA CATALINA
<b>V465</b>			
BULLION, NV VOR/DME	WELLS, NV VOR/DME	25	BULLION
WELLS, NV VOR/DME	MALAD CITY, ID VOR/DME	40	WELLS
MALAD CITY, ID VOR/DME	JACKSON, WY VOR/DME	*63	MALAD CITY
*MEA GAP AT COP			
DUNOIR, WY VOR/DME	BILLINGS, MT VORTAC	45	DUNOIR
<b>V469</b>			
HARRISBURG, PA VORTAC	DUPONT, DE VORTAC	32	HARRISBURG
<b>V484</b>			
TWIN FALLS, ID VORTAC	WASATCH, UT VORTAC	59	TWIN FALLS
WASATCH, UT VORTAC	MYTON, UT VOR/DME	28	WASATCH
<b>V487</b>			
LA GUARDIA, NY VOR/DME	BRIDGEPORT, CT VOR/DME	9	LA GUARDIA
BRIDGEPORT, CT VOR/DME	BRIDGEPORT, CT VOR/DME	30	BRIDGEPORT
<b>V495</b>			
WHATCOM, WA VORTAC	VICTORIA, CA VOR/DME	10	WHATCOM
SEATTLE, WA VORTAC	VICTORIA, CA VOR/DME	50	SEATTLE
<b>V500</b>			
NEWBERG, OR VOR/DME	KIMBERLY, OR VOR/DME	79	NEWBERG
BOISE, ID VORTAC	POCATELLO, ID VOR/DME	66	BOISE
<b>V501</b>			
ST THOMAS, PA VORTAC	PHILIPSBURG, PA VORTAC	22	ST THOMAS

AIRWAY SEGMENT		CHANGEOVER POINTS	
FROM	TO	DISTANCE	FROM
<b>V502</b>			
EMPORIA, KS VORTAC	KANSAS CITY, MO VORTAC	40	EMPORIA
<b>V514</b>			
THERMAL, CA VORTAC	TWENTYNINE PALMS, CA VORTAC	20	THERMAL
GOFFS, CA VORTAC	BOULDER CITY, NV VORTAC	*60	GOFFS
*COP MEASURED FROM NEEDLES VORTAC.			
<b>V520</b>			
NEZ PERCE, ID VOR/DME	SALMON, ID VOR/DME	53	NEZ PERCE
DUBOIS, ID VORTAC	JACKSON, WY VOR/DME	60	DUBOIS
<b>V527</b>			
HOT SPRINGS, AR VOR/DME	RAZORBACK, AR VORTAC	42	HOT SPRINGS
<b>V532</b>			
SALINA, KS VORTAC	LINCOLN, NE VORTAC	51	SALINA
<b>V536</b>			
MULLAN PASS, ID VOR/DME	KALISPELL, MT VOR/DME	45	MULLAN PASS
KALISPELL, MT VOR/DME	GREAT FALLS, MT VORTAC	35	KALISPELL
<b>V569</b>			
FRANKSTON, TX VOR/DME	CEDAR CREEK, TX VORTAC	5	FRANKSTON
<b>V571</b>			
HUMBLE, TX VORTAC	NAVASOTA, TX VOR/DME	24	HUMBLE
<b>V573</b>			
HOT SPRINGS, AR VOR/DME	LITTLE ROCK, AR VORTAC	14	HOT SPRINGS
<b>V574</b>			
NAVASOTA, TX VOR/DME	HUMBLE, TX VORTAC	18	NAVASOTA
<b>V591</b>			
GRAND JUNCTION, CO VOR DME	RED TABLE, CO VOR/DME	*56	GRAND JUNCTION
*THE COP IS AT THE SLOLM INT			
<b>V611</b>			
SANTA FE, NM VORTAC	FORT UNION, NM VORTAC	21	SANTA FE
FORT UNION, NM VORTAC	CIMARRON, NM VORTAC	28	FORT UNION
CIMARRON, NM VORTAC	PUEBLO, CO VORTAC	30	CIMARRON



AIRWAY SEGMENT  
FROM TO

CHANGEOVER POINTS  
DISTANCE FROM

AIRWAY SEGMENT		CHANGEOVER POINTS	
FROM	TO	DISTANCE	FROM
<b>ALASKA V311</b>			
ANNETTE ISLAND, AK VOR DME	BIORKA ISLAND, AK VORTAC	103	ANNETTE ISLAND
<b>ALASKA V317</b>			
ANNETTE ISLAND, AK VOR DME	LEVEL ISLAND, AK VOR/DME	64	ANNETTE ISLAND
LEVEL ISLAND, AK VOR DME	SISTERS ISLAND, AK VORTAC	74	LEVEL ISLAND
<b>ALASKA V319</b>			
YAKUTAT, AK VOR/DME	JOHNSTONE POINT, AK VOR/DME	119	YAKUTAT
SPARREVOHN, AK VOR/DME	BETHEL, AK VORTAC	92	SPARREVOHN
<b>ALASKA V320</b>			
MC GRATH, AK VORTAC	ANCHORAGE, AK VOR/DME	95	MC GRATH
<b>ALASKA V321</b>			
KING SALMON, AK VORTAC	HOMER, AK VOR/DME	70	KING SALMON
<b>ALASKA V333</b>			
HOOPER BAY, AK VOR/DME	NOME, AK VOR/DME	70	HOOPER BAY
NOME, AK VOR/DME	SHISHMAREF, AK NDB	65	NOME
<b>ALASKA V401</b>			
AMBLER, AK NDB	KOTZEBUE, AK VOR/DME	40	AMBLER
KOTZEBUE, AK VOR/DME	SHISHMAREF, AK NDB	60	KOTZEBUE
<b>ALASKA V428</b>			
BIORKA ISLAND, AK VORTAC	SISTERS ISLAND, AK VORTAC	55	BIORKA ISLAND
SISTERS ISLAND, AK VORTAC	HAINES, AK NDB	21	SISTERS ISLAND
HAINES, AK NDB	WHITEHORSE, CA VOR/DME	30	HAINES
<b>ALASKA V438</b>			
KODIAK, AK VOR/DME	HOMER, AK VOR/DME	66	KODIAK
HOMER, AK VOR/DME	ANCHORAGE, AK VOR/DME	53	HOMER
<b>ALASKA V440</b>			
NOME, AK VOR/DME	UNALAKLEET, AK VOR/DME	45	NOME
MC GRATH, AK VORTAC	ANCHORAGE, AK VOR/DME	95	MC GRATH
YAKUTAT, AK VOR/DME	BIORKA ISLAND, AK VORTAC	108	YAKUTAT
BIORKA ISLAND, AK VORTAC	SANDSPIT, CA VOR/DME	134	BIORKA ISLAND

AIRWAY SEGMENT		CHANGEOVER POINTS	
FROM	TO	DISTANCE	FROM
<b>ALASKA V441</b>			
MIDDLETON ISLAND, AK VOR/DME	KENAI, AK VOR/DME	84	MIDDLETON ISLAND
<b>ALASKA V444</b>			
BARROW, AK VOR/DME	EVANSVILLE, AK NDB	105	BARROW
BETTLES, AK VOR/DME	FAIRBANKS, AK VORTAC	89	BETTLES
<b>ALASKA V447</b>			
FAIRBANKS, AK VORTAC	CHANDALAR LAKE, AK NDB	103	FAIRBANKS
<b>ALASKA V452</b>			
KUKULIAK, AK VOR/DME	NOME, AK VOR/DME	67	KUKULIAK
MOSES POINT, AK VOR/DME	GALENA, AK VOR/DME	70	MOSES POINT
GALENA, AK VOR/DME	NENANA, AK VORTAC	75	GALENA
<b>ALASKA V453</b>			
BETHEL, AK VORTAC	UNALAKLEET, AK VOR/DME	109	BETHEL
<b>ALASKA V457</b>			
ILIAMNA, AK NDB/DME	KENAI, AK VOR/DME	47	ILIAMNA
<b>ALASKA V459</b>			
EMMONAK, AK VOR/DME	ST MARYS, AK NDB	40	EMMONAK
<b>ALASKA V480</b>			
ST PAUL ISLAND, AK NDB DME	BETHEL, AK VORTAC	223	ST PAUL ISLAND
BETHEL, AK VORTAC	MC GRATH, AK VORTAC	117	BETHEL
MC GRATH, AK VORTAC	NENANA, AK VORTAC	70	MC GRATH
<b>ALASKA V481</b>			
GULKANA, AK VOR/DME	BIG DELTA, AK VORTAC	63	GULKANA
BIG DELTA, AK VORTAC	FORT YUKON, AK VORTAC	69	BIG DELTA
<b>ALASKA V488</b>			
HOOPER BAY, AK VOR/DME	HOOPER BAY, AK VOR/DME	91	HOOPER BAY
TANANA, AK VOR/DME	FAIRBANKS, AK VORTAC	40	TANANA
<b>ALASKA V496</b>			
HOOPER BAY, AK VOR/DME	ST MARYS, AK NDB	40	HOOPER BAY

AIRWAY SEGMENT		CHANGEOVER POINTS	
FROM	TO	DISTANCE	FROM
<b>ALASKA V504</b>			
NENANA, AK VORTAC	BETTLES, AK VOR/DME	67	NENANA
BETTLES, AK VOR/DME	DEADHORSE, AK VOR/DME	116	BETTLES
<b>ALASKA V506</b>			
KODIAK, AK VOR/DME	KING SALMON, AK VORTAC	55	KODIAK
KING SALMON, AK VORTAC	BETHEL, AK VORTAC	102	KING SALMON
NOME, AK VOR/DME	KOTZEBUE, AK VOR/DME	64	NOME
HOTHAM, AK NDB	BARROW, AK VOR/DME	186	HOTHAM
<b>ALASKA V508</b>			
MIDDLETON ISLAND, AK VOR/DME	KENAI, AK VOR/DME	85	MIDDLETON ISLAND
KENAI, AK VOR/DME	SPARREVOHN, AK VOR/DME	67	KENAI
SPARREVOHN, AK VOR/DME	ANIAK, AK NDB	68	SPARREVOHN
<b>ALASKA V510</b>			
EMMONAK, AK VOR/DME	ANVIK, AK NDB	69	EMMONAK
ANVIK, AK NDB	MC GRATH, AK VORTAC	87	ANVIK
<b>ALASKA V531</b>			
FAIRBANKS, AK VORTAC	TANANA, AK VOR/DME	69	FAIRBANKS
TANANA, AK VOR/DME	HUSLIA, AK VOR/DME	40	TANANA
SELAWIK, AK VOR/DME	KOTZEBUE, AK VOR/DME	30	SELAWIK
KOTZEBUE, AK VOR/DME	POINT HOPE, AK NDB	116	KOTZEBUE
<b>ALASKA V603</b>			
ELFEE, AK NDB	DILLINGHAM, AK VOR/DME	207	ELFEE
<b>ALASKA V617</b>			
HOMER, AK VOR/DME	JOHNSTONE POINT, AK VOR/DME	63	HOMER

AIRWAY SEGMENT		CHANGEOVER POINTS	
FROM	TO	DISTANCE	FROM
<b>HAWAII V15</b>			
MOLOKAI, HI VORTAC	MAUI, HI VORTAC	31	MOLOKAI
<b>HAWAII V16</b>			
LANAI, HI VORTAC	UPOLU POINT, HI VORTAC	47	LANAI

AIRWAY SEGMENT		CHANGEOVER POINTS	
FROM	TO	DISTANCE	FROM

**§95.8005 JET ROUTES CHANGEOVER POINTS**

<b>J1</b>			
ROGUE VALLEY, OR VORTAC	BATTLE GROUND, WA VORTAC	90	ROGUE VALLEY
<b>J5</b>			
LAKEVIEW, OR VORTAC	SEATTLE, WA VORTAC	156	LAKEVIEW
<b>J6</b>			
DRAKE, AZ VORTAC	ZUNI, NM VORTAC	76	DRAKE
MARTINSBURG, WV VORTAC	LANCASTER, PA VOR/DME	24	MARTINSBURG
<b>J8</b>			
GALLUP, NM VORTAC	FORT UNION, NM VORTAC	103	GALLUP
<b>J10</b>			
BLUE MESA, CO VOR/DME	FALCON, CO VORTAC	50	BLUE MESA
<b>J15</b>			
RATTLESNAKE, NM VORTAC	GRAND JUNCTION, CO VOR/DME	90	RATTLESNAKE
<b>J16</b>			
BATTLE GROUND, WA VORTAC	PENDLETON, OR VORTAC	60	BATTLE GROUND
<b>J17</b>			
CHEYENNE, WY VORTAC	RAPID CITY, SD VORTAC	90	CHEYENNE
<b>J18</b>			
PHOENIX, AZ VORTAC	ST JOHNS, AZ VORTAC	88	PHOENIX
MOLINE, IL VOR/DME	JOLIET, IL VOR/DME	45	MOLINE
<b>J19</b>			
ROBERTS, IL VOR/DME	NORTHBROOK, IL VOR/DME	40	ROBERTS
<b>J20</b>			
POCATELLO, ID VOR/DME	ROCK SPRINGS, WY VOR/DME	82	POCATELLO
<b>J21</b>			
GOPHER, MN VORTAC	DULUTH, MN VORTAC	81	GOPHER

AIRWAY SEGMENT		CHANGEOVER POINTS	
FROM	TO	DISTANCE	FROM
<b>J24</b>			
HUGO, CO VOR/DME	HAYS, KS VORTAC	80	HUGO
<b>J32</b>			
ABERDEEN, SD VOR/DME	DULUTH, MN VORTAC	130	ABERDEEN
<b>J37</b>			
KENNEDY, NY VOR/DME	KINGSTON, NY VOR/DME	37	KENNEDY
<b>J44</b>			
FALCON, CO VORTAC	MC COOK, NE VOR/DME	90	FALCON
MC COOK, NE VOR/DME	LINCOLN, NE VORTAC	51	MC COOK
<b>J48</b>			
CASANOVA, VA VORTAC	MONTEBELLO, VA VOR/DME	58	CASANOVA
<b>J54</b>			
OLYMPIA, WA VORTAC	BAKER CITY, OR VOR/DME	143	OLYMPIA
POCATELLO, ID VOR/DME	CHEROKEE, WY VOR/DME	95	POCATELLO
<b>J55</b>			
BOSTON, MA VOR/DME	KENNEBUNK, ME VOR/DME	38	BOSTON
<b>J56</b>			
WASATCH, UT VORTAC	HAYDEN, CO VOR/DME	*66	WASATCH
*USE GILL (GLL) VOR/DME FROM	COP TO RIDJE INT		
HAYDEN, CO VOR/DME	GILL, CO VOR/DME	*55	HAYDEN
*USE GILL (GLL) VOR/DME FROM	COP TO RIDJE INT		
<b>J58</b>			
COALDALE, NV VORTAC	WILSON CREEK, NV VORTAC	44	COALDALE
MILFORD, UT VORTAC	RATTLESNAKE, NM VORTAC	92	MILFORD
<b>J60</b>			
HANKSVILLE, UT VORTAC	RED TABLE, CO VOR/DME	75	HANKSVILLE
RED TABLE, CO VOR/DME	MILE HIGH, CO VORTAC	39	RED TABLE
GOSHEN, IN VORTAC	DRYER, OH VOR/DME	90	GOSHEN
<b>J64</b>			
RATTLESNAKE, NM VORTAC	PUEBLO, CO VORTAC	93	RATTLESNAKE
PUEBLO, CO VORTAC	HILL CITY, KS VORTAC	80	PUEBLO
FORT WAYNE, IN VORTAC	ELLWOOD CITY, PA VOR/DME	112	FORT WAYNE

AIRWAY SEGMENT		CHANGEOVER POINTS	
FROM	TO	DISTANCE	FROM
<b>J70</b>			
DICKINSON, ND VORTAC	ABERDEEN, SD VOR/DME	60	DICKINSON
<b>J71</b>			
CENTRALIA, IL VORTAC	ROBERTS, IL VOR/DME	98	CENTRALIA
ROBERTS, IL VOR/DME	NORTHBROOK, IL VOR/DME	40	ROBERTS
<b>J78</b>			
DRAKE, AZ VORTAC	ZUNI, NM VORTAC	76	DRAKE
<b>J79</b>			
FRANKLIN, VA VORTAC	SALISBURY, MD VORTAC	20	FRANKLIN
<b>J80</b>			
COALDALE, NV VORTAC	WILSON CREEK, NV VORTAC	44	COALDALE
MILFORD, UT VORTAC	GRAND JUNCTION, CO VOR/DME	50	MILFORD
<b>J82</b>			
BATTLE GROUND, WA VORTAC	DONNELLY, ID VOR/DME	90	BATTLE GROUND
RAPID CITY, SD VORTAC	SIOUX FALLS, SD VORTAC	125	RAPID CITY
<b>J83</b>			
APPLETON, OH VORTAC	DRYER, OH VOR/DME	75	APPLETON
<b>J84</b>			
NORTHBROOK, IL VOR/DME	DANVILLE, IL VORTAC	67	NORTHBROOK
<b>J86</b>			
HUMBLE, TX VORTAC	LEEVILLE, LA VORTAC	135	HUMBLE
<b>J87</b>			
MOLINE, IL VOR/DME	JOLIET, IL VOR/DME	45	MOLINE
<b>J88</b>			
SAN MARCUS, CA VORTAC	SALINAS, CA VORTAC	71	SAN MARCUS
<b>J90</b>			
HELENA, MT VORTAC	MILES CITY, MT VOR/DME	115	HELENA
<b>J92</b>			
BEATTY, NV VORTAC	BOULDER CITY, NV VORTAC	12	BEATTY



AIRWAY SEGMENT		CHANGEOVER POINTS	
FROM	TO	DISTANCE	FROM
<b>J94</b>			
ROCK SPRINGS, WY VOR DME	SCOTTSBLUFF, NE VORTAC	105	ROCK SPRINGS
<b>J96</b>			
DRAKE, AZ VORTAC	GALLUP, NM VORTAC	77	DRAKE
GALLUP, NM VORTAC	CIMARRON, NM VORTAC	146	GALLUP
<b>J107</b>			
MILFORD, UT VORTAC	ROCK SPRINGS, WY VOR/DME	120	MILFORD
<b>J110</b>			
BELLAIRE, OH VOR/DME	COYLE, NJ VORTAC	132	BELLAIRE
<b>J116</b>			
MEEKER, CO VOR/DME	FALCON, CO VORTAC	60	MEEKER
<b>J121</b>			
CHARLESTON, SC VORTAC	KINSTON, NC VORTAC	128	CHARLESTON
SNOW HILL, MD VORTAC	SEA ISLE, NJ VORTAC	20	SNOW HILL
<b>J126</b>			
SAN MARCUS, CA VORTAC	SALINAS, CA VORTAC	71	SAN MARCUS
<b>J128</b>			
BLUE MESA, CO VOR/DME	FALCON, CO VORTAC	50	BLUE MESA
<b>J130</b>			
MC COOK, NE VOR/DME	PAWNEE CITY, NE VORTAC	72	MC COOK
<b>J134</b>			
DRAKE, AZ VORTAC	GALLUP, NM VORTAC	77	DRAKE
GALLUP, NM VORTAC	CIMARRON, NM VORTAC	146	GALLUP
<b>J136</b>			
YAKIMA, WA VORTAC	SPOKANE, WA VORTAC	50	YAKIMA
MULLAN PASS, ID VOR/DME	HELENA, MT VORTAC	100	MULLAN PASS
BILLINGS, MT VORTAC	MEDICINE BOW, WY VOR/DME	149	BILLINGS
<b>J140</b>			
DULUTH, MN VORTAC	SAULT STE MARIE, MI VOR/DME	171	DULUTH

AIRWAY SEGMENT		CHANGEOVER POINTS	
FROM	TO	DISTANCE	FROM
<b>J143</b>			
MENDOCINO, CA VORTAC	ROSEBURG, OR VOR/DME	150	MENDOCINO
<b>J152</b>			
JOHNSTOWN, PA VOR/DME	HARRISBURG, PA VORTAC	62	JOHNSTOWN
<b>J153</b>			
ROME, OR VOR/DME	BAKER CITY, OR VOR/DME	120	ROME
BAKER CITY, OR VOR/DME	SPOKANE, WA VORTAC	60	BAKER CITY
<b>J154</b>			
WASATCH, UT VORTAC	ROCK SPRINGS, WY VOR/DME	35	WASATCH
ROCK SPRINGS, WY VOR/DME	GILL, CO VOR/DME	104	ROCK SPRINGS
<b>J157</b>			
MYTON, UT VOR/DME	LARAMIE, WY VOR/DME	112	MYTON
<b>J163</b>			
POCATELLO, ID VOR/DME	ROCK SPRINGS, WY VOR/DME	82	POCATELLO
<b>J173</b>			
WASATCH, UT VORTAC	MEEKER, CO VOR/DME	47	WASATCH
<b>J174</b>			
SNOW HILL, MD VORTAC	HAMPTON, NY VORTAC	106	SNOW HILL
<b>J180</b>			
SAWMILL, LA VOR/DME	LITTLE ROCK, AR VORTAC	105	SAWMILL
LITTLE ROCK, AR VORTAC	FORISTELL, MO VORTAC	118	LITTLE ROCK
<b>J181</b>			
RANGER, TX VORTAC	OKMULGEE, OK VOR/DME	139	RANGER
<b>J183</b>			
LLANO, TX VORTAC	COLLEGE STATION, TX VORTAC	93	LLANO
<b>J187</b>			
MEMPHIS, TN VORTAC	FORISTELL, MO VORTAC	96	MEMPHIS
<b>J189</b>			
KLAMATH FALLS, OR VORTAC	BATTLE GROUND, WA VORTAC	78	KLAMATH FALLS

AIRWAY SEGMENT		CHANGEOVER POINTS	
FROM	TO	DISTANCE	FROM
<b>J197</b>			
DOVE CREEK, CO VORTAC	HUGO, CO VOR/DME	105	DOVE CREEK
<b>J209</b>			
NORFOLK, VA VORTAC	SALISBURY, MD VORTAC	42	NORFOLK
<b>J220</b>			
ARMEL, VA VOR/DME	STONYFORK, PA VOR/DME	122	ARMEL
<b>J233</b>			
KIRKSVILLE, MO VORTAC	WATERLOO, IA VOR/DME	78	KIRKSVILLE
<b>J236</b>			
THERMAL, CA VORTAC	NEEDLES, CA VORTAC	53	THERMAL
NEEDLES, CA VORTAC	TUBA CITY, AZ VORTAC	72	NEEDLES
<b>J240</b>			
MYTON, UT VOR/DME	BLUE MESA, CO VOR/DME	60	MYTON
<b>J244</b>			
FORT UNION, NM VORTAC	ZUNI, NM VORTAC	86	FORT UNION
<b>J501</b>			
BIORKA ISLAND, AK VORTAC	SANDSPIT, CA VOR/DME	153	BIORKA ISLAND
YAKUTAT, AK VOR/DME	BIORKA ISLAND, AK VORTAC	108	YAKUTAT
JOHNSTONE POINT, AK VOR/DME	YAKUTAT, AK VOR/DME	100	JOHNSTONE POINT
<b>J502</b>			
SEATTLE, WA VORTAC	VICTORIA, CA VOR/DME	50	SEATTLE
<b>J503</b>			
SEATTLE, WA VORTAC	PRINCETON, CA VORTAC	108	SEATTLE
<b>J505</b>			
SEATTLE, WA VORTAC	CRANBROOK, CA VOR/DME	108	SEATTLE
<b>J515</b>			
BETTLES, AK VOR/DME	BARROW, AK VOR/DME	130	BETTLES

AIRWAY SEGMENT		CHANGEOVER POINTS	
FROM	TO	DISTANCE	FROM
<b>J517</b>			
BOISE, ID VORTAC	SPOKANE, WA VORTAC	100	BOISE
<b>J518</b>			
INDIAN HEAD, PA VORTAC	BALTIMORE, MD VORTAC	20	INDIAN HEAD
<b>J523</b>			
ELY, NV VOR/DME	BRYCE CANYON, UT VORTAC	20	ELY
<b>J589</b>			
CORVALLIS, OR VOR/DME	VICTORIA, CA VOR/DME	100	CORVALLIS
<b>J713</b>			
BIG PINEY, WY VOR/DME	WASATCH, UT VORTAC	94	BIG PINEY

## Appendix 2. FAA Form 7233-4 – International Flight Plan

**a.** The FAA will accept a flight plan in international format for IFR, VFR, SFRA, and DVFR flights. File the flight plan electronically via a Flight Service Station (FSS), FAA contracted flight plan filing service, or other commercial flight plan filing service. Depending on the filing service chosen, the method of entering data may be different but the information required is generally the same.

**b.** The international flight plan format is mandatory for:

**1.** Any flight plan filed through a FSS or FAA contracted flight plan filing service; with the exception of Department of Defense flight plans and civilian stereo route flight plans, which can still be filed using the format prescribed in FAA Form 7233-1.

**NOTE-**

*DOD Form DD-175 and FAA Form 7233-1 are considered to follow the same format.*

**2.** Any flight that will depart U.S. domestic airspace. For DOD flight plan purposes, offshore Warning Areas may use FAA Form 7233-1 or military equivalent.

**3.** Any flight requesting routing that requires Performance Based Navigation.

**4.** Any flight requesting services that require filing of capabilities only supported in the international flight plan format.

**c.** Flight Plan Contents

**1.** A flight plan will include information shown below:

**(a)** Flight Specific Information (TBL 2-1)

**(b)** Aircraft Specific Information (TBL 2-19)

**(c)** Flight Routing Information (TBL 2-20)

**(d)** Flight Specific Supplementary Information (Item 19)

**2.** The tables indicate where the information is located in the international flight plan format, the information required for U.S. domestic flights, and the location of equivalent information in the domestic flight plan format.

**3.** International flights, including those that temporarily leave domestic U.S. airspace and return, require all applicable information in the international flight plan. Additional information can be found in ICAO Doc. 4444 (Procedures for Air Navigation Services, Air Traffic Management), and ICAO Doc. 7030 (Regional Supplemental Procedures) as well as the Aeronautical Information Publications (AIPs), Aeronautical Information Circulars (AICs), and NOTAMs of applicable other countries.

**TBL 2-1**  
**Flight Specific Information**

Item	International Flight Plan (FAA Form 7233-4)	Domestic U.S. Requirements	Equivalent Item on Domestic Flight Plan (FAA Form 7233-1)
Aircraft Identification	Item 7	Required	Item 2
Flight Rules	Item 8	Required	Item 1
Type of Flight	Item 8	No need to file for domestic U.S. flight	N/A
Equipment and Capabilities	Item 10 Item 18 PBN/; NAV/; COM/; DAT/; SUR/	Required	Item 3
Date of Flight	Item 18 DOF/	Include when date of flight is not today	N/A
Reasons for Special Handling	Item 18 STS/; RMK/	Include when special category is applicable	Item 11
Remarks	Item 18 RMK/	Include when necessary	Item 11
Operator	Item 18 OPR/	No need to file for domestic U.S. flight	N/A
Flight Plan Originator	Item 18 ORGN/	No need to file for domestic U.S. flight	N/A

**d. Instructions for Flight-Specific Information Items**

**1. Aircraft Identification (Item 7)** Aircraft Identification is always required. Aircraft identification must not exceed seven alphanumeric characters and be either:

(a) The ICAO designator for the aircraft operating agency, followed by the flight identification (for example, KLM511, NGA213, JTR25). When in radiotelephony the call sign to be used by the aircraft will consist of the ICAO telephony designator for the operating agency followed by the flight identification (for example, KLM511, NIGERIA213, JESTER25);

(b) The nationality or common mark and registration of the aircraft (for example, EIAKO, 4XBCD, N2567GA), when:

(1) In radiotelephony, the call sign to be used by the aircraft will consist of this identification alone (for example, CGAJS) or preceded by the ICAO telephony designator for the aircraft operating agency (for example, BLIZZARD CGAJS); or

(2) The aircraft is not equipped with radio.

**NOTE-**

**1. Standards for nationality, common and registration marks to be used are contained in Annex 7, Chapter 2.**

**2. Provisions for using radiotelephony call signs are contained in Annex 10, Volume II, Chapter 5. ICAO designators and telephony designators for aircraft operating agencies are contained in Doc 8585—Designators for Aircraft Operating Agencies, Aeronautical Authorities and Services.**

**NOTE-**

*Some countries' aircraft identifications begin with a number, which cannot be processed by U.S. ATC automation. The FAA will add a leading letter temporarily to gain automation acceptance for aircraft identifications that begin with a numeral. For flight-processing systems (e.g., ERAM or STARS) which will not accept a call sign that begins with a number, if the call sign is 6 characters or less, add a Q at the beginning of the call sign. If the call sign is 7 characters, delete the first character and replace it with a Q. Put the original call sign in the remarks section of the flight plan.*

**EXAMPLE-**

9HRA becomes Q9HRA  
5744233 becomes Q744233

**2. Flight Rules (Item 8a)**

(a) Flight rules are always required.

(b) Flight rules must indicate IFR (I) or VFR (V).

(c) For composite flight plans, submit separate flight plans for the IFR and VFR portions of the flight. Specify in Item 15 the point or points where change of flight rules is planned. The IFR plan will be routed to ATC, and the VFR plan will be routed to a Flight Service for Search and Rescue services.

**NOTE-**

*The pilot is responsible for opening and closing the VFR flight plan. ATC does not have knowledge of a VFR flight plan's status.*

**3. Type of Flight (Item 8b)**

(a) The type of flight is optional for flights remaining wholly within U.S. domestic airspace.

(b) Indicate the type of flight as follows:

- G – General Aviation
- S – Scheduled Air Service
- N – Non-Scheduled Air Transport Operation
- M – Military
- X – other than any of the defined categories above

**4. Equipment and Capabilities (Item 10, Item 18 NAV/, COM/, DAT/, SUR/)**

(a) Equipment and capabilities that can be filed in a flight plan include:

- Navigation capabilities in Item 10a, Item 18 PBN/, and Item 18 NAV/
- Voice communication capabilities in Item 10a and Item 18 COM/
- Data communication capabilities in Item 10a and Item 18 DAT/
- Approach capabilities in Item 10a and Item 18 NAV/
- Surveillance capabilities in Item 10b and Item 18 SUR/

(b) Codes allowed in Item 10a are shown in Table 2-2. Codes allowed in Item 10b are shown in TBL 2-3. Codes recognized in Item 18 NAV/, COM/, DAT/, and SUR/ are shown in TBL 2-4. Note that other service providers may define additional allowable (and required) codes for use in Item 18 NAV/, COM/, DAT/, or SUR/. Codes to designate PBN capability are described in TBL 2-5.

**Radio communication, navigation and approach aid equipment and capabilities**

*ENTER* one letter as follows:

N if no COM/NAV/approach aid equipment for the route to be flown is carried, or the equipment is unserviceable,

OR

S if standard COM/NAV/approach aid equipment for the route to be flown is carried and serviceable (see Note 1),

AND/OR

*ENTER* one or more of the following letters from TBL 2-2 to indicate the serviceable COM/NAV/ approach aid equipment and capabilities available.

TBL 2-2

**Item 10a Navigation, Communication, and Approach Aid Capabilities**

A	GBAS Landing System	J7	CPDLC FANS 1/A SATCOM (Iridium)
B	LPV (APV with SBAS)	K	MLS
C	LORAN C	L	ILS
D	DME	M1	ATC SATVOICE (INMARSAT)
E1	FMC WPR ACARS	M2	Reserved
E2	D-FIS ACARS	M3	ATC RTF (Iridium)
E3	PDC ACARS	O	VOR
F	ADF	P1	CPDLC RCP 400 (See Note 7)
G	GNSS (See Note 2)	P2	CPDLC RCP 240 (See Note 7)
H	HF RTF	P3	SATVOICE RCP 400 (See Note 7)
I	Inertial Navigation	P4-P9	Reserved for RCP
J1	CPDLC ATN VDL Mode 2 (See Note 3)	R	PBN Approved (See Note 4)
J2	CPDLC FANS 1/A HFDL	T	TACAN
J3	CPDLC FANS 1/A VDL Mode A	U	UHF RTF
J4	CPDLC FANS 1/A Mode 2	V	VHF RTF
J5	CPDLC FANS 1/A SATCOM (INMARSAT)	W	RVSM Approved
J6	Reserved	X	MNPS Approved /North Atlantic (NAT) High Level Airspace (HLA) approved
		Y	VHF with 8.33 kHz Channel Spacing Capability
		Z	Other equipment carried or other capabilities (See Note 5)

Any alphanumeric characters not indicated above are reserved.

**NOTE-**

1. If the letter "S" is used, standard equipment is considered to be VHF RTF, VOR, and ILS, unless another combination is prescribed by the appropriate ATS authority.
2. If the letter "G" is used, the types of external GNSS augmentation, if any, are specified in Item 18 following the indicator NAV/ and separated by a space.

**EXAMPLE-**

NAV/SBAS

3. See RTCA/EUROCAE Interoperability Requirements Standard for ATN Baseline 1 (ATN B1 INTEROP Standard – DO-280B/ED-110B) for data link services air traffic control clearance and information/air traffic control communications management/air traffic control microphone check.
4. If the letter "R" is used, the performance-based navigation levels that can be met are specific in Item 18 following the indicator PBN/. Guidance material on the application of performance-based navigation to a specific route segment, route, or area is contained in the Performance-based Navigation (PBN) Manual (Doc 9613)
5. If the letter "Z" is used, specify in Item 18 the other equipment carried or other capabilities, preceded by COM/, NAV/, and/or DAT, as appropriate.
6. Information on navigation capability is provided to ATC for clearance and routing purposes.
7. Guidance on the application of performance-based communication, which prescribes RCP to an air traffic service in a specific area, is contained in the Performance-based Communication and Surveillance (PBCS) Manual (Doc 9869).



**TBL 2-3**  
**Item 10b Surveillance Capabilities**

*ENTER* "N" if no surveillance equipment for the route to be flown is carried, or the equipment is unserviceable,  
or

*ENTER* One or more of the following descriptors, to a maximum of 20 characters, to describe the serviceable surveillance equipment and/or capabilities on board.

*ENTER* no more than one transponder code (Modes A, C, or S)

**SSR Modes A and C:**

A	Transponder	Mode A (4 digits – 4096 codes)
C	Transponder	Mode A (4 digits – 4096 codes) and Mode C

**SSR Mode S:**

E	Transponder	Mode S, including aircraft identification, pressure–altitude, and extended squitter (ADS–B) capability
H	Transponder	Mode S, including aircraft identification, pressure–altitude, and enhanced surveillance capability
I	Transponder	Mode S, including aircraft identification, but no pressure–altitude capability
L	Transponder	Mode S, including aircraft identification, pressure–altitude, extended squitter (ADS–B),

and enhanced surveillance capability

P	Transponder	Mode S, including pressure–altitude, but no aircraft identification capability
S	Transponder	Mode S, including both pressure–altitude and aircraft identification capability
X	Transponder	Mode S, with neither aircraft identification nor pressure–altitude

**NOTE–**

*Enhanced surveillance capability is the ability of the aircraft to down–link aircraft derived data via Mode S transponder.*

**ADS–B:**

B1	ADS–B with dedicated 1090 MHz ADS–B “out” capability
B2	ADS–B with dedicated 1090 MHz ADS–B “out” and “in” capability
U1	ADS–B with “out” capability using UAT
U2	ADS–B with “out” and “in” capability using UAT
V1	ADS–B with “out” capability using VDL Mode 4
V2	ADS–B with “out” and “in” capability using VDL Mode 4

**NOTE–**

*File no more than one code for each type of capability, e.g., file B1 or B2 and not both*

**ADS–C:**

D1	ADS–C with FANS 1/A capabilities
G1	ADS–C with ATN capabilities

Alphanumeric characters not included above are reserved.

**EXAMPLE–**

**ADE3RV/HB2U2V2G1**

**NOTE–**

- 1. The RSP specification(s), if applicable, will be listed in Item 18 following the indicator SUR/, using the characters “RSP” followed by the specifications value. Currently RSP180 and RSP400 are in use.*
- 2. List additional surveillance equipment or capabilities in Item 18 following the indicator SUR/.*

**TBL 2-4**  
**Item 18 NAV/, COM/, DAT/, and SUR/ capabilities used by FAA**

Item	Purpose	Entry	Explanation
NAV/ entries used by FAA	Radius-to-Fix (RF) capability	Z1	RNP-capable flight is authorized for Radius to Fix operations.
	Fixed Radius Transitions (FRT)	Z2	RNP-capable flight is authorized for Fixed Radius Transitions.
	Time of Arrival Control (TOAC)	Z5	RNP-capable flight is authorized for Time of Arrival Control.
	Advanced RNP (A-RNP)	P1	Flight is authorized for A-RNP operations.
	Helicopter RNP 0.3	R1	Flight is authorized for RNP 0.3 operations (pertains to helicopters only).
	RNP 2 Continental	M1	Flight is authorized for RNP 2 continental operations.
	RNP 2 Oceanic/Remote	M2	Flight is authorized for RNP 2 oceanic/remote operations.
COM/ entries used by FAA	N/A	N/A	The FAA currently does not use any entries in COM/.
DAT/ entries used by FAA	Capability and preference for delivery of pre-departure clearance	Priority number followed by: <ul style="list-style-type: none"> <li>• FANS</li> <li>• FANSP</li> <li>• PDC</li> <li>• VOICE</li> </ul>	Entries are combined with a priority number, for example; 1FANS2PDC means a preference for departure clearance delivered via FANS 1/A; with capability to also receive the clearance via ACARS PDC. FANS = FANS 1/A DCL FANSP = FANS 1/A+ DCL PDC = ACARS PDC VOICE = PDC via voice (no automated delivery)
SUR/ entries used by FAA	Req. Surveillance Performance	RSP180	Aircraft is authorized for Required Surveillance Performance RSP180
		RSP400	Aircraft is authorized for Required Surveillance Performance RSP400
	ADS-B	260B	Aircraft has 1090 MHz Extended Squitter ADS-B compliant with RTCA DO-260B (complies with FAA requirements)
		282B	Aircraft has 978 MHz UAT ADS-B compliant with RTCA DO-282B (complies with FAA requirements)

**NOTE-**

1. Other entries in NAV/, COM/, DAT/, and SUR/ are permitted for international flights when instructed by other service providers. Direction on use of these capabilities by the FAA is detailed in the following sections.
2. In NAV/, descriptors for advanced capabilities (Z1, P1, R1, M1, and M2) should be entered as a single character string with no intervening spaces, and separated from any other entries in NAV/ by a space.

**EXAMPLE-**

NAV/Z1P1M2 SBAS

TBL 2-5

**Item 18. PBN/ Specifications**

(Include as many of the applicable descriptors, up to a maximum of 8 entries (not more than 16 characters).

PBN/ RNAV SPECIFICATIONS	
A1	RNAV 10 (RNP 10)
B1	RNAV 5 all permitted sensors
B2	RNAV 5 GNSS
B3	RNAV 5 DME/DME
B4	RNAV 5 VOR/DME
B5	RNAV 5 INS or IRS
B6	RNAV 5 LORAN C
C1	RNAV 2 all permitted sensors
C2	RNAV 2 GNSS
C3	RNAV 2 DME/DME
C4	RNAV 2 DME/DME/IRU
D1	RNAV 1 all permitted sensors
D2	RNAV 1 GNSS
D3	RNAV 1 DME/DME
D4	RNAV 1 DME/DME/IRU
PBN/ RNP SPECIFICATIONS	
L1	RNP 4
O1	Basic RNP 1 all permitted sensors
O2	Basic RNP 1 GNSS
O3	Basic RNP 1 DME/DME
O4	Basic RNP 1 DME/DME/IRU
S1	RNP APCH
S2	RNP APCH with BARO-VNAV
T1	RNP AR APCH with RF (special authorization required)
T2	RNP AR APCH without RF (special authorization required)

**NOTE-**

**1.** PBN Codes B1–B6 indicates RNAV 5 capability. The FAA considers these B codes to be synonymous and qualifying for point-to-point routing but not for assignment to the PBN routes shown in the table.

**2.** Combinations of alphanumeric characters not included above are reserved.

**3.** The PBN/ specifications are allowed per ICAO Doc. 4444. The FAA makes use of a subset of these codes as described in the section on filing navigation capability.

(c) The following sections detail what capabilities need to be provided to obtain services from the FAA for:

- IFR flights (general).
- Assignment of Performance-Based Navigation (PBN) routes.
- Automated Departure clearance (via Datacom DCL or PDC).
- Reduced Vertical Separation Minima (if requesting FL 290 or above).
- Reduced Separation in Oceanic Airspace.

(d) Capabilities such as voice communications, required communications performance, approach aids, and ADS-C, are not required in a flight plan that remains entirely within domestic airspace.

(e) Flights that leave domestic United States airspace may be required to include additional capabilities, per requirements for the FIRs being overflown. Consult the appropriate State Aeronautical Information Publications for requirements.

(f) Include the capability only if:

- The requisite equipment is installed and operational;
- The crew is trained as required; and
- Any required Operations Specification, Letter of Authorization, or other approvals are in hand.

**NOTE-**

*Do not include a capability solely based on the installed equipment if an operational approval is required.*

**5. Filing equipment and capability in an IFR Flight Plan.** This section details the minimum requirements to identify capabilities in an IFR flight plan for flights in the domestic United States. Other requirements to file a capability are associated with obtaining specific services as described in subsequent sections. The basic capabilities that must be addressed include Navigation, Transponder, Voice, and ADS-B Out as described below. A designator for “Standard” capability is also allowed to cover a suite of commonly carried voice, navigation, and approach equipment with one code.

**(a) Standard Capability and No Capability (Item 10a)**

- Use “S” if VHF radio, VOR, and ILS equipment for the route to be flown are carried and serviceable. Use of the ‘S’ removes the need to list these three capabilities separately.
- Use “N” if no communications, navigation, or approach aid equipment for the route to be flown are carried or the equipment is unserviceable.
- When there is no transponder, ADS-B, or ADS-C capability then file only the letter ‘N’ in Item 10b.

**(b) Navigation Capabilities (Item 10a, Item 18 NAV/)**

- Indicate radio navigation capability by filing one or more of the codes in TBL 2-6.
- Indicate Area Navigation (RNAV) capability by filing one or more of the codes in TBL 2-7.

TBL 2-6

**Radio Navigation Capabilities**

Capability	Item 10a	Item 18 NAV/
VOR	O	
DME	D	
TACAN	T	

TBL 2-7

**Area Navigation Capabilities**

Capability	Item 10a	Item 18 NAV/
GNSS	G	SBAS (if WAAS equipped) GBAS (if LAAS equipped)
INS	I	
DME / DME	DR	
VOR / DME	DOR	

**NOTE-**

**1. SBAS – Space-Based Augmentation System**  
**GBAS – Ground-Based Augmentation System**

**2. No PBN/ code needs to be filed to indicate the ability to fly point-to-point routes using GNSS or INS.**

**3. Filing one of these four area navigation capabilities as shown does not indicate performance based navigation sufficient for flying Q-Routes, T-Routes, or RNAV SIDs or STARs. To qualify for these routes, see the section on Performance Based Navigation Routes.**

**(c) Transponder Capabilities (Item 10b)**

- For domestic flights, it is not necessary to indicate Mode S capability. It is acceptable to simply file one of the following codes in TBL 2-8.

**TBL 2-8  
Mode C**

Capability	Item 10b
Transponder with no Mode C	A
Transponder with Mode C	C

- International flights must file in accordance with relevant AIPs and regional supplements. Include one of the Mode S codes in TBL 2-9, if appropriate.

**NOTE-**  
File only one transponder code.

**TBL 2-9  
Mode S**

Capability	Aircraft ID	Altitude Encoding	Item 10b
Mode S Transponder	No	No	X
Mode S Transponder	No	Yes	P
Mode S Transponder	Yes	No	I
Mode S Transponder	Yes	Yes	S
Mode S Transponder with Extended Squitter	Yes	Yes	E
Enhanced Mode S Transponder	Yes	Yes	H
Enhanced Mode S Transponder with Extended Squitter	Yes	Yes	L

**(d) ADS-B Capabilities (Item 10b, Item 18 SUR/ and Item 18 CODE/)**

- Indicate ADS-B capability as shown in TBL 2-10. The accompanying entry in Item 18 indicates that the equipment is compliant with 14 CFR §91.227. Some ADS-B equipment used in other countries is based on an earlier standard and does not meet U.S. requirements.
- Do not file an ADS-B code for “in” capability only. There is currently no way to indicate that an aircraft has “in” capability but no “out” capability.
- For aircraft with ADS-B “out” on one frequency and “in” on another, include only the ADS-B “out” code. For example, B1 or U1, (See TBL 2-10).

**TBL 2-10  
ADS-B Capabilities**

Capability	Item 10b	Item 18 SUR/
1090 ES Out Capability	B1	260B
1090 ES Out and In Capability	B2	260B
UAT Out Capability	U1	282B
UAT Out and In Capability	U2	282B

**(e) Voice Communication Capabilities (Item 10a)**

The FAA does not require indication of voice communication capabilities in a flight plan for domestic flights, but it is permissible. For flights outside the domestic United States, all relevant capabilities must be indicated as follows (See TBL 2–11):

**TBL 2–11  
Voice Communication Capabilities**

Capability	Item 10a
VHF Radio	V
UHF Radio	U
HF Radio	H
VHF Radio (8.33 kHz Spacing)	Y
ATC SATVOICE (INMARSAT)	M1
ATC SATVOICE (Iridium)	M3

**(f) Approach Aid Capabilities (Item 10a).**

The FAA does not require filing of approach aid capability in order to request a specific type of approach, however any of the codes indicated in TBL 2–12 in 10a are permissible.

- International flights may be required to indicate approach capability, based on instructions from relevant service providers.

**TBL 2–12  
Approach Aid Capabilities**

Capability	Item 10a
ILS	L
MLS	K
LPV Approach (APV with SBAS) (WAAS)	B
GBAS Landing System (LAAS)	A

**6. Performance–Based Navigation Routes (Item 10a, Item 18 PBN/, Item 18 NAV/)**– When planning to fly routes that require PBN capability, file the appropriate capability as shown in TBL 2–13.

**TBL 2–13**  
**Filing for Performance Based Navigation (PBN) Routes**

Type of Routing	Capability Required	Item 10a	Item 18 PBN/ See NOTE 2	Item 18 NAV/ See NOTE 3	Notes
RNAV SID or STAR (See NOTE 1)	RNAV 1	GR	D2		If GNSS
		DIR	D4		If DME/DME/IRU
RNP SID or STAR (See NOTE 2)	RNP 1 GNSS	GR	O2		If GNSS only
	RNP 1 GNSS	DGIR	O1		If GNSS primary and DME/DME/IRU backup
RNP SID or STAR with RF required (See NOTE 2)	RNP 1 GNSS	GRZ	O2	Z1	If GNSS only
	RNP 1 GNSS	DGIRZ	O1	Z1	If GNSS primary and DME/DME/IRU backup
Domestic Q–Route (see separate requirements for Gulf of Mexico Q–Routes)	RNAV 2	GR	C2		If GNSS
		DIR	C4		If DME/DME/IRU
T–Route	RNAV 2	GR	C2		GNSS is required for T–Routes
RNAV (GPS) Approach	RNP Approach, GPS	GR	S1		<i>Domestic arrivals do not need to file PBN approach capabilities to request the approach.</i>
RNAV (GPS) Approach	RNP Approach, GPS Baro–VNAV	GR	S2		
RNAV (GPS) Approach with RF required	RNP Approach, GPS RF Capability	GRZ	S2	Z1	
RNP AR Approach with RF	RNP (Special Autho- rization Required) RF Leg Capability	GR	T1		
RNP AR Approach with- out RF	RNP (Special Autho- rization Required)	GR	T2		

**NOTE–**

**1.** If the flight is requesting an RNAV SID only (no RNAV STAR) or RNAV STAR only (no RNAV SID) then consult guidance on the FAA website at

[https://www.faa.gov/about/office\\_org/headquarters\\_offices/ato/service\\_units/air\\_traffic\\_services/flight\\_plan\\_filing](https://www.faa.gov/about/office_org/headquarters_offices/ato/service_units/air_traffic_services/flight_plan_filing).

**2.** PBN descriptor D1 includes the capabilities of D2, D3, and D4. PBN descriptor B1 includes the capabilities of B2, B3, B4, and B5. PBN descriptor C1 includes the capabilities of C2, C3, and C4.

**3.** In NAV/, descriptors for advanced capabilities (Z1, P1, R1, M1, and M2) should be entered as a single character string with no intervening spaces, and separated from any other entries in NAV/ by a space.

**EXAMPLE–**

NAV/Z1P1M2 SBAS

**7.** Automated Departure Clearance Delivery (DCL or PDC). When planning to use automated pre–departure clearance delivery capability, file as indicated below.

(a) PDC provides pre–departure clearances from the FAA to the operator’s designated flight operations center, which then delivers the clearance to the pilot by various means. Use of PDC does not require any special flight plan entry.

(b) DCL provides pre–departure clearances from the FAA directly to the cockpit/FMS via Controller Pilot Datalink Communications (CPDLC). Use of DCL requires flight plan entries as follows:

- Include CPDLC codes in Item 10a only if the flight is capable of en route/oceanic CPDLC, the codes are not required for DCL.
- Include Z in Item 10a to indicate there is information provided in Item 18 DAT/.
- Include the clearance delivery methods of which the flight is capable, and order of preference in Item 18 DAT/. (See AIM 5-2-2)
  - VOICE – deliver clearance via Voice
  - PDC – deliver clearance via PDC
  - FANS – deliver clearance via FANS 1/A
  - FANSP – deliver clearance via FANS 1/A+

**EXAMPLE-**  
DAT/1FANS2PDC  
DAT/1FANSP2VOICE

**8. Operating in Reduced Vertical Separation Minima (RVSM) Airspace (Item 10a).** When planning to fly in RVSM airspace (FL 290 up to and including FL 410) then file as indicated below.

(a) If capable and approved for RVSM operations, per AIM 4-6-1, Applicability and RVSM Mandate (Date/Time and Area), file a W in Item 10a. Include the aircraft registration mark in Item 18 REG/, which is used to post-operationally monitor the safety of RVSM operations.

- Do not file a “W” in Item 10a if the aircraft is capable of RVSM operations, but is not approved to operate in RVSM airspace.
- If RVSM capability is lost after the flight plan is filed, request that ATC remove the ‘W’ from Item 10a.

(b) When requesting to operate non-RVSM in RVSM airspace, using one of the exceptions identified in AIM 4-6-10, do not include a “W” in Item 10a. Include STS/NONRVSM in Item 18. STS/NONRVSM is used only as part of a request to operate non-RVSM in RVSM airspace.

**9. Eligibility for Reduced Oceanic Separation.** Indicate eligibility for the listed reduced separation minima as indicated in the tables below. Full Operational Requirements for these services are found in the U.S. Aeronautical Information Publication (AIP) ENR 7, Oceanic Operations, available at [http://www.faa.gov/air\\_traffic/publications/atpubs/aip\\_html/index.html](http://www.faa.gov/air_traffic/publications/atpubs/aip_html/index.html).

*TBL 2-14*  
**Filing for Gulf of Mexico CTA**

Dimension of Separation	Separation Minima	ADS-C Surveillance Requirements	Comm. Requirement	PBN Requirement	Flight Plan Entries			
					ADS-C in Item 10b	CPDLC in Item 10a	PBN in Item 18 PBN/ (also File 'R' in Item 10a)	PBN in Item 18 NAV/
Lateral	50 NM	N/A (ADS-C not required)	Voice comm-HF or VHF as required to maintain contact over the entire route to be flown.	RNP10 or RNP4	N/A	N/A	A1 or L1	N/A

**NOTE-**  
If not RNAV10/RNP10 capable and planning to operate in the Gulf of Mexico CTA, then put the notation NONRNP10 in Item 18 RMK/, preferably first.



**TBL 2-15**  
**Filing for 50 NM Lateral Separation in Anchorage Arctic FIR**

Dimension of Separation	Separation Minima	ADS-C Surveillance Requirements	Comm. Requirement	PBN Requirement	Flight Plan Entries			
					ADS-C in Item 10b	CPDLC in Item 10a	PBN in Item 18 PBN/ (also File 'R' in Item 10a)	PBN in Item 18 NAV/
Lateral	50 NM	N/A (ADS-C not required)	None beyond normal requirements for the airspace	RNP10 or RNP4	N/A	N/A	A1 or L1	N/A

**TBL 2-16**  
**Filing for 30 NM Lateral, 30 NM Longitudinal, and 50 NM Longitudinal Oceanic Separation in Anchorage, Oakland, and New York Oceanic CTAs**

Dimension of Separation	Separation Minima	ADS-C Surveillance Requirements	Comm. Requirement	PBN Requirement	Flight Plan Entries			
					ADS-C in Item 10b	CPDLC in Item 10a	PBN in Item 18 PBN/ (also File 'R' in Item 10a)	PBN in Item 18 NAV/
Longitudinal	50 NM	Position report at least every 27 minutes (at least every 32 minutes if both aircraft are approved for RNP-4 operations)	CPDLC	RNP10	D1	J5 and/or J7	A1	N/A
Longitudinal	30 NM	ADS-C position report at least every 10 minutes	CPDLC	RNP4	D1	J5 and/or J7	L1	N/A
Lateral	30 NM	ADS-C-based lateral deviation event contract with 5NM lateral deviation from planned routing set as threshold for triggering ADS report of lateral deviation event	CPDLC	RNP4	D1	J5 and/or J7	L1	N/A

TBL 2-17

**Filing for Reduced Oceanic Separation when RSP/RCP Required on March 29, 2018**

Dimension of Separation	Separation Minima	RSP Re-requirement	RCP Re-requirement	PBN Requirement	Flight Plan Entries				
					RSP in Item 18 SUR/	RCP in Item 10a	CDPLC in Item 10a	PBN in Item 18 PBN/ (also File 'R' in Item 10a)	PBN in Item 18 NAV/
Lateral	55.5 km 30 NM	180	240	RNP 2 or RNP 4	RSP180	P2	J5, and/or J6, and/or J7	L1	
Performance-based Longitudinal	5 Minutes	180	240	RNAV 10 (RNP 10) RNP 4, or RNP 2 oceanic/ remote	RSP180	P2	J5, and/or J6, and/or J7	A1 or L1	M2
Performance-based Longitudinal	55.5 km 30 NM	180	240	RNP 4 or RNP 2 oceanic/ remote	RSP180	P2	J5, and/or J6, and/or J7	L1	M2
Performance-based Longitudinal	93 km 50 NM	180	240	RNAV 10 (RNP 10) or RNP 4	RSP180	P2	J5, and/or J6, and/or J7	A1 or L1	

**NOTE-**

1. Filing of RNP 2 alone is not supported in FAA controlled airspace; PBN/L1 (for RNP 4) or PBN/A1 (for RNP 10) must be filed to obtain the indicated separation.
2. Use of "RNP 2" in NAV/ signifies continental RNP 2 (and means the same as M1). Continental RNP 2 is not adequate for reduced oceanic separation. Descriptor M2 indicates RNP 2 global/oceanic RNP 2 capability.

**10. Date of Flight (Item 18 DOF/)**

Flights planned more than 23 hours after the time the flight plan is filed, must include the date of flight in DOF/ expressed in a six-digit format YYMMDD, where YY equals the year (Y), MM equals the month, and DD equals the day.

**NOTE-**

FAA ATC systems will not accept flight plans more than 23 hours prior to their proposed departure time. FAA Flight Service and commercial flight planning services generally accept flight plans earlier and forward to ATC at an appropriate time, typically 2 to 4 hours before the flight.

**EXAMPLE-**

DOF/171130

**11. Reasons for Special Handling (Item 18 STS/)**

(a) Indicate the applicable Special Handling in Item 18 STS/ as shown in TBL 2-18.

**NOTE-**

Priority for a flight is not automatically granted based on filing one of these codes but is based on documented procedures. In some cases, additional information may also be required in remarks; follow all such instructions as well.

**TBL 2–18**  
**Special Handling**

Special Handling	Item 18 STS/
Flight operating in accordance with an altitude reservation	ALTRV
Flight approved for exemption from ATFM measures by the appropriate ATS authority	ATFMX
Fire Fighting	FFR
Flight check for calibration of NAVAIDS	FLTCK
Flight carrying hazardous material(s)	HAZMAT
Flight with Head of State status	HEAD
Medical flight declared by medical authorities	HOSP
Flight operating on a humanitarian mission	HUM
Flight for which a military entity assumes responsibility for separation of military aircraft	MARSA
Life critical medical emergency evacuation	MEDEVAC
Non–RVSM capable flight intending to operate in RVSM airspace	NONRVSM
Flight engaged in a search and rescue mission	SAR
Flight engaged in military, customs, or police services	STATE

(b) Any other requests for special handling must be made in Item 18 RMK/.

(c) Include plain–language remarks when required by ATC or deemed necessary. Do not use special characters, for example; / \* – = +.

**EXAMPLE–**  
RMK/NRP  
RMK/DVRSN

**12. Remarks**

Include when necessary.

**13. Operator (Item 18 OPR/)**

When the operator is not obvious from the aircraft identification, the operator may be indicated.

**EXAMPLE–**  
OPR/NETJETS

**14. Flight Plan Originator (Item 18 ORGN/)**

(a) VFR flight plans originating outside of FAA FSS or FAA contracted flight plan filing services must enter the 8–letter AFTN address of the service where the flight plan was originally filed. Alternately, enter the name of the service where the FPL was originally filed. This information is critical to locating the FPL originator in the event additional information is needed.

(b) For IFR flight plans, the original filers AFTN address may be indicated, which is helpful in cases where a flight plan has been forwarded.

**EXAMPLE–**  
ORGN/Acme Flight Plans  
ORGN/KDENXLDS

**TBL 2–19**  
**Aircraft Specific Information**

Item	International Flight Plan (FAA Form 7233–4)	Domestic U.S. Requirements	Equivalent Item on Domestic Flight Plan (FAA Form 7233–1)
Number of Aircraft	Item 9	Included when more than one a/c in flight	Item 3
Type of Aircraft	Item 9	Required	Item 3
Wake Turbulence Category	Item 9	Required	N/A
Aircraft Registration	Item 18 REG/	Include when planning to operate in RVSM airspace	N/A
Mode S Address	Item 18 CODE/	Not required within U.S. controlled airspace	N/A
SELCAL Codes	Item 18 SEL/	Include when SELCAL equipped	N/A
Performance Category	Item 18 PER/	Not required for domestic flights	N/A

**e. Instructions for Aircraft–Specific Information.**

**1. Number of Aircraft (Item 9)** when there is more than one aircraft in the flight; indicate the number of aircraft up to 99.

**2. Type of Aircraft (Item 9)**

(a) Provide the appropriate 2–4 character aircraft type designator listed in FAA Order JO 7360.1, Aircraft Type Designators. FAA Order JO 7360.1 may be located at: Orders & Notices (faa.gov), then enter 7360.1 in the Search box.

(b) When there is no designator for the aircraft type use 'ZZZZ', and provide a description in Item 18 TYP/.

**3. Wake Turbulence Category (Item 9)**

A Wake Turbulence Category is required for all aircraft types. Provide the appropriate wake turbulence category for the aircraft type as listed in FAA Order 7360.1. The categories include:

(a) **J – SUPER**, aircraft types specified as such in FAA Order JO 7360.1, Aircraft Type Designators.

(b) **H – HEAVY**, to indicate an aircraft type with a maximum certificated take–off mass of 300,000 lbs. or more, with the exception of aircraft types listed in FAA Order JO 7360.1 in the SUPER (J) category.

(c) **M – MEDIUM**, to indicate an aircraft type with a maximum certificated take–off mass of less than 300,000 lbs. but more than 15,500 lbs.

(d) **L – LIGHT**, to indicate an aircraft type with a maximum certificated take–off mass of 15,500 lbs. or less.

**4. Aircraft Registration (Item 18 REG/)**

The aircraft registration must be provided here if different from the Item 7 entry. The registration mark must not include any spaces or hyphens. Additionally, the actual aircraft registration must also be included if Item 7 would have contained a leading numeric and was modified to be prefixed with the appropriate alphabetic character for U.S. ATC acceptance.

**EXAMPLE–**

*U.S. aircraft with registration N789AK*

*REG/N789AK*

*Belgian aircraft with registration OO–FAH*

*REG/OOFAH*

**5. Mode S Address (Item 18 CODE/)**

There is no U.S. requirement to file the aircraft Mode S Code in Item 18.

**6. SELCAL code (Item 18 SEL/)**

(a) Flights with HF radio and Selective Calling capability should include their 4–letter SELCAL code. Per the U.S. AIP, GEN 3.4, Paragraph 9, Selective Calling System (SELCAL) Facilities Available.

(b) The SELCAL is a communication system that permits the selective calling of individual aircraft over radio–telephone channels from the ground station to properly equipped aircraft, to eliminate the need for the flight crew to constantly monitor the frequency in use.

**EXAMPLE–**  
SEL/CLEF

**7. Performance Category (Item 18 PER/)**

Include the appropriate single–letter Aircraft Approach Category as defined in the Pilot/Controller Glossary.

**EXAMPLE–**  
PER/A

TBL 2–20

**Flight Routing Information**

Item	International Flight Plan (FAA Form 7233–4)	Domestic U.S. Requirements	Equivalent Item on Domestic Flight Plan (FAA Form 7233–1)
Departure Airport	Item 13	Required	Item 2
Departure Time	Item 13	Required	Item 1
Cruise Speed	Item 15	Required	N/A
Requested Altitude	Item 15	Required	Item 3
Route	Item 15	Required	N/A
Delay En Route	Item 15, Item 18 DLE/	Required	N/A
Destination Airport	Item 16	Required	Item 11
Total Estimated Elapsed Time	Item 16	Required	Item
Alternate Airport	Item 16 Item 18 ALTN/ (Destination Alternate).	If necessary	N/A
	RALT/ (En route Alternate); TALT/ (Take–off Alternate)	No need to file for domestic U.S. flight	
Estimated Elapsed Times	Item 18 EET/	Include when filing flight plan with center other than departure center	N/A

**f. Instructions for Flight Routing Items**

**1. Departure Airport (Item 13, Item 18 DEP/)**

(a) Enter the departure airport. The airport should be identified using the four–letter location identifier from FAA Order JO 7350.9, Location Identifiers, or from ICAO Document 7910. FSS and FAA contracted flight plan filing services will allow up to 11 characters in the departure field. This will permit entry of non–ICAO identifier airports, and other fixes such as an intersection, fix/radial/distance, and latitude/longitude coordinates. Other electronic filing services may require a different format.

**NOTE–**

While user interfaces for flight plan filing are not specified, all flight plan filing services must adhere to the appropriate Interface Control Document upon transmission of the flight plan to the control facility.

(b) When the intended departure airport (Item 13) is outside of domestic U.S. airspace, or if using the paper version of FAA Form 7233–4, or DOD equivalent, if the chosen flight plan filing service does not allow

non-ICAO airport identifiers in Item 13 or Item 16, use the following ICAO procedure. Enter four Z's (ZZZZ) in Item 13 and include the non-ICAO airport location identifier, fix, or waypoint location in Item 18 DEP/. A text description following the location identifier is permissible in Item 18 DEP/.

**NOTE–**

Use of non-ICAO identifiers in Item 13 and Item 16 is only permissible when flight destination is within U.S. airspace. If the destination is outside of the U.S., then both Item 13 and Item 16 must contain either a valid ICAO airport identifier or ZZZZ. Use of non-ICAO departure point is not permitted in Item 13 if destination in Item 16 is outside of U.S.

**EXAMPLE–**

DEP/MD21  
DEP/W29 BAY BRIDGE AIRPORT  
DEP/EMI211017  
DEP/3925N07722W

**2. Departure Time (Item 13)**

Indicate the expected departure time using 4 digits, 2 digits for hours and 2 digits for minutes. Time is to be entered as Coordinated Universal Time (UTC).

**3. Requested Cruising Speed (Item 15)**

(a) Include the requested cruising speed as True Airspeed in knots using an N followed by four digits.

**EXAMPLE–**

N0450

(b) Indicate the requested cruising speed in Mach using an M followed by three digits.

**EXAMPLE–**

M081

**4. Requested Cruising Altitude or Flight Level (Item 15)**

(a) Indicate a Requested Flight Level using the letter F followed by 3 digits.

**EXAMPLE–**

F350

(b) Indicate a Requested Altitude in hundreds of feet using the letter A followed by 3 digits.

**EXAMPLE–**

A080

**5. Route (Item 15)**

Provide the requested route of flight using a combination of published routes, latitude/longitude, and/or fixes in the following formats.

(a) Consecutive fixes, lat/long points, NAVAIDs, and waypoints should be separated by the characters “DCT”, meaning direct.

**EXAMPLE–**

FLACK DCT IRW DCT IRW12503  
4020N07205W DCT MONEY

(b) A published route should be preceded by a fix that is published on the route, indicating where the route will be joined. The published route should be followed by a fix that is published as part of the route, indicating where the route will be exited.

**EXAMPLE–**

DALL3 EIC V18 MEI LGC4

(c) It is acceptable to specify intended speed and altitude changes along the route by appending an oblique stroke followed by the next speed and altitude. However, note that FAA ATC systems will neither process this information nor display it to ATC personnel. Pilots are expected to maintain the last assigned altitude and request revised altitude clearances from ATC.

**EXAMPLE–**

DCT APN J177 LEXOR/N0467F380 J177 TAM/N0464F390 J177

**6. Delay En Route (Item 15, Item 18 DLE/)**

(a) ICAO defines Item 18 DLE/ to provide information about a delay en route. International flights with a delay outside U.S. domestic airspace should indicate the place and duration of the delay in Item 18 DLE/. The delay is expressed by a fix identifier followed by the duration in hours (H) and minutes (M), HHMM.

**EXAMPLE–**

DLE/EMI0140

(b) U.S. ATC systems will accept but not process information in DLE/. Therefore, for flights in the lower 48 states, it is preferable to include the delay as part of the route (Item 15). Delay in this format is specified by an oblique stroke (/) followed by the letter D, followed by 2 digits for hours (H) of delay, followed by a plus sign (+), followed by 2 digits for minutes (M) of delay: /DHH+MM.

**EXAMPLE–**

DCT EMI/D01+40 DCT MAPEL/D00+30 V143 DELRO DCT

**7. Destination Airport (Item 16, Item 18 DEST/)**

(a) Enter the destination airport. The airport should be identified using the four–letter location identifier from FAA Order JO 7350.9, Location Identifiers, or from ICAO Document 7910. FSS and FAA contracted flight plan filing services will allow up to 11 characters in the destination field. This will permit entry of non–ICAO identifier airports, and other fixes such as an intersection, fix/radial/distance, and latitude/longitude coordinates. Other electronic filing services may require a different format.

**NOTE–**

*While user interfaces for flight plan filing are not specified, all flight plan filing services must adhere to the appropriate Interface Control Document upon transmission of the flight plan to the control facility.*

(b) When the intended destination (Item 16) is outside of domestic U.S. airspace, or if using the paper version of FAA Form 7233–4, or if the chosen flight plan filing service does not allow non–ICAO airport identifiers in Item 13 or Item 16, use the following ICAO procedure. Enter four Z's (ZZZZ) in Item 13 and include the non–ICAO airport location identifier, fix, or waypoint location in Item 18 DEP/. A text description following the location identifier is permissible in Item 18 DEP/.

**EXAMPLE–**

DEST/06A MOTON FIELD

DEST/4AK6

DEST/MONTK

DEST /3925N07722W

**8. Total Estimated Elapsed Time (Item 16)**

All flight plans must include the total estimated elapsed time from departure to destination in hours (H) and minutes (M), format HHMM.

**9. Alternate Airport (Item 16, Item 18 ALTN/)**

(a) When necessary, specify an alternate airport in Item 16 using the four–letter location identifier from FAA Order 7350.9 or ICAO Document 7910. When the airport does not have a four–letter location identifier, include ZZZZ in Item 16c and file the non–standard identifier in Item 18 ALTN/.

(b) While the FAA does not require filing of alternate airports in the flight plan provided to ATC, rules for establishing alternate airports must be followed.

(c) Adding an alternate may assist during Search and Rescue by identifying additional areas to search.

(d) Although alternate airport information filed in a flight plan will be accepted by air traffic computer systems, it will not be presented to controllers. If diversion to an alternate airport becomes necessary, pilots are expected to notify ATC and request an amended clearance.

**EXAMPLE–**

ALTN/W50 2W2

### 10. Estimated Elapsed Times (EET) at boundaries or reporting points (Item 18 EET/)

EETs are required for international or oceanic flights when crossing a Flight Information Region (FIR) boundary. The EET will include the ICAO four–letter location identifier for the FIR followed by the elapsed time to the FIR boundary (e.g., KZNY0245 indicates 2 hours, 45 minutes from departure until the New York FIR boundary).

**EXAMPLE–**

*EET/MMFR0011 MMTY0039 KZAB0105*

### 11. Remarks (Item 18 RMK/)

Enter only those remarks pertinent to ATC or to the clarification of other flight plan information. Items of a personal nature are not accepted.

**NOTE–**

1. “DVRSN” should be placed in Item 11 only if the pilot/company is requesting priority handling to their original destination from ATC as a result of a diversion as defined in the Pilot/Controller Glossary.

2. Do not assume that remarks will be automatically transmitted to every controller. Specific ATC or en route requests should be made directly to the appropriate controller.

### g. Flight Specific Supplemental Information (Item 19)

1. Item 19 data must be included when completing FAA Form 7233–4. This information will be retained by the facility/organization that transmits the flight plan to Air Traffic Control (ATC), for Search and Rescue purposes, but it will not be transmitted to ATC as part of the flight plan.

2. Do not include Supplemental Information as part of Item 18. The information in Item 19 is retained with the flight plan filing service for retrieval only if necessary.

**NOTE–**

*Supplemental Information within Item 19 will be transmitted as a separate message to the destination FSS for VFR flight plans filed with a FSS or FAA contracted flight plan filing service. This will reduce the time necessary to conduct SAR actions should the flight become overdue, as this information will be readily available to the destination Flight Service Station.*

3. Minimum required Item 19 entries for a domestic flight are Endurance, Persons on Board, Pilot Name and Contact Information, and Color of Aircraft. Additional entries may be required by foreign air traffic services, or at pilot discretion.

(a) After E/ Enter fuel endurance time in hours and minutes.

(b) After P/ Enter total number of persons on board using up to 30 alphanumeric characters. Enter TBN (to be notified) if the total number of persons is not known at the time of filing.

**EXAMPLE–**

*P/005*

*P/TBN*

*P/ON FILE CAPEAIR OPERATIONS*

(c) R/ (Radio) Cross out items not carried

(d) S/ (Survival Equipment) Cross out items not carried.

(e) J/ (Jackets) Cross out items not carried.

(f) D/ (Life Raft/Dinghies) Enter number carried and total capacity. Indicate if covered and color.

(g) A/ (Aircraft Color and Markings) Enter aircraft color(s).

**EXAMPLE–**

*White Yellow Blue*

4. N/ (Remarks. Not for ATC) select N if no remarks. Enter comments concerning survival equipment and information concerning personal GPS locating service, if utilized. Enter name and contact information for responsible party to verify VFR arrival/closure, if desired. Ensure party will be available for contact at ETA. (for example; FBO is open at ETA)



**5. C/ (Pilot)** Enter name and contact information, including telephone number, of pilot-in-command. Ensure contact information will be valid at ETA in case SAR is necessary.

**FIG 2-1  
FAA Form 7233-4, Pre-Flight Pilot Checklist and International Flight Plan**

**PRIVACY ACT STATEMENT:** This statement is provided pursuant to the Privacy Act of 1974, 5 USC § 552a: The authority for collecting this information is contained in 49 U.S.C. §§ 40113, 44702, 44703, 44709, and 14 C.F.R. Part 6 - [Part 61, 63, 65, or 67]. The principal purpose for which the information is intended to be used is to allow you to submit your flight plan. Submission of the data is voluntary. Failure to provide all required information may result in you not being able to submit your flight plan. The information collected on this form will be included in a Privacy Act System of Records known as DOT/FAA 847, titled "Aviation Records on Individuals" and will be subject to the routine uses published in the System of Records Notice (SORN) for DOT/FAA 847 (see www.dot.gov/privacy/privacyactnotices).

**Paperwork Reduction Act Statement:** A federal agency may not conduct or sponsor, and a person is not required to respond to, nor shall a person be subject to a penalty for failure to comply with a collection of information subject to the requirements of the Paperwork Reduction Act unless that collection of information displays a currently valid OMB Control Number. The OMB Control Number for this information collection is 2120-0026. Public reporting for this collection of information is estimated to be approximately 2.5 minutes per response, including the time for reviewing instructions, searching existing data sources, gathering and maintaining the data needed, completing and reviewing the collection of information. All responses to this collection of information are required to obtain or retain a benefit per 14 CFR Part 91. Send comments regarding this burden estimate or any other aspect of this collection of information, including suggestions for reducing this burden to the FAA at: 800 Independence Ave. SW, Washington, DC 20591, Attn: Information Collection Clearance Officer, ASP-110.

**Pre-Flight Pilot Checklist**

Aircraft Identification		Time of Briefing				
Weather (Destination) (Alternate)	<input type="checkbox"/> Present	Remarks	<b>Report Weather Conditions Aloft</b> <i>Report immediately weather conditions encountered---particularly cloud tops, upper cloud layers, thunderstorms, ice, turbulence, winds and temperature</i>			
	<input type="checkbox"/> Forecast					
			Position	Altitude	Time	Weather Conditions
Weather (En Route)	<input type="checkbox"/> Present					
	<input type="checkbox"/> Forecast					
	<input type="checkbox"/> Pireps					
Winds Aloft	Best Crzg. Alt.					
Nav. Aid & Comm. Status.	<input type="checkbox"/> Destination					
	<input type="checkbox"/> En Route					
Airport Conditions	<input type="checkbox"/> Destination					
	<input type="checkbox"/> Alternate					
ADIZ	<input type="checkbox"/> Airspace Restrictions					

**Civil Aircraft Pilots**

FAR Part 91 states that each person operating a civil aircraft of U.S. registry over the high seas shall comply with Annex 2 to the Convention of International Civil Aviation. International Standards - Rules of the Air. Annex 2 requires the submission of a flight plan containing items 1-1 9 prior to operating any flight across international waters. Failure to file could result in a civil penalty not to exceed \$1,000 for each violation (Section 901 of the Federal Aviation Act of 1958, as amended).

*International briefing information may not be current or complete. Data should be secured, at the first opportunity, from the country in whose airspace the flight will be conducted.*

<b>International Flight Plan</b>		
U.S. Department of Transportation Federal Aviation Administration		
PRIORITY <b>&lt;=FF</b>	ADDRESSEE(S) _____ _____ _____ <b>&lt;=</b>	
FILING TIME _____	ORIGINATOR _____ <b>&lt;=</b>	
SPECIFIC IDENTIFICATION OF ADDRESSEE(S) AND / OR ORIGINATOR _____ _____		
3 MESSAGE TYPE <b>&lt;=(FPL</b>	7 AIRCRAFT IDENTIFICATION _____	8 FLIGHT RULES _____ <b>&lt;=</b>
9 NUMBER _____	TYPE OF AIRCRAFT _____	WAKE TURBULENCE CAT. / _____ <b>&lt;=</b>
10 EQUIPMENT _____ / _____		
13 DEPARTURE AERODROME _____	TIME _____ <b>&lt;=</b>	
15 CRUISING SPEED _____	LEVEL _____	ROUTE _____
_____ <b>&lt;=</b>		
16 DESTINATION AERODROME _____	TOTAL EET HR MIN _____	ALTN AERODROME _____
		2ND ALTN AERODROME _____ <b>&lt;=</b>
18 OTHER INFORMATION _____ _____		
_____ <b>&lt;=</b>		
SUPPLEMENTARY INFORMATION (NOT TO BE TRANSMITTED IN FPL MESSAGES)		
19 ENDURANCE HR MIN <b>E/</b> _____	PERSONS ON BOARD <b>P/</b> _____	EMERGENCY RADIO UHF VHF ELT <b>R/</b> <input type="checkbox"/> <input type="checkbox"/> <input type="checkbox"/>
SURVIVAL EQUIPMENT POLAR DESERT MARITIME JUNGLE <input type="checkbox"/> / <input type="checkbox"/> <input type="checkbox"/> <input type="checkbox"/> <input type="checkbox"/>	JACKETS LIGHT FLUORES UHF VHF <input type="checkbox"/> / <input type="checkbox"/> <input type="checkbox"/> <input type="checkbox"/> <input type="checkbox"/>	
DINGHIES NUMBER CAPACITY COVER COLOR <b>D/</b> _____ <input type="checkbox"/> _____ <input type="checkbox"/> _____ <b>&lt;=</b>		
AIRCRAFT COLOR AND MARKINGS <b>A/</b> _____		
REMARKS <b>N/</b> _____ <b>&lt;=</b>		
PILOT-IN-COMMAND <b>C/</b> _____ <b>&lt;=</b>		
FILED BY _____	ACCEPTED BY _____	ADDITIONAL INFORMATION _____

FAA Form 7233-4 (7/15)

**NOTE-**  
Current FAA Form 7233-4 available at <https://www.faa.gov/forms/>.