



U.S. Department
of Transportation
**Federal Aviation
Administration**

Advisory Circular

Subject: Standards for Airport Markings

Date: 12/23/2020

AC No: 150/5340-1M

Initiated By: AAS-100

Change: 1

1 **Purpose.**

This advisory circular (AC) change contains the Federal Aviation Administration (FAA) standards for markings used on airport runways, taxiways, and aprons.

2 **Applicability.**

No change to paragraph 3, Applicability, dated 5/10/2019.

3 **Principal Changes.**

The AC change incorporates the following principal changes:

1. Page vi, paragraph 5, Implementation, subparagraph 4 replaced as shown below.
2. Paragraph 3.5.1 appended to add four new subparagraphs 3.5.1.1, 3.5.1.2, 3.5.1.3, and 3.5.1.4.

4 **Implementation.**

Implement changes addressed by this change upon effective date of this AC except as noted in Implementation subparagraph 1, dated 5/10/2019, and by the following revised subparagraph 4:

4. Paragraph 3.5, Approach/Departure Holding Position Marking.
 - a. Delay implementation of the APCH/DEP conditional marking and associated signage until FAA updates the following aeronautical publication for conditional holding positions: Aeronautical Information Manual (AIM); FAA Orders JO 7110.65, *Air Traffic Control*, and JO 7210.3, *Facility Operation and Administration*.
 - b. Implementation of approach/departure holding positions involves a process that includes: FAA assessment of affected runways and taxiways; advance

coordination with local ATC for development of a local standard operating procedure (SOP); local controller training and, as applicable, updates to the part 139 sign and marking plan. Upon completion of an assessment, FAA provides notification to the airport if conditional holding positions are necessary for protection of the approach/departure area.

- c. Upon receiving notification from the FAA of the need for conditional holding positions in the approach/departure area, implement the necessary changes to the holding position marking as follows:
 - i. For airports with operating airport traffic control towers and airports certified under 14 CFR Part 139, implement the necessary changes within two years from the date of FAA notification.
 - ii. For Federally obligated airports without an operating airport traffic control tower and non-certificated airports, implement marking changes with the next planned airfield development project.

5 Feedback on this AC.

If you have suggestions for improving this AC change, you may use the [Advisory Circular Feedback](#) form at the end of this AC.



John R. Dermody
Director of Airport Safety and Standards



U.S. Department
of Transportation
**Federal Aviation
Administration**

Advisory Circular

Consolidated AC includes Change 1

Subject: Standards for Airport Markings

Date: 5/10/2019

AC No: 150/5340-1M

Initiated By: AAS-100

Change:

1 **Purpose.**

This advisory circular (AC) contains the Federal Aviation Administration (FAA) standards for markings used on airport runways, taxiways, and aprons.

2 **Cancellation.**

This AC cancels AC 150/5340-1L, *Standards for Airport Markings*, dated September 27, 2013.

3 **Applicability.**

The Federal Aviation Administration recommends the standards and guidelines in this AC to establish uniform application of airfield surface markings for runways, taxiways and aprons. This AC does not constitute a regulation, is not mandatory and is not legally binding in its own right. It will not be relied upon as a separate basis by the FAA for affirmative enforcement action or other administrative penalty. Conformity with this AC is voluntary, and nonconformity will not affect rights and obligations under existing statutes and regulations, except for the projects described in subparagraphs 2, 3 and 4 below:

1. The standards and guidelines contained in this AC are practices the FAA recommends to establish an acceptable level of safety, performance and operation for airfield ground navigation.
2. This AC provides one, but not the only, acceptable means of meeting the requirements of 14 CFR part 139, *Certification of Airports*.
3. Use of these standards and guidelines is mandatory for projects funded under Federal grant assistance programs, including the Airport Improvement Program (AIP). See Grant Assurance #34.

4. This AC is mandatory, as required by regulation, for projects funded by the Passenger Facility Charge program. See PFC Assurance #9.

4 **Principal Changes.**

The AC incorporates the following principal changes:

1. New criterion for centering runway landing designators (common industry practice). See paragraph 2.3.5 and the green instructional box titled “Centering of Runway Landing Designators, Width of Rectangular Boxes (Painting).”
2. Paragraph 1.2, no-taxi islands definition. Added new definition to define no-taxi islands applicable to this advisory circular.
3. Paragraph 1.3.2. Added new red safety box informing airport operators not to apply preformed thermoplastic markings on the runway due to their significant reduction in pavement friction as compared to bare pavement.
4. Paragraph 1.3.8. The advisory circular makes the recommendation for training of personnel that perform application of surface markings, prepare surfaces to receive surface markings, remove markings, etc., as important aspects to obtaining desired markings and longevity.
5. Paragraph 1.3.9. Added new paragraph to clarify that all surface markings painted by the use of stencils are not to leave stencil gaps.
6. Paragraph 1.4. Added new notes to Table 1-2 that clarifies the relationship of Table 1-2 with Table 1-1 when dealing with the requirements for black borders.
7. Paragraph 1.5. Added new paragraph explaining the functions and applications of no-taxi islands to mitigate runway incursions and taxiing excursions. Deleted previous no-taxi island criteria from paragraph 4.4.5.2 and paragraph 4.10.4. Revised the red safety box in paragraph 4.4.5.2 to reference new paragraph 1.5 criteria.
8. Paragraphs 2.1.1. Added “*Engineered Materials Arresting Systems (EMAS)*” to the end of the paragraph as another example of paved areas prior to the runway end (start of runway). Clarified that Table 2-1 applies to runways that lack stopways, blast pads, displaced thresholds, or aligned taxiways.
9. Paragraph 2.9. Revised text in subparagraphs 2.9.1 and 2.9.2 to clarify the functions of a displaced threshold, the location where a displaced threshold begins as compared to a non-displaced threshold, and the use of arrow shafts.
10. Paragraphs 3.1 and 3.5. Pattern A is replaced by the Pattern B surface marking to protect the Approach/Departure Areas of the runway. This interchange is a direct result from the FAA Technical Center R&D report DOT/FAA/TC-16/26, *Evaluation of Enhanced Visual Cues for Runway Approach and Runway Safety Areas*, published in April 2016. This change in pattern will be accompanied with the installation of a new vertical sign to be promulgated by a change to AC 150/5340-18G.

11. Paragraph 4.3.4. Revised text to align FAA criterion with International Civil Aviation Organization (ICAO) Annex 14, Volume I criterion for enhanced taxiway centerline surface markings that are collinear with on-centered surface painted holding position signs. Revised Figure D-6 to reflect new criterion.
12. Paragraph 4.3.4. Added an instructional green box with guidance on how to relocate surface painted holding position signs between the two taxiway width categories (off-taxiway centerline placement and on-taxiway centerline placement).
13. Paragraph 4.4.5.4.2. Replaced criterion for the case not outlined in black when a taxiway edge marking is located at a runway holding position to read – a 6-inch (12 cm) gap is left between the holding position marking and the taxiway edge marking.
14. Paragraph 4.11.3.1. Replace 600 RVR with 500 RVR to agree with FAA Order 7110.65, *Air Traffic Control* (latest edition).
15. Paragraph 5.3.5, Item 4. Replaced the word “*interior*” with “*exterior*.”
16. Paragraph 5.6.1. Added more guidance regarding when to remove existing runway markings when a runway is closed or from an intersecting runway that has been closed.
17. Figures as follow:
 - a. Figure A-10 and Figure A-11 added the word “*Displaced*” to the phrase “*Runway Threshold Bar (white)*”;
 - b. Figure A-12 added the word “*Yellow*” to Note 2;
 - c. Figure A-13 added the word “*each*” to the phrase “*2 Lines and 1 Space are each 12” [30 cm] Wide*”;
 - d. Figure A-16 added to Note 3 the reference to paragraph 320 of AC 150/5300-13, *Airport Design*;
 - e. Figure A-18 clarified the design criterion to build taxiway/taxiway intersections with cockpit-over centerline fillets and marking criterion to use curved taxiway centerline markings by added the phrase “*until such substandard fillets are widened to full standard design criteria*” to the end of the existing phrase “*Taxiway centerline markings at intersection having less than standard fillets and requiring judgmental over steering*”;
 - f. Figure A-19 redrawn to emphasize the design criteria for standard width of taxiway entrances with a no-taxi island between entrance taxiways to a runway and for the elimination of paved areas within a POFZ;
 - g. Figure A-23 added the pictorial symbol for a vertical sign to reinforce placement of a vertical sign at runway holding position locations;
 - h. Figure D-5, Figure D-7, and Figure D-8 added the phrase “*The SPHPS to the right of the taxiway centerline is not always required in most cases.*” to the table within the first row.
 - i. Figure D-6 revised to show new marking pattern per ICAO Annex 14. Introduced new dimension “D” and removed taxiway centerline marking

between the surface painted holding position sign (SPHPS) and the runway holding position marking (Pattern A).

18. The format of the document has been updated in this version, and minor editorial changes have been made throughout.

5 Implementation.

Implement changes addressed by this revision upon effective date of this AC except as noted by the following:

1. Paragraph 2.3.5. FAA expects airports certificated under Part 139 to apply the guidelines for centering runway landing designator markings upon the next repainting project.
2. Paragraph 1.3.2, Preformed Thermoplastic Surface Marking on Runways. In the case of existing preformed thermoplastic markings on a runway, FAA expects airports certificated under Part 139 to correct such applications within one year of the effective date of this change.
3. Paragraph 1.3.9, Stencil Templates. For instances of existing surface markings with stencil gaps, FAA expects airports certificated under Part 139 to correct existing stencil gaps during the next painting project.
- ~~4. Paragraph 3.1, Approach/Departure Holding Position Marking. Implementation of the APCH/DEP signage and marking will employ a delayed approach to allow time for stakeholder outreach and familiarization activities to take place.

 - ~~a. Delay installation of APCH/DEP signage and marking until after January 1, 2021.~~
 - ~~b. For airports certified under 14 CFR Part 139 and those with an air traffic control tower, FAA expects conformance to the standards of paragraph 3.5 no later than December 31, 2022.~~
 - ~~c. Non-towered, general aviation airports may defer action on conforming to paragraph 3.5 until the next planned development project at the airport (i.e., signage and marking project, or pavement rehabilitation project).~~~~
5. Paragraph 4.3.4, Enhanced Taxiway Centerline Surface Marking. FAA expects airports certificated under Part 139 to conform to Figure D-6 for enhanced taxiway centerline surface marking collocated with on-center surface painted holding position signs when carrying out the next repainting project.

6 How to use this AC.

1. This AC includes color-coded text boxes to emphasize safety initiatives, solutions to painting difficulties, and general remarks.
 - a. Green (Painting) – explains painting precautions and solutions, such as when proportioning is permissible for runway surface markings.
 - b. Red (Safety) – emphasizes safety initiatives.

- c. Gray (General) – contains general remarks.
2. All references to other FAA ACs and Orders are interpreted as the current version.
3. Most figures in this AC are full scale AutoCAD drawings saved as MS Word versions. For some figures, certain details may appear to be missing (missing or broken lines) when either printed or viewed on a computer monitor. To view all the details in these figures, use the appropriate ZOOM function. In some instances, where there is a large surface area, a ZOOM value of over 250% may be necessary to view all details. Both this AC and the original AutoCAD files for all figures are available for download at the FAA web site:
http://www.faa.gov/airports/resources/advisory_circulars/index.cfm/go/document.list/parentTopicID/85.
4. Hyperlinks (allowing the reader to access documents located on the internet and to maneuver within this document) are provided throughout this document and are identified with underlined text. When navigating within this document, return to the previously viewed page by pressing the “ALT” and “ ← ” keys simultaneously.

7 **Measurements in this AC.**

This AC uses U.S. customary units followed with “soft” (rounded) conversion to metric units. The U.S. customary units govern.

8 **Copies of this AC and Other FAA Publications.**

You can view a list of all ACs at http://www.faa.gov/regulations_policies/advisory_circulars/. You can view the Federal Aviation Regulations at http://www.faa.gov/regulations_policies/faa_regulations/.

9 **Feedback on this AC.**

If you have suggestions for improving this AC, you may use the [Advisory Circular Feedback](#) form at the end of this AC.

/signed/

John R. Dermody
Director of Airport Safety and Standards

Page Intentionally Blank

CONTENTS

Number	Page
Chapter 1. Surface Markings for Airfield Pavements and Paved Airfield Roadways.	1-1
1.1 General.....	1-1
1.2 Definitions.....	1-1
1.3 Surface Marking Practices.....	1-2
1.4 Enhanced Conspicuity of Surface Markings on Concrete Pavements and Light Colored Pavements.....	1-9
1.5 No-Taxi Islands.....	1-12
Chapter 2. Surface Markings for Runways	2-1
2.1 Application.....	2-1
2.2 Interruption of Runway Surface Markings.....	2-2
2.3 Runway Landing Designator Marking.....	2-5
2.4 Runway Centerline Marking.....	2-8
2.5 Runway Threshold Marking.....	2-8
2.6 Runway Aiming Point Marking.....	2-10
2.7 Runway Touchdown Zone Marking.....	2-12
2.8 Runway Edge Marking.....	2-16
2.9 Runway Threshold Bar Marking and Runway Displaced Threshold Marking.....	2-17
2.10 Chevron Markings for Blast Pads, Stopways, and EMAS.....	2-20
2.11 Runway Shoulder Marking.....	2-21
Chapter 3. Holding Position Markings.....	3-1
3.1 Applications of Holding Position Markings.....	3-1
3.2 Case 1 and Case 2 – Applications of Pattern A for the Runway Holding Position Marking on Runways.....	3-1
3.3 Case 3 – Applications of Pattern A for the runway Holding Position Marking on Taxiways.....	3-4
3.4 Case 4 – Applications of Pattern B for the ILS Holding Position Marking.....	3-7
3.5 Case 5 – Applications of Pattern B for Precision Obstacle Free Zone (POFZ) and Runway Approach/Departure Holding Position Marking.....	3-1
3.6 Case 6 – Applications for Pattern C for the Taxiway/Taxiway Intersection Intermediate Holding Position Marking.....	3-2

CONTENTS

Number	Page
Chapter 4. Surface Markings for Taxiways	4-1
4.1 Application.....	4-1
4.2 Taxiway Centerline Markings.....	4-1
4.3 Enhanced Taxiway Centerline Marking.	4-4
4.4 Taxiway Edge Marking.....	4-9
4.5 Surface Painted Holding Position Signs.	4-11
4.6 Surface Painted Taxiway Direction Signs.	4-17
4.7 Surface Painted Taxiway Location Signs.	4-19
4.8 Surface Painted Gate Destination Signs.	4-20
4.9 Surface Painted Apron Entrance Point Signs.....	4-21
4.10 Taxiway Shoulder Markings.....	4-23
4.11 Geographic Position Markings.	4-24
4.12 Apron Control Markings.....	4-26
Chapter 5. Other Surface Markings.	5-1
5.1 Application.....	5-1
5.2 Vehicle Roadway Markings.....	5-1
5.3 Very High Frequency Omnidirectional Range (VOR) Receiver Checkpoint Marking.....	5-2
5.4 Non-Movement Area Boundary Marking.....	5-3
5.5 Markings for Thresholds Temporarily Relocated During Construction.....	5-5
5.6 Marking and Lighting of Permanently Closed Runways and Taxiways.	5-5
5.7 Temporarily Closed Runways and Taxiways.	5-6
5.8 Converting a Runway to a Taxiway.....	5-7
5.9 Intermittent Use of a Taxiway as a Runway.....	5-8
5.10 Closed or Abandoned Airports.	5-9
5.11 Heliport Markings.....	5-9
5.12 Marking for Arresting Gear.	5-9
5.13 Hazardous Construction Areas.	5-9
5.14 Aircraft Deicing Facility Markings.....	5-9
5.15 Interim Surface Markings for Taxiways Mistaken as Runways.....	5-10

CONTENTS

Number	Page
Appendix A. Pavement Markings	A-1
Appendix B. Inscriptions for Signs and Geographic Position Markings	B-1
Appendix C. Examples of Markings Outlined in Black	C-1
Appendix D. Enhanced Markings for Runway Holding Position	D-1
D.1 General.....	D-1
D.2 Applicability.	D-1
D.3 Enhanced Taxiway Centerline Markings.....	D-1
D.4 Extended Runway Holding Position Markings.....	D-5
D.5 Surface Painted Holding Position Signs.....	D-6

FIGURES

Number	Page
Figure 1-1. Example of Marking Removal Patterns	1-4
Figure 1-2. Example of Marking Removal Patterns	1-5
Figure 1-3. Example of Marking Removal Patterns	1-6
Figure 1-4. Example of Marking Removal Patterns	1-7
Figure 1-5. Example of Painted Numbering System for Surface Painted Markings	1-8
Figure 1-6. Case 1	1-18
Figure 1-7. Case 2	1-19
Figure 1-8. Case 3	1-20
Figure 1-9. Case 4.....	1-21
Figure 2-1. V Geometry.....	2-4
Figure 4-1. Sequential Circular-Shaped Apron Control Markings 3, 4, and 5 Between Two Terminals	4-28
Figure 4-2. Circular-Shaped Apron Control Marking 16 on Elongated Terminal Apron	4-29
Figure 4-3. Circular-Shaped Apron Control Markings 9S and 9N Between Terminals.....	4-30
Figure 4-4. Triangular-Shaped Apron Control Marking Between Terminals	4-32
Figure 4-5. Circular and Triangular-Shaped Apron Control Marking Dimensions.....	4-33
Figure 5-1. Precautionary Placement of the Non-Movement Boundary Marking.....	5-4

CONTENTS

Number	Page
Figure 5-2. TAXI Marking Location Facing Runway Approach End.....	5-11
Figure 5-3. TAXI Marking Dimensions	5-12
Figure 5-4. Aviation Grade Artificial Turf Installation	5-13
Figure A-1. Precision Runway Markings	A-1
Figure A-2. Non-Precision Runway	A-2
Figure A-3. Visual Runway Markings.....	A-3
Figure A-4. Example of Conflicting Markings on Crossing Runways.....	A-4
Figure A-5. Details of Markings for Intersecting Runways	A-5
Figure A-6. Runway Designation Numerals and Letters.....	A-6
Figure A-7. Displaced Threshold Markings	A-7
Figure A-8. Marking for Aligned Taxiway with Runway without a Displaced Threshold.....	A-8
Figure A-9. Markings for Blast Pads and Stopways.....	A-9
Figure A-10. Markings for Aligned Taxiway Preceding a Displaced Threshold.....	A-10
Figure A-11. Markings for Blast Pad Preceding a Displaced Threshold.....	A-11
Figure A-12. Runway Shoulder Markings.....	A-12
Figure A-13. Holding Position Marking Details.....	A-13
Figure A-14. Holding Position Marking Details.....	A-14
Figure A-15. Taxiway Markings.....	A-15
Figure A-16. Taxiway Markings.....	A-16
Figure A-17. Taxiway Markings.....	A-17
Figure A-18. Methods for Taxiway Centerline Marking.....	A-18
Figure A-19. Surface Painted Direction Signs.....	A-19
Figure A-20. Surface Painted Gate Identification Signs.....	A-20
Figure A-21. Multiple Gate Signs.....	A-21
Figure A-22. Surface Painted Apron Entrance Point Signs.....	A-22
Figure A-23. Taxiway Shoulder Markings	A-23
Figure A-24. Geographic Position Markings.....	A-24
Figure A-25. Vehicle Roadway Markings	A-25
Figure A-26. VOR Receiver Checkpoint Markings	A-26
Figure A-27. Closed Runway and Taxiway Markings	A-27

CONTENTS

Number	Page
Figure B-1. Pavement Markings ABCDEFGH	B-1
Figure B-2. Pavement Markings IJKLMNOP	B-2
Figure B-3. Pavement Markings QRSTUVWX	B-3
Figure B-4. Pavement Markings YZ123456.....	B-4
Figure B- 5. Pavement Markings 7890-, ↑.....	B-5
Figure C-1. Runway Holding Position Marking.....	C-1
Figure C-2. ILS Holding Position Marking	C-1
Figure C-3. Continuous Taxiway Edge Line Marking	C-2
Figure C-4. Dashed Taxiway Edge Line Marking.....	C-2
Figure C-5. Alternate Outlining Method for Dashed Taxiway Edge Line Marking	C-3
Figure C-6. Taxiway Centerline Marking.....	C-3
Figure C-7. Intermediate Holding Position Markings	C-4
Figure C-8. Non-Movement Area Boundary Marking.....	C-4
Figure D-1. Enhanced Taxiway Centerline Marking on Curved Taxiway.....	D-2
Figure D-2. Dashed Lines at Converging Taxiway Centerlines.....	D-3
Figure D-3. Converging, Straight, and Curved Enhanced Taxiway Centerlines Intersecting with Holding Position Marking.....	D-4
Figure D-4. Extended Runway Holding Position Markings on Taxiways	D-5
Figure D-5. Surface Painted Holding Position Signs for Taxiway Widths Greater than 35 Feet (10.5 m).....	D-6
Figure D-6. Surface Painted Holding Position Sign for Taxiway Widths Equal to or Less than 35 feet (10.5 m).....	D-7
Figure D-7. Surface Painted Holding Position Signs When Taxiway Centerline is Not Perpendicular to Runway Holding Position Marking.....	D-8
Figure D-8. Surface Painted Holding Position Signs Co-Located with Geographic Position Marking.....	D-9
Figure D-9. Two Taxiway Centerlines Converging at a Runway Holding Position Marking .	D-10
Figure D-10. Intersection of Two Taxiways at Runway End	D-11
Figure D-11. Intersection of Three Converging Taxiway Centerlines	D-12
Figure D-12. Intersection of Multi-Taxiway Centerlines With Less Than 150 feet (45.7 m) Between Taxiways.....	D-13
Figure D-13. Two Taxiway Centerlines Intersecting a Runway Holding Position Marking ...	D-14

CONTENTS

Number	Page
Figure D-14. Intersection of Stub Taxiway and Runway	D-15
Figure D-15. Narrow Taxiway Stacked Surface Painted Holding Position Sign	D-16
Figure D-16. Enhanced Taxiway Centerlines When a Taxiway Connects Closely Spaced Runways.....	D-17

TABLES

Number	Page
Table 1-1. General Guidelines for Painting a Black Border	1-9
Table 1-2. Guidelines for Black Borders and Glass Beads.....	1-10
Table 2-1. Minimum Required Runway Surface Marking Schemes for Paved Runways.....	2-1
Table 2-2. Number of Runway Threshold Stripes for Standard Runway Widths	2-9
Table 2-3. Groupings of Touchdown Zone Markings Required When Installed From One Threshold	2-13
Table 2-4. Groupings of Touchdown Zone Markings Required When Installed From Both Thresholds.....	2-14
Table D-1. Notes for Figure D-5.....	D-6
Table D-2. Notes for Figure D-6.....	D-7
Table D-3. Notes for Figure D-7.....	D-8
Table D-4. Notes for Figure D-8.....	D-9

CHAPTER 1. SURFACE MARKINGS FOR AIRFIELD PAVEMENTS AND PAVED AIRFIELD ROADWAYS.

1.1 General.

This chapter provides the standards for surface markings used on airfield pavements (runways, taxiways, aprons, and paved airfield roadways). The standards for the surface markings assume that runways, taxiways, and aprons are built in accordance to the standard dimensions and layouts (e.g., clearances, fillets) in Advisory Circular (AC) 150/5300-13, *Airport Design*. The airport operator should expect difficulties when painting surface markings on non-standard infrastructure, such as a runway with a non-standard width. To assist airport operators, this AC offers a few workable solutions for existing non-standard situations. Surface markings for large airplane parking positions and surface markings for unpaved airfield runways will be addressed at a future date in additional chapters.

Note: Use the zoom feature to view detail in any figure.

1.2 Definitions.

The following definitions apply to terms used in this AC.

1. **Certificated Airport.** An airport that has been issued an Airport Operating Certificate by the FAA under the authority of Part 139.
2. **Commercial Service Airports and Passenger Enplanements.** Defined in FAA Order 5100.38, Airport Improvement Program Handbook.
3. **Displaced Threshold.** A threshold that is located at a point on the runway other than the designated beginning of the runway.
4. **Island.** An unused paved or grassy area along a taxiway, between taxiways, between runways, or between a taxiway and a runway. Paved islands are clearly marked as unusable, either by painting or the use of artificial turf. For the purposes of this AC, certain islands are referred to as “No-taxi” islands.
5. **Movement Area.** The runways, taxiways, and other areas of an airport that are used for taxiing, takeoff, and landing of aircraft, exclusive of loading aprons and aircraft parking areas (reference Part 139).
6. **No-taxi Island.** An island that requires safety enhancements, i.e., the use of specific surface markings and/or taxiway design features to mitigate excursions from a taxiway or mitigate runway incursions. Vertical signage and/or lighting may also be required or used.
7. **Non-precision Runway.** See AC 150/5300-13 for the definition.
8. **Precision Runway.** See AC 150/5300-13 for the definition.
9. **Threshold.** The beginning of that portion of the runway that is available for landing. In some instances, the landing threshold may not coincide with the end of the opposite direction runway (see paragraph 1.2).

10. Visual Runway. A runway end without an existing or planned (on the Airport Layout Plan) straight-in instrument approach procedure.

1.3 **Surface Marking Practices.**

The following subparagraphs address common practices used in airport markings.

1.3.1 In some situations, these standards may call for markings with different meanings to be installed close together. Ensure that sufficient space is left between such markings such that an observer will not be confused. Note: The taxiway edge marking and non-movement area boundary marking never coincide or run side-by-side. See paragraph [5.4](#).

1.3.2 Increasing the Friction Coefficient of Surface Markings.

[AC 150/5370-10](#), *Standards for Specifying Construction of Airports*, Item P-620, Runway and Taxiway Marking, provides airport operators information to increase the friction coefficient of surface markings. Common practices include the spreading of silica sand on the marked surface immediately after painting and the use of glass beads in the marking materials. Glass beads or silica sand are required when durable markings (epoxy and methyl acrylate based paints) are used. These paints are usually applied at 18 to 30 mils in dry thickness.

Safety Notice No. 1

Reduced Runway Surface Friction Prohibition of Preformed Thermoplastic Surface Markings on Runways

Until further notice, preformed thermoplastic surface markings are not to be within the runway proper because of the significantly lower friction readings recorded on such markings as compared to dry unmarked pavement (see FAA Technical Report DOT/FAA/AR-TN08/22, Evaluation of Thermoplastic Marking Materials). FAA expects airports certified under Part 139 to correct existing non-conforming conditions within one year of issuance of this change.

1.3.3 Paint Color Specifications, Requirements for Surface Preparation, Paint Application Rates and Methods, and Requirements for Preformed Thermal Plastic Markings.

[AC 150/5370-10](#) provides the paint color specifications, requirements for surface preparation, paint application rates, the various methods for applying paint, and the performance requirements for using preformed thermoplastic markings. Precaution: Reflective tapes such as those commonly used for highways and city street applications are not to be used on the airside because of the potential for foreign object damage caused by loosened painted tape.

1.3.4 Striated Markings.

Striated markings, which may be used only in areas subject to frost heave, consist of painted stripes 4 inches (10 cm) to 8 inches (20 cm) in width that are separated by

unpainted stripes. The width of the unpainted stripe may not exceed the width of the painted stripe. The width of the painted and unpainted stripes must be the same throughout the specific marking. Each edge of the marking must be a painted stripe. That is, a painted stripe is to begin and end within the width of the markings.

Precaution: Because striated markings offer reduced visibility compared to non-striated markings, more frequent maintenance is required to maintain an acceptable level of visibility. Hence, striated markings are never used on Category II and Category III runways. The mixing of striated and non-striated markings is not permitted within a surface marking scheme. For example, in a 2-digit landing designator, one digit cannot be striated while the other is not. It is permitted to mix different marking schemes. For example, the landing designator is striated and the aiming point is not.

1.3.5 Temporary Markings.

When selecting a material for temporary markings, consider the difficulty of removing the temporary marking when it is no longer needed. Some airports have had some success using water-based paint. Striated markings may also be used for temporary markings, but they are never used to denote a closed runway or other closed pavement or for Category II or Category III runways. Tape is never to be used as temporary marking.

1.3.6 Removal of Markings.

Pavement markings that are no longer needed are not to be painted over but instead are to be physically removed. The FAA does not endorse painting over the old markings because this inadequate practice merely preserves the old marking which, in some cases, has misled pilots and required extra maintenance. Physical removal of markings is achieved by water blasting, shot blasting, sand blasting, chemical removal, or other acceptable means that do not harm the pavement. The physical removal of any old marking(s) must include a predetermined larger size and shape of a removal area that encompasses the old marking(s) and by grouping adjacent markings together into a larger rectangular removal area. The rationale behind this practice is to eliminate the continued visual appearance of the removed marking(s). When a runway end or threshold is being moved, all of the markings that are being removed must be strikingly larger in size, grouped together with adjacent markings, and be rectangular in shape. For example, use a single, larger rectangular removal area to encompass the entire runway designator 7 or 14L and provide a separate large rectangular area comprising all of the runway threshold markings along with a separate large rectangular area for the touchdown zone markings on the same side of the runway centerline. Also, the size and shape for the removal area for (1) Patterns A, B, and C holding position markings and (2) yellow arrow heads having a runway threshold bar or a runway demarcation bar must be much larger than the marking(s) being removed. For example, use a single, larger rectangular removal area to encompass all yellow arrow heads and the adjacent white runway threshold bar marking. See [Figure 1-1](#), [Figure 1-2](#), [Figure 1-3](#), and [Figure 1-4](#) for examples of marking removal patterns.

Figure 1-1. Example of Marking Removal Patterns

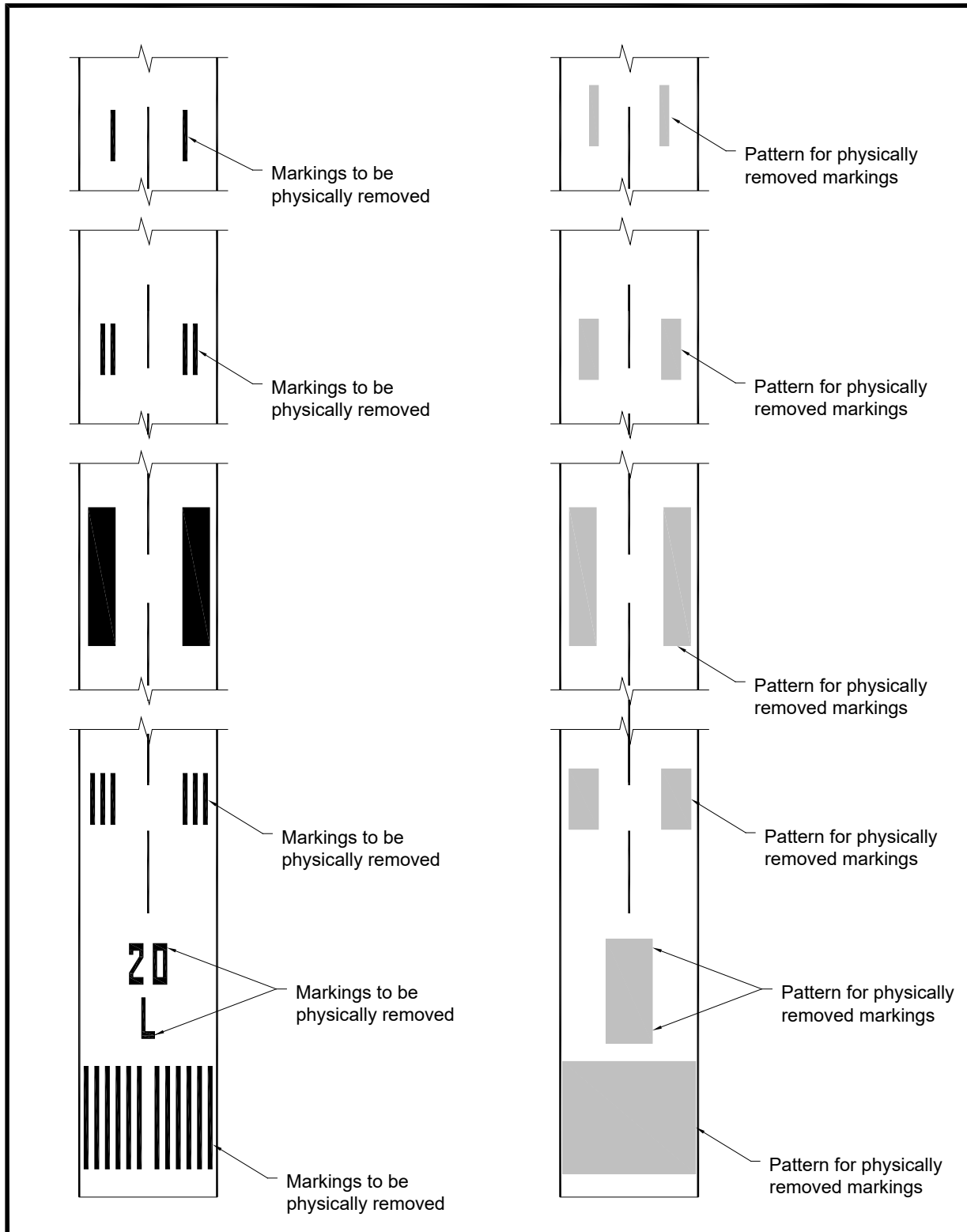

Note: For further details, see paragraph [1.3.6](#).

Figure 1-2. Example of Marking Removal Patterns

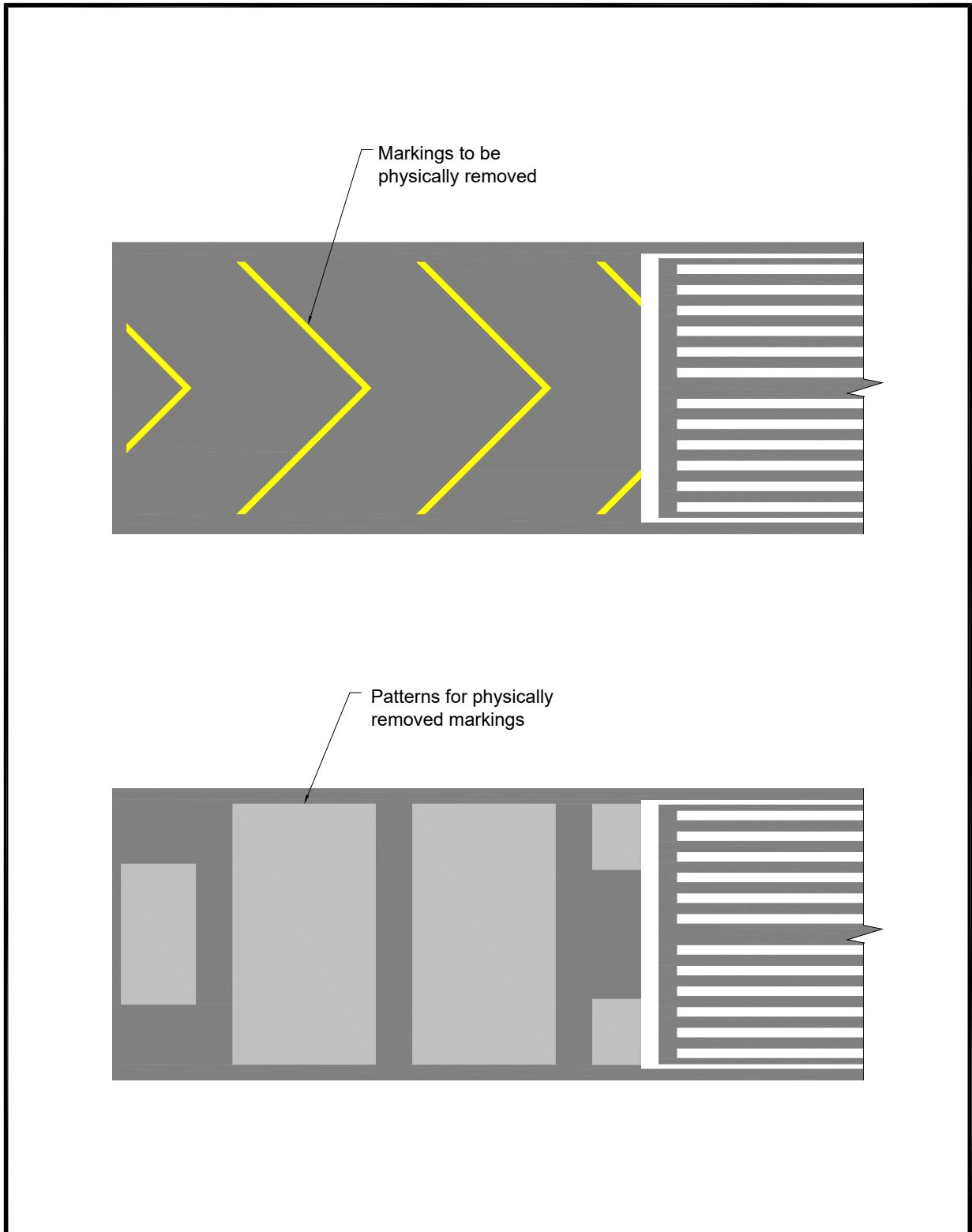

Note: For further details, see paragraph [1.3.6](#).

Figure 1-3. Example of Marking Removal Patterns

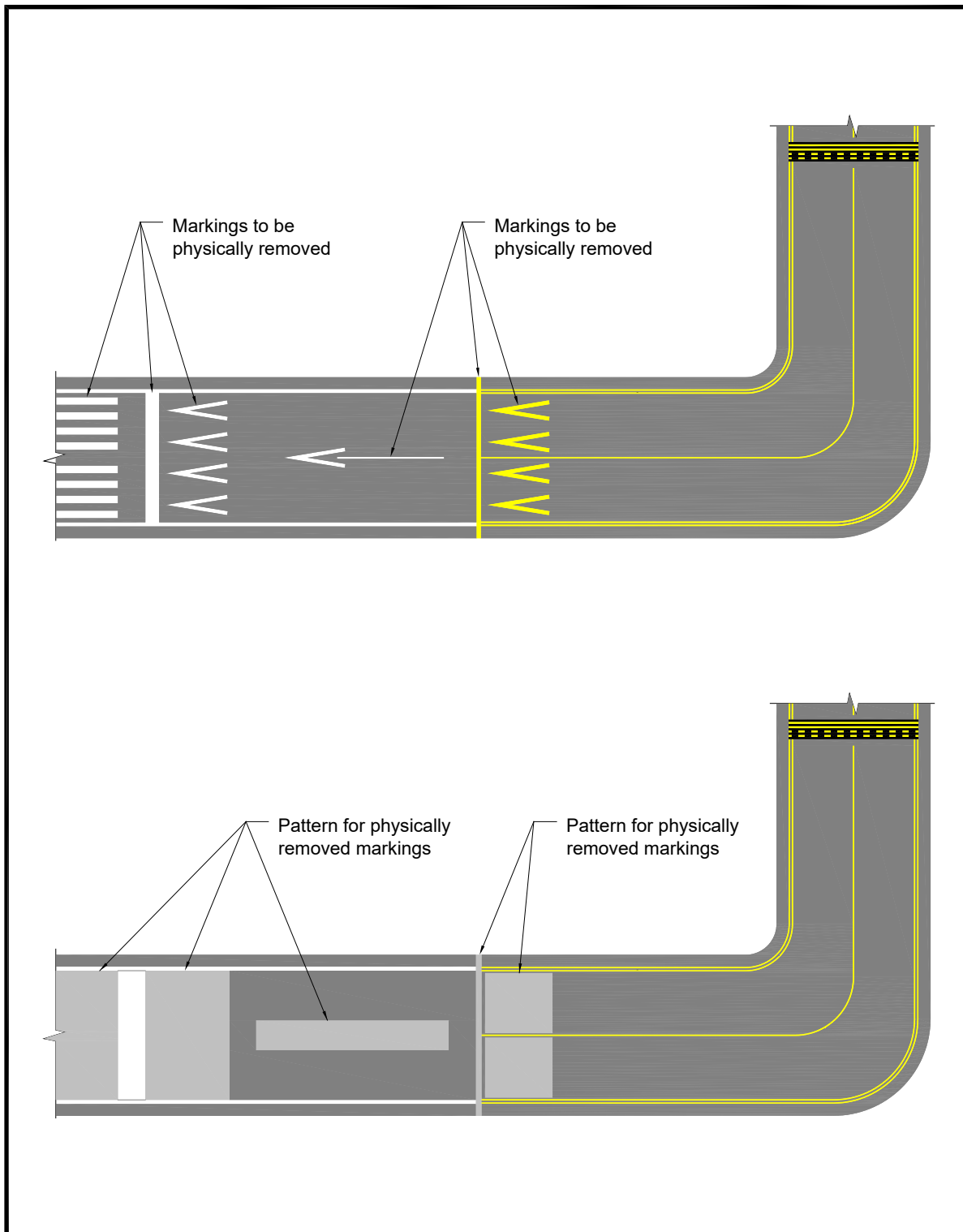

Notes: For further details, see paragraph [1.3.6](#).
Aligned taxiway construction is prohibited per [AC 150/5300-13](#). Existing locations should be rectified.

Figure 1-4. Example of Marking Removal Patterns

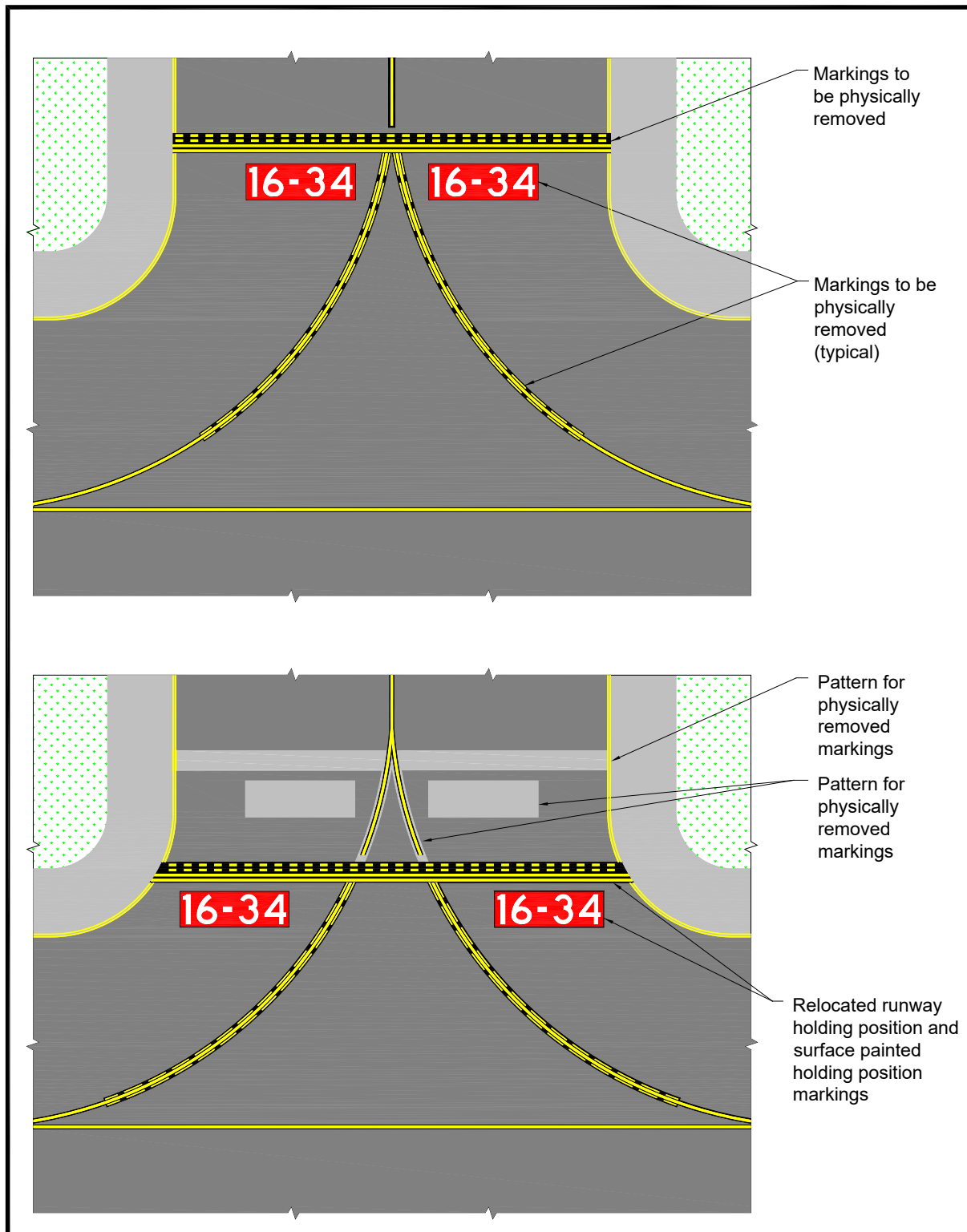

Note: For further details, see paragraph [1.3.6](#).

1.3.7 Painted Numbering System for Record Keeping of Surface Painted Markings.

To facilitate the daily inspection, scheduled maintenance, necessary repairs, etc., for surface markings, the airport operator may use a numbering system or alphanumeric system that is located in a corner of the surface marking. Figure 1-5 shows a numbering system adopted by one airport for identifying each surface marking listed in their Sign Plan. If employed, the height of the inscription should be small and inconspicuous to all viewers except an individual standing next to the surface marking.

Figure 1-5. Example of Painted Numbering System for Surface Painted Markings

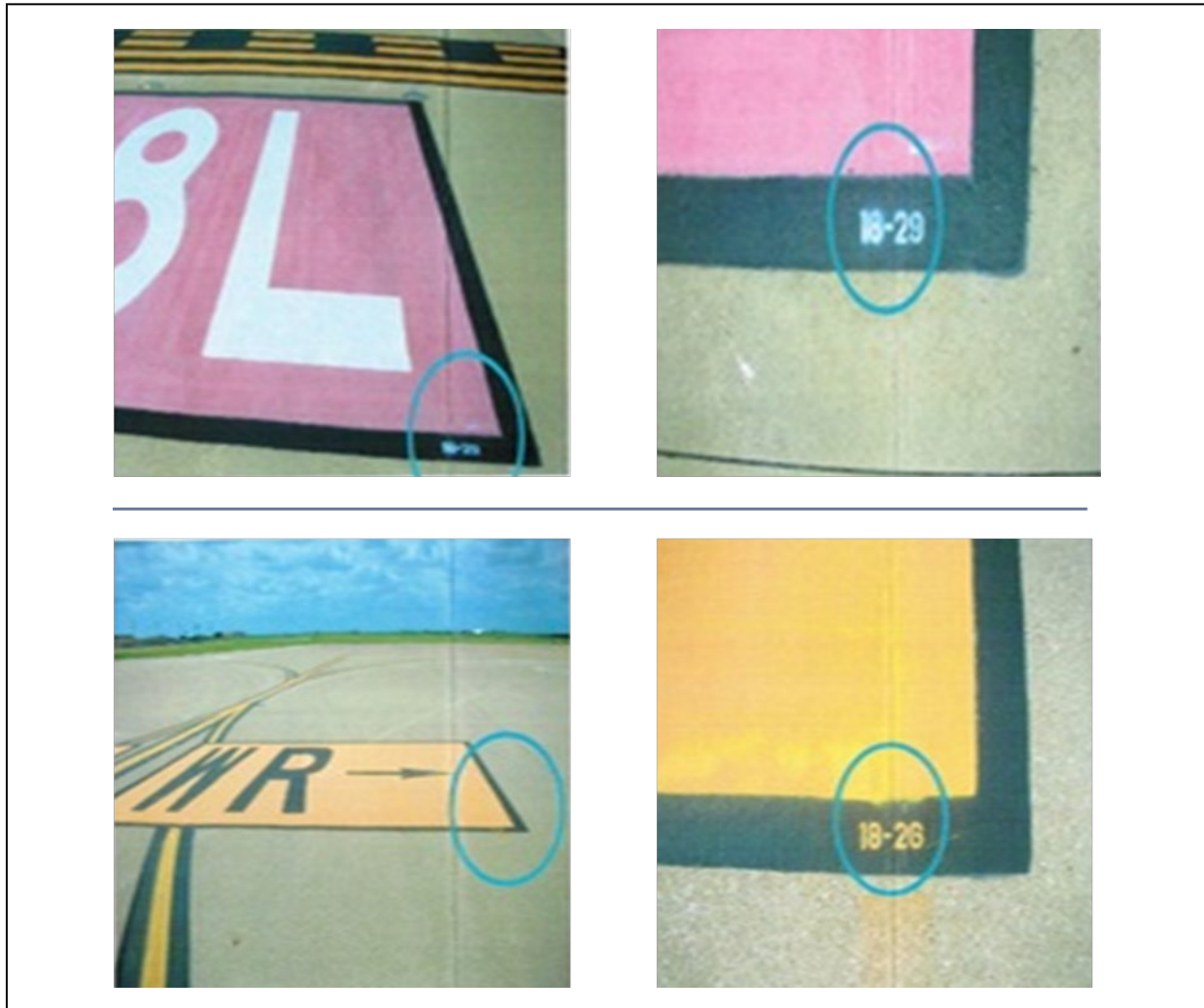

1.3.8 Personnel involved in the application of airfield surface markings should complete training which includes surface preparation, removal and application of surface markings, and maintenance standards.

1.3.9 Use of Stencil Templates.

All gaps created when painting surface markings using a stencil template must be filled in. For example, the surface painted holding position sign shown in [Figure D-5](#) contains no stencil gaps. Airports certified under Part 139 must rectify any gaps during the next painting project.

1.4 **Enhanced Conspicuity of Surface Markings on Concrete Pavements and Light Colored Pavements.**

Surface markings that cannot be seen by pilots and other individuals operating on paved airfield surfaces are ineffective. Two proven techniques that help airport operators enhance the degree of contrast (conspicuity) of surface markings are (1) outlining surface markings with black borders on concrete pavements and light-colored pavements and (2) placing glass beads in paint. However, glass beads are not to be used in black paint, including numerals and inscriptions found in [Appendix B, Table 1-1](#) serves as a general guide for determining when existing asphalt concrete surfaces or asphalt treated surfaces may be classified as a light-colored pavement, i.e., when to outline a required surface marking with a black border.

Table 1-1. General Guidelines for Painting a Black Border

Pavement Surface Type	Age of Pavement Surface ¹		
	New	Up to 2 years old	Over 2 years old
Portland Cement Concrete	Yes	Yes	Yes
Asphalt Concrete	No	No	Yes
Asphalt Treated	No	No	Yes

Note 1: This table serves only as a general guide since an existing asphalt pavement at one airport location may not experience the same rate of surface color deterioration as at another airport location.

1.4.1 Technique 1 – Outlining Surface Markings with Black Borders on Concrete Pavements and Light-Colored Pavements.

The degree of contrast (conspicuity) between surface markings on light-colored pavements, in particular on concrete pavements and older asphalt pavements, can be increased by outlining all edges of the surface marking with a black border. [Appendix C](#) provides illustrations of recommended patterns for various surface markings outlined in black. Black borders, except for enhanced taxiway centerline applications, are 6 inches (15 cm) or greater in width to enhance the conspicuity of certain painted surface markings on concrete pavements and light-colored pavements. The borders for the outside dashes of the enhanced taxiway centerline marking can range from 3 to 6 inches (7.5 to 15 cm). See [Table 1-2](#) for surface markings that are required or recommended to have black borders.

1.4.1.1 **Surface Markings that Require Black Borders.**

1. Runway centerline marking (per paragraph 2.4).
2. Runway threshold marking (per paragraph 2.5).
3. Runway displaced threshold marking (per paragraph 2.9).
4. Runway threshold bar marking (per paragraph 2.9.1).
5. Runway aiming point marking (per paragraph 2.6).
6. Runway landing designator marking (per paragraph 2.3).
7. Runway touchdown zone markings (per paragraph 2.7).
8. All holding position markings (per paragraphs 3.2, 3.3, 3.4, and 3.5).
9. Intermediate holding position marking for taxiway/taxiway intersections (per paragraph 3.6).
10. All taxiway centerline markings on taxi routes designated as Low Visibility Operations (LVO) surface movement guidance and control system (SMGCS) routes (per paragraph 4.2).
11. Enhanced taxiway centerline marking (per paragraph 4.3).
12. Surface painted holding position sign marking (per paragraph 4.5).
13. Geographic position marking (per paragraph 4.11).
14. Non-movement area boundary marking (per paragraph 5.4).

1.4.1.2 **Surface Markings Recommended for Black Borders.**

This AC strongly recommends outlining all other markings not listed paragraph 1.4.1.1, particularly taxiway centerlines per paragraph 4.2.

Table 1-2. Guidelines for Black Borders and Glass Beads

Marking	Black Border	Glass Beads
Runway centerline marking (per paragraph <u>2.4</u>).	Required	Required
Runway threshold marking (per paragraph <u>2.5</u>).	Required	Required
Runway displaced threshold marking (per paragraph <u>2.9</u>).	Required	Required
Runway threshold bar marking (per paragraph <u>2.9.1</u>).	Required	Required
Runway aiming point marking (per paragraph <u>2.6</u>).	Required	Required
Runway landing designator marking (per paragraph <u>2.3</u>).	Required	Required
Runway touchdown zone markings (per paragraph <u>2.7</u>).	Required	Required
Runway edge marking (per paragraph <u>2.8</u>).		Recommended
Runway demarcation bar marking (per paragraph <u>2.9.3</u>).		Recommended

Marking	Black Border	Glass Beads
All holding position markings used on runways, taxiways, and holding bays and used to indicate ILS or precision obstacle free zone (POFZ) protected areas (per paragraphs <u>3.2</u> , <u>3.3</u> , <u>3.4</u> , and <u>3.5</u>).	Required	Required
Intermediate holding position marking for taxiway/taxiway intersections (per paragraph <u>3.6</u>).	Required	
Taxiway centerline markings (per paragraph <u>4.2</u>).	Recommended	Required
All taxiway centerline markings on taxi routes designated as LVO/SMGCS routes (per paragraph <u>4.2</u>).	Required	Required
Enhanced taxiway centerline markings per paragraph <u>4.3</u> .	Required	Required
Taxiway edge marking (per paragraph <u>4.4</u>).		Recommended
Geographic position marking (per paragraph <u>4.11</u>).	Required	Required
Surface painted signs for holding position signs (paragraph <u>4.5</u>), taxiway direction signs (paragraph <u>4.6</u>), taxiway location signs (paragraph <u>4.7</u>), gate destination signs (paragraph <u>4.8</u>), and apron entrance point signs (paragraph <u>4.9</u>).	Required	Required
Non-movement area boundary marking (per paragraph <u>5.4</u>).	Required	Required
All other markings not listed paragraph <u>1.4.1.1</u> .	Recommended	
<p>Note 1: Table 1-1 and Table 1-2 are interrelated. Surface markings per Table 1-2 that require black borders may initially be deferred for the case of new, dark-colored asphalt concrete/new asphalt treated pavement surfaces for up to 2 years as per Table 1-1. This case applies to dark, newly constructed asphalt concrete/newly asphalt treated pavements. New light-colored asphalt projects require the black borders upon completion.</p> <p>Note 2: Surface markings identified per Note 1 that sufficiently fade before 2 years, shall receive black borders.</p>		

1.4.2 Technique 2 – Use of Glass Beads on Permanent Pavement Markings.

Glass beads identified in Item P-620 of AC 150/5370-10 are an effective means of enhancing the conspicuity of surface markings when aircraft and vehicles operate at night, during low-visibility conditions, or when the pavement surface is wet. The glass beads used in the below applications should meet the specifications found in AC 150/5370-10, Item P-620. If Type IV glass beads that have a larger diameter are used, then they should only be applied in higher-built materials, such as TT-P-1952E-Type III waterborne paint, epoxy, methyl methacrylate, or preformed thermoplastic. The beads used in the intermix and on the surface of preformed thermoplastic should meet the specifications found in AC 150/5370-10, Item P-620.

Precaution: Glass beads should never be used in black paint, including numerals and inscriptions found in Appendix B. See Table 1-2 for surface markings that are required or recommended to have glass beads.

Glass Bead Requirement
Per AC 150/5370-10, Paragraph 620-3.5, Application
(General)

Glass beads shall be distributed upon the marked areas at the locations shown on the plans to receive glass beads immediately after application of the paint. A dispenser shall be furnished that is properly designed for attachment to the marking machine and suitable for dispensing glass beads. Glass beads shall be applied at the rate(s) shown in Item P-620, Table 1 of AC 150/5370-10. Glass beads shall not be applied to black paint or green paint, including numerals and inscriptions found in Appendix B. Type I beads must be used in the red or pink background paint on surface painted holding position sign (SPHPS) and geographic position marking (GPM). Using Type III beads washes out the background color, resulting in less contrast between the inscription and background. Glass beads shall adhere to the cured paint or all marking operations shall cease until corrections are made. Different bead types shall not be mixed, with the exception of those supplied on the surface of preformed thermoplastic (to comply with the bead gradation chart found in AC 150/5370-10, Item P-620). Regular monitoring of glass bead embedment should be performed.

1.5 **No-Taxi Islands.**

1.5.1 Safety Enhancements.

For this advisory circular, the term “no-taxi island” is a category of island having safety enhancements. The safety enhancements mentioned by this paragraph are found along a section of a taxiway. The safety enhancements are achieved by painting specific surface markings and, depending on the taxiway’s location, complying with standard taxiway design features under AC 150/5300-13, complying with standard vertical signage under AC 150/5340-18, and complying with standard taxiway edge lighting under AC 150/5340-30, *Design and Installation Details for Airport Visual Aids*. The following applications of no-taxi islands serve to mitigate taxiway excursions, runway incursions, or certain types of wrong runway takeoffs. Explanations of the most common applications are listed below along with subparagraph 1.5.2 which provides sequential practices for applying surface markings, types of physical reconstruction of a taxiway section, and figures for visual clarification of their applications.

- 1.5.1.1 **Case 1:** This application involves taxiway excursions into unpaved areas or onto a paved area not intended for aircraft operations. Documented examples are (a) compound taxiing turns along consecutive taxiway-taxiway intersections as shown in Figure 1-6 and (b) an extra-long section of a taxiway that borders a large paved area(s). The objective for this application is to provide clearer, visual cues along such sections of a taxiway so that pilots can recognize the edges of usable full-strength taxiway from non-maneuvering areas. Under this application the safety

enhancement is generally achieved through surface painted markings alone.

- 1.5.1.2 **Case 2:** This application involves runway incursions caused by terminals or aprons whose taxiways offer direct access to a runway; in some cases pilots have more immediate access to the runway. The most common documented examples are illustrated in Figure 1-7 (runway lacks a full-length parallel taxiway), and Figure 4-3 of AC 150/5300-13, (runway has a full-length parallel taxiway). In both cases, a taxi route beyond the apron offers direct taxi access to a runway. The objective for this application is to create turning maneuvers for pilots along a reconfigured taxi route while on the apron or just beyond the apron prior to entering the runway. Under this application the safety enhancement is achieved by either (1) creating no-taxi islands on aprons which are generally accomplished through surface painted marking(s), namely, continuous taxiway edge markings, taxiway shoulder markings, and greenish no-taxi island(s), and possibly installing vertical signage or (2) removing/ reconfiguring/ constructing a taxiway beyond the apron.
- 1.5.1.3 **Case 3:** This application involves runway incursions and certain types of wrong-runway takeoffs caused by an oversized entrance taxiway. A documented example is a single entrance taxiway with excessive width located on a sizable paved area that abuts the runway entrance as shown in Figure 1-8 (figure shows new taxiway fillet design methodology from AC 150/5300-13). The objective for this application is to downsize this oversized entrance taxiway to the standard taxiway width plus having specific taxiway surface marking(s) and relocation of vertical signage closer to the taxiway centerline. Excess pavement usually provides enough surface area to obtain the standard taxiway shoulder width. This action enhances the recognition of the location of the runway holding position by creating a more distinguishable, *channeled entrance* to the assigned runway. Regarding wrong-runway takeoffs, this application may mitigate wrong runway takeoffs when an excessively wide taxiway entrance serves two runway ends that are in very close proximity to each other. Under these applications the safety enhancement is achieved by creating greenish no-taxi islands (a design standard for entrance taxiways) after downsizing excessive taxiway width and by the relocation of standard surface painted markings and placement of vertical signage. Physical reconstruction of the entrance taxiway or the removal of excessive pavement may not be necessary. Making changes, in this case, may also require changes to runway/taxiway lights and airfield guidance signs.
- 1.5.1.4 **Case 4:** This application involves runway incursions caused by certain multi-entrance taxiways located on a single, expansive paved area that abuts the runway; usually located at the runway end. A documented example is an excessive paved area with multi-parallel entrance taxiways that lack greenish no-taxi islands as shown in Figure 1-9 (figure shows

new taxiway fillet design methodology from [AC 150/5300-13](#)). As illustrated in the “before” example, the continuous pavement lacks (1) standard entrance taxiway widths, (2) greenish no-taxi islands (a design standard for entrance taxiways), (3) standard vertical signage for each taxiway entrance, and (4) standard dual-continuous taxiway edge surface markings on both sides of each taxiway entrance. The objective for this application is to obtain standard width entrance taxiways by the insertion of greenish no-taxi islands which in turn, allow each reconfigured entrance taxiway to have its own, unique taxiway identifier, surface markings, and vertical signage; thus creating a unique tunnel effect. This action enhances the recognition of each runway holding position and allows for the proper placement of their vertical signage and other surface markings. Under this application the safety enhancement is achieved by creating no-taxi islands through the placement of standard surface painted markings and standard vertical signage with or without the physical reconstruction of the entrance taxiway(s).

1.5.2 Sequential Process for Safety Enhancements.

The following descriptions provide sequential practices for applying surface markings and provide illustrations to achieve the applications explained in subparagraph [1.5.1](#).

1.5.2.1 **Case 1A.**

Taxiway section has stabilized/paved taxiway shoulders with or without paved areas beyond the taxiway shoulders, see [Figure 1-6](#).

1. First, paint the dual-continuous taxiway edge marking per paragraph [4.4](#) of this advisory circular.
2. If excursions continue, then paint yellow taxiway shoulder markings according to paragraph [4.10.4](#) of this advisory circular.
3. If excursions persist, then, for the taxiway section suffering continued excursions, apply a green border that starts beyond the end point of the yellow taxiway shoulder markings to create a visually green no-taxi island(s). The depth of the green no-taxi island must be at least equal to the width of standard taxiway shoulder for the largest taxiway design group using this taxiway. This action may require adding stabilized pavement. If pavement exists, apply green paint in accordance to Federal Standard 595, Color Number #34108. For locations lacking paved areas beyond the taxiway shoulder(s), the green border may be achieved by planting grass, installing green artificial turf, or, for desert locations, placement of an earthen material that provides a more definitive, visual distinction between the shoulders and the ground areas. Note: Because of the variability in the shape of existing taxiway geometries, these sequential marking steps may not be fully achieved. For example, there is insufficient area between the non-parallel taxiways to obtain the standard width of a green border beyond the end point of standard taxiway shoulder

markings. Common examples are taxiways in such close proximity to each other that they create small unusable odd-shape/circular areas. In such situations, two acceptable options are to (1) paint yellow taxiway shoulder markings with a green border onto the available taxiway shoulder(s) such that all or some of the green border is painted between the yellow taxiway shoulder markings or (2) simply paint the available shoulder green without the yellow taxiway shoulder markings. For severe situations, the depth of the green border should, to the extent possible, equal the width of the standard yellow taxiway shoulder markings for the largest taxiway design group using the site.

1.5.2.2 **Case 1B.**

Taxiway section lacks stabilized/paved taxiway shoulders, see [Figure 1-6](#).

1. First paint the dual- continuous taxiway edge marking per paragraph [4.4](#) of this advisory circular.
2. If excursions continue, then plant grass or install green artificial turf beyond the edges of the taxiway for a distance equal to at least the width of standard taxiway shoulder for the largest taxiway design group using this taxiway.
3. If excursions persist, then construct a stabilized/paved standard taxiway shoulder width per [AC 150/5300-13](#) that is painted with yellow taxiway shoulder markings per paragraph [4.10.4](#) of this advisory circular, plus create (with or without stabilized pavement) the green border per Case 1A (3).

1.5.2.3 **Case 2A.**

Aprons with a taxiway having direct access to a runway which lacks a parallel taxiway, see [Figure 1-7](#).

1. First, reconfigure taxiway route(s) located on the apron to create a no-taxi island in front of the existing taxiway serving the runway. This action produces multiple turning operations for pilots. In some cases, such as aprons that lack sufficient space to create the no-taxi island affect, construct a taxiway(s) off the sides of the apron running parallel to the runway to create the desired turning maneuver for pilots. The geometry of the taxiways created by the marking of the no-taxi islands must be designed following the criteria of [AC 150/5300-13](#).
2. For no-taxi islands located on the apron, paint the dual-continuous taxiway edge marking per paragraph [4.4](#).
3. If runway incursions continue or taxing through the no-taxi island occurs, then paint yellow taxiway shoulder markings according to paragraph [4.10.4](#).
4. If runway incursions or taxing through the no-taxi island persist, then apply a green border starting from the end point of yellow taxiway

shoulder markings to create a visually green no-taxi island(s). The depth of the green no-taxi island must be at least equal to the width of standard taxiway shoulder for the largest taxiway design group using this taxiway. The border is green paint per Federal Standard 595, Color Number #34108.

5. For both subparagraphs 3 and 4 above, install any required or deemed necessary vertical taxiway signage in accordance with AC 150/5340-18 and,
6. Paint any required or deemed necessary surface markings per this advisory circular.

1.5.2.4 **Case 2B.**

Aprons with direct access taxiways to runways that have a parallel taxiway, see Figure 4-2 of AC 150/5300-13A.

1. As illustrated in Figure 4-3 of AC 150/5300-13A, relocate the existing taxiway between the apron and the parallel taxiway to a new location. This action produces the multiple turning operations for pilots prior to entering the runway. The geometry of the new location taxiways must be designed following the criteria of AC 150/5300-13.
2. Install required or deemed necessary surface markings and vertical signage for the new taxiway connector.
3. Paint the abandoned taxiway to produce a green no-taxi island or remove the abandon taxiway pavement.
4. Install taxiway edge lights or reflectors in accordance with AC 150/5340-30. Vertical taxiway edge reflectors or lights will enhance the identification of islands to pilots during nighttime, low visibility and during snow conditions when markings are not clearly visible.

1.5.2.5 **Case 3.**

Single Entrance Taxiways with Excessive-Width, Figure 1-8.

1. Reduce the excessive width of the entrance taxiway by painting dual-continuous taxiway edge markings (paragraph 4.4) that indicate the edges of the prescribed standard taxiway width per AC 150/5300-13 for the largest taxiway design group using the taxiway entrance; plus
2. Convert excessive pavement into, if possible, standard taxiway shoulder widths having painted standard yellow taxiway shoulder markings per paragraph 4.10.4 of this advisory circular; plus
3. Create green no-taxi islands for the reconfigured entrance taxiway starting from the end of the end point of the yellow taxiway shoulder marking. The depth of the green border must be at least equal to the width of the standard taxiway shoulder required for the largest taxiway

design group using the taxiway entrance. The border is green paint per Federal Standard 595, Color Number #34108; plus

4. Relocate/install all missing vertical signage in accordance with AC 150/5340-18. Install taxiway edge lights or reflectors in accordance with AC 150/5340-30. Vertical taxiway edge reflectors or lights will enhance the identification of islands to pilots during nighttime, low visibility and during snow conditions when markings are not clearly visible.

1.5.2.6

Case 4.

Multi-Entrance Taxiways located on single, expansive pavement abutting the runway, see Figure 1-9.

1. If the width of any entrance taxiway exceeds the standard taxiway width, then follow instructions in Case 3.
2. If none of the entrance taxiways exceed the standard width, then paint standard yellow taxiway shoulder markings per paragraph 4.10.4 of this advisory circular; plus
3. Create green no-taxi islands for each taxiway entrance starting from the end of the yellow taxiway shoulder markings. The depth of the green border must be at least equal to the width of the standard taxiway shoulder required for the largest taxiway design group using the taxiway entrance. The border is green paint per Federal Standard 595, Color Number #34108; plus
4. Relocate/install all missing vertical signage for each entrance taxiway in accordance with AC 150/5340-18. Install taxiway edge lights or reflectors in accordance with AC 150/5340-30. Vertical taxiway edge reflectors or lights will enhance the identification of islands to pilots during nighttime, low visibility and during snow conditions when markings are not clearly visible.

Figure 1-6. Case 1

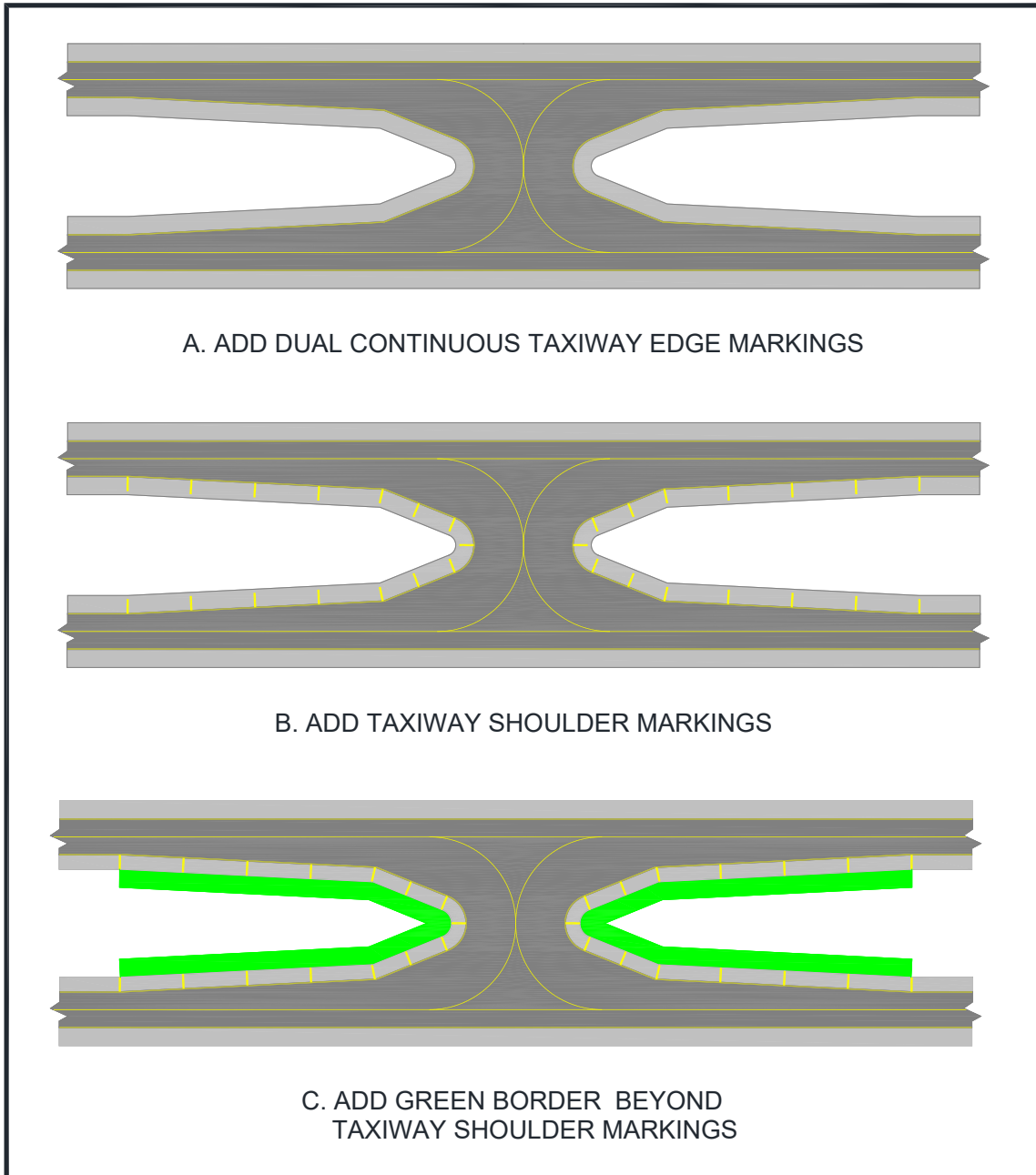
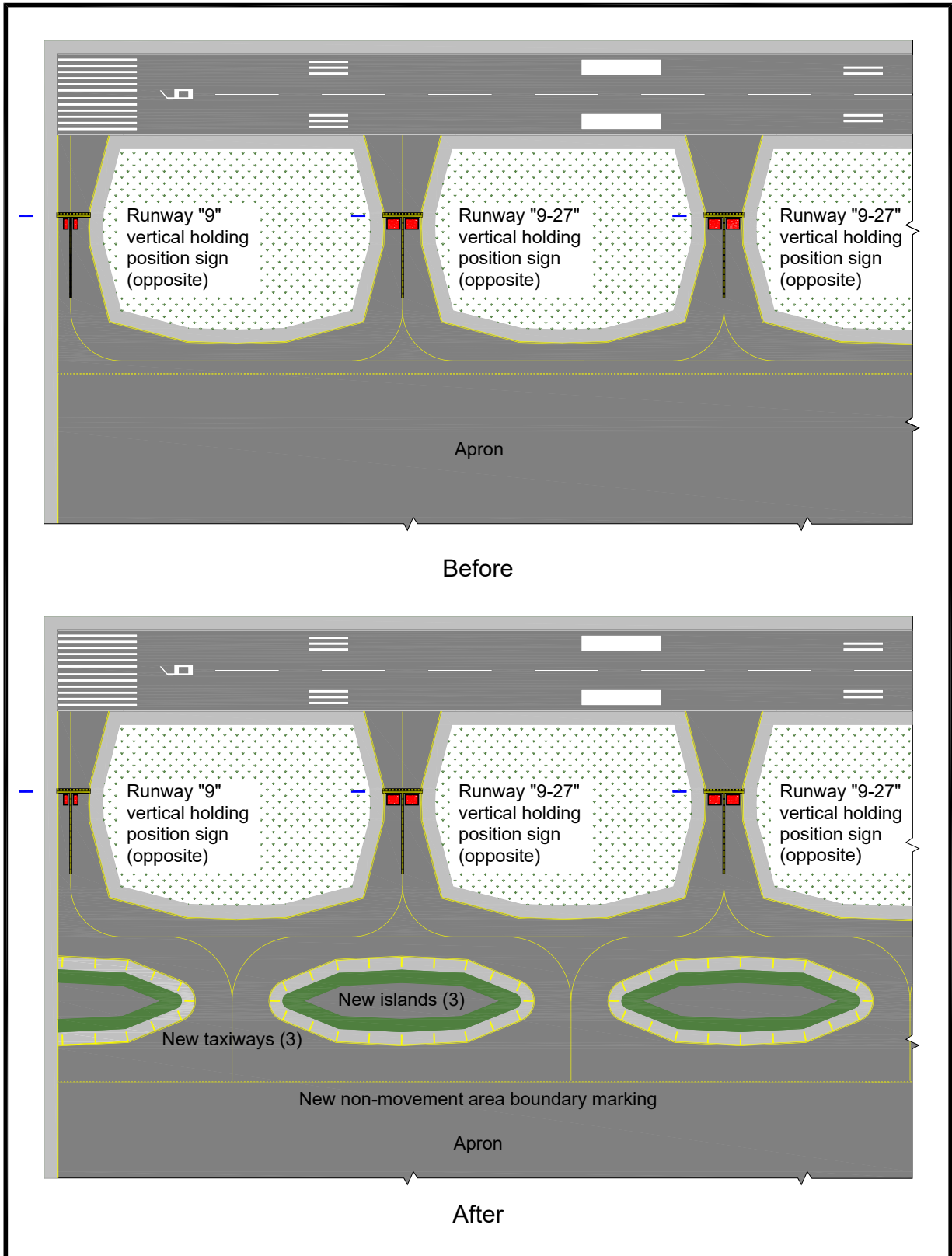

Figure 1-7. Case 2



Before

After

Figure 1-8. Case 3

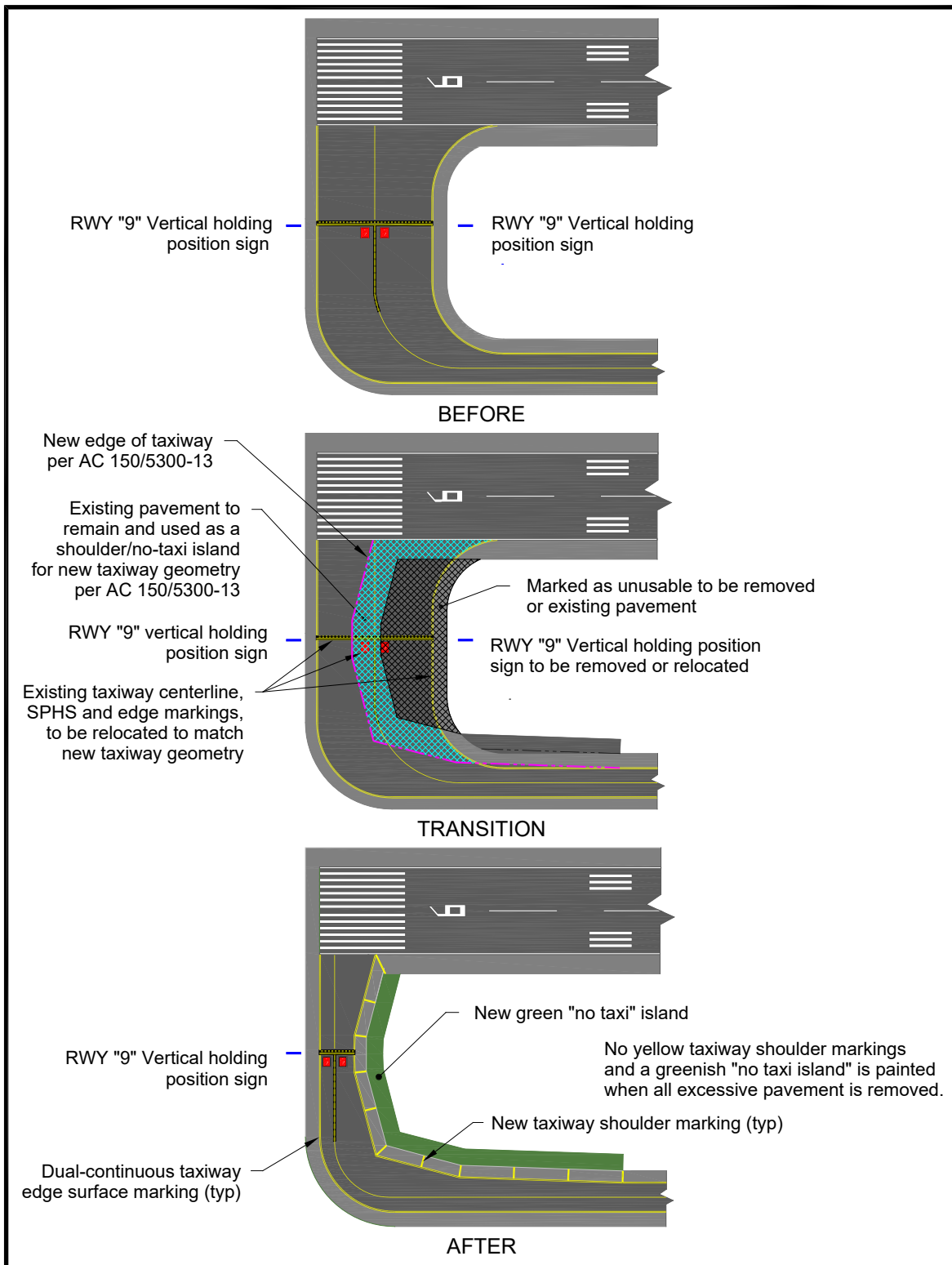

Notes: Airport operator has the option to remove all excess pavement.
 New green "No Taxi Island" if not all excessive pavement was removed.

Figure 1-9. Case 4

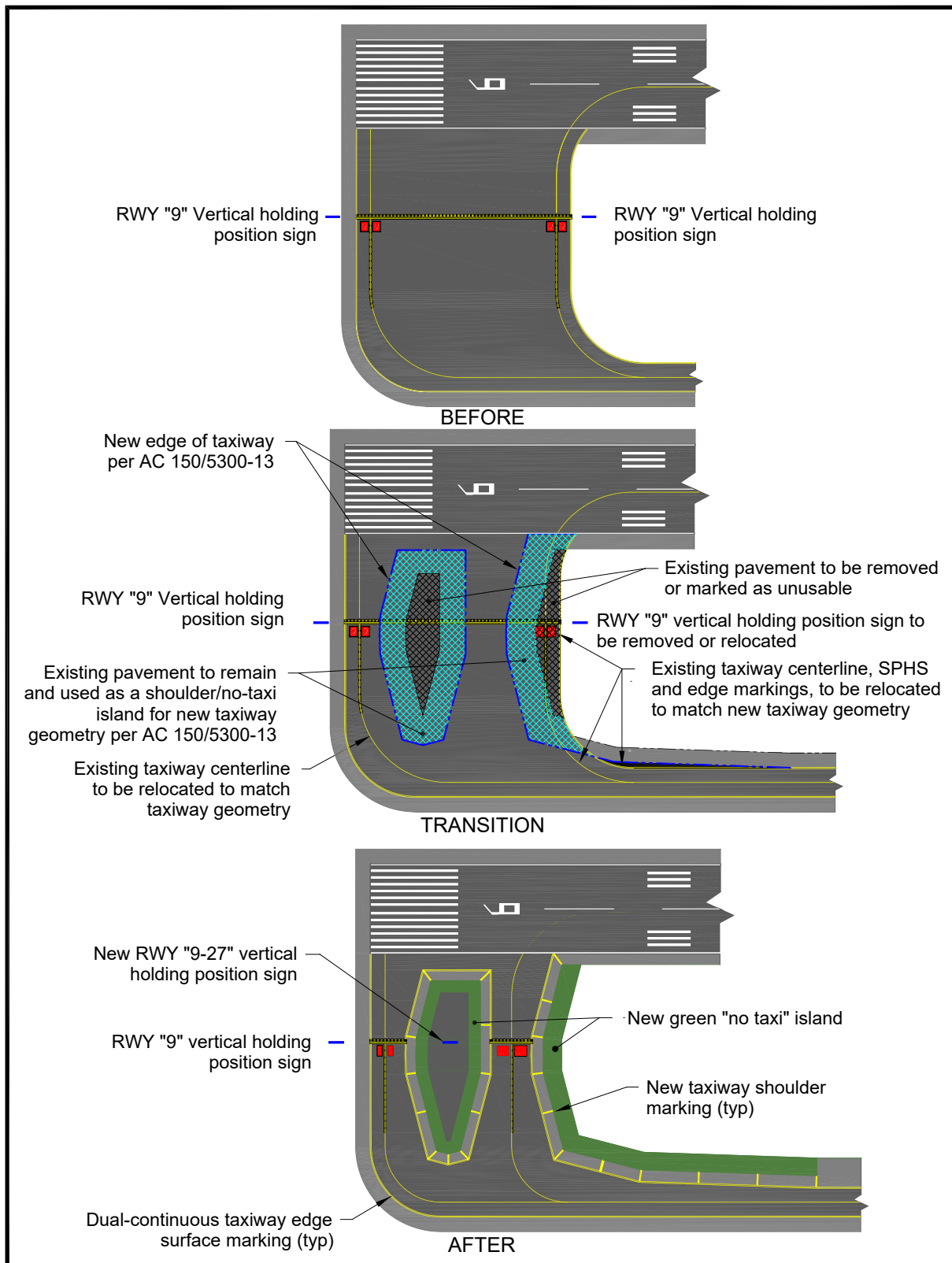

Page Intentionally Blank

CHAPTER 2. SURFACE MARKINGS FOR RUNWAYS

2.1 Application.

The minimum requirements for surface marking schemes used for runways are a direct function of the approach category for each runway threshold and the existence of displaced thresholds, stopways, blast pads, or extra-wide shoulders. Runways having the same approach category off both runway thresholds will show the same surface marking scheme from threshold to threshold (with some exceptions, such as the runway designator). In comparison, runways with different approach categories will show two different surface marking schemes. The complete runway surface marking schemes required by a runway combine Table 2-1 requirements with the physical structure, such as blast pads or stopways, and usage of the runway.

- 2.1.1 Table 2-1 identifies the minimum standard surface marking schemes for paved runways based upon the approach category. Figure A-1, Figure A-2, Figure A-3, and Figure A-6 provide the dimensional standards for the surface marking schemes. An airport operator may paint a runway with additional surface marking schemes beyond those required, such as a visual runway with runway edge markings or the aiming point marking, if deemed necessary by the FAA. Furthermore, surface markings beyond those described in Table 2-1 are required to support particular operations, such as a displaced threshold, or to identify runway related features, such as blast pads, stopways, or Engineered Materials Arresting Systems (EMAS).

Table 2-1. Minimum Required Runway Surface Marking Schemes for Paved Runways

Runway Surface Marking Scheme	Threshold Approach Category		
	Visual Approach	Non-precision Approach (and approaches with vertical guidance not lower than $\frac{3}{4}$ - statute mile visibility)	Precision Approach (Approaches with lower than $\frac{3}{4}$ - statute mile visibility)
Landing Designator (par. <u>2.3</u>)	X	X	X
Centerline (par. <u>2.4</u>)	X	X	X
Threshold Markings (par. <u>2.5</u>)	Note 1	X	X
Aiming Point (par. <u>2.6</u>)	Note 2	Note 3	X
Touchdown Zone (par. <u>2.7</u>)			X
Edge Markings (par. <u>2.8</u>)	Note 4	Note 4	X

Note 1: Required on runways serving approach categories C and D airplanes and for runways used, or intended to be used, by international commercial air transport.

Note 2: Required on 4,200-foot (1,280 m) or longer runways serving approach categories C and D airplanes.

Note 3: Required on 4,200-foot (1,280 m) or longer instrumented runways.

Note 4: Used when the full runway pavement width may not be available for use as a runway.

- 2.1.2 Runways with a displaced threshold, blast pad, stopway, or extra-wide shoulders require additional marking schemes not identified in Table 2-1. These surface marking schemes and others not in Table 2-1 are discussed separately in this AC. See AC 150/5300-13 for detailed information about the location of displaced thresholds, blast pads, and stopways.

Painting Note No. 1

Application of Proportioning Runway Markings for Non-Standard Runway Widths

The dimensional size for the runway surface marking promulgated by this AC is based on the assumption that the runway has a standard runway width as prescribed by AC 150/5300-13. For convenience, the standard widths are shown in Table 2-2 below.

Airport operators with non-standard runway widths may, for specified surface markings, proportionally adjust the marking's width to be less than the standard scheme. Under non-standard conditions, the width of marking is in direct proportion to the available runway width. However, the corresponding length for the marking is never reduced.

Subsequent paragraphs in this AC will specify, via a green-shaded solution box, those runway surface markings that may be proportioned. The absence of a green-shaded solution box in a subsequent paragraph implies that that runway surface marking, such as the runway centerline, is not to be decreased in width even if other nearby runway surface markings are proportionally adjusted.

2.2 **Interruption of Runway Surface Markings.**

At the intersection of two runways, the surface markings of one runway are, with the possible exception of runway edge markings (such as V-shaped runways), fully displayed through the intersection while the surface markings of the other runway are completely interrupted. This process of removing runway surface markings from one runway establishes an order of precedence among the different runways.

2.2.1 Order of Precedence.

2.2.1.1 The order of precedence for displaying the runway surface marking schemes of one runway over the other runway at the intersection of these runways should follow this order:

1. Precision approach runway, Category III.
2. Precision approach runway, Category II.

3. Precision approach runway, Category I.
4. Non-precision approach runway.
5. Visual runway.

2.2.1.2 For an intersection of runways of the same precedence, the preferred higher precedence runway is the one having the lowest approach minima or the runway end most often used.

2.2.2 Lesser Precedence Runways.

The manner in which a lesser precedence runway intersects a higher precedence runway may require the shifting or complete removal of certain surface markings that fall within the intersection. As shown in [Figure A-5](#), the most affected surface markings are the runway centerline, runway edge markings, aiming point markings, and runway touchdown zone markings. The latter two runway markings may have implications when shifted or removed. See paragraphs [2.2.3](#) and [2.6](#) for shifting an aiming point marking, and see paragraph [2.7](#) for removing touchdown zone markings.

2.2.3 Consequences When Shifting the Aiming Point Markings.

[Figure A-4](#) shows one possible conflict that could occur when the aiming point markings are relocated.

2.2.3.1 When the aiming point markings of a given runway that are in the intersection of two runways need to be moved more than 200 feet (61 m) away from the existing threshold, the airport operator will have to displace the existing threshold or designate a new runway end (threshold) in order to retain the distance between the threshold and the aiming point marking as illustrated in the bottom illustration of [Figure A-4](#). The preferred distance to be maintained between the newly designated threshold and the shifted aiming point marking is 1,020 feet (311 m); see paragraph [2.6](#).

2.2.3.2 Runways with an approach landing aid, such as Precision Approach Path Indicators (PAPIs) or Visual Approach Slope Indicators (VASIs), which are co-located with the aiming point markings, can be negatively affected when an excessive shifting of the aiming point marking occurs. The consequence could be a non-compatible threshold crossing height for landing airplanes. When the aiming point markings are shifted more than 60 feet (18.3 m), the co-located PAPI or VASI should be evaluated for relocation to provide a correct vertical guidance to pilots. See [AC 150/5340-30](#) to determine if the impact of shifted aiming point markings warrants a relocation of the co-located PAPI or other runway approach aids. Contact FAA Air Traffic Organization (ATO) Technical Operations regarding Federal PAPIs and VASIs.

2.2.3.3 For landing safety, the FAA requires that whenever the distance between the threshold and aiming point markings is 1,220 feet (372 m) or more, the airport operators place a note in the Chart Supplement to inform pilots

about the increased distance existing between the threshold and the aiming point markings.

2.2.4 V-Shaped Runway Ends Configuration.

The V-shaped runway ends configuration is a pavement geometry where two runway ends commence from the same location but proceed in different directions (see [Figure 1-2](#)). This undesirable geometry requires a special shifting procedure of the runway landing designator marking of the lesser precedence runway farther down the runway than prescribed by [paragraph 2.3](#). The special procedure is as follows. On the lesser order runway, locate the point on its runway centerline that is perpendicular to the inside common corner of the two intersecting runways. Once this base point is located, move this base point 20 feet (6.5 m) down the runway centerline to relocate the bottom of the letter or number(s) used for the runway landing designator. For an intersection of runways of the same precedence, the preferred higher precedence runway is the one having the lowest approach minimums or the runway end most often used.

Figure 2-1. V Geometry

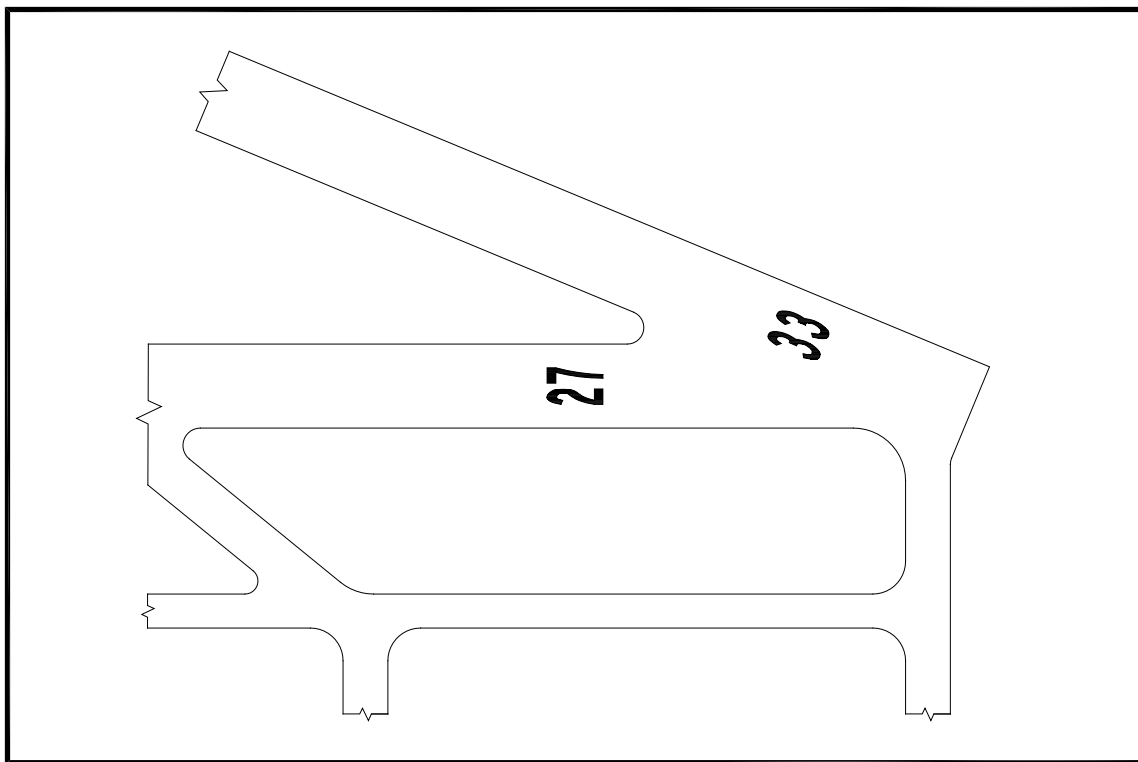

Safety Notice No. 2

Wrong-Runway Takeoffs Mitigation

In an effort to eliminate the possibility of a “wrong-runway” takeoff operation by pilots, the airport operator should reconstruct V-shaped runway geometries to a different geometry, possibly an X-shaped geometry.

2.3 Runway Landing Designator Marking.

2.3.1 Purpose.

The runway landing designator marking identifies a runway end.

2.3.2 Requirement.

See Table 2-1.

2.3.3 Location.

Runway landing designator marking(s) must be located from the runway threshold per Figure A-1, Figure A-2, Figure A-3, or from the displaced threshold per Figure A-7. All these figures show the start location for both types of thresholds.

2.3.4 Color.

Runway landing designator markings are white. See paragraph 1.4 and Table 1-1 for required techniques to enhance this marking.

2.3.5 Characteristics.

1. A runway landing designator marking consists of a number comprising one or two digits. When parallel runways exist, the number is further supplemented with a letter.
2. A single-digit runway landing designation number is never preceded by a zero. Runway landing designators are centered in accordance with the green box entitled “Centering of Runway Landing Designators - Width of Rectangular Boxes.”
3. For single runways, dual parallel runways, and triple parallel runways, the designator number is the whole number nearest the one-tenth of the magnetic azimuth along the runway centerline when viewed from the direction of approach. For example, where the magnetic azimuth along the runway centerline is 183 degrees, the runway designator marking would be 18; for a magnetic azimuth of 87 degrees, the runway designation marking would be 9. For a magnetic azimuth ending in the number “5” such as 185 degrees, the runway designator marking may be either 18 or 19.
4. On four or more parallel runways, one set of adjacent runways is numbered to the nearest one-tenth of the magnetic azimuth and the other set of adjacent runways is numbered to the next nearest one-tenth of the magnetic azimuth.

5. For parallel runways, each runway landing designator number must be supplemented by a letter, in the order shown from left to right when viewed from the direction of approach as prescribed by the following marking criteria. Different labeling patterns than those prescribed below are permissible under certain circumstances as identified in subparagraph 6 below.
 - a. Two parallel runways having a magnetic azimuth of 182 degrees are designated “18L” and “18R.”
 - b. Three parallel runways having a magnetic azimuth of 87 degrees are designated “9L,” “9C,” and “9R.”
 - c. Four parallel runways having a magnetic azimuth of 324 degrees are designated “32L,” “32R,” “33L,” and “33R.”
 - d. Five parallel runways having a magnetic azimuth of 138 degrees are designated “13L,” “13R,” “14L,” “14C,” and “14R” or “14L,” “14R,” “13L,” “13C,” and “13R.” Other combinations exist for this case. See subparagraph 6 below.
 - e. Six parallel runways having a magnetic azimuth of 83 degrees are designated “8L,” “8C,” “8R,” “9L,” “9C,” and “9R. See subparagraph 6 below.
 - f. Seven parallel runways having a magnetic azimuth of 85 degrees – the runways would be designated “8L,” “8C,” “8R,” “9L,” “9C,” “9R,” and “10.” Other combinations exist for this case. See subparagraph 6 below.
6. There are certain runway placements where the surface marking schemes for parallel runways provided in subparagraph 5 above may not be appropriate because their orientation may lead to pilot confusion. For example, the marking scheme recommended for parallel runways on the same side of a terminal is to follow subparagraph 5 above. However, when two parallel runways are separated by a large distance, as by a central terminal or several terminals, it is preferable to designate the runways as non-parallel runways to avoid pilot confusion. Another case that may cause pilot confusion is a turf runway that is parallel to a paved visual runway but at a great distance from a higher precedence paved runway. In general, the airport operator should carefully choose how to mark parallel runways to eliminate pilot confusion.

2.3.6 The appearance of the letters and numbers used for runway landing designator markings are in the form and proportion shown in Figure A-6. The spacing between numbers and letters are as shown in Figure A-1, Figure A-2, Figure A-3, and Figure A-6. However, with the exception of the numerals 6 and 9, all numerals and the letters L, C, and R are 60 feet (18.3 m) in height. Numerals 6 and 9, which are 63 feet (18.9 m) in height, follow the Rule of 69. That is, although the numerals 6 and 9 are taller, the 3-foot tips of the numerals are ignored so that their separations from the threshold markings, the letters L-C-R, the first runway centerline, and the start of the runway threshold remain as shown in Figure A-1, Figure A-2, and Figure A-3.

Painting Note No. 2

Centering of Runway Landing Designators Width of Rectangular Boxes

Runway landing designators are centered along the runway centerline in accordance with the width of the numeral(s) and the width of the letter.

An imaginary rectangular box contains the numeric runway landing designator whose height equals tallest numeral and whose width equals either (1) the width of a single numeral or (2) the total width of two numerals plus the required spacing between the numerals. A runway that requires the letters L, C, or R, will create a second rectangular box in the same fashion. See [Figure A-6](#) for widths of numerals and letters and horizontal spacing between numerals. See [Figure A-1](#), [Figure A-2](#), and [Figure A-3](#) for vertical spacing of rectangular boxes.

Example 1 - Runway 7R will consist of two rectangular boxes. The width of the rectangular box for the numeral 7 equals 23 feet (6.9 m) while the letter R has a width equal to 20 feet (6 m). Therefore, 23 feet (6.9 m) and 20 feet (6 m) are divided equally along the runway centerline.

Example 2 - Runway 14 will consist of a single rectangular box. Numeral 1 is 7 feet wide and numeral 4 is 25 feet wide, with a 15-foot space between them. The total width equals 47 feet (7 + 15 + 25) [14.3 m (2.1 + 4.6 + 7.6)]. Therefore, 47 feet (14.3 m) is divided equally along the runway centerline.

Note: Although the majority of 2-digit designators are centered equally along the runway centerline, example 2 results in the numeral 4 overlapping the runway centerline (unpainted). Other similar combinations, such as Runway 13, Runway 18, place the wider numeral along the unpainted runway centerline.

Painting Note No. 3

Application of Proportioning Runway Markings for Airplane Design Group (ADG) I Runway Width

Due to the space limitations on very narrow runways, the size and spacing of the numbers and letters are reduced only when necessary such that the painted runway landing designator is no closer than 2 feet (0.6 m) from the runway edge or runway edge markings. For example, this problem may occur when painting certain dual-numbered runway landing designators spaced 15 feet (4.5 m) apart on an ADG I runway width of 60 feet (18.3 m). In such cases, first reduce the 15-foot (4.5-m) spacing to 10 feet (3.1 m) and retain the size of numerals and letter per [Figure A-6](#). Second, reduce the 15-foot (4.5-m) spacing to 10 feet (3.1 m) and reduce the size of numerals and letter proportionally to maintain the 2-foot (0.6-m) edge or runway edge markings clearance.

2.4 Runway Centerline Marking.

2.4.1 Purpose.

The runway centerline marking identifies the physical center of the runway width and provides alignment guidance to pilots during takeoff and landing operations. For lighting provisions, see [AC 150/5340-30](#).

2.4.2 Requirement.

See [Table 2-1](#).

2.4.3 Location.

A runway centerline marking is located along the physical center of the runway width and spaced between the runway landing designation markings as shown in [Figure A-1](#), [Figure A-2](#), and [Figure A-3](#).

2.4.4 Color.

The runway centerline marking is white. See paragraph [1.1](#) and [Table 1-1](#) for required techniques to enhance this marking.

2.4.5 Characteristics.

A runway centerline marking consists of a line of uniformly spaced stripes and gaps and of uniform width.

1. The stripes are 120 feet (36.5 m) in length and the gaps are 80 feet (24.3 m) in length.
2. The minimum width of the stripes is:
 - a. 36 inches (90 cm) for precision runways.
 - b. 18 inches (45 cm) for non-precision runways.
 - c. 12 inches (30 cm) for visual runways.
3. To accommodate varying runway lengths, all adjustments to the uniform pattern of runway centerline stripes and gaps are made near the runway midpoint (defined as the distance between the two thresholds or displaced thresholds). Under such cases, reduce the lengths of both the stripes and gaps starting from midpoint and proceed toward the runway thresholds. Reduced stripes must be at least 80 feet (24 m) in length, and the reduced gaps must be at least 40 feet (12.3 m) in length. The affected stripes and gaps within the section should show a uniform pattern.

2.5 Runway Threshold Marking.

2.5.1 Purpose.

A runway threshold marking, commencing 20 feet (6 m) from the actual start point of runway threshold, closely identifies the actual beginning point of the runway threshold used for landings. For lighting provisions, see [AC 150/5340-30](#).

2.5.2 Requirement.

See Table 2-1.

2.5.3 Location.

The runway threshold marking starts 20 feet (6 m) from the actual start point of the runway threshold as shown in Figure A-1 and Figure A-2. This value remains the same even though a 10-foot (3-m) white threshold bar is introduced, such as for displaced thresholds or the addition of a blast pad or stopway, as shown in Figure A-9. Previously, when a displaced threshold was painted or a blast pad or stopway added, the 20-foot (6-m) dimension was increased to 30 feet (9 m) to accommodate the requirement for painting the runway threshold bar. When any runway threshold or displaced threshold is re-marked with threshold bar markings, or when a blast pad or stopway is added, the separation is 10 feet (3 m) as shown in Figure A-8.

2.5.4 Color.

The components of a runway threshold marking are white. See paragraph 1.4 and Table 1-1 for required techniques to enhance this marking.

2.5.5 Characteristics.

The runway threshold marking consists of a pattern of longitudinal stripes of uniform dimensions spaced symmetrically about the runway centerline. The number of longitudinal stripes and their spacing is determined by the runway width.

1. Table 2-2 provides the number of longitudinal stripes for runways having standard runway widths as defined by AC 150/5300-13. Figure A-1 illustrates the pattern for a 150-foot (45-m) wide runway. See paragraph 2.5.5 for painting guidance applicable to non-standard runway widths.

Table 2-2. Number of Runway Threshold Stripes for Standard Runway Widths

Standard runway widths	Number of symmetrical stripes
60 feet (18.3 m)	4
75 feet (22.9 m)	6
100 feet (30.5 m)	8
150 feet (45.7 m)	12
200 feet (61 m)	16

2. For standard runway widths, the longitudinal stripes are 150 feet (45.7 m) long and 5.75 feet (1.75 m) wide with the outer edges spaced (stripe-gap) 5.75 feet (1.75 m) apart. However, the two longitudinal stripes nearest the runway centerline are doubled spaced, i.e., outer edges of the near-most pair are 11.5 feet (3.5 m) apart. Figure A-1 illustrates the stripe-gap pattern for 150-foot (46-m) wide runways. The

stripe-gap pattern allows sufficient room to paint runway edge markings without interfering with the outermost longitudinal stripes.

Painting Note No. 4

Application of Proportioning Runway Markings for Non-Standard Runway Widths

For standard 75-foot (23-m) wide runways that use 36-inch (90-cm) wide runway edge markings, the stripe-gap pattern of 5.75 feet (1.75 m) is reduced to 5.50 feet (1.68 m).

3. For non-standard runway widths, the same stripe-gap pattern is continued from the runway centerline until the outermost longitudinal stripe is not closer than 4 feet (1.2 m) from the runway edge. For example, for a non-standard 125-foot (38-m) wide runway, the stripe-gap pattern yields a total of 10 longitudinal stripes symmetrical about the runway centerline. In no case should the stripe-gap pattern exceed 92 feet (27 m) on either side of the runway centerline. The value of 92 feet (27 m) is the width for the pattern used on the standard 200-foot (61-m) wide runways.
4. When there is pavement in excess of 5 feet (1.5 m) prior to the actual start of the runway threshold and (a) pilots may confuse the pavement as part of the actual runway or (b) the pavement does not have the same load bearing capacity as the runway, then painting of a runway threshold bar per paragraph 2.9 is required. In contrast, if the installation of landing threshold lights requires pavement to support the light fixtures and the supportive pavement abuts the start point of the runway threshold, then the supportive pavement is not considered a part of the runway. In this instance, the painting of a runway threshold bar is not required.

2.6 Runway Aiming Point Marking.

2.6.1 Purpose.

A runway aiming point marking provides a visual aiming point for landing operations.

2.6.2 Requirement.

See Table 2-1.

2.6.3 Location.

The preferred beginning of the aiming point marking starts 1,020 feet (311 m) from the runway threshold as shown in Figure A-1, Figure A-2, and Figure A-3. However, this preferred separation is not adequate for all cases as partially discussed below.

Note: The term “preferred” assumes the following conditions: standard visual glide slope of 3 degrees; no obstacle in the approach area affecting the obstacle clearance surface of

the PAPI; standard threshold crossing heights per AC 150/5340-30; sufficient runway length so not to force the placement of the aiming point marking; no rapid terrain drop off near the approach threshold that encounters severe turbulence; no elevation differences between the threshold and the installation zone of the PAPI.

2.6.3.1 **Intersecting Runways.**

A separation tolerance of plus or minus 200 feet (61 m) is allowed when it is necessary to shift the aiming point marking to avoid overlapping aiming point markings at dual runway intersection as shown in Figure A-4 and Figure A-5, and discussed in paragraph 2.2.3. However, depending on the threshold crossing heights and the available runway approach aids, the shifting of the aiming point markings may negatively impact the threshold crossing heights for approaching airplanes. One potential impact of the shift is to the co-located runway approach aids, such as the PAPI, in which the previous vertical guidance offered by the aiming point marking to pilots is now incompatible with the threshold crossing height associated with the runway approach aid. Under such conditions, adjustment in the location of the affected runway approach aid may be necessary after an evaluation so that the co-located relationship between the PAPI (and other approach aids) and the shifted aiming point marking permits an acceptable landing operation for both landing aids.

2.6.3.2 **Compatible Threshold Crossing Heights.**

See AC 150/5340-30 to determine if the impact of a relocated aiming point marking warrants relocating the co-located PAPI (or other runway approach aids).

2.6.4 Color.

The runway aiming point marking is white. See paragraph 1.4 and Table 1-1 for required techniques to enhance this marking.

2.6.5 Characteristics.

1. The runway aiming point marking consists of two conspicuous rectangular markings, 150 feet (45.7 m) in length for runways of at least 4,200 feet (1280 m) in length between the thresholds (or a displaced threshold(s)), and 100 feet (30.5 m) in length for lesser lengths between the thresholds (or a displaced threshold(s)). The runway aiming point marking is located symmetrically on each side of the runway centerline as shown in Figure A-1, Figure A-2, and Figure A-3. See Table 2-2, for the dimensions of standard runway widths per AC 150/5300-13.
2. The width of each rectangular marking is as follows:
 - a. 30 feet (9.1 m) for standard runway widths of 150 feet (45.7 m) or greater.
 - b. 20 feet (6 m) for standard runway widths of 100 feet (30.5 m).
 - c. 15 feet (5 m) for standard runway widths of 75 feet (22.9 m).
 - d. 12 feet (3.7 m) for a standard runway width of 60 feet (18.3 m).

3. The lateral spacing between the inner sides of the runway aiming point markings is as follows:
 - a. For runways of 150 feet (45.7 m) or more in width, the lateral spacing between the inner sides of the rectangular bars centered on the runway centerline is 72 feet (21.9 m).
 - b. For runways of 100 feet (30.5 m) in width, the lateral spacing between the inner sides of the rectangular bars centered on the runway centerline is 48 feet (14.6 m).
 - c. For runways of 75 feet (22.9 m) in width, the lateral spacing between the inner sides of the rectangular bars centered on the runway centerline is 36 feet (11.0 m).
 - d. For runways of 60 feet (18.3 m) in width, the lateral spacing between the inner sides of the rectangular bars centered on the runway centerline is 28.8 feet (8.8 m).

Painting Note No. 5

Application of Proportioning Runway Markings for Non-Standard Runway Widths and for Standard Runway Widths less than 150 feet (45.7 m)

For runways with widths below 150 feet (45.7 m), the width of the rectangular bars and their lateral spacing between the inner sides of the rectangular bars are adjusted in proportion to the available runway width by using the 150-foot (45.7-m) width runway parameters to determine the percentage decrease in lateral spacing and width of each marking. For example, a non-standard 70-foot wide runway would apply $70/150 = 0.467$ to obtain a lateral spacing of $72 \times 0.467 = 33.6$ feet (10.25 m) between the pair and an individual width of $30 \times 0.467 = 14$ feet (4.27 m).

If runway edge markings are also painted, which are not reduced, then the adjustment should add the width of the corresponding runway edge markings plus a minimum 1-foot (0.3-m) clearance between the outer edge of the aiming point marking and the runway edge marking.

Lateral spacing – in no case is the lateral spacing less than 30 feet (9.1 m) except for runways less than 75 feet (22.9 m).

Lengths – in all cases, the length of the aiming point marking remains unchanged.

2.7 Runway Touchdown Zone Marking.

2.7.1 Purpose.

For landing operations, the touchdown zone marking identifies the touchdown zone along a precision runway in 500-foot (152-m) increments. For lighting provisions, see [AC 150/5340-30](#).

2.7.2 Requirement.

See Table 2-1.

2.7.3 Location.

The touchdown zone marking consists of symmetrically arranged pairs of rectangular bars in groups of one, two, and three along the runway centerline as shown in Figure A-1. As shown, there are five groupings with the aiming point marking serving as an independent, sixth pair.

2.7.3.1 The touchdown zone marking scheme maintains a 900-foot (275-m) “no-marking zone” from the midpoint of the runway back toward the threshold. That is, those pairs of surface markings that extend within 900 feet (275 m) of the runway midpoint are eliminated. The intent of this painting practice is to preserve a 1,800-foot (550-m) unmarked area so pilots do not confuse the surface markings during a landing with the surface markings for the other approach procedure. The same practice applies equally to a displaced threshold, i.e., the midpoint is located between the thresholds or displaced thresholds and not the runway ends. Taking this into consideration, the painted pattern for the runway touchdown zone marking depends on the (a) authorized approach off each runway and (b) the available length between the runway thresholds or displaced threshold, i.e., the midpoint. The surface marking patterns for the two possible cases are provided in Table 2-3 (case #1) and Table 2-4 (case #2).

2.7.3.1.1 **Case #1** – Only one runway end requires the runway touchdown zone marking scheme. Apply Table 2-3 criteria, which take into account the “no-marking zone” of 900 feet (275 m) from the midpoint back toward the threshold.

Table 2-3. Groupings of Touchdown Zone Markings Required When Installed From One Threshold

Distance Between Thresholds (or displaced thresholds)	Markings for Precision Approach End (includes displaced threshold)	Other Runway End Visual or Non-precision
6,065 ft (1849 m) or greater ¹	Full set of markings	Aiming point marking
5,565 ft (1697 m) to 6,064 ft (1848 m)	Less one grouping of rectangular bar markings ²	Aiming point marking
5,065 ft (1544 m) to 5,564 ft (1696 m)	Less two groupings of rectangular bar markings	Aiming point marking
4,565 ft (1391 m) to 5,064 ft (1543 m)	Less three groupings of rectangular bar markings	Aiming point marking

Distance Between Thresholds (or displaced thresholds)	Markings for Precision Approach End (includes displaced threshold)	Other Runway End Visual or Non-precision
<p>Note 1: The value of 6,065 feet is derived as follows. For the non-precision or visual runway end, the table assumes the 900-foot “no-marking zone” criterion plus the length of a preferred aiming point marking, which starts 1,020 feet from the start of the threshold to obtain a length of 1,920 feet. Add to this the length of the aiming point marking. Per paragraph 2.6.5, the length of the aiming point marking is either 150 feet or 100 feet. This table uses a length of 150 feet because all the entries in column #1 are greater than 4,200 feet. Therefore, adding 150 feet to 1,920 feet obtains a length of 2,070 feet. For the precision end, which equals 3,995 feet, it assumes the 900-foot “no-marking zone” followed by the standard 75-foot-long rectangular bar for a total length of 975 feet. Add to this value the full 3,000-foot touchdown zone marking scheme and the 20-foot separation between the actual starting point of the runway threshold (or displaced threshold) and the bottom edge of threshold marking to obtain 3,995 feet. Summing the values 3,995 and 2,070 yields 6,065 feet.</p> <p>Note 2: Each reduction in a pair of rectangular bar markings from the precision end equates to a 500-foot (152-m) reduction between the thresholds.</p> <p>The painting rationale for this table is to ignore the midpoint between the thresholds so the precision instrumented landing is favored over non-precision or visual landings. That is, the length of the non-precision/visual side of the runways always remains at 2,070 feet in length to promote the painting of a full set of touchdown zone markings.</p>		

- 2.7.3.1.2 **Case #2** – Both runway ends require runway touchdown zone markings. Apply Table 2-4 criteria, which take into account the “no-marking zones” of 1,800 feet (550 m) from the threshold-to-threshold midpoint.

Table 2-4. Groupings of Touchdown Zone Markings Required When Installed From Both Thresholds

Distance Between Thresholds (or displaced thresholds)	Markings for Each Threshold (or displaced threshold)
7,990 ft (2436 m) or greater ¹	Full set of markings
6,990 ft (2130 m) to 7,989 ft (2435 m)	Less one grouping of rectangular bars from each side nearest to the runway midpoint ²
5,990 ft (1826 m) to 6,989 ft (2129 m)	Less two groupings of rectangular bars from each side nearest to the runway midpoint ²
4,990 ft (1521 m) to 5,989 ft (1825 m)	Less three groupings of rectangular bars from each side nearest to the runway midpoint ²
<p>Note 1: The value of 7,990 feet is derived as follows. Proceed from the runway midpoint in one direction, and you will have the 900-foot “no-marking zone” criterion followed by the standard 75-foot long rectangular bar for a total length of 975 feet. Add to this value the full 3,000-foot touchdown zone marking scheme plus the 20-foot separation between the actual starting point of the runway threshold (or displaced threshold) and the edge of threshold marking to obtain 3,995 feet. Double this value for both directions to obtain 7,990 feet.</p> <p>Note 2: Each reduction in a grouping of rectangular bar markings from both sides equates to a 1,000-foot (305-m) reduction between the thresholds.</p>	

Distance Between Thresholds (or displaced thresholds)	Markings for Each Threshold (or displaced threshold)
The painting rationale for this table is to preserve the midpoint between the thresholds, thereby promoting an equal treatment of painting groupings of rectangular bar markings for both sides.	

2.7.3.2 Because the location of the aiming point marking may be adjusted from the threshold to accommodate different approach slopes and/or heights over the threshold, and to possibly take into account non-zero runway gradients, the location of an adjusted aiming point marking will vary. Please see [AC 150/5340-30](#). Under such conditions, an adjusted aiming point will, in most cases, continue to be located between the first and the second touchdown zone markings. However, when the accumulative effect of the adjustments is severe (defined as when a touchdown zone marking coincides with or is within 160 feet (48.8 m) of the adjusted aiming point marking), that touchdown zone marking must not be painted. For the pilot community, this practice permits the aiming point marking to retain its prominent visual landing aid as compared to a touchdown zone marking.

2.7.4 Color.

All rectangular bars are white. See paragraph [1.4](#) and [Table 1-1](#) for required techniques to enhance this marking.

2.7.5 Characteristics.

1. For runway widths of 150 feet (45.7 m) or greater, each rectangular bar is 75 feet (22.9 m) long and 6 feet (1.8 m) wide. The lateral spacing between the inner sides of the rectangular bars on the same side of the runway centerline is 5 feet (1.5 m).
2. For runway widths less than 150 feet (45.7 m), the length of the marking remains unchanged, but the width and the lateral spacing between the markings are reduced proportionally to the decrease in runway width by using 150-foot (45.7 m) parameters to determine the percentage decrease.
3. The lateral spacing between the inner sides of the rectangular bars centered along the runway centerline is equal to that of the aiming point marking (criteria repeated below from paragraph [2.6.5](#)). In all cases, the length of the rectangular bars (and the aiming point markings) remains unchanged. See [Table 2-2](#) for the dimensions of standard runway widths.
 - a. For runways of 150 feet (45.7 m) or more in width, the lateral spacing between the inner sides of the rectangular bars centered on the runway centerline is 72 feet (21.6 m).
 - b. For runways of 100 feet (30.5 m) in width, the lateral spacing between the inner sides of the rectangular bars centered on the runway centerline is 48 feet (14.6 m).

- c. For runways of 75 feet (22.9 m) in width, the lateral spacing between the inner sides of the rectangular bars centered on the runway centerline is 36 feet (11.0 m).
- d. For runways of 60 feet (18.3 m) in width, the lateral spacing between the inner sides of the rectangular bars centered on the runway centerline is 28.8 feet (8.8 m).

Painting Note No. 6

Application of Proportioning Runway Markings for Non-Standard Runway Widths

For runways with widths below 150 feet (45.7 m), the width of the rectangular bars and their lateral spacing between the inner sides of the rectangular bars are adjusted in proportion to the available runway width by using the 150-foot (45.7 m) width runway parameters to determine the percentage decrease in lateral spacing and width of the marking. For example, a nonstandard 70-foot wide runway would apply $70/150 = 0.467$ to obtain a lateral spacing for the centered pair of $72 \times 0.467 = 33.6$ feet (10.25 m), a lateral spacing for other pairs of $5 \times 0.467 = 2.3$ feet (0.7 m), and a width of $6 \text{ feet} \times 0.467 = 2.8$ feet (0.85 m). This adjustment must be such that the inner sides of the innermost rectangular bars to the runway centerline align themselves with the inner side of the aiming point marking. Given that the runway edge markings are painted, the adjustment should be such that the clearance between the runway side strip and the outer edge of the three-bar grouping is a minimum of 1-foot (0.3-m). In no case should the three-bar group be painted farther out from the runway centerline than the aiming point marking.

2.8 Runway Edge Marking.

2.8.1 Purpose.

The runway edge marking provides enhanced visual contrast between the runway edge and the surrounding terrain or runway shoulders, and delineates the width of suitable paved area for runway operations. For lighting provisions, see [AC 150/5340-30](#).

2.8.2 Requirement.

See [Table 2-1](#).

2.8.3 Location.

The runway edge marking consists of two parallel stripes, one placed along each edge of the usable runway with the outer edge of each stripe approximately on the edge of the paved useable runway. For extra wide runways, such as military runways converted for public use, the maximum distance between the outer edges of the parallel stripes is 200 feet (61 m). [Figure A-1](#) illustrates the runway edge marking.

2.8.4 Color.

The stripes of the runway edge marking are white. See paragraph [1.4](#) for recommended techniques to enhance this marking.

2.8.5 Characteristics.

The runway edge marking has a minimum width of 36 inches (90 cm) for runways of 100 feet (30.5 m) or wider in width and at least 18 inches (45 cm) on smaller width runways (see [Table 2-2](#) for standard runway widths). The runway edge marking extends the full length of the runway as shown in [Figure A-7](#), except for precision runways as shown in [Figure A-1](#) which lack a threshold bar marking.

1. For runways with a displaced threshold, the edge markings continue through the paved area prior to the displaced threshold as shown [Figure A-7](#). This continuation of the edge markings is required because this paved area is used for takeoffs and for landing rollouts from the other direction.
2. Where an aligned taxiway, as shown in [Figure A-8](#) and [Figure A-10](#), precedes a runway threshold, both edge markings will terminate. The point of termination of the edge markings is determined by the taxiway geometry. **Prohibited:** The conversion of a runway section into an aligned taxiway or the construction of a new aligned taxiway is prohibited. See [AC 150/5300-13](#). The FAA further recommends that existing aligned taxiways, for example, as shown in [Figure A-8](#) and [Figure A-10](#), be removed or be reconfigured into usable runways as shown in [Figure A-7](#) or [Figure A-11](#). When a taxiway connects to a runway or the runway has turn pads or turnarounds, the runway edge marking remains continuous between the runway and these adjoining infrastructures.
3. For intersecting runways, see guidance in paragraph [2.2](#).

2.9 **Runway Threshold Bar Marking and Runway Displaced Threshold Marking.**

The complete marking scheme for a runway with a displaced threshold, when required by [AC 150/5300-13](#), includes a runway threshold bar and arrowheads with and without arrow shafts. [Figure A-7](#), [Figure A-10](#), and [Figure A-11](#) illustrate the various applications of displaced thresholds and the requirement for additional marking components. For lighting provisions, see [AC 150/5340-30](#).

2.9.1 Runway Threshold Bar Marking.

2.9.1.1 **Purpose.**

The runway threshold bar marking serves two functions by delineating the start of the (i) displaced threshold by indicating the beginning section of the runway available for landing from the unusable section on the approach side of the displaced threshold as shown in [Figure A-7](#), [Figure A-10](#), and [Figure A-11](#) and (ii) regular threshold from prepared surfaces before the runway that are used for a blast pad, stopway, EMAS or end of an aligned taxiway as shown in [Figure A-8](#) and [Figure A-9](#).

2.9.1.2 Requirement.

Install a runway threshold bar marking when there is a displaced threshold, blast pad, stopway, EMAS, or aligned taxiway on the approach side of the threshold.

2.9.1.3 Location.

The runway threshold bar marking is an elongated rectangular bar that is located perpendicular to the runway centerline and on the landing portion of the runway. The outboard edge of the marking is aligned with the location labeled “start of runway displaced threshold” as shown in [Figure A-10](#) or “start of runway threshold” as shown in [Figure A-9](#). Note that the entire runway threshold bar marking is on the portion of the runway available for landing.

2.9.1.4 Color.

The runway threshold bar marking is white. See paragraph [1.4](#) for required techniques to enhance this marking.

2.9.1.5 Characteristics.

The runway threshold bar marking is 10 feet (3.1 m) in width and extends between the runway edges or between the runway edge markings.

2.9.2 Arrow Marking.

The arrow marking (arrowheads with and without arrow shafts; depending on the length of the displacement) performs three possible functions, that is, two cases for displaced thresholds and one case for a runway threshold with an aligned taxiway.

2.9.2.1 Purposes.

1. [Figure A-7](#) illustrates the predominant case in which the threshold is displaced from the runway end. In this case, white arrowheads with and without arrow shafts are required to identify the portion of the runway before the displaced threshold to provide centerline guidance for pilots during approaches, takeoffs, and landing rollouts from the opposite direction.
2. [Figure A-10](#) illustrates the rare case in which a displaced threshold is preceded by an aligned taxiway. In this case white arrowheads with and without arrow shafts and yellow arrowheads without arrow shafts are required to identify the runway portion from the aligned taxiway portion. Furthermore, a yellow runway demarcation bar is required to identify the start of the runway. See paragraph [2.9.3](#) for runway demarcation bar criteria and figures.
3. [Figure A-8](#) illustrates the rare case in which a runway threshold (not displaced) is preceded by an aligned taxiway. In this case, yellow arrowheads without arrow shafts are required to identify the runway portion from the aligned taxiway portion.

General Comment
The conversion of a runway section into an aligned taxiway or the construction of a new aligned taxiway is prohibited. See AC 150/5300-13 .

2.9.2.2 Requirement.

Install this marking when the threshold is displaced or preceded by an aligned taxiway.

2.9.2.3 Locations.

1. For the predominant case, arrowheads with or without arrow shafts (depending on the length of displacement) are located on the portion of the runway before the displaced threshold.
2. For the rare cases referenced in paragraph [2.9.2.1](#), only arrowheads are used on the portion of the aligned taxiway before the threshold bar marking or before the demarcation bar marking as described in paragraph [2.9.3](#).

2.9.2.4 Colors.

1. For the predominant case, the arrow shaft and arrowhead are white. See paragraph [1.4](#) for required techniques to enhance these markings which are part of a displaced threshold.
2. For the rare cases referenced in paragraph [2.9.2.1](#), the arrowhead is yellow which is not part of a displaced threshold.

2.9.2.5 Characteristics.

The dimensions and spacing requirements for arrow shafts and arrowheads are as shown in [Figure A-7](#) (function one, as listed in paragraph [2.9.2.1](#)), [Figure A-8](#) (function two), and [Figure A-10](#) (function three).

2.9.3 Runway Demarcation Bar Marking.**2.9.3.1 Purpose.**

A demarcation bar delineates a runway with a displaced threshold from a blast pad, stopway, or an aligned taxiway that precedes the runway.

2.9.3.2 Requirement.

Install a demarcation bar marking only when the threshold is displaced and the runway is preceded by a blast pad, stopway, or aligned taxiway.

2.9.3.3 Location.

The demarcation bar is an elongated rectangular bar on a blast pad, stopway, or an aligned taxiway that is perpendicular to the runway

centerline at the point of intersection with the start of the runway as shown in [Figure A-10](#) and [Figure A-11](#). As shown in [Figure A-10](#), the portion of aligned taxiway before the demarcation bar is not part of the usable runway for takeoff or for landing from the opposite direction. Note that no part of the demarcation bar is on the unable runway for takeoff or for landing.

2.9.3.4 **Color.**

The demarcation bar marking is yellow. See paragraph [1.4](#) for recommended techniques to enhance this marking.

2.9.3.5 **Characteristics.**

The demarcation bar marking is 3 feet (0.9 m) wide and extends across the entire width of the blast pad, stopway, or aligned taxiway.

2.10 **Chevron Markings for Blast Pads, Stopways, and EMAS.**

2.10.1 Purposes.

The chevron marking identifies paved blast pads, stopways, and EMAS (engineered materials arresting systems) in relation to the end of the runway. For lighting provisions, see [AC 150/5340-30](#), and for EMAS design, see [AC 150/5220-22](#), *Engineered Materials Arresting Systems (EMAS) for Aircraft Overruns*.

2.10.2 Requirement.

Install chevron markings on blast pads, stopways, and EMAS.

2.10.3 Location.

The chevron marking is located on the blast pad and stopway that are aligned with and contiguous to the runway end as shown in [Figure A-9](#) and [Figure A-11](#). The chevron scheme for an EMAS installation is also centered along the extended runway centerline (not shown in [Figure A-9](#) and [Figure A-11](#)).

2.10.4 Color.

Chevron markings are yellow. See paragraph [1.4](#) for a recommended technique to enhance this marking.

2.10.5 Characteristics.

Dimensionally, stopways equal the width of the runway while blast pads equal the runway width plus the standard shoulder widths (see [AC 150/5300-13](#)). The dimensions and spacing requirements for chevron markings are shown in [Figure A-9](#). The recommended minimum length for a stopway is 150 feet (45.7 m) to allow for at least two chevron stripes. For cases where (1) standard length blast pads, per [AC 150/5300-13](#), are installed off runway ends designed exclusively for small airplanes (Airplane Design Groups I and II– small) or (2) existing stopways are less than 150 feet (45.7 m) in length on runway widths of 75 feet (22.9 m) or less, the width of the chevrons and the

spacing between the chevrons shown in [Figure A-9](#) can be reduced by two-thirds. The intent of the reduction in dimensions is to provide pilots with at least two visible chevrons.

2.11 **Runway Shoulder Marking.**

2.11.1 Purpose.

The runway shoulder marking is used, when needed, as a supplement to further delineate a paved runway shoulder that pilots have mistaken or are likely to mistake as usable runway. This marking is used only in conjunction with the runway edge marking.

2.11.2 Requirement.

Runway shoulder markings are optional.

2.11.3 Location.

The runway shoulder marking is located between the runway edge marking and the outer edge of the paved shoulder as shown in [Figure A-12](#).

2.11.4 Color.

Runway shoulder markings are yellow. See paragraph [1.4](#) for a recommended technique to enhance this marking.

2.11.5 Characteristics.

The runway shoulder marking consists of stripes 3 feet (0.9 m) in width and spaced 100 feet (30.5 m) apart along the edge of the runway. The stripes start at the runway midpoint, are slanted at an angle of 45 degrees to the runway centerline, and are oriented as shown in [Figure A-12](#).

Page Intentionally Blank

CHAPTER 3. HOLDING POSITION MARKINGS

3.1 Applications of Holding Position Markings.

The purposes for the different holding position markings are to prevent aircraft and vehicles from entering into protected areas associated with a runway and navigational aids, or to control traffic at the intersection of taxiways. This AC describes six operational situations (cases) using three different holding position marking schemes. Cases 1, 2, and 3 employ the same marking scheme referred to as Pattern A – runway holding position marking. Cases 4 and 5 employ a different marking scheme referred to as Pattern B – ILS, POFZ holding position marking or the Runway Approach/Departure Areas of a runway. For certain POFZ operational situations, Case 5 uses Pattern B in which it usually appears as an L-shaped ladder. Case 6 uses a different marking scheme referred to as Pattern C – intermediate holding position marking for taxiway/taxiway intersections. [Figure A-13](#) and [Figure A-14](#) show the four different marking patterns and [Figure 3](#) of AC 150/5340-18G shows the application for the Runway Approach/Departure Areas of a runway.

- **Case 1:** In terms of taxiing on a runway, an aircraft will need to hold short of an intersecting runway (see paragraph [3.2](#)).
- **Case 2:** In terms of landing on a runway used for land and hold short operations (LAHSO), the aircraft will need to hold short of an intersecting runway or, in some rare cases, at a specified hold spot on the landing runway (see paragraph [3.2](#)).
- **Case 3** (most common application for Cases 1, 2, and 3): In terms of taxiing on a taxiway, an aircraft will need to hold short prior to entering an active runway (see paragraph [3.3](#)).
- **Case 4:** In terms of taxiing on a taxiway, an aircraft will need to hold short before entering the protected area of an Instrument Landing System (ILS) (see paragraph [3.4](#)).
- **Case 5:** In terms of taxiing on a taxiway, an aircraft will need to hold short before entering the protected area of a Precision Obstacle Free Zone (POFZ) or Runway Approach/Departure Areas of a runway (see paragraph [3.5](#)). Although the surface marking pattern is the same as Case 4, the pattern in many POFZ applications is L-shaped instead of only linear in shape.
- **Case 6:** In terms of taxiing on a taxiway, an aircraft will need to hold short of a taxiway/taxiway intersection (see paragraph [3.6](#)).

3.2 Case 1 and Case 2 – Applications of Pattern A for the Runway Holding Position Marking on Runways.

3.2.1 Purpose.

Pattern A, when painted on a runway as shown in [Figure A-13](#), identifies the location where a pilot (or vehicle driver) is to stop and hold when (1) the runway is operationally closed for an interval of time so that ATCT can control taxiing operations through a

runway/runway intersection or (2) the runway is used for land and hold short operations (LAHSO). For necessary corresponding signage and lighting provisions, see [AC 150/5340-18](#), and [AC 150/5340-30](#).

Safety Notice No. 3

Safety Initiatives

Note 1: Land and hold short operations (LAHSO) require a letter of agreement between the airport operator and the airport traffic control tower (ATCT).

Note 2: Since the design standard for a full-length parallel taxiway reduces both wrong-runway takeoffs and runway incursions, we do not recommend the use of an operationally closed runway as a taxiway, especially when a parallel taxiway exists. Such an operation can potentially confuse pilots because this taxiing operation introduces yellow-colored taxiway surface markings onto the runway itself. Hence, to avoid the potential for operational errors by pilots, the airport operator should take measures to meet the full-length parallel taxiway design standard. In some cases, the operational capacity for a given runway could indicate the need for dual parallel taxiways to avoid this type of taxiing operation.

Note 3: To avoid a runway incursion event at runway/runway intersections when an operationally closed runway is used as a taxiway, the intersection must have the runway holding position marking and corresponding signs whether or not pilots taxi through the runway/runway intersection. Additionally, this marking should only be used in those instances where documentation supports the need for the operational use of the runway as a taxiway. The operational use of a runway as a taxiway must be described in a Letter of Agreement with the ATCT.

3.2.2 Location.

In all Case 1 and Case 2 applications, the criteria given below assume that the centerlines of the intersecting runways are perpendicular. Hence, for runway/runway intersections that are non-perpendicular, additional distance may be required to ensure that all airplane features, such as wingtips, remain outside the protected area of the intersecting runway.

3.2.2.1 **Operationally Closed Runways Used for Taxiing Operations.**

The location of the runway holding position marking on operationally closed runway is in accordance with the holding position criteria per [AC 150/5300-13](#) for the intersecting runway's runway design code.

3.2.2.2 **Runways Used for LAHSO.**

3.2.2.2.1 The location of the runway holding position marking on the runway used for LAHSO is in accordance with the holding position criteria per [AC 150/5300-13](#) for the intersecting runway's runway design code. On rare

cases the location of the runway holding position marking for LAHSO is based on a predetermined hold-short point along the landing runway to protect an approach/departure flight path or to overcome painting difficulties as described below in paragraph 3.2.2.2.2. In no case should the location of the predetermined hold-short point be within the holding position criteria per AC 150/5300-13 for the intersecting runway's runway design code.

- 3.2.2.2.2 Certain airfield geometries for runways that are used for taxiing or LAHSO operations have intersecting taxiway(s) that hamper the painting of the runway holding position marking (and installation of accompanying necessary signage) in accordance with the applicable holding position criterion. One such geometry occurs when a crossing taxiway or its fillet intersects the runway where the marking or sign is to be placed. One solution is to move the hold-short point farther away from the runway/runway intersection so that both the marking and the installed signage clear the common crossing area. Under this solution:
1. the marking is always painted at a greater distance than the holding position criteria in AC 150/5300-13, and
 2. the required corresponding signage retains only the runway designations, i.e., never uses a taxiway designation.

3.2.3 Color.

The Pattern A marking scheme, as shown in Figure A-13, is yellow and, when painted on light-colored pavements, is outlined in black. See paragraph 1.4 and Table 1-1 for required techniques to enhance this surface marking on light-colored pavements.

3.2.4 Characteristics.

- 3.2.4.1 The marking is identical to the runway holding position marking installed on a taxiway as described in paragraph 3.3 and shown in Figure A-13. The solid lines, as compared to the dashed lines, are always on the side where the aircraft is to hold.
- 3.2.4.2 The marking is installed perpendicular to the runway centerline and interrupts all runway markings except for the runway designation marking. If the runway holding position marking should interrupt the mentioned exceptions, then paint the runway holding position marking farther away than specified by AC 150/5300-13 to avoid any interruption of these specified markings. The painting practice is to avoid "over striping" existing runway surface markings.
- 3.2.4.3 The runway holding position marking extends across the full width of the runway but not onto the runway shoulders or onto any intersecting taxiway fillet.

3.3 Case 3 – Applications of Pattern A for the runway Holding Position Marking on Taxiways.

3.3.1 Purposes.

Pattern A, when painted on a taxiway as shown in [Figure A-13](#), serves several roles. For a taxiway that intersects a runway at an airport with an operating airport traffic control tower (ATCT), the Pattern A marking scheme identifies the location on a taxiway where pilots and vehicle drivers are to stop until they receive a clearance from ATCT to proceed onto the runway. Under this role, Pattern A may be supplemented with the Geographic Position Marking as part of the airport's LVO/SMGCS Plan as described in paragraph [4.11](#) and as shown in [Figure A-24](#). For a taxiway that intersects a runway at an airport without an operating airport traffic control tower, Pattern A identifies the location where pilots and vehicle drivers are to stop to ensure that they have adequate separation with other aircraft before proceeding onto the runway. If the marking is located closer than prescribed by [AC 150/5300-13](#), such as when the taxiing aircraft penetrates a Terminal Instrument Procedures (TERPS) surface, then the airport operator can expect higher approach minimums to the impacted runway end. [AC 150/5300-13](#) includes a discussion of these airspace surfaces. Except as specified in paragraph [3.2](#), the runway holding position marking must not be used for any other situations than the roles described in this paragraph. For signage and lighting provisions, see [AC 150/5340-18](#) and [AC 150/5340-30](#).

3.3.2 Location.

Pattern A for the runway holding position marking is located as follows:

- 3.3.2.1 For a taxiway that intersects a runway, the Pattern A runway holding position markings must be located on all such taxiways in accordance with the holding position criteria per [AC 150/5300-13](#) for the runway's runway design code. This measurement is taken to the edge of the holding position marking farthest from the runway, at the taxiway centerline (see [Figure A-16](#)). Because the location is based on the approach visibility minimums, approach category, and airplane design group, the airport operator should use the lowest approach visibility minima and critical aircraft intended to use the runway. Locating a runway holding position marking other than what is required by this paragraph must be approved by the FAA.
- 3.3.2.2 Pattern A is used also on turnarounds and holding bays as shown in [AC 150/5300-13](#), especially for airports with an airport traffic control tower or for any runways used at night and in low-visibility conditions. Locating a Pattern A runway holding position marking other than what is required by this and other paragraphs must be approved by the FAA Airports Regional Office or Airports District Office.

Safety Notice No. 4

14 Code of Federal Regulation (CFR) Part 139 Certificated Airports Runway Incursion Mitigation Requirement

Extended runway holding position markings, as illustrated in [Figure D-4](#), provide a safety benefit to pilots of ADG V and VI aircraft that lowers the risk of a runway incursion. Uniformity of surface markings contributes to airfield safety by providing visual instructions that result in consistent interpretation by pilots. Application of this surface painted marking, which is part of the taxiway centerline marking standard under 14 CFR Section 139.311(a)(2), establishes compliance with 14 CFR Part 139.

3.3.3 Color.

The Pattern A marking scheme, as shown in [Figure A-13](#), is yellow and, when painted on light-colored pavements, outlined in black. See paragraph [1.4](#) and [Table 1-1](#) for required techniques to enhance this surface marking.

3.3.4 Characteristics.

3.3.4.1 Pattern A for the runway holding position marking consists of a set of two continuous lines, two dashed lines, and three spaces that are all parallel, extend across the entire width of the taxiway, measure 12 inches (30 cm) in width, and are separated as shown in [Figure A-13](#). It is located laterally such that a dash is centered on the taxiway centerline. Where the marking extends unbroken over more than one taxiway centerline, locate the marking such that a dash is centered on one taxiway centerline. At airports that do not have an operating ATCT and are not certificated under Part 139, the width and separation measurement may be reduced from 12 inches (30 cm) to 6 inches (15 cm). For clarification, all airports certificated under Part 139, whether or not there is an operating ATCT, are required to use the 12-inch measurement.

3.3.4.2 The taxiway centerline marking is interrupted by the runway holding position marking as shown in [Figure A-13](#).

3.3.4.3 For taxiways having taxiway edge markings, interrupt the taxiway edge marking as shown in [Figure A-23](#) so that the Pattern A marking continues to the edge of the defined taxiway width. For taxiways that connect to runways that serve Airplane Design Groups (ADGs) V or VI airplanes as defined by [AC 150/5300-13](#), the marking is further extended onto both paved shoulders (similar to Pattern A, as shown in [Figure D-4](#)) except when the Pattern A surface marking governs over the Pattern B surface marking per paragraph [3.4.2.1](#). For both airplane design groups, the length of the marking from the taxiway centerline onto the paved shoulder measures 62.5 feet (19 m). The 62.5-foot (19-m) measurement takes into account the downward viewing angle from the cockpit while the pilots are

seated in the normal position as well as other safety factors, such as aircraft wander from the taxiway centerline. For taxiways with widths greater than 75 feet (22.9 m), the runway holding position marking is extended 25 feet (7.5 m) [$62.5 \text{ viewing angle minus } (1/2)(75) \text{ standard taxiway width equals } 25 \text{ feet}$] onto the paved taxiway shoulders. Only those taxiway entrances to runways that serve ADGs V or VI are to be further extended. Typical airplane models within ADGs V and VI include the Airbus 330-200/-300, A-340-200/-300/-500/-600, A-380, Boeing-747-100/-200/-400, B-777-200/-300, and B-787-8/-9.

- 3.3.4.3.1 If the runway holding position marking is outlined in black, then the taxiway edge markings abut the black outline on both sides of this marking. That is, it abuts the black border of the solid yellow line on one side and abuts the black border of the dashed yellow line on the other side (see [Figure A-13](#)).
- 3.3.4.3.2 If the runway holding position marking is not outlined in black, leave a six-inch gap between the holding position markings (top and bottom) and the taxiway edge markings (see [Figure A-13](#)).
- 3.3.4.4 The orientation of Pattern A is for the solid continuous lines to be painted on the side where the aircraft and vehicles will hold before proceeding to the runway. That is, dashed lines are painted closer to the runway.
- 3.3.4.5 Pattern A is painted perpendicular to the taxiway centerline but may be canted from the perpendicular in unusual situations, such as an extremely acute, angled taxiway. For such unusual situations, it may be necessary to install additional runway holding position signs, runway guard lights, or stop bars to emphasize the location of the surface painted runway holding position marking.
- 3.3.4.6 Pattern A on converging taxiways, as shown in [Figure D-13](#), meet at an angle when two or more taxiways intersect the same runway holding position marking. On any angled taxiway to the runway, consideration must be given to locate the painted marking so no portion of an aircraft, e.g., wing tip or tail, penetrates the runway safety area or any protected surface. See [AC 150/5300-13](#) for detailed requirements and information about clearance requirements by aircraft on taxi routes.
- 3.3.4.7 For taxiways connecting to runways serving ADGs V and VI, having a light fixture or a sign located on the taxiway shoulder that aligns with the extended runway holding position marking, as shown in [Figure D-4](#), the extended runway holding position marking should extend no closer than 5 feet (1.5 m) to the edge of the light fixture or sign.
- 3.3.4.8 For taxiways connecting to runways serving ADGs V and VI whose taxiway shoulder markings interfere with or are within 10 feet (3.1 m)

from the extended runway holding position marking, as shown in Figure D-4, the taxiway shoulder markings are to be removed (omitted) from that location.

3.4 **Case 4 – Applications of Pattern B for the ILS Holding Position Marking.**

3.4.1 Purposes.

Pattern B for the ILS holding position marking as shown in Figure A-13 identifies the location on a taxiway or holding bay where a pilot or vehicle driver is to stop when they have received instructions from the airport traffic control tower (ATCT) to hold before entering an ILS protected area. The intent of the marking is to protect the signal of the ILS navigational aid by identifying the holding position for CAT I operations and protecting the approved TERPS for CAT II/III operations. For signage and lighting provisions, see AC 150/5340-18 and AC 150/5340-30.

3.4.2 Location.

Pattern B for the ILS holding position marking is located on the taxiway or holding bay at the boundary of the ILS protected area and, as appropriate, at the holding position for CAT I and CAT II/III operations. The entire marking is located inside the boundary of the protected area.

3.4.2.1 Where the distance between the runway holding position marking (Pattern A) on a taxiway and the holding position marking (Pattern B) for an ILS protected area is 50 feet (15 m) or less, one holding position may be established, provided it will not affect capacity. In this case, the runway holding position (Pattern A) is moved back to the ILS holding position (Pattern B) and only the runway holding position markings (Pattern A) are installed.

3.4.2.2 If a taxiway or holding bay penetrates both an ILS protected area and the Precision Obstacle Free Zone (POFZ) protected area (see Pattern B, Figure A-13), such as when the threshold is displaced, paint only one pattern instead of two patterns, but only if the single pattern can protect both protected areas. The pattern to be painted is the one whose location offers the most conservative, protective boundary (for example, farthest from the runway).

3.4.2.3 The FAA will designate the ILS protected area and POFZ boundaries and, as appropriate, determine the correct holding position location for CAT II/III operations for the airport operator. See AC 150/5300-13 for general information about the ILS and POFZ protected areas.

3.4.3 Color.

The Pattern B marking scheme as shown in Figure A-13 is yellow and, when used on light-colored pavements, outlined in black. See paragraph 1.4 and Table 1-1 for required techniques to enhance this surface marking.

3.4.4 Characteristics.

- 3.4.4.1 Pattern B for the ILS holding position marking consists of a set of two parallel lines that are 2 feet (0.6 m) wide and spaced 4 feet (1.2 m) apart. These parallel lines are connected by perpendicular sets of two lines that are 1 foot (0.3 m) wide and spaced 1 foot (0.3 m) apart and repeat every 10 feet (3 m). The Pattern B marking for ILS applications must extend across the entire width of the taxiway or holding bay (see [Figure A-13](#)). It is located laterally such that a set of perpendicular lines (parallel to the taxiway centerline) are equidistant from the taxiway centerline. Where the marking extends unbroken over more than one taxiway centerline, locate the marking such that one set of perpendicular lines is equidistant from one taxiway centerline. At airports that do not have an ATCT and are not certificated under Part 139, the airport operator may reduce the dimension for the width of the parallel yellow lines and spaces from 2 feet (0.6 m) to 1 foot (0.3 m) and from 4 feet (1.2 m) to 2 feet (0.6 m). For clarification, all airports certificated under Part 139, whether or not there is an operating ATCT, are required to use the larger measurements.
- 3.4.4.2 The taxiway centerline marking is interrupted by the ILS holding position marking as shown in [Figure A-13](#).
- 3.4.4.3 For taxiways having taxiway edge markings, interrupt the taxiway edge marking so that the Pattern B marking continues to the edge of the defined taxiway width as shown in [Figure A-13](#). For taxiways that connect to runways that serve Airplane Design Groups (ADGs) V or VI airplanes as defined by [AC 150/5300-13](#), the marking is further extended onto both paved shoulders (similar to Pattern A as shown in [Figure D-4](#)) only when the Pattern A marking is omitted per paragraph 3.4.2.1. In that case, for both airplane design groups, the length of the marking from the taxiway centerline onto the paved shoulder measures 62.5 feet (19 m). The 62.5-foot (19-m) measurement takes into account the downward viewing angle from the cockpit while the pilots are seated in the normal position as well as other safety factors, such as aircraft wandering from the taxiway centerline. For taxiways with widths greater than 75 feet (22.9 m), the ILS holding position marking is extended 25 feet (7.5 m) [62.5 viewing angle minus $(1/2)(75)$ standard taxiway width equals 25 feet] onto the paved taxiway shoulders. Typical airplane models within ADGs V and VI include the Airbus 330-200/-300, A-340-200/-300/-500/-600, A-380, Boeing-747-100/-200/-400, B-777-200/-300, and B-787-8/-9.
- 3.4.4.3.1 If the ILS holding position marking is outlined in black, then the taxiway edge markings abut the black outline on both sides of this marking (see [Figure A-13](#)).

- 3.4.4.3.2 If the ILS holding position marking is not outlined in black, a 6-inch gap is left between the holding position marking and the taxiway edge marking (see [Figure A-13](#)).
- 3.4.4.4 Pattern B is painted perpendicular to the taxiway centerline but may be canted from the perpendicular in unusual situations, such as an extremely acute, angled taxiway. For such unusual situations, it may be necessary to install additional runway holding position signs, runway guard lights, or stop bars to emphasize the location of the surface painted runway holding position marking.
- 3.4.4.5 Pattern B on converging taxiways meet at an angle when two or more taxiways intersect the same ILS holding position marking. On any angled taxiway to the runway, consideration must be given to locate the painted marking so no portion of an aircraft, e.g., wing tip or tail, penetrates the protected surface. See [AC 150/5300-13](#) for detailed requirements and information about clearance requirements by aircraft on taxi routes.
- 3.4.4.6 For taxiways connecting to runways serving ADGs V and VI whose taxiway shoulder markings interfere with or are within 10 feet (3.1 m) from the extended ILS holding position marking (see paragraph [3.4.4.3](#)), the taxiway shoulder markings are to be removed (omitted) from that location.

3.5 **Case 5 – Applications of Pattern B for Precision Obstacle Free Zone (POFZ) and Runway Approach/Departure Holding Position Marking.**

3.5.1 Purposes.

Pattern B marking, as shown in [Figure A-13](#), identifies a conditional holding position on a taxiway or holding bay, where a pilot or vehicle driver is to stop when they receive instructions from the airport traffic control tower (ATCT) to hold before entering a protected areas. Use of pattern B markings do not include runway pavement applications. [Figure A-14](#) depicts the application of a pattern B marking for a POFZ holding positions. Figure 1-4 and Figure 1-5 in [AC 150/5340-18G](#), *Standards for Airport Sign Systems*, depicts application of a pattern B marking for a runway Approach/Departure area. The marking is used also at non-towered airport where the runway end has an approved vertical guidance of $\frac{3}{4}$ -statute mile approach visibility minimum or less. The intent of the marking is to protect the authorized landing minima (TERPS) for a given runway end and the Runway Approach/Departure Areas of a runway. See [AC 150/5300-13](#) for detailed information about these protected areas. For signage and lighting provisions, see [AC 150/5340-18](#) and [AC 150/5340-30](#). Install this marking when a POFZ or the Runway Approach/Departure Areas of a runway exists.

- 3.5.1.1 The airport designates the boundaries of the POFZ and Approach/Departure surfaces on the airport layout plan using the

applicable dimensional values in AC 150/5300-13. This establishes initial points for the FAA evaluation of potential conditional holding positions.

- 3.5.1.2 For the approach/departure surfaces, FAA uses data provided by the airport to evaluate the initial holding position locations established in paragraph 3.5.1.1. The relevant data typically includes:
1. Approach minima
 2. Surface elevation information (e.g. threshold, taxiway centerline, etc.)
 3. Airfield geometric layout
 4. Most demanding tail height using taxiway
- 3.5.1.3 For airports with an operating airport traffic control tower, coordinate in advance with the local air traffic control personnel to permit time for development of a local standard operating procedure for conditional holding positions and local controller training. The design phase is the optimum time to engage the local ATC and limit potential delays to marking installation.
- 3.5.1.4 Changes at an airport can affect existing protection measures in the approach and departure area. If such changes have potential to affect a conditional holding position, a new evaluation is necessary. This includes but is not limited to the following factors:
1. A change to most demanding aircraft tail height
 2. Revised or new approach procedures
 3. Geometric changes to airfield pavement in approach/departure area

3.5.2 Location.

Pattern B position marking is located on the taxiway or holding bay at the boundary of the POFZ protected area or the Runway Approach/Departure Areas of a runway as defined by AC 150/5300-13 and, when appropriate, at the holding position for CAT I and CAT II/III operations. Figure A-17 shows the most common POFZ application for this marking, which is L-shaped. Because of the variety of taxiway entrance/holding bay geometries, the Pattern B marking for the POFZ must not be painted over a surface painted holding position sign.

- 3.5.2.1 Certain airfield geometries may cause a taxiway or holding bay to penetrate both an ILS protected area and the Precision Obstacle Free Zone (POFZ) protected area, such as when the threshold is displaced. Under such situations, paint only one pattern instead of two patterns, but only if the single pattern can protect both protected areas. The pattern to be painted is the one whose location offers the most conservative, protective boundary (for example, farthest from the runway). Under this application the ILS holding position (Pattern B) marking or POFZ holding position

(Pattern B) marking, which now serves a dual function, cannot be replaced with, or used in lieu of, a runway holding position (Pattern A) marking.

3.5.2.2 The FAA Airports Regional Office or Airports District Office will designate the ILS protected area, the Runway Approach/Departure Areas of a runway, and POFZ boundaries and, as appropriate, determine the correct holding position location for CAT II/III operations for the airport operator.

3.5.2.3 The Pattern B marking must extend across only those portions of a taxiway or holding bays that run along the boundary of the POFZ as shown in [Figure A-14](#) and [Figure A-17](#) or for the Runway Approach/Departure Areas of a runway.

3.5.3 Color.

The Pattern B marking scheme is yellow and, when used on light-colored pavements, outlined in black. See paragraph [1.4](#) and [Table 1-1](#) for required techniques to enhance this surface marking.

3.5.4 Characteristics.

Pattern B holding position marking consists of a set of two parallel lines that are 2 feet (0.6 m) wide and spaced 4 feet (1.2 m) apart. These parallel lines are connected by perpendicular sets of two lines that are 1 foot (0.3 m) wide and spaced 1-foot (0.3 m) apart and repeated every 10 feet (3 m). It is located laterally such that a set of perpendicular lines (parallel to the taxiway centerline) are equidistant from the taxiway centerline. Where the marking extends unbroken over more than one taxiway centerline, locate the marking such that one set of perpendicular lines is equidistant from one taxiway centerline. For example, [Figure A-13](#) provides the discontinuation (separation) of a POFZ holding position marking, which follows the same criteria as the ILS holding position marking, with an intersecting taxiway centerline or taxiway edge markings. In addition, [Figure A-17](#) illustrates the general separation of a Pattern B marking for a POFZ from an entrance taxiway serving a runway. At airports that do not have an ATCT and are not certificated under Part 139, the airport operator may reduce the dimension for the width of the parallel yellow lines and spaces from 2 feet (0.6 m) to 1 foot (0.3 m) and from 4 feet (1.2 m) to 2 feet (0.6 m). For clarification, all airports certificated under Part 139, whether or not there is an operating ATCT, are required to use the larger measurements.

3.6 **Case 6 – Applications for Pattern C for the Taxiway/Taxiway Intersection Intermediate Holding Position Marking.**

3.6.1 Purpose.

Pattern C for the intermediate holding position marking, as shown in [Figure A-14](#) for taxiway/taxiway intersections, is used to support the operational need by the airport traffic control tower to manage taxiing aircraft through a congested intersection or for other reasons deemed necessary by the FAA. For example, [Figure A-17](#) shows the

intersection between a taxiway and a holding pad used for deicing aircraft. Pilots when instructed by the airport traffic control tower to “hold short of (taxiway designation)” must stop so no part of the aircraft extends beyond the boundary of the intermediate holding position marking. For signage and lighting provisions, see AC 150/5340-18 and AC 150/5340-30.

3.6.2 Location.

For the taxiway being marked, the intermediate holding position marking for taxiway/taxiway intersection is located according to the taxiway centerline to fixed or movable object criteria in AC 150/5300-13 for the most demanding airplane design group serving the airport (per the definition in AC 150/5300-13).

3.6.3 Color.

The intermediate holding position marking is yellow and, when used on light-colored pavements, outlined in black. See paragraph 1.4 and Table 1-1 for a required technique to enhance this surface marking.

3.6.4 Characteristics.

The intermediate holding position marking for taxiway/taxiway intersections consists of a single dashed line extending across the width of the taxiway per Figure A-14 and Figure C-7. The single dashed lines are 1 foot (0.3 m) wide, 3 feet (0.9 m) long, and spaced 3 feet (0.9 m) apart. The marking is located laterally such that a dash is centered on the taxiway centerline. Where the marking extends unbroken over more than one taxiway centerline, locate the marking such that a dash is centered on one taxiway centerline. As shown in Figure A-14, all intersecting taxiway centerlines are spaced 6 to 12 inches (15 cm to 30 cm) on either side of this marking. When the taxiway has taxiway edge markings, the taxiway edge markings are interrupted.

CHAPTER 4. SURFACE MARKINGS FOR TAXIWAYS

4.1 Application.

All taxiways regardless of their width have a centerline marking, and whenever a taxiway intersects a runway, the taxiway should have a surface painted runway holding position marking. For Part 139 certificated airports, all taxiways that intersect a runway must have a surface painted runway holding position sign and an enhanced taxiway centerline marking. Taxiway edge markings are installed wherever there is a need to separate the taxiway from a pavement that is not intended for aircraft use or to delineate the edge of the taxiway that is not otherwise clearly visible. Examples of other taxiway surface markings that should be installed when appropriate and deemed necessary by the FAA (in some cases, with input from the tower manager of the airport traffic control tower (ATCT) include the Pattern A, B, and C holding position markings discussed in [Chapter 3](#), the intermediate holding position markings for taxiway/taxiway intersections, geographic position marking, and the taxiway shoulder marking.

4.2 Taxiway Centerline Markings.

4.2.1 Purpose.

The taxiway centerline marking provides pilots with continuous visual guidance to permit taxiing along a designated path. See [AC 150/5300-13](#) for standard fillet design, [AC 150/5340-30](#) for lighting provisions, and [AC 150/5340-18](#) for signage provisions.

4.2.2 Requirement.

All taxiways, regardless of their width, have a surface painted taxiway centerline.

4.2.3 Location.

On a straight section of a taxiway, the taxiway centerline marking is located along the physical centerline of the paved taxiway. This statement assumes the taxiway was built to standard, i.e., symmetrical with a taxiway centerline. On curved sections of a taxiway, the taxiway centerline marking continues from the centerline marking of the straight portion of the taxiway along a curved centerline defined in [AC 150/5300-13](#).

4.2.3.1 For taxiways that intersect other taxiways, the adequacy of the fillet design determines the centerline painting scheme as shown in [Figure A-18](#). The standard design is cockpit-over-centerline steering, which reduces the number of airplane main gear excursions from the taxiway.

4.2.3.1.1 At taxiway intersections with fillets that do not meet the fillet design standards of [AC 150/5300-13](#) for the Taxiway Design Group (TDG) of the taxiway—that is, judgmental over-steering is performed by pilots—the centerline marking continues straight through the intersection as shown at the top [Figure A-18](#). This practice applies to intersecting taxiways that are or are not of the same TDG.

- 4.2.3.1.2 Where fillets are designed to the TDG of the taxiway, the taxiway centerline marking follows the taxiway curve as shown on the bottom of [Figure A-18](#) to permit cockpit-over-centerline steering operations. This practice applies to intersecting taxiways that are of the same TDG.

Note: [AC 150/5300-13](#) states that cockpit-over-centerline steering is the standard methodology for painting taxiway centerlines in taxiway intersections. To reduce taxiway excursions on turns, airport operators should (1) construct standard fillets and (2) paint taxiway centerlines according to cockpit-over-centerline design.

- 4.2.3.2 For taxiways that intersect runways, different painting requirements or restrictions apply.

- 4.2.3.2.1 For a taxiway that intersects a runway at a runway end, as shown in [Figure A-16](#) and [Figure A-17](#), the taxiway centerline is terminated either at the runway edge or at the outer edge of the runway edge marking. However, the taxiway centerline (lead-on and lead-off) will continue onto the runway under the following conditions:

1. Where there is a displaced threshold, as shown in [Figure A-7](#) and [Figure A-11](#), the taxiway centerline marking continues onto the displaced area of the runway and extends parallel to the displaced threshold markings (arrow heads and arrow shafts) for a distance of 200 feet (61 m) beyond the point of tangency or terminates at the point of contact with the displaced threshold bar, whichever is less. As shown in [Figure A-7](#) and [Figure A-11](#), the lead-on and lead-off taxiway centerlines are 3 feet (1 m) from the runway arrow markings as measured near-edge to near-edge. This lead-on or lead-off taxiway centerline line is interrupted for all runway markings with some exceptions (see subparagraph [2](#) below).
2. For low-visibility taxiing operations, when the runway visual range (RVR) is below 1,200 feet (366 m), the taxiway centerline marking continues across all runway markings with the exception of the runway designation marking and, unless required by a LVO/SMGCS Plan, the runway threshold marking (longitudinal stripes). The painted taxiway centerline marking must follow the path of the in-pavement lighting criteria of [AC 150/5340-30](#). That is, if the in-pavement lighting is curved, the painted taxiway centerline is curved. In this situation, the taxiway centerline marking continues onto the runway and extends parallel to the runway centerline marking for a distance of 200 feet (61 m) beyond the point of tangency and is 3 feet (1 m) from the runway centerline as measured near-edge to near-edge. For some airfield geometries, such as an airfield with parallel runways with several parallel taxiways, the painted taxiway centerline at the runway end is painted straight through the runway end and curved onto the runway. See [AC 150/5340-30](#) for the different RVR in-pavement lighting

requirements and recommendations associated with various airfield configurations.

- 4.2.3.3 For taxiways that intersect a runway at any other locations than at the runway end, as shown in Figure A-16, the taxiway centerline marking curves onto the runway and extends parallel to the runway centerline marking for a distance of 200 feet (61 m) beyond the point of tangency with the runway centerline or terminates at the point of contact with the displaced threshold bar, whichever is less. As shown in Figure A-16 and Figure A-17, these lead-on and lead-off taxiway centerlines are 3 feet (1 m) from the runway centerline when measured near-edge to near-edge.
1. For taxiways that cross a runway, which are either perpendicular to or non-perpendicular to the runway centerline, and are normally used as crossing taxi routes, the taxiway centerline marking may continue across the runway but is interrupted for all runway markings with some exceptions (see paragraph 4.2.3.2.1).
 2. For low-visibility taxiing operations, when the RVR is below 1,200 feet (366 m), the taxiway centerline marking continues across all runway markings with the exception of the runway designation marking and, unless required by the LVO/SMGCS Plan, the runway threshold marking (longitudinal stripes), aiming point marking, and the touchdown zone markings.

4.2.4 Color.

The taxiway centerline marking is yellow. See paragraph 1.4 and Table 1-1 for required and recommended techniques to enhance this marking.

Painting Note No. 7

Non-Standard Colors

Over the years, some airport operators have installed other colors to denote various taxiing routes on the movement areas. These surface markings are non-standard. In an attempt to circumvent the yellow color standard, these different colored centerline markings have sometimes been referred to as supplemental markings or some other ambiguous term. Regardless of what they are called, these surface markings are non-standard and require specific approval by the FAA Director of Airport Safety and Standards. Regarding aircraft deicing facilities that are located in a non-movement area, taxiway/taxilane centerlines are painted in accordance with AC 150/5300-14, Design of Aircraft Deicing Facilities.

4.2.5 Characteristics.

4.2.5.1 **Width.**

The taxiway centerline marking width, which is either 6 inches (15 cm) or 12 inches (30 cm), is based on the type of taxiing operation as described below. Uniform width must be maintained for the entire length of the taxiway except under the following conditions.

4.2.5.1.1 The taxiway or part of the taxiway is designated as a LVO/SMGCS taxi route. Under this designation, the width of the taxiway centerline must be 12 inches (30 cm) wide and, on light-colored pavement, further outlined in black. The taxiway centerline width of any remaining section of the taxiway that is not part of the designated LVO/SMGCS taxi route may change abruptly at that point or at the intersection with other taxiway centerline markings, for example, reduced from 12 inches (30 cm) to 6 inches (15 cm).

4.2.5.1.2 A confusing intersection of taxiways is better served by the designation of a preferred taxi route through the confused intersection by painting a wider centerline width. The FAA recommends that airport operators take measures to realign or reconstruct confusing taxiway intersections.

4.2.5.1.3 If deemed necessary by the airport operator to provide pilots a better visual clue of the location of troublesome taxiway exits from the runway, the airport operator may increase 6-inch (15-cm) wide taxiway centerline markings before the aircraft hold side at the runway holding position location to 12-inch (30-cm) wide lead-off taxiway centerline markings on the runway side.

4.2.5.2 **Discontinuity of the Taxiway Centerline Marking Along the Taxiway.**

The taxiway centerline marking of a taxiway remains continuous except when it intersects (1) a runway holding position marking, (2) an intermediate holding position marking (intersection of taxiways), (3) an ILS or POFZ holding position marking, or (4) non-movement area boundary marking (paragraph 5.4). [Figure A-13](#) and [Figure A-14](#) illustrate the marking details for most of these conditions.

4.3 **Enhanced Taxiway Centerline Marking.**

4.3.1 Purposes.

The enhanced taxiway centerline marking provides supplemental visual cues to alert pilots of an upcoming runway holding position marking (Pattern A) in order to minimize the potential for runway incursions. To reinforce situational awareness before entering a runway, this safety enhancement is only used on those taxiways that directly enter a runway. For example, this safety enhancement would not be painted on a runway or used at all Pattern A applications, such as case 1 or case 2 (paragraph 3.2),

situations as shown in [Figure D-16](#), or a taxiway that goes through the runway safety area but not onto the runway itself. The same restriction is valid for case 4 Pattern B applications.

Safety Notice No. 5

14 Code of Federal Regulation (CFR) Part 139 Certificated Airports Runway Incursion Mitigation Requirement

Enhanced taxiway centerline markings, as illustrated in [Figure D-1](#), provide a safety benefit that lowers the risk of a runway incursion. Enhanced taxiway centerline marking improves situational awareness of pilots and vehicle operators on taxiway segments leading to a runway holding position marking. Uniformity of surface markings contributes to airfield safety by providing visual instructions that result in consistent interpretation by pilots and vehicle operators. Application of this surface painted marking establishes compliance with the taxiway centerline marking requirements under Part 139.311(a)(2).

4.3.2 Location.

Taxiway centerlines are enhanced for 150 feet (45.7 m) prior to a Pattern A – runway holding position marking, as shown in [Figure D-1](#), except for the situations described in paragraph 4.3.4. The portion of the taxiway centerline between the runway holding position marking and the runway itself is not enhanced. If the location of taxiway centerline lights and their housings interfere with the painting of the enhanced taxiway centerline, then lights and their housing can be covered up temporarily during the painting process, i.e., lights need not be relocated or housing painted to accommodate this requirement.

4.3.3 Color.

The enhanced taxiway centerline marking is yellow and must use glass beads. See paragraph 1.4 and [Table 1-1](#) for required techniques to enhance this marking. If a black border is required, the border on the outside of the dashes can be 3 to 6 inches (7.5 to 15 cm) in width. All black borders never use glass beads.

4.3.4 Characteristics.

The standard painted enhanced taxiway centerline marking consists of two parallel lines of yellow dashes, one on each side of the existing 6-inch (15-cm) or 12-inch (30-cm) taxiway centerline as shown in [Figure A-23](#) and [Figure D-5](#) for Case 1 applications and [Figure D-6](#) for Case 2 applications. As illustrated, the surface painted holding position sign(s) is located either off the taxiway centerline (Case 1) or centered directly over the taxiway centerline (Case 2). Taxiway width, built the taxiway design group, determines when to apply Case 1 or Case 2. For Case 1 applications, the first dashes start 6 to 12 inches (15 to 30 cm) from the runway holding position marking (Pattern A) as shown in [Figure D-1](#) for a length of 9 feet (2.7 m) and a width of 6 inches (15-cm), followed by a 3-foot (0.9 m) gap between the next set of dashes. For this case, the standard pattern

consists of 12 sets of 9-foot (2.75-m) dashes plus 3-foot (0.9-m) gap and ends with a set of 6-foot (1.8-m) dashes for a total length of 150 feet (45.7 m). For Case 2 applications, the first set of dashes is 36 inches (0.91 m) from the bottom of the surface painted holding position sign and follows the same Case 1 pattern. However, the length for Case 2 is 150 feet (45.7 m) as measured from the bottom of the Pattern A surface marking to the bottom of the last set of dashes. It is noted that for both Case 1 and Case 2 applications, the variety of existing taxiway geometries and the placement of the Pattern A runway holding position marking do cause variations to the standard pattern, especially the total length criterion of 150 feet (45.7 m). The sections below describe the most common taxiway geometries having such difficulties.

Painting Note No. 8

Transition Period for SPHPS when the Taxiway Width Changes Category between “more than 35 feet” and “35 feet or less”

When a taxiway width is increased from the category “35 feet (10.5 m) or less” to the category “more than 35 feet (10.5 m),” physically remove the on-centered SPHPS and apply a new SPHPS to the left of the taxiway centerline. In some cases, an additional SPHPS is required to the right of the taxiway centerline.

Physically remove the on-centered SPHPS and, mostly likely, the entire set of dashes of the enhanced taxiway centerline marking. Insert a new Figure D-5 standard surface pattern.

When a taxiway width is reduced from the category “more than 35 feet (10.5 m)” to the category “35 feet or less,” physically remove the off-center SPHPS and apply an on-centered SPHPS.

Physically remove the off-centered SPHPS and, most likely, the entire first set of dashes of the existing enhanced taxiway centerline marking. Insert a new Figure D-6 standard surface pattern.

Compliance: Although a single marking project should correct both the enhanced taxiway centerline markings and the SPHPS marking, the existing enhanced taxiway centerline marking may be corrected during the next painting project.

4.3.4.1 **Taxiway Serving Two Closely Spaced Runways.**

Figure D-16 illustrates how to paint enhanced taxiway centerline markings for a taxiway that connects two closely spaced runways. Each enhancement terminates at the runway edge unless the full 150-foot (46-m) length can be painted. Figure D-16 illustrates situations in which one enhancement is fully painted, one enhancement terminates at the outer edge of the runway edge marking, and the other enhancements terminate at the edge of the runway (Figure D-16 uses an unpainted reference line to terminate the enhancements to Runway 1/19).

4.3.4.2 **Taxiway/Taxiway Intersections and Merging Intersections.**

Figure D-11 (Note 2), Figure D-12 (Note 1), and Figure D-14 illustrate that if the taxiway centerline to be enhanced intersects another taxiway that is located within 150 feet (45.7 m) of a runway holding position marking and leads to a point other than onto the runway (another enhanced taxiway centerline), the enhancement must terminate 5 feet (1.5 m) prior to the point where the other taxiway centerline crosses the taxiway centerline that is being enhanced. In comparison, on a taxiway, as shown in Figure D-11 (Note 1) and Figure D-13, where the enhancement is 150 feet (45.7 m) or less and merges with a straight or curved taxiway centerline, the enhancement terminates at the last set of full dashes prior to the point of tangency with the other taxiway centerline.

4.3.4.3 **Single, Straight-In, Enhanced Taxiway Centerline Marking Intersecting a Runway Holding Position Marking at Angles of 90 Degrees.**

Figure D-10 and Figure D-12 (Note 3) show the standard painted patterns, i.e., the enhanced taxiway centerline measures 150 feet (45.7 m) in length. In comparison, Figure D-13 shows a painted pattern for Runway 16/34 in which an enhancement terminates at the last set of full dashes prior to the point of tangency with the other taxiway centerline marking.

4.3.4.4 **Straight-In, Enhanced Taxiway Centerline Markings Intersecting a Runway Holding Position Marking at Angles Other than 90 Degrees.**

Figure D-3 (details A – D) and Figure D-7 show standard painted patterns. When a straight-in enhancement intersects the runway holding position marking at an angle other than 90 degrees, the first dashes of the enhancement on either side of the taxiway centerline will start and stop at different locations. In this case, use the taxiway centerline as a guide to paint the enhancements as shown in details A – D of Figure D-3. This painting pattern will show both dashes starting 6 to 12 inches (15 to 30 cm) from the first solid bar of the runway holding position marking and ending at the same location. The finished pattern will show for the first set of dashes, one dash longer than 9 feet (2.7 m) and the other dash shorter than 9 feet (2.7 m).

4.3.4.5 **Single Taxiway Centerline Serving Two Runway Holding Position Markings.**

If a taxiway centerline intersects two runway holding position markings as shown in Figure D-12 (Note 2) and measures less than 300 feet (91.4 m) in length, then the entire taxiway centerline is enhanced only between the two runway holding position markings. In no case will the lacking length of the enhancement be painted between the runway itself and the runway holding position markings. To paint this enhancement, start with the 9-foot (2.75-m) dashes from each runway holding position marking (see paragraph 4.3.4.7.2 for painting practice). Next, continue painting the

pattern from each starting point until both enhancements meet at the midpoint of the curved taxiway centerline. It is okay if the dashes or the spaces at the midpoint are less than the length specified in the standard. The intent here is to maintain the pattern of long dashes and shorter spaces on each side of the centerline.

4.3.4.6 **Dual Holding Position Markings.**

If an ILS or a POFZ (Pattern B) holding position marking is within 150 feet (45.7 m) of a runway holding position marking (Pattern A), the enhanced taxiway centerline remains within the confines of the two holding position markings, i.e., the enhancement does not proceed beyond the ILS or the POFZ holding position marking. Under this situation, the enhanced taxiway centerline terminates 3 feet (0.9 m) before the ILS and the POFZ holding position markings.

4.3.4.7 **Curved and Multiple Taxiway Centerlines Converging Prior to or Intersecting a Runway Holding Position Marking.**

Various geometries exist such as those shown in [Figure D-9](#), [Figure D-10](#), [Figure D-11](#), and [Figure D-12](#). Below are the most common geometries and the recommended painting patterns.

4.3.4.7.1 Intersecting and Convergent Taxiway Centerlines.

As shown in [Figure D-2](#) and [Figure D-3](#) (Detail B), where two taxiway centerlines intersect or converge before or at the runway holding position marking, the outside dashes continue, with the possible exception of the first set of dashes, to maintain the 9-foot (2.75-m) pattern along the point of convergence. Depending on the geometry, the first inside dashes may be less than 9 feet (2.7 m) but must be aligned with the outside dashes, i.e., the inside dashes stop with and possibly start with the outside dashes. As noted in [Figure D-3](#) (Detail B), it is permissible to omit inside dashes that measure less than 5 feet (1.5 m). Detail B also illustrates that the inside dashes can overlap each other.

4.3.4.7.2 Curved Taxiway Centerlines Intersecting a Runway Holding Position Marking.

As shown in [Figure D-3](#) (Detail D), when a taxiway centerline is curved, the dashes on either side of the taxiway centerline would start and stop at different locations when maintaining the 9-foot (2.75-m) length.

Therefore, in order to correct this mismatch, apply the following painting practice, which takes all measurements from the taxiway centerline:

1. Each dash in the first set of dashes along with the taxiway centerline will start at the same distance, 6 to 12 inches (15 to 30 cm) from the first solid bar of the runway holding position marking.
2. To locate the end point of the first set of dashes, first measure 9 feet (2.7 m) along the taxiway centerline. Next, draw an imaginary line that

is perpendicular to the tangent of the taxiway centerline and mark the ends of the first dashes on each side of the taxiway centerline.

3. Measure an additional 3 feet (0.9 m) along the curved taxiway centerline. Next, draw an imaginary line perpendicular to the tangent of the curve and mark the starting point for the second set of dashes. The ending point for this set is found by measuring 9 feet (2.7 m) along the center of the curved taxiway centerline. An imaginary line perpendicular to the tangent at this point will mark the end of the second set of dashes.
4. Repeat the procedure for the remaining curved portion of the taxiway centerline, remembering that the last set of dashes only measures 6 feet (1.8 m).

4.4 **Taxiway Edge Marking.**

Where the term “taxiway edge marking” is used throughout this AC, it is understood to apply equally to taxilanes.

4.4.1 Purposes.

The taxiway edge marking, a dual continuous or dashed marking, is used along a taxi route to (1) alert pilots where the demarcation line exists between usable pavement for taxi operations and unusable pavement and (2) identify the edge(s) of a taxi route located on sizeable paved areas that can be crossed over by the pilot. Two marking schemes for the taxiway edge marking are available to the airport operator to indicate whether the pilot is allowed to cross the taxiway edge. Figure A-15, Figure C-3, and Figure C-4 illustrate these marking variations. For lighting provisions, see AC 150/5340-30.

4.4.1.1 **Continuous Taxiway Edge Marking.**

The continuous taxiway edge marking is used to delineate the taxiway edge from the shoulder or some other contiguous paved surface that is not intended for use by pilots. Continuous taxiway edge markings are never used in any operational situation where pilots are permitted to cross this surface marking, for example, a taxilane on a terminal used for gate access. See paragraph 1.5 for additional usage of this surface marking.

4.4.1.2 **Dashed Taxiway Edge Marking.**

The dashed taxiway edge marking is used where there is an operational need to define the edge(s) of a taxi route on or contiguous to a sizeable paved area that permits pilots to cross over this surface marking. A common application for this surface marking is a taxi route along the outer edge of a terminal apron. To achieve safety objectives, dashed taxiway edge markings are never used on entrance taxiways/bypass taxiways that directly enter a runway, such as shown in Figure 1-9 and Figure A-19 (see red safety box below, Runway Incursion Mitigation Requirement).

Furthermore, airports having dual or more parallel taxiways at a runway end, as shown in [Figure 5-1](#) with “paved islands,” must use continuous taxiway edge markings around all paved no-taxi islands. This safety measure is taken to ensure standard wingtip-to-wingtip clearances. Regardless of the taxi route’s site, the location for painting the dashed taxi edge marking must be per [AC 150/5300-13](#) using standard taxiway widths after obtaining standard taxiway/taxilane object free area widths for locating the taxiway centerline. In other words, these dashed taxiway edge markings (the stripe pattern) are never used to provide wing tip clearances for other moving or parked airplanes found, for example, operating on aprons. For this separation situation the airport operator may use the non-movement area boundary marking to indicate adequate clearance (taxiway/taxilane object free area).

4.4.2 Requirement.

Taxiway edge markings are used when deemed necessary by the airport operator or the FAA.

4.4.3 Location.

The taxiway edge marking is located such that the outer edge of the continuous line or dashed line defines the edge of the usable pavement.

4.4.4 Color.

Both taxiway edge marking schemes are yellow. If black borders are necessary, the black borders on the outside of the marking can be 6 inches (15 cm) in width and never use glass beads. See paragraph [1.4](#) and [Table 1-1](#) for recommended techniques to enhance this marking.

4.4.5 Characteristics.

4.4.5.1 The outermost edge of both dual dashed or dual continuous marking schemes must be painted along the edge of the usable pavement.

4.4.5.2 The continuous taxiway edge marking consists of dual, continuous lines with each line being at least 6 inches (15 cm) in width and spaced 6 inches (15 cm) apart (edge to edge) as shown in [Figure C-3](#). This continuous marking must be used to designate no-taxi islands as shown in [Figure 1-9](#) and [Figure A-19](#). (See paragraph [1.5](#).)

4.4.5.3 The dashed taxiway edge marking consists of dual, dashed yellow lines that are at least 6 inches (15 cm) in width and spaced 6 inches (15 cm) apart (edge to edge) as shown in [Figure C-4](#) or [Figure C-5](#). The dashed lines are 15 feet (4.5 m) in length with 25-foot (7.5-m) gaps as shown in [Figure A-15](#). This marking is never used to designate no-taxi islands.

Safety Notice No. 6

Runway Incursion Mitigation Requirement

Recorded runway incursion data associated with multi-taxiway entrance designs to a runway without “no-taxi islands” between the adjacent taxiway entrances have experienced a higher rate of runway incursions as compared to entrances with no-taxi islands. To reduce the possibility of runway incursions, all designs for a direct entrance to a runway that use two or more taxiway entrances must use “no-taxi islands” that are outlined with the dual continuous taxiway edge marking. In most cases, a green border to create the no-taxi island is required (see paragraph 1.5). AC 150/5300-13 prescribes and illustrates only bypass taxiway entrance designs that have unpaved no-taxi islands as part of the design.

- 4.4.5.4 For the cases where the taxiway edge marking intersects a holding position marking (Pattern A) which is:
 - 4.4.5.4.1 Outlined in black – the taxiway edge markings should abut the black outlines on both sides of the runway holding position marking, i.e., the borders for the yellow dashed and yellow solid line.
 - 4.4.5.4.2 Not outlined in black – a 6-inch (12 cm) gap is left between the holding position marking and the taxiway edge marking as shown in Figure A-13.

4.5 Surface Painted Holding Position Signs.

4.5.1 Purposes.

This surface painted sign provides supplemental visual cues that alert pilots and vehicle drivers of an upcoming holding position location and the associated runway designator(s) as another method to minimize the potential for a runway incursion and, for certain airport geometries, wrong runway takeoffs. Several applications of this surface painted sign for taxiways are shown in Figure D-5 (non-centered), Figure D-6 (centered) and Figure D-15 (stacked). The surface painted holding position sign is used only on taxiways (not runways) that connect a runway and have a Pattern A holding position marking. Taxiways that do not lead directly onto the runway, such as a taxiway that crosses through an approach area, are not to have this surface painted sign. In regards to Pattern B under specific landing operations, certain taxiway/runway geometries, for example Figure A-17, do occur in which this surface painted sign is necessary to protect both the runway entrance environment and the ILS or the POFZ protected area. Figure A-17 shows the POFZ protected area overlapping the holding bay at the entrance to the runway.

Safety Notice No. 7

14 Code of Federal Regulation (CFR) Part 139 Certificated Airports Runway Incursion Mitigation

Surface painted holding position signs (SPHPS), as illustrated in [Figure D-5](#) or [Figure D-6](#), provide a safety benefit that lowers the risk of a runway incursion. SPHPS enhance situational awareness of pilots and vehicle operators of holding positions on taxiway segments that lead directly to a runway. Uniformity of surface markings contributes to airfield safety by providing visual instructions that result in consistent interpretation by pilots and vehicle operators. Application of this surface painted marking establishes compliance with 14 CFR Part 139

4.5.2 Location.

The location (and number) of the SPHPS is determined by the width of the taxiway entrance and the number of taxiway centerlines that intersect the same holding position marking. Although the design of all taxiway entrances to a runway should have been based on a single taxiway design group, i.e., all taxiway entrances have the same standard width, some existing runways have varied taxiway widths serving more than one taxiway design group. In such cases, the taxiway design group for that taxiway entrance will determine the location (and number) of the surface painted marking. For example, a runway with a runway design code of C-III-5000 has one taxiway entrance built to TDG-2 standards and others built to TDG-3 standards. For the TDG-2 entrance, a single, centered surface painted marking as shown in [Figure D-6](#) is painted while the TDG-3 taxiway entrances are painted differently.

- 4.5.2.1 The SPHPS must not be painted on a runway, including runways that are temporarily used by ATCT as a taxiway.
- 4.5.2.2 In all cases, the SPHPS is never painted onto the taxiway shoulders.
- 4.5.2.3 In reference to the holding position marking (Pattern A), the surface painted holding position sign is always painted prior to and runs parallel to the holding position marking at a distance of 2 to 4 feet (0.6 to 1.2 m) as shown in [Figure D-5](#), [Figure D-6](#), and [Figure D-7](#). The location takes into account the direction of taxiing and should allow sufficient clearance for in-pavement runway guard lights and/or stop bars.
- 4.5.2.4 When a single taxiway centerline intersects the holding position marking (Pattern A), the surface painted holding position sign is located as follows:
 - 4.5.2.4.1 For taxiway widths that are greater than 35 feet (10.5 m) (TDG-3 - TDG-7), one or two surface markings are placed 3 to 10 feet (0.9 to 3.1 m) from the center of the taxiway centerline. With a few exceptions, one surface marking must be painted on the left side of the taxiway centerline. The left side rather than the right side is used because not all aircraft that may use

this entrance require two-person crews. The surface painted sign for the right side of the taxiway centerline, which is highly recommended for taxiway entrances serving airplane operations that require two-person crews, may be eliminated when a taxiway centerline is closer than 45 feet (13.7 m) from the edge of the taxiway and a mandatory vertical runway holding position sign is in clear view (from either left or right of the taxiway centerline.) Any airport with a taxiway entrance to a runway with insufficient lead-on length (see safety box under Condition 2 of paragraph 4.5.2.5 for definition) to the runway holding position marking, such as Figure D-11, must have two surface painted holding position signs, one on each side of the taxiway centerline marking. Because of the variety in taxiway geometries, such as shown in Figure D-9, Figure D-10, Figure D-11, Figure D-12, and Figure D-14, the taxiway centerline may or may not be perpendicular to the holding position marking. If the taxiway centerline is perpendicular, then placement of the surface painted holding position sign is in accordance with Figure D-5. If the taxiway centerline is not perpendicular, then placement is in accordance with Figure D-7.

- 4.5.2.4.2 For taxiways widths of 35 feet (10.5 m) or less (TDG-1A, TDG-1B, and TDG-2), one surface marking is centered directly over the taxiway center. If the taxiway centerline is perpendicular to the holding position marking (Pattern A), then placement of the surface painted holding position sign is as shown in Figure D-6. If the taxiway centerline is not perpendicular, then placement is still centered over the taxiway centerline, but oriented to run parallel to the holding position marking. That is, its placement would appear in like fashion when two such markings are painted as shown in Figure D-7.
- 4.5.2.5 When two or more taxiway centerlines intersect or converge within 15 feet (4.5 m) of the holding position marking (Pattern A), there might not be enough space for two or more surface painted holding position signs. Figure D-3, Figure D-12, and Figure D-16 are examples of layouts where it is not possible to paint all the required surface painted holding position signs for each converging taxiway centerline. In these cases, a surface painted holding position sign may be omitted on one side of the taxiway centerline as shown in Figure D-9 and Figure D-12 for TDGs 3-7 standard taxiway widths. In the cases of TDG-1A, TDG-1B, and TDG-2 standard taxiway widths, a single surface painted holding position sign must be centered over the two converging taxiways where separate surface markings would have overlapped each other. These and other types of geometries will require individual site assessment by the airport operator to determine the number of surface painted holding position signs that are required by this AC fit properly into the available space. In terms of proper spacing between two taxiway centerlines, a surface painted holding position sign should be approximately equidistant from both taxiway centerlines at a distance of no less than 3 feet (0.9 m) or more than 10 feet (3.1 m) from either taxiway centerline as measured from the center of the

taxiway centerlines to the nearest border of the surface painted holding position sign. For difficult taxiway geometries, the airport operator should consult their FAA Regional Airports Division Office or the Airports District Office (ADO) before painting any markings. For such requests, the airport operator should provide information about the rate of usage by each taxiway centerline, aircraft types, and the available space for painting.

Safety Notice No. 8

Wrong-Runway Takeoff Mitigation

If an airport has a taxiway entrance that simultaneously serves two or more runways, the surface painted holding position sign must show all runway designators plus directional arrows. The directional arrows must approximate the orientation of the runways.

The surface painted holding position sign is part of the standard signage requirements under Part 139.311(b)(1)(ii).

Safety Notice No. 9

Runway Incursion Mitigation Extra-Wide Taxiway Entrances

Condition 1.

Any airport with a taxiway entrance to a runway having a width greater than 200 feet (61 m) as measured along its runway holding position marking requires the following surface markings. First, a surface painted holding position sign must be painted on the left side of the taxiway centerline (or centered over the taxiway centerline for TDG-1A, TDG-1B, and TDG-2 standard taxiway widths). Second, depending on how excessive the width, a “repetitive pattern” of additional surface painted holding position signs must be painted in accordance with Table 4-1 below. This second requirement is in direct response to documented runway incursions associated with extra-wide taxiway entrances to a runway. Note the spacing requirement is based on the Airplane Design Group component of the Runway Design Code, not the Taxiway Design Group.

The repetitive pattern of Table 4-1 relates the spacing of the additional markings to the viewing angles of pilots and to the painting of future parallel taxiway entrances according to AC 150/5300-13. In other words, when the airport operator decides to paint additional parallel taxiway entrances, the criterion in Table 4-1 would already have in place the required surface painted holding position sign within the proper distance of the newly painted taxiway centerlines (or centered over the taxiway centerline for TDG-1A, TDG-1B, and TDG-2).

Safety Notice No. 9

When the airport operator paints additional parallel taxiway entrances, then the repetitive pattern is completed by painting a no-taxi island per paragraph [1.5](#).

Table 4-1. Placement of Repetitive Surface Painted Holding Position Signs and No-Taxi Islands on Taxiway Entrances of Over 200 Feet (61 m) in Width

Airplane Design Group (ADG) Category ¹	Distance between adjacent surface painted holding position signs ² as measured from the same outer edge ³	Midpoint distance for a no-taxi island between parallel taxiway centerlines ⁴ as measured from either taxiway centerline
	Feet (meters)	Feet (meters)
ADG I	69 (21)	34.5 (10.5)
ADG II	105 (32)	52.5 (16)
ADG III	152 (46.5)	76 (23.25)
ADG IV	215 (65.5)	107.5 (32.75)
ADG V	267 (81)	133.5 (40.5)
ADG VI	324 (99)	162 (49.5)

Note 1: The terms Airplane Design Group and Taxiway Design Group are defined in [AC 150/5300-13](#).

Note 2: Each entry equals the taxiway centerline to parallel taxiway centerline value based on ADGs listed in [AC 150/5300-13](#).

Note 3: The listed value assumes that the existing surface painted holding position sign is used as the starting point to measure and paint additional surface markings either on the left side of the taxiway centerline ([Figure D-5](#)) or directly centered over the taxiway centerline ([Figure D-6](#)). For taxiways with dual surface markings, such as shown in [Figure D-5](#), the measurement should still be from the left-side surface marking. If there is no left-side surface marking, use the center of the taxiway centerline and add 3 to 10 feet (0.9 to 3.1 m) to the listed value in [Table 4-1](#). This numeric range is the dimension letter B used in [Figure D-5](#).

Note 4: Each entry is half of the taxiway centerline to parallel taxiway centerline value based on ADG listed in [AC 150/5300-13](#).

Condition 2.

Any ADG III–VI runway with a taxiway entrance to a runway with insufficient lead-on length to the runway holding position marking must have two surface painted holding position signs, one on each side of the taxiway centerline marking.

The term “insufficient lead-on-length” is defined as follows:

1. For the case of a perpendicular taxiway centerline intersecting the holding position marking, such as shown in [Figure D-5](#), [Figure D-12](#) curve #3, and [Figure D-14](#), the design airplane for that runway is unable to line up its entire fuselage perpendicular to the runway holding position marking.

Safety Notice No. 9

2. For the case of a non-perpendicular taxiway centerline intersecting the holding position marking, such as shown in [Figure D-7](#) and [Figure D-9](#), the design airplane for that runway is unable to line up its entire fuselage on a straight section of the entrance taxiway centerline while holding at the runway holding position marking.

Three quick, visual indications of this undesirable design condition are (1) taxiway centerlines, such as shown in [Figure D-9](#), that only curve into the runway holding position marking; (2) holding position markings, such as shown in [Figure D-14](#), that are painted in or near the region where taxiway fillets are constructed; and (3) an enhanced taxiway centerline that measures far less than 150 feet (45.7 m) in length.

[Figure D-9](#), [Figure D-10](#), [Figure D-11](#), and [Figure D-12](#) provide some examples on how to paint left-of-centerline and right-of-centerline surface painted holding position signs.

The surface painted holding position sign is part of the standard signage requirements under Part 139.311(b)(1)(ii).

4.5.3 Color.

The surface painted holding position sign has a red background with a white inscription and, on light-colored pavements, is outlined in black. Although this marking supplements the mandatory runway holding position sign, the black outline that surrounds the white alphanumeric inscription on the signs is not required for the surface painted holding position sign. See paragraph [1.4](#) and [Table 1-1](#) for required techniques to enhance this marking.

4.5.4 Characteristics.

4.5.4.1 The standard height of the inscription and its location are as follows:

4.5.4.1.1 For taxiway widths that are greater than 35 feet (10.5 m) (TDGs 3-7), the inscription is 12 feet (3.7 m), but may be reduced in accordance with the criteria in [Figure D-5](#).

4.5.4.1.2 For taxiways widths of 35 feet (10.5 m) or less (TDG-1A, TDG-1B, and TDG-2), the inscription is in accordance with the criteria in [Figure D-6](#).

Painting Note No. 9

Solutions for Difficult Placements Stacked Surface Painted Holding Position Signs

For taxiway entrances or a taxiway entrance with a complex geometry that requires a lengthy inscription (a single surface marking) for two or more runways and that will not fit properly between the existing taxiway centerline and the taxiway edge, the airport operator should reduce the inscription height. Under this solution, the lowest allowable height for the inscription for TDGs 3-7 standard taxiway widths is 6 feet (1.8 m), and for TDG-1A, TDG-1B, and TDG-2 standard taxiway widths the lowest allowable height is 3 feet (0.9 m). This painting solution may be necessary for smaller standard taxiway widths whose entrance taxiways support two runway ends. If this solution fails, the single marking may then be broken into two separate markings, one marking per runway, but stacked one above the other as shown in [Figure D-15](#). Under this solution, the airport operator should fit the stacked markings such that (1) the height of the inscription is increased toward the standard height and (2) the separation between the stacked inscriptions is 2 to 4 feet (0.6 to 1.2 m). For taxiways less than or equal to 35 feet (10.7 m) wide, the stacked surface painted holding position signs are located centered on the taxiway in accordance with criteria in [Figure D-6](#). See [Figure D-15](#) for the recommended order of appearance for stacked surface painted holding position signs.

Note: All other unaffected runway holding positions that do not require a reduced inscription height must use the standard inscription height. The intent of this note is to maintain uniformity in visual cues across the United States.

- 4.5.4.2 The inscription must be identical to the runway holding position sign by using the same numbers, letters, and arrows. The appearance of the letters, numbers, and arrows must be per [Appendix B](#).
- 4.5.4.3 The background is rectangular and extends horizontally and vertically beyond the extremities of the inscription by 7.5 inches (19 cm) for TDG-1A, TDG-1B, and TDG-2 standard taxiway widths, and by 15 inches (38 cm) for TDGs 3-7 standard taxiway widths.
- 4.5.4.4 The surface painted holding position sign is at least 2 feet (0.6 m) from the edge of the inside taxiway edge marking or from the edge of the paved taxiway when there are no taxiway edge markings. See [Figure D-4](#).

4.6 Surface Painted Taxiway Direction Signs.

4.6.1 Purpose.

The surface painted taxiway direction sign is used with an arrow to provide directional guidance at an intersection.

4.6.2 Requirement.

This marking is required where it is not possible to provide a taxiway direction sign in accordance with AC 150/5340-18. Optionally, it may be installed where operational experience has indicated that its presence at a troublesome taxiway intersection can assist flight crews in better ground navigation. For signage provisions, see AC 150/5340-18.

4.6.3 Location.

The edge of the surface painted taxiway direction sign (excluding the black border if used) is 3 feet (0.9 m) from the edge of the taxiway centerline and is located on the side of the taxiway centerline that the aircraft travels as shown in Figure A-19. That is, markings that indicate left turns are located on the left-hand side of the taxiway centerline while markings indicating right turns are located on the right-hand side of the taxiway centerline.

4.6.3.1 The surface painted taxiway direction sign is not painted on runways, including runways that are operationally used as a taxiway, or painted between the runway holding position marking (Pattern A) and the runway.

4.6.3.2 For crisscrossing taxiways, such as two taxiways crisscrossing at 90 degrees to each other, a surface painted taxiway direction sign is combined with arrows to indicate the different travelling directions at the intersection. Under this application, the single marking is located on the left side of the taxiway centerline.

4.6.3.2.1 When it is not practicable to install a taxiway direction sign along the side of the taxiway, paint a surface painted taxiway direction sign and locate it at the same distance from the intersection per AC 150/5300-13 standards for fixed/moveable objects.

4.6.3.2.2 When a surface painted taxiway direction sign supplements a taxiway direction sign installed along the side of the taxiway, the surface painted direction sign may be located at or within the distances per AC 150/5300-13 standards for fixed/moveable objects, and the point of divergence of the painted taxiway centerlines.

4.6.3.3 A surface painted taxiway direction sign is not co-located with a surface painted holding position sign.

4.6.4 Color.

The surface painted taxiway direction sign has a yellow background with a black inscription that includes an arrow(s). See paragraph 1.4 and Table 1-1 for required techniques to enhance this marking. On light-colored pavements, a 6-inch (15-cm) black border completely surrounds its perimeter.

4.6.5 Characteristics.

- 4.6.5.1 The black inscription is 12 feet (3.7 m) in height. However, the height may be reduced if necessary to the minimum height of 9 feet (2.7 m).
- 4.6.5.2 Each black inscription must be accompanied by an arrow oriented to show the approximate direction of a turn.
- 4.6.5.3 The black inscription with the arrow(s) must conform in appearance to the letters, numbers, and symbols in Appendix B.
- 4.6.5.4 The yellow background is rectangular and extends a minimum of 15 inches (38 cm) horizontally and vertically beyond the extremities of the black inscription, which includes the arrow head(s).
- 4.6.5.5 A 6-inch (15-cm) wide vertical black stripe separates two black inscriptions when more than one inscription is included on the same side of the taxiway centerline.
- 4.6.5.6 See paragraph 4.7.5.4 when collocating a surface painted taxiway direction sign with a surface painted taxiway location sign.

4.7 **Surface Painted Taxiway Location Signs.**

4.7.1 Purposes.

The surface painted taxiway location sign identifies the taxiway upon which the aircraft is located. This marking is used to supplement other signs located along the taxiway system.

4.7.2 Requirement.

This marking is required when deemed necessary by the airport operator or FAA. Optionally, it may be installed where operational experience has indicated that its presence can assist flight crews in better ground navigation. For signage provisions, see AC 150/5340-18.

4.7.3 Location.

The surface painted taxiway location sign is located normally on the right side of the taxiway centerline in the direction of travel as shown in Figure A-19. The edge (excluding the black border if used) of the surface painted taxiway location sign should be 3 feet (0.9 m) from the edge of the taxiway centerline.

- 4.7.3.1 When adequate pavement width exists, a surface painted taxiway location sign may be located on the left side of the taxiway centerline if it is co-located to the left of a surface painted holding position sign (paragraph 4.5). In this case, the two surface painted signs will mimic the mandatory holding position signs. Under this application, if the co-located surface

painted taxiway location sign and the mandatory holding position sign serve two converging taxiways, then the surface painted taxiway location sign should be located to the left of the surface painted holding position sign (in the direction of taxiing).

- 4.7.3.2 The surface painted taxiway location sign is not painted on runways, including runways that are operationally used as a taxiway, or painted between the runway holding position marking (Pattern A) and the runway.

4.7.4 Color.

The surface painted taxiway location sign has a black background with a yellow inscription, and a yellow border around its perimeter for all pavement surfaces. See paragraph [1.4](#) and [Table 1-1](#) for required techniques to enhance this marking.

4.7.5 Characteristics.

- 4.7.5.1 The yellow inscription is 12 feet (3.7 m) in height. However, the height may be reduced if necessary to the minimum height of 9 feet (2.7 m).
- 4.7.5.2 The yellow inscription never contains an arrow and must conform in appearance to the letters, numbers, and symbols in [Appendix B](#).
- 4.7.5.3 The background is rectangular and extends a minimum of 15 inches (38 cm), which includes the 6-inch (15-cm) yellow border, horizontally and vertically beyond the extremities of the yellow inscription.
- 4.7.5.4 When a surface painted taxiway location sign is collocated with a surface painted taxiway direction sign on any pavement surface, paint the inscriptions for both markings of equal height.

4.8 **Surface Painted Gate Destination Signs.**

4.8.1 Purpose.

The surface painted gate destination sign is used to assist pilots in locating their assigned terminal gate. The marking is especially useful for low-visibility operations.

4.8.2 Requirement.

This marking is optional.

4.8.3 Location.

The surface painted gate destination sign may be installed in non-movement areas or movement areas that are in the proximity of terminal building(s) per the examples in [Figure A-20](#) and [Figure A-21](#). The markings are located adjacent to taxiway centerlines on the same side in which a turn will be made while traveling toward the assigned gate.

4.8.4 Color.

The surface painted gate destination sign has a solid yellow background with a black inscription. On light-colored pavements, a 6-inch (15-cm) black border may be used. See paragraph [1.4](#) and [Table 1-1](#) for required techniques to enhance this marking.

4.8.5 Characteristics.

4.8.5.1 For surface painted gate destination signs containing only a single row of several gate designations as shown in [Figure A-20](#), the black inscriptions must have a maximum height of 4 feet (1.2 m).

4.8.5.2 For surface painted gate destination signs containing more than one row of gate designations, shown as an option in [Figure A-21](#), the inscriptions must have a minimum height of 3 feet (0.9 m). There is no maximum height size for a surface painted gate destination sign containing more than one row of inscriptions.

4.8.5.3 The background of the marking is rectangular and extends a minimum of 15 inches (38 cm) horizontally and vertically beyond the extremities of the inscriptions.

4.8.5.4 The black inscription must conform in appearance to the letters, numbers, and other symbols in [Appendix B](#).

4.8.5.5 A range of gates that are sequential should be indicated with a single dash. For example, a series of gates A1 through A4 are indicated as “A1 - A4”.

4.8.5.6 A range of gates that are non-sequential should be separated by commas. For example, the gates B1, B3, and B6 are indicated as “B1, B3, B6.”

4.9 **Surface Painted Apron Entrance Point Signs.**

4.9.1 Purpose.

The surface painted apron entrance point sign is used to assist pilots in locating their position along the edges of a large, continuous apron serving the terminal gates. The marking is especially useful for identifying both the entrances and exits in and along the terminal complex. To facilitate shorter, less confusing verbal communication and to enhance the movement of ground traffic, the surface painted apron entrance point sign is sometimes referred to as the “apron spot” at some airports.

4.9.2 Requirement.

This marking is optional.

4.9.3 Location.

The surface painted apron entrance point sign may be painted in non-movement areas or movement areas that are in the proximity of an apron leading to the concourses or

terminal buildings as shown in [Figure A-22](#). The marking, located 7 feet (2.1 m) from taxiway centerline(s), is on the same side of the centerline to which a turn will be made to travel toward the assigned gate.

4.9.4 Color.

The surface painted apron entrance point sign has a yellow background with a black inscription. The color of the border depends on the pavement color. Concrete or light-colored pavement should use a black border, while dark pavements should use a white border.

4.9.5 Characteristics.

- 4.9.5.1 The surface painted apron entrance point sign consists of three 9-foot (2.7-m) diameter circles each located 7 feet (2.1 m) from the associated taxiway/apron centerline. As shown in [Figure A-22](#), two circles are located on either side of the entrance taxiway centerline(s) that continues toward the gate and ends with the third circle.
- 4.9.5.2 For taxiways that do not turn but continue forward, only the third circle is painted (see [Figure 4-2](#)). For complex taxiways where two converging taxiway centerlines cross the non-movement boundary marking in very close proximity to each other, the airport operator may paint a single marking near the non-movement boundary marking that is between the two converging taxiway centerlines. That is, the single marking is not overlapping the taxiway centerlines. For a single taxiway centerline that diverges into two separate taxiway centerlines just prior to the non-movement boundary marking, paint a single marking on the taxiway centerline prior to its splitting into different taxiway centerlines.
- 4.9.5.3 Each circle is comprised of an inner 8-foot (2.7-m) diameter yellow circle with a 6-inch (15-cm) outer ring that is black in color for concrete and light-colored pavements and is white in color for asphalt pavements.
- 4.9.5.4 The inscription is either numeric or alpha-numeric. For the situation that consists of three circles, the inscription for gate designation within each of the three circles should match.
- 4.9.5.5 The black inscription inside each circle should be 4 feet (1.2 m) in height.
- 4.9.5.6 The appearance of the inscription numbers must conform to the scale of letters, numbers, and other symbols in [Appendix B](#).

4.10 Taxiway Shoulder Markings.

4.10.1 Purpose.

Aprons, holding bays, and taxiways are sometimes provided with paved shoulders or stabilization per AC 150/5300-13 to prevent ground erosion attributed to jet blast or water runoff or to minimize engine damage caused by foreign object debris. Although these shoulders are not intended for use by aircraft, conditions may exist along a taxi route that confuse pilots and cause them to use the shoulders. For example, a particular taxiway curve with an extra-wide paved shoulder may confuse pilots as to which side of the painted taxiway edge marking stripe is intended for their use. Where such conditions exist, the airport operator should paint taxiway shoulder markings to indicate the non-usable (deceptive) area to pilots. Figure A-23 illustrates this surface marking.

4.10.2 Requirement.

This marking is optional.

4.10.3 Location.

The taxiway shoulder marking is painted using a perpendicular reference line drawn from the taxiway centerline. The start and stop points, and separation gaps, for painting the marking are described below.

4.10.3.1 Referring to Figure A-23 on straight sections, the taxiway shoulder markings will be placed perpendicular at each point of intersection with the defined edge of paved taxiway or the taxiway edge marking with additional markings being uniformly placed between the two start and finish markings. The spacing of the markings, centerline-to-centerline, will not exceed 100 feet (30.5 m) between two adjacent markings as shown in Figure A-23.

4.10.3.2 Referring to Figure A-23 on curved sections, the taxiway shoulder markings will be uniformly spaced along the curve. The first and last markings are placed perpendicular at the point of curvature and point of tangency of the curve or, in the case of a runway/taxiway intersection, at the point of intersection of the runway and taxiway edges. The spacing of the markings, centerline-to-centerline, will not exceed 50 feet (15 m) between two adjacent markings measured at the largest gap of the radially-spaced markings. Two cases exist for the largest gap of the radially-spaced markings.

4.10.3.2.1 Case 1 - For a taxiway that intersects a paved area as shown in Figure A-23, both curved shoulders are referred to as “inboard” shoulders. Under this case use a 50-foot (15-m) centerline-to-centerline separation (maximum separation) as measured along the inner edge of the curved shoulder that abuts the paved taxiway. Notice that in case 1 both curved shoulders are categorized as inboard shoulders.

4.10.3.2.2 Case 2 - For a taxiway that makes a turn prior to connecting another paved area, as shown in [Figure A-10](#), one curved shoulder is referred to as an “inboard” shoulder and the other as an “outboard” shoulder. Placement of the taxiway shoulder marking along the inboard shoulder is measured as described above. For the outboard shoulder use the same maximum 50-foot (15-m) centerline-to-centerline placement of the taxiway shoulder marking but as measured along the outer edge of the curved shoulder that abuts the ground.

4.10.4 Color.

The taxiway shoulder marking is yellow.

4.10.5 Characteristics.

The area is marked with 3-foot (1-m) wide yellow stripes that start with the edge of the paved taxiway or the edge of the taxiway edge marking (paint over the black border if present) and extended to within 5 feet (1.5 m) of the edge of the paved/stabilized shoulder area or 25 feet (7.5 m) in length, whichever length is less.

4.11 **Geographic Position Markings.**

4.11.1 Purpose.

The geographic position marking (GPM), as shown in [Figure A-24](#), is used repeatedly along a designated taxi route to serve as an indicator of a location (a spot) so that pilots can confirm holding points or report their location while taxiing during periods of low-visibility operations. Low-visibility operations are those taxiing operations prior to takeoff or after landings that occur when the runway visual range (RVR) is below 1,200 feet (366 m). Operationally, these sequentially numbered holding points differ from a reporting point. For example, one of the GPM (the spot) may be used only as a reporting point when ATCT is sequencing airplanes along the LVO/SMGCS route—when the first airplane reports to ATCT it is passing spot #3, ATCT would then clear the next airplane up to the next open spot.

Note: See AC 120-57, Surface Movement Guidance and Control System, and [AC 150/5340-18](#) for signage and lighting provisions.

4.11.2 Requirement.

This marking is required as noted in the airport’s LVO/SMGCS plan.

4.11.3 Location.

The repeated marking is located along a low-visibility taxi route identified by the airport’s LVO/SMGCS Plan. Each marking is positioned to the left of the taxiway centerline in the direction of taxi.

4.11.3.1 All geographic position markings used operationally by the airport traffic control tower to designate a specific hold point along the low-visibility taxi route are co-located with the intermediate holding position marking

(Pattern C) for taxiway/taxiway intersections as shown in Figure A-24. For a taxi route designated for use in visibilities below 500 RVR, the geographic position marking must be collocated with the intermediate holding position marking as well as a clearance bar consisting of three yellow lights. When the GPM is not used operationally for hold points, i.e., when the spot is always used as a reporting point for sequencing operations, the painting of an intermediate holding position marking and the installation of the clearance bar are optional. To avoid operational confusion, GPM must not be collocated with Pattern A or Pattern B surface markings.

- 4.11.3.2 The geographic position marking is never located at a runway holding position marking (Pattern A) location that immediately enters the runway used for the departure. However, the GPM may be located at a runway holding position for other runway(s) that the designated low-visibility taxi route happens to cross prior to arriving at the departure runway.
- 4.11.3.3 A taxiway/taxiway intermediate holding position marking should be used with the geographic position marking, except for a GPM that is located at a runway holding position for the runway that will not be used for takeoff.
- 4.11.3.4 The airport operator, in coordination with the FAA Regional Airports Division Office or the Airports District Office, will determine where the geographic position markings are deemed necessary. Generally, the geographic position markings are sequentially numbered holding points along a designated taxi route. To offer airport operators greater flexibility in developing a labeling scheme benefitting ATCT, the inscription scheme may, if approved by the FAA, take into account the specific taxiway intersections. For example, a geographic position marking that is located near Taxiway B2 may be labeled “2B” while another geographic position marking associated with Taxiway E4 is labeled “4E.”

4.11.4 Color.

The geographic position marking, as shown in Figure A-24, is a 7-foot (2-m) diameter pink circle with a black inscription surrounded by two 6-inch (15-cm) wide rings, one white and one black. When the geographic position marking is painted on concrete or other light-colored pavements, the white ring is inside the black outer ring. When the geographic position marking is installed on asphalt or other dark-colored pavements, the white ring becomes the outer ring and the black ring becomes the inner ring. See paragraph 1.4 and Table 1-1 for required techniques to enhance this marking.

4.11.5 Characteristics.

The GPM is designated with a black inscription that may be a single number or a number-letter combination. Since the basic marking reappears along the designated low-visibility LVO/SMGCS taxi route, each inscription must correspond to the sequential position identified by the LVO/SMGCS Plan. The sequential process for inscriptions is as follows.

- 4.11.5.1 The number used for the inscription must correspond to its sequential position along the LVO/SMGCS taxi route, i.e., 1, 2, 3, etc.
- 4.11.5.2 When a number plus a letter combination is used for the inscription, the letter indicates the taxiway's letter designation on which the marking is located. For example, the inscription "2B" implies the second marking along Taxiway B. Additionally, the number always precedes the letter for all inscriptions.
- 4.11.5.3 If a GPM is located on a taxiway with an alphanumeric designation, only the letter portion of the taxiway designation is used for all the inscriptions. For example, if the fourth location on the LVO/SMGCS taxi route is located on Taxiway A7, the inscription for this location would read "4A".
- 4.11.5.4 The inscription inside the GPM is centered within the circle.
- 4.11.5.5 The inscription has a height of 4 feet (1.2 m).
- 4.11.5.6 The numbers and letters used in the inscription are scaled to those in Appendix B.

4.12 **Apron Control Markings.**

4.12.1 Purpose.

The apron control marking is used to facilitate the local apron tower or the FAA airport traffic control tower in the movement of aircraft and vehicles to designated areas of aprons, aprons, and other paved areas between non-movement areas and the movement area. In terms of controller workload, the surface marking simplifies verbal communications between controllers, pilots, and vehicle drivers during this transition process.

4.12.2 Requirement.

This marking is optional.

4.12.3 Location.

The apron control marking is predominantly located on terminal aprons and cargo aprons within the non-movement area but may be painted within the movement area.

4.12.4 Color.

The apron control marking has a black inscription on a yellow background with a black border when painted on light-colored pavements. See Table 1-1 for general guidelines for determining light-colored pavements. The black inscription, determined by the airport operator, may be numeric, letters, or alphanumeric with or without special characters such as an arrow. Flexibility is acknowledged for the black inscription as a means for the airport operator to address the varied operational applications conducted on diverse apron and apron layouts. The black inscription is centered within the surface

marking with a height of at least 4 feet (1.2 m). The numbers, letters, and other characters used in the inscription are scaled to those in Appendix B.

4.12.5 Characteristics.

Two recommended shapes for apron markings are as follows. Note: Existing apron marking schemes that differ from the two recommended shapes may remain until repainting is necessary for a major section or to replace the existing marking scheme to one of the recommended shapes.

4.12.5.1 **Circular-shaped.**

Circular apron markings—illustrated in Figure 4-1, Figure 4-2 and Figure 4-3—should have a diameter of at least 9 feet (2.7 m), which excludes the black border. The diameter of the circular marking must be increased so the width and height of the black inscription is at least 1 foot (30 cm) from the edges of the yellow circumference. Place the marking directly over the taxiway centerline or so the outer edge of the circular marking, excluding the black border, is within 7 feet (2.1 m) of the taxiway centerline.

Figure 4-1. Sequential Circular-Shaped Apron Control Markings 3, 4, and 5 Between Two Terminals

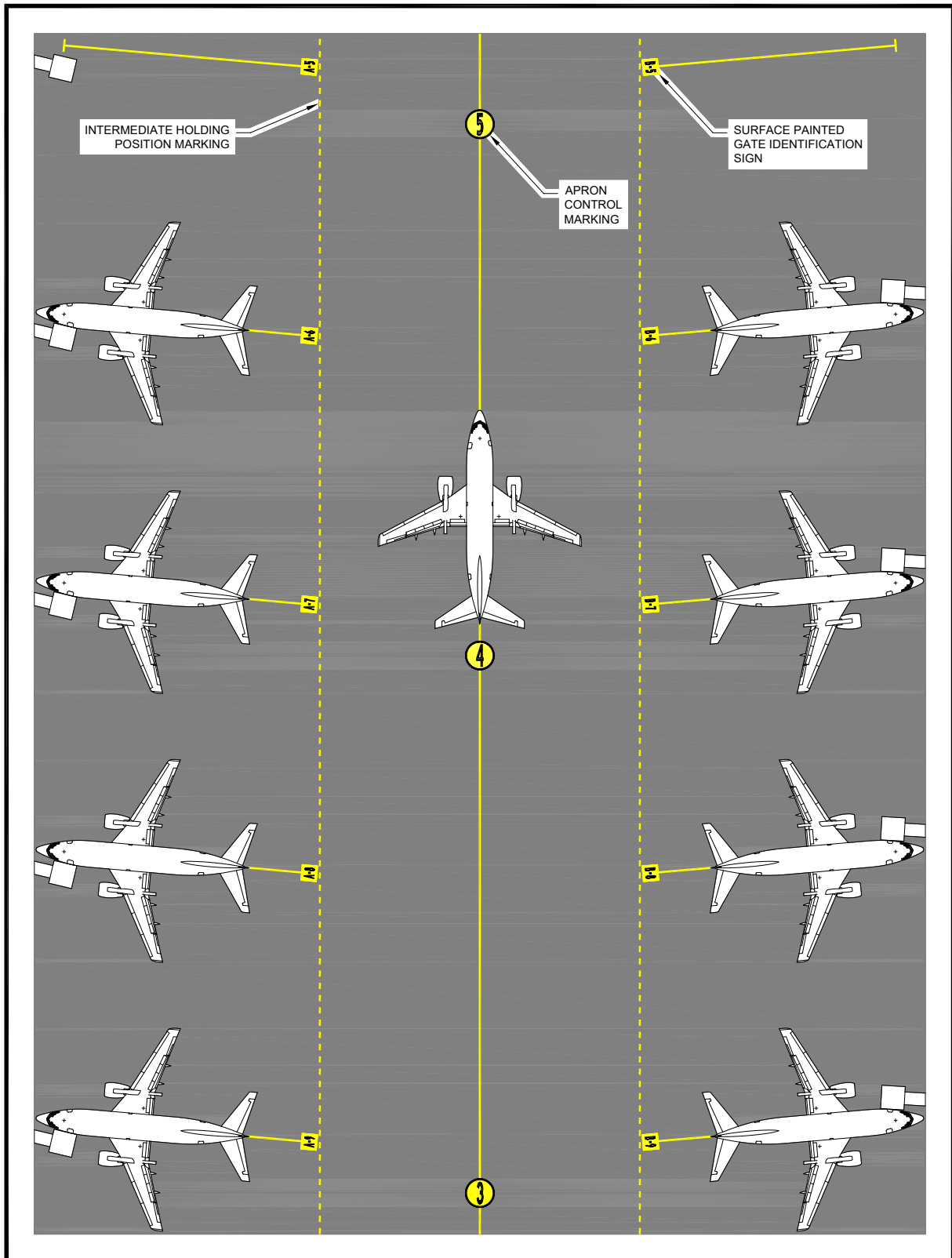

Figure 4-2. Circular-Shaped Apron Control Marking 16 on Elongated Terminal Apron

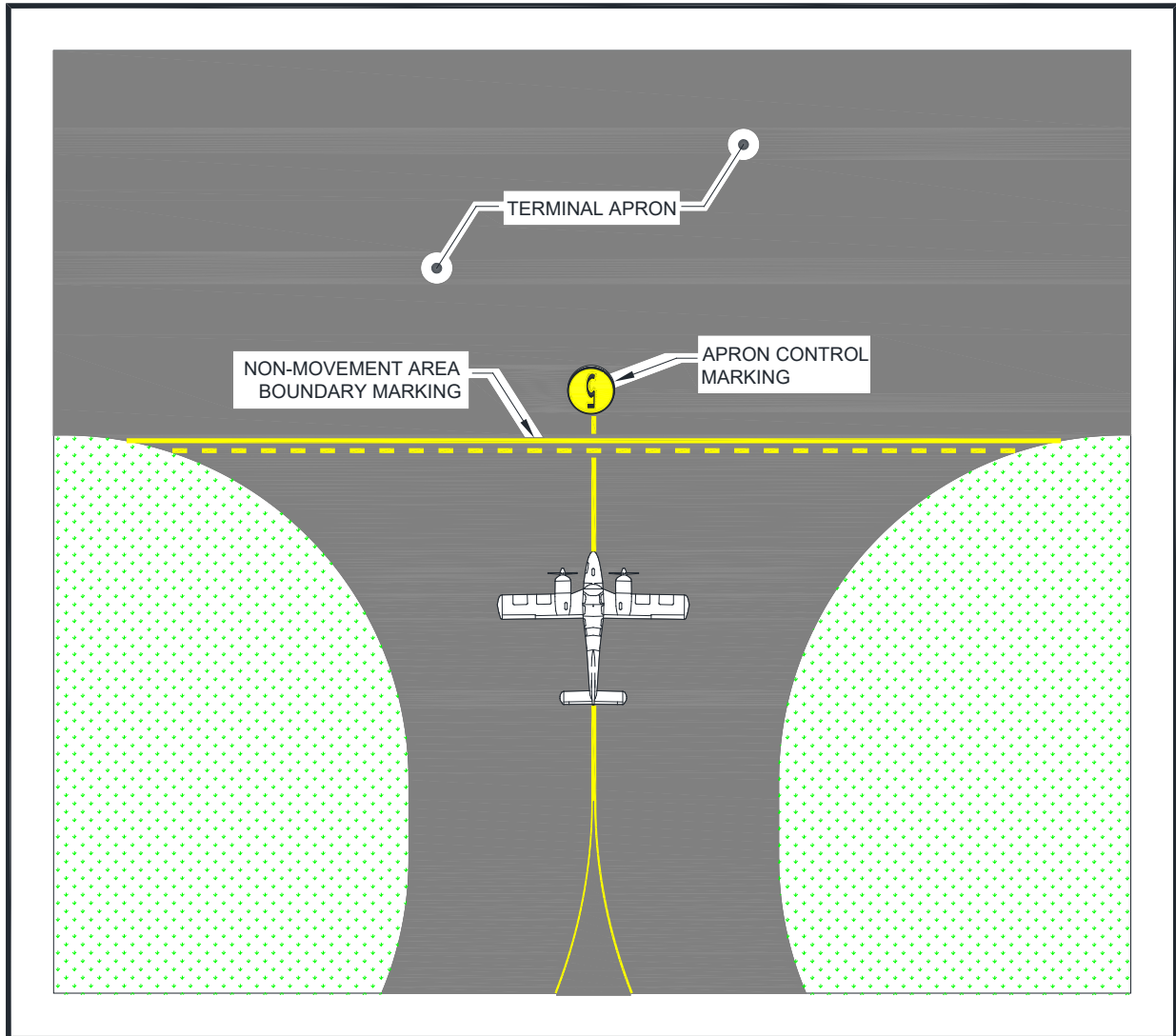
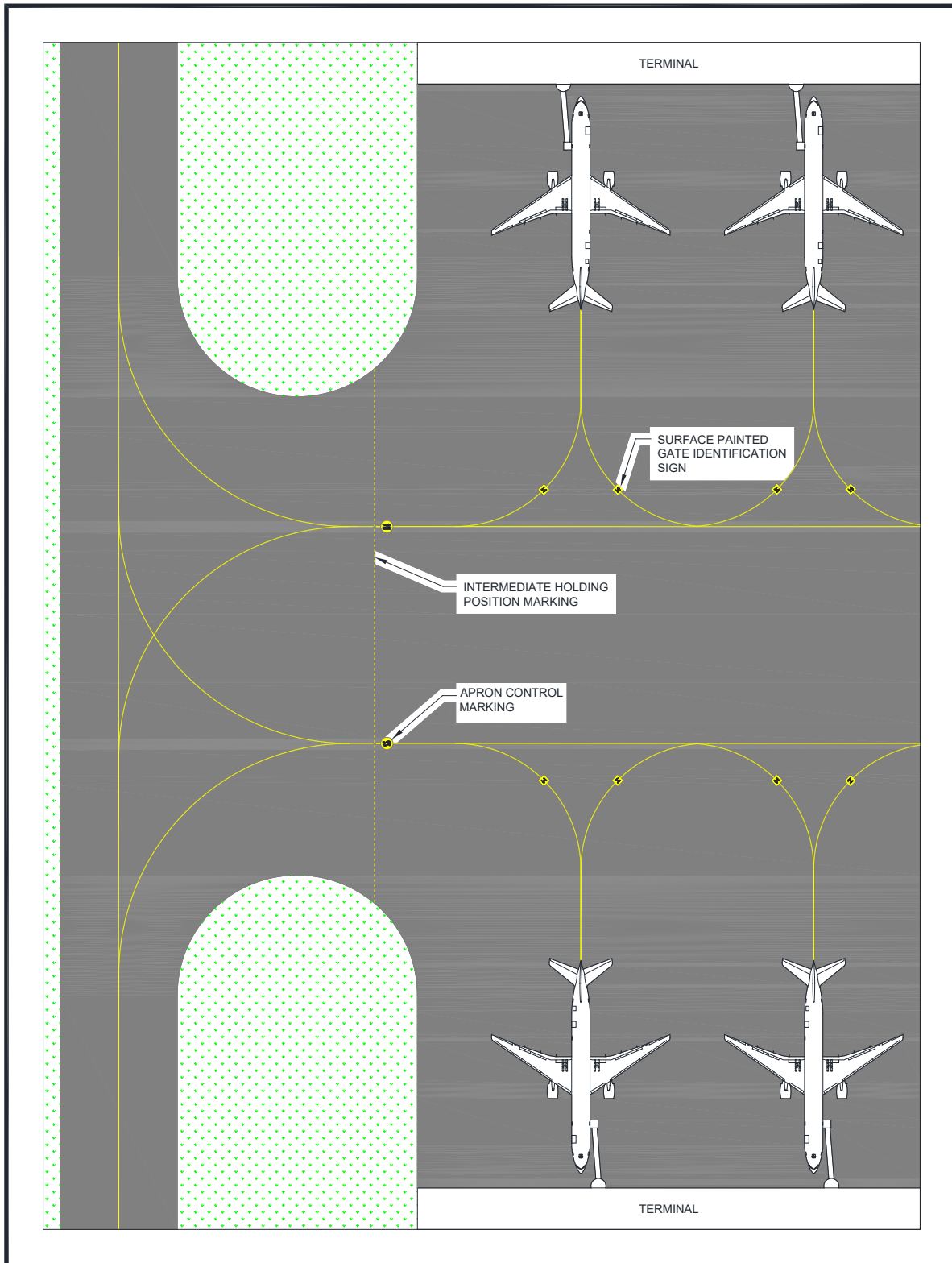

Figure 4-3. Circular-Shaped Apron Control Markings 9S and 9N Between Terminals



4.12.5.2 Triangular-shaped.

Triangular-shaped apron markings, as illustrated in Figure 4-5, offer pilots and drivers the additional function of reinforcing a specific direction of travel. Triangular-shaped apron markings are equiangular triangles of at least 9 feet (3 m) in height. The base and height of the triangular marking must be increased so that the width and height of the black inscription is at least 1 foot (30 cm) from the edges of the yellow triangle. Place the marking directly over the taxiway centerline.

Figure 4-4. Triangular-Shaped Apron Control Marking Between Terminals

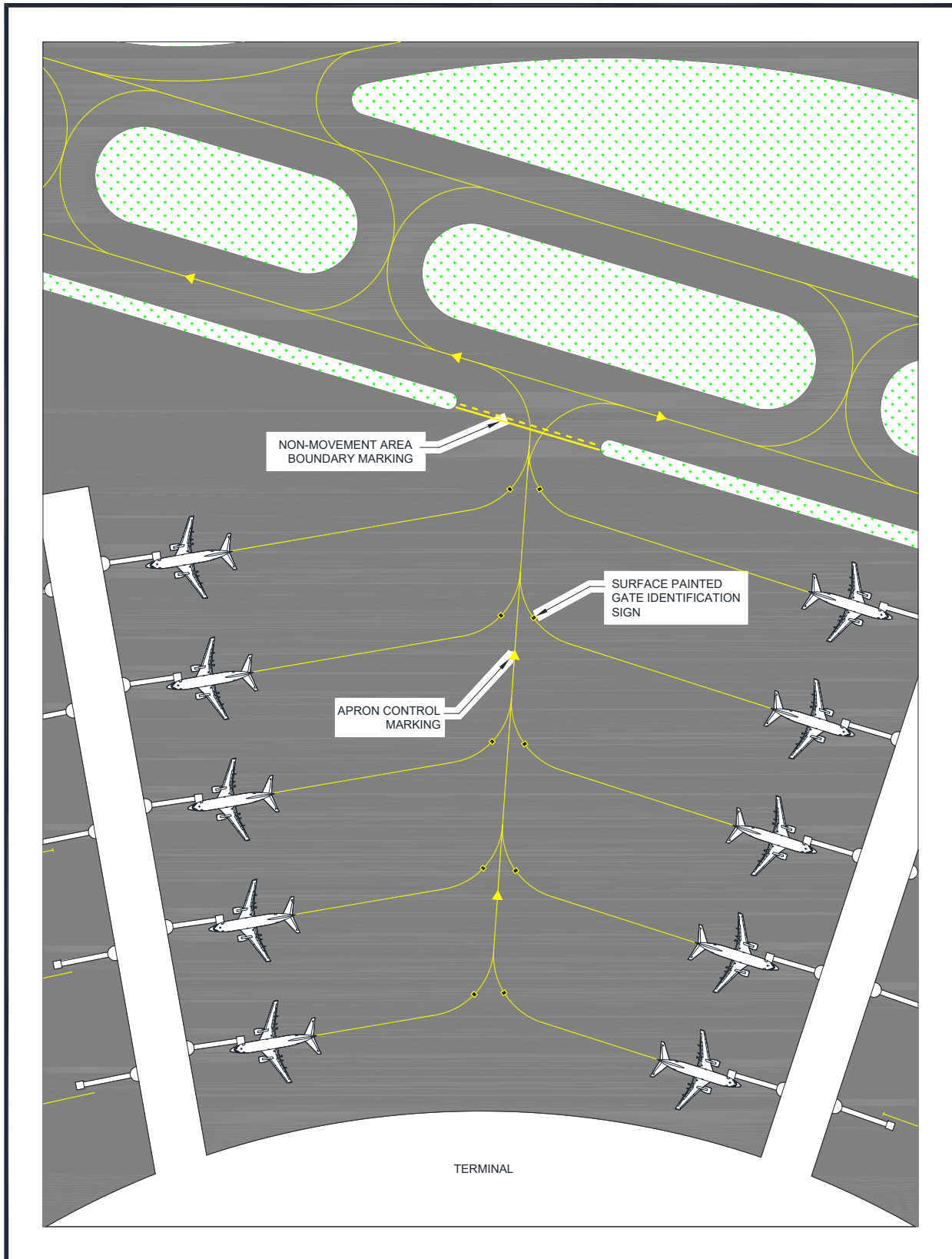
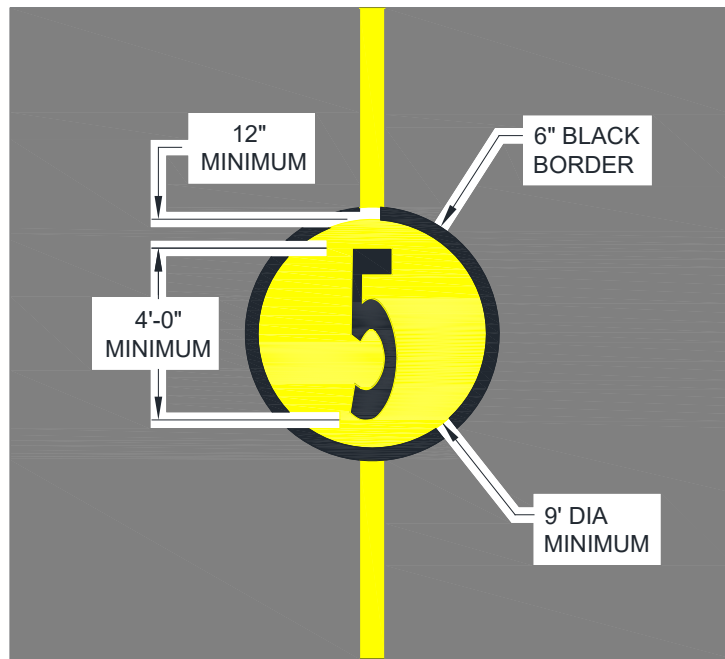
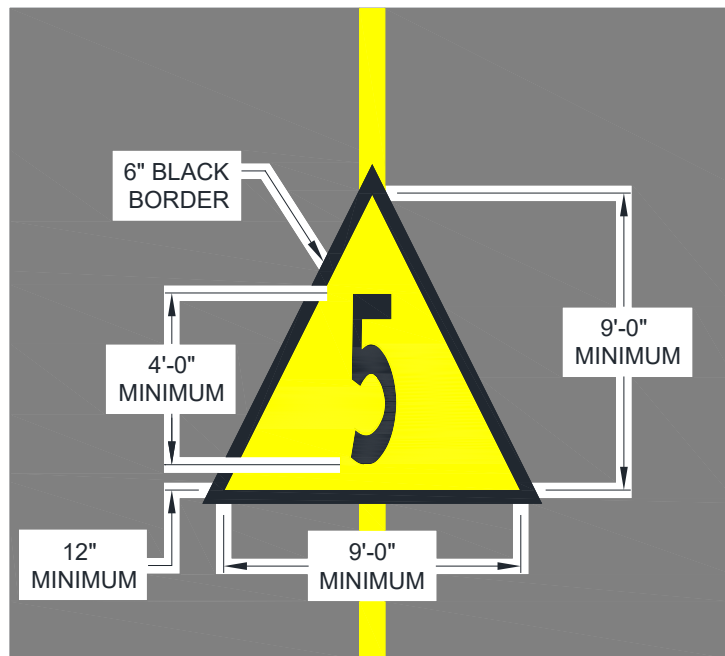

Figure 4-5. Circular and Triangular-Shaped Apron Control Marking Dimensions



(a) Circular Shaped Apron Control Marking Details



(b) Triangular Shaped Apron Control Marking Details

Page Intentionally Blank

CHAPTER 5. OTHER SURFACE MARKINGS.

5.1 **Application.**

The surface markings in this section are used, as appropriate, on airports.

5.2 **Vehicle Roadway Markings.**

5.2.1 Purpose.

The three distinct vehicle roadway markings contained in this chapter are used to delineate roadways located on or that cross paved areas used by aircraft (aircraft maneuvering areas) so that collisions and other mishaps are averted. Markings for roadways not located on aircraft maneuvering areas, such as airport service roads, should conform, whenever possible, to the U.S. Department of Transportation's Manual on Uniform Traffic Control Devices. Do not use surface painted markings intended for aircraft, such as holding position markings, enhanced taxiway centerline markings, or non-movement area boundary markings for roadways used exclusively by vehicles. Misuse of such markings may mislead pilots into identifying the roadway as a taxiway. For roadway signage provisions for either case, see [AC 150/5340-18](#).

5.2.2 Requirement.

These markings for roadways located on or that cross aircraft maneuvering areas are applied as necessary to control vehicular traffic on the airport.

5.2.3 Location.

Vehicle roadways are delineated on aircraft maneuvering areas where there is a need to define a pathway for vehicle operations. A minimum separation of 2 feet (0.6 m) must be maintained between the roadway edge marking described below and the non-movement area boundary marking (see paragraph 5.4). All vehicle roadway markings are interrupted when crossing any taxiway and runway markings.

5.2.4 Color.

Vehicle roadway markings are white.

5.2.5 Characteristics.

5.2.5.1 Vehicle roadway markings consist of (a) roadway edge lines to delineate each edge of the roadway, (b) a dashed line to separate lanes within the edges of the roadway, and, where appropriate, (c) a roadway stop line (bar). The roadway edge lines, which are either solid lines or zipper-style, and the dashed lines are all 6 inches (15 cm) wide, except that zipper-style edges are 12 inches (30 cm) wide and 4 feet (1.2 m) long. See [Figure A-15](#) for details of the zipper-style marking. The dashed line for lane separation is 15 feet (4.5 m) in length and spaced 25 feet (7.5 m) apart. The roadway stop line (bar) is 2 feet (0.6 m) wide and extends across its appropriate lane. See [Figure A-25](#) for illustrations and details.

- 5.2.5.2 In lieu of the solid lines for roadway edge lines, zipper-style markings may be used to delineate the edges of the vehicle roadway wherever the airport's LVO/SMGCS working group or the airport operator determines the roadway edges need enhanced delineation.
- 5.2.5.3 Every roadway lane that feeds vehicle traffic onto or across a taxi route must have a solid roadway stop line (bar). The placement of the stop line (bar) is in accordance with the criteria for taxiway centerline to fixed/movable object per AC 150/5300-13 for the largest airplane design group serving the airport. This placement generally ensures adequate vehicle clearance from taxiing aircraft. However, airport operators should evaluate if the effects of jet blasts by turning aircraft operations on vehicle traffic require a larger setback.

5.3 **Very High Frequency Omnidirectional Range (VOR) Receiver Checkpoint Marking.**

5.3.1 Purpose.

The VOR receiver checkpoint marking is used by pilots to check their aircraft instruments with navigational aid signals. It consists of a painted circle with a painted directional arrow that is aligned toward the azimuth of the VOR facility. The location of the marking indicates a point on the airport where sufficient signal strength from a VOR facility exists so a pilot can check the aircraft VOR equipment against the radial azimuth indicated by the painted directional arrow. For the accompanying signage provisions, see AC 150/5340-18.

5.3.2 Requirement.

This marking is required as directed by FAA Flight Program Operations.

5.3.3 Location.

FAA Flight Program Operations personnel determine the location for the VOR receiver checkpoint marking(s) and issue information for checkpoint descriptions in flight publications. In general, the VOR receiver checkpoint marking preferably is located on an airport apron but could be on a taxiway; but it is never on a runway. The location(s) should also allow easy access to align the aircraft with the marking without unduly obstructing other airport traffic. VOR receiver checkpoint markings should not be established at distances less than one-half mile (0.8 km) from the facility, nor on unpaved areas.

5.3.4 Color.

The VOR receiver checkpoint marking is a painted circle of the size and colors shown in Figure A-26.

5.3.5 Characteristics.

The VOR receiver checkpoint marking is a painted circle with an arrow that is accompanied with an associated information sign.

1. The VOR receiver checkpoint is a circle 10 feet (3.1 m) in diameter with a yellow arrow aligned toward the azimuth of the VOR facility.
2. The arrow should extend to the full width of the inner circle.
3. The black interior of the circle is surrounded by a 6-inch (15-cm) wide yellow ring contiguous to a 6-inch (15-cm) wide white outer ring per Figure A-26.
4. When installed on concrete or other light-colored pavements, the exterior of the circle is painted black.

5.4 **Non-Movement Area Boundary Marking.**

5.4.1 Purpose.

The non-movement area boundary marking is used to delineate the movement areas under direct control by the airport traffic control tower from the non-movement areas that are not under their control. Secondary purpose: The primary users of this marking are airport operators having an airport traffic control tower. However, some airport operators without an airport traffic control tower have effectively used this surface marking on terminals and other aprons to separate vehicle traffic, equipment traffic, etc. from the areas where aircraft taxi, such as, when aircraft enter/exit an aircraft parking area located off the terminal. No part of a parked aircraft may overhang this marking. If aircraft taxi parallel to this marking, paint a taxiway or taxilane centerline marking such that the taxiway/taxilane object free area criteria are met.

5.4.2 Requirement.

This marking is used when there is a need to delineate the movement areas under direct control by the airport traffic control tower from the non-movement areas that are not under their control, and only where aircraft may cross the marking. Airports without an airport traffic control tower may use the surface marking to help delineate aircraft traffic routes, aircraft parking limits, etc.

5.4.3 Location.

A non-movement area boundary marking is located on the boundary between the movement and non-movement area as shown in Figure A-15. Prior to its implementation, a letter of agreement should be formalized between the airport operator and airport traffic control tower that specifies the location(s) of the boundaries. To provide adequate clearance for the wings of taxiing aircraft, the marking should never coincide with the edge of a taxiway. In this regard, the non-movement area boundary marking is set back in accordance with the taxiway or taxilane centerline to fixed/movable object criteria (taxiway/taxilane object free area) of AC 150/5300-13. However, the airport operator should evaluate if the effects of jet blasts by turning aircraft operations on equipment, personnel, or vehicle traffic require a larger setback. Taxilane instead of taxiway clearance criteria are usually used because this marking is

Painted in nearly all cases on terminal aprons, cargo areas, and aircraft parking areas where aircraft taxi at lower speeds.

Safety Notice No. 10

Mitigation of Wrong Runway Takeoffs

Precaution should be taken not to paint a non-movement area boundary marking on the outer edges of an apron that is transitioning into a taxiway that leads directly to a runway. Under certain runway/taxiway geometries, such as shown in [Figure 5-1](#), placement of this surface marking where dual parallel taxiways support a runway have resulted in pilots taking off on a parallel taxiway. The concern of such usage is that pilots who expect a nearby runway holding position marking after leaving an apron will confuse these two markings because of their visual similarities, i.e., single dash/single line versus dual dashes/dual lines. It is recommended that the non-movement boundary marking not be located on or just prior to a taxiway that leads directly to a runway.

Figure 5-1. Precautionary Placement of the Non-Movement Boundary Marking

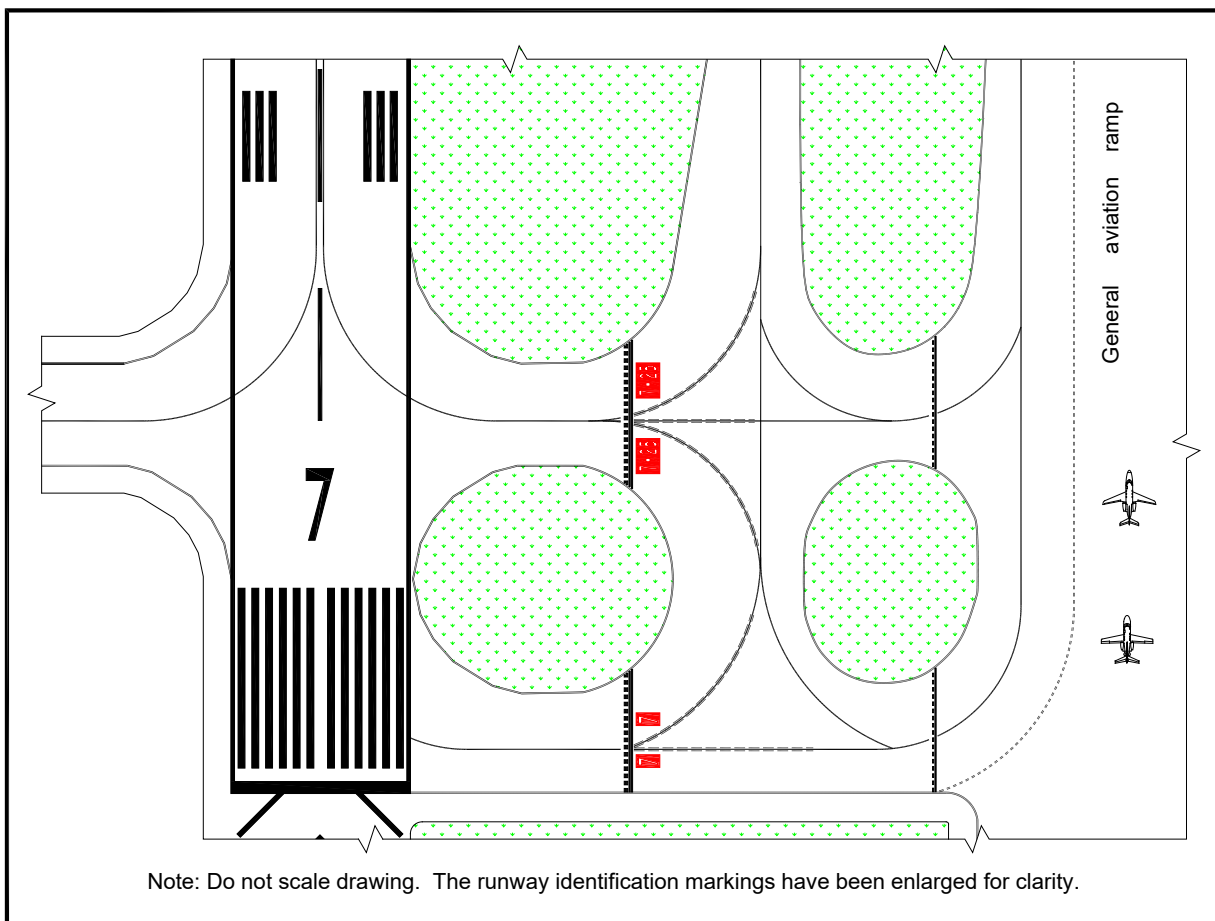

Note: The location of movement area markings at these locations may cause pilots errors. For example, to mistake this marking for a runway holding position marking (Pattern A), resulting in a takeoff from the parallel taxiway.

5.4.4 Color.

The non-movement area boundary marking is yellow and will be outlined in black on light-colored pavements. See paragraph 1.4 and Table 1-1 for required techniques to enhance this marking.

5.4.5 Characteristics.

5.4.5.1 The non-movement area boundary marking consists of two yellow lines, one solid and one dashed as shown in Figure A-15. The solid line is located on the side of the non-movement area while the dashed line is located on the side of the movement area.

5.4.5.2 Each line is 6 inches (15 cm) in width with 6-inch (15-cm) spacing between lines. In the event of circumstances where pilots may have difficulty discerning the edge of a movement area, the width of the lines and spaces may be doubled to 12 inches (30 cm). In both applications, the dashes are 3 feet (0.9 m) in length with 3-foot (0.9-m) spacing between dashes.

5.4.5.3 If a taxiway centerline intersects a non-movement area boundary marking, then the taxiway centerline is interrupted so that it is 6 to 12 inches (15 to 30 cm) from both sides of the non-movement area boundary marking.

5.4.5.4 If the non-movement area boundary marking that includes a black border intersects a taxiway edge marking, then the taxiway edge marking is interrupted such that the taxiway edge marking abuts the black border of the non-movement area boundary marking.

5.4.5.5 If the non-movement area boundary marking that does not include a black border intersects a taxiway edge marking, then the taxiway edge marking is interrupted such that a 6-inch gap is left between the taxiway edge marking and the non-movement area boundary marking.

5.5 **Markings for Thresholds Temporarily Relocated During Construction.**

See AC 150/5370-2, *Operational Safety on Airports During Construction*, for provisions for marking and lighting a threshold temporarily relocated during construction.

5.6 **Marking and Lighting of Permanently Closed Runways and Taxiways.**

Permanently closed paved areas are indicated by the use of an “X”. Figure A-27 provides detailed criteria for the “X” marking.

- 5.6.1 For runways and taxiways that are permanently closed, the lighting circuits are disconnected. For closed runways, all markings for runway thresholds, runway designations, touchdown aiming points, and touchdown zones are obliterated. Removal of other existing runway markings, such as the centerline, edge markings, shoulder markings, stopway markings, and blast pad markings is recommended but not required. For closed runways that intersect an open runway, the runway centerline that abuts the open runway is obliterated from the entire width of the runway safety area of the open runway.
- 5.6.2 For closed runways, only solid yellow “X” markings are painted (never striated “X” markings) at each end of the runway and at 1,000-foot (305-m) intervals.
- 5.6.3 For a closed runway that intersects an active runway, a solid yellow “X” marking should be placed on the closed runway near the sides of the open intersecting runway. In most cases, two “X” markings are required, i.e., one “X” per each side of the open intersecting runway.
- 5.6.4 For closed taxiways, a yellow “X” marking is placed at each entrance of the closed taxiway.
- 5.6.5 In terms of pattern selection from Figure A-27, the larger alternate pattern is preferable over the smaller pattern for closed runways because this pattern is seen more readily from aircraft on final approach. For closed taxiways, the smaller pattern is preferable over the larger alternative pattern unless taxiing pilots have difficulty seeing the marking and are entering the closed taxiway or have reported near landings on the closed taxiway.

5.7 Temporarily Closed Runways and Taxiways.

The following procedures are to be followed when it is necessary to temporarily close a runway or a taxiway. See AC 150/5370-2 for requirements and guidelines.

- 5.7.1 For temporarily closed runways, the airport operator has two options when it is necessary to provide a visual indication that a runway is temporarily closed.
 - 5.7.1.1 **Option 1 (preferred).**

The airport operator uses a raised-lighted “X” on each runway end to indicate the runway is temporarily closed. See AC 150/5370-2 for guidance on the use of this visual aid.
 - 5.7.1.2 **Option 2.**

The airport operator places an “X” only at each end of the runway over the runway designation markings or, when required by construction activity, just off the runway end. The “X” is yellow in color and conforms to the dimensions specified in Figure A-27. Since the “X” is used temporarily, they are usually made of some easily removable material, such as plywood or fabric, rather than painted on the pavement surface. Any materials used

for a temporary “X” should provide a solid appearance, for example, not by being prevented from flapping in the wind, say by using a ground anchor device. Anchoring devices should be designed to minimize damage to pavement, and any damage should be repaired before the runway is opened to aircraft traffic. Since the “X” will usually be placed over white runway markings, their visibility can be enhanced by a 6-inch (15-cm) black border.

- 5.7.2 For temporarily closed taxiways, the airport operator has two options when it is necessary to provide a visual indication that a taxiway is temporarily closed.
- 5.7.2.1 **Option 1.**
Usually this type of closure is treated as a hazardous area so the guidance in paragraph 5.13 applies.
- 5.7.2.2 **Option 2.**
As an alternative, the airport operator may install the same yellow “X” shown in Figure A-27 for those entrances leading into the temporarily closed taxiway.
- 5.7.3 If the runway or taxiway will be closed during the nighttime, the runway and taxiway lights will normally be disconnected so they cannot be illuminated unless such illumination is needed to perform maintenance operations on or adjacent to the runway, e.g., snow removal.

General Comment
<p>Note: The airport operator is responsible for determining (1) the need for a visual indication that a runway or taxiway is temporarily closed and (2) the safest place to put the “X” or “X”s or other indicators per paragraph <u>5.13</u>. In making these determinations, the airport operator should consider such things as the reason for the closure, duration of the closure, airfield configuration, and the existence and hours of operation of the airport traffic control tower and construction crews.</p>

5.8 **Converting a Runway to a Taxiway.**

The following actions are necessary to convert a runway permanently to a taxiway.

- 5.8.1 All runway markings found on the runway are obliterated or replaced with the appropriate taxiway markings. For example, the runway landing designation numbers are obliterated, and the white runway centerline is converted to a yellow taxiway centerline.
- 5.8.2 All runway related signage and lighting fixtures found on or along the runway must be removed and/or replaced with the appropriate taxiway signage and lighting to indicate the existence of the converted taxiway. For example, runway edge lights are converted

to blue edge lights, and runway centerline lighting fixtures are converted to green. (It may be possible to do both actions by changing the lens color.) See AC 150/5345-46, *Specification for Runway and Taxiway Light Fixtures*, for information about taxiway edge lights; AC 150/5345-39, *Specification for L-853 Runway and Taxiway Retroreflective Markers*, for information about runway and taxiway retroreflective markers; and AC 150/5340-30 for information about taxiway centerline lighting requirements.

- 5.8.3 All markings associated with the converted runway but not painted on the runway, such as the runway holding position markings found on entrance taxiways, are obliterated and replaced with the appropriate taxiway markings. Additionally, runway related signage and lighting fixtures found off the runway must be removed and/or replaced with the appropriate taxiway signage and lighting to indicate the existence of the converted taxiway.
- 5.8.4 In terms of documentation, airport operators must update their Airport Layout Plan as well as other appropriate documents to indicate the presence of the new taxiway and the permanent closure of the runway. Both the Chart Supplement and the Airport Master Record (FAA Form 5010) need to indicate the conversion to a permanent taxiway.

General Comment
Note: The “X” closure marking is never used on this type of conversion since the converted pavement is intended to be an active, new taxiway.

5.9 Intermittent Use of a Taxiway as a Runway.

The intermittent use of a taxiway as a runway is a type of conversion where the converted taxiway is either used only as a runway or used as a runway for a specified time of the day or night. In both of these applications, the airport operator must properly re-mark affected pavements (including provisions for signage and lighting). One required restriction for any conversions is that the converted pavement cannot be marked simultaneously with a yellow taxiway centerline and a white runway designation number. Other re-marking actions are listed below. The FAA recommends a Safety Management System risk assessment to determine if other necessary actions need to be implemented.

General Comment
Note: For airports subject to National Environmental Policy Act (NEPA) requirements, any proposal to use a taxiway as a runway should include a review of the potential environmental consequences of such an action. The airport operator should contact the FAA Airports Regional Office or Airports District Office for NEPA guidance.

- 5.9.1 Pavement used as a runway during the day should at a minimum be painted with the visual runway markings identified in Table 2-1, that is, the white landing designation number(s) and a white centerline. Furthermore, converted pavement used as a runway at night that is to be lighted should have runway lighting installed per AC 150/5340-30.
- 5.9.2 If the pavement is to be used ONLY as a taxiway at night, blue edge lights should be installed per AC 150/5340-30.
- 5.9.3 In terms of documentation, airport operators must update their Airport Layout Plan as well as other appropriate documents to indicate the presence of the new runway. If the runway is to be used ONLY as a taxiway at night and has blue edge lighting, this runway must be listed as unlighted along with an appropriate annotation in both the Chart Supplement and the Airport Master Record (FAA Form 5010) indicating the runway is closed to nighttime operations and that the blue lights are provided for taxiing aircraft.
- 5.9.4 Since the pavement is now considered a runway, any taxiways intersecting the designated runway must have appropriate runway holding position markings (including provisions for signage and lighting) painted per this AC including criteria from AC 150/5340-18, and AC 150/5340-30.
- 5.10 **Closed or Abandoned Airports.**
When all runways are closed temporarily, the airport beacon is turned off and the runways are marked per paragraph 5.7. When an airport is abandoned and all runways are closed permanently, the runways are marked per paragraph 5.6, the airport beacon is disconnected, and an “X” is placed in the segmented circle or at a central location if no segmented circle exists. For additional details, see AC 150/5370-2.
- 5.11 **Heliport Markings.**
Information on markings for heliports is in AC 150/5390-2, *Heliport Design*.
- 5.12 **Marking for Arresting Gear.**
Information on marking for arresting gear is in AC 150/5220-9, *Aircraft Arresting Systems on Civil Airports*.
- 5.13 **Hazardous Construction Areas.**
Marking of hazardous areas due to construction, in which no part of an aircraft may enter, are marked in accordance with AC 150/5370-2.
- 5.14 **Aircraft Deicing Facility Markings.**
Information on markings for aircraft deicing facilities is in AC 150/5300-14, *Design of Aircraft Deicing Facilities*.

5.15 **Interim Surface Markings for Taxiways Mistaken as Runways.**

This AC recognizes the use of the non-standard surface marking “TAXI” as an interim measure only for those taxiways that have repeated landing incidents.

Note: For new construction, the outer edge of an entrance taxiway must be curved. See [AC 150/5300-13](#). [Figure 5-2](#) and [Figure 5-4](#) provide location and characteristics for this application. In practice “TAXI” extends across the entire pavement including any paved shoulder as shown in the figures. The color is yellow with a 12 inch (30.5 cm) wide black border along the sides of each letter and a 4-foot (1.2-m) black border on the tops and bottoms of the letters. [Figure 5-4](#) illustrates the combined application with aviation grade artificial turf. See FAA Engineering Brief No. 72A, *Positive Identification of Runways for Landing*, which provides guidance for identifying situations where a taxiway could be mistaken for a runway and provides other mitigation strategies for dealing with this problem.

Figure 5-2. TAXI Marking Location Facing Runway Approach End

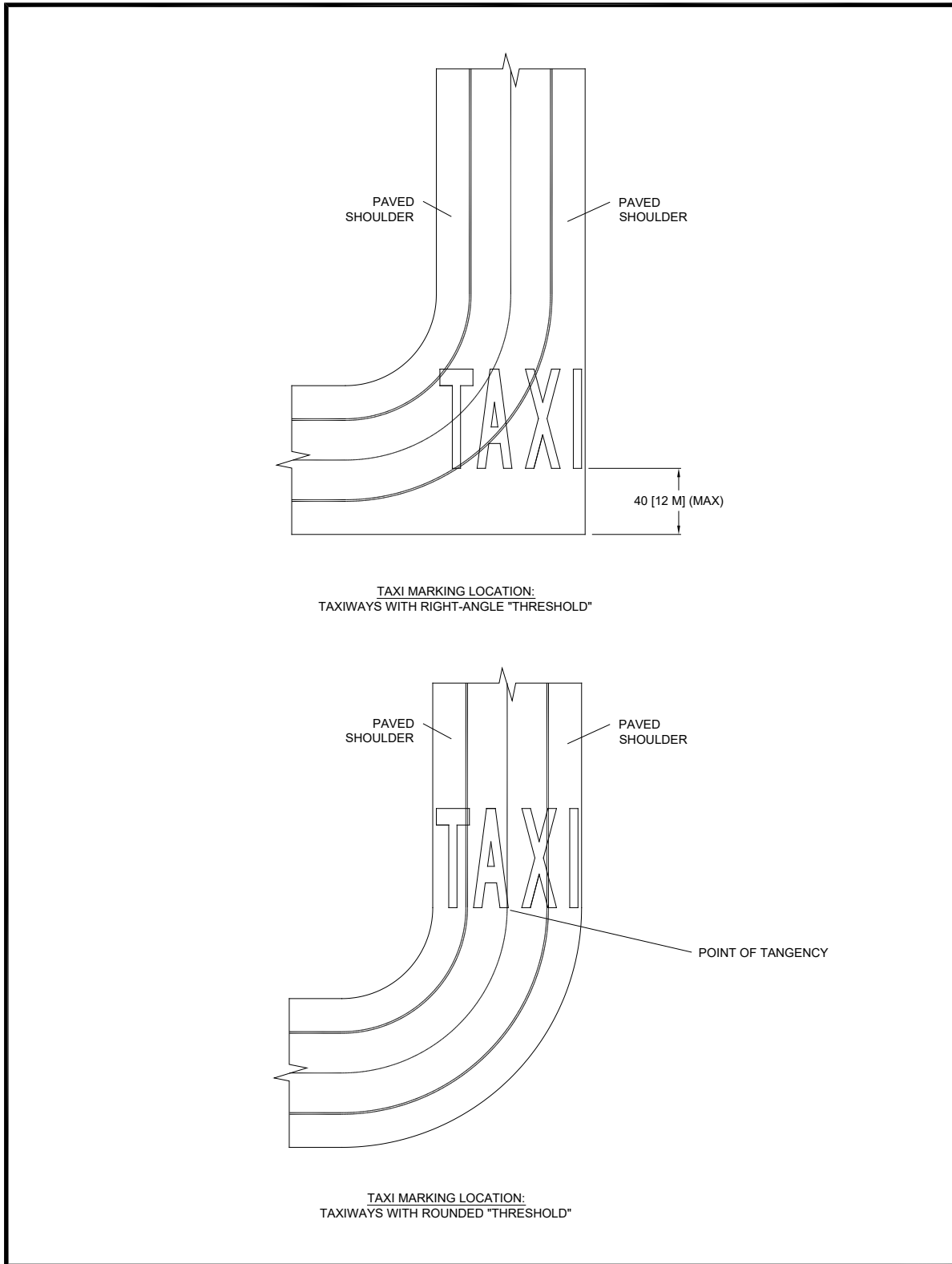

Note: For new construction, the outer edge of an entrance taxiway must be curved. See [AC 150/5300-13](#).

Figure 5-3. TAXI Marking Dimensions

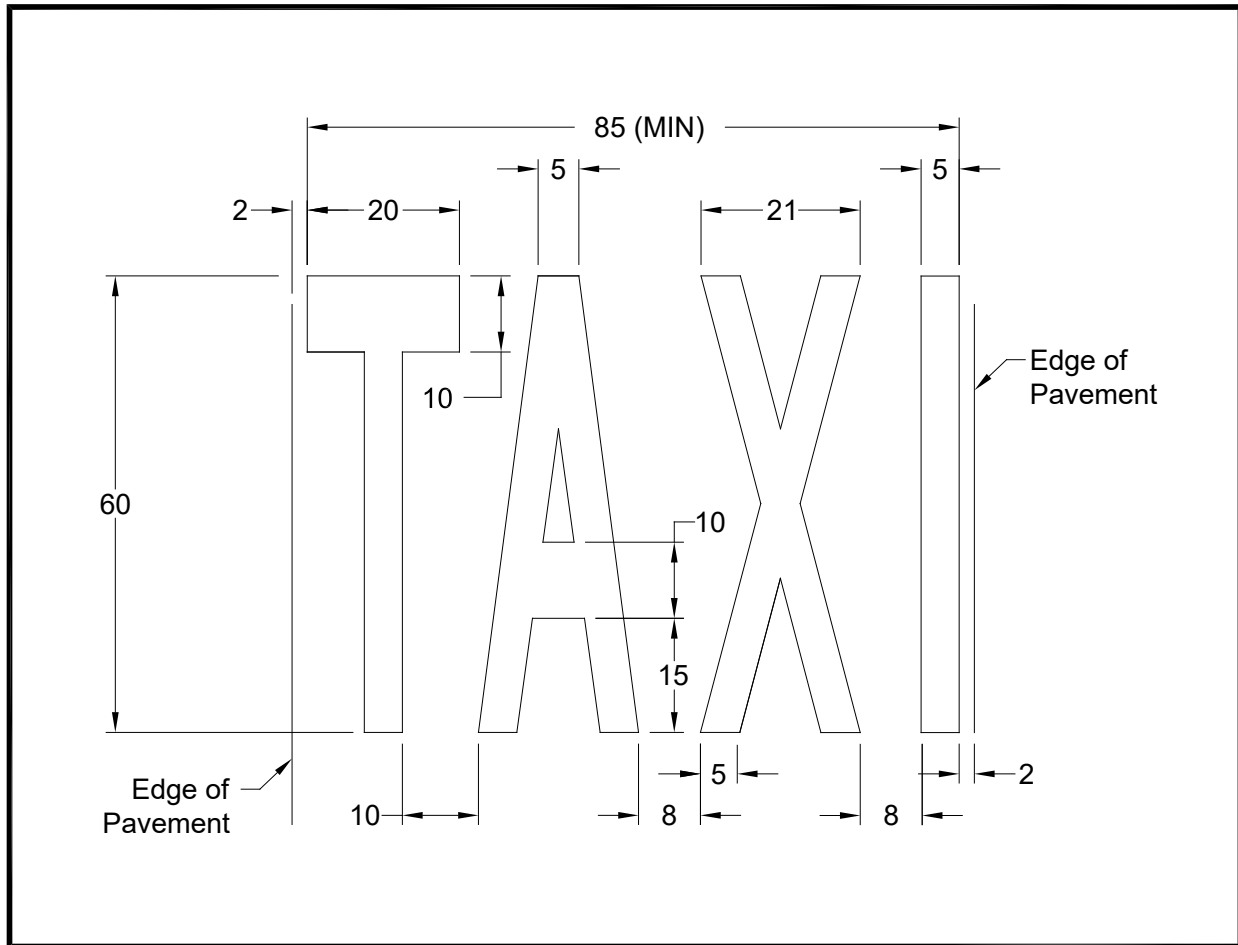

Note: These are minimum dimensions (in feet). If the existing taxiway plus paved shoulder is not wide enough to accommodate these markings, then provide a paved pad or wider shoulder in the area where the marking is to be installed.

Figure 5-4. Aviation Grade Artificial Turf Installation

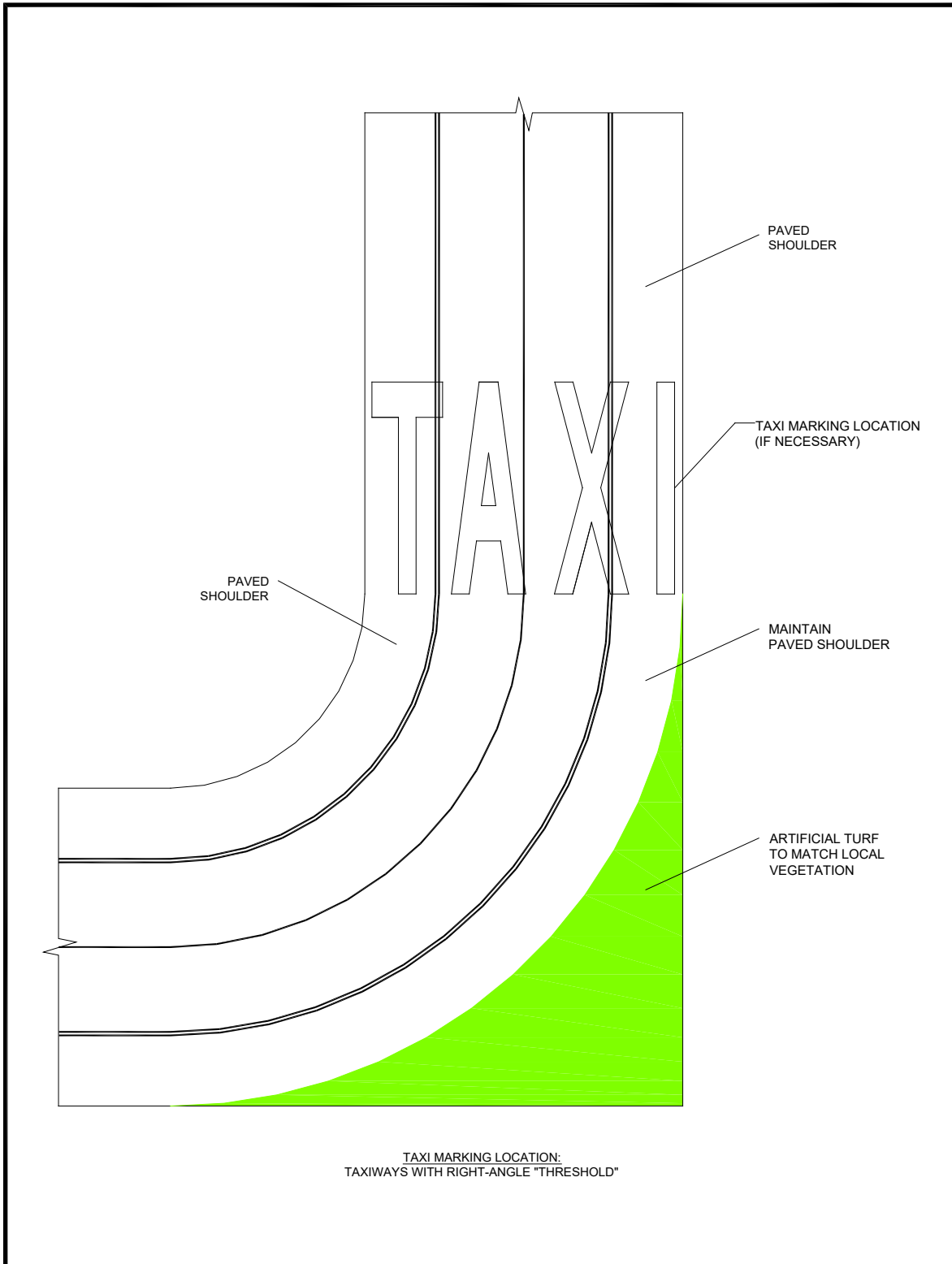

Note: For new construction, the outer edge of an entrance taxiway must be curved. See [AC 150/5300-13](#).

Page Intentionally Blank

APPENDIX A. PAVEMENT MARKINGS

Figure A-1. Precision Runway Markings

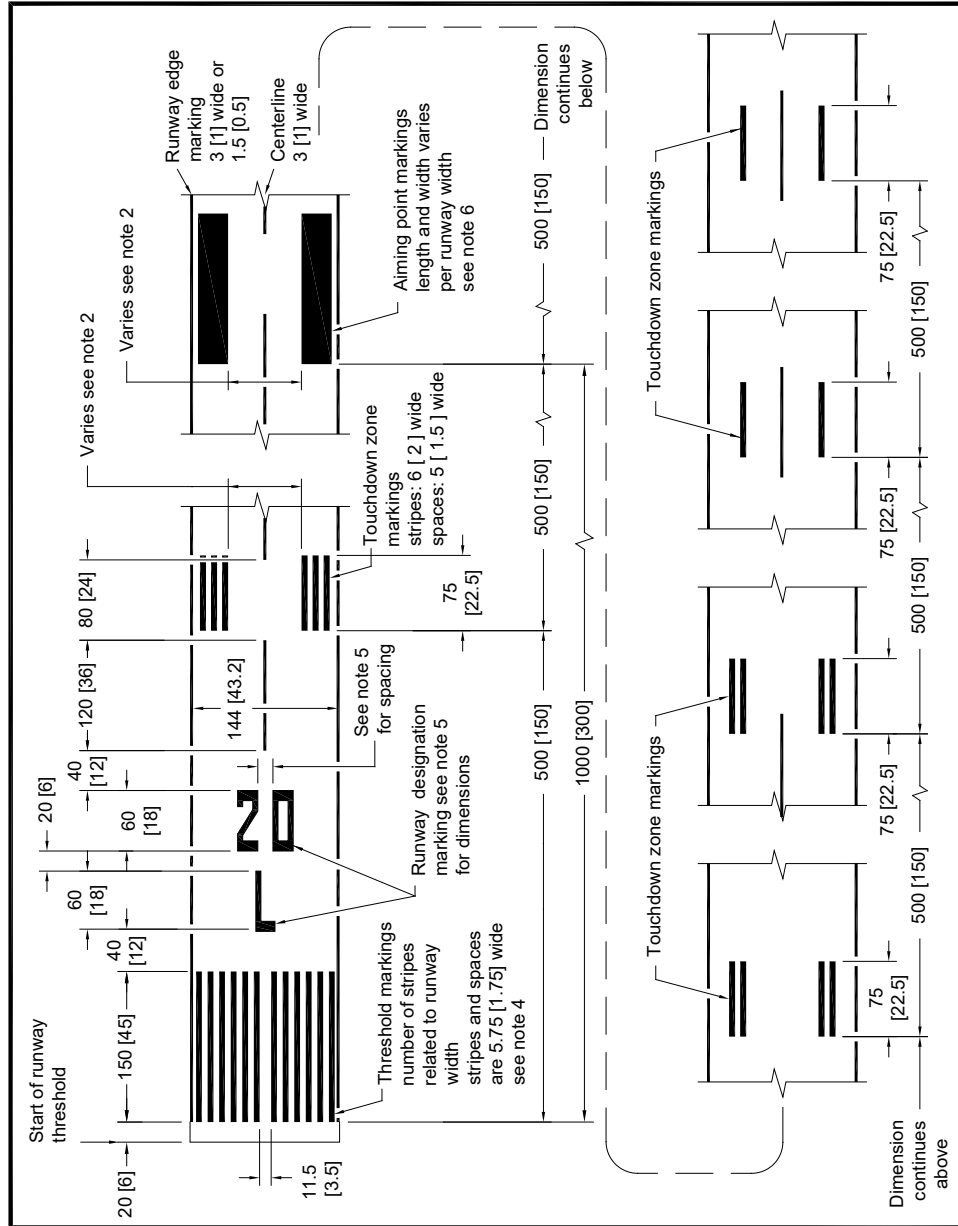

Notes:

1. Dimensions are expressed in feet (meters).
2. Dimension varies with runway width. See paragraph 2.6.
3. The touchdown zone marking scheme maintains a 900 ft (275m) "no marking zone" from the midpoint of the runway. That is, those pairs of surface markings that extend within 900 ft (275m) of the runway midpoint are eliminated.
4. See paragraph 2.5.
5. See Figure A-6.
6. See paragraph 2.6.
7. Centering of Runway Designators is per paragraph 2.3.6.

Figure A-2. Non-Precision Runway

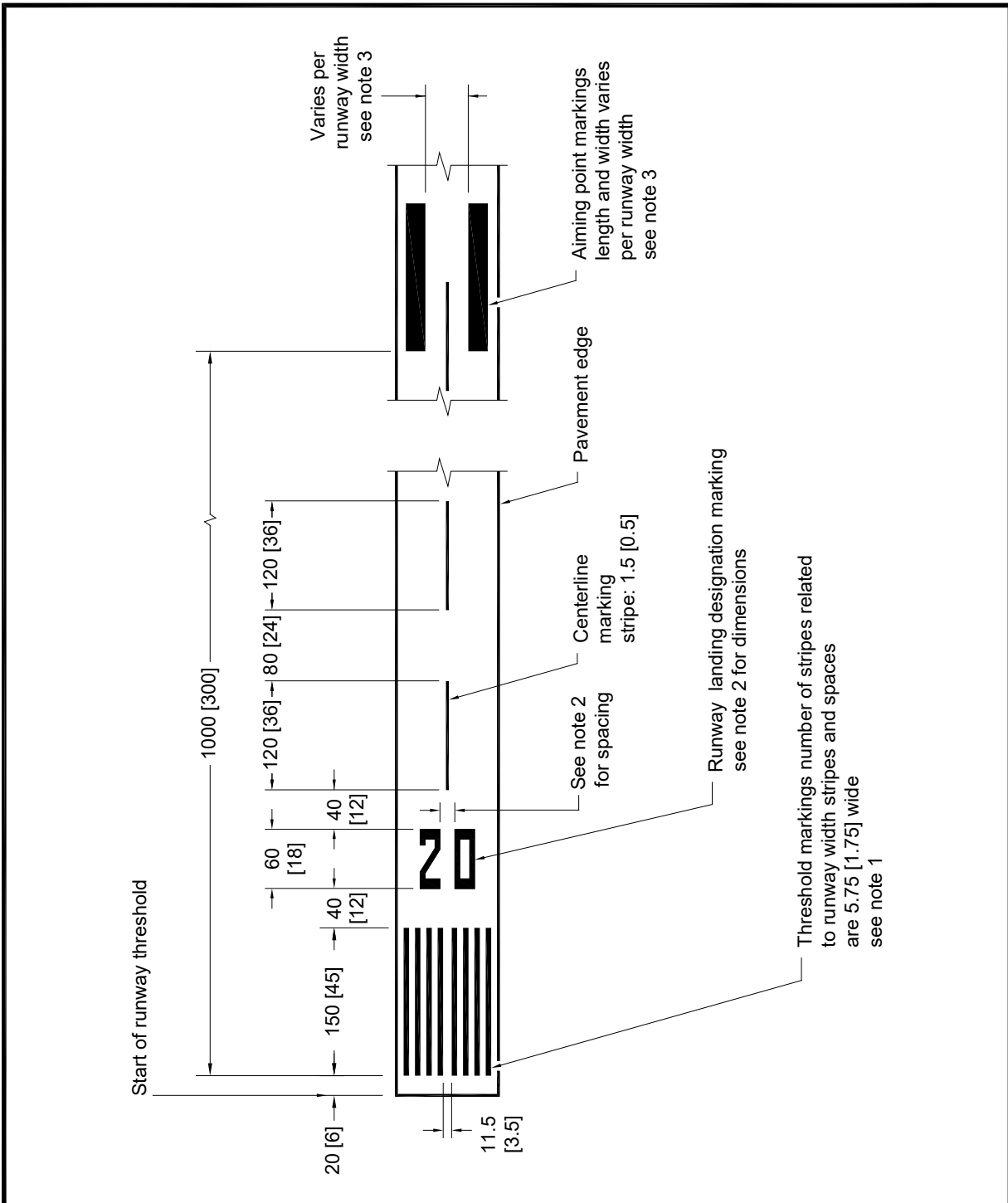

Notes: Dimensions are expressed in feet (meters).

1. See paragraph 2.5 and Table 2-2.
2. See Figure A-6.
3. See paragraph 2.6. See Table 2-1 for when required.
4. Centering of Runway Designators is per paragraph 2.3.6.

Figure A-3. Visual Runway Markings

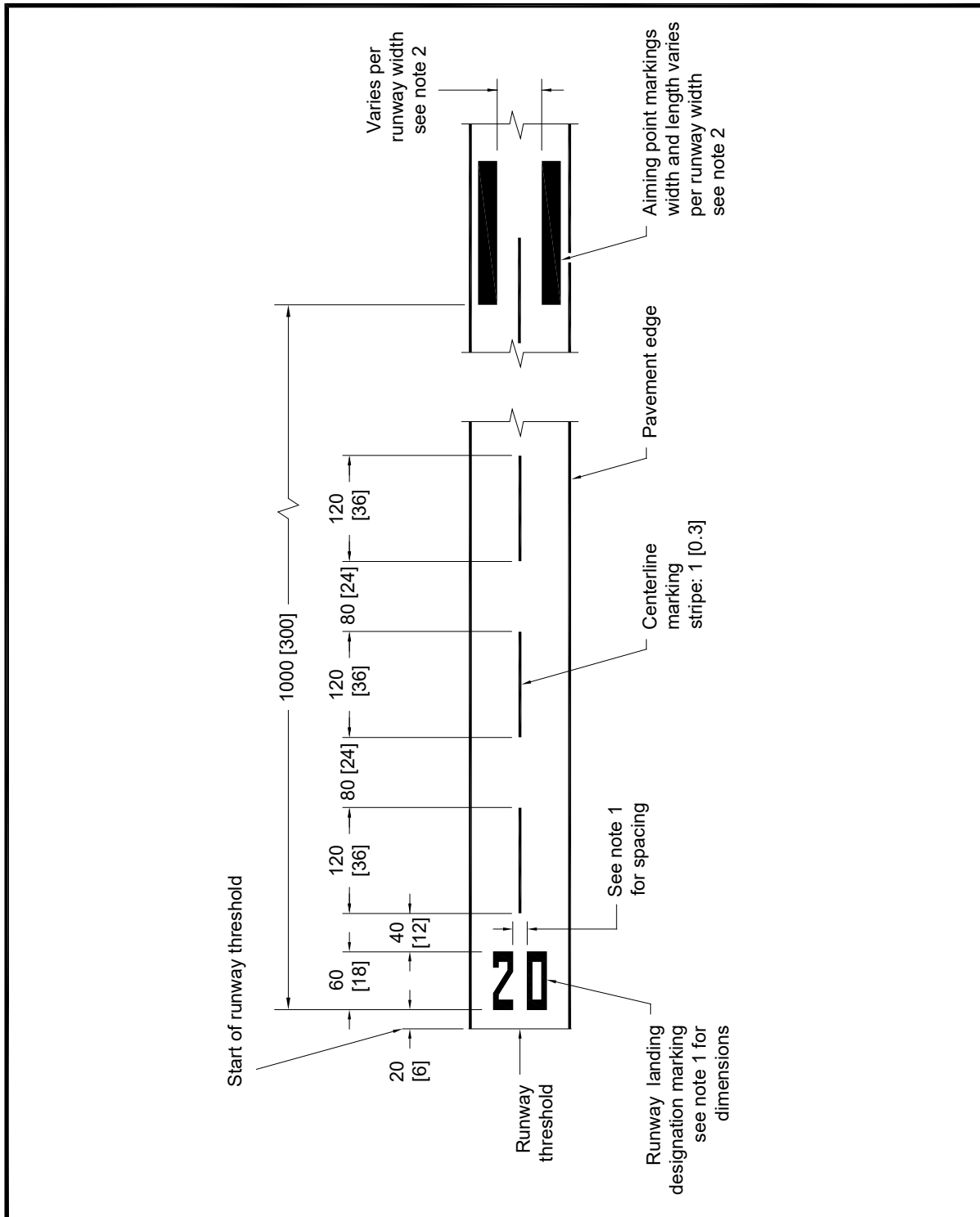

Notes: Dimensions are expressed in feet (meters).

1. See [Figure A-6](#).
2. See paragraph [2.6](#).
3. Centering of Runway Designators is per paragraph [2.3.6](#).

Figure A-4. Example of Conflicting Markings on Crossing Runways

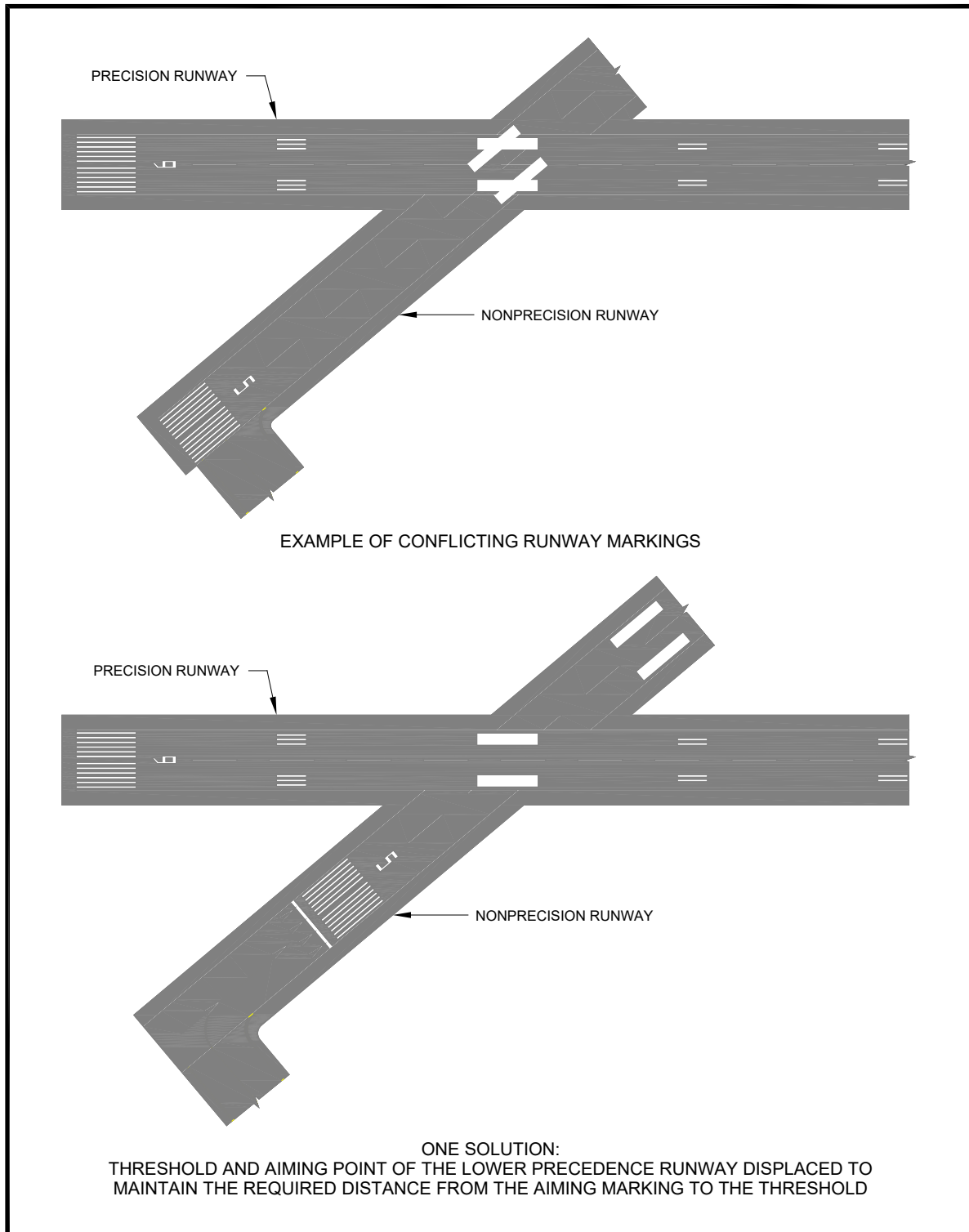

Note: In lieu of displaced threshold, the airport operator may place a remark on FAA Form 5010 which provides the distance that exists between the threshold and the aiming point marking.

Figure A-5. Details of Markings for Intersecting Runways

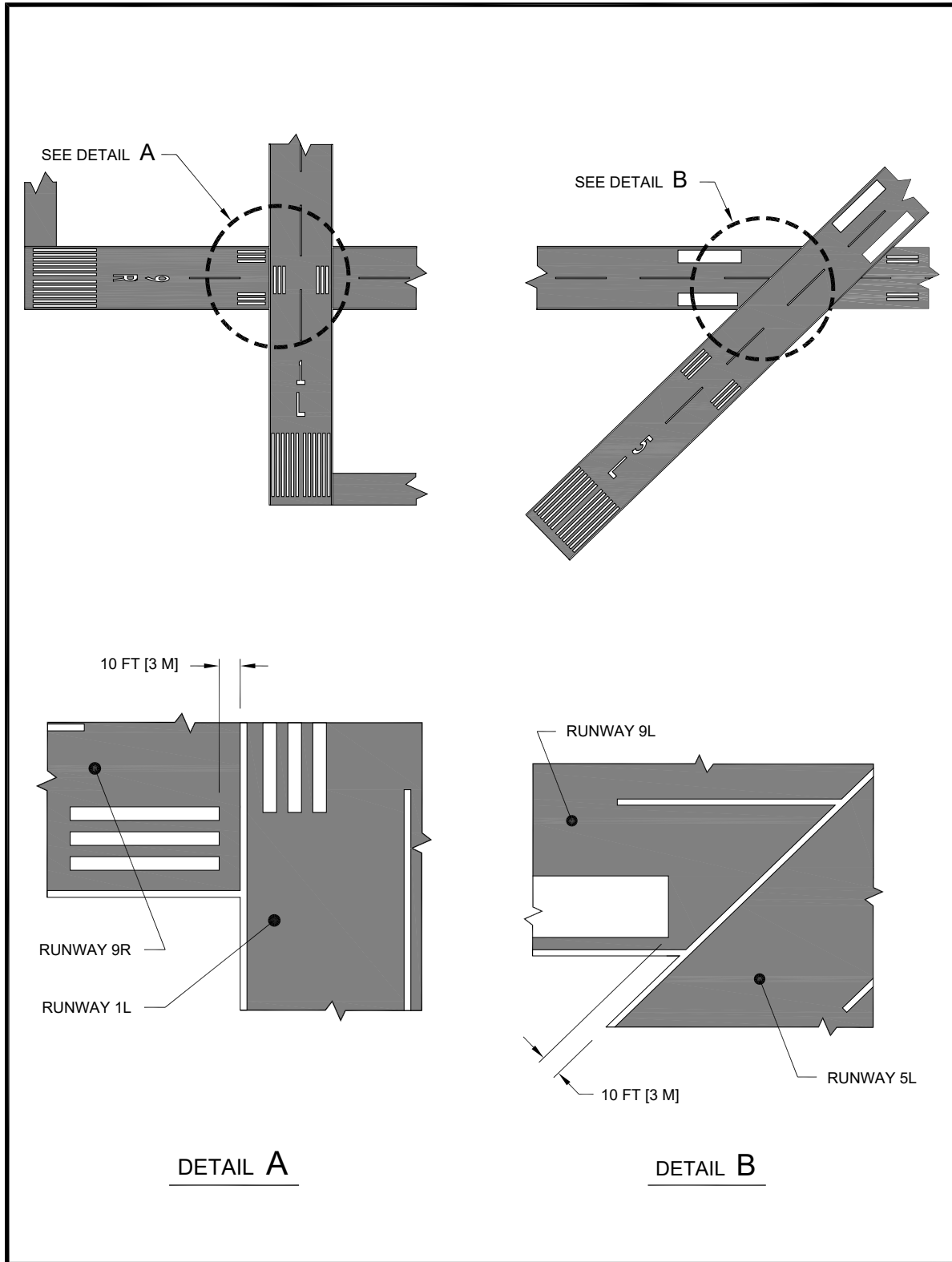
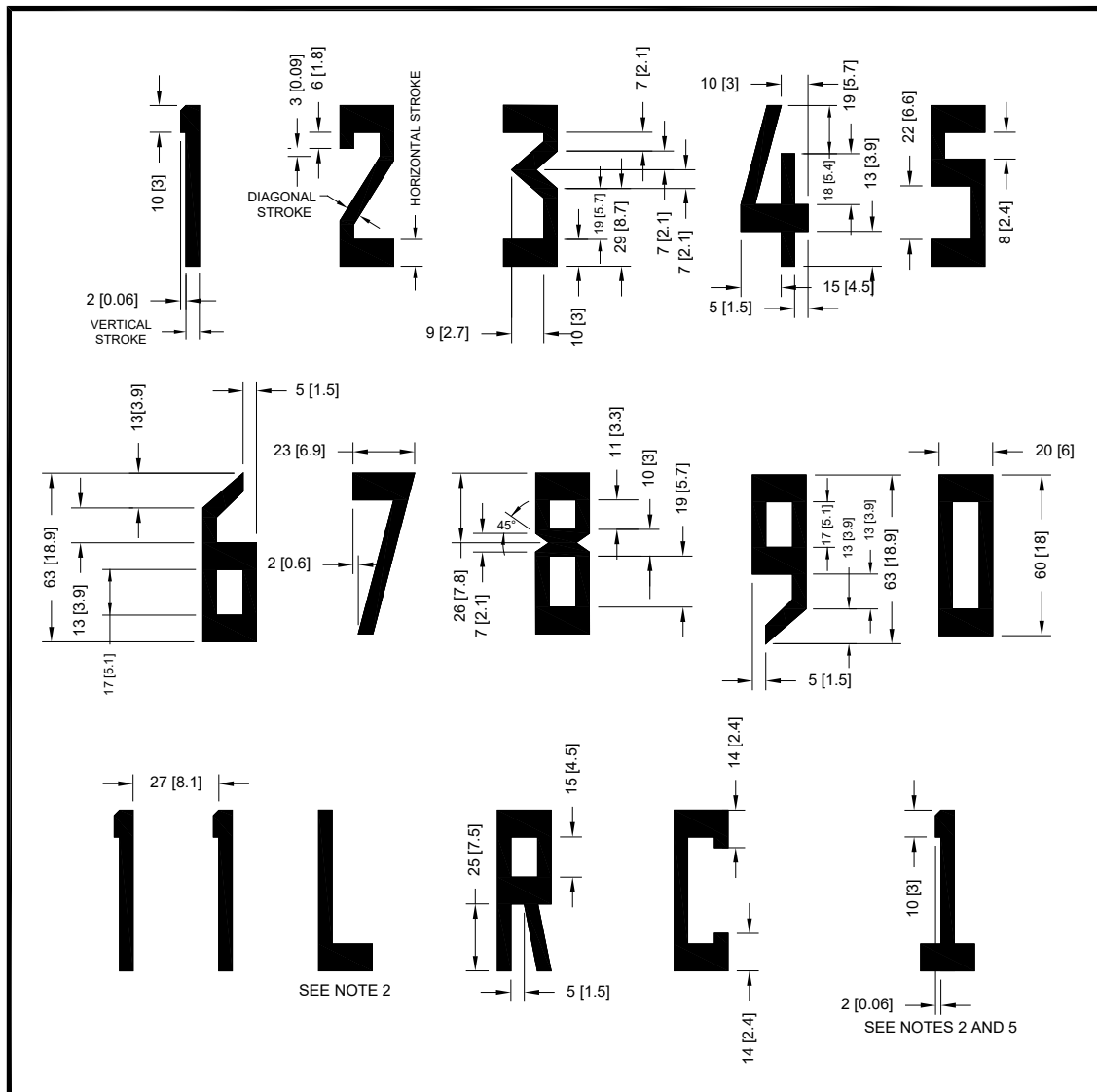
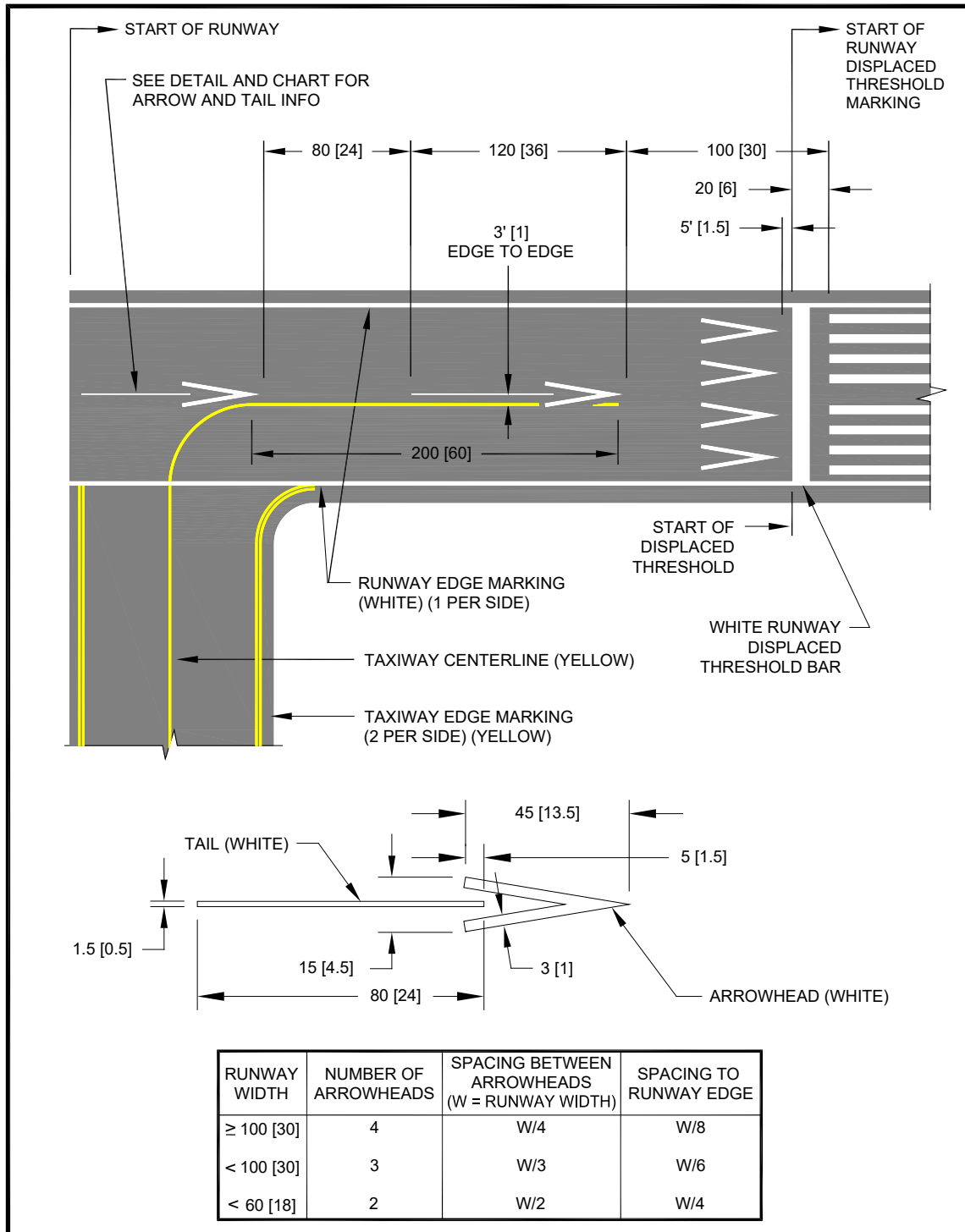

Figure A-6. Runway Designation Numerals and Letters

**Notes:**

1. Dimensions are expressed in feet (meters).
2. All characters have these characteristics (unless otherwise specified):
 - 60 [18] high
 - 20 [6] wide
 - vertical stroke of 5 [1.5]
 - horizontal stroke of 10 [30]
 - diagonal stroke of 5 [1.5]
3. All numerals except the number eleven as shown are horizontally spaced 15 [4.5] apart.
4. Single digits must not be preceded by a zero.
5. The numeral "1", when used alone, contains a horizontal stroke, as shown, to differentiate it from the runway centerline marking.
6. Single designations are centered on the runway pavement centerline. For double designations, the center of the outer edges of the two numerals is centered on the runway pavement centerline.
7. Where the runway designation consists of a number and a letter, the number and letter are located on the runway centerline in a stacked arrangement as shown in [Figure A-1](#).

Figure A-7. Displaced Threshold Markings



Notes:

1. Dimensions are expressed in feet (meters).
2. Runway edge markings, when used on the runway, extend into the displaced area.
3. Runway markings (except holding position markings) including those in the displaced threshold are white.

Figure A-8. Marking for Aligned Taxiway with Runway without a Displaced Threshold

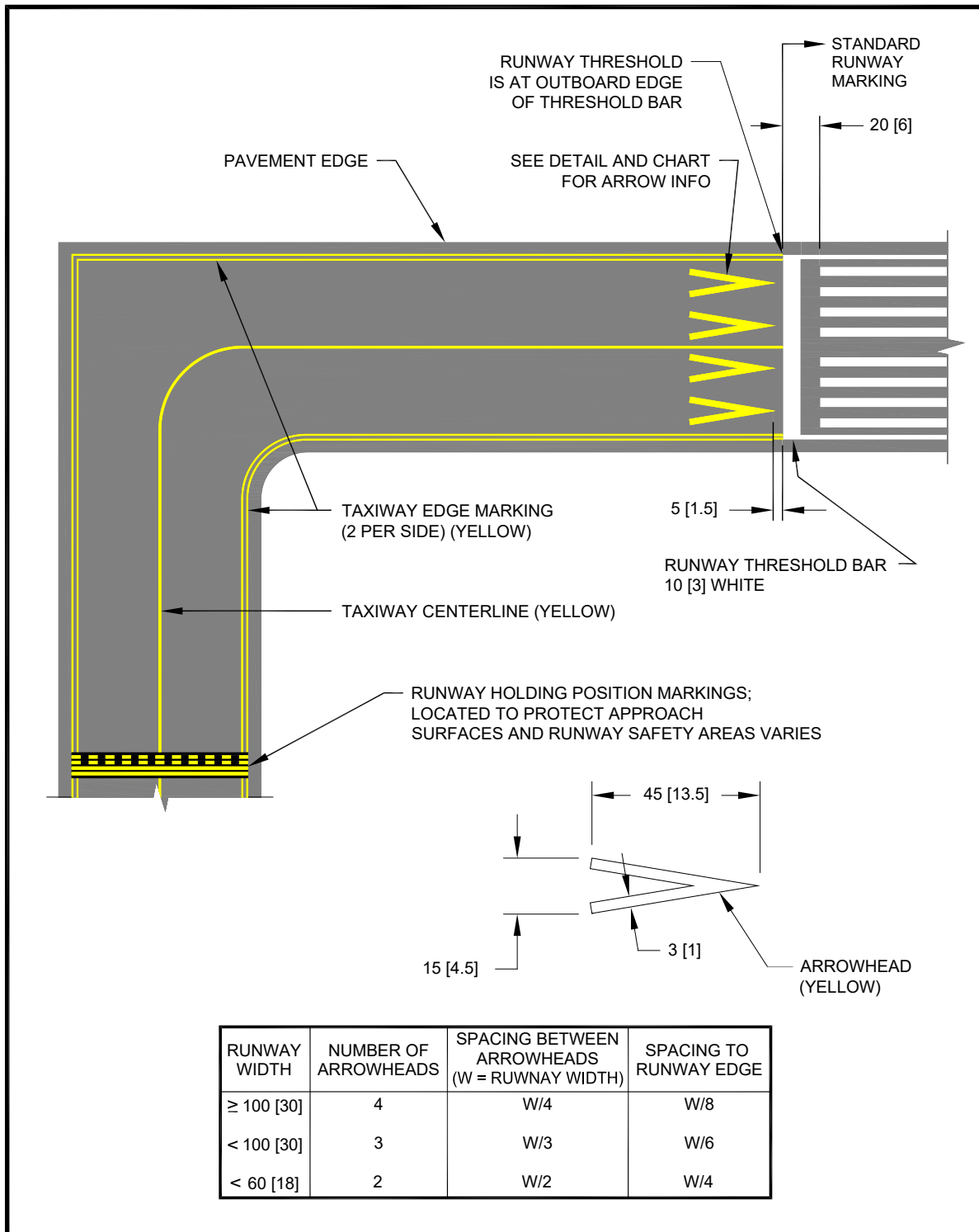

Notes: Dimensions are expressed in feet (meters).
 Aligned taxiway construction is prohibited per AC 150/5300-13. Existing locations should be rectified.

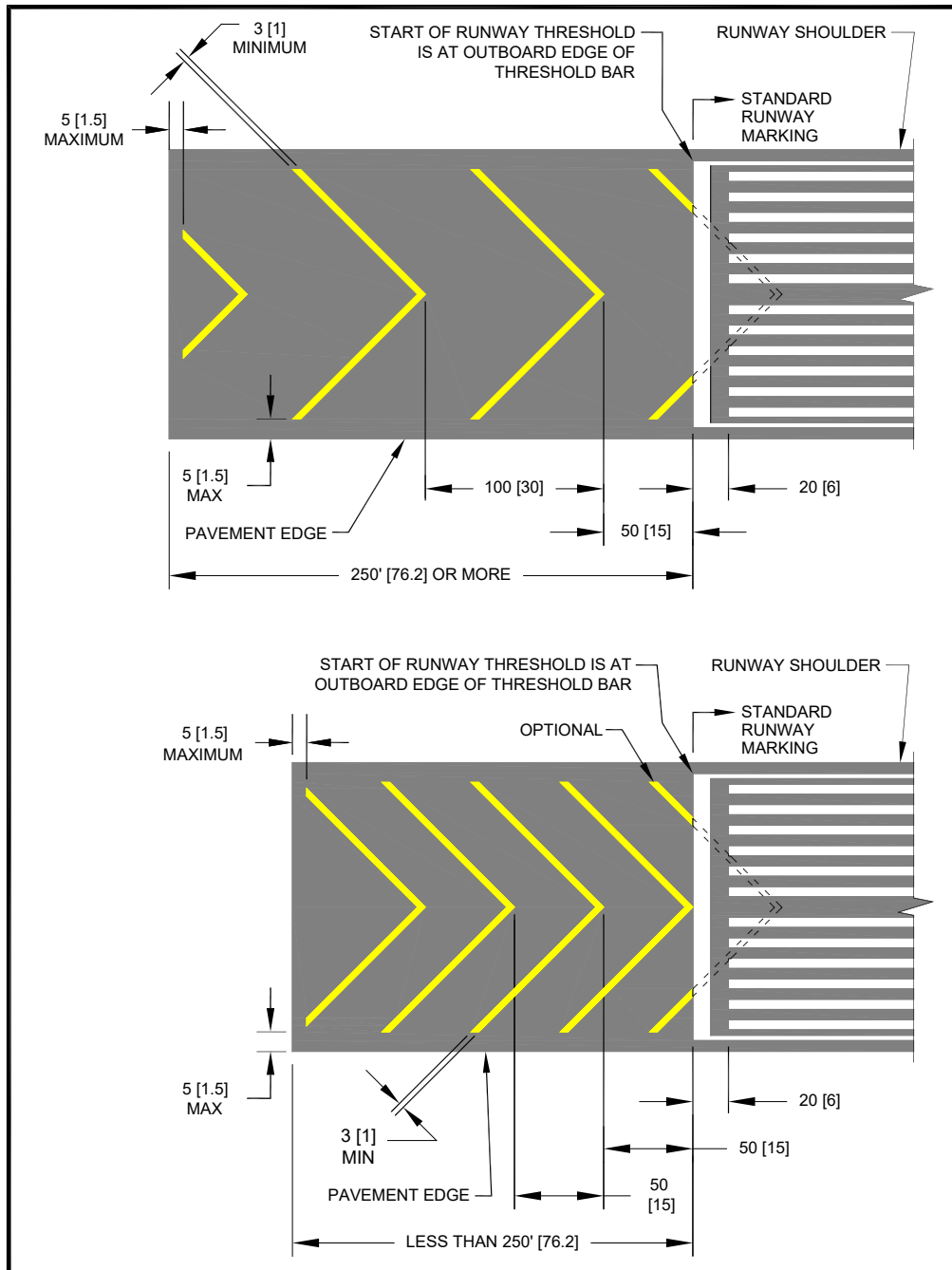
Figure A-9. Markings for Blast Pads and Stopways**Notes:**

1. Dimensions are expressed in feet (meters).
2. The widths of the stopways and blast pads are not the same. Stopways equal runway width. Blast pads equal runway width plus runway shoulders. See [AC 150/5300-13](#).
3. 50 ft (15m) spacing must be used when length of area is less than 250 ft (76 m) in which case the first full chevron starts at the index point (intersection of runway centerline and runway threshold).
4. Chevrons are painted yellow and at an angle of 45° to the runway centerline.
5. Chevron spacing may be doubled if length of area exceeds 1000 ft (305m).
6. For stopways of less than 250 ft (76 m) in length, full chevrons are required with the option to paint partial chevrons.

Figure A-10. Markings for Aligned Taxiway Preceding a Displaced Threshold

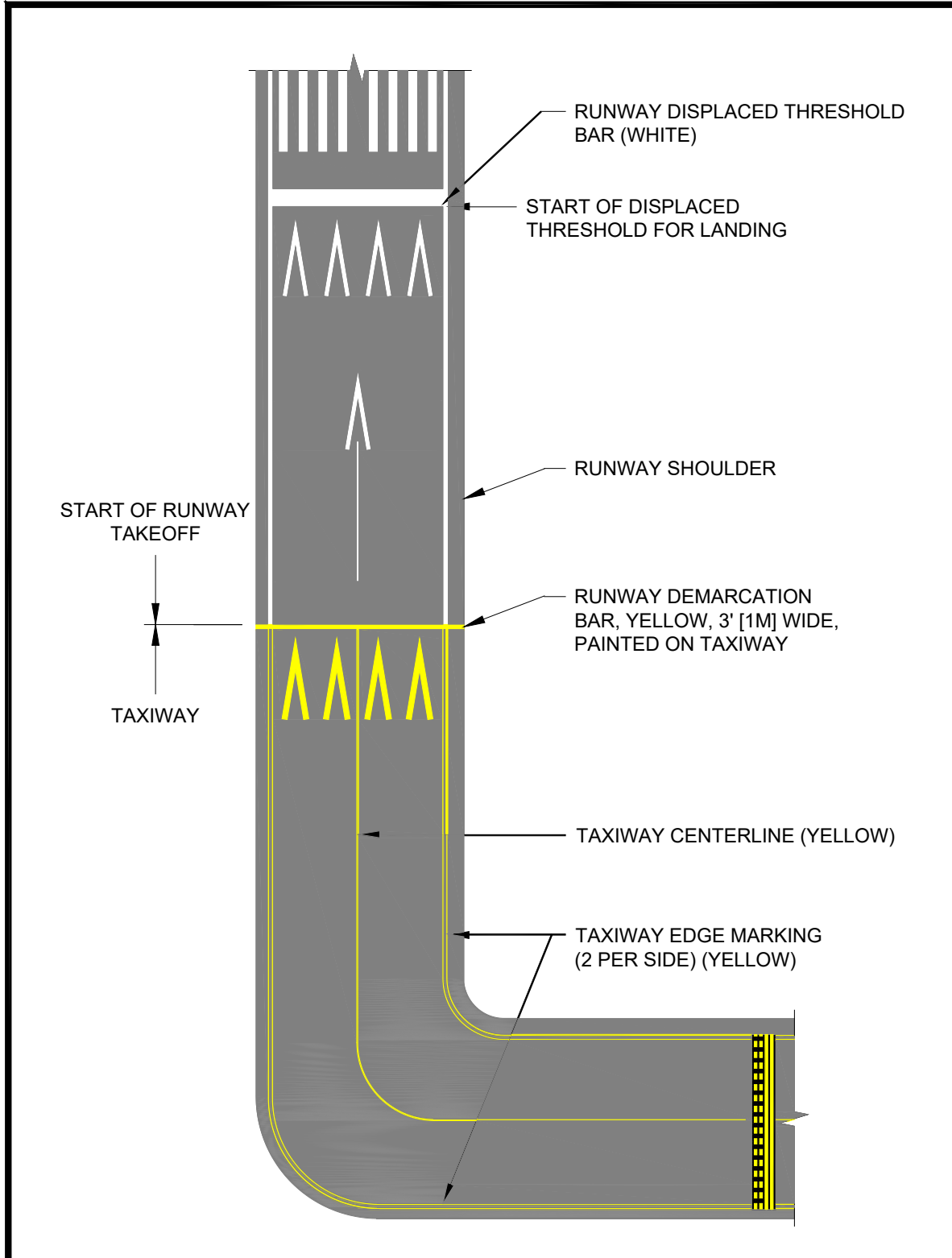

Note: Aligned taxiways are prohibited per [AC 150/5300-13](#) for new construction or reconstruction of existing aligned taxiways.

Figure A-11. Markings for Blast Pad Preceding a Displaced Threshold

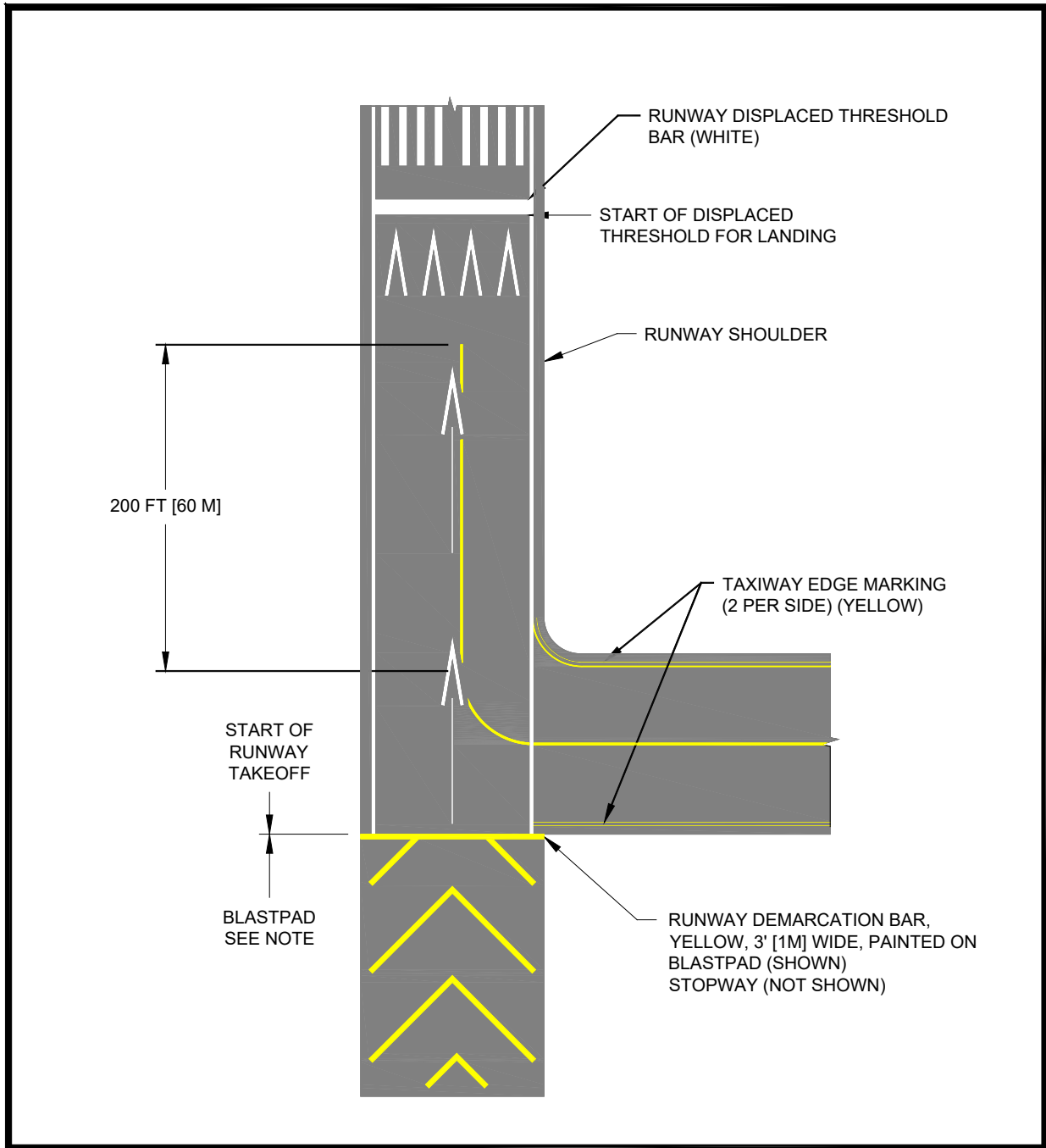

Notes:

1. Stopway width equals runway width.
2. Blast pad width equals runway width plus runway shoulders.
3. For proper fillet and centerline layout, refer to AC 150/5300-13.

Figure A-12. Runway Shoulder Markings

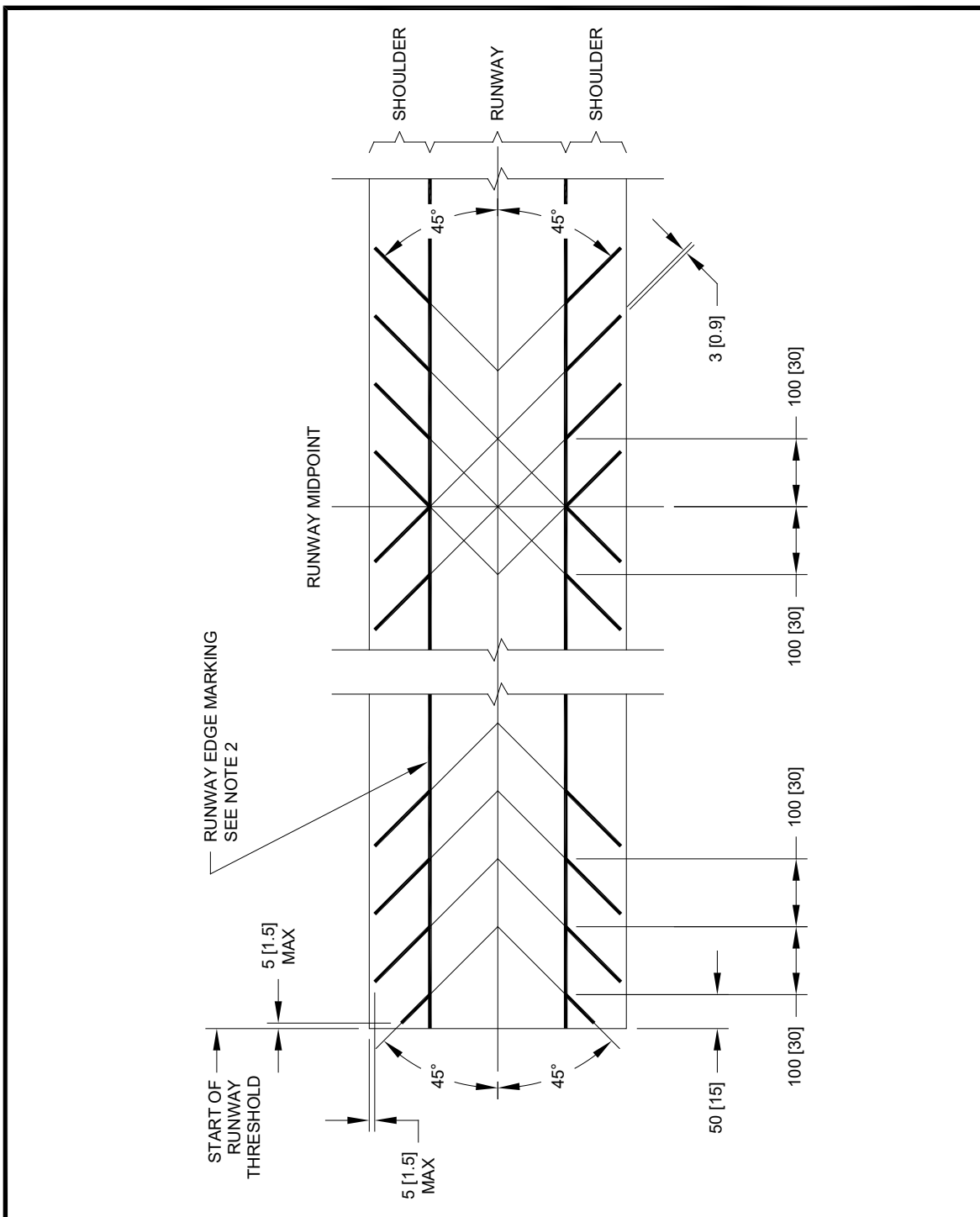

Notes:

1. Dimensions are expressed in feet (meters).
2. Yellow runway shoulder markings are used only in conjunction with white runway edge markings.
3. Runway shoulder markings are painted yellow.

Figure A-13. Holding Position Marking Details

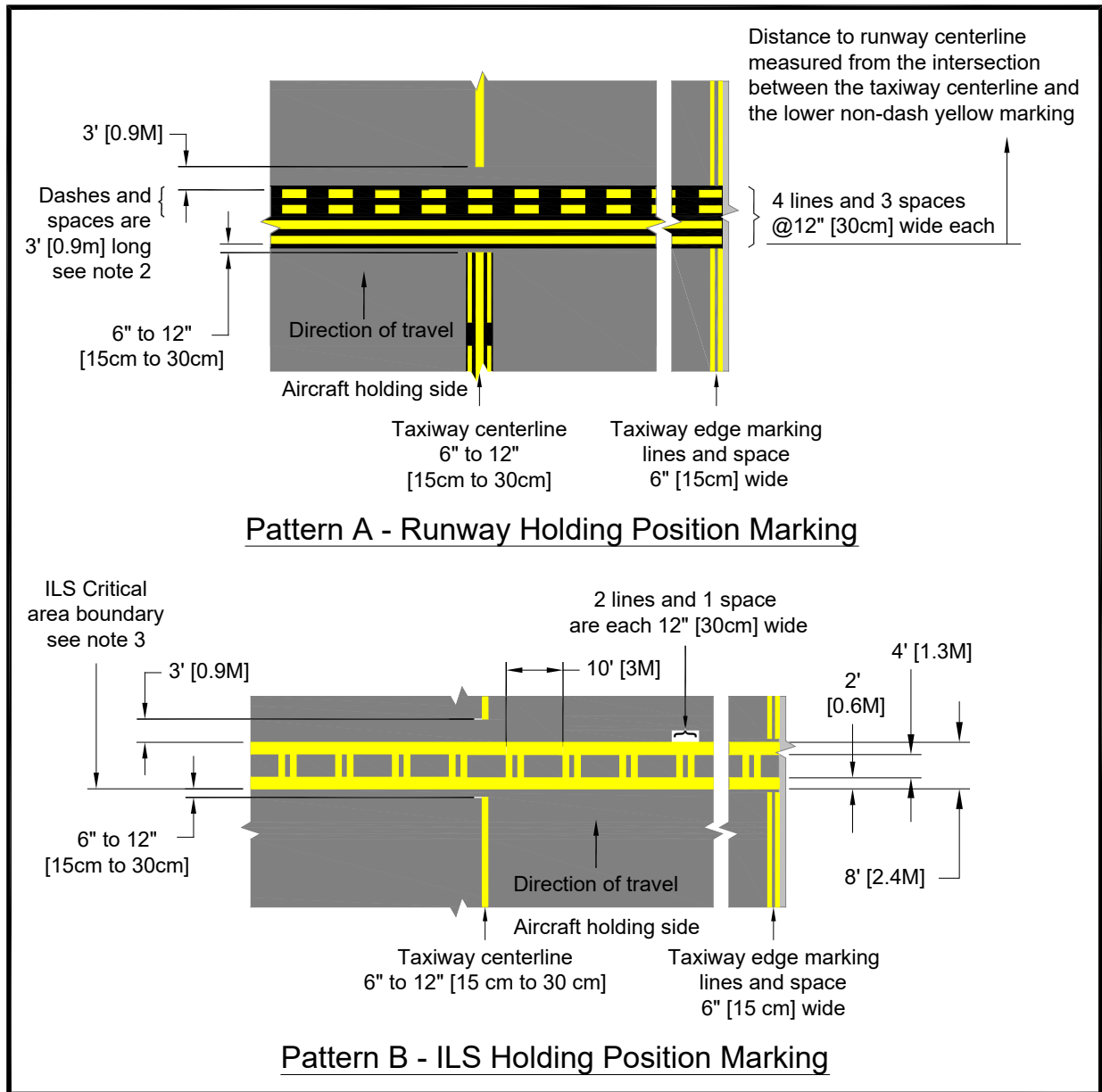

Notes:

1. Unless otherwise noted, all lines are yellow.
2. See paragraph 3.3 for reductions.
3. See paragraph 3.4 for reductions.
4. Dimensions shown do not account for outline marking in black paint when on light-colored pavement. See paragraph 1.4 and Appendix C.
5. See Table 1-1 for general guidelines for black borders on light-colored pavements.

Figure A-14. Holding Position Marking Details

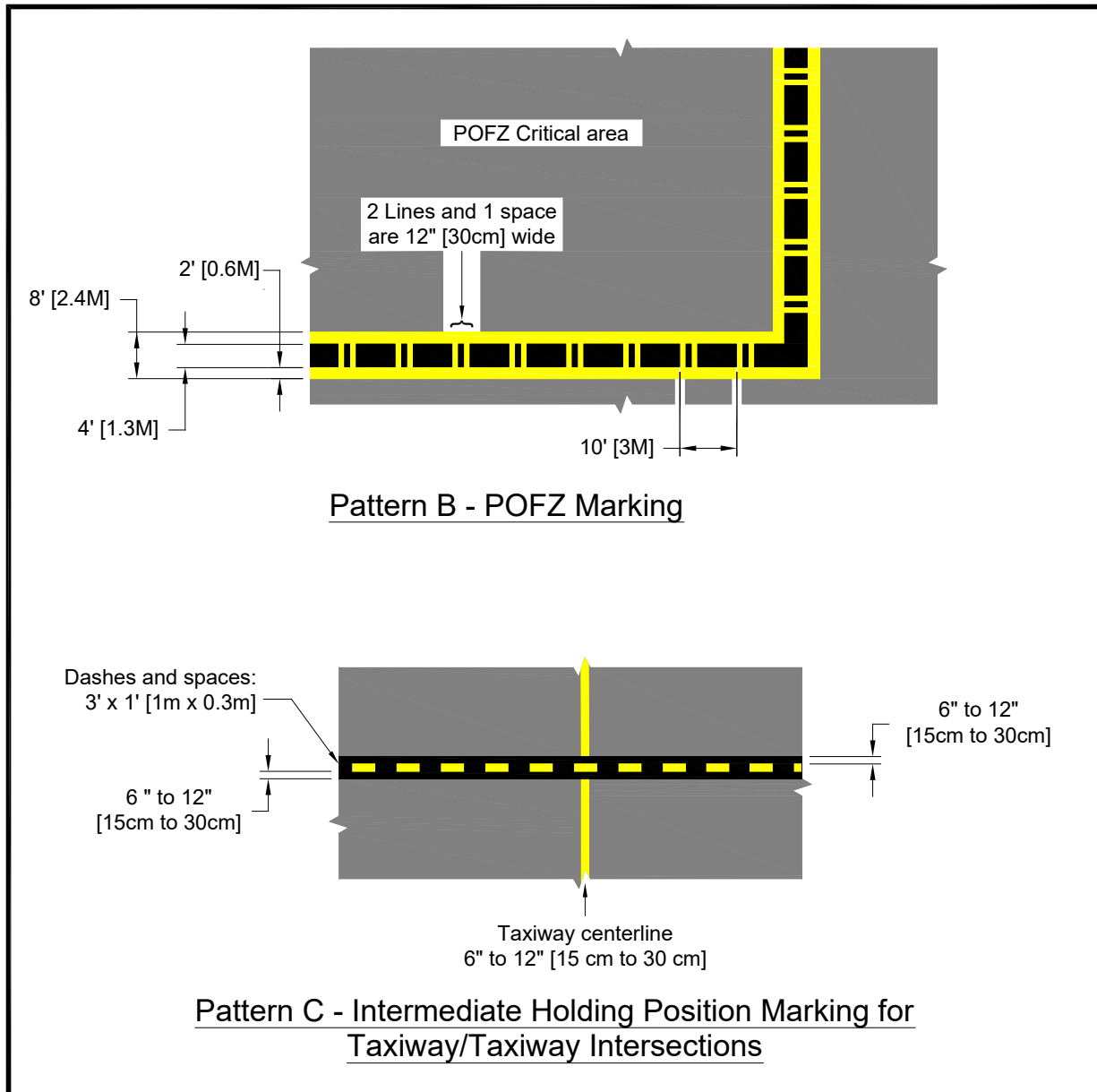

Notes:

1. Unless otherwise noted all lines are yellow.
2. Dimensions shown do not account for outline marking in black paint when on light-colored pavement. See paragraph 1.4 and Appendix C.
3. See Table 1-1 for general guidelines for black borders on light-colored pavements.

Figure A-15. Taxiway Markings

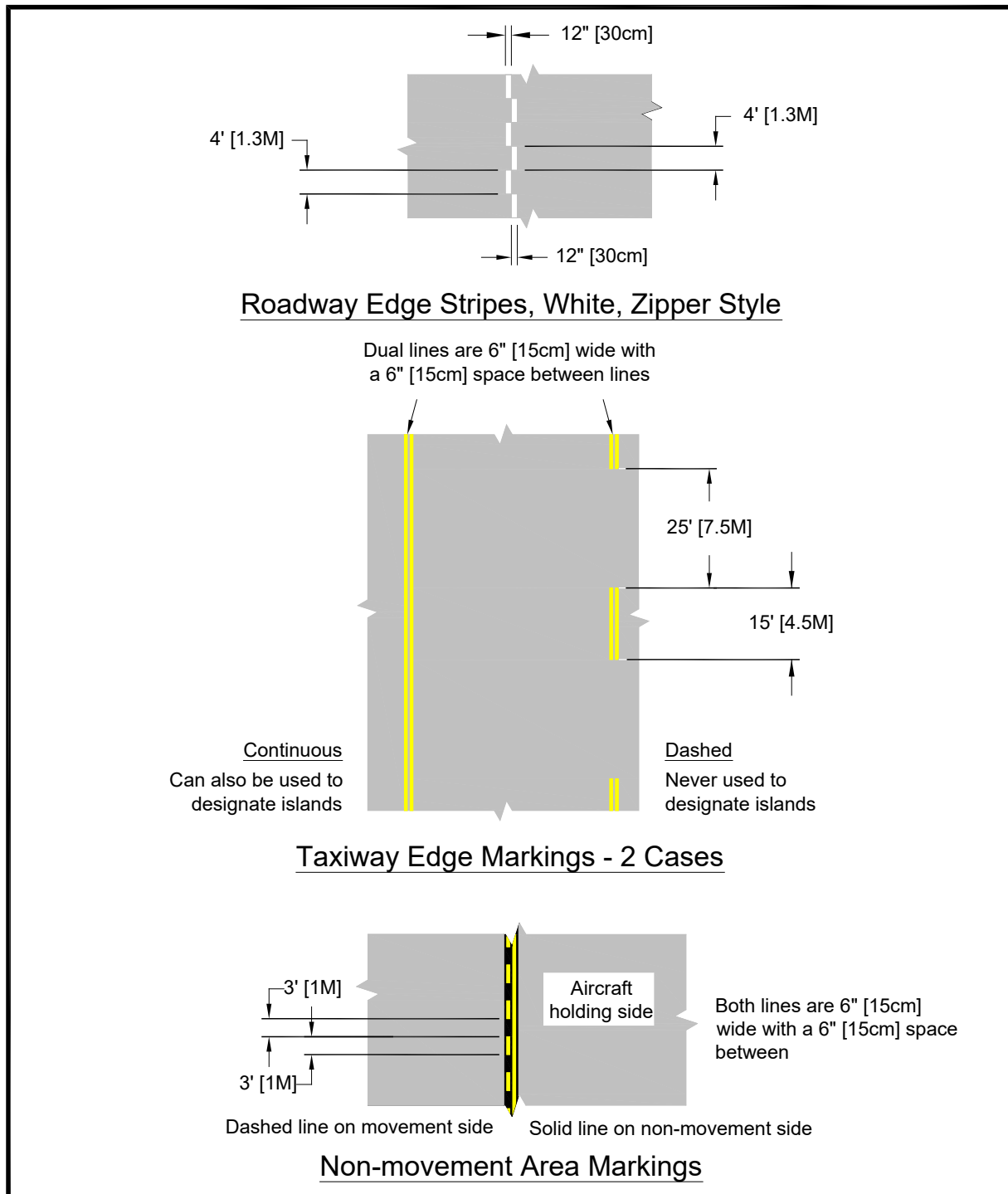

Notes:

1. Unless otherwise noted all lines are yellow.
2. Dimensions shown do not account for black outline of enhanced taxiway marking. See paragraph 1.4 and Appendix C.

Figure A-16. Taxiway Markings

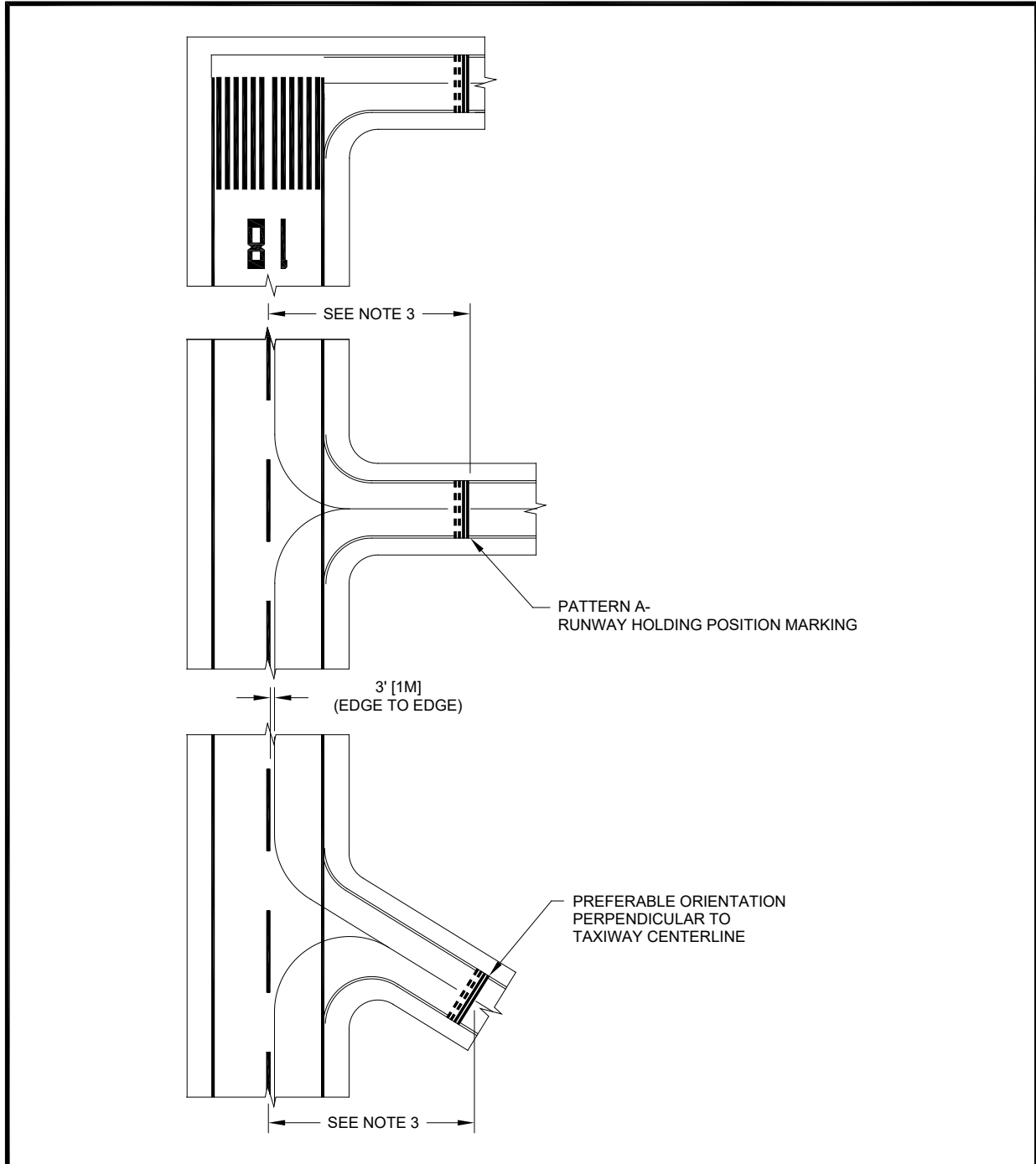
**Notes:**

1. Refer to [Figure A-1](#), [Figure A-13](#) and [Figure A-14](#) for dimensions off the runway and taxiway markings identified in this figure.
2. Refer to [AC 150/5340-18](#) for sign requirements at holding position markings.
3. Refer to paragraph 320 of [AC 150/5300-13](#) for placement assistance.
4. Not all required surface markings are shown, such as, the enhanced taxiway centerline marking and surface painted holding position sign marking, to offer picture clarity.

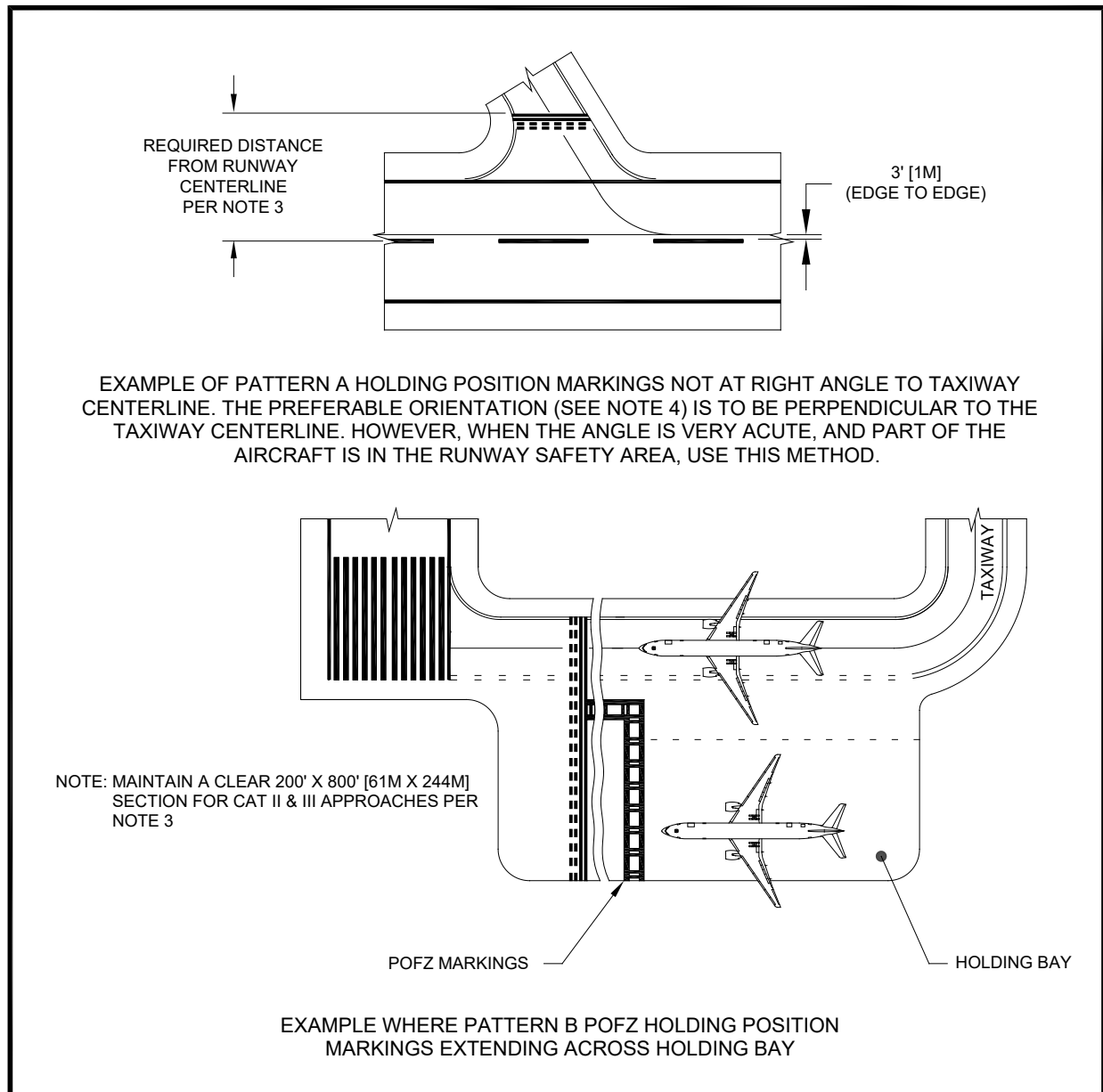
Figure A-17. Taxiway Markings**Notes:**

1. Refer to [Figure A-1](#), [Figure A-13](#) and [Figure A-14](#) for dimensions off the runway and taxiway markings identified in this figure.
2. Refer to [AC 150/5340-18](#) for sign requirements at holding position markings.
3. Refer to [AC 150/5300-13](#) for proper fillet and centerline geometry.
4. Refer to [Figure A-14](#).
5. Not all required surface markings are shown, such as, the enhanced taxiway centerline marking and surface painted holding position sign marking, to offer picture clarity.

Figure A-18. Methods for Taxiway Centerline Marking

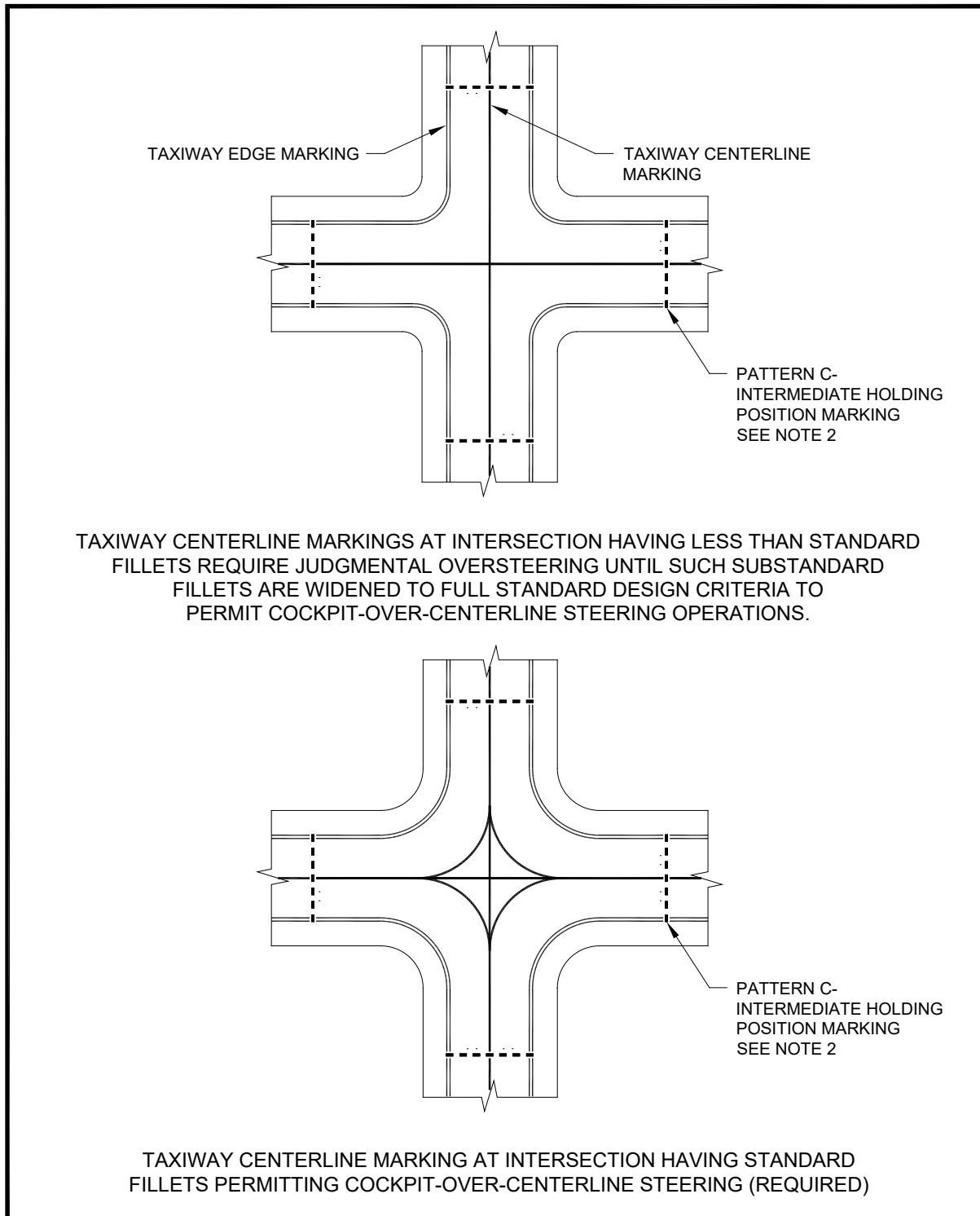

Notes:

1. Refer to [Figure A-12](#) and [Figure A-13](#) for dimensions of the taxiway marking identified in this figure.
2. Refer to [Figure A-13](#).

Figure A-19. Surface Painted Direction Signs

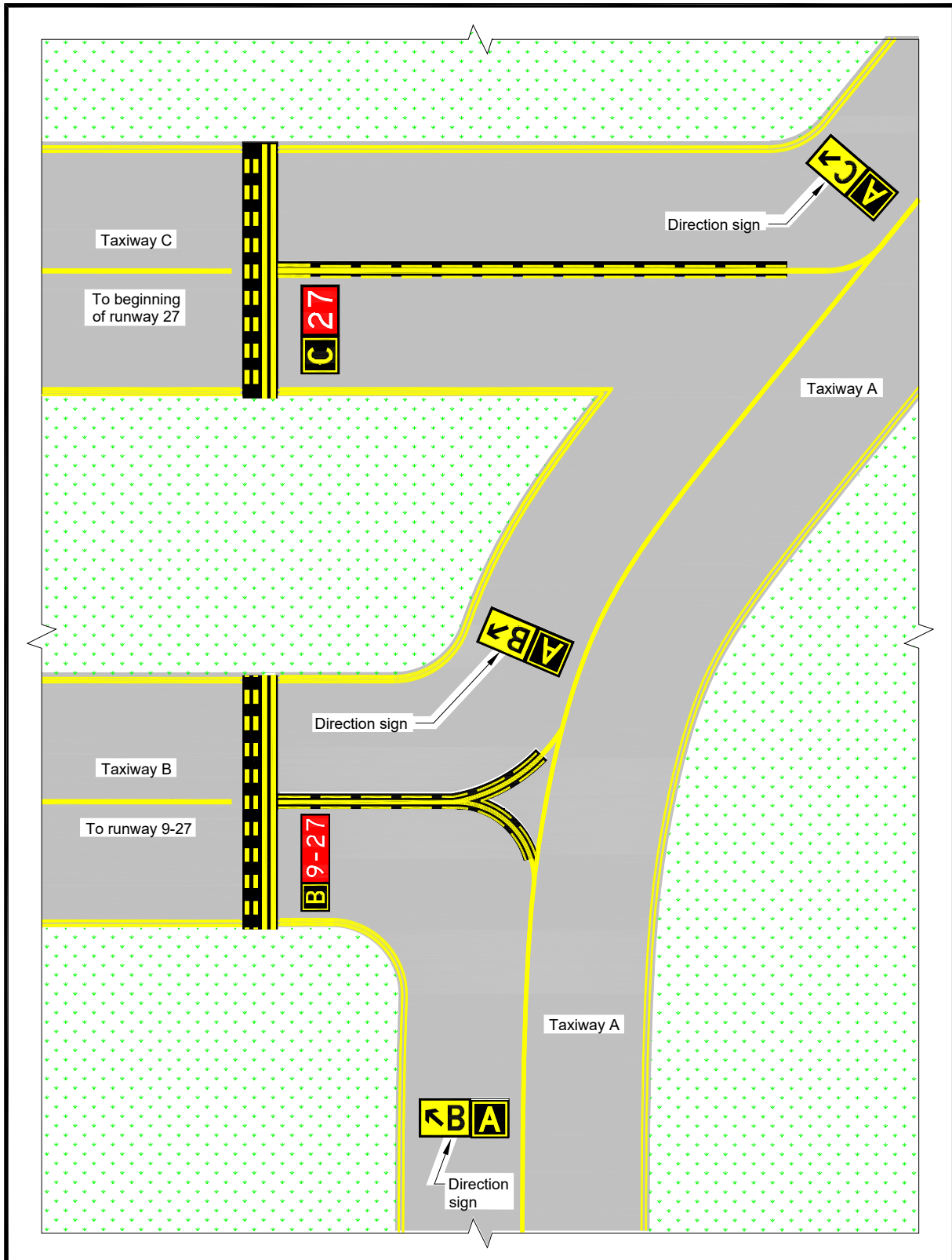

Figure A-20. Surface Painted Gate Identification Signs

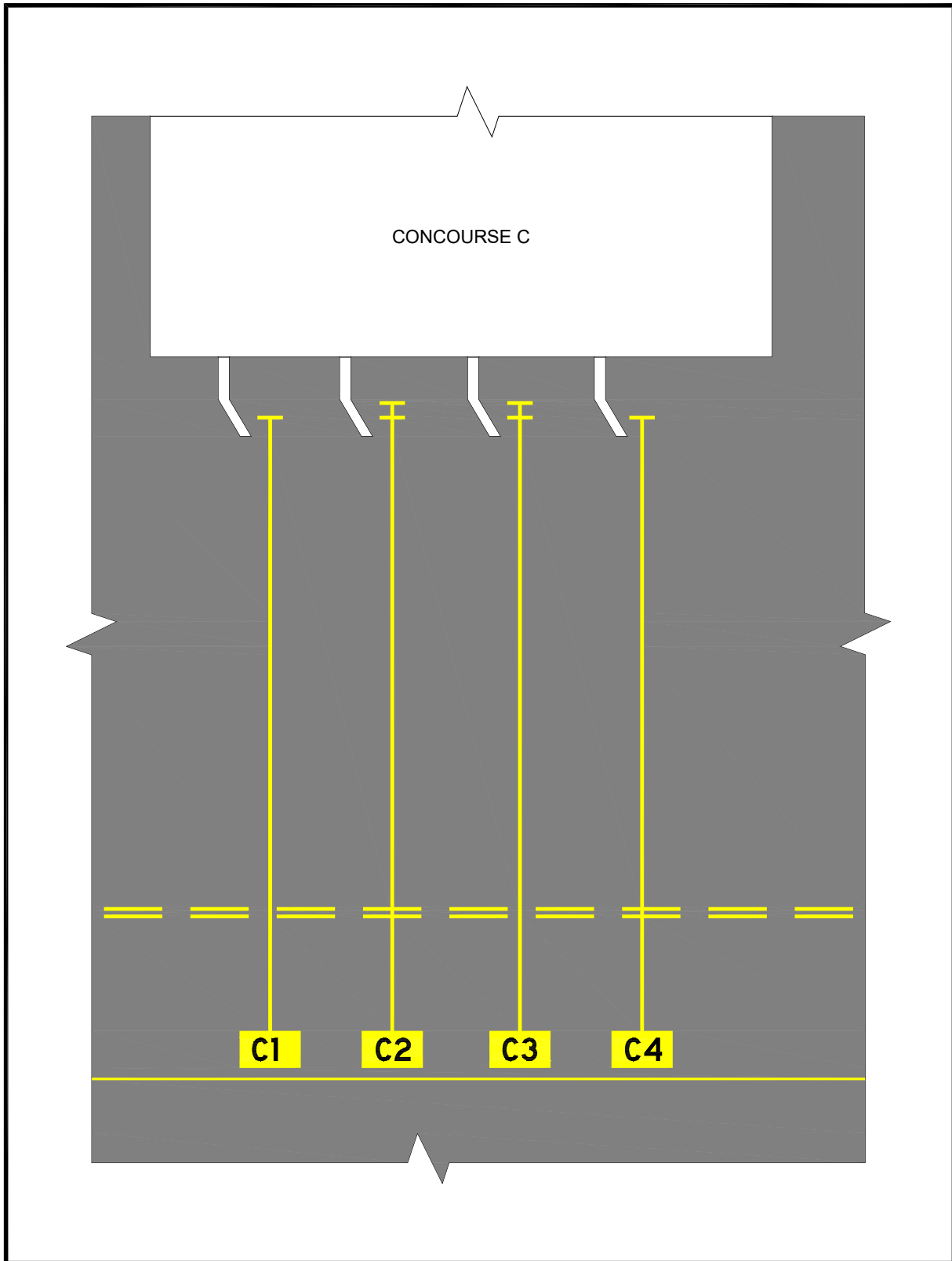

Figure A-21. Multiple Gate Signs

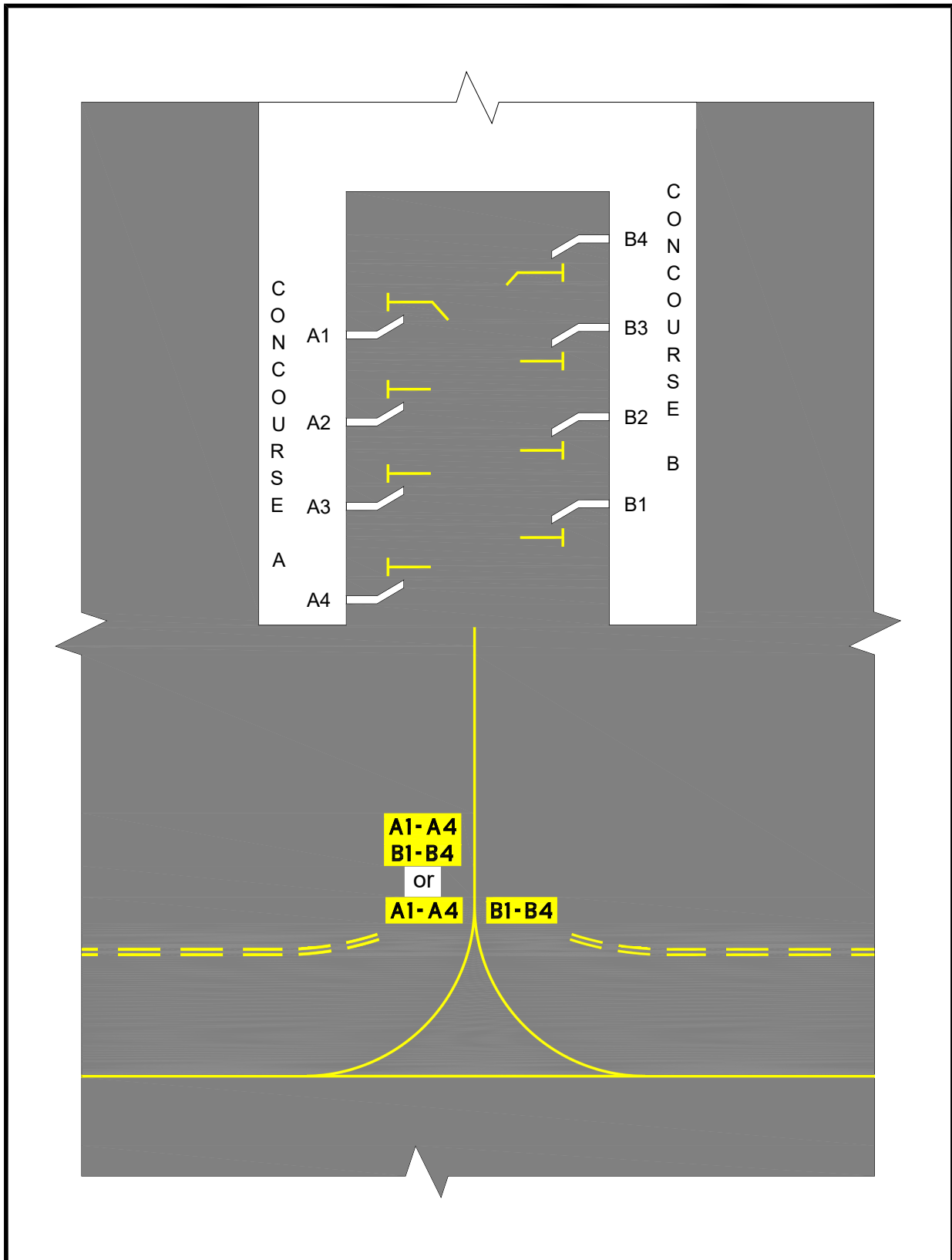
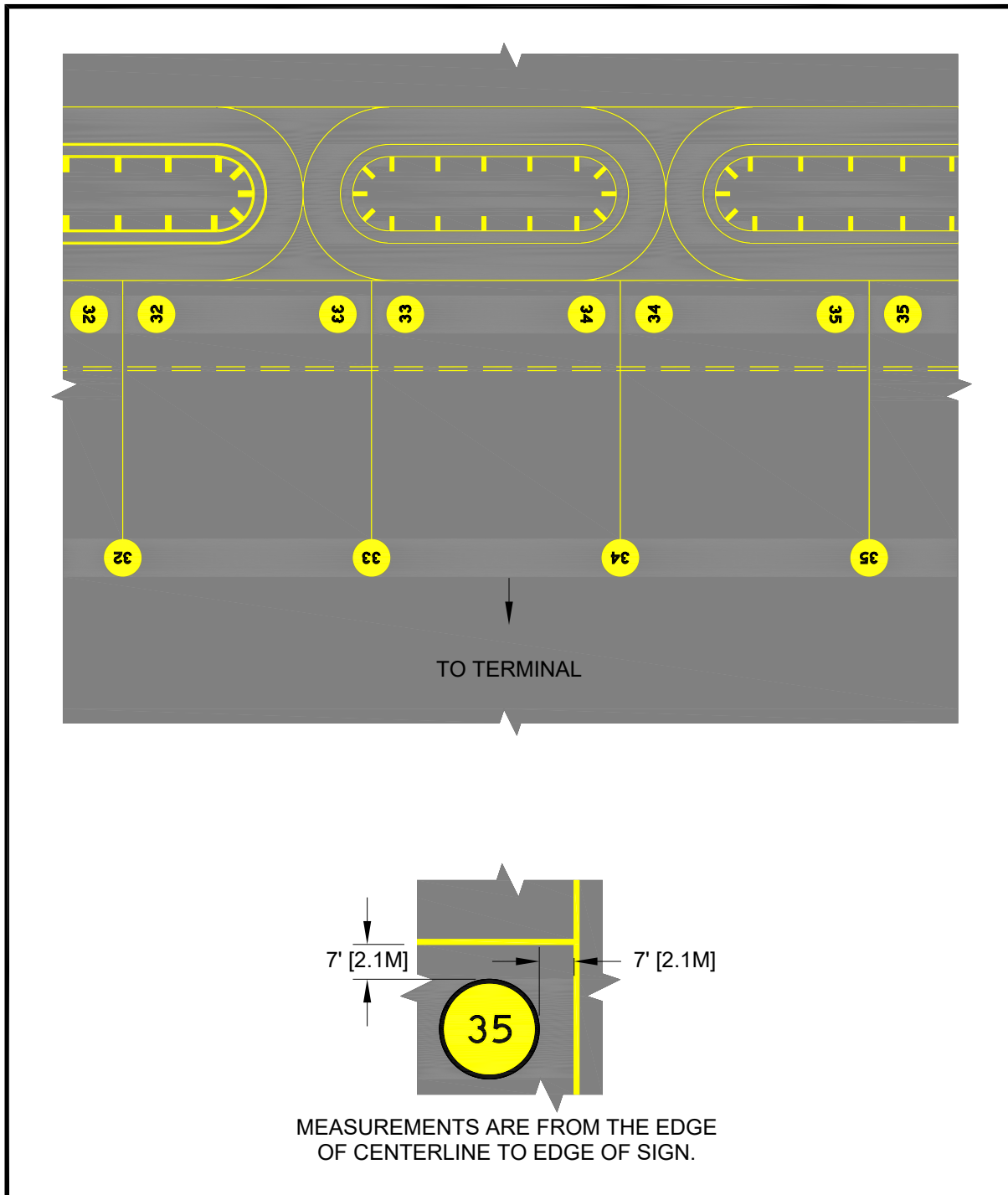
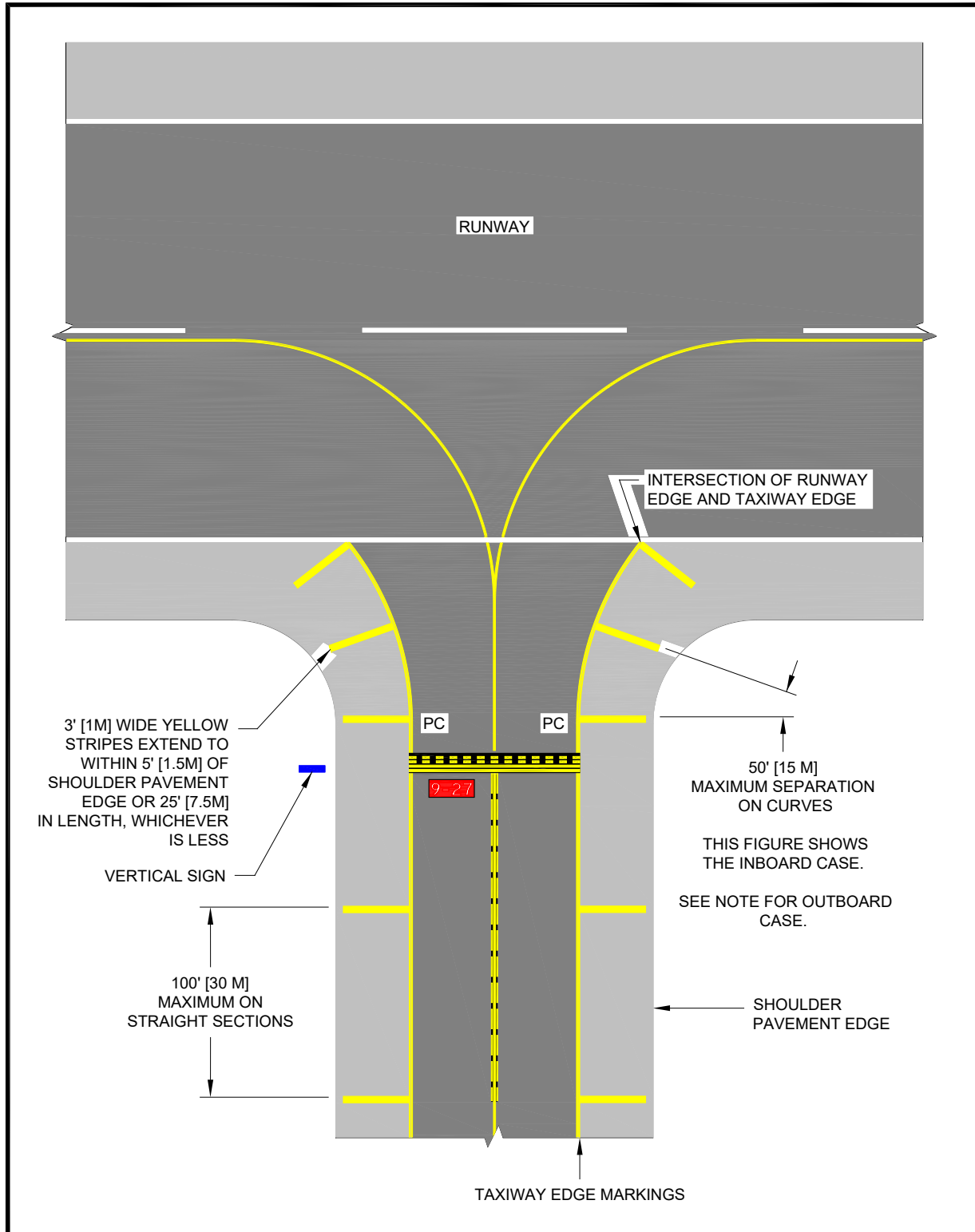

Figure A-22. Surface Painted Apron Entrance Point Signs



Note: Centerline at apron entrance point locations may be marked with a radius marking rather than with a “T” configuration, as shown.

Figure A-23. Taxiway Shoulder Markings



- Note:**
1. See paragraph [4.10.3.2](#)
 2. PC – Point of curvature

Figure A-24. Geographic Position Markings

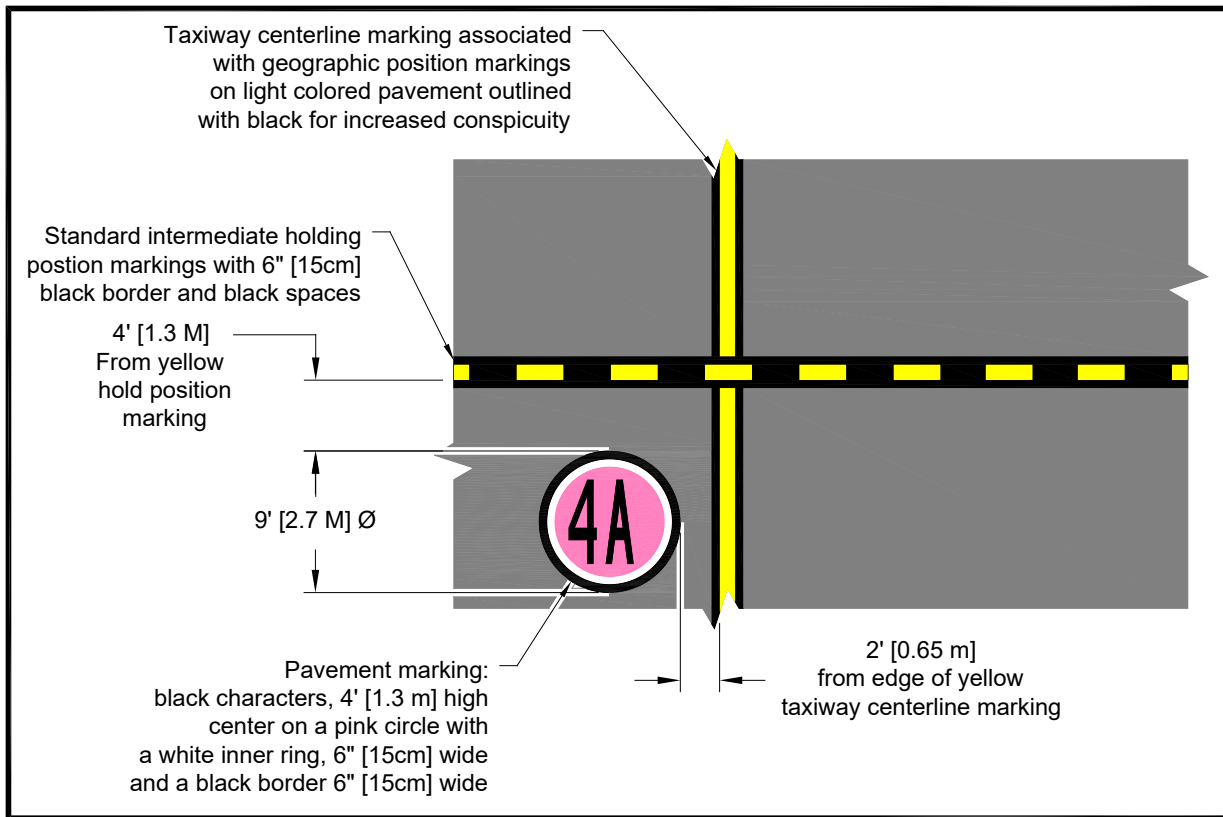
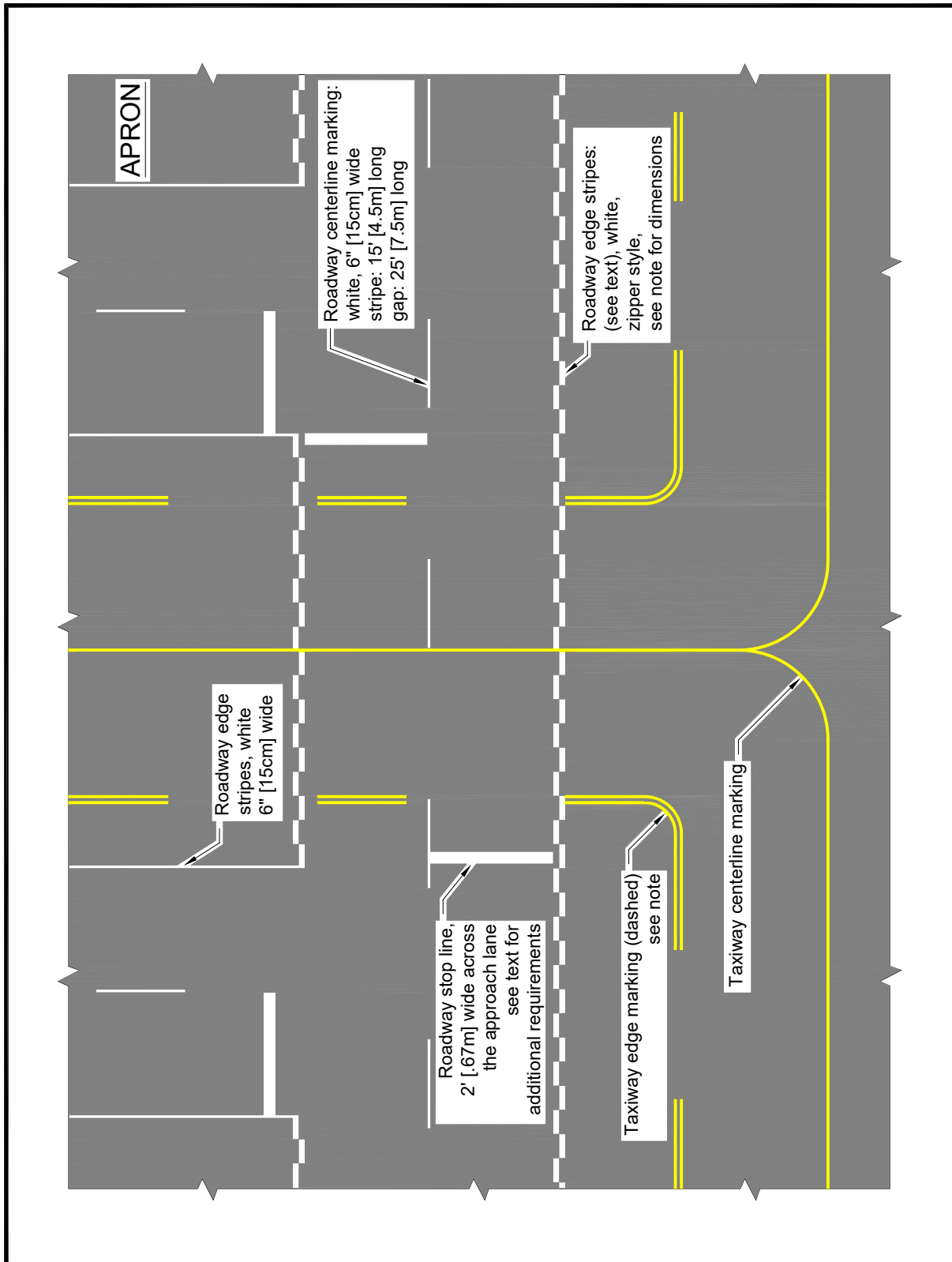
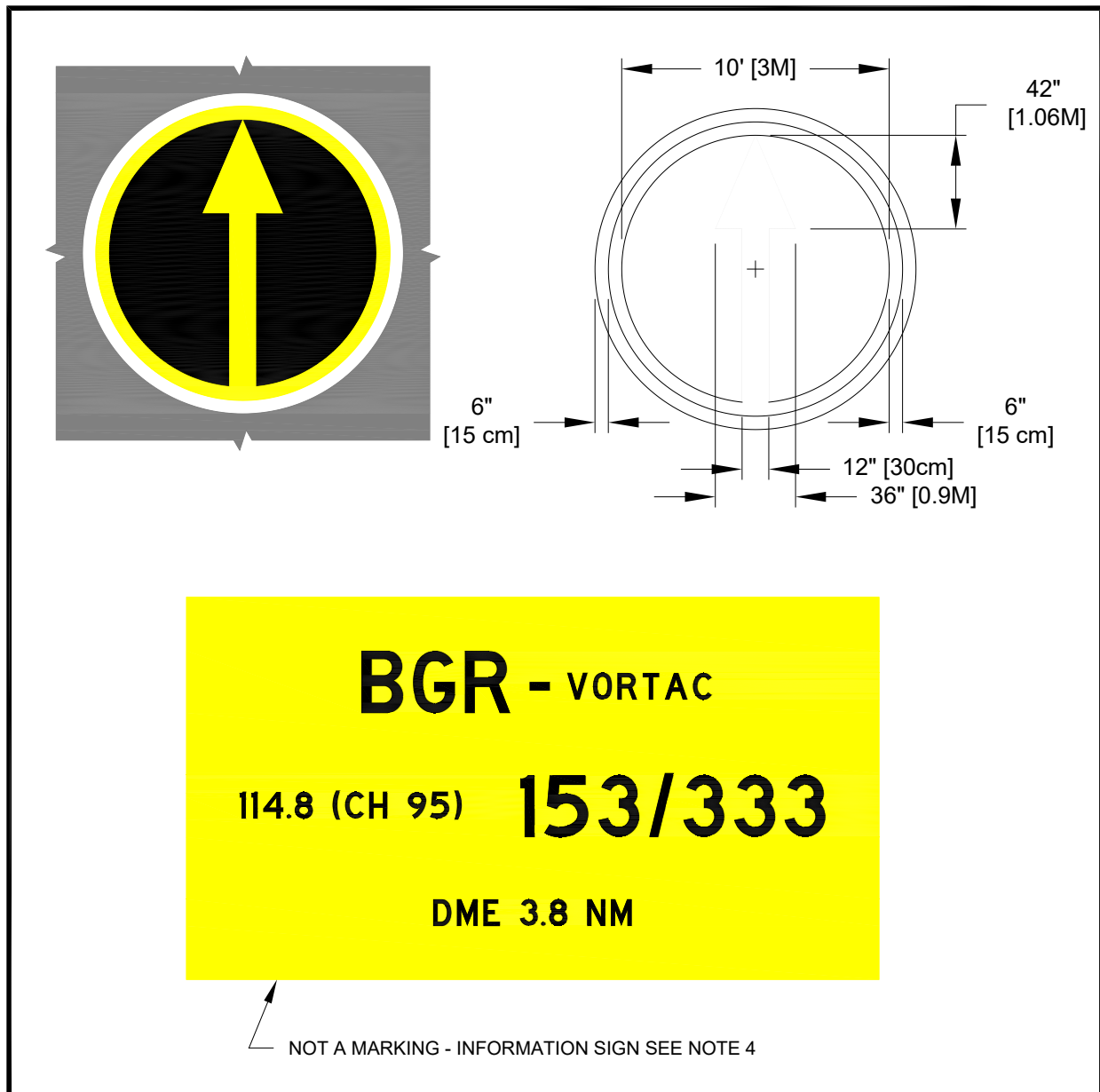

Figure A-25. Vehicle Roadway Markings



Note: Refer to [Figure A-15](#).

Figure A-26. VOR Receiver Checkpoint Markings

**Notes:**

1. Arrow is to be aligned toward the facility.
2. Interior of circle is to be painted black on concrete surfaces only.
3. Circle may be bordered on inside and outside with a 6 inch (15 cm) black band if necessary for contrast.
4. Refer to [AC 150/5340-18](#).

Figure A-27. Closed Runway and Taxiway Markings

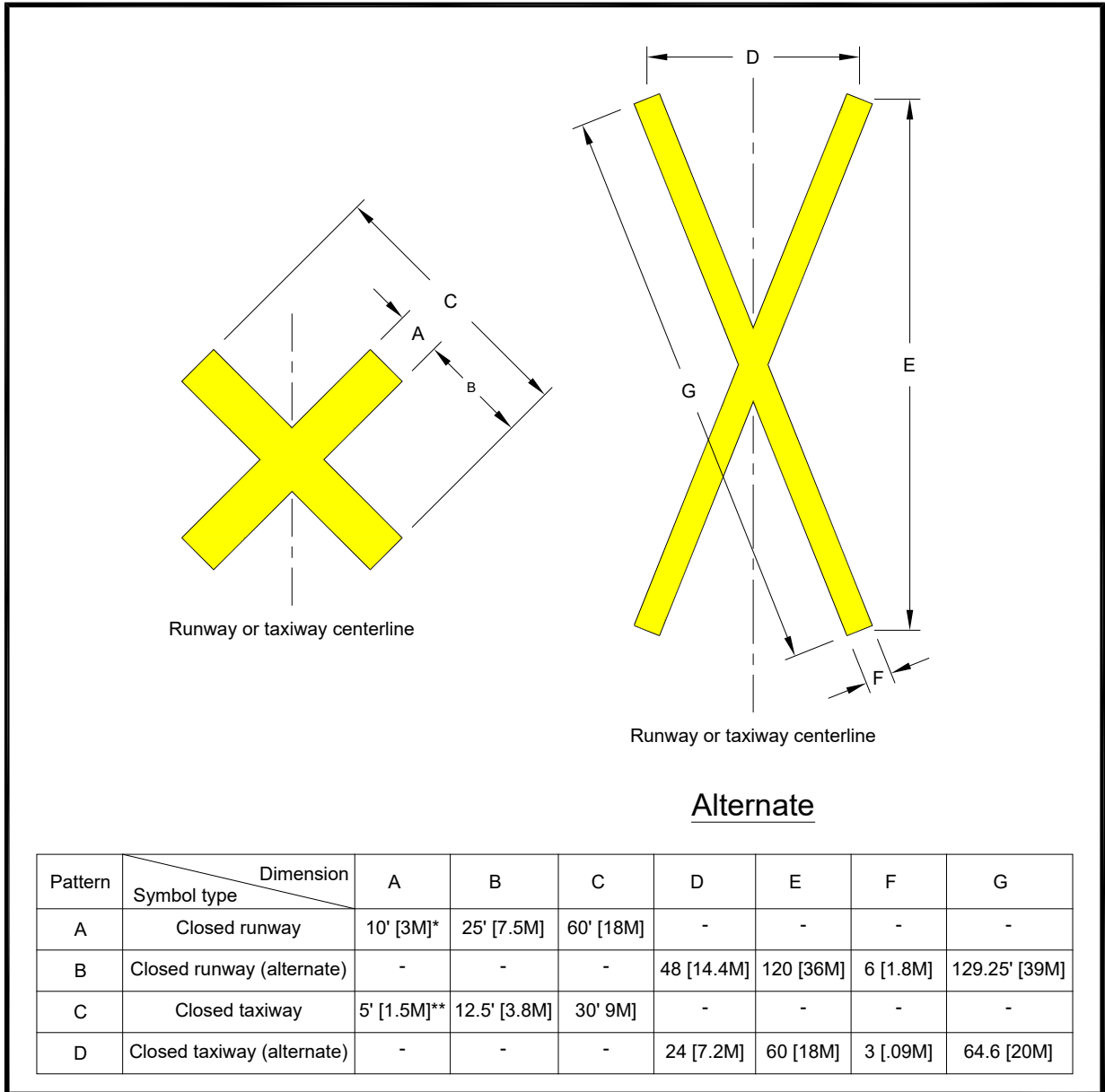

Note: Both symbols are always painted yellow.

* For temporary symbol, this dimension may be changed to 8 ft (2.4m).

** For temporary symbol, this dimension may be changed to 4 ft (1.2m).

Page Intentionally Blank

APPENDIX B. INSCRIPTIONS FOR SIGNS AND GEOGRAPHIC POSITION MARKINGS

Figure B-1. Pavement Markings ABCDEFGH

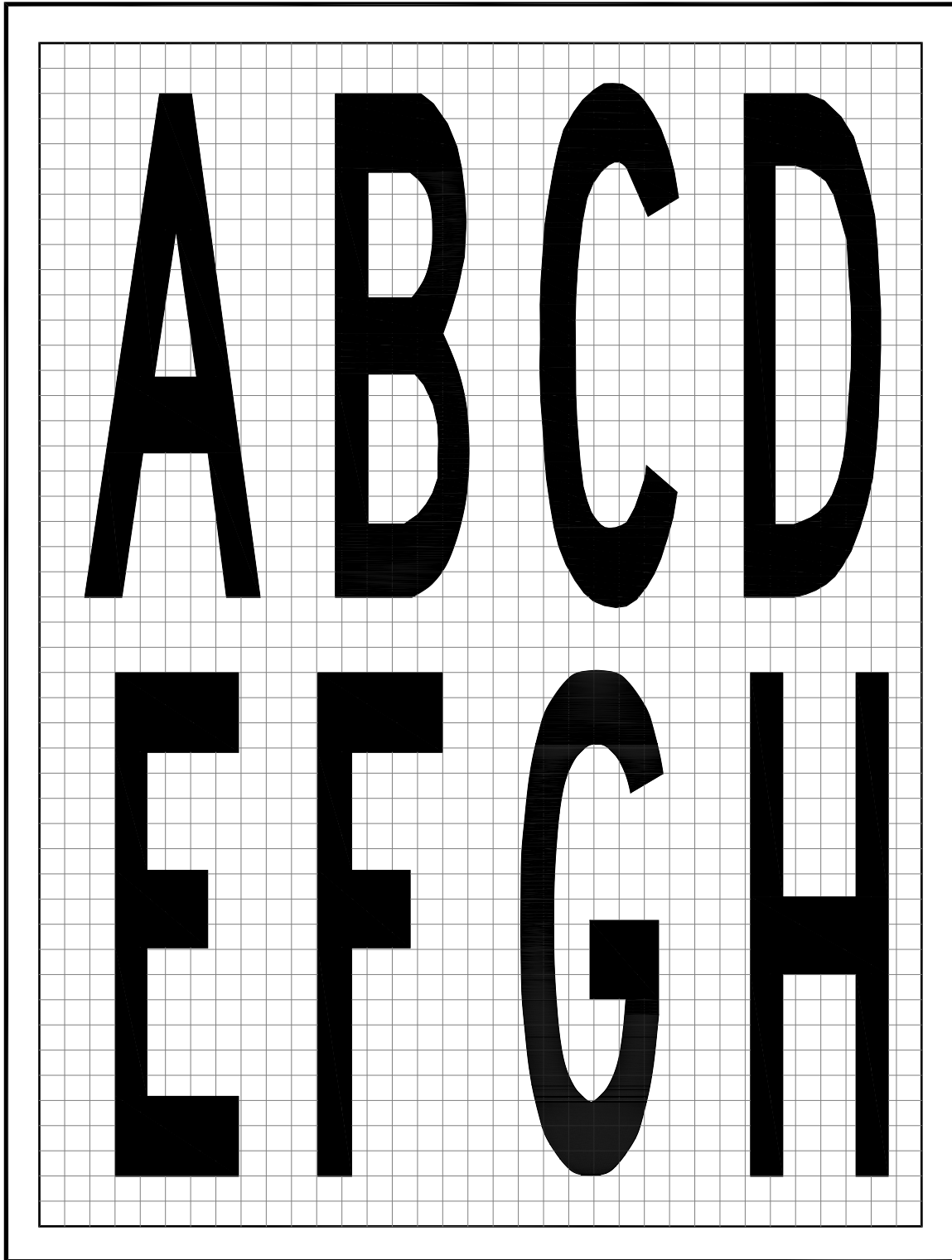

Figure B-2. Pavement Markings IJKLMNPO

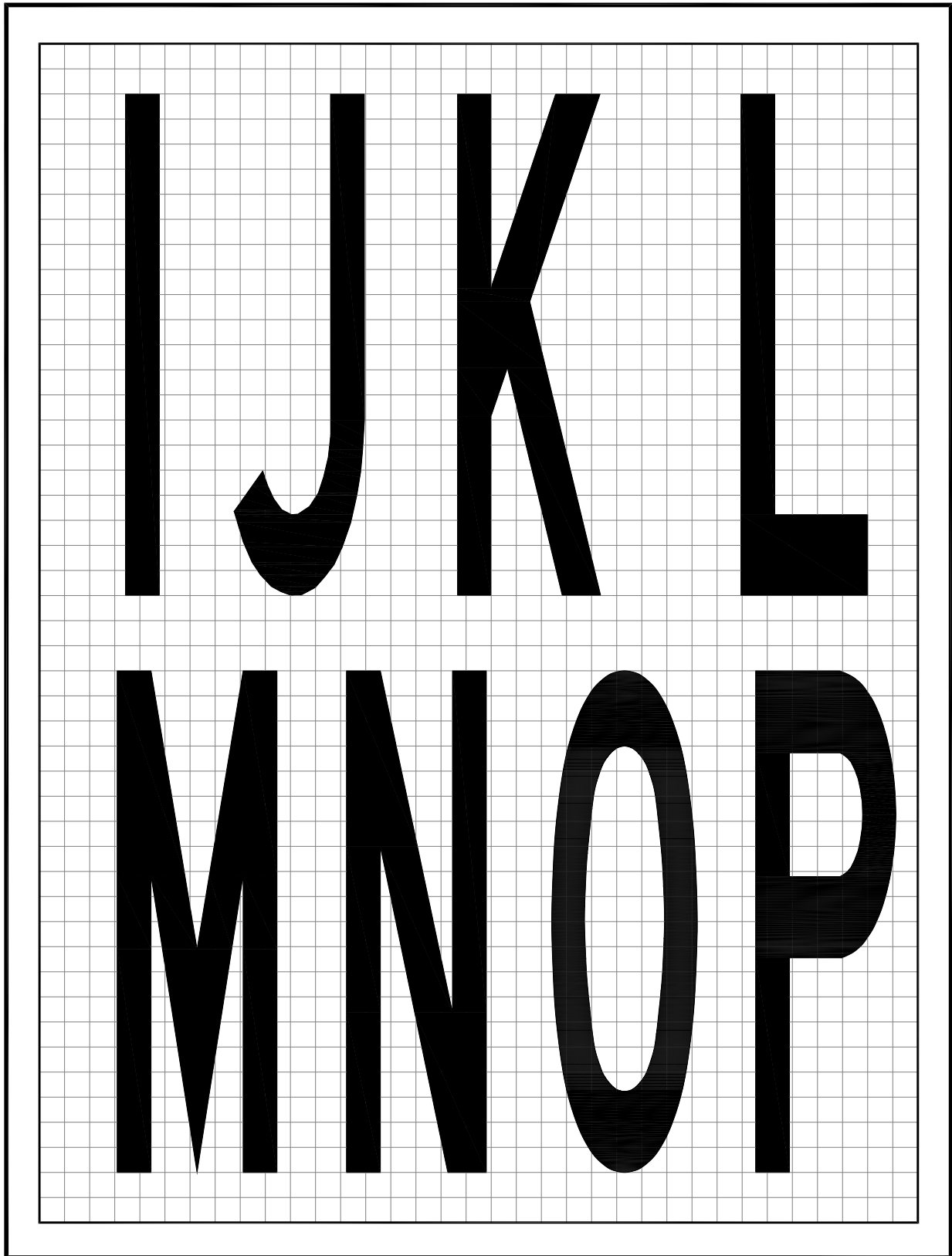

Figure B-3. Pavement Markings QRSTUVWX

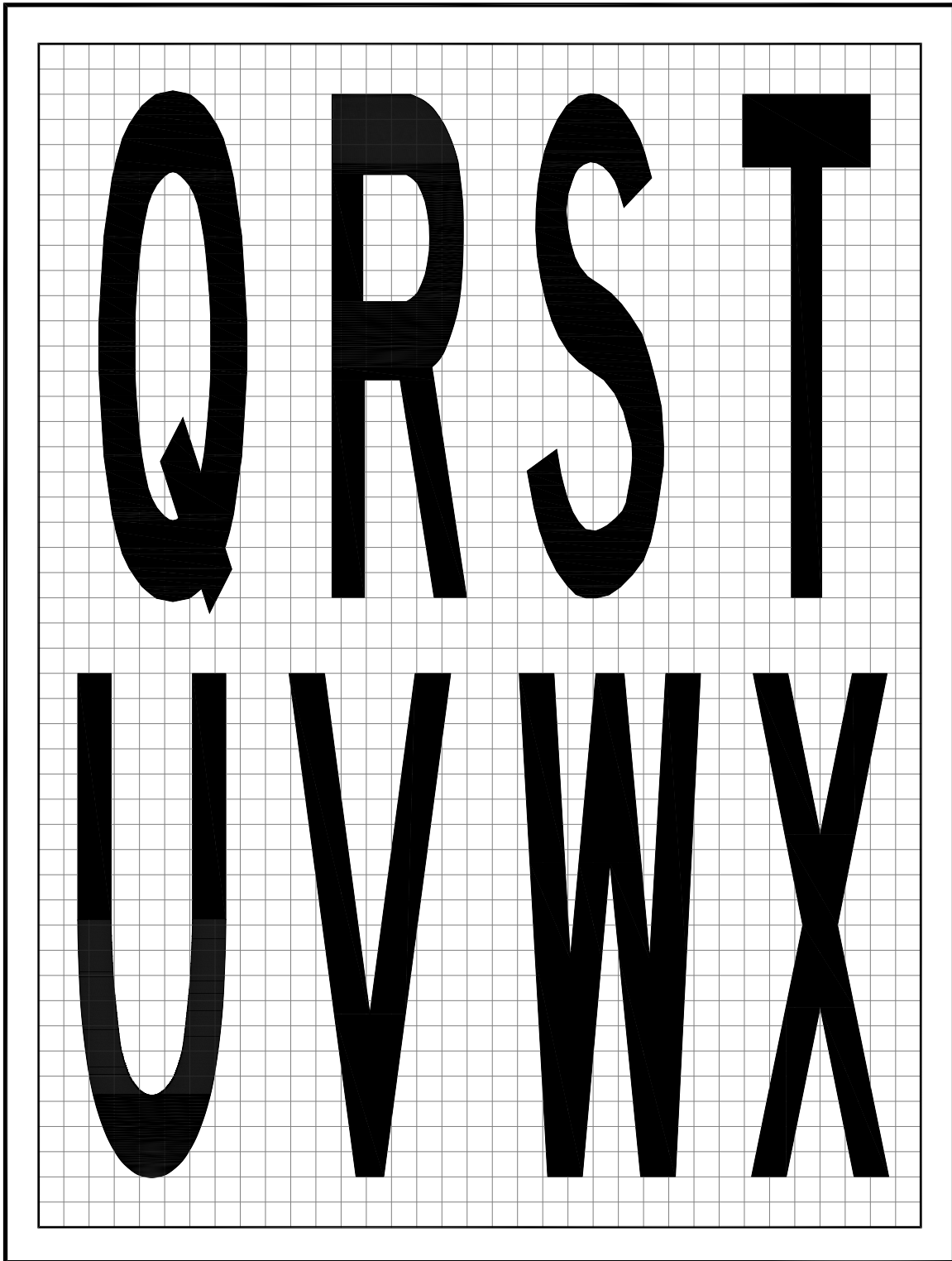

Figure B-4. Pavement Markings YZ123456

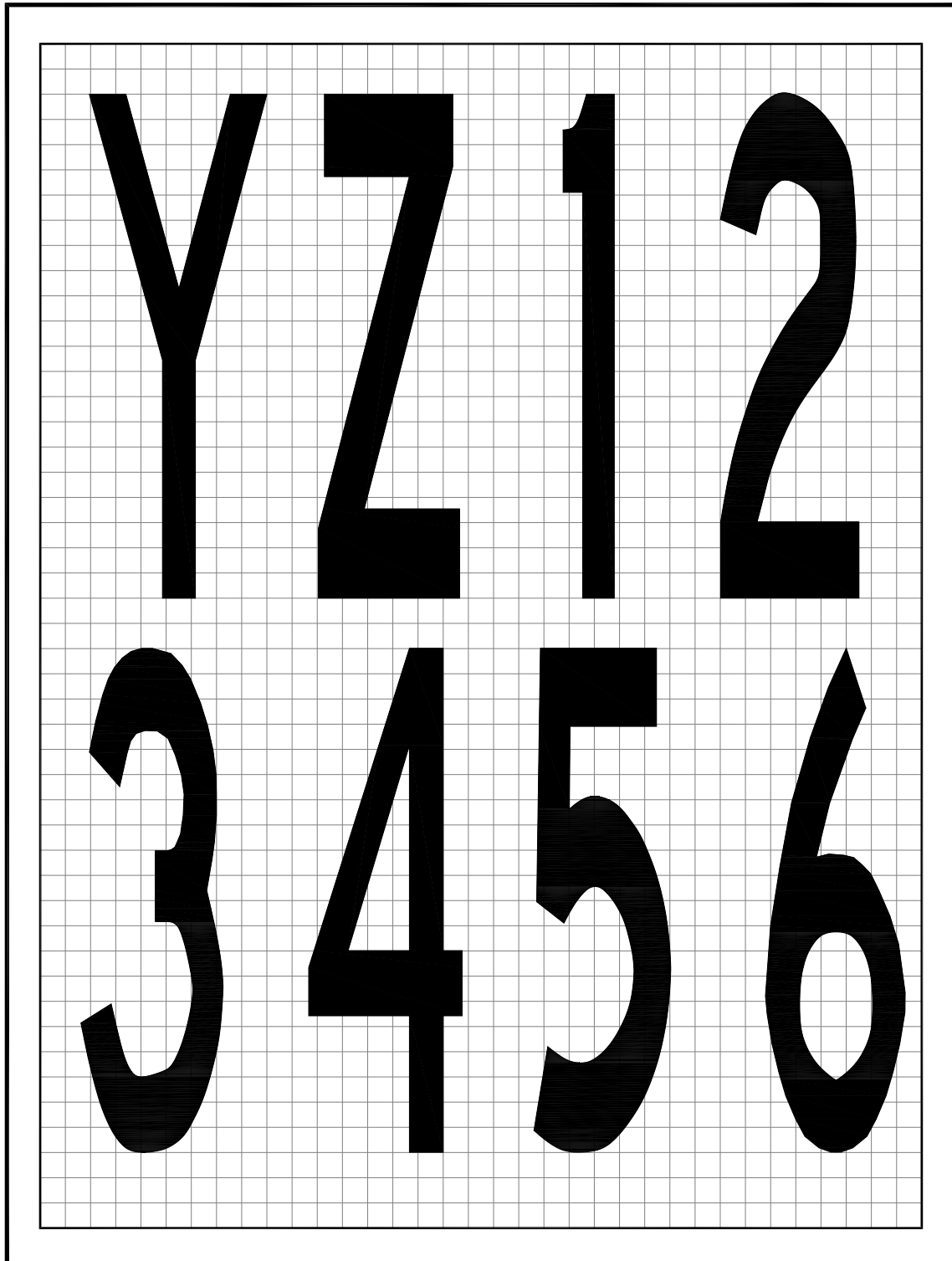
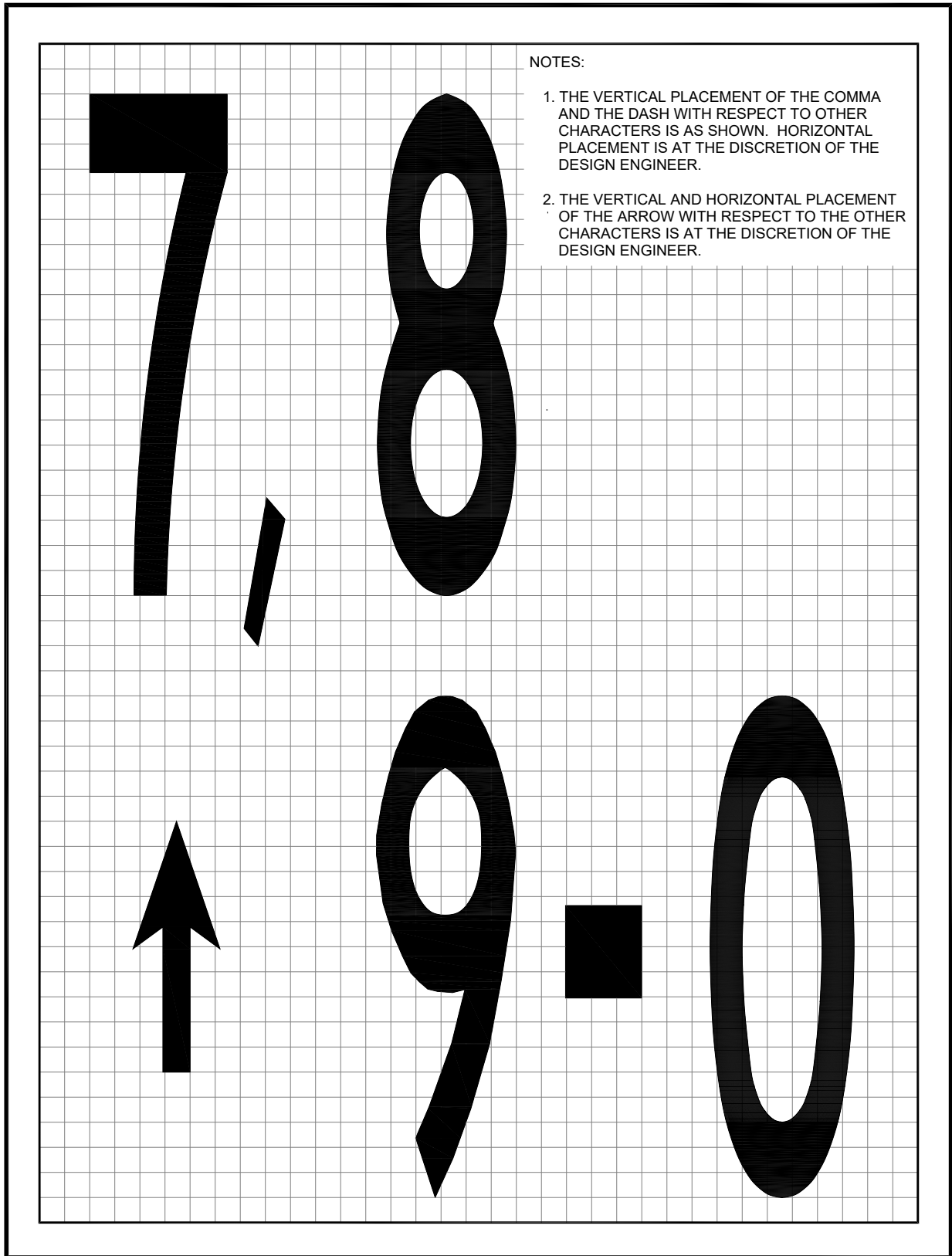

Figure B- 5. Pavement Markings 7890-, ↑



Page Intentionally Blank

APPENDIX C. EXAMPLES OF MARKINGS OUTLINED IN BLACK

This appendix illustrates the acceptable layout for various markings outlined in black. The black paint extends at least 6 inches (15 cm) beyond the outside edge of the markings. All spaces between paint lines in markings composed of two or more lines or dashes are painted in black as illustrated in the figures below. An alternate outlining pattern is provided for dashed taxiway edge line markings. These figures are not drawn to scale.

Figure C-1. Runway Holding Position Marking

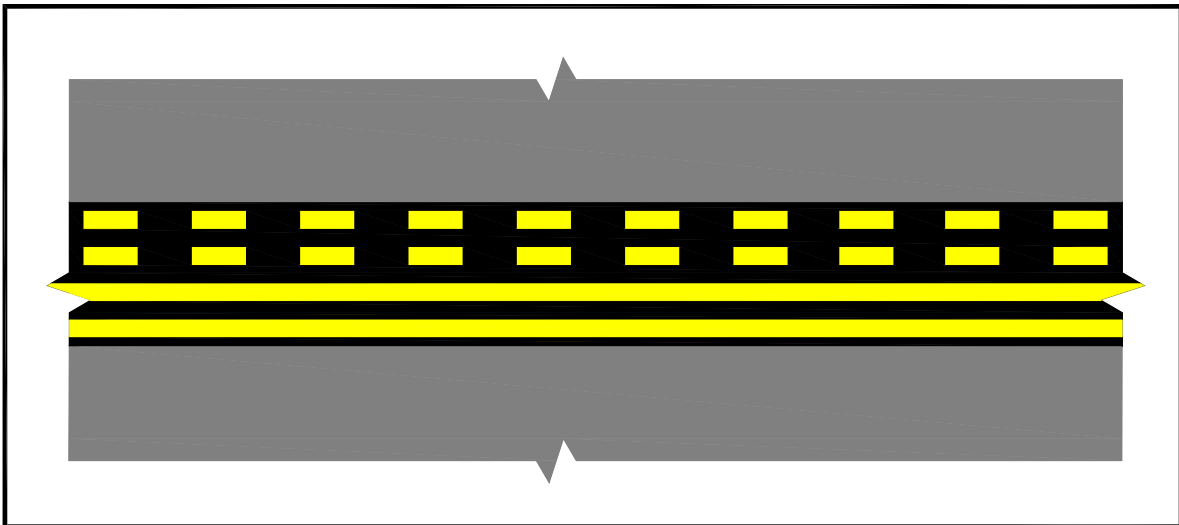

Figure C-2. ILS Holding Position Marking

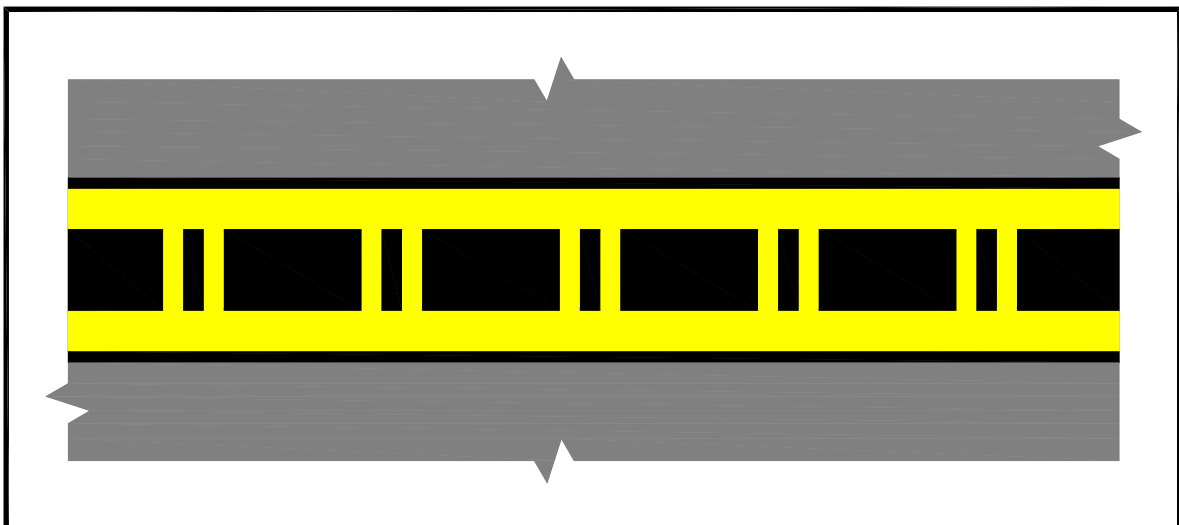

Figure C-3. Continuous Taxiway Edge Line Marking

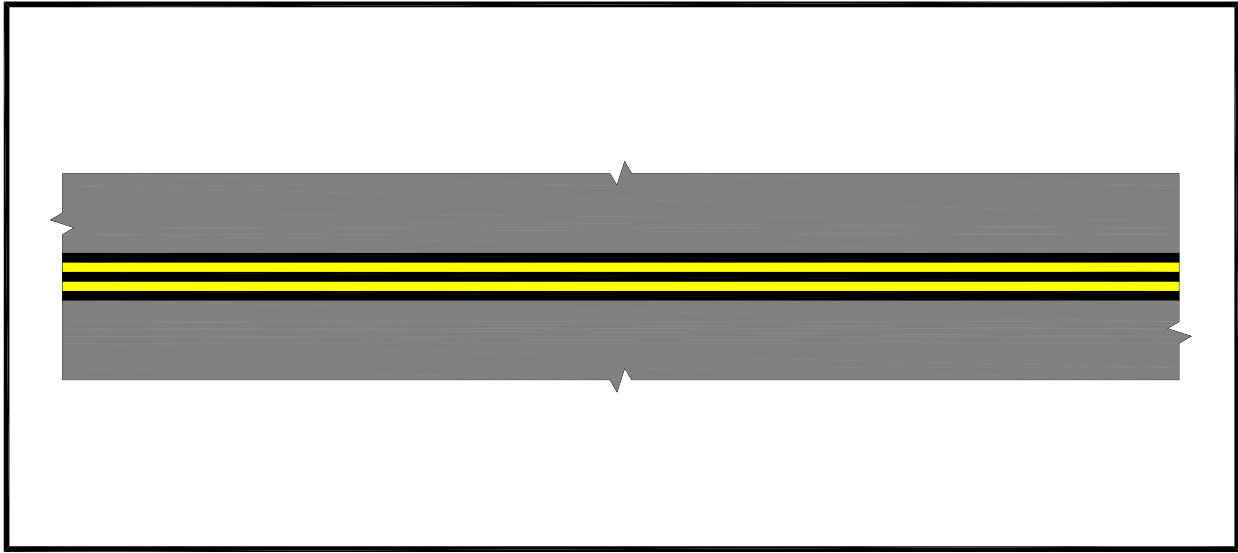

Figure C-4. Dashed Taxiway Edge Line Marking

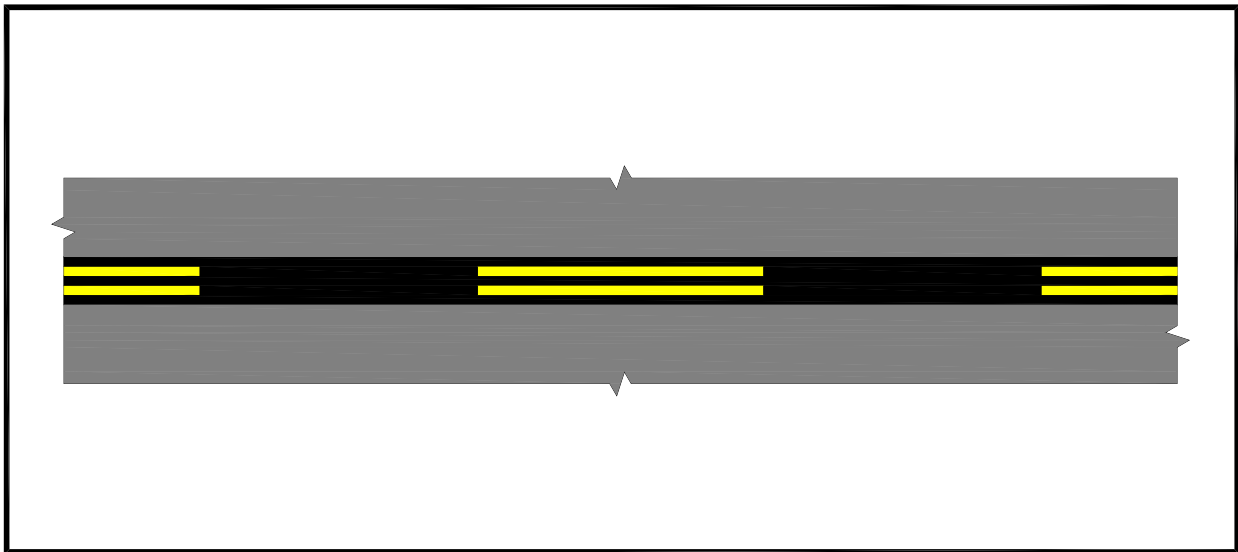

Figure C-5. Alternate Outlining Method for Dashed Taxiway Edge Line Marking

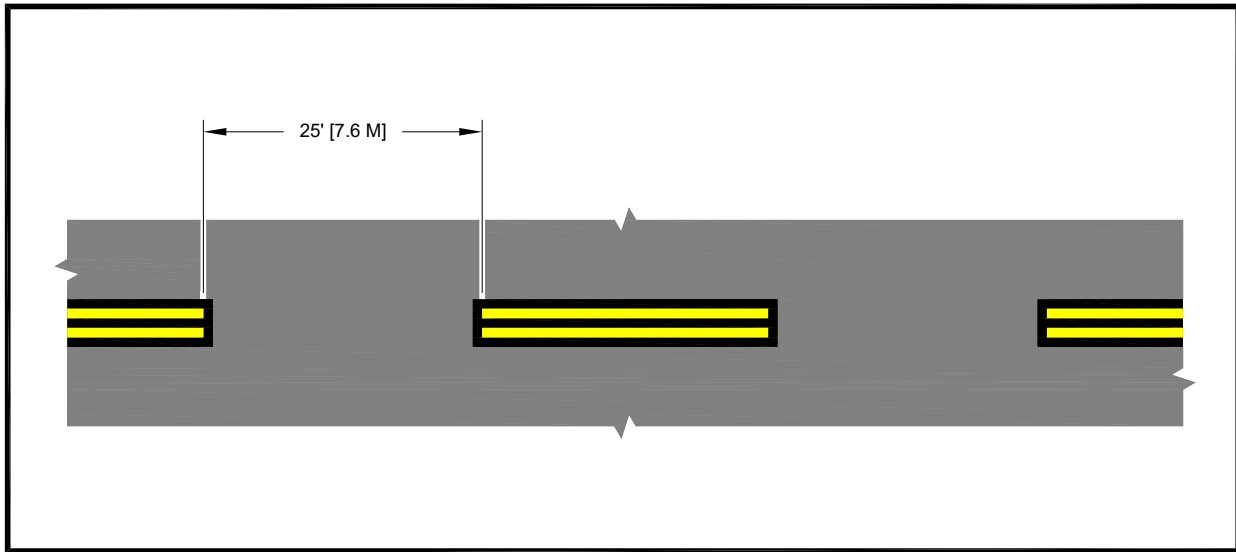

Figure C-6. Taxiway Centerline Marking

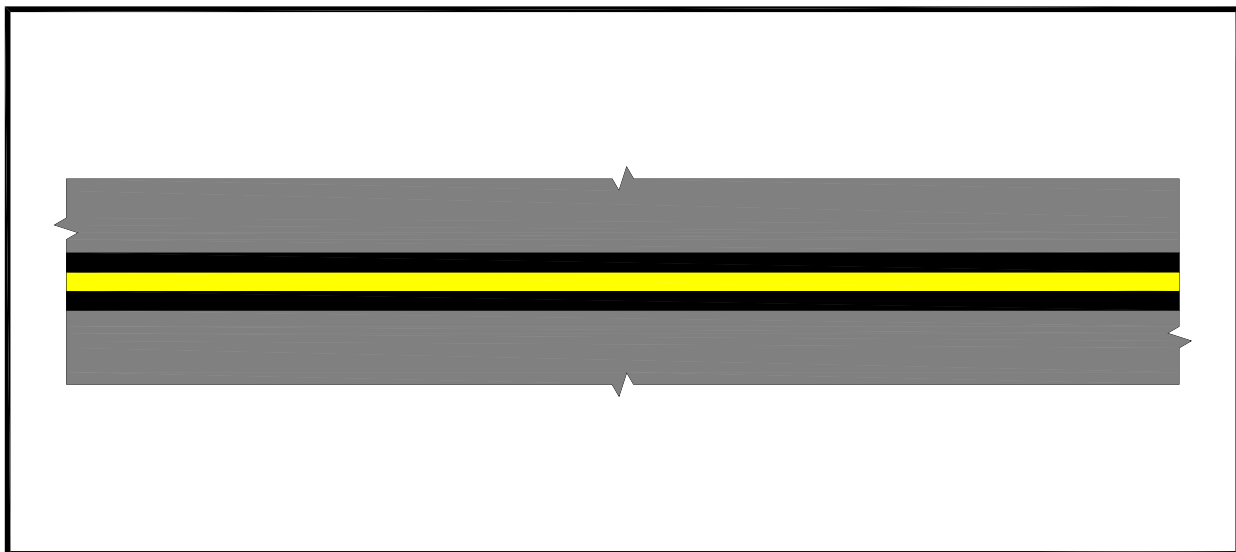

Figure C-7. Intermediate Holding Position Markings

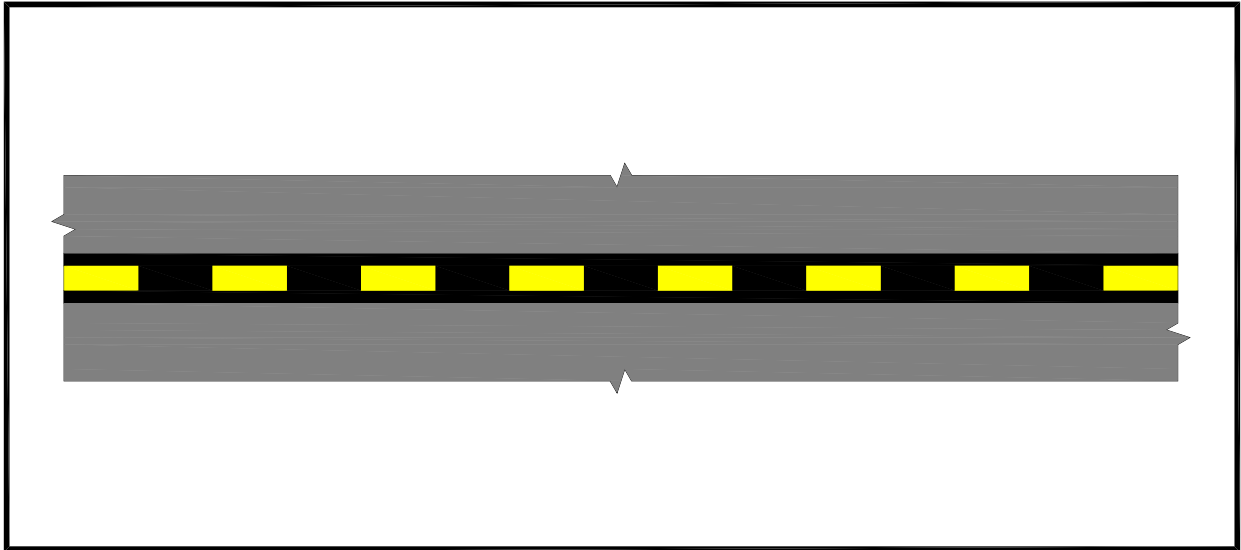
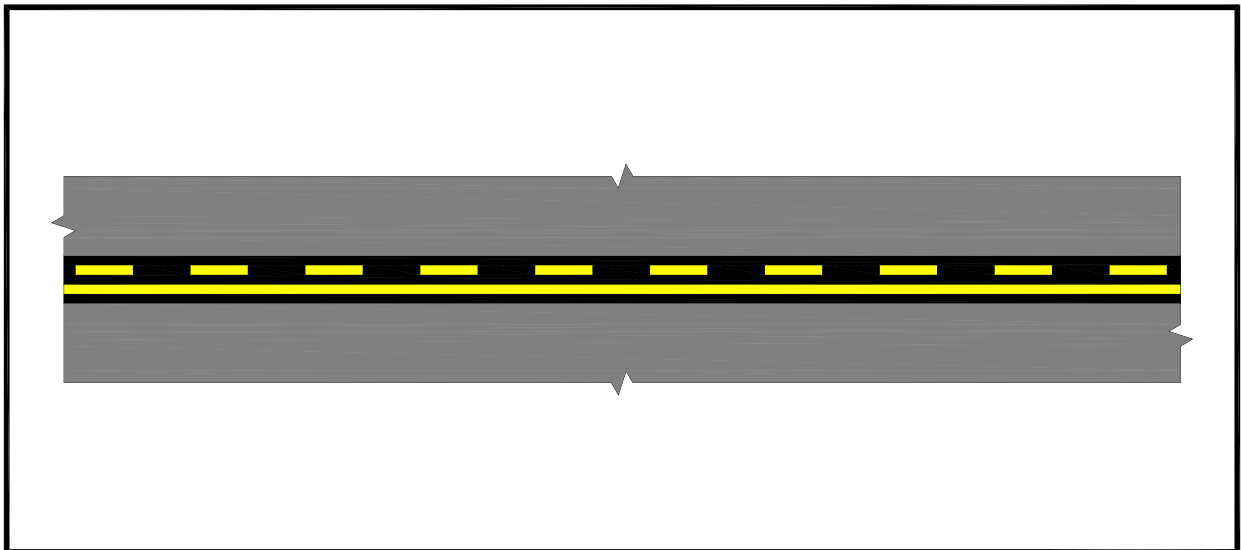

Figure C-8. Non-Movement Area Boundary Marking



APPENDIX D. ENHANCED MARKINGS FOR RUNWAY HOLDING POSITION

D.1 General.

D.1.1 Enhanced taxiway markings are intended to provide additional visual cues to taxiing pilots to help them identify the location of the runway holding position. This appendix provides standards for these enhanced markings and guidance, including examples, on where to use the enhanced markings.

D.1.2 The figures included in this appendix are not drawn to scale.

D.2 Applicability.

The guidelines and standards for enhanced taxiway markings contained in this appendix may be used as a runway incursion prevention initiative. They may be used in combination or separately with existing taxiway markings. However, all intersections at an airport must use the same combination of markings.

D.3 Enhanced Taxiway Centerline Markings.

Figure D-1. Enhanced Taxiway Centerline Marking on Curved Taxiway

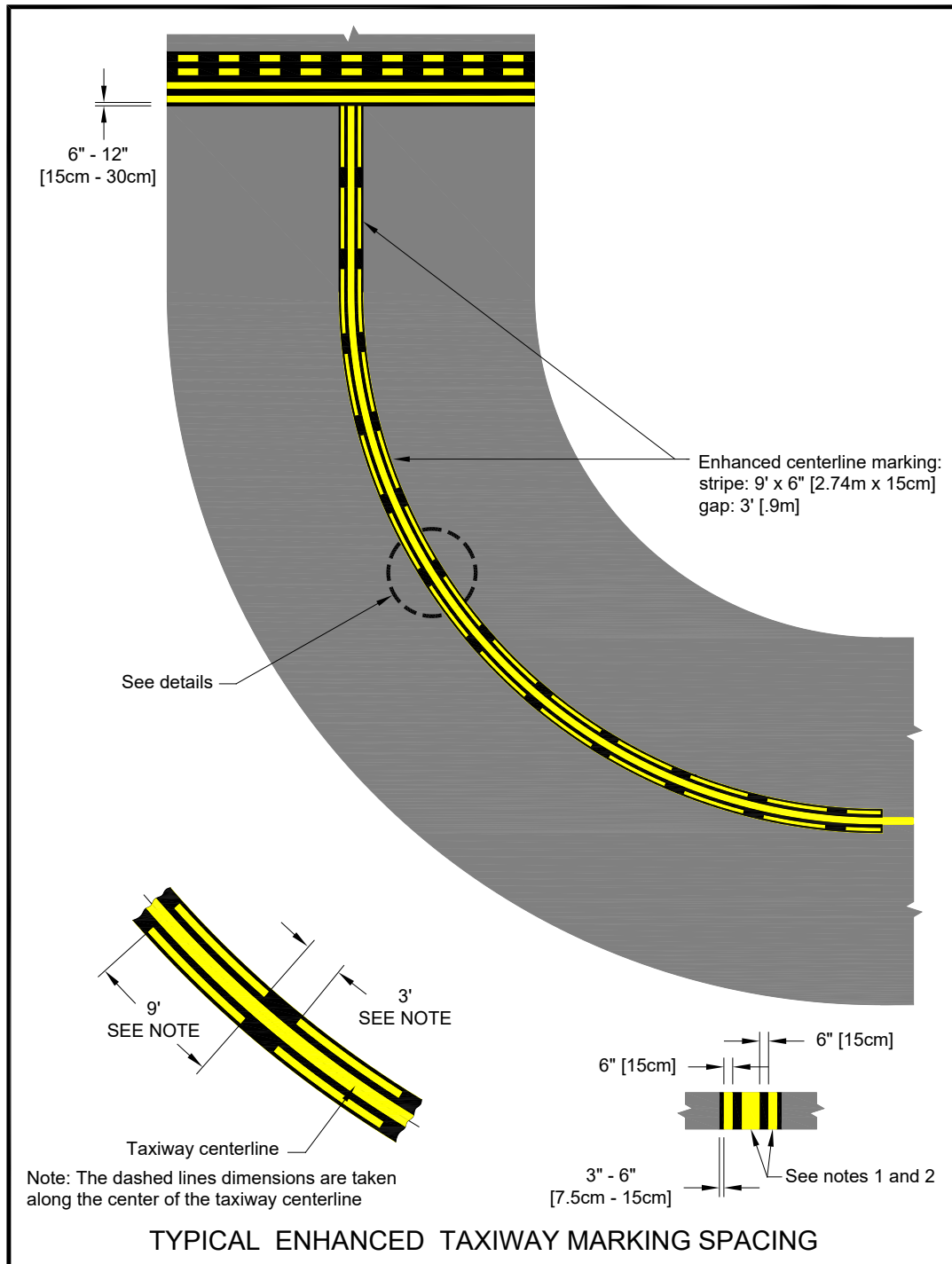

Notes:

1. Dashed lines for the enhanced taxiway centerline marking are 6 inches (15cm) in width and separated 6 inches (15 cm) from the taxiway centerline. This applies to both 6 inches (15 cm) and 12 inches (30 cm) taxiway centerline markings.
2. The taxiway centerline markings may be shifted left or right to avoid interference with the taxiway centerline lights.

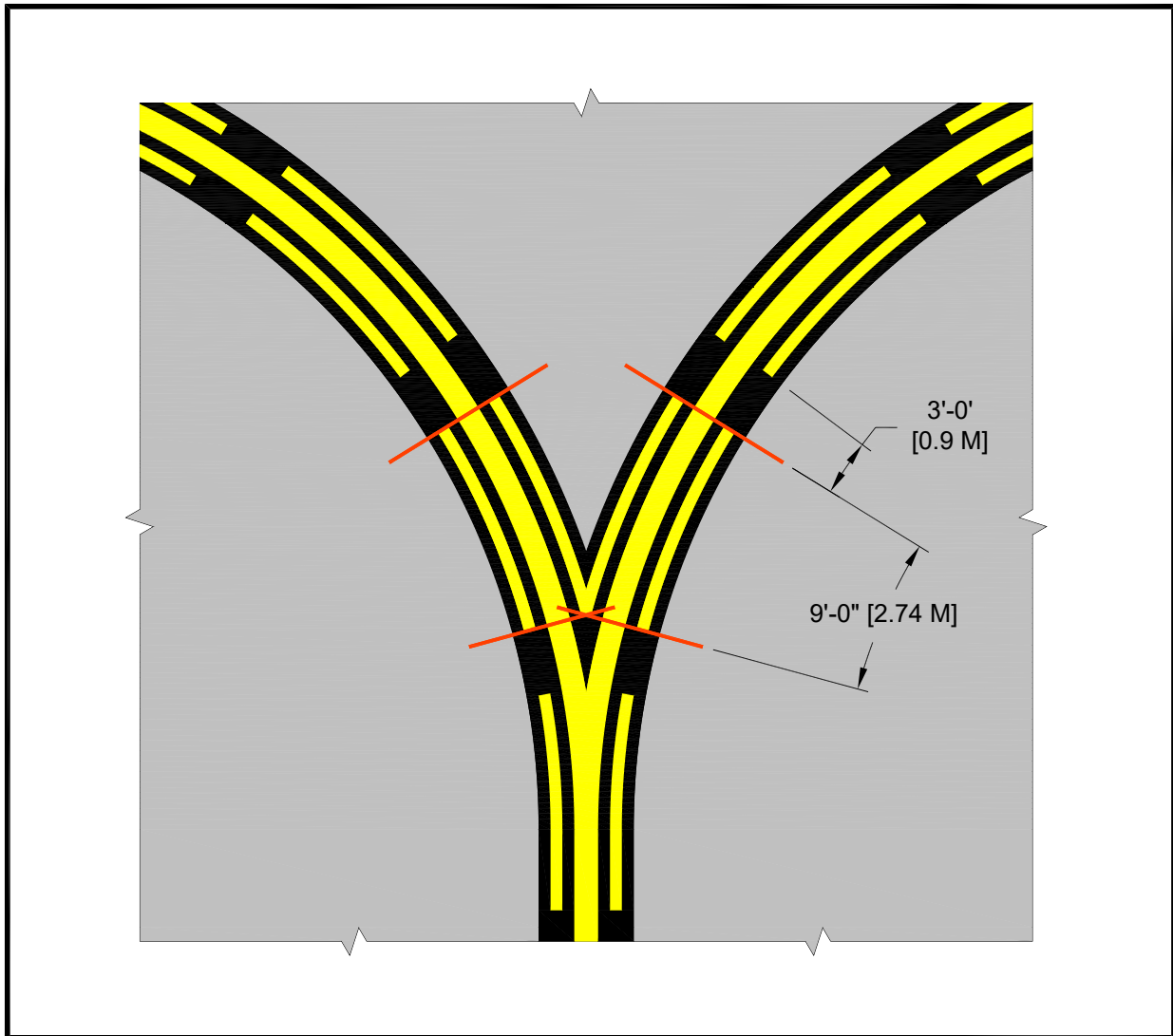
Figure D-2. Dashed Lines at Converging Taxiway Centerlines**Notes:**

1. As shown in this case the V-shaped inner dashes start and stop with the outside 9-foot (3 m) dashes. - However, this may not always be the case for the inner dashes. If the v-shaped are less than 5 feet (1.5 m) they may be omitted.
2. Measurements are taken along the center of the centerline stripe.

Figure D-3. Converging, Straight, and Curved Enhanced Taxiway Centerlines Intersecting with Holding Position Marking

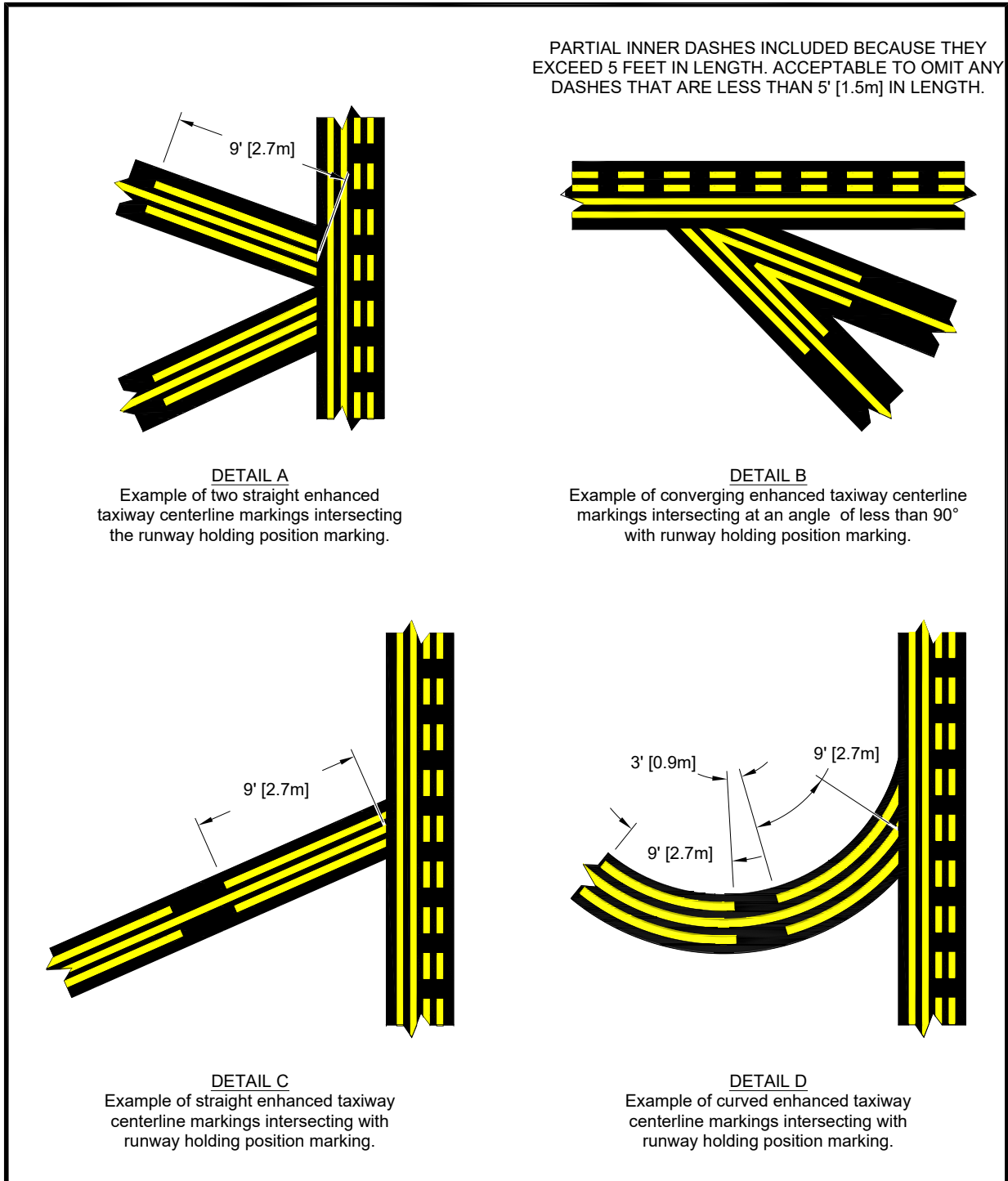

Note: All measurements are taken along the center of the centerline.

D.4 Extended Runway Holding Position Markings.

The extended runway holding position marking, applicable only to those taxiway entrances that serve Airplane Design Group (ADG) V or VI airplanes, measures 125 feet (38 m) from one paved shoulder to the other paved shoulder, i.e., 62.5 feet (19 m) from the main taxiway centerline. Figure D-4 illustrates the extended surface marking on a standard 75-foot (23-m) wide taxiway with a standard 35-foot (10.5-m) wide taxiway shoulder for TDG-6. For taxiways wider than 75 feet (22.9 m) that connect to the runways that serve ADG V or VI aircraft, the holding position line is extended so it is 25 feet (7.5 m) on both paved taxiway shoulders.

Figure D-4. Extended Runway Holding Position Markings on Taxiways

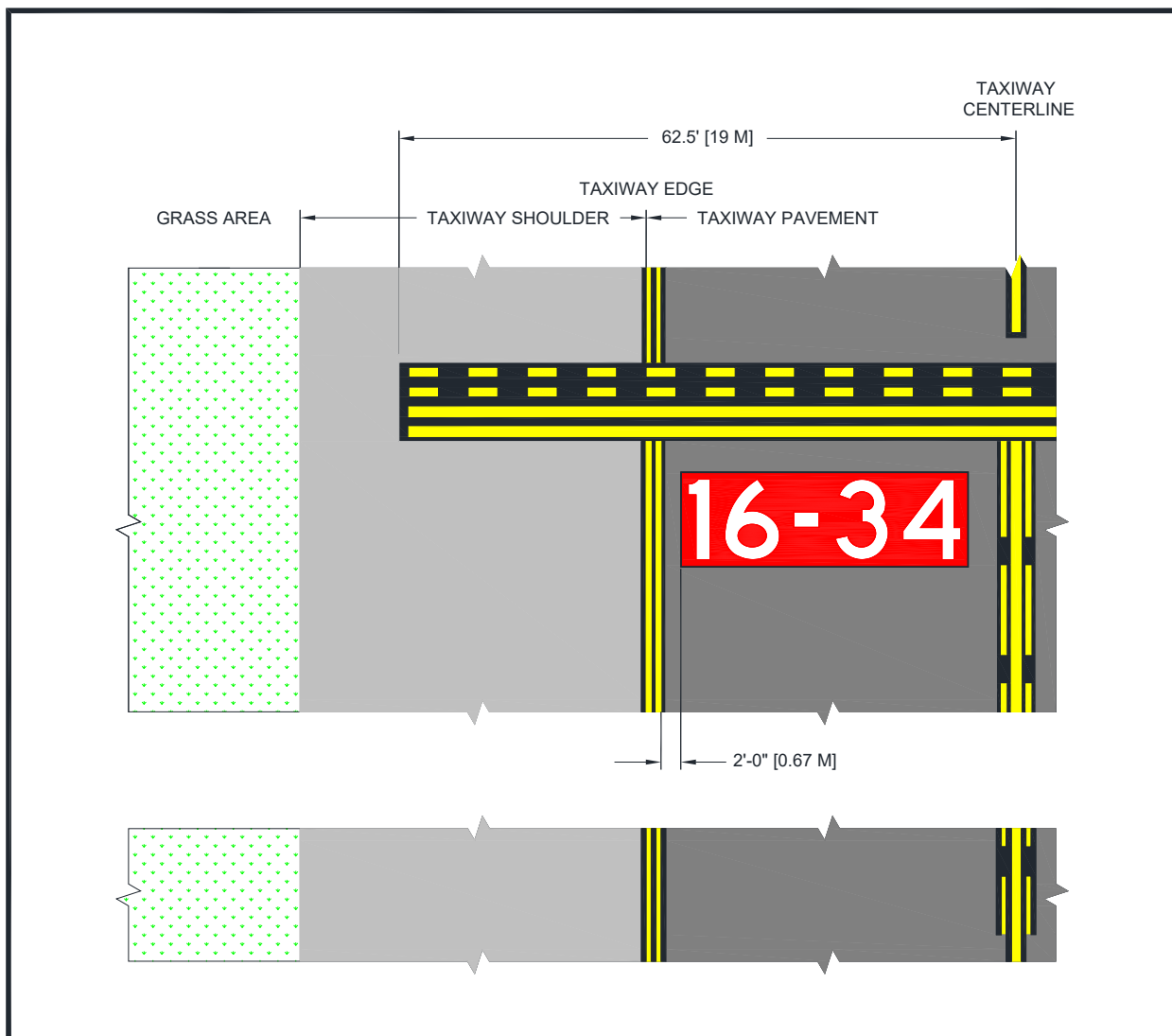

D.5 Surface Painted Holding Position Signs.

Figure D-5. Surface Painted Holding Position Signs for Taxiway Widths Greater than 35 Feet (10.5 m)

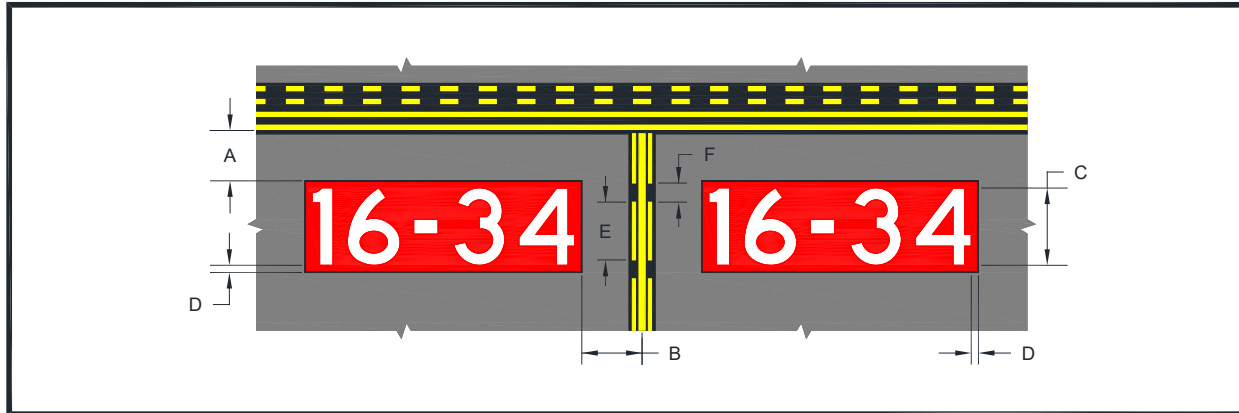

Table D-1. Notes for Figure D-5

Dimension Letter	Dimension feet (meters)	Notes
A	2 – 4 (0.67 – 1.34)	The SPHPS to the right of the taxiway centerline is not always required in most cases.
B	3 – 10 (0.91 – 3.0)	
C	9 – 12 (2.75 – 3.7)	Inscriptions must have a height of 12 feet (3.7 m); however, the height may be reduced, as necessary, to the minimum height of 9 feet (2.75 m). In special situations, the surface painted marking may be reduced to less than 9 feet (2.75 m) in order to fit the marking appropriately. Examples of special situations include taxiways with widths narrower than 75 feet (22.9 m) or taxiways that need to display multiple runway designations with arrows. In all cases, inscriptions follow Appendix B inscription criteria. All other taxiway entrances to the same runway not needing the reduction are to maintain the 12-foot (3.7 m) height dimension. For practicality, the lowest height reduction is 6 feet (1.8 m). In all cases, the dimension D is not reduced.
D	15 inches (38 cm)	
E	9 (2.75)	
F	3 (0.91)	
		See subparagraphs in paragraph 4.2.5.1 for selecting 6-inch (15 cm) or 12-inch (30 cm) taxiway centerline widths.

Figure D-6. Surface Painted Holding Position Sign for Taxiway Widths Equal to or Less than 35 feet (10.5 m)

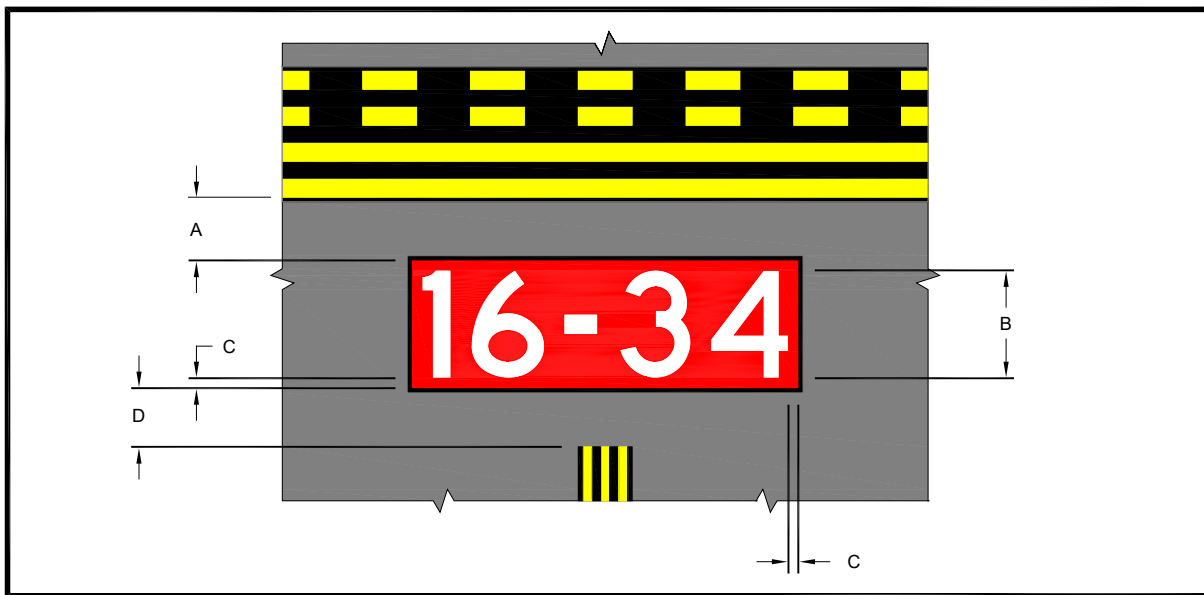

Table D-2. NOTES for Figure D-6

Dimension Letter	Dimension feet (meters)	Notes
A	2 – 3 (0.67 – 0.91)	
B	6 (1.8)	Inscriptions follow <u>Appendix B</u> inscription criteria. The size of the sign inscription is scaled to fit taxiways 35 feet (10.5 m) or less in width for TDG-1A, TDG-1B, and TDG-2. Reference <u>AC 150/5300-13</u> . In special situations, the surface marking may be reduced to less than 6 feet (1.8 m) in order to fit the marking appropriately. Examples of special situations include taxiways that need to display multiple runway designations with arrows. In all cases, the inscriptions follow <u>Appendix B</u> inscription criteria. All other taxiway entrances to the same runway not needing the reduction are to maintain the 6-foot (1.8-m) height dimension. For practicality, the lowest height reduction is 3 feet (0.91 m).
C	7.5 inches (19 cm)	
D	36 inches (0.91)	The dimension is measured without any black border., i.e., red to yellow.
NOTE		The dimensions for the enhanced taxiway centerline are in <u>Figure D-1</u> .
		See subparagraphs in paragraph 4.2.5.1 for selecting 6-inch (15 cm) or 12-inch (30 cm) taxiway centerline widths.
		The first set of dashes can vary in length (their placement from Pattern A) due to the placement of the SPHPS from the Pattern A runway holding position marking. In all cases the total length continues to be 150 feet (45.7 m).

Figure D-7. Surface Painted Holding Position Signs When Taxiway Centerline is Not Perpendicular to Runway Holding Position Marking

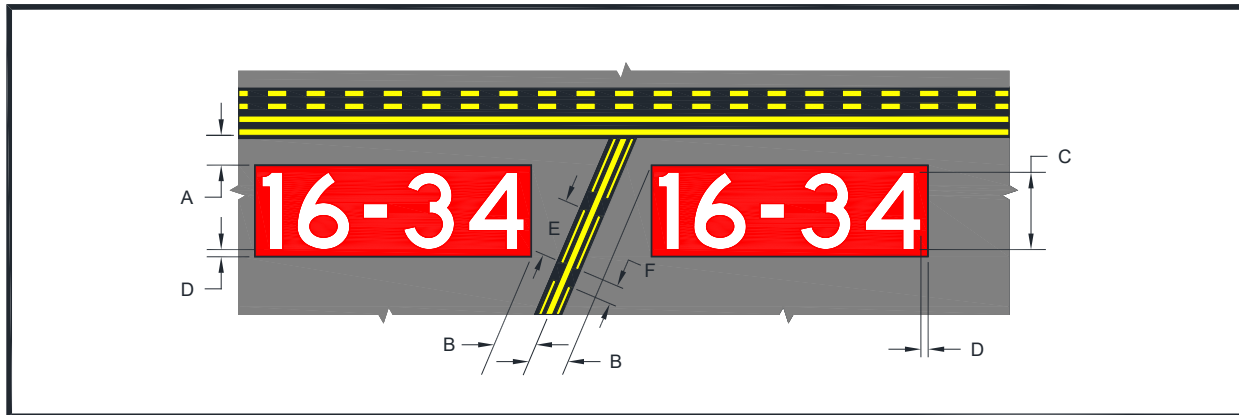

Table D-3. NOTES for Figure D-7

Dimension Letter	Dimension feet (meters)	Notes
A	2 – 4 (0.67 – 1.34)	The SPHPS to the right of the taxiway centerline is not always required in most cases.
B	3 – 10 (0.91 – 3.0)	
C	9 – 12 (2.75 – 3.7)	Inscriptions must have a height of 12 feet (3.7 m); however, the height may be reduced, as necessary, to the minimum height of 9 feet (2.75 m). In special situations, the surface painted marking may be reduced to less than 9 feet (2.75 m) in order to fit the marking appropriately. Examples of special situations include taxiways with widths narrower than 75 feet (22.9 m) or taxiways that need to display multiple runway designations with arrows. In all cases, inscriptions follow Appendix B inscription criteria. All other taxiway entrances to the same runway not needing the reduction are to maintain the 12-foot (3.7-m) height dimension. For practicality, the lowest height reduction is 6 feet (1.8 m). In all cases, the dimension D is not reduced.
D	15 inches (38 cm)	
E	9 (2.75)	
F	3 (0.91)	
		See subparagraphs in paragraph 4.2.5.1 for selecting 6-inch (15 cm) or 12-inch (30 cm) taxiway centerline widths.

Figure D-8. Surface Painted Holding Position Signs Co-Located with Geographic Position Marking

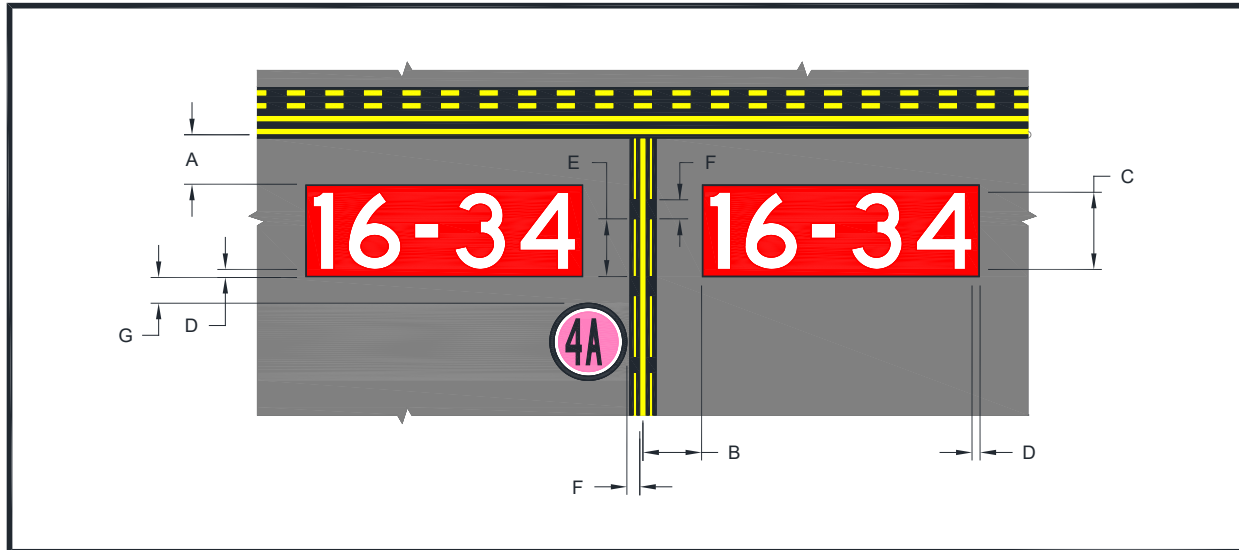

Table D-4. Notes for Figure D-8

Dimension Letter	Dimension feet (meters)	Notes
A	2 – 4 (0.67 – 1.34)	The SPHPS to the right of the taxiway centerline is not always required.
B	3 – 10 (0.91 – 3.0)	
C	9 – 12 (2.75 – 3.7)	Inscriptions must have a height of 12 feet (3.7 m); however, the height may be reduced, as necessary, to the minimum height of 9 feet (2.75 m). In special situations, the surface painted marking may be reduced to less than 9 feet (2.75 m) in order to fit the marking appropriately. Examples include taxiways with widths narrower than 75 feet (22.9 m) or taxiways that need to display multiple runway designations with arrows. In all cases, the inscriptions follow Appendix B inscription criteria. All other taxiway entrances to the same runway not needing the reduction are to maintain the 12-foot (3.7-m) height dimension. For practicality, the lowest height reduction is 6 feet (1.8 m). In all cases, the dimension D is not reduced.
D	15 inches (38 cm)	
E	9 (2.75)	
F	3 (0.91)	
G	4 (1.3)	From edge of red border
H	2 (0.65)	From outermost edge of main yellow taxiway centerline
		See subparagraphs in paragraph 4.2.5.1 for selecting 6-inch (15 cm) or 12-inch (30 cm) taxiway centerline widths.

Note: Because the geographic position marking cannot be located at a runway holding position for the low-visibility runway (see paragraph [4.11](#)), this figure applies only where the designated taxi route for low-visibility operations crosses a runway that is not itself the low-visibility runway.

D.5.1 Additional Guidelines for Application.

The following illustrations provide examples of various runway holding position locations using the enhanced markings. The figures included in this appendix are not drawn to scale.

D.5.2 Two Taxiway Centerlines Converging at a Runway Holding Position Marking.

Where two taxiway centerlines converge at a runway holding position marking, the surface painted holding position signs must be installed parallel to the runway holding position marking. As shown in Figure D-9, only one sign on either side of the two taxiway centerlines is practical.

Figure D-9. Two Taxiway Centerlines Converging at a Runway Holding Position Marking

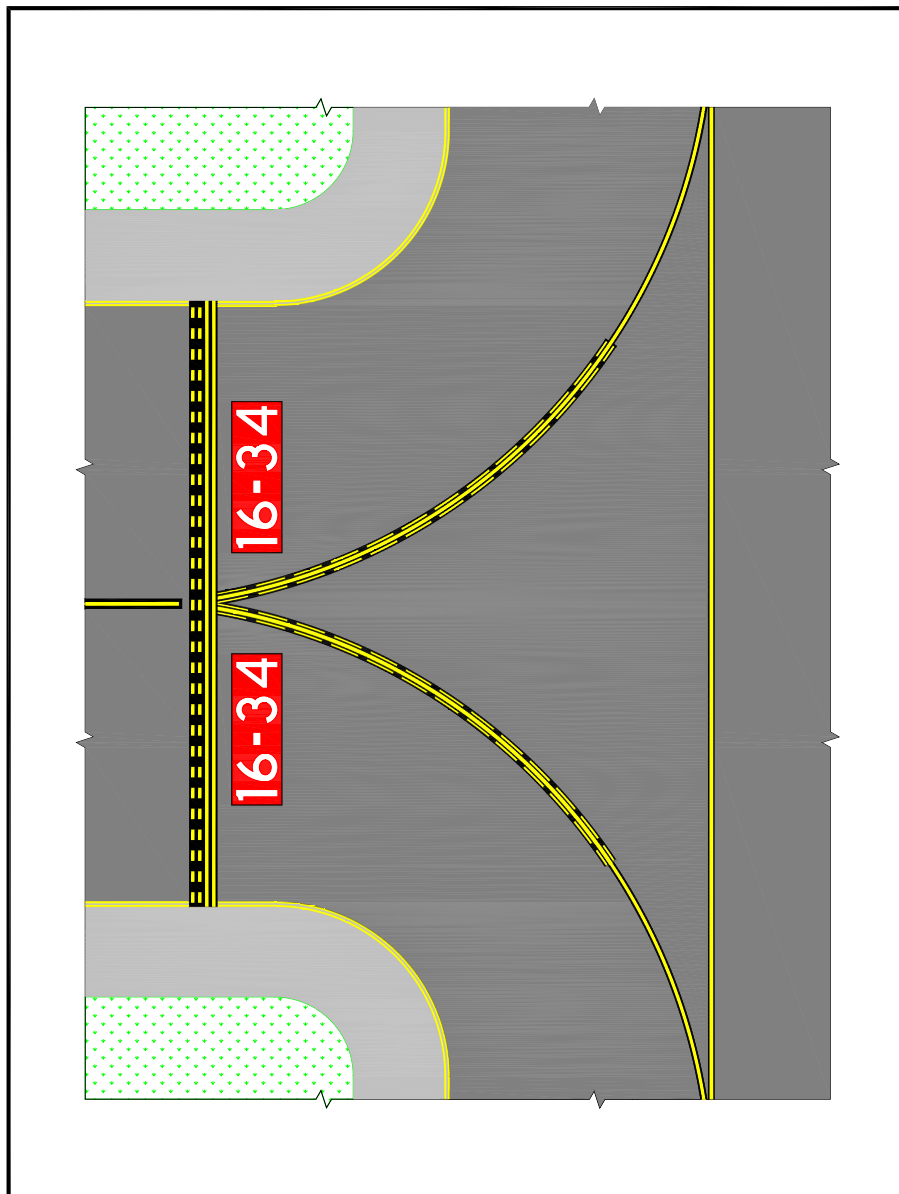

D.5.3 Intersection of Two Taxiways at Runway End.

In the case of two converging taxiway centerlines, surface painted holding position signs containing a single runway designator must be positioned parallel to the runway holding position marking, as shown in Figure D-10.

Figure D-10. Intersection of Two Taxiways at Runway End

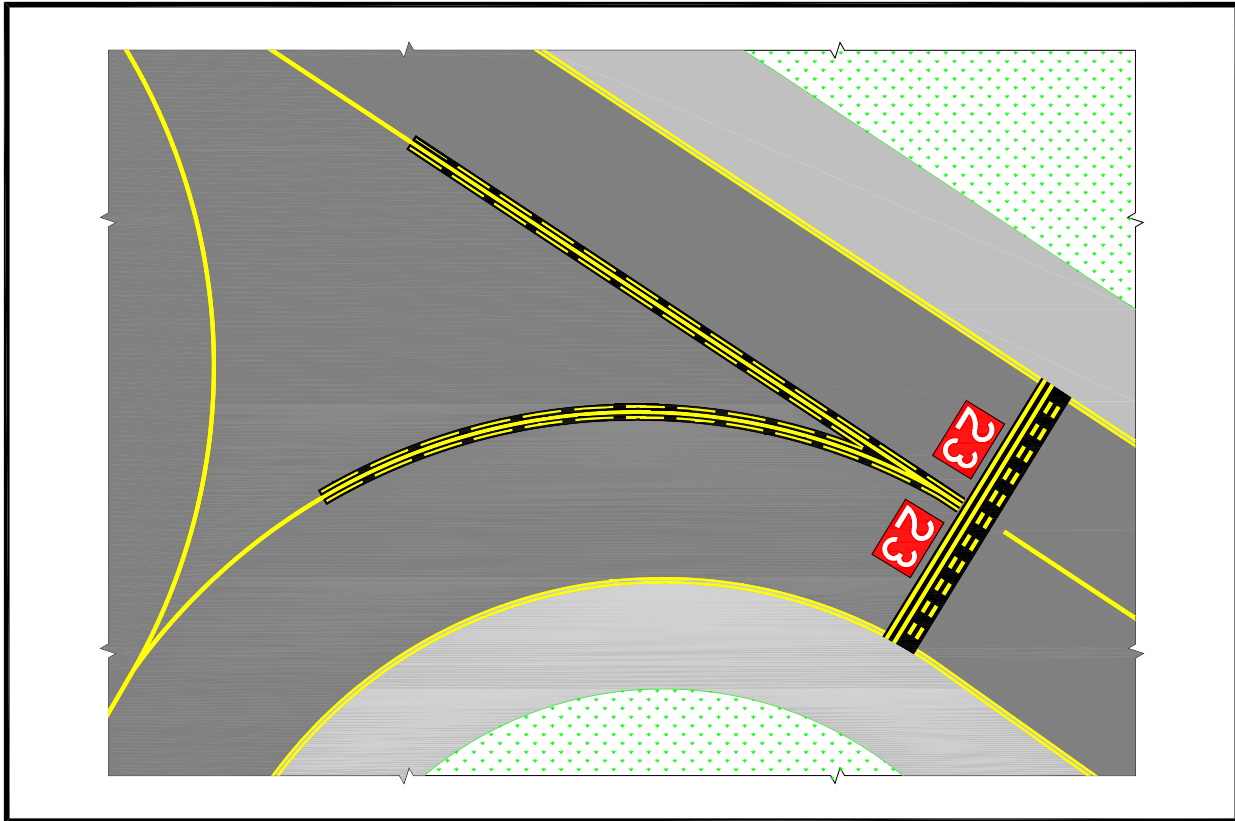

D.5.4 Intersection of Three Converging Taxiway Centerlines.

Figure D-11 illustrates taxiway centerline configurations when there are three converging centerlines.

Figure D-11. Intersection of Three Converging Taxiway Centerlines

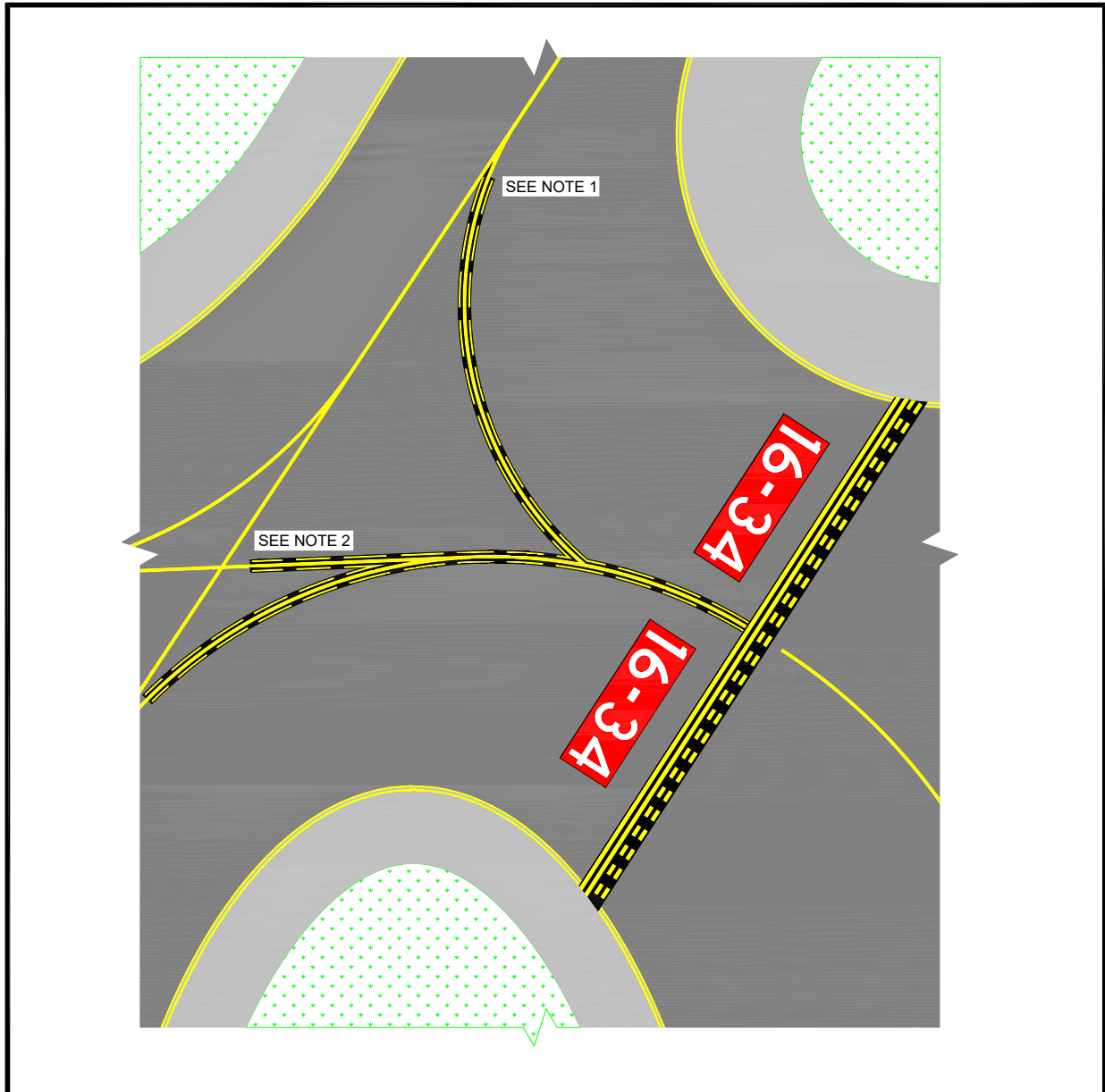
**Notes:**

1. Enhancement is tangent to merging curve.
2. Enhancement terminates 5 feet (1.5 m) from intersection.

D.5.5 Intersection of Multi-Taxiway Centerlines with Less Than 150 Feet (45.7 m) Between Taxiways.

Figure D-12 illustrates different taxiway centerline configurations when there are three converging centerlines, less than 150 feet (45.7 m) between the runway holding position markings, and potential difficulty in positioning surface painted holding position signs in the available space.

Figure D-12. Intersection of Multi-Taxiway Centerlines With Less Than 150 feet (45.7 m) Between Taxiways

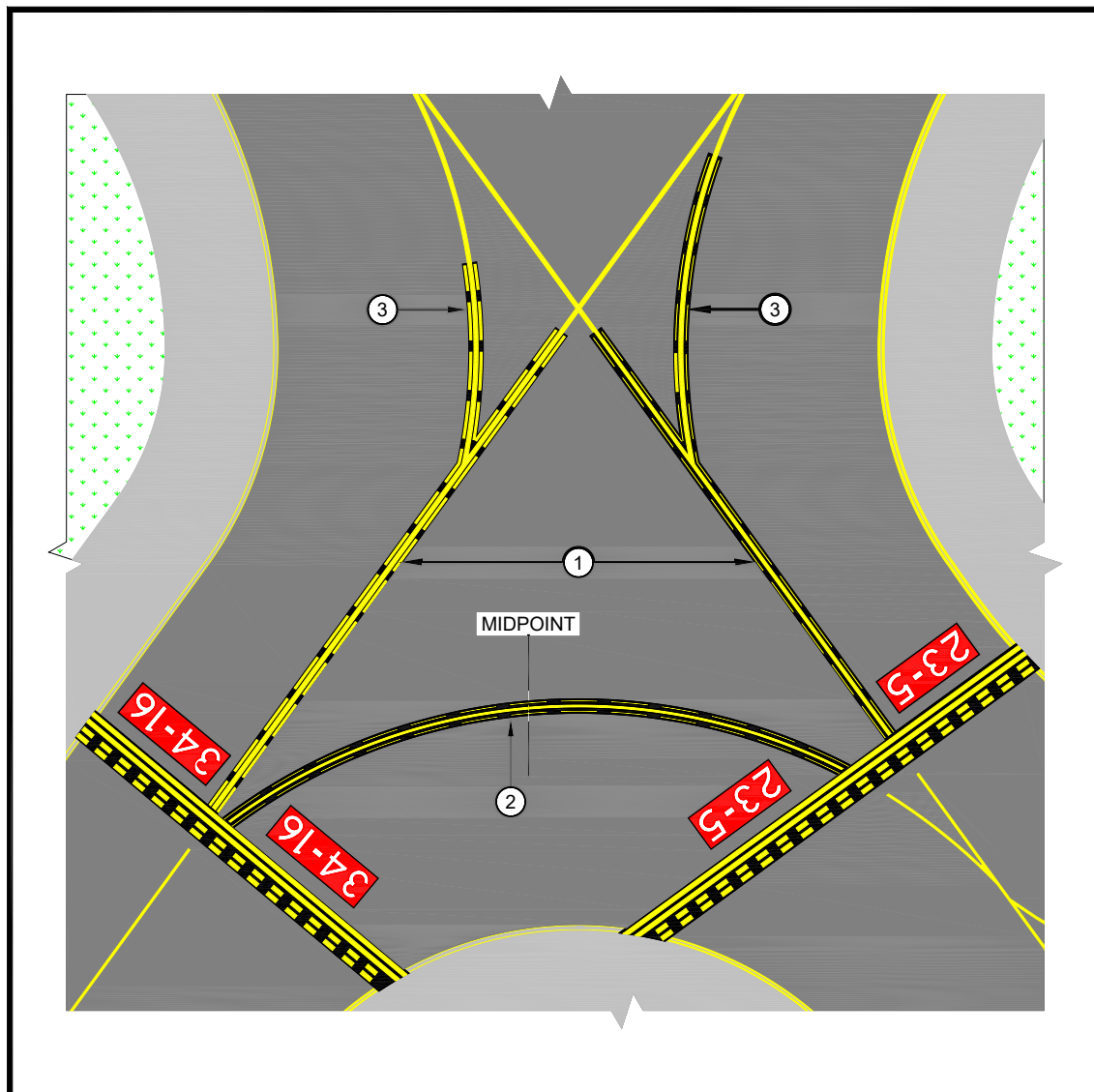

Notes:

1. Illustrates perpendicular taxiway centerlines less than 150 feet (45.7 m) (see paragraph 4.3.4).
2. Illustrates a curved taxiway centerline between two runway holding position markings with less than 300 feet (91.4 m) along the taxiway centerline (see paragraph 4.3.4).
3. Illustrates a converging taxiway centerline curving toward two runway holding positions.

D.5.6 Two Taxiway Centerlines Intersecting a Runway Holding Position Marking.

Figure D-13 illustrates an angled runway holding position marking that is intersected by two taxiway centerlines.

Figure D-13. Two Taxiway Centerlines Intersecting a Runway Holding Position Marking

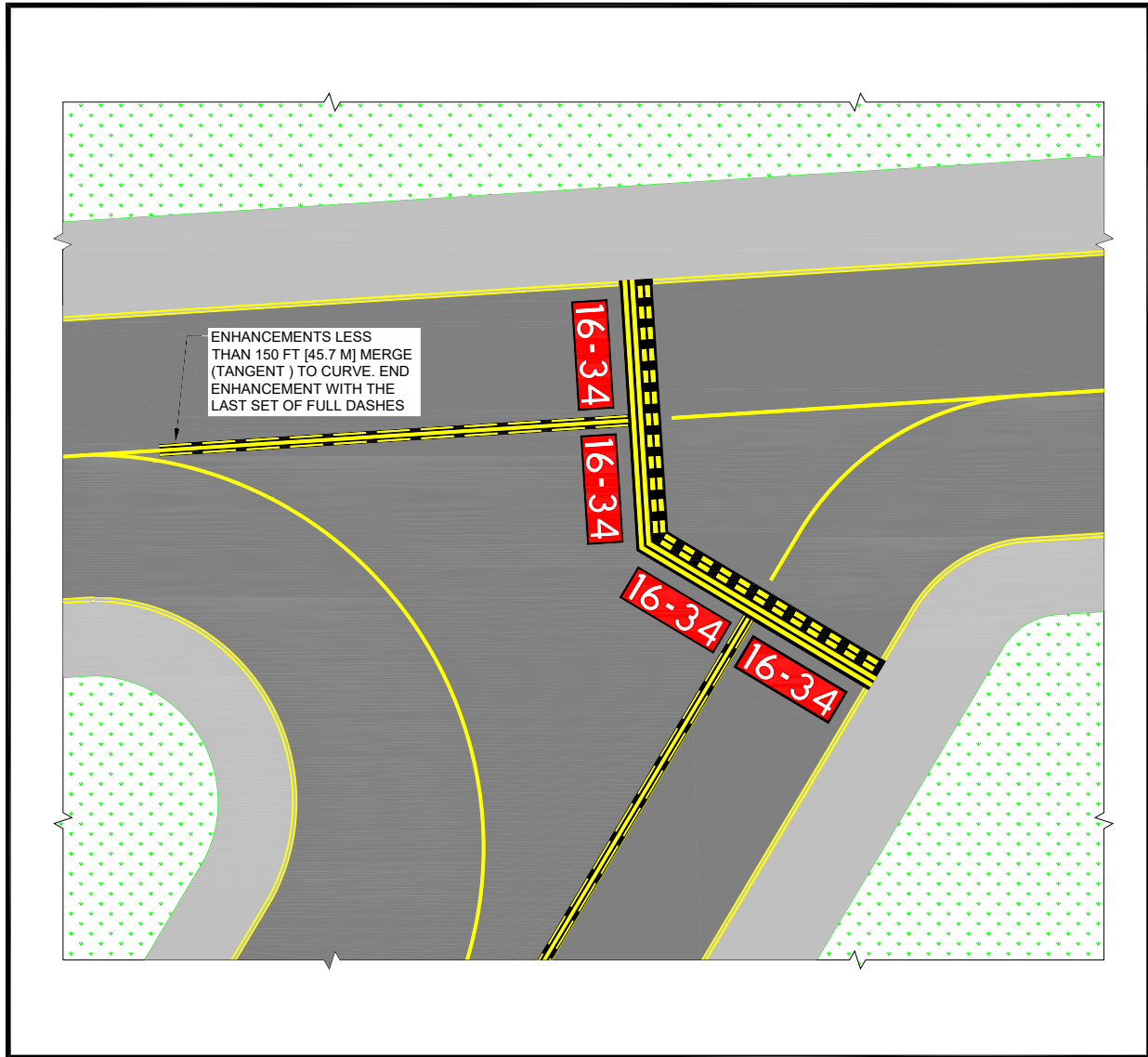

D.5.7 Intersection of Stub Taxiway and Runway.

Figure D-14 illustrates a solution for a stub taxiway that is less than 150 feet (45.7 m) long, with a 90-degree turn and angled taxiway shoulder areas. Per paragraph 4.3.4, the enhancement terminates 5 feet (1.5 m) from a taxiway/taxiway intersection.

Figure D-14. Intersection of Stub Taxiway and Runway

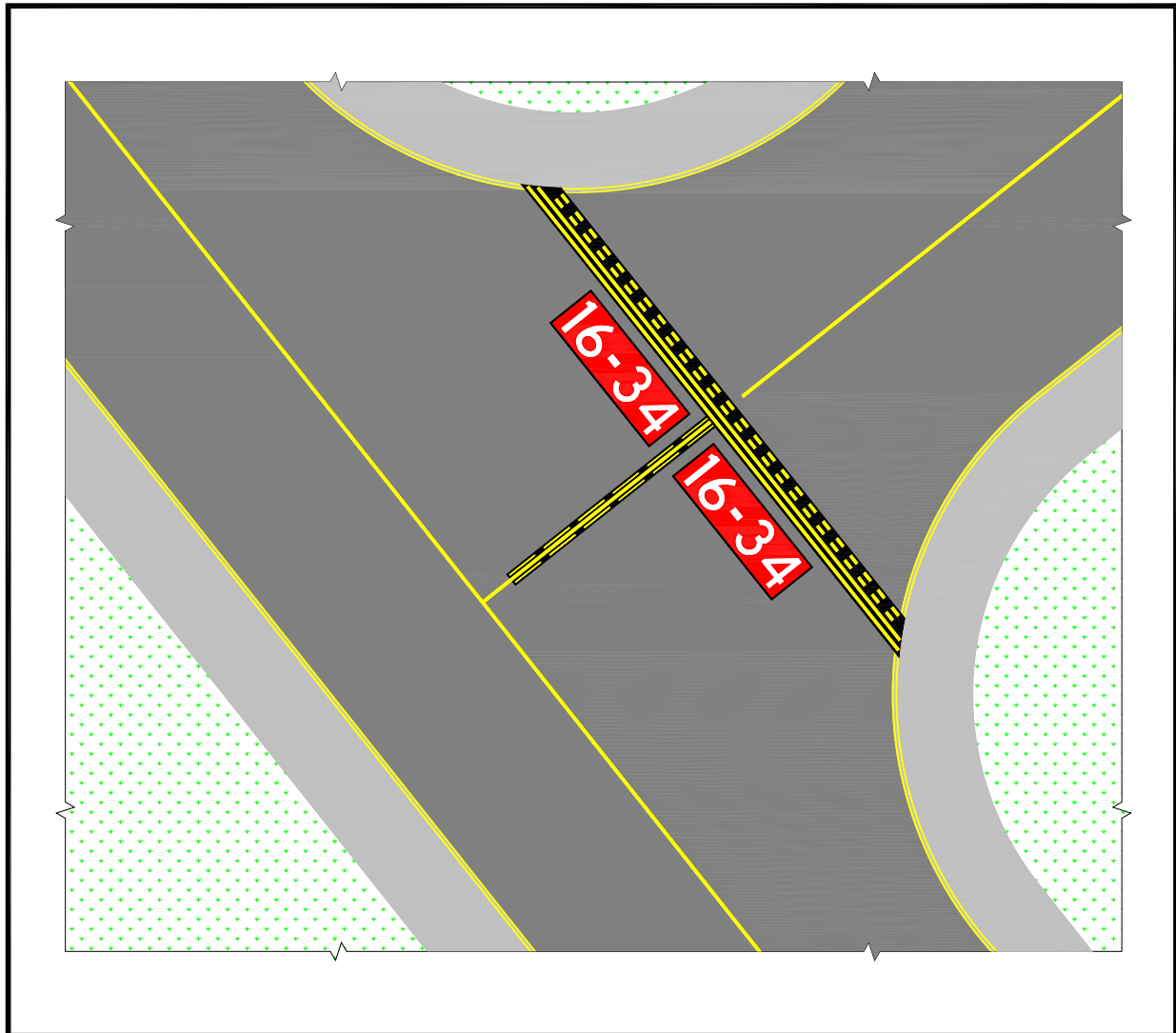
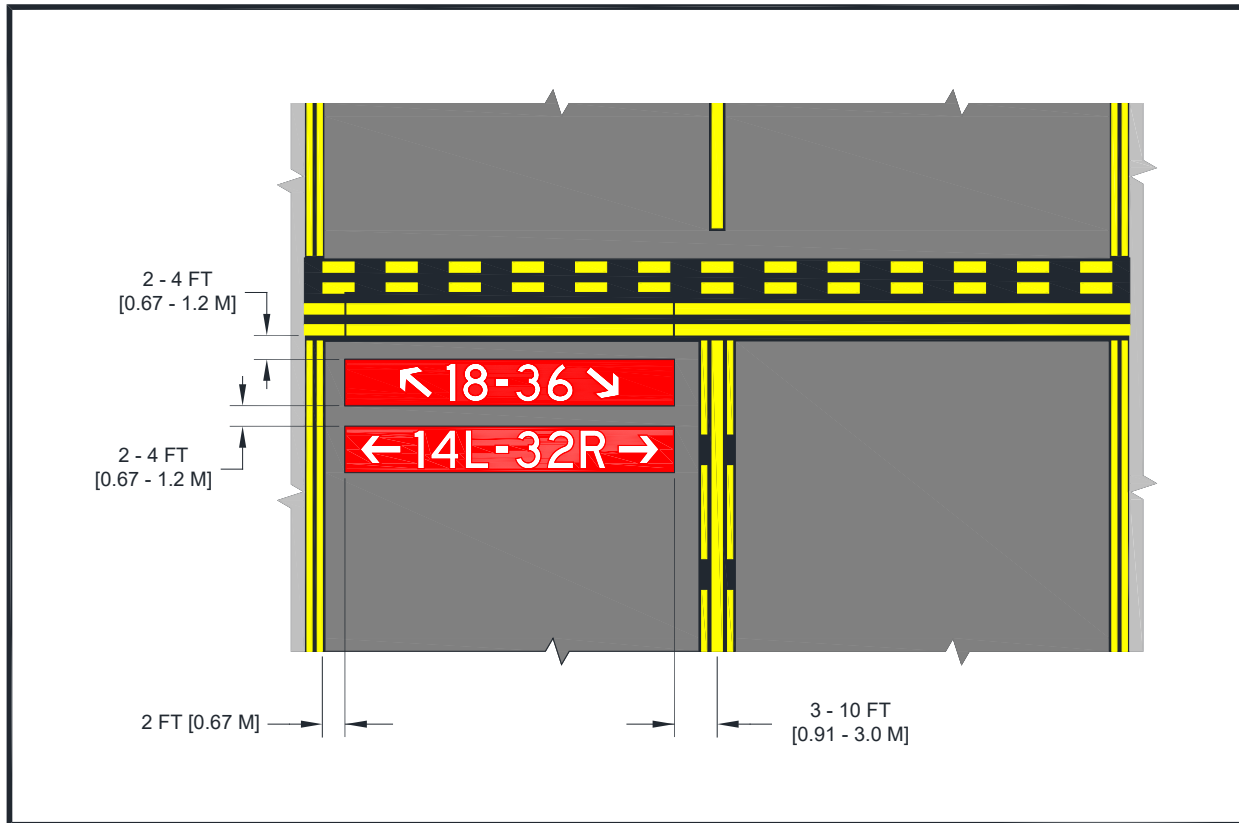
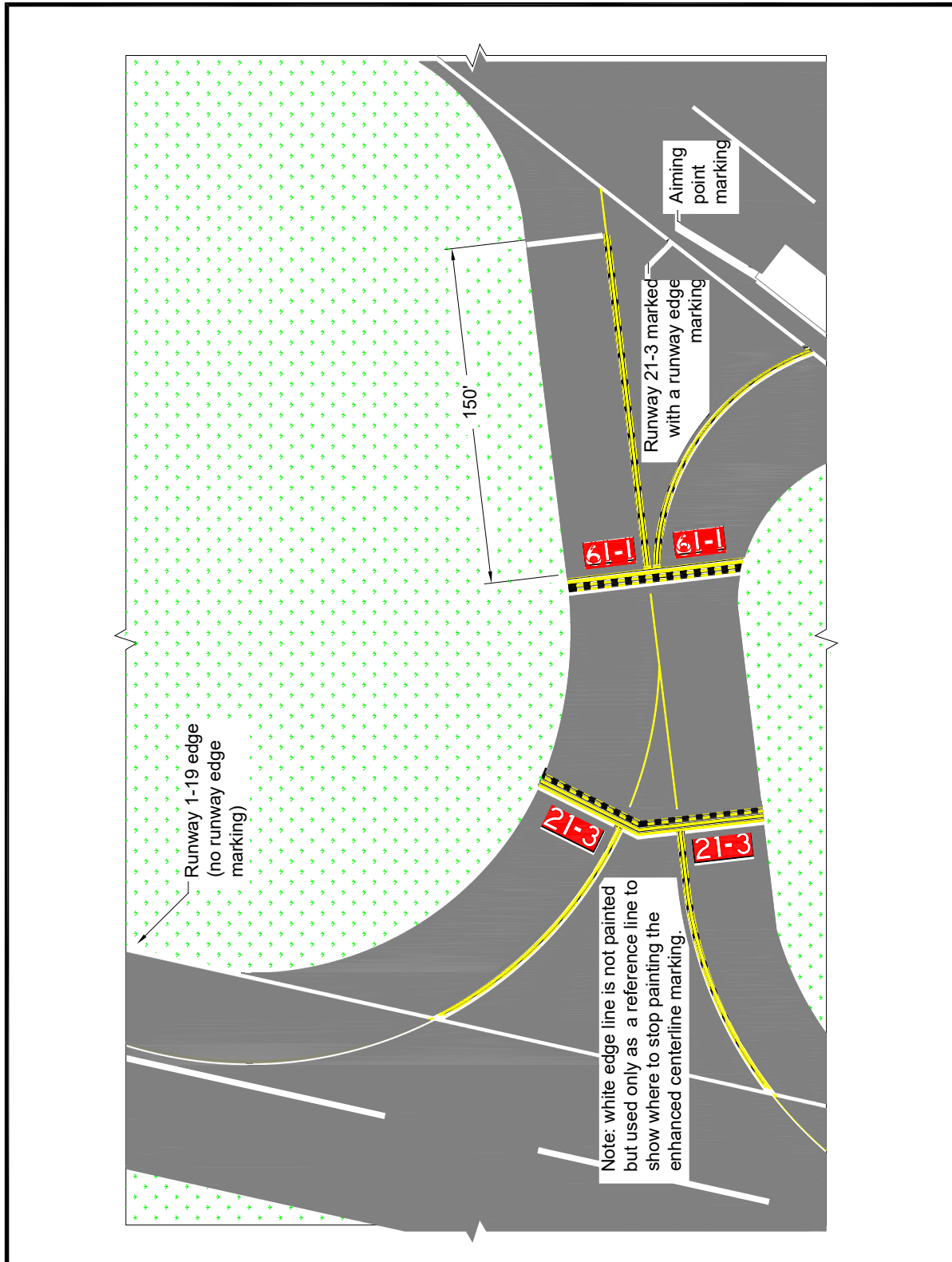

Figure D-15. Narrow Taxiway Stacked Surface Painted Holding Position Sign**Notes:**

1. Stacked surface painted holding position signs for narrow taxiways - only to be used per paragraph 4.5.4.2.
2. The recommended order of appearance follows:
 - a. If the “stacked” surface painted holding position signs are for a taxiway that clearly accesses one runway (for example, RWY 14L-32R) before another runway (RWY 18-36), then the order of appearance is from “bottom up” as shown above.
 - b. If the “stacked” surface painted holding position signs are for a taxiway that equally offers access to two or more runways, then follow a “clockwise” order of appearance as viewed for the holding position. Hence, the bottom surface painted holding position sign is the first runway as viewed from the holding position. This practice follows the signage convention.
3. For taxiways less than or equal to 35’ wide, the stacked surface painted holding position signs are located centered on the taxiway in accordance with Figure D-6.

Figure D-16. Enhanced Taxiway Centerlines When a Taxiway Connects Closely Spaced Runways



Page Intentionally Blank

Advisory Circular Feedback

If you find an error in this AC, have recommendations for improving it, or have suggestions for new items/subjects to be added, you may let us know by (1) mailing this form to Manager, Airport Safety and Operations Division, Federal Aviation Administration ATTN: AAS-100, 800 Independence Avenue SW, Washington DC 20591 or (2) faxing it to the attention of the Office of Airport Safety and Standards at (202) 267-5383.

Subject: AC 150/5340-1M, Change 1

Date: _____

Please check all appropriate line items:

An error (procedural or typographical) has been noted in paragraph _____ on page _____.

Recommend paragraph _____ on page _____ be changed as follows:

In a future change to this AC, please cover the following subject:
(Briefly describe what you want added.)

Other comments:

I would like to discuss the above. Please contact me at (phone number, email address).

Submitted by: _____

Date: _____