



U.S. Department  
of Transportation  
Federal Aviation  
Administration

# Advisory Circular

**Subject:** Non-Towered Airport Flight  
Operations

**Date:** 2/25/19

**AC No:** 90-66B

**Initiated by:** AFS-800

**Change:** 1

**1. PURPOSE OF THIS ADVISORY CIRCULAR (AC).** This AC calls attention to regulatory requirements, recommended operations, and communications procedures for operating at an airport without a control tower or an airport with a control tower that operates only part time. It recommends traffic patterns, communications phraseology, and operational procedures for use by aircraft, lighter-than-air aircraft, gliders, parachutes, rotorcraft, and ultralight vehicles. This AC stresses safety as the primary objective in these operations. This AC is related to the right-of-way rules under Title 14 of the Code of Federal Regulations (14 CFR) part 1, § 1.1 (traffic pattern), and part 91, §§ 91.113 and 91.126.

**2. PRINCIPAL CHANGES.** This change incorporates new information in paragraphs 9 thru 12 to clarify some of the operational techniques and requirements at non-towered airports.

## PAGE CONTROL CHART

Remove Pages	Dated	Insert Pages	Dated
Pages 3 thru 5	3/13/18	Pages 3 thru 5	2/25/19
Pages 7 thru 13	3/13/18	Pages 7 thru 13	2/25/19

Robert C. Carty  
Deputy Executive Director, Flight Standards Service



U.S. Department  
of Transportation  
Federal Aviation  
Administration

# Advisory Circular

**Subject:** Non-Towered Airport Flight  
Operations

**Date:** 3/13/18

**AC No:** 90-66B

**Initiated by:** AFS-800

**Change:**

- 1 PURPOSE OF THIS ADVISORY CIRCULAR (AC).** This AC calls attention to regulatory requirements, recommended operations, and communications procedures for operating at an airport without a control tower or an airport with a control tower that operates only part time. It recommends traffic patterns, communications phraseology, and operational procedures for use by aircraft, lighter-than-air aircraft, gliders, parachutes, rotorcraft, and ultralight vehicles. This AC stresses safety as the primary objective in these operations. This AC is related to the right-of-way rules under Title 14 of the Code of Federal Regulations (14 CFR) part [1](#), § [1.1](#) (traffic pattern), and part [91](#), §§ [91.113](#) and [91.126](#).
  - 2 AUDIENCE.** This AC applies to aircraft operators operating at or in the vicinity of an airport without a control tower or an airport with a control tower that operates only part time.
  - 3 WHERE YOU CAN FIND THIS AC.** You can find this AC on the Federal Aviation Administration's (FAA) website at [http://www.faa.gov/regulations\\_policies/advisory\\_circulars](http://www.faa.gov/regulations_policies/advisory_circulars).
  - 4 WHAT THIS AC CANCELS.** AC 90-66A, Recommended Standard Traffic Patterns and Practices for Aeronautical Operations at Airports Without Operating Control Towers, dated August 26, 1993; and AC 90-42F, Traffic Advisory Practices at Airports Without Operating Control Towers, dated May 21, 1990, are canceled.
  - 5 PRINCIPAL CHANGES.** This AC has been updated to reflect current procedures and best practices at airports without operating control towers and includes relevant material from AC 90-42F.
  - 6 DEFINITIONS.**
    - 6.1 Airports Without Operating Control Towers.** Airports without control towers or airports with control towers that are not operating. These airports are commonly referred to as non-towered or part-time-towered airports. Another term commonly used is "uncontrolled airport."
    - 6.2 Common Traffic Advisory Frequency (CTAF).** A frequency designed for the purpose of carrying out airport advisory practices while operating to or from an airport without an operating control tower. The CTAF may be a Universal Communications (UNICOM),
-

MULTICOM, Flight Service Station (FSS), or tower frequency, and is identified in appropriate aeronautical publications.

**6.2.1** Universal Communications Frequency (UNICOM). A nongovernment air/ground radio communication station that may provide airport information at public-use airports.

**6.2.2** MULTICOM. A mobile service, not open to public correspondence use, used for essential communications in the conduct of activities performed by or directed from private aircraft.

**6.3** **Movement Area**. The runways, taxiways, and other areas of an airport/heliport that are used for taxiing/hover taxiing, air taxiing, takeoff and landing of aircraft, exclusive of loading ramps, and parking areas.

**6.4** **Traffic Pattern**. The traffic flow that is prescribed for aircraft landing at, taxiing on, or taking off from an airport.

## **7 RELATED READING MATERIAL:**

### **7.1 Guidance Materials for Pilots.**

- [Aeronautical Information Manual](#) (AIM).
- Airport Chart Supplements at [http://www.faa.gov/air\\_traffic/flight\\_info/aeronav/productcatalog/supplementalcharts/airportdirectory/](http://www.faa.gov/air_traffic/flight_info/aeronav/productcatalog/supplementalcharts/airportdirectory/).
- Aircraft Owners and Pilots Association (AOPA) at <https://www.aopa.org/>.
- [FAA Aeronautical Chart User's Guide](#).
- [Fly Neighborly Guide](#), Helicopter Association International.
- Notices to Airmen (NOTAM) at [https://www.faa.gov/air\\_traffic/publications/notices/](https://www.faa.gov/air_traffic/publications/notices/).
- Operations at Non-Towered Airports, AOPA, Air Safety Institute pamphlet.
- [Pilot's Handbook of Aeronautical Knowledge](#) (PHAK) (FAA-H-8083-25B).
- State Aviation Publications.
- United States Parachute Association at <http://www.uspa.org>.
- United States Ultralight Association at <https://www.usua.org>.
- Various Pilot Guides.

**7.2** **ACs**. The current editions of the following ACs also contain information applicable to operations at airports without operating control towers:

- AC [90-23](#), Aircraft Wake Turbulence.
- AC [90-48](#), Pilots' Role in Collision Avoidance.

- AC [91-32](#), Safety In and Around Helicopters.
- AC [91-57](#), Model Aircraft Operating Standards.
- AC [103-6](#), Ultralight Vehicle Operations—Airports, Air Traffic Control, and Weather.
- AC [105-2](#), Sport Parachuting.
- AC [107-2](#), Small Unmanned Aircraft Systems (sUAS).

## **8 BACKGROUND AND SCOPE.**

- 8.1** In the interest of promoting safety, the FAA, through its AIM, Chart Supplements, ACs, and other publications, provides frequency information, good operating practices, and procedures for pilots to use when operating at an airport without an operating control tower. The FAA believes that observance of a standard traffic pattern and the use of CTAF procedures as detailed in this AC will improve the safety and efficiency of aeronautical operations at airports without operating control towers.
- 8.2** Regulatory provisions relating to traffic patterns are found in 14 CFR parts 91, [93](#), and [97](#). The airport traffic patterns described in part 93 relate primarily to those airports where there is a need for unique traffic pattern procedures not provided for in part 91. Part 97 addresses instrument approach procedures (IAP). At airports without operating control towers, part 91 requires only that pilots of airplanes approaching to land make all turns to the left, unless light signals or visual markings indicate that turns should be made to the right (see approved light gun signals in § [91.125](#), visual markings and right-hand patterns in the PHAK, Chapter [14](#), Airport Operations, and the AIM, Chapter 4, Section 3, Airport Operations).
- 8.2.1** The FAA does not regulate traffic pattern entry, only traffic pattern flow. For example, an aircraft on an instrument approach flying on the final approach course to land would follow the requirements dictated by the approach procedure. A visual flight rules (VFR) aircraft on a long, straight-in approach for landing never enters the traffic pattern unless performing a go-around or touch and go after landing (see paragraph [9.5](#)).
- 8.2.1.1** Traffic pattern entry information is advisory, provided by using this AC or by referring to the AIM and the PHAK. Approaching to land in relation to traffic patterns by definition would mean aircraft in the traffic pattern landing or taking off from an airport. An aircraft not in the traffic pattern would not be bound by § 91.126(b) (see paragraph [11.3](#) for aircraft crossing over midfield above pattern altitude to enter the pattern). Requirements for traffic pattern flow under § 91.126 continue to apply to other airspace classification types under § [91.127](#) (Class E airspace), § [91.129](#) (Class D airspace), and § [91.130](#) (Class C airspace), particularly when a towered airport is currently operating as a non-towered airport.

## 9 GENERAL OPERATING PRACTICES.

**9.1 Left Traffic.** Use of standard traffic patterns (left turns) for all aircraft and CTAF procedures by radio-equipped aircraft are required at all airports without operating control towers unless indicated otherwise by visual markings, light gun signals, airport publications, or published approach procedure. It is recognized that other traffic patterns (right turns) may already be in common use at some airports or that special circumstances or conditions exist that may prevent use of the standard traffic pattern. Right-hand patterns are noted at airports on an aeronautical chart with an “RP” designator and the applicable runway next to the airport symbol.

**9.2 Collision Avoidance.** The pilot in command’s (PIC) primary responsibility is to see and avoid other aircraft and to help them see and avoid his or her aircraft. Keep lights and strobes on. The use of any traffic pattern procedure does not alter the responsibility of each pilot to see and avoid other aircraft. Pilots are encouraged to participate in “Operation Lights On,” a voluntary pilot safety program described in the AIM, paragraph 4-3-23, that is designed to improve the “see-and-avoid” capabilities.

**9.2.1 Unmanned Aircraft.** Unmanned aircraft (commonly known as drones or model aircraft), like manned aircraft, are allowed to operate in Class G airspace without specific air traffic control (ATC) authorization and without required radio communications. The remote PIC and the Unmanned Aircraft System (UAS) operator must always yield right-of-way to a manned aircraft and not interfere with manned aircraft operations. Additional information regarding unmanned aircraft operations may be found in AC 91-57, AC 107-2, and 14 CFR part [107](#).

**Note:** Operators of UAS are required to obtain ATC authorization prior to operating in Class B, C, D, and surface Class E airspaces.

**9.3 Preflight Actions.** As part of the preflight familiarization with all available information concerning a flight, each pilot should review all appropriate publications (e.g., Chart Supplements, the AIM, and NOTAMs), for pertinent information on current traffic patterns at the departure and arrival airports.

**9.4 Traffic Flow.** It is recommended that pilots use visual indicators, such as the segmented circle, wind direction indicator, landing direction indicator, and traffic pattern indicators that provide traffic pattern information. If other traffic is present in the pattern, arriving or departing aircraft should use the same runway as these aircraft. Transient aircraft may not know local ground references, so pilots should use standard pattern phraseology, including distances from the airport.

**9.5 Straight-In Landings.** The FAA encourages pilots to use the standard traffic pattern when arriving or departing a non-towered airport or a part-time-towered airport when the control tower is not operating, particularly when other traffic is observed or when operating from an unfamiliar airport. However, there are occasions where a pilot can choose to execute a straight-in approach for landing when not intending to enter the traffic pattern, such as a visual approach executed as part of the termination of an

instrument approach. Pilots should clearly communicate on the CTAF and coordinate maneuvering for and execution of the landing with other traffic so as not to disrupt the flow of other aircraft. Therefore, pilots operating in the traffic pattern should be alert at all times to aircraft executing straight-in landings, particularly when flying a base leg prior to turning final.

**9.6 Instrument Flight Rules (IFR) Traffic.** Pilots conducting instrument approaches in visual meteorological conditions (VMC) should be particularly alert for other aircraft in the pattern so as to avoid interrupting the flow of traffic and should bear in mind they do not have priority over other VFR traffic. Pilots are reminded that circling approaches require left-hand turns unless the approach procedure explicitly states otherwise. This has been upheld by prior FAA legal interpretations of § 91.126(b).

**9.6.1** Non-instrument-rated pilots might not understand radio calls referring to approach waypoints, depicted headings, or missed approach procedures. IFR pilots often indicate that they are on a particular approach, but that may not be enough information for a non-IFR-rated pilot to know your location. It is better to provide specific direction and distance from the airport, as well as the pilot's intentions upon completion of the approach. For example, instead of saying, "PROCEDURE TURN INBOUND V-O-R APPROACH 36," it should be "6 MILES SOUTH ... INBOUND V-O-R APPROACH RUNWAY 36, LOW APPROACH ONLY" or "6 MILES SOUTH ... INBOUND V-O-R APPROACH RUNWAY 36, LANDING FULL STOP."

**9.7 No-Radio Aircraft.** Pilots should be aware that procedures at airports without operating control towers generally do not require the use of two-way radios; therefore, pilots should be especially vigilant for other aircraft while operating in the traffic pattern. Pilots of inbound aircraft that are not capable of radio communications should determine the runway in use prior to entering the traffic pattern by observing the landing direction indicator, the wind indicator, landing and departing traffic, previously referring to relevant airport publications, or by other means.

**9.8 Wake Turbulence.** All aircraft generate wake turbulence. Therefore, pilots should be prepared to encounter turbulence while operating in a traffic pattern and especially when in the trail of other aircraft. Wake turbulence can damage aircraft components and equipment. In flight, avoid the area below and behind the aircraft generating turbulence, especially at low altitude where even a momentary wake encounter can be hazardous. All operators should be aware of the potential adverse effects that their wake, rotor, or propeller turbulence has on light aircraft and ultralight vehicles.

**9.9 Other Approaches to Land.** Pilots should be aware of the other types of approaches to land that may be used at an airport when a pilot indicates they are doing so, which may or may not be initiated from the traffic pattern. The more common types of these include a short approach, low approach, or overhead approach.

**9.9.1** A short approach is executed when the pilot makes an abbreviated downwind, base, and final legs turning inside of the standard 90-degree base turn. This can be requested at a towered airport for aircraft spacing, but is more commonly used at a non-towered airport

or a part-time-towered airport when the control tower is not operating, when landing with a simulated engine out or completing a power-off 180-degree accuracy approach commercial-rating maneuver.

**9.9.2** A low approach is executed when an aircraft intends to overfly the runway, maintaining runway heading but not landing. This is commonly used by aircraft flying practice instrument approaches.

**9.9.3** An overhead approach is normally performed by aerobatic or high-performance aircraft and involves a quick 180-degree turn and descent at the approach end of the runway before turning to land (described in the AIM, paragraph 5-4-27, Overhead Approach Maneuvers).

**10 COMMUNICATIONS PROCEDURES.** The following information is intended to supplement the AIM, paragraph 4-1-9, Traffic Advisory Practices at Airports Without Operating Control Towers.

**10.1 Recommended Traffic Advisory Practices.** All traffic within a 10-mile radius of a non-towered airport or a part-time-towered airport when the control tower is not operating should continuously monitor and communicate, as appropriate, on the designated CTAF until leaving the area or until clear of the movement area. After first monitoring the frequency for other traffic present passing within 10 miles from the airport, self-announcing of your position and intentions should occur between 8 and 10 miles from the airport upon arrival. Departing aircraft should continuously monitor/communicate on the appropriate frequency from startup, during taxi, and until 10 miles from the airport, unless 14 CFR or local procedures require otherwise.

**10.1.1** To achieve the greatest degree of safety, it is essential that:

1. All radio-equipped aircraft transmit/receive on a common frequency identified for the purpose of airport advisories, as identified in appropriate aeronautical publications.
2. Pilots use the correct airport name, as identified in appropriate aeronautical publications, when exchanging traffic information to reduce the risk of confusion. For example, using “Midwest National Traffic” instead of the town name “Mosby Traffic” or “Clay County Traffic” at KGPH when the airport name is printed “Midwest National” on aeronautical charts.
3. To help identify one airport from another, the correct airport name should be spoken at the beginning and end of each self-announce transmission.
4. Pilots clarify intentions if a communication sent by either their aircraft or another aircraft was potentially not received or misunderstood.
5. Pilots limit communications on CTAF frequencies to safety-essential information regarding arrivals, departures, traffic flow, takeoffs, and landings. The CTAF should not be used for personal conversations.

**10.2 Information Provided by UNICOM.** UNICOM stations may, upon request, provide pilots with weather information, wind direction, the recommended runway, or other necessary information. If the UNICOM frequency is designated as the CTAF, it will be identified in appropriate aeronautical publications. If wind and weather information is not available, it may be obtainable from nearby airports via the Automatic Terminal Information Service (ATIS) or Automated Weather Observing System (AWOS). UNICOM operators are not required to communicate with pilots, and if they do, there are no standards for the information conveyed.

**10.3 Self-Announce Position and/or Intentions.** “Self-announce” is a procedure whereby pilots broadcast their aircraft call sign, position, altitude, and intended flight activity or ground operation on the designated CTAF. This procedure is used almost exclusively at airports that do not have an operative control tower on the airport. If an airport has a control tower that is either temporarily closed or operated on a part-time basis, pilots should use the published CTAF to self-announce position and/or intentions when entering within 10 miles of the airport.

**10.3.1** Self-announce transmissions may include aircraft type to aid in identification and detection. Paint schemes and color or style descriptions may be added to the use of the aircraft call sign and type, but should not replace type or call sign. For example, “MIDWEST TRAFFIC, TWIN COMMANDER FIVE ONE ROMEO FOXTROT TEN MILES NORTHEAST” or “MIDWEST TRAFFIC, FIVE ONE ROMEO FOXTROT TWIN COMMANDER TEN MILES NORTHEAST.” In some cases, where the type of aircraft may not be familiar to pilots, the color and description may be added to the type and call sign. For instance, “MIDWEST TRAFFIC, EXPERIMENTAL SKYBOLT NOVEMBER THREE TWO DELTA SIERRA, ORANGE AND WHITE BIPLANE TEN MILES NORTHEAST.” When referring to a specific runway, pilots should use the runway number and not use the phrase “Active Runway,” because there is no official active runway at a non-towered airport. To help identify one airport from another when sharing the same frequency, the airport name should be spoken at the beginning and end of each self-announce transmission.

**Note:** Pilots are reminded that the use of the phrase, “ANY TRAFFIC IN THE AREA, PLEASE ADVISE,” is not a recognized self-announce position and/or intention phrase and should not be used under any condition. Any traffic that is present at the time of your self-announcement that is capable of radio communications should reply without being prompted to do so.

**10.4 Confusing Language.** To avoid misunderstandings, pilots should avoid using the words “to” and “for” whenever possible. These words might be confused with runway numbers or altitudes. The use of “inbound for landing” should also be avoided. For example, instead of saying, “MIDWEST TRAFFIC, EIGHT ONE TANGO FOXTROT TEN MILES TO THE NORTHEAST, INBOUND FOR LANDING RUNWAY TWO TWO MIDWEST,” it is more advisable to say, “MIDWEST TRAFFIC, EIGHT ONE TANGO FOXTROT TEN MILES NORTHEAST OF THE AIRPORT, LANDING STRAIGHT IN RUNWAY TWO TWO, MIDWEST,” so it does not confuse runway 4, runway 22, or the use of an IAP on arrival.



**10.5 Unlisted Frequencies.** Where there is no tower, CTAF, or UNICOM station depicted for an airport on an aeronautical chart, use MULTICOM frequency 122.9 for self-announce procedures. Such airports should be identified in appropriate aeronautical information publications.

**10.6 Practice Instrument Approaches in VFR Conditions.** Pilots conducting practice instrument approaches should be particularly alert for other aircraft that may be departing in the opposite direction or on a base leg or final approach to the runway associated with the approach. Conducting any practice instrument approach, regardless of its direction relative to other airport operations, does not take priority over other VFR aircraft. Pilots should be ready to communicate on CTAF, discontinue the approach, and enter a traffic pattern as needed, based on the traffic saturation of the airport and/or the current runway in use, to maintain aircraft separation and aviation safety. Pilots are reminded that circling approaches, practice or actual, require left-hand turns unless the approach procedure explicitly states otherwise. This has been upheld by prior FAA legal interpretations of § 91.126(b).

**10.7 Disagreements.** Do not correct other pilots on frequency (unless it is safety critical), particularly if you are aware you are correcting a student pilot. If you disagree with what another pilot is doing, operate your aircraft safely, communicate as necessary, clarify their intentions and, if you feel you must discuss operations with another pilot, wait until you are on the ground to have that discussion. Keep in mind that while you are communicating, you may block transmissions from other aircraft that may be departing or landing in the opposite direction to your aircraft due to IFR operations, noise abatement, obstacle avoidance, or runway length requirements. An aircraft might be using a runway different from the one favoring the prevailing winds. In this case, one option is to simply point out the current winds to the other pilots and indicate which runway you plan on using because of the current meteorological conditions.

**11 RECOMMENDED STANDARD TRAFFIC PATTERN.** The following information is intended to supplement the AIM, paragraph 4-3-3, Traffic Patterns, and the PHAK, Chapter 14.

**11.1 Traffic Pattern Design.** Airport owners and operators, in coordination with the FAA, are responsible for establishing traffic patterns. The FAA encourages airport owners and operators to establish traffic patterns as recommended in this AC. Further, left traffic patterns should be established, except where obstacles, terrain, and noise-sensitive areas dictate otherwise (see Appendix [A](#), Traffic Patterns).

**11.2 Determination of Traffic Pattern.** Prior to entering the traffic pattern at an airport without an operating control tower, aircraft should avoid the flow of traffic until established on the entry leg. For example, the pilot can check wind and landing direction indicators while at an altitude above the traffic pattern, or by monitoring the communications of other traffic that communicate the runway in use, especially at airports with more than one runway. When the runway in use and proper traffic pattern direction have been determined, the pilot should then proceed to a point well clear of the pattern before descending to and entering at pattern altitude.

**11.3 Traffic Pattern Entry.** Arriving aircraft should be at traffic pattern altitude and allow for sufficient time to view the entire traffic pattern before entering. Entries into traffic patterns while descending may create collision hazards and should be avoided. Entry to the downwind leg should be at a 45 degree angle abeam the midpoint of the runway to be used for landing. The pilot may use discretion to choose an alternate type of entry, especially when intending to cross over midfield, based upon the traffic and communication at the time of arrival.

**Note:** Aircraft should always enter the pattern at pattern altitude, especially when flying over midfield and entering the downwind directly. A midfield crossing alternate pattern entry should not be used when the pattern is congested. Descending into the traffic pattern can be dangerous, as one aircraft could descend on top of another aircraft already in the pattern. All similar types of aircraft, including those entering on the 45 degree angle to downwind, should be at the same pattern altitude so that it is easier to visually acquire any traffic in the pattern.

**Figure 1. Preferred and Alternate Entry When Crossing Midfield (From the PHAK)**

Preferred Entry When Crossing Over Midfield

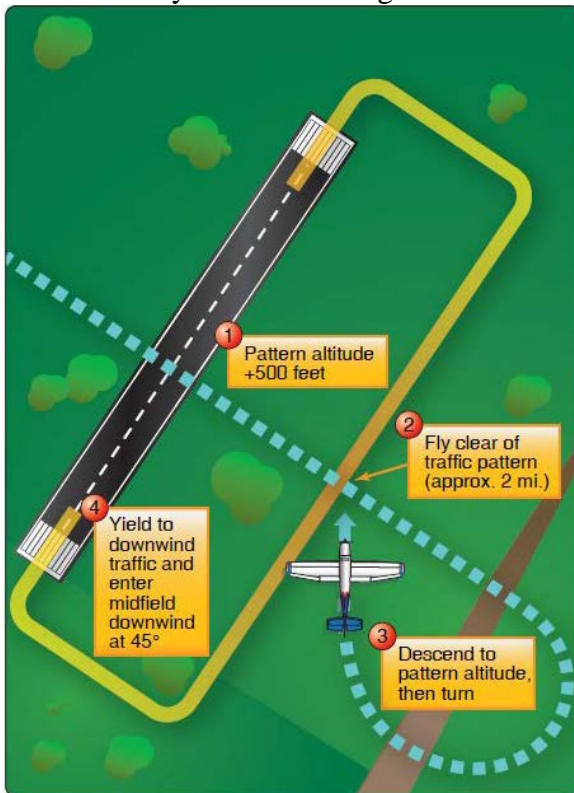

Alternate Midfield Entry

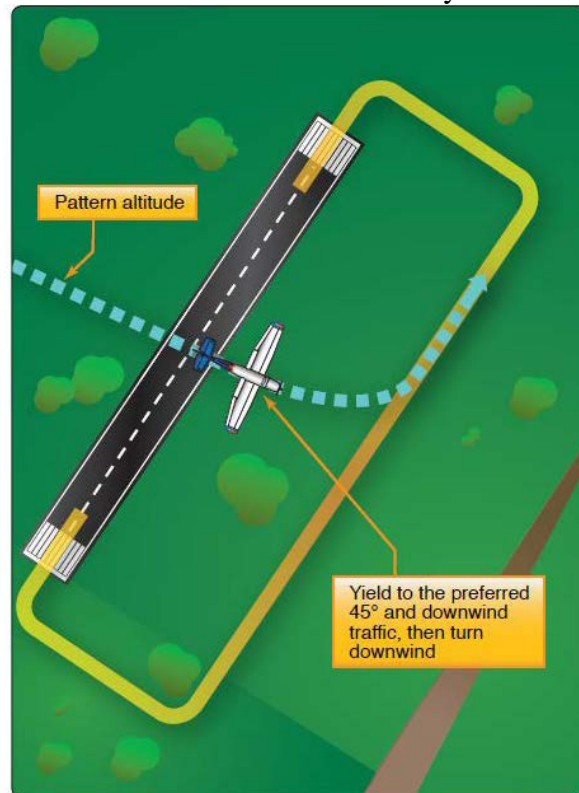

**11.4 Traffic Pattern Altitudes.** It is recommended that airplanes observe a 1,000 foot above ground level (AGL) traffic pattern altitude. Large and turbine-powered airplanes should enter the traffic pattern at an altitude of 1,500 feet AGL or 500 feet above the established pattern altitude. Ultralight vehicles should operate no higher than 500 feet below the powered aircraft pattern altitude. A pilot may vary the size of the traffic pattern depending on the aircraft's performance characteristics.

- 11.5 Descent and Base Turn.** The traffic pattern altitude should be maintained until the aircraft is at least abeam the approach end of the landing runway on the downwind leg. The base leg turn should commence when the aircraft is at a point approximately 45 degrees relative bearing from the approach end of the runway.
- 11.6 Runway Preference.** Landing and takeoff should be accomplished on the operating runway most nearly aligned into the wind. However, if a secondary runway is used (e.g., for length limitations), pilots using the secondary runway should avoid the flow of traffic to the runway most nearly aligned into the wind.
- 11.7 Takeoff and Go-Around.** Airplanes on takeoff should continue straight ahead until beyond the departure end of the runway. Aircraft executing a go-around maneuver should continue straight ahead, beyond the departure end of the runway, with the pilot maintaining awareness of other traffic so as not to conflict with those established in the pattern. In cases where a go-around was caused by an aircraft on the runway, maneuvering parallel, or sidestepping to the runway may be required to maintain visual contact with the conflicting aircraft.

**Note:** Ask an instructor, Fixed-Base Operator (FBO) employee, or other pilots at your departure airport about special procedures such as noise abatement departure routes or local protocols if they are not apparent or directly communicated by the FAA. Not every airport has official noise abatement procedures, nor does every airport consistently share this information with transient pilots. One inconsiderate act, even if inadvertent, can undo months of effort by local pilots and the airport.

- 11.8 Turning Crosswind.** Airplanes remaining in the traffic pattern should not commence a turn to the crosswind leg until beyond the departure end of the runway and within 300 feet below traffic pattern altitude. Pilots should make the turn to downwind leg at the traffic pattern altitude.

**Note:** Pilots should be aware that the crosswind leg may be longer or shorter due to weather conditions that are unusually hot or cold.

- 11.9 Departing the Pattern.** When departing the traffic pattern, airplanes should continue straight out or exit with a 45-degree left turn (right turn for right traffic pattern) beyond the departure end of the runway after reaching pattern altitude. Pilots need to be aware of any traffic entering the traffic pattern prior to commencing a turn.
- 11.10 Airspeed Limitations.** Airplanes should not be operated in the traffic pattern at an indicated airspeed of more than 200 knots (230 mph).
- 11.11 Right-of-Way.** Throughout the traffic pattern, right-of-way rules apply as stated in § 91.113; any aircraft in distress has the right-of-way over all other aircraft. In addition, when converging aircraft are of different categories, a balloon has the right-of-way over any other category of aircraft; a glider has the right-of-way over an airship, airplane, or rotorcraft; and an airship has the right-of-way over an airplane or rotorcraft.

**Note:** Parachute operations are subject to 14 CFR part [105](#). Parachute operators are required to coordinate their operations with the airport manager before they take place, and utilize proper radio notification during operations.

**12 OTHER TRAFFIC PATTERNS.** Airport operators routinely establish local procedures for the operation of gliders, parachutists, lighter-than-air aircraft, helicopters, and ultralight vehicles. Appendix [B](#), Glider Operations, and Appendix [C](#), Parachute Operations, illustrate these operations as they relate to recommended standard traffic patterns.

### **12.1 Rotorcraft.**

**12.1.1** In the case of a helicopter approaching to land other than on the active runway, the pilot must avoid the flow of fixed-wing aircraft and land on a marked helipad or suitable clear area. Pilots should be aware that at some airports, the only suitable landing area is the runway, and a standard traffic pattern can be utilized if it does not conflict with any other fixed-wing traffic present at the time of landing.

**12.1.2** All pilots should be aware that rotorcraft may fly slower and approach at steeper angles than airplanes. Air taxi is the preferred method for helicopter ground movements, which enables the pilot to proceed at an optimum airspeed, minimize downwash effect, and conserve fuel. Flight over aircraft, vehicles, and personnel should be avoided.

**12.1.3** In the case of a gyroplane approaching to land, the gyroplane pilot operating in the traffic pattern when landing on the runway may fly a pattern similar to the fixed-wing aircraft traffic pattern but at a lower altitude (500 feet AGL) and closer to the runway. This runway pattern may be on the opposite side of the runway from fixed-wing traffic only when airspeed requires it or for practice power-off landings and if local policy permits. Landings not on the runway must avoid the flow of fixed-wing traffic.

**12.1.4** Helicopters operating in the traffic pattern when landing on the runway may fly a pattern similar to the fixed-wing aircraft traffic pattern but at a lower altitude (500 feet AGL) and closer to the runway. This runway pattern may be on the opposite side of the runway from fixed-wing traffic only when airspeed requires it or for practice power-off landings (autorotation) and if local policy permits. Landings not on the runway must avoid the flow of fixed-wing traffic.

**12.1.5** Both classes of rotorcraft can be expected to practice power-off landings (autorotation), which will involve a very steep angle of approach and high rate of descent (1,500 to 2,000 feet/minute).

### **12.2 Gliders.**

**12.2.1** A glider, including the tow aircraft during towing operations, has the right-of-way over powered aircraft.

**12.2.2** If both airplanes and gliders use the same runway, the glider traffic pattern will be inside the pattern of engine-driven aircraft. If a glider operating area is established to one side of a powered-aircraft runway, the glider pattern will normally be on the side of the airport

closest to the glider operating area. This will allow gliders to fly the same direction traffic pattern as powered aircraft in certain wind conditions and necessitate a separate, opposing direction traffic pattern in other wind conditions. (See examples in Appendix [B](#)).

- 12.2.3** Typically, glider traffic patterns have entry points (initial points) from 600 to 1,000 feet AGL.

### **12.3 Ultralight Vehicles.**

- 12.3.1** In accordance with 14 CFR part [103](#), ultralight vehicles are required to yield the right-of-way to all aircraft.
- 12.3.2** Ultralight vehicles should fly the rectangular pattern as described in Appendix B. Pattern altitude should be 500 feet below and inside the standard pattern established for the airport. An ultralight pattern with its own dedicated landing area will typically have a lower traffic pattern parallel to the standard pattern, with turns in the opposite direction.
- 12.3.3** All pilots should be aware that ultralights will fly significantly slower than airplanes. Ultralights may also exhibit very steep takeoff and approach angles. Turns may be executed near the end of the runway in order to clear the area expediently.

### **12.4 Lighter-Than-Air Aircraft.**

- 12.4.1** A balloon has the right-of-way over any other category of aircraft and does not follow a standard traffic pattern.
- 12.4.2** Due to limited maneuverability, airships do not normally fly a standard traffic pattern. However, if a standard traffic pattern is flown, it will be at an airspeed below most other aircraft.

### **12.5 Parachute Operations.**

- 12.5.1** All activities are normally conducted under a NOTAM noting the location, altitudes, and time or duration of jump operations. The Chart Supplement lists airports where permanent Drop Zones (DZ) are located.
- 12.5.2** Jumpers normally exit the aircraft either above, or well upwind of, the airport and at altitudes well above traffic pattern altitude. Parachutes are normally deployed between 2,000 feet and 5,000 feet AGL and can be expected to be below 3,000 feet AGL within 2 miles of the airport.
- 12.5.3** Pilots of jump aircraft are required by part 105 to establish two-way radio communications with the ATC facility that has jurisdiction over the affected airspace prior to jump operations for the purpose of receiving information in the aircraft about known air traffic in the vicinity. In addition, when jump aircraft are operating at or in the vicinity of an airport, pilots are also encouraged to provide advisory information on the CTAF. For example, "Chambersburg traffic, jumpers away over Chambersburg."

- 12.5.4** When a DZ has been established at an airport, parachutists are expected to land within the DZ. At airports that have not established DZs, parachutists should avoid landing on runways, taxiways, aprons, and their associated safety areas. Pilots and parachutists should both be aware of the limited flight performance of parachutes and take steps to avoid any potential conflicts between aircraft and parachute operations.
- 12.5.5** Appendix [C](#) depicts operations conducted by parachutists.
- 13 AC FEEDBACK FORM.** For your convenience, the AC Feedback Form is the last page of this AC. Note any deficiencies found, clarifications needed, or suggested improvements regarding the contents of this AC on the Feedback Form.

## APPENDIX A. TRAFFIC PATTERNS

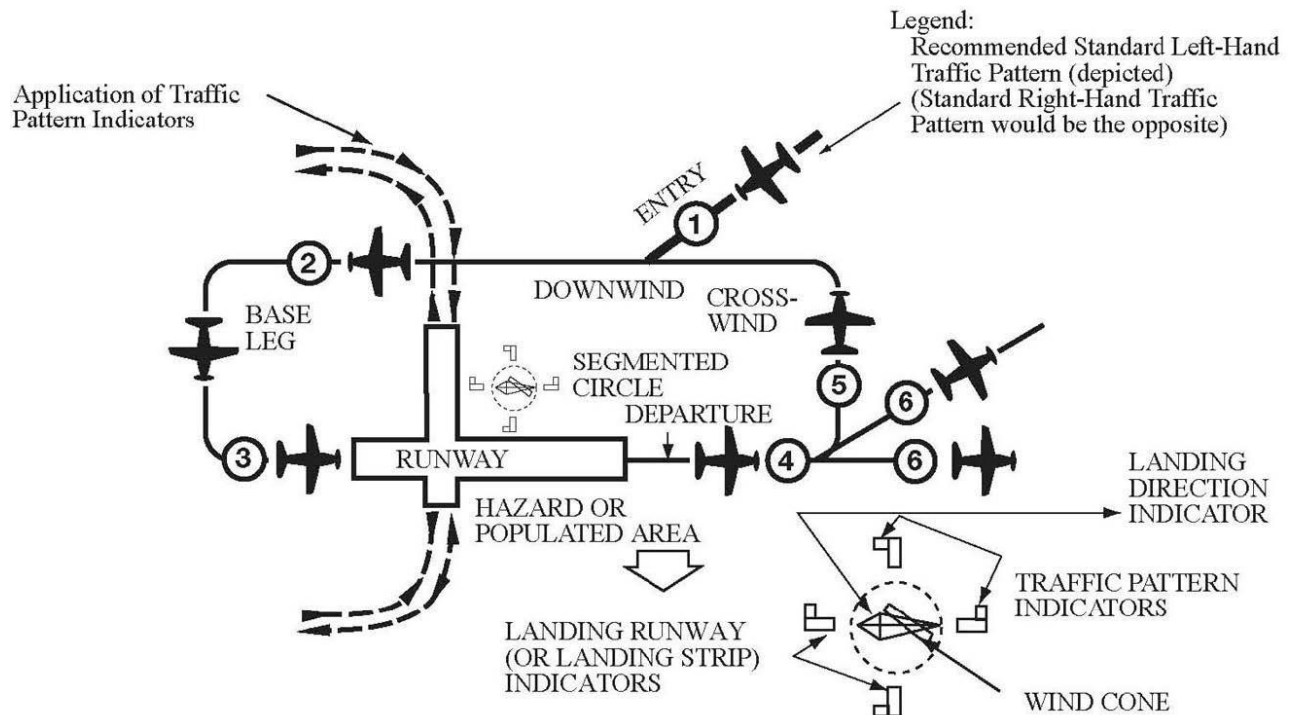
Single Runway (Diagram from the [AIM](#), Paragraph 4-3-3)

## EXAMPLE—

## Key to traffic pattern operations

1. Enter pattern in level flight, abeam the midpoint of the runway, at pattern altitude.
2. Maintain pattern altitude until abeam approach end of the landing runway on downwind leg, begin descent and turn base at approximately 45 degrees from the intended landing point.
3. Complete turn to final at least ¼ mile from the runway.
4. Continue straight ahead until beyond departure end of runway.
5. If remaining in the traffic pattern, commence turn to crosswind leg beyond the departure end of the runway within 300 feet of pattern altitude.
6. If departing the traffic pattern, continue straight out, or exit with a 45-degree turn (to the left when in a left-hand traffic pattern; to the right when in a right-hand traffic pattern) beyond the departure end of the runway, after reaching pattern altitude.

**Parallel Runways (Diagram from the AIM, Paragraph 4-3-3)**

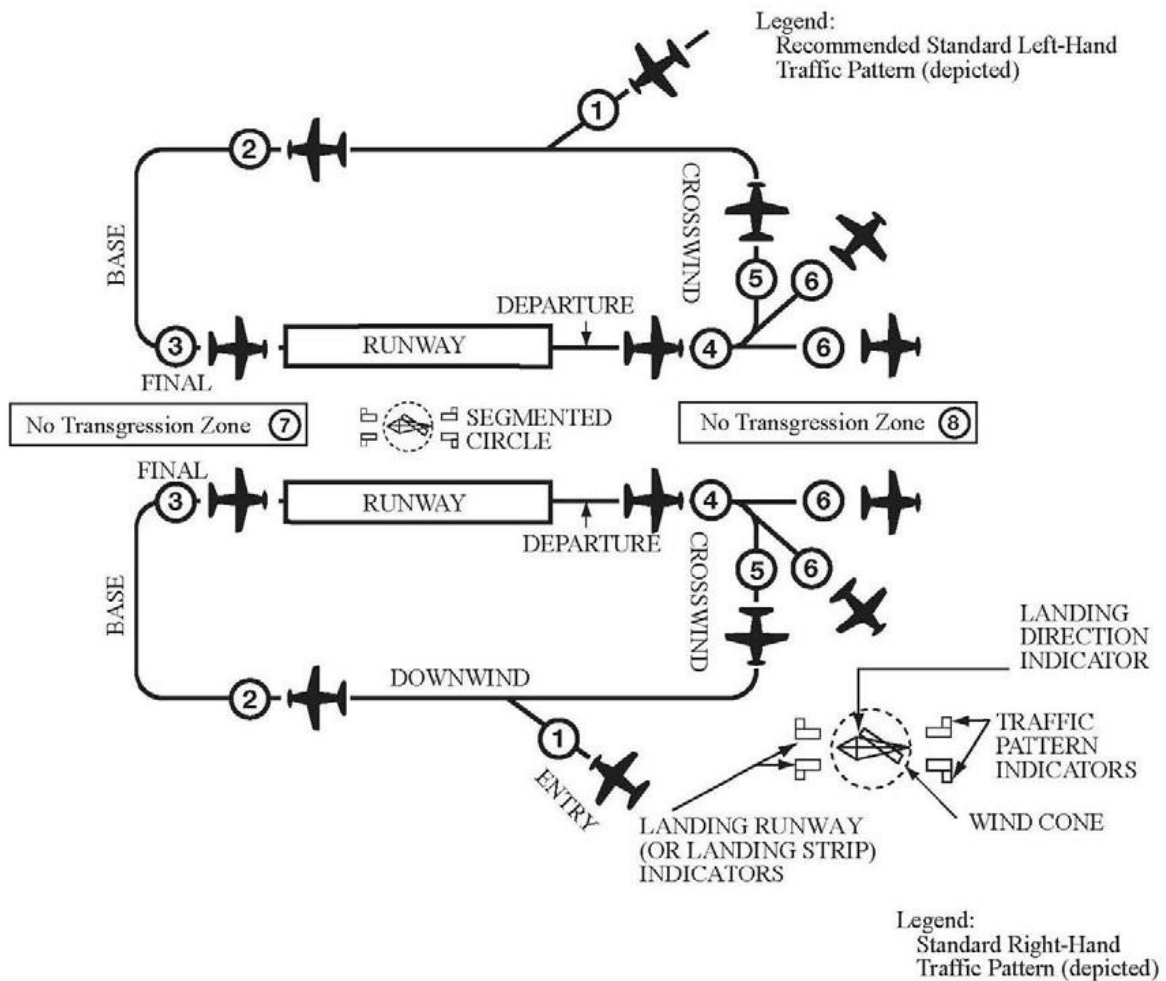

**EXAMPLE—**

**Key to traffic pattern operations**

1. Enter pattern in level flight, abeam the midpoint of the runway, at pattern altitude.
2. Maintain pattern altitude until abeam approach end of the landing runway on downwind leg, begin descent and turn base at approximately 45 degrees from the intended landing point.
3. Complete turn to final at least ¼ mile from the runway.
4. Continue straight ahead until beyond departure end of runway.
5. If remaining in the traffic pattern, commence turn to crosswind leg beyond the departure end of the runway within 300 feet of pattern altitude.
6. If departing the traffic pattern, continue straight out, or exit with a 45-degree turn (to the left when in a left-hand traffic pattern; to the right when in a right-hand traffic pattern) beyond the departure end of the runway, after reaching pattern altitude.
7. Do not overshoot final or continue on a track which will penetrate the final approach of the parallel runway.
8. Do not continue on a track which will penetrate the departure path of the parallel runway.



### APPENDIX B. GLIDER OPERATIONS

#### Ultralight Aircraft Pattern

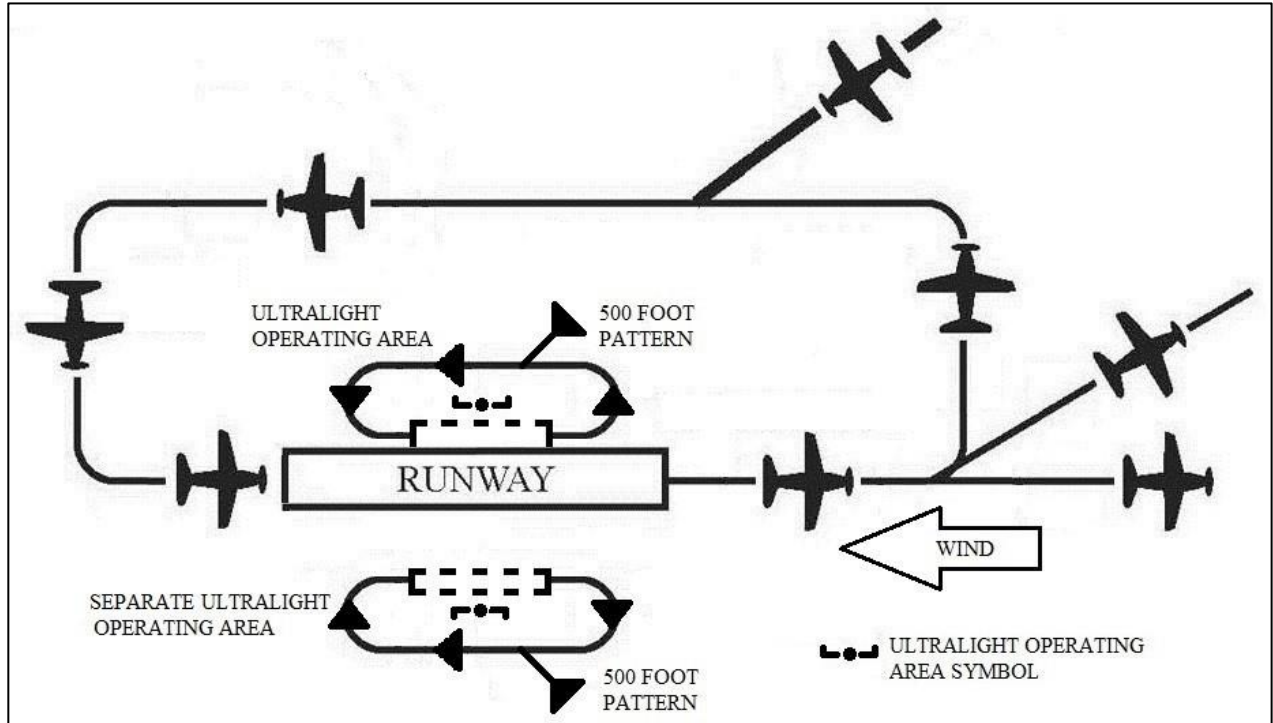

#### Glider Aircraft Pattern

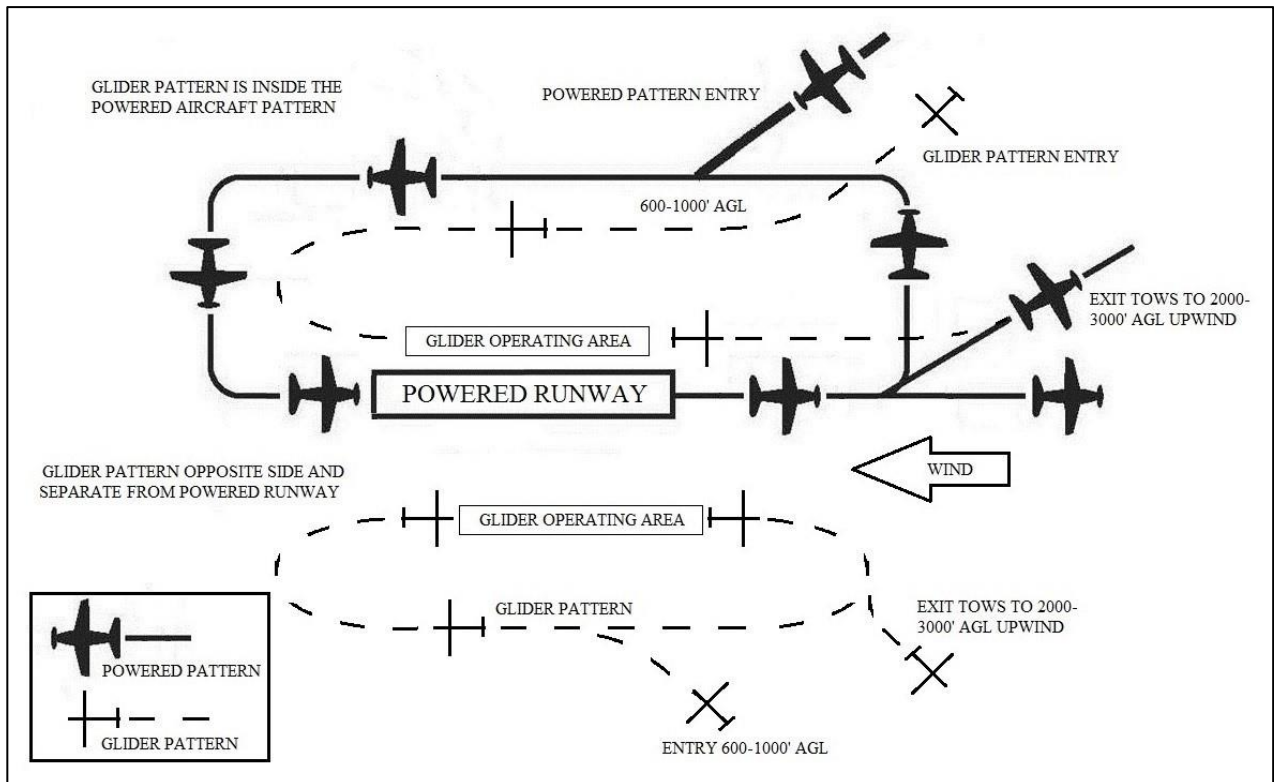

APPENDIX C. PARACHUTE OPERATIONS

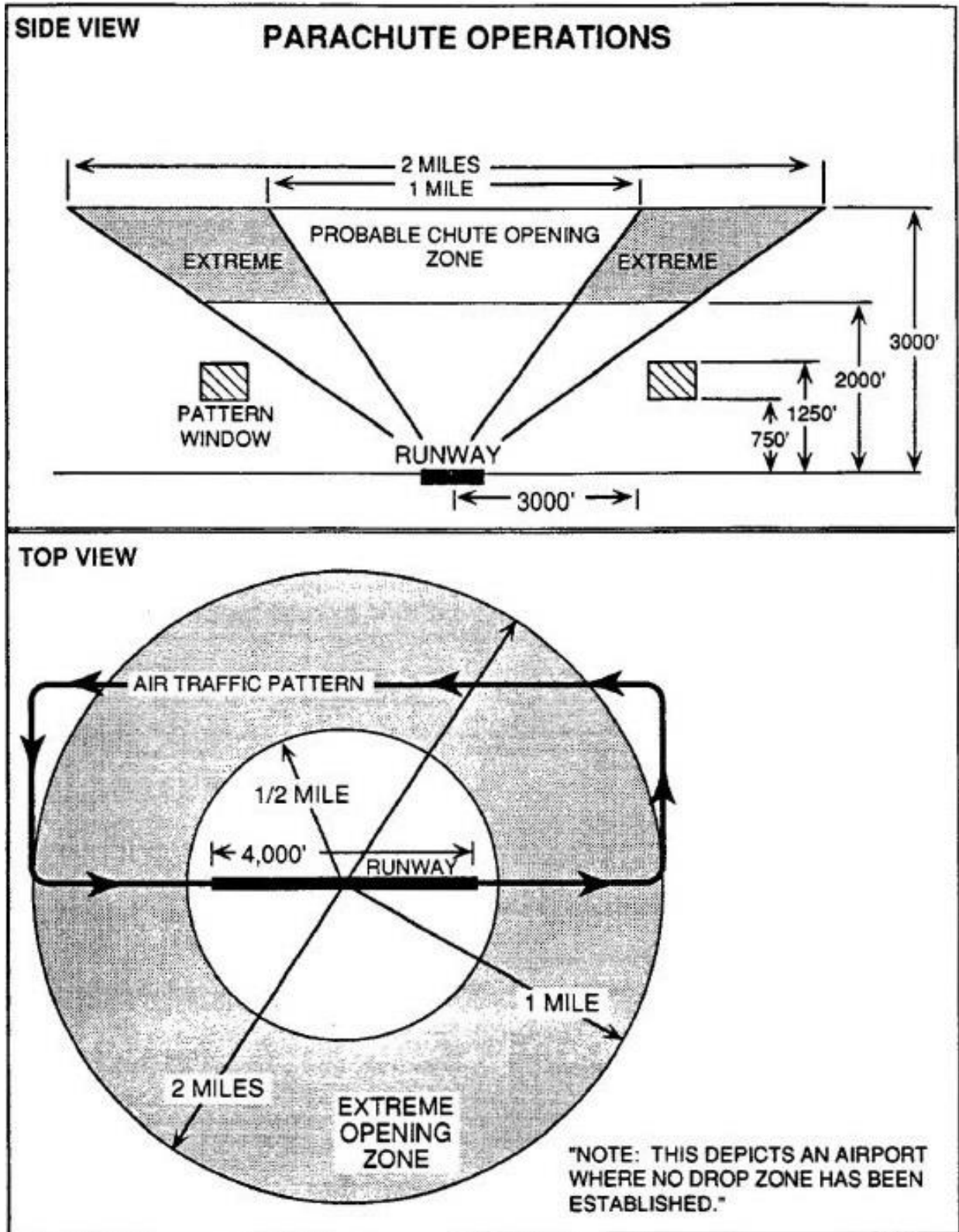

### Advisory Circular Feedback Form

If you find an error in this AC, have recommendations for improving it, or have suggestions for new items/subjects to be added, you may let us know by contacting the General Aviation and Commercial Division (AFS-800) at 9-AFS-800-Correspondence@faa.gov or the Flight Standards Directives Management Officer at 9-AWA-AFS-140-Directives@faa.gov.

Subject: AC 90-66B CHG 1, Non-Towered Airport Flight Operations

Date: \_\_\_\_\_

*Please check all appropriate line items:*

An error (procedural or typographical) has been noted in paragraph \_\_\_\_\_ on page \_\_\_\_\_.

Recommend paragraph \_\_\_\_\_ on page \_\_\_\_\_ be changed as follows:

---

---

In a future change to this AC, please cover the following subject:  
*(Briefly describe what you want added.)*

---

---

Other comments:

---

---

I would like to discuss the above. Please contact me.

Submitted by: \_\_\_\_\_

Date: \_\_\_\_\_