



U.S. Department
of Transportation
**Federal Aviation
Administration**

Advisory Circular

Subject: Airport Field Condition Assessments
and Winter Operations Safety

Date: 7/29/2016

AC No: 150/5200-30D

Initiated By: AAS-300

1 **PURPOSE.**

This advisory circular (AC) provides guidance to assist airport operators in developing a snow and ice control plan, assessing and reporting airport conditions through the utilization of the Runway Condition Assessment Matrix (RCAM), and establishing snow removal and control procedures.

2 **CANCELLATION.**

This AC cancels AC 150/5200-30C, *Airport Winter Safety and Operations*, dated December 9, 2008.

3 **APPLICATION.**

1. The information contained in this AC provides guidance for the airport operators in the development of plans, methods, and procedures for identifying, reporting, and removal of airport contaminants. The use of this guidance is an acceptable means of compliance, for airports certificated under Title 14 Code of Federal Regulations (CFR) part 139, Certification of Airports. The use of this AC is also a method of compliance for federally obligated airports. Furthermore, use of the specifications in this AC is mandatory for projects funded under the Airport Improvement Program (AIP) or with revenue from the Passenger Facility Charge (PFC) program.
2. For implementation purposes, all certificated airports must submit revised Snow and Ice Control Plans to the FAA no later than September 1, 2016, for approval. The Federal NOTAM System is the primary means of conveying airport condition information by certificated and federally obligated airports. Effective October 1, 2016, the Federal NOTAM System will incorporate the new **reporting criteria and methodology contained in this AC.**

4 **PRINCIPAL CHANGES.**

The AC incorporates the following principal changes:

1. Updates the title of the AC to communicate the inclusion of guidance on field condition assessments beyond winter conditions.
2. Introduces the Runway Condition Assessment Matrix (RCAM) and procedures for its use and application.
3. Expands on using current NOTAM system technology for airport condition reporting.
4. Adds new information to the Airfield Clearing Priorities for the Snow and Ice Control Plan.
5. Adds definitions of contaminants in Paragraph 1.12.
6. Defines vehicle and pilot reported braking action and updates terminology: Good, Good-to-Medium, Medium (previously known as Fair), Medium-to-Poor, Poor, and Nil.
7. Adds “conditions not monitored” information for airport operators to use when the airport is not monitored due to operations hours or staffing.
8. Adds the new acronym “RwyCC” for Runway Condition Code.
9. Removes the capability to report friction (Mu) values (replaced by RwyCCs).
10. Adds information on snow removal from Engineered Material Arresting Systems.
11. Adds new Appendix A, Sample Airport Condition Assessment Worksheet.
12. Adds new Appendix F, Runway Condition Assessment Matrix (RCAM) (For Airport Operators’ Use Only).
13. Provides origin and background on the Takeoff and Landing Performance Assessment Aviation Rulemaking Committee.
14. Identifies the approved list of layered contaminants.
15. Introduces percentage based contaminant reporting by runway third.
16. Limits use of Vehicle Braking Action Reports to non-runway environment (e.g., taxiways, aprons, holding bays, etc.).
17. Provides examples of how multiple contaminants are to be illustrated.
18. Revises and supplements the list of questions for Snow and Ice Control Plans (SICPs).
19. Provides a decision tree for an overview of the basic RCAM process.

5 **Related Code of Federal Regulations (CFRs) and Reference Materials.**

The following are FAA regulations and publications (see current versions) from which material has been extracted for the preparation of this AC. They will continue to be the authoritative source of revisions to this AC. These references also contain additional

resource material that may be useful in special situations, but their immediate availability to airport operators is not considered necessary to accomplish the basic operational purpose of this AC. Electronic versions of these documents are available online.

1. Electronic CFRs are available at www.ecfr.gov:
 - a. 14 CFR Part 139, Certification of Airports.
 - b. 14 CFR Part 25, Airworthiness Standards: Transport Category Airplanes.
 - c. 14 CFR Part 91, General Operating and Flight Rules.
 - d. 14 CFR Part 121, Air Carrier Certification.
 - e. 14 CFR Part 135, Operating Requirements: Commuter and On Demand Operations and Rules Governing Persons On Board Such Aircraft.
 - f. 49 CFR Part 1542, Airport Security.
 - g. 49 CFR Part 1544, Aircraft Operator Security: Air Carriers and Commercial Operators.
2. Air Traffic publications are available at www.faa.gov/air_traffic/publications/:
 - a. FAA Order JO 7110.10, *Flight Services*.
 - b. FAA Order JO 7110.65, *Air Traffic Control*.
 - c. FAA Order JO 7210.3, *Facility Operation and Administration*.
 - d. FAA Order JO 7930.2, *Notices to Airmen (NOTAMs)*.
 - e. Aeronautical Information Manual (AIM).
 - f. Pilot/Controller Glossary (P/CG).
3. Airport ACs (150 series) are available at www.faa.gov/airports/resources/advisory_circulars/:
 - a. AC 150/5300-13, *Airport Design*.
 - b. AC 150/5200-28, *Notices to Airmen (NOTAMs) for Airport Operators*.
 - c. AC 150/5320-12, *Measurement, Construction, and Maintenance of Skid Resistant Airport Pavement Surfaces*.
4. Other FAA ACs are available at www.faa.gov/regulations_policies/advisory_circulars/:
 - a. AC 25-31, *Takeoff Performance Data for Operations on Contaminated Runways*.
 - b. AC 25-32, *Landing Performance Data for Time-of-Arrival Landing Performance Assessments*.
 - c. AC 91-79, *Mitigating the Risks of a Runway Overrun Upon Landing*.
 - d. AC 121.195-1, *Operational Landing Distances for Wet Runways; Transport Category Airplanes*.

5. Other FAA Orders and Notices are available at http://www.faa.gov/regulations_policies/orders_notices/:
 - a. FAA Order 8900.1, *Flight Standards Information Management System*.
 - b. FAA Order 5190.6, *Airport Compliance Manual*.

A handwritten signature in black ink, appearing to read "Michael J. O'Donnell". The signature is stylized and written over a light gray rectangular background.

Michael J. O'Donnell
Director of Airport Safety and Standards

CONTENTS

| Paragraph | Page |
|---|------------|
| CHAPTER 1. INTRODUCTION | 1-1 |
| 1.1 Overview..... | 1-1 |
| 1.2 Background..... | 1-1 |
| 1.3 Snow and Ice Control Committee..... | 1-2 |
| 1.4 Airport Snow and Ice Control Committee (SICC)..... | 1-2 |
| 1.5 Snow Control Center (SCC)..... | 1-3 |
| 1.6 Airfield Clearing Priorities for the Snow and Ice Control Plan (SICP)..... | 1-3 |
| 1.7 Terminal and Landside – Ground Side Priority..... | 1-4 |
| 1.8 Airfield Target Clearance Times..... | 1-5 |
| 1.9 Staffing for Operation of Snow and Ice Control Equipment..... | 1-6 |
| 1.10 Sizing and Storage of Snow and Ice Control Equipment..... | 1-7 |
| 1.11 FAA-Approved Runway Friction Measuring Equipment..... | 1-7 |
| 1.12 Definitions..... | 1-8 |
| CHAPTER 2. THE SNOW AND ICE CONTROL PLAN..... | 2-1 |
| 2.1 Safety Requirements..... | 2-1 |
| 2.2 Airport Operators..... | 2-1 |
| 2.3 Snow and Ice Control Plans..... | 2-1 |
| 2.4 Topics for Pre- and Post-Season SICC Meetings..... | 2-3 |
| 2.5 Outlining a Snow and Ice Control Plan (SICP)..... | 2-5 |
| 2.6 Topics for Writing Instructions and Procedures for Winter Operations and Notification..... | 2-5 |
| 2.7 Runway Incursion Mitigation and Operations During Non-Towered Air Traffic Control Periods..... | 2-6 |
| 2.8 Staff Training and Recordkeeping..... | 2-7 |
| 2.9 Other Related Items..... | 2-7 |
| CHAPTER 3. FORECAST TECHNOLOGY FOR AIRPORT OPERATORS..... | 3-1 |
| 3.1 Weather Forecasting..... | 3-1 |
| 3.2 FAA Forecasting Research and Development for Airport Operators..... | 3-1 |
| 3.3 Forecasting Runway Surface Conditions..... | 3-4 |

| | |
|---|------------|
| CHAPTER 4. SNOW CLEARING OPERATIONS AND ICE PREVENTION..... | 4-1 |
| 4.1 Introduction..... | 4-1 |
| 4.2 Snow Clearing Principles..... | 4-1 |
| 4.3 Controlling Snow Drifts..... | 4-11 |
| 4.4 Snow Disposal..... | 4-12 |
| 4.5 Methods for Ice Control and Removal. | 4-13 |
| 4.6 Approved Chemicals..... | 4-14 |
| 4.7 Runway Friction Improvements. | 4-16 |
| 4.8 Sand..... | 4-18 |
| CHAPTER 5. SURFACE ASSESSMENT AND REPORTING | 5-1 |
| 5.1 Airport Operator Responsibility..... | 5-1 |
| 5.2 Runway Friction Surveys. | 5-2 |
| 5.3 Runway Condition Assessments..... | 5-5 |
| 5.4 Applying the RCAM to a Runway Assessment. | 5-14 |
| 5.5 Reportable Contaminants without Performance Data. | 5-17 |
| 5.6 Condition Reporting. | 5-17 |
| 5.7 Information Exchanged Between the Airport and Pilots. | 5-17 |
| 5.8 Requirements for Runway, Taxiway, and Apron and Holding Bay Closures. | 5-19 |
| 5.9 Continuous Monitoring..... | 5-20 |
| 5.10 Letter of Agreement (LOA) Between Airport Operator and Air Traffic Control Tower..... | 5-21 |
| 5.11 Airport Records and Log Controls. | 5-21 |
| 5.12 Using “Conditions Not Monitored” NOTAMs..... | 5-22 |
| 5.13 Winter NOTAM Abbreviations. | 5-22 |
| APPENDIX A. SAMPLE AIRPORT CONDITIONS ASSESSMENT WORKSHEET ... | A-1 |
| APPENDIX B. DEVELOPMENT OF RECOMMENDED SNOW BANK HEIGHT PROFILES..... | B-1 |
| APPENDIX C. SNOW AND ICE CONTROL AS A MATERIALS-HANDLING PROBLEM..... | C-1 |
| APPENDIX D. DECELEROMETERS THAT MEET FAA TECHNICAL SPECIFICATIONS..... | D-1 |
| APPENDIX E. PERFORMANCE SPECIFICATION FOR DECELEROMETERS..... | E-1 |

APPENDIX F. RUNWAY CONDITION ASSESSMENT MATRIX (RCAM) (FOR AIRPORT OPERATORS' USE ONLY)..... F-1

FIGURES

| | |
|---|------|
| Figure 1-1. Example of Prioritized Paved Areas for the Snow and Ice Control Plan..... | 1-4 |
| Figure 3-1. ETI Precipitation Gauge in a Single Alter Wind Shield 2 Type | 3-2 |
| Figure 3-2. Schematic of Unidirectional Storm WSDDM Configuration | 3-3 |
| Figure 4-1. Snow Bank Profile Limits Along Edges of Runways and Taxiways with the Airplane Wheels on Full Strength Pavement (see Figure 4-2 guidance)..... | 4-7 |
| Figure 4-2. ILS CAT I and CAT II/III Snow Clearance Area Depth Limitations..... | 4-8 |
| Figure 4-3. Possible Team Configuration with Perpendicular Wind..... | 4-9 |
| Figure 4-4. Possible Team Configuration During Light Snowfall with Parallel or Calm Wind . | 4-9 |
| Figure 4-5. Possible Team Configuration During Medium to Heavy Snowfall with Parallel or Calm Wind (Dependent upon Rotary Plow performance)..... | 4-10 |
| Figure 4-6. Typical Snow Trench Dimensions | 4-12 |
| Figure 5-1. Runway Condition Description Column of the RCAM..... | 5-9 |
| Figure 5-2. Runway Condition Code (RwyCC) Column of the RCAM..... | 5-10 |
| Figure 5-3. Friction Assessment Column of the RCAM | 5-12 |
| Figure 5-4. Vehicle Deceleration or Directional Control Observation Column of the RCAM . | 5-13 |
| Figure 5-5. Pilot Reported Breaking Action Column of the RCAM | 5-14 |
| Figure B-1. Individual Height Profiles of Airplane Wingtips and Outer and Inner Engine Nacelles' Lower Edges for Airplane Design Groups III and IV | B-2 |
| Figure B-2. Individual Height Profiles of Airplane Wingtips and Outer and Inner Engine Nacelles' Lower Edges for Airplane Design Groups V and VI | B-3 |

TABLES

| | |
|--|------|
| Table 1-1. Clearance Times for Commercial Service Airports | 1-5 |
| Table 1-2. Clearance Times for Non-Commercial Service Airports | 1-6 |
| Table 4-1. Guidance for Airside Urea Application Rates..... | 4-15 |
| Table 4-2. Standard Gradation for Sand | 4-19 |
| Table 4-3. Expanded Sand Gradation Standard..... | 4-19 |
| Table 5-1. Friction Survey Example | 5-5 |
| Table 5-2. Runway Condition Assessment Matrix (RCAM)..... | 5-7 |

This page intentionally left blank.

CHAPTER 1. INTRODUCTION

1.1 Overview.

The presence of contaminants such as snow, ice, or slush on airfield pavements causes hazardous conditions that may contribute to airplane incidents and accidents. Further, winter storm conditions usually reduce airport traffic volumes through flight delays and/or cancellations and, in severe storm conditions, airport closures. The extent to which these undesirable effects are minimized will depend on the approach taken by the airport operator to closely monitor and assess conditions and have mitigating practices ready to combat potential and any existing contaminant conditions on the airport. This revised AC introduces new concepts and practices and a different approach for airport operators to use, which is a less subjective way of assessing airport conditions. The information in this AC harmonizes activities across FAA Lines of Business in addressing airport surface contaminants. This harmonization recognizes that aircraft manufacturers have determined that variances in contaminant type, depth, and air temperature cause specific changes in aircraft braking performance. As a result, it is possible to take the aircraft manufacturers' data for specific contaminants and produce the Runway Condition Assessment Matrix for use by airport operators. This harmonization effort associated with identified contaminants extends beyond our domestic airports to our ICAO partners, who are implementing similar standards and procedures to make the process of identifying airport contaminants less subjective. In complying with part 139 for certificated airports, the NOTAM system will become more important for distributing airport conditions reports.

1.2 Background.

- 1.2.1 Following the overrun accident of a Boeing-737 in December of 2005, the FAA found that the current state of the industry practices did not have adequate guidance and regulation addressing operation on non-dry, non-wet runways, i.e., contaminated runways. As such, the FAA chartered an Aviation Rulemaking Committee (ARC) to address Takeoff and Landing Performance Assessment (TALPA) requirements for the appropriate parts 23, 25, 91 subpart K, 121, 125, 135, and 139. In formulating recommendations, it became clear to the ARC that the ability to communicate actual runway conditions to the pilots in real time and in terms that directly relate to expected aircraft performance was critical to the success of the project. While researching current NOTAM processes numerous significant short comings were discovered that hampered this communication effort. This document provides NOTAM reporting procedures intended for a digital communication process that would support this major safety initiative and resolve the identified shortcomings. Without accurate real time information pilots cannot safely assess takeoff or landing performance.
- 1.2.2 At the core of this recommendation is the concept of using the included Runway Condition Assessment Matrix (RCAM) (shown in Table 5-2) as the basis for performing runway condition assessments by airport operators and for interpreting the reported runway conditions by pilots in a standardized format based on airplane

performance data supplied by airplane manufacturers for each of the stated contaminant types and depths. The concept attempts, to the maximum extent feasible, to replace subjective judgments of runway conditions with objective assessments which are tied directly to contaminant type and depth categories, which have been determined by airplane manufacturers to cause specific changes in the airplane braking performance.

1.3 **Snow and Ice Control Committee.**

Winter storm conditions usually reduce airport traffic volumes through flight delays and/or cancellations and, in severe storm conditions, airport closures. The extent to which these undesirable effects are minimized will depend on the approach taken by the airport operator to combat winter conditions. The airport operators that are most successful at combating winter storms are those that establish an airport snow and ice control committee that conducts pre- and post-seasonal planning meetings, operates a Snow Control Center (SCC), and, most importantly, implements a written plan. This advisory circular provides recommendations and guidance for writing plans plus identifies topics that should receive special focus to improve operational safety. For airports certificated under part 139, the written plan is referred to as the *Snow and Ice Control Plan* (see §139.313, *Snow and Ice Control*.)

1.4 **Airport Snow and Ice Control Committee (SICC).**

All airports subject to icing conditions or annual snowfall of several inches (6 inches (15 cm) or more) should have a SICC. Such committees have been effective in (1) pre-season planning, (2) focusing the operational plan to improve runway safety and communications between various offices/departments involved or impacted by a storm event, (3) addressing the needs of airport users, and (4) critiquing clearing activities of the airfield and apron areas after the winter season and after each storm event. It is recommended that the airport operator schedule ongoing evaluation meetings, preferably after each storm event, to allow evaluation of procedures, identify safety concerns, and, when necessary, implement revised clearing procedures. The SICC size and functions will vary based on the airport size, airport users, and the type of winter weather experienced within its geographical location. The airport manager or his/her representative should chair the SICC. The committee should include representatives from the following:

1. Airport operations staff.
2. Airline flight operations departments (pilot representative), airline station personnel (deicing representatives), and fixed-base operators.
3. FAA air traffic control, flight service station, and technical operations.
4. Other concerned parties deemed necessary, such as the U.S. military (at joint-use airports), service providers, and contractors who may be actively conducting construction activities.

1.5 **Snow Control Center (SCC).**

The airport operator should set up a Snow Control Center (SCC) for snow and ice control activities. Depending on the size of the airport and its operations, the SCC may be in a special room or facility, or it might be a “snow desk” in a maintenance building, or it could be the command vehicle of the operations officer. The SCC performs the following main functions: (1) managing snow clearing operations; (2) serving as a prime source of field condition reporting, e.g., timely runway braking conditions, snow accumulations, etc.; (3) informing the airport traffic control tower (ATCT), air carriers, air taxis, and other parties of expected runway closures and openings; and (4) issuing timely NOTAMs (see AC 150/5200-28, *Notices to Airmen (NOTAMs) for Airport Operators*, and FAA Orders 7930.2, *Notices to Airmen (NOTAMS)*, and 7340.1, *Contractions*.)

1.6 **Airfield Clearing Priorities for the Snow and Ice Control Plan (SICP).**

It is impractical and infeasible for airport operators to simultaneously clear all airside pavement and support facilities of all snow, slush, and ice. The airport operator can establish a minimum level of service by establishing a priority classification system much like how municipalities clear their roadway system during snow events. This targeted approach places focus on critical areas of the airfield that will allow aircraft operations in a safe and efficient manner at an acceptable level of service given environmental conditions. Efforts to clear areas of lower importance can be delayed until the higher priority areas are fully functional or to low aircraft activity hours.

1.6.1 Establishing Priority Areas.

The SICP, as a minimum, will identify two priority areas based on the airport’s safety requirements, aircraft operations, and navigational aid facilities. The sizing of the priority areas will take into account the airport resource capabilities and the actual aircraft operational needs. Correct sizing of the highest priority area will optimize clearing activities. Oversizing the highest priority area can be counterproductive as it may exceed the airport’s resource capabilities, and it can deflect limited resources to clear areas not immediately needed for aircraft operations. Figure 1-1 illustrates an airport with typically prioritized areas.

1.6.1.1 Priority 1.

Areas appropriate for this category are those that directly contribute to safety and the re-establishment of aircraft operations at a minimum acceptable level of service. Priority 1 will generally consist of the primary runway(s) with taxiway turnoffs and associated taxiways leading to the terminal, portions of the terminal ramp, portions of the cargo ramp, airport rescue and fire fighting (ARFF) station ramps and access roads, mutual aid access points (including gates), emergency service roads, access to essential NAVAID, and centralized deicing facilities. It is not necessary to clear an entire terminal or cargo apron. Priority 1 should only include those portion(s) of apron areas immediately necessary to allow movement of aircraft at a minimum acceptable level of service. Those portions of the

apron area that are not essential to re-establishing a minimum level of acceptable airfield service may be used as temporary snow pile staging area for subsequent removal during low activity periods.

1.6.1.2 Priority 2.

Areas appropriate for Priority 2 are those not essential to re-establishing a minimum acceptable level of service for aircraft operations. Items in this category normally include crosswind/secondary runways and their supportive taxiways, terminal and cargo apron area not cleared under Priority 1, commercial ramp areas, overnight parking, access roads to secondary facilities, and airfield facilities not essential to flight operations or not used on a daily basis.

1.6.1.3 Priority 3.

Priority 3 includes all other areas not addressed under Priority 1 or Priority 2. This typically includes the perimeter security road and service roads within the AOA.

Figure 1-1. Example of Prioritized Paved Areas for the Snow and Ice Control Plan

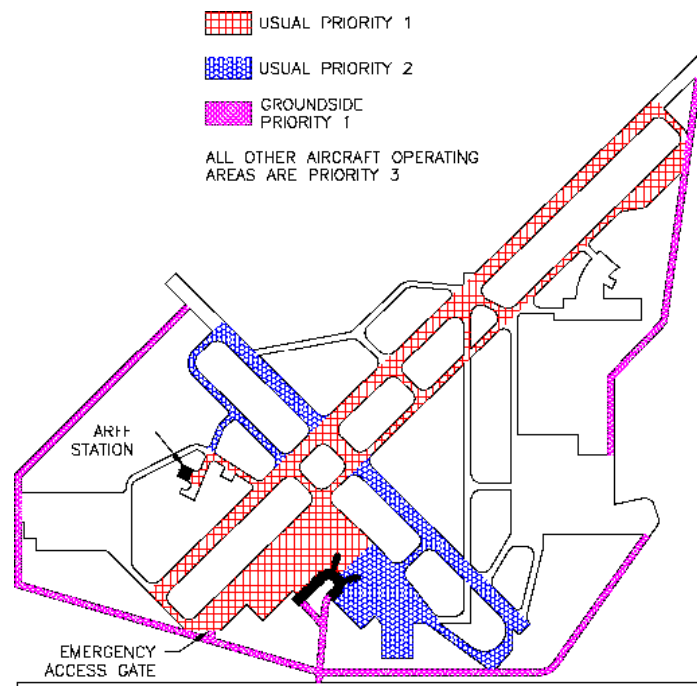

1.7 Terminal and Landside – Ground Side Priority.

The clearing of snow from the terminal and landside infrastructure to and from the terminal is a separate category generally not contained in the SICP because the objective of this clearing operation is public access, not aircraft operation safety. Moreover, different chemicals, clearing equipment, and techniques, and possibly the use

of municipal or service contractors, might be standard for such operations. Landside pavement deicers are not to be tracked onto the airfield areas because of their corrosive properties to aircraft. See Paragraph 4.6.2 for prohibition of landside chemicals on aircraft operational areas.

1.8 **Airfield Target Clearance Times.**

Airports should consider having sufficient equipment to clear within a reasonable time 1 inch (2.54 cm) of snow weighing up to 25 lb/ft³ (400 kg/m³) for the priorities outlined in Paragraph 1.6 that accommodate clearing the anticipated airplane operations during the Priority 1 clearance time. This means that generally only some portions of the terminal or cargo apron should be included in the Priority 1 area. If supportive runways (such as a parallel runway) typically have simultaneous operations during the winter months, then the areas for both runways and associated principal taxiways should be included in the total area. The term “reasonable time,” as used in this AC, is based on the airport type and number of annual operations. The guidance in Paragraphs 1.8.1, 1.8.2, and 1.9 is provided to assist the airport operator in determining necessary equipment.

- 1.8.1 First, use the general information note and footnote in Table 1-1 and Table 1-2 to classify the airport as a **Commercial Service Airport** or a **Non-Commercial Service Airport**.

Table 1-1. Clearance Times for Commercial Service Airports

| Annual Airplane Operations (includes cargo operations) | Clearance Time¹ (hour) |
|---|--|
| 40,000 or more | 1/2 |
| 10,000 – but less than 40,000 | 1 |
| 6,000 – but less than 10,000 | 1 1/2 |
| Less than 6,000 | 2 |
| <p>General: Commercial Service Airport means a public-use airport that the U.S. Secretary of Transportation determines has at least 2,500 passenger boardings each year and that receives scheduled passenger airplane service [see 49 U.S.C. 47102(7)].</p> <p>Footnote 1: These airports should have sufficient equipment to clear 1 inch (2.54 cm) of falling snow weighing up to 25 lb/ft³ (400 kg/m³) from Priority 1 areas within the targeted clearance times.</p> | |

Table 1-2. Clearance Times for Non-Commercial Service Airports

| Annual Airplane Operations (includes cargo operations) | Clearance Time¹ (hour) |
|---|--|
| 40,000 or more | 2 |
| 10,000 – but less than 40,000 | 3 |
| 6,000 – but less than 10,000 | 4 |
| Less than 6,000 | 6 |

General: Although not specifically defined, Non-Commercial Service Airports are airports that are not classified as Commercial Service Airports [see Table 1-1, general note].

Footnote 1: These airports may wish to have sufficient equipment to clear 1 inch (2.54 cm) of falling snow weighing up to 25 lb/ft³ (400 kg/m³) from Priority 1 areas within the recommended clearance times.

- 1.8.2 Second, using the appropriate table, find the number of annual airplane operations handled by the airport and the targeted clearance time. As shown in the tables, this action-initiating condition, compared with an action-initiating event based on weather forecasts or runway surface condition sensors, calls for clearing operations for 1-inch (2.54-cm) snowfall with an assumed weight (snow density) of up to 25 lb/ft³ (400 kg/m³). For airports located in regions where snow densities over 25 lb/ft³ (400 kg/m³) are the norm, the airport operator should keep in mind that heavier snow densities can increase the size and type of equipment comprising the fleet used to clear Priority 1 paved areas within the targeted clearance times (for details, see AC 150/5220-20, *Airport Snow and Ice Control Equipment*).

1.9 **Staffing for Operation of Snow and Ice Control Equipment.**

Sizing the snow and ice control equipment fleet should be based on the total Priority 1 paved area that is cleared of snow, slush, or ice within a targeted clearance time. AC 150/5220-20 offers guidance on how to select the number and types of equipment necessary to meet targeted clearance times. As for staffing, § 139.303(a)-(b) relate equipment fleet size with sufficient, qualified staff. Section 139.303(b) requires certificate holders “to equip personnel with sufficient resources needed to comply with the requirements of this part.” Section 139.303(a) requires certificate holders “to provide sufficient and qualified personnel to comply with the airport’s Airport Certification Manual and the requirements of this part.” While snow removal and surface treatment may be adequate for runways, the adequacy must extend to maintaining all open taxiways, aprons, centralized deicing facilities, and holding bays in a safe operating condition.

1.10 **Sizing and Storage of Snow and Ice Control Equipment.**

Sizing the snow and ice control equipment fleet should be based on the total Priority 1 paved area that is cleared of snow, slush, or ice within a targeted clearance time. The equipment necessary for Priority 1 may be used to clear lower priority areas once Priority 1 areas are clear. AC 150/5220-20 offers guidance on how to select the number and types of equipment necessary to meet targeted clearance times. Snow and ice control equipment should be housed in a building capable of maintaining 50 degrees Fahrenheit to prolong the useful life of the equipment and to enable more rapid response to operational needs. Operationally, equipment should be inspected after each use to determine whether additional maintenance or repair is necessary. Guidance on storing snow and ice control equipment is provided in AC 150/5220-18, *Buildings for Storage and Maintenance of Airport Snow and Ice Control Equipment and Materials*.

1.11 **FAA-Approved Runway Friction Measuring Equipment.**

There are two basic types of friction measuring equipment that can be used for conducting friction surveys on runways during winter operations: Continuous Friction Measuring Equipment (CFME) and Decelerometers (DEC). See Paragraph 5.2.

1.11.1 Continuous Friction Measuring Equipment (CFME).

CFME devices are recommended (over Decelerometers) for measuring friction characteristics of pavement surfaces covered with contaminants, as they provide a continuous graphic record of the pavement surface friction characteristics with friction averages for each one-third zone of the runway length. They may be either self-contained or towed. AC 150/5320-12, *Measurement, Construction, and Maintenance of Skid-Resistant Airport Pavement Surfaces*, contains performance specifications for CFME in Appendix 3 and a list of FAA-approved equipment in Appendix 4.

1.11.2 Decelerometers.

Decelerometers are recommended (over CFMEs) for airports where the longer runway downtime required to complete a friction survey is unacceptable and for busy airports where it is difficult to gain access to the full length of a runway crossed by another runway. Decelerometers should be of the electronic type due to the advantages noted below. Mechanical decelerometers may be used, but should be reserved as a backup. Airports having only mechanical devices should plan to upgrade as soon as possible. Neither type of decelerometer will provide a continuous graphic record of friction for the pavement surface condition. They provide only a spot check of the pavement surface. On pavements with frozen contaminant coverage of less than 25 percent, decelerometers are used only on the contaminated areas. For this reason, a survey taken under such conditions will result in a conservative representation of runway braking conditions. This should be considered when using friction values as an input into decisions about runway treatments. In addition, any time a pilot may experience widely varying braking along the runway, it is essential that the percentage of contaminant coverage be noted in any report. FAA-approved decelerometers are listed in Appendix D of this AC, and performance specifications are provided in Appendix E.

1.11.2.1 **Electronic Decelerometers.**

Electronic decelerometers eliminate potential human error by automatically computing and recording friction averages for each one-third zone of the runway. They also provide a printed record of the friction survey data.

1.11.2.2 **Mechanical Decelerometers.**

Mechanical decelerometers may be used as a backup to an electronic decelerometer. The runway downtime required to complete a friction survey will be longer than with an electronic decelerometer. Mechanical decelerometers do not provide automatic friction averages or a printed copy of data.

1.12 **Definitions.**

1.12.1 Ash.

Ash is a grayish-white to black solid residue of combustion normally originating from pulverized particulate matter ejected by volcanic eruption.

1.12.2 Compacted Snow.

Compacted snow is snow that has been compressed and consolidated into a solid form that resists further compression such that an airplane will remain on its surface without displacing any of it. If a chunk of compressed snow can be picked up by hand, it will hold together or can be broken into smaller chunks rather than falling away as individual snow particles.

Note: A layer of compacted snow over ice must be reported as compacted snow only.

Example: *When operating on the surface, significant rutting or compaction will not occur. Compacted snow may include a mixture of snow and embedded ice; if it is more ice than compacted snow, then it should be reported as either ice or wet ice, as applicable.*

1.12.3 Contaminant.

A contaminant is a deposit such as frost, any snow, slush, ice, or water on an airport pavement where the effects could be detrimental to the friction characteristics of the pavement surface.

1.12.4 Contaminated Runway.

1.12.4.1 For purposes of generating a runway condition code and airplane performance, a runway is considered contaminated when more than 25 percent of the overall runway length and width coverage or cleared width is covered by frost, ice, or any depth of snow, slush, or water.

1.12.4.2 When runway contaminants exist, but overall coverage within the area of the runway that is being maintained is 25 percent or less, the contaminants

will still be reported. However, a runway condition code will not be generated.

Note: While mud, ash, sand, and oil are reportable contaminants, there is no associated airplane performance data available for these contaminants and no Runway Condition Code (RwyCC) will be reported. Mud is the only contaminant in this reference where a measured depth is reportable.

Exception: Rubber is not subject to the 25 percent rule, and will be reported as *Slippery When Wet* when the pavement evaluation/friction deterioration indicates the averaged Mu value on the wet pavement surface is below the Minimum Friction Level classification specified in Table 3-2, Friction Level Classification for Runway Pavement Surfaces, of AC 150/5320-12, *Measurement, Construction, and Maintenance of Skid-Resistant Airport Pavement Surfaces*.

1.12.5 Dry Runway/Pavement.

Use the term “DRY” to describe runway/pavement surfaces that are neither wet nor contaminated. A FICON NOTAM must not be originated for the sole purpose of reporting a dry runway. A dry runway surface should be reported only when there is need to report conditions on the remainder of the surface.

1.12.6 Dry Snow.

Dry snow is snow that has insufficient free water to cause it to stick together. This generally occurs at temperatures well below 32° F (0° C). If when making a snowball, it falls apart, the snow is considered dry.

1.12.7 Eutectic Temperature/Composition.

A deicing chemical melts ice by lowering the freezing point. The extent of this freezing point depression depends on the chemical and water in the system. The limit of freezing point depression, equivalent to the lowest temperature that the chemical will melt ice, occurs with a specific amount of chemical. This temperature is called the eutectic temperature, and the amount of chemical is the eutectic composition. Collectively, they are referred to as the eutectic point.

1.12.8 FICON (Field Condition Report).

A FICON is a Notice to Airmen (NOTAM) generated to reflect pavement surface conditions on runways, taxiways, and aprons and Runway Condition Codes (RwyCCs) if greater than 25 percent of the overall runway length and width coverage or cleared width of the runway is contaminated.

1.12.9 Frost.

Frost consists of ice crystals formed from airborne moisture that condenses on a surface whose temperature is below freezing. Frost differs from ice in that the frost crystals grow independently and therefore have a more granular texture.

Note: Heavy frost that has noticeable depth may have friction qualities similar to ice and downgrading the runway condition code accordingly should be considered. If

driving a vehicle over the frost does not result in tire tracks down to bare pavement, the frost should be considered to have sufficient depth to consider a downgrade of the runway condition code.

1.12.10 Ice.

Ice is the solid form of frozen water including ice that is textured (i.e., rough or scarified ice).

Note: A layer of ice over compacted snow must be reported as ice only.

1.12.11 Layered Contaminant.

A layered contaminant is a contaminant consisting of two overlapping contaminants. The RCAM identifies the approved list of layered contaminants, including:

1. Dry Snow over Compacted Snow
2. Wet Snow over Compacted Snow
3. Slush over Ice
4. Water over Compacted Snow
5. Dry Snow over Ice
6. Wet Snow over Ice

1.12.12 Mud.

Mud is wet, sticky, soft earth material.

1.12.13 Multiple Contaminants.

Multiple contaminants are a combination of contaminants (as identified in the RCAM) observed on paved surfaces. When reporting multiple contaminants, only the two most prevalent contaminants are reported. When reporting on runways, up to two contaminant types may be reported for each runway third. The Runway Condition Code (when applicable) will be based on the most hazardous contaminant, when both contaminants are not from the same category in the RCAM. The reported contaminants may consist of a single **and** layered contaminant, two single contaminants, or two layered contaminants. The reporting of “multiple contaminants” represent contaminants which are located adjacent to each other, not to be confused with a “layered contaminant” which is overlapping. For example:

- Single contaminant and Layered contaminant.
‘Wet’ **and** ‘Wet Snow over Compacted Snow’
- Single contaminant and Single contaminant.
‘Wet Snow’ **and** ‘Slush’
- Layered contaminant and Layered contaminant.
‘Dry Snow over Compacted Snow’ **and** ‘Dry Snow over Ice’

1.12.14 Oil.

Oil is a viscous liquid, derived from petroleum or synthetic material, especially for use as a fuel or lubricant.

1.12.15 Runways (Primary and Secondary).

1.12.15.1 **Primary.**

Primary Runways are runways being actively used or expected to be used during existing or anticipated adverse meteorological conditions, where the majority of the takeoff and landing operations will take place.

1.12.15.2 **Secondary.**

Secondary runways are runways that support a primary runway and is less operationally critical. Takeoff and landing operations on such a runway are generally less frequent than on a primary runway. Snow removal operations on these secondary runways should not occur until Priority 1 surfaces are satisfactorily cleared and serviceable.

1.12.16 Runway Condition Assessment Matrix (RCAM).

The RCAM is the tool (Table 5-2) by which an airport operator will assess a runway surface when contaminants are present.

1.12.17 Runway Condition Code (RwyCC).

Runway Condition Codes describe runway conditions based on defined contaminants for each runway third. Use of RwyCCs harmonizes with ICAO Annex 14, providing a standardized “shorthand” format (e.g., 4/3/2) for reporting. RwyCCs (which replace the reporting of Mu values) are used by pilots to conduct landing performance assessments.

1.12.18 Sand.

Sand is a sedimentary material, finer than a granule and coarser than silt.

1.12.19 Slippery When Wet Runway.

1.12.19.1 For runways where a friction survey (conducted for pavement maintenance) indicates the averaged Mu value at 40 mph on the wet pavement surface failed to meet the minimum friction level classification specified in AC 150/5320-12, *Measurement, Construction, and Maintenance of Skid Resistant Airport Pavement Surfaces*, the airport operator must reports via the NOTAM system a RwyCC of ‘3’ for the entire runway (by thirds: 3/3/3) when the runway is wet. The runway condition description “Slippery When Wet” is used for this condition. If airport operator judgment deems a downgrade is necessary, the downgrade must be made such that all three runway thirds match (i.e. 3/3/3, 2/2/2, 1/1/1). An airport may discontinue the use of this NOTAM when the runway minimum friction level classification has been met or exceeded.

1.12.19.2 Slippery When Wet is only reported when a pavement maintenance evaluation indicates the averaged Mu value on the wet pavement surface is below the Minimum Friction Level classification specified in Table 3-2 of AC 150/5320-12. Some contributing factors that can create this condition include rubber buildup, groove failures/wear, and pavement macro/micro textures.

1.12.20 Slush.

Slush is snow that has water content exceeding a freely drained condition such that it takes on fluid properties (e.g., flowing and splashing). Water will drain from slush when a handful is picked up. This type of water-saturated snow will be displaced with a splatter by a heel and toe slap-down motion against the ground.

1.12.21 Water.

Water is the liquid state of water. For purposes of condition reporting and airplane performance, water is greater than 1/8-inch (3mm) in depth.

1.12.22 Wet Ice.

Wet ice is ice that is melting, or ice with a layer of water (any depth) on top.

1.12.23 Wet Runway.

A runway is wet when it is neither dry nor contaminated. For purposes of condition reporting and airplane performance, a runway can be considered wet when more than 25 percent of the overall runway length and width coverage or cleared width being used is covered by any visible dampness or water that is 1/8-inch (3 mm) or less in depth.

1.12.24 Wet Snow.

Wet snow is snow that has grains coated with liquid water, which bonds the mass together, but that has no excess water in the pore spaces. A well-compacted, solid snowball can be made, but water will not squeeze out.

CHAPTER 2. THE SNOW AND ICE CONTROL PLAN

2.1 Safety Requirements.

Snow, ice, and slush should be removed as expeditiously as practicable. The goal is to maintain runways, high-speed turnoffs, and taxiways in a “*no worse than wet*” (i.e., no contaminant accumulation) condition. Surface friction can be improved by application of sand when unusual conditions prevent prompt and complete removal of slush, snow, or ice. Operations of snow removal equipment and support vehicles must be conducted to prevent runway incursions and interference or conflict with airplane operations. This safety responsibility is shared by airport personnel, airplane operators, and any contract service providers. The reduced hours of daylight during the winter and frequent low-visibility conditions resulting from fog, blowing snow, or precipitation require extra care during field operations and greater attention to enhancing visibility of equipment performing winter maintenance (i.e., snow removal, friction enhancement, etc.). Post-clearing operations must be conducted to ensure airfield signage and markings between the runway(s) and apron are visible to the maximum extent possible to pilots to reduce the potential for runway incursions.

2.2 Airport Operators.

Airport operators ensure safety of operations at their facilities in accordance with 14 CFR part 139 regulatory guidance. Airport operators should ensure the snow and ice control plan is current, complete, and customized to the local conditions. All airport leases and agreements should be clear and specific and cover the duties and responsibilities of lessees to carry out their assigned snow and ice control duties. Airport operators, however, should notify the users of the airport of any change in published procedure or change in the physical facility. As an example, an airport operator should give, as soon as practicable, notice of pavement or visual aids that may have been damaged by a snow plowing operation. Complete documentation of compliance with the snow and ice control plan (SICP) should be kept. This documentation includes when and where SAIC activities have taken place. This advisory circular will use the term “*Snow and Ice Control Plan*” to represent the airport’s snow and ice control plans.

2.3 Snow and Ice Control Plans.

The Snow and Ice Control Plan (SICP) is a basic document encompassing at least two separate phases. Phase #1 addresses pre- and post-winter season subjects that prepare the airport operator for the new winter season. This phase may include revising the existing SICP after the winter season ends. Phase #2 addresses the sequential actions, via instruction and procedures, taken by the airport operator for dealing with winter storms and notifying airport users in a timely manner when less than satisfactory conditions exist at the airport including the closure of runways. Chapters 1, 3, 4, and 5 of this AC offer guidance, recommendations, and standards for writing instructions and procedures for Phase #2. Additionally, Paragraphs 2.4 and 2.5 should be used to

maintain a safer airfield. At minimum, the following questions should be addressed when outlining new plans or revising existing plans:

1. Are we meeting all applicable part 139 requirements?
2. Are we materially prepared and adequately budgeted for the new winter season?
3. Did the SICP incorporate identified post-season improvements?
4. Are we staffed adequately with qualified personnel?
5. Is our training program effective and adequately tracking test records and development of qualified personnel?
6. Are procedures for disposal of deicers and equipment maintenance materials and supplies in compliance with storm water regulations?
7. Were the pre- and post-season meetings held this year appropriate to address all facets and needs of operations and meet the requirements of the SICP?
8. Did our weather forecasting method monitor last year's storm events accurately and in a timely manner?
9. Do we need to change our prescribed storm conditions to start clearing operations or preventive measures?
10. Do we need to change our runway, taxiway, apron and holding bay closure procedures as defined in Paragraph 5.8 for closing a runway and other paved areas used by airplanes?
11. In reference to our closure procedures, do we need to revise the steps prescribed in the SICP for continuously monitoring?
12. Are there any changes to our chain-of-command and phone numbers?
13. Do we need to update or issue a Letter of Agreement (LOA) with the air traffic control tower (ATCT) or other parties for implementing runway, taxiway, apron and holding bay closure procedures?
14. Were there any changes to the airfield areas to be cleared and maintained, the timing of operations, and how clearing will be done?
15. Are we informing our users frequently and in a timely manner when we must close the airport or report less than satisfactory surface conditions? Did we get complaints?
16. How do we ensure markings, signs, and lighting systems are legible/visible after clearing operations? Are touchdown markings addressed in our procedures?
17. What are our procedures in case of airfield accidents involving snow clearing crews, airplanes, or other airport vehicles?
18. Did we address all unique airport site conditions?
19. Have all storm crews received driver's training on the SICP and trained on new equipment?

2.4 **Topics for Pre- and Post-Season SICC Meetings.**

As with all plans, the SICC should be reviewed at least annually to collectively assess the previous year's program. Three general topics are recommended for discussion, namely to incorporate (1) changes to airport staff, equipment, runway chemicals, and airport clearing procedures; (2) changes to air carrier ground deicing/anti-icing programs; and (3) "*lessons learned*" from actual events encountered. The SICC should consider holding a series of meetings to prepare for and adequately budget for the upcoming winter season. Two distinct meetings should be held; one focused on airport clearing operations, and the other focused on air carrier ground deicing/anti-icing programs. Each meeting should discuss any new topics not dealt with in past years, such as any new FAA aircraft ground deicing/anti-icing polices or any new Federal, state, or local storm water runoff regulations.

2.4.1 Topics Relative to Airport Snow Removal Operations Discussions.

The following are topics normally covered:

1. Areas designated as Priority 1 areas, to include any new airfield infrastructure.
2. Clearing operations, follow-up airfield assessments and reporting actions to further mitigate the potential for pilot and vehicular surface incidents or runway incursions.
3. Staffing requirements and qualifications (training) for snow crews and Snow Control Center staff.
4. Updates to the training program to close any ambiguity.
5. Streamline the decision-making process, the "chain-of-command" authority.
6. Response times to keep runways, taxiways, and apron areas operational, e.g., to rectify problems encountered during previous storm events that hampered airport operations.
7. Communications, terminology, frequencies, and procedures with the airport traffic control tower (ATCT), snow crews, and the Snow Control Center.
8. Monitoring and updating of surface conditions after a clearing operation and deicing or sanding applications.
9. Issuance of NOTAMs and dissemination to air carrier and other airport tenants to meet timely notification requirements.
10. Equipment inventory, including assessing the condition of snow control equipment, scheduling repairs, and stocking spare parts.
11. Status of procurement contracts and specifications for new vehicles or equipment.
12. Preventive maintenance program for snow control equipment and maintenance and calibration for friction testing equipment.
13. Status of procurement contracts and specifications for deicer-/anti-icer materials and sand supply, including their storage before the first snowfall.
14. Validation of deicer certification letters from vendors.
15. Procedures for storm water runoff mitigation.

16. Snow hauling and/or disposal plan, including sites for dumping snow or positioning of portable melter equipment for melting snow in place.
17. New runoff requirements for the containment and/or collection of deicing chemicals and vehicle maintenance fluids and materials.
18. Changes to or the addition of new contract service for clearing aprons.

2.4.2 Topics Relative to Air Carrier Ground Deicing/Anti-icing Programs.

The airport operator should act as a facilitator and arrange a meeting for the parties that may be affected by airplane ground deicing plans, including those plans required of air carriers operating under 14 CFR part 121. These parties include airport management and consultants, air carriers, other airport users, corporate tenants, pilot representatives, and FAA Air Traffic Control. The meeting should assess the impact of any airplane ground deicing activities on airport operations and identify actions that can be taken by the various parties to maximize the efficiency of operations during icing conditions. For example, the committee may be able to identify the most effective locations for secondary deicing and establish procedures for its implementation. At most airports, one meeting to discuss these subjects before the start of the winter season should suffice. However, at other airports, subsequent meetings may be necessary to assess the effectiveness of plans and to modify them if necessary. These meetings typically address the following topics:

1. Assessment of all air carriers' deicing programs from the previous year, including—
 - a. Reviewing airplane surface flow strategies.
 - b. Reviewing ground time and takeoff clearances after deicing.
 - c. Analyzing and adjusting to airplane deicing plans.
2. Actions needed by various parties (e.g., airport operator, aircraft operators, air traffic) to maximize efficiency of operations, including—
 - a. Identifying locations for airplane deicing that use chemicals or infrared deicing technology.
 - b. Planning taxi routes to minimize ground time.
 - c. Developing rates that control deiced departures.
 - d. Allocating departure slot capacities.
 - e. Determining airport deicing crew needs.
 - f. Verifying communication procedures between air traffic control and airplanes to be deiced.
3. Any requirements for containment/collection of deicing/anti-icings.

2.5 **Outlining a Snow and Ice Control Plan (SICP).**

- 2.5.1 A logical first step in writing the SICP is to identify and prioritize the timely clearing of snow and/or ice from aircraft movement areas. Paragraphs 1.6 and 1.8 of this advisory circular discuss airfield clearing priorities and clearance times. These parameters, in turn, guide the airport operator in selecting the conditions that initiate activities, such as, clearing operations, chemical applications, runway friction surveys, and other operations. Chapter 3 provides information on weather forecasting and weather system technology as one important tool useful as a head start for an appropriate response for winter storm forecasts.
- 2.5.2 Next, the SICP includes instructions and procedures for handling the various types of winter storms encountered by the airport and how to notify airport users in a timely manner of other than normal runway conditions, including, but not limited to: runway closures, and when any portion of the movement area normally available to them is covered by snow, slush, ice, or standing water.
- 2.5.3 When winter contaminants are present on airfield pavements, the airport operator must assess the conditions and take mitigating steps for the contaminant type.
- 2.5.4 Finally, the SICP addresses special safety topics to minimize runway incursions during initial and follow-up clearing operations. Paragraph 2.7 of this chapter offers guidance and recommendations for runway incursion mitigation.

2.6 **Topics for Writing Instructions and Procedures for Winter Operations and Notification.**

Part 139 airports are required to address the following topics in their SICP (see § 139.313(b)), and it is recommended that all other airport operators address the same topics in their SICP. Each topic provides a cross-reference for further clarification.

1. Prompt removal or control, as completely as practicable, of snow, ice, and slush on airfield pavements (see Chapter 4).
2. Positioning snow off airfield pavement surfaces so all airplane propellers, engine pods, rotors, and wing tips will clear any snowdrift and snow bank as the airplane's landing gear traverses any portion of the movement area (see Figure 4-1, Chapter 4).
3. Selection and application of authorized materials for snow and ice control to ensure they adhere to snow and ice sufficiently to minimize engine ingestion (see Chapter 4).
4. Timely commencement of snow and ice control operations.
5. Prompt notification in accordance with § 139.339, to all air carriers using the airport when any portion of the movement area normally available to them is less than satisfactorily cleared for safe operation by their aircraft (see Chapter 5, Paragraphs 5.8, *Requirements for Runway, Taxiway, and Apron and Holding Bay Closures*, and 5.6, *Condition Reporting*). In addition, all airplane operators should

be informed any time pavements are contaminated with ice, snow, slush, or standing water.

2.7 **Runway Incursion Mitigation and Operations During Non-Towered Air Traffic Control Periods.**

- 2.7.1 The SICP should contain specific procedures for those periods when the ATCT is closed and for airports that do not have an ATCT (non-towered airport). Additionally the SICP should contain specific procedures for unexpected situations, such as when “whiteout” conditions occur while snow clearing crews occupy the runways. The following items should be considered:
- 2.7.2 Surface clearing procedures must ensure snow removal operations will not create the possibility for a runway incursion after the runway reopens, for example, signage, markings and lighting are clearly visible.
- 2.7.3 Although it is not required, airport operators should consider closing runways during snow clearing operations. For airport operators that choose to keep runways open during such operations, the SICP should include procedures requiring continuous coordination among the clearing crew and the SCC to ensure the equipment operators on runways are aware of their surroundings. Snow removal equipment operators should monitor appropriate air traffic control (ATC) or other frequencies for information on approaching or departing airplanes.
- 2.7.4 The overlying air traffic control frequency should be monitored along with the local frequency by the airport’s Snow Control Center at all non-towered airports and at airports where the ATCT has less than 24-hour operations. This should apply even if a NOTAM has been issued closing the runway for snow clearing operations. Such monitoring is especially important during marginal visual meteorological condition (VMC) and instrument meteorological condition (IMC).

Note: The overlying air traffic facility may be enroute, terminal, or flight service. Monitoring is recommended for snow crews to hear an airplane approaching and therefore be able to clear the runway of personnel and equipment, if necessary. At times air traffic control and /or the pilots may not be aware of a runway closure at the non-towered airport. That is, sometimes a NOTAM is issued after an airplane becomes airborne and the pilot did not receive the latest update, especially at an uncontrolled airfield. The FAA recommends that NOTAMs for runway closures, snow removal operations, and any other lengthy maintenance activities at uncontrolled airports be directly coordinated with the overlying air traffic control facility (TRACON or ARTCC) when the operation will begin in less than 60 minutes.

- 2.7.5 Include special snow crew communication procedures for “whiteout” conditions at both towered and non-towered airports.
- 2.7.6 Include special snow crew communication procedures for occasions when a single equipment operator needs to return to the runway after a major clearing event.

2.8 **Staff Training and Recordkeeping.**

The SICP should describe qualification criteria and training for individuals directly involved in snow and ice control operations. The SICP should also outline recordkeeping procedures for tracking employee progress in achieving training goals and objectives. The SICP may specify that an implemented training program contain specific course material for equipment drivers, staff working in the Snow Control Center, etc. Although airport operators should develop their own training programs to address conditions at their particular airports, the FAA recommends the programs contain the following minimum components:

1. Formal classroom lectures, training films if available, and discussion periods to teach the contents of the SICP to individuals who need to understand procedures in detail.
2. Tabletop exercises that use miniature equipment on airfield layouts to simulate operations.
3. Hands-on training for equipment operators on how their equipment works as well as practice runs under typical operational scenarios.
4. Instruction on airfield familiarization that includes both day and night tours of the airfield and ensures an understanding of all surface markings, signs, and lighting.
5. Instruction for all personnel on proper communication procedures and terminology. This includes the special procedures to be followed during “whiteout” conditions and when radio signal is lost between drivers and/or the ATCT. See FAA AC 150/5210-20, *Ground Vehicle Operations on Airports*, for guidance on communication procedures for airport personnel.
6. Instruction for drivers on the proper procedures and communications to follow when the ATCT is not operating or the airport has no ATCT.
7. Training in following runway closure criteria for personnel responsible for closing and opening runways during snow events. This training is especially important for non-towered airports or part-time towered airports.
8. Examples of common runway incursions during snow removal operations.

2.9 **Other Related Items.**

The implemented SICP should integrate with other airport plans, programs, and lease agreements.

2.9.1 Other Airport Plans and Programs.

Although the SICP is a stand-alone plan, it should integrate with other airport plans and programs to avoid conflicts and duplication of procedures and responsibilities. A few examples of closely related plans/programs are the *Airport Certification Manual*, *Airport Emergency Plan*, and the *Storm Water Pollution Prevention Plan* (for deicer runoff mitigation). The FAA recommends the airport fire-fighting and rescue service receive a copy of the SICP, especially so responders will know which service roads will be closed.

2.9.2 Post Accident/Incident Recommendations.

2.9.2.1 To address accidents or incidents that might occur during adverse weather conditions, the SICP should contain procedures that ensure surface conditions occurring during the event are properly inspected and documented. Additionally, the airport operator must not disturb evidence on the runway until the appropriate Federal authority (FAA/National Transportation Safety Board (NTSB)) provides a release. To help the NTSB, the airport operator should document the type and depth of contamination on the runway at the time of the accident/incident, which should include conducting a runway friction assessment and taking still and/or video photography.

Note: Refer to Paragraph 5.1.4 to address conditions that are acceptable to use decelerometers or continuous friction measuring equipment to conduct runway friction surveys on frozen contaminated surfaces.

2.9.2.2 If wreckage is observed on the pavement, the airport operator must not attempt to conduct testing in those areas that would disturb evidence on the runway (see AC 150/5200-12, *Fire Department Responsibility in Protecting Evidence at the Scene of an Aircraft Accident*).

2.9.3 Snow and Ice Control Contractors/Lease Agreements.

The principle of ensuring safety of operations applies equally to lease holders and service contractors hired to perform snow and ice control services. In particular, contractual agreements should be clear and specific in terms of duties, procedures for snow and ice control, responsibilities for communications and ground control, and other contingencies. Service contractors and leaseholders should receive a copy of the latest airport SICP, not necessarily the complete *Airport Certification Manual*. Contracted service providers are recommended to have the same training as described in Paragraph 2.8.

2.9.4 Storm Water Runoff Regulations.

Greater emphasis has been placed on mitigating the negative impacts associated with snow clearing operations and equipment maintenance on bodies of water off the airport. The SICP should be reviewed and modified, if necessary, to ensure it complements the airport's storm water discharging permit. That is, the SICP should help the airport operator achieve compliance with Federal, State, and local environmental storm water runoff regulations.

CHAPTER 3. FORECAST TECHNOLOGY FOR AIRPORT OPERATORS

3.1 Weather Forecasting.

Appropriate responses to a winter storm event begin with accurate and timely weather information. A reliable weather forecast not only enhances the effectiveness and efficiency of any SICP, but it offers airport operators operational cost savings associated with snow clearing tasks, chemical usage, and staffing. Airport operators should base their snow clearing operations or preventive measures on weather forecasting that offers continuous, up-to-date, and airport weather-related information. The FAA recommends that airport operators select a weather forecasting approach that offers usable information to airport users as well as to the airport operator. One such approach, the Weather Support to Deicing Decision Making (WSDDM) System, is described below.

3.2 FAA Forecasting Research and Development for Airport Operators.

The FAA Aviation Weather Research Program began research in the 1990s to fully understand the safety problems faced during winter storm events and to improve decision making by airport operators and air carrier ground operations during these events. The research resulted in the Weather Support to Deicing Decision Making (WSDDM) System, an integrated display system that depicts accurate, real-time determinations of snowfall rate, accumulations and their liquid equivalents, temperature, humidity, wind speed, and direction of storm events.

3.2.1 Weather Support to Deicing Decision Making (WSDDM) System.

The WSDDM System is an automated system that analyzes and forecasts short-term winter weather conditions within the airport vicinity. The data inputs to the system are provided by snow gauges; weather radars, such as Doppler; surface weather stations; and National Weather Service Aviation Routine Weather Report (METAR) data from Automated Surface Observing Systems (ASOS). All data are processed by software algorithms to produce a graphical and text depiction of current weather conditions and a 1-hour forecast of expected snowfall rate and accumulation at the airport. The displayed analyses and forecasts can be easily understood by most users. The graphical data can be generated and displayed on a local computer or viewed online. The system has been effective at major U.S. airports.

3.2.1.1 The basic version of the WSDDM system, known as Basic WSDDM, is for unidirectional storm fronts. The system has a single snow gauge with a computer display of the current and historical liquid equivalent snowfall rates and accumulation. Airports that routinely encounter multiple storm fronts should use two or more snow gauges. Figure 3-1 shows one type of snow gauge used by WSDDM. Figure 3-2 illustrates the Basic WSDDM schematic for a unidirectional storm configuration.

3.2.1.2 WSDDM systems must comply with the equipment performance and installation requirements described in Society of Automotive Engineers

(SAE) *Aerospace Standard (AS) 5537, Weather Support to Deicing Decision Making (WSDDM), Winter Weather Nowcasting System*. The SAE specification is available for purchase at <http://www.sae.org>.

3.2.2 Safety and Operational Benefits.

The WSDDM system provides current and 1-hour NOWCAST forecasts (current conditions) of snow bands and surface weather conditions on the airport and the surrounding 125-mile (200-km) vicinity. The display is optimized to allow airport operators and air carriers to understand (typically within 1 minute) the current weather conditions at the airport and in the surrounding region. This capability allows for more rapid and appropriate decision making during winter storms with minimal impact on airport resources and staff workload.

Figure 3-1. ETI Precipitation Gauge in a Single Alter Wind Shield 2 Type

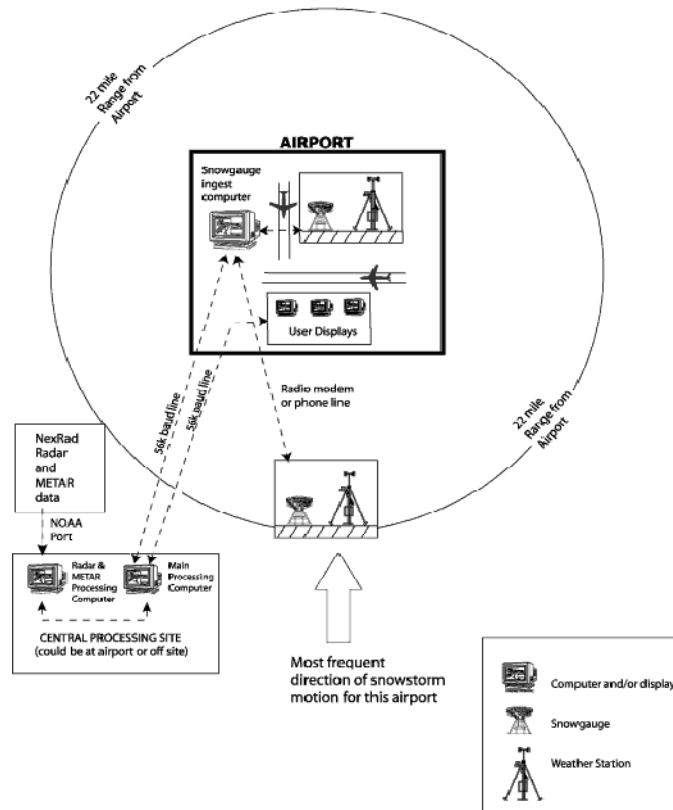

Figure 3-2. Schematic of Unidirectional Storm WSDDM Configuration

3.2.2.1 Benefits to Airport Operators.

Users of WSDDM have reported various operational and cost-saving benefits. WSDDM optimizes runway clearing operations by providing airport operators more accurate information about when a snow band will affect the airport. Accurate timing saves on anti-icers because it allows crews to apply them according to the manufacturer's recommended lead times. In terms of managing crew workloads, WSDDM determines gaps in storm events, which can be used to change crew shifts, take rests, and refill chemical trucks, sand spreaders, and other equipment. Airport operators are also able to more accurately determine when the airport can resume normal operations by examining the radar loops and storm tracks and watching storm trends. By examining the storm tracks, users can make fairly accurate 3- to 4-hour forecasts of snow onset, which, in turn, allow airport operators to prepare more appropriately for winter storms.

3.2.2.2 Real-Time Liquid Content Forecast.

A key safety element of the WSDDM system is the use of one or more precision snow gauges. These snow gauges provide real-time estimates of the liquid equivalent snowfall rate for every minute. The improved accuracy

of the WSDDM system reporting is key to air carrier deicing operations because the deicing community has shown *the improper liquid equivalent snowfall rate reporting is the key factor leading to the failure of deicing/anti-icing fluids*. The current National Weather Surface METAR stations do not provide this data. Instead, METAR provides hourly snow intensity estimates based on *visibility*. Snow intensity estimates based on visibility have been shown to be misleading when wet snow, heavily rimed snow (snow that has accreted significant amounts of cloud droplets), and snow containing single crystals of compact shape (nearly spherical) occur. Researchers define the hazard as high-visibility/high-snowfall rate conditions. Recent examination of five of the major airplane ground deicing accidents showed that high visibility-high snowfall rate conditions were present during a number of these accidents. All of the accidents had nearly the same liquid equivalent rate of 0.1 inch/hour (2.5 mm/hour), but widely varying visibilities. The WSDDM System was designed to address this safety concern by including snow gauges to measure liquid equivalent snowfall rate every minute.

3.3 **Forecasting Runway Surface Conditions.**

One proven method of forecasting the surface conditions of runways is to use runway surface condition sensors (RSCS). Two basic types of RSCS are in use today, namely in-pavement stationary sensors and vehicle-mounted infrared sensors. The safety benefit of RSCS is their predictive capability for proactive anti-icing decision making. Since the temperature of pavements lag behind air temperature, the use of air temperature to infer surface conditions is imprecise. Therefore, the use of air temperature is not preferred over pavement temperature when available because it frequently leads to misinformation about the true behavior of pavement surfaces. The RCAM's use of outside air temperature (OAT) is due in part to the unavailability of surface temperature at most airports. This inaccuracy can result in inappropriate airfield clearing operations or poorly timed preventive measures. At its worst, this misinformation might result in delays that allow ice to bond to paved surfaces, the hardest condition to rectify. With the exception of freezing rain, ice will not form on pavements unless the pavement temperature itself reaches the freezing point. Therefore, knowledge of the direction and rate of temperature change within a pavement structure provides the predictive capability as to when to expect the formation of ice. The predictive nature of RSCS is particularly valuable as it ensures the timely application of anti-icing (or deicers) chemicals, which provides a cost savings in chemicals, and helps crews make appropriate chemical selections to prevent, weaken, or disbond ice or compacted snow from paved surfaces. Airport operators have at their disposal in-pavement RSCS at pre-determined sites and mobile RSCS that are hand-held or vehicle-mounted to evaluate any pavement.

3.3.1 Stationary Runway Weather Information Systems.

These stationary sensors provide only site-specific pavement and air temperature trends, dew point temperature, chemical strength, and other atmospheric weather conditions at

the installation sites. Sensor information is generally disseminated via a central computer to airport users. An added bonus of in-pavement RSCS is their ability to predict when previously applied chemicals have been diluted sufficiently to require reapplication of chemicals. The FAA recommends that in-pavement RSCS comply with the performance and installation requirements of *SAE Aerospace Recommended Practice (ARP) 5533, Stationary Runway Weather Information System (In-pavement)*. The SAE specification is available for purchase at <http://www.sae.org>.

3.3.2 Mobile Infrared Surface and Ambient Temperature Sensor Systems.

These vehicle-mounted sensors provide pavement and air temperatures at any desired airfield pavement location. Information is disseminated directly to the viewer or driver of the vehicle-mounted units. The FAA recommends that mobile RSCS comply with the performance requirements of *SAE ARP 5623, Mobile Digital Infrared Pavement Surface, Ambient Air and Dew Point Temperature Sensor System*. The SAE specification is available for purchase at <http://www.sae.org>.

This page intentionally left blank.

CHAPTER 4. SNOW CLEARING OPERATIONS AND ICE PREVENTION

4.1 Introduction.

Contaminants on a runway impede airplane acceleration by absorbing energy in compaction and displacement, and by impinging on parts of the airplane after being kicked up by the tires. For airplanes decelerating, slush, snow, and standing water-covered pavements and, especially iced surfaces, hamper deceleration rates due to a reduction in the friction coefficient of the runway and the potential for hydroplaning. Large chunks of ice, from refreezing snow or slush, or deposits from aircraft gear created during landings, can cause severe damage to tires, engines, and airframes. Wet snow, slush, and standing water can cause structural damage from spray impingement or by engine ingestion, which can affect acceleration capability. The recommended maximum depth for takeoff operations for slush and water is ½ inch (13mm) unless the airplane's AFM shows greater depths to be safe (see AC 25-31, *Takeoff Performance Data for Operations on Contaminated Runways*). Consequently, these runway surface contaminants should be minimized to maintain safe landing, takeoff, and turnoff operations. For these reasons, snow clearing operations for Priority 1 runway(s), taxiway connectors, and taxiways to the terminal(s) should start as soon as practicable after snowfall or icing begins. One prime goal is to take the appropriate measures so snow in its various forms, such as slush or frozen water, does not bond to the pavement. Dry snow falling on cold dry pavements will generally not adhere and may be blown off by wind or airplane operations or removed by brooming operations. In such conditions, only brooming may be needed to prevent the formation of compacted snow tracks. Snow fences may be of use to airports that primarily experience dry snowfalls. Wet snow, however, cannot be blown off the pavement and will readily compact and bond to it when run over by airplane wheels. Consequently, the airport operator needs to implement different clearing and/or preventive measures for wet snow than those used for dry snow conditions. When measures are taken, the airport operator's Snow Control Center (SCC) should (1) maintain close coordination with the ATCT and the Flight Service Station (FSS) or UNICOM to ensure prompt and safe responses to winter storm events and (2) inform the users of the airport when less than satisfactory conditions exist.

4.2 Snow Clearing Principles.

Winter conditions and rates of accumulations of precipitation vary widely from airport to airport. However, there are some basic guidelines that apply to all airports that should be followed as closely as possible. The airport operator should notify airport users promptly and issue a NOTAM advising users of unusual airport conditions. Wind speed and direction, available equipment, and local conditions that may require special equipment and techniques, collectively determine the snow clearing procedures for the airport's SICP. The following guidance offers a generic outline for writing the SICP that covers terminal apron environment-related items, runway/taxiway-related items, and areas with special surface material such as Engineered Material Arresting Systems.

4.2.1 Terminal Apron Suggested Clearing Objectives.

Accumulations of snow and slush, snow tracks, and thin layers of ice on aprons and airplane parking areas, including holding bays, can make for safety hazards. The SICP should contain measures to mitigate at least the following five common situations:

1. **Slick Apron Surfaces.** Apron equipment and apron personnel operating on slick or icy apron surfaces lack sufficient traction to start, stop, or even remain in place when encountering jet exhaust from surrounding airplanes. Maintaining good traction is critical to the safety of personnel, equipment, and airplanes.
2. **Increased Airplane Engine Thrust.** Pilots of parked or holding airplanes apply increased engine thrust to break away, maneuver, and taxi under adverse apron surface irregularities, such as frozen ruts formed by tire tracks. The resultant excessive engine blast necessary to overcome such obstacles may damage other airplanes, apron equipment, or apron personnel.
3. **Obscured Taxiway Signage.** The clearing of snow from apron areas should not be performed in a way that partially or completely covers taxiway signs with plowed snow. *Observing this precaution will reduce the risk of runway incursions.*
4. **Obscured Terminal Visual Aids.** The obscuration of normally visible surface markings or obliterated sign messages could make maneuvering on aprons difficult and slow. Pilots, unable to see these visual aids, are hard pressed to judge direction and taxiing clearances.
5. **Snow Stockpiles Adjacent to Airplane Operating Areas.** Airport operators should exercise care when moving snow from the aprons and terminal toward taxiways and runways. Locate snow and ice stockpiles at a sufficient setback such that aircraft wingtip hazards are eliminated. Depending on the amount of snow cleared and the size of the apron, apron signage directing pilots toward the runway could become obscured (covered with snow), and the resulting height of snow stockpiles could cause a clearance issue between taxiing airplanes and the snow stockpile. Airports that experience heavy snowfalls and have large aprons with limited space for stockpiling snow should consider operating snow melters or hauling snow away.
 - a. The strategy for snow and ice removal will be unique to the airport configuration and amount of precipitate to be cleared. A phased removal process will allow the operator to focus effort on aprons areas necessary to re-establish minimum aircraft operations.
 - b. Areas of the apron not immediately needed for aircraft operations may be used as temporary storage of snow from Priority 1 areas. Removal of these snow piles can occur during low activity hours to limit interaction with taxiing aircraft.
 - c. Airports with constrained terminal apron area space may not have adequate space to stockpile snow even on a temporary basis. Such locations may need to haul snow from the terminal apron to another location on the airport. Hauling requires additional safety and environmental considerations. Escort of haul trucks must be optimized to limit interaction with parked and taxiing

aircraft. Snow melt from the stockpiles location must consider water quality requirements.

- d. Some locations may find the use of snow melters for removing snow from Priority 1 terminal areas to be advantageous. These locations will typically have constrained terminal apron space and experience frequent heavy snowfalls on a recurring annual basis. Considerations for using snow melters include cost, safety, environment, frequency of heavy snow, and airport operations.
- e. Some locations may find a combination of hauling and melting to be optimum in removing snow in an efficient manner.

4.2.2 Runway and Taxiway Suggested Clearing Objectives.

The following guidance is intended to show efficient use of various equipment to optimize snow clearing operations. Some types of equipment may not be appropriate for some airports. Equipment and procedures used must be determined based on many factors, including but not limited to climate, number and types of operations, and amount of annual snowfall.

4.2.2.1 Focus runway snow clearing operations on keeping the entire primary runway(s), as near as practicable, bare from snow accumulations or ice buildup. Depending on the precipitation rate, the time required to clear the full width of the runway may result in additional accumulation, and thus less braking capability, on the critical center portion. In such a case, concentrating on the center portion of the runway, during the initial clearing operations can result in greater safety. The minimum width required will vary by airplane type, but is generally 100' for transport category airplanes. The airport operator should check with airport users regarding their minimum runway width requirements. Additionally, the airport operator should keep in mind that the entire width of runway is still usable and must be safely maintained. This means that while contaminant depths may vary from the center cleared portion to the remaining portions of the runway, the condition of the outlying portions must not present a hazard. Use sweepers or brooms initially to keep the primary runway or its center portion, as near as practicable, bare of accumulations. Also, when snow has melted or ice begins to separate from the pavement due to the action of chemicals, sweepers or brooms should be used to remove the residue. As soon as snow has accumulated to a depth that cannot efficiently be handled by the sweepers or brooms, displacement plows and rotary plows (snow blowers) should be used as follows.

1. Use displacement plows, in tandem if more than one, to windrow snow into a single windrow that can be cast over the edge of runway lights by a rotary plow.
2. For runways or other paved areas with in-pavement surface condition sensors, remove any snow or ice that affects the performance of the remote sensors.

3. Regarding the use of displacement plows, ice and snow will always melt around runway centerline and touchdown zone light assemblies. However, under cold temperature and with LED fixtures, ice rings, termed “igloos,” tend to form around them. In order to prevent damage to lights, use appropriate polyurethane cutting edges or shoes and casters on plow moldboards and on the front of rotary plows.
 4. Rotary plows should throw snow a sufficient distance from runways/taxiways edges so adequate clearance is available between airplane wings and engine nacelles and the cast snow banks. Figure 4-1 shows desired maximum snow height profiles, which are based on airplane design groups.
- 4.2.2.2 All drivers must maintain a safe distance between equipment operating in echelon (i.e., V-formation, close wing formation) in order to avoid accidental contact or accidents (see Figure 4-3, Figure 4-4, and Figure 4-5).
- 4.2.2.3 Obscured visual aids—in particular, in-pavement and edge lights, taxiway markings, runway markings (such as touchdown marking), airport guidance signs, and runway end identification lights (REIL), precision approach path indicator (PAPI) or visual approach slope indicator (VASI)—should be maintained free of snow and ice.
- 4.2.2.4 A covering of snow and ice or drifts may affect visual and electronic NAVAIDs. Any snow or ice that affects the signal of electronic NAVAIDs should be removed. When clearing with rotary plows and displacement plows, special procedures need to take into account the location of all NAVAIDs, especially to protect the guidance signal of instrument landing systems (ILS). The SICP needs to address the following situations:
- 4.2.2.4.1 Glide slope critical ground areas along the runway require that snow depths be limited in height to prevent signal loss or scattering. Figure 4-2 provides graphic representations of the glide slope ground snow clearance areas with prescribed snow depth limitations according to type of facility and aircraft approach category. When snow depths exceed the specified depth limitations, minima are raised to the “localizer only” function until the conditions revert or are corrected.
- 4.2.2.4.2 Two consecutive pilot reports of glide slope signal malfunctions generally result in raised minima (a NOTAM must be issued by the owner of the NAVAID). A few additional points should be considered:
- The 200-foot width dimension adjacent to the threshold might be wider for an antenna mast placed further out (see FAA Order 6750.49, *Maintenance of Instrument Landing System (ILS) Facilities*).
 - The snow clearance areas illustrated in the figures are minimal in size.

- Snow clearing activities should not allow snow banks, mounds, or ridges exceeding 2 feet to be placed along the edges of the prescribed snow clearance areas.
- Snow banks should not be placed off the approach ends of runways, especially for CAT II/III operations.

Note: Snow banking operations need to take into account the guidance in Figure 4-1.

- 4.2.2.4.3 Visibility of signs (legibility) and lights should be maintained by certain prescribed clearing techniques or by performing post-clearing maintenance. Maintaining visibility can be better achieved by taking into account wind directions. For example, in crosswind conditions, cast in the downwind direction. Figure 4-3 through Figure 4-5 provide general guidance.
- 4.2.2.4.4 The snow depth height limitations noted in Figure 4-1 do not take into consideration airplane characteristics. That is, at some airports, airplane characteristics, such as engine clearances, may dictate lower snow banks than shown in Figure 4-2. The objective here is prevention by avoiding the introduction of hazardous snow banks, drifts, windrows, and ice ridges that could come into contact with any portion of the airplane wing or nacelle surface.
- 4.2.2.5 If the airport's operation involves the use of snow banks, their height profiles should be compatible with NAVAID ground requirements and offer sufficient clearance between airplane wings and engine nacelles to avoid structural damage to jet and propeller airplanes. Figure 4-1 shows maximum allowable snow height profiles, which are based on airplane design groups (see AC 150/5300-13, *Airport Design*, for airplane design group categories.) Snow banking along terminal or cargo aprons likewise should comply with Figure 4-1 to prevent operational problems caused by ingestion of ice into turbine engines or by propellers striking the snow banks. Appendix B, which used numerous airplane models, was used to develop criteria for Figure 4-1.
- 4.2.2.6 Airport operators' actions associated with periodic assessments based on changing conditions, completion of snow clearing operations, or any other contaminant clearing requirements provided for in the SICP, runway assessments and friction measurements should be accomplished to determine the effectiveness of the clearing operation. See Chapter 5 for additional guidance.
- 4.2.2.7 If the runway pavement temperature is warm enough for snow to compact and bond, or if freezing rain is forecasted, approved anti-icing chemicals and/or heated sand should be applied prior to the start of precipitation or as soon as precipitation starts. Some airport operators prefer to apply deicing chemicals rather than anti-icing chemicals for different weather conditions.

Paragraph 4.6 provides a listing of approved fluid and solid material specifications.

- 4.2.2.8 All snow removal units operating in aircraft movement areas must maintain radio communication with the ATCT, if one exists, or be under the direct control of a designated supervisor who in turn is in direct communication with the ATCT.
- 4.2.2.9 High-speed runway turnoffs require the same attention for ice and snow control and removal as runways. These turnoffs should offer sufficient directional control and braking action for airplanes under all conditions. Accident data clearly illustrate that poor attention to high-speed runway turnoffs contributes to veer offs.
- 4.2.2.10 Joint-use airports with military operations may have arresting barriers located near the end of the runway or at the beginning of the overrun areas. Great care should be taken in clearing snow from the barriers. Barriers located on the runway should be deactivated and pendants removed prior to snow removal operations. Snow should be removed to the distance required for effective run-out of the arresting system.

4.2.3 Engineered Material Arresting System (EMAS) Suggested Clearing Objectives.

- 4.2.3.1 EMAS installed at airports require special attention as relates to removal of contaminants. Most are designed to be mechanically or manually cleared of contaminants. The manufacture specifications should be followed in order to determine what types of equipment are compatible with the EMAS bed and recommended clearing procedures and/or limitations. See AC 150/5220-22, *Engineered Materials Arresting Systems (EMAS) for Aircraft Overruns*, for additional guidance.
- 4.2.3.2 Identify compatible deicing agents and the equipment, tools, or process for application.

Figure 4-1. Snow Bank Profile Limits Along Edges of Runways and Taxiways with the Airplane Wheels on Full Strength Pavement (see Figure 4-2 guidance)

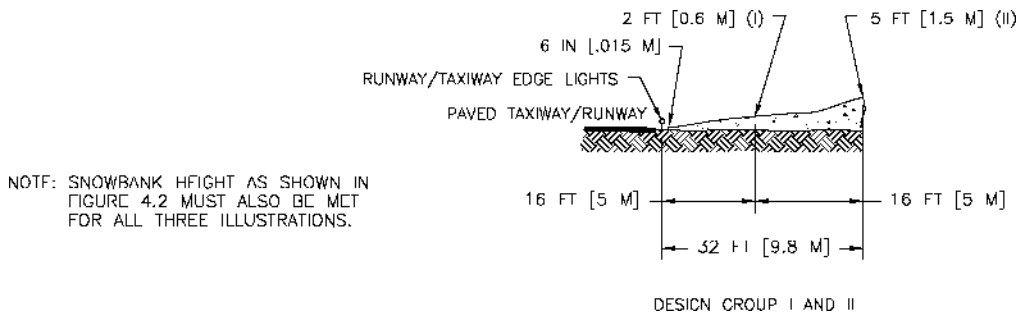
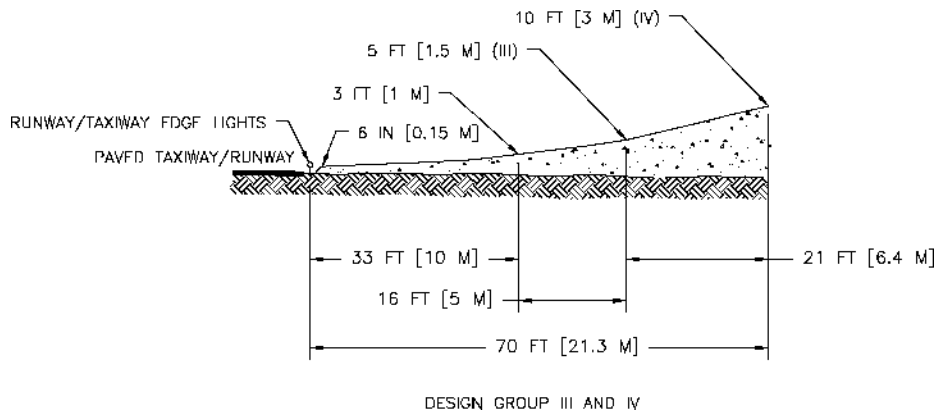
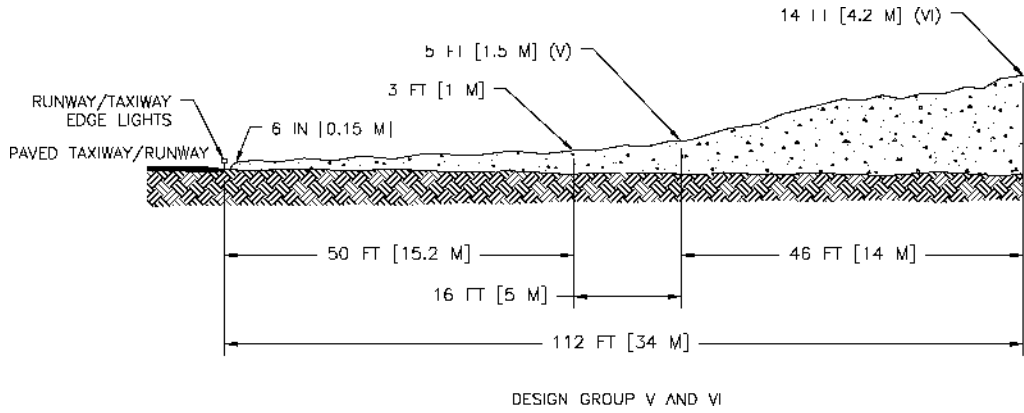

NOTE: SNOWBANK HEIGHT AS SHOWN IN FIGURE 4.2 MUST ALSO BE MET FOR ALL THREE ILLUSTRATIONS.

Figure 4-2. ILS CAT I and CAT II/III Snow Clearance Area Depth Limitations

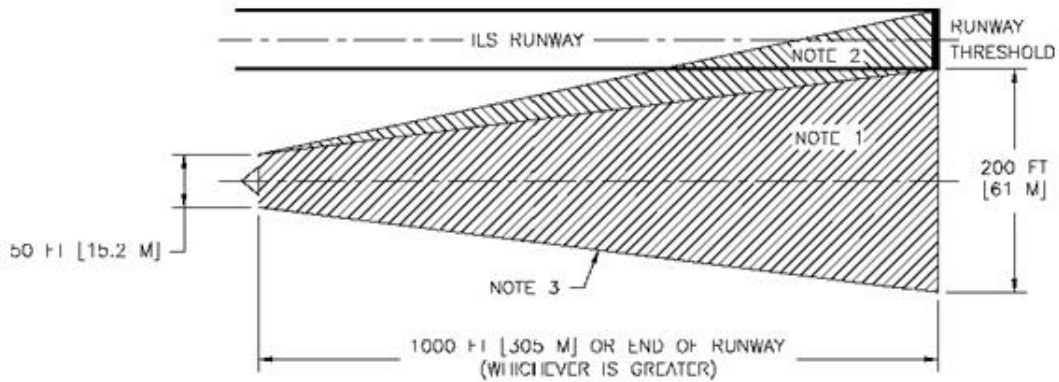

NOTES:

1. CATEGORY I GLIDE SLOPE SNOW CLEARANCE AREA.
2. CATEGORY II AND III GLIDE SLOPE SNOW CLEARANCE AREA. THE AREA DEPICTED UNDER NOTE 1 SHALL ALSO BE CLEARED.
3. THE DEPTH OF SNOWBANKS ALONG THE EDGES OF THE CLEARED AREA SHALL BE LESS THEN 2 FEET.

| ACTION TAKEN | SNOW DEPTH | | |
|------------------------------------|--|---|--|
| | SBR <6 IN [15 cm] NR. CEGS <18 IN [45 cm] | SBR 6 TO 8 IN [15 TO 20 cm] NR. CEGS 18 TO 24 IN [45 TO 60 cm] | SBR >8 IN [20 cm] NR. CEGS <24 IN [60 cm] |
| SNOW REMOVAL (SEE ABOVE FIGURE) | REMOVAL NOT REQUIRED TO RESTORE FULL SERVICE AND CATEGORY. | <p style="text-align: center;">ILS CATEGORY I</p> <p>REMOVE SNOW 50 FT [15M] WIDE AT MAST WIDENING TO 200 FT [60M] WIDE AT 1000 FT [300M] OR END OF RUNWAY TOWARD MIDDLE MARKER.</p> <p style="text-align: center;">ILS CATEGORIES II AND III</p> <p>AS ABOVE PLUS WIDEN THE AREA TO INCLUDE A LINE FROM THE MAST TO THE FAR EDGE OF RUNWAY THRESHOLD.</p> | |
| NO SNOW REMOVAL | RESTORE FULL SERVICE AND CATEGORY. | <p style="text-align: center;">ALL CATEGORIES</p> <p>RESTORE TO CATEGORY I SERVICE. CATEGORY D AIRCRAFT MINIMA RAISED TO LOCALIZER ONLY.</p> <p>TYPICAL NOTAM TEXT:</p> <p>"DUE TO SNOW ON THE IXXX (APPROPRIATE IDENTIFIER) GLIDE SLOPE, MINIMA TEMPORARILY RAISED TO LOCALIZER ONLY FOR CATEGORY D AIRCRAFT" IF APPLICABLE, "CATEGORY II NA" OR "CATEGORY II/III NA".</p> | <p style="text-align: center;">ALL CATEGORIES</p> <p>APPROACH RESTRICTED TO LOCALIZER ONLY MINIMA.</p> <p>TYPICAL NOTAM TEXT:</p> <p>"DUE TO SNOW ON THE IXXX (APPROPRIATE IDENTIFIER) GLIDE SLOPE, MINIMA TEMPORARILY RAISED TO LOCALIZER ONLY.</p> |

* NA (NOT AUTHORIZED)

Figure 4-3. Possible Team Configuration with Perpendicular Wind

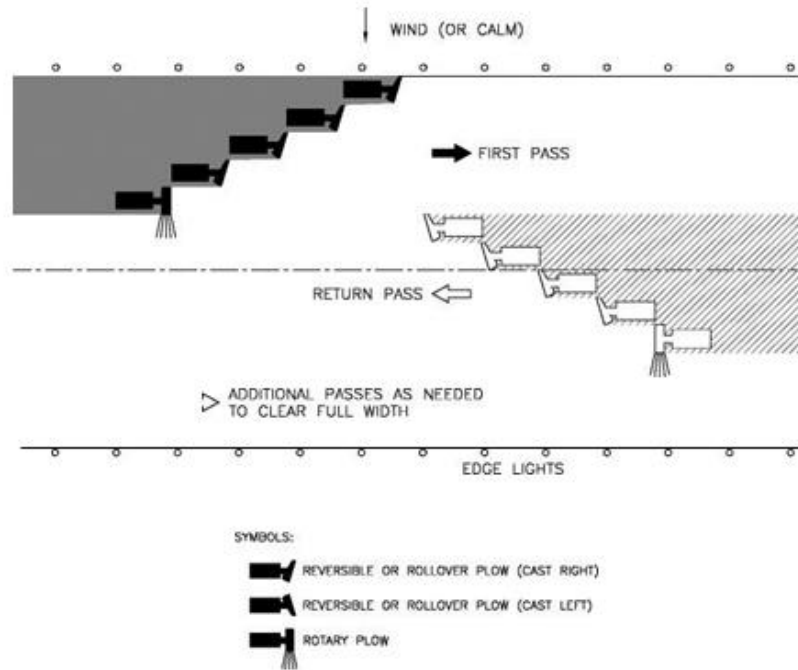

Figure 4-4. Possible Team Configuration During Light Snowfall with Parallel or Calm Wind

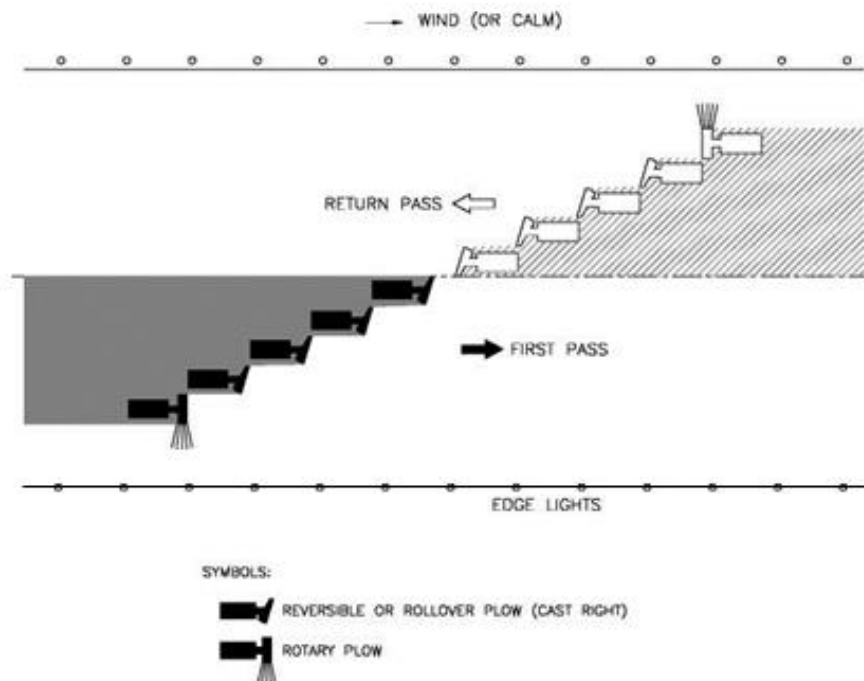
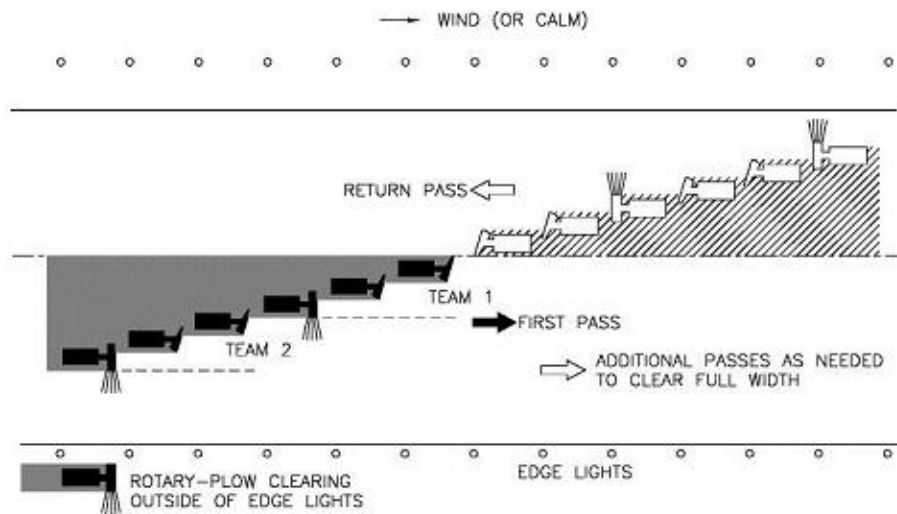

Figure 4-5. Possible Team Configuration During Medium to Heavy Snowfall with Parallel or Calm Wind (Dependent upon Rotary Plow performance)



4.2.4 Surface Incident/Runway Incursion Mitigation Procedures.

The FAA recommends the SICP contain specific safety procedures or a separate written section to mitigate the possibility for surface incidents/runway incursions. These specific safety procedures should provide answers to, at a minimum, the following two questions: (1) How can pilots of the various types of airplanes or vehicle drivers traversing the airfield cause a runway incursion because of our snow clearing operations? and (2) How do snow operation personnel at either non-towered airports or airports with less than 24-hour ATCTs monitor information released by the ATC enroute center? The procedure addressing the latter questions should apply even if a NOTAM has been issued closing the runway for snow clearing operations. This precaution is especially important during marginal visual meteorological condition (VMC). The SICP should address the following topics:

4.2.4.1 **Radio Communications.**

Equipment operations should be timed carefully and coordinated properly with team members to ensure an orderly turnaround for safe return and start of a new pass. The SICP should designate a lead operator for each shift who maintains contact with his team members and the ATCT. At airports lacking an ATCT or when the tower is closed, proper radio communications must be maintained at all times and in accordance with SICP procedures. Consideration should be given to providing vehicle operators with headphones to minimize ambient noise disruption from vehicular noise.

4.2.4.2 **Failed Radio Signals.**

The SICP must outline specific procedures when radio signal is lost between crews and when a single driver loses radio signal. All drivers must be trained in the specific procedures to follow.

4.2.4.3 **Airfield Signage and Lights.**

Airfield signs must be kept clean of contaminants to maintain the legibility of signage. Priority should be given to lights and signs associated with holdlines, direction and location signs, and ILS critical areas. Common methods to remove snow from signs include using a truck mounted with an air-blast unit, spraying the faces of signs with an approved liquid deicer, or hand shoveling.

4.2.4.4 **Low Visibility and Whiteouts.**

It is of utmost importance to maintain visual contact with your surroundings during snow clearing operations, especially for operations in an echelon formation. The SICP should specify procedures to follow if visibility suddenly drops to near zero or whiteout conditions exist while clearing operations are in progress. For example, the airport operator may require that all equipment stop immediately with all drivers radioing in their positions to the designated supervisor or to ATCT for runway evacuation instructions.

4.2.4.5 **Driver Fatigue.**

Consideration should be given to monitoring the “*windshield time*” of drivers (length of shift) operating snow removal equipment because operator fatigue could become a contributing factor for runway incursions. In response, some airport operators have implemented limits on driver operating hours.

4.3 **Controlling Snow Drifts.**

Preventing snow from drifting onto operational areas at airports receiving severe winter storms reduces the duration and frequency of snow clearing operations. Two methods for controlling drifts are described below.

4.3.1 Snow Fences.

Snow fences that are properly designed and located can reduce windblown snow across airfields. Experience at a particular airport is the most helpful in determining optimum locations for snow fences. The following precautions and guidance are provided:

- 4.3.1.1 Prior to any installations, the airport operator must contact the local technical operations for any planned installations in the vicinity of a NAVAID system. Failure to remove snow or the introduction of snow in areas adjacent to NAVAID systems could result in erroneous signal guidance or facility shutdown.

4.3.1.2 Snow fences should be located upwind of the area to be protected.

4.3.1.3 A study conducted by the U.S. Department of Agriculture showed 12-foot (3.7-m) high fences were generally most effective. Shorter heights can be and usually are necessary on airport property, since snow fences must not be located near critical surfaces, in Runway or Taxiway Safety Areas, or Object Free Areas, as defined in AC 150/5300-13.

4.3.2 Snow Trenches.

Snow trenches that catch and store drifting snow have been used at times by airports with heavy snowfalls. This approach is considered an expedient way to control snow from drifting after it has been cleared to the edge of the runway. Multiple trenches spaced longitudinally about 10 feet (3 m) apart running parallel to the runway can store more snow. A trench should be excavated no closer than 50 feet (15 m) from the runway. Figure 4-6 illustrates typical snow trench formation relative to wind direction.

Figure 4-6. Typical Snow Trench Dimensions

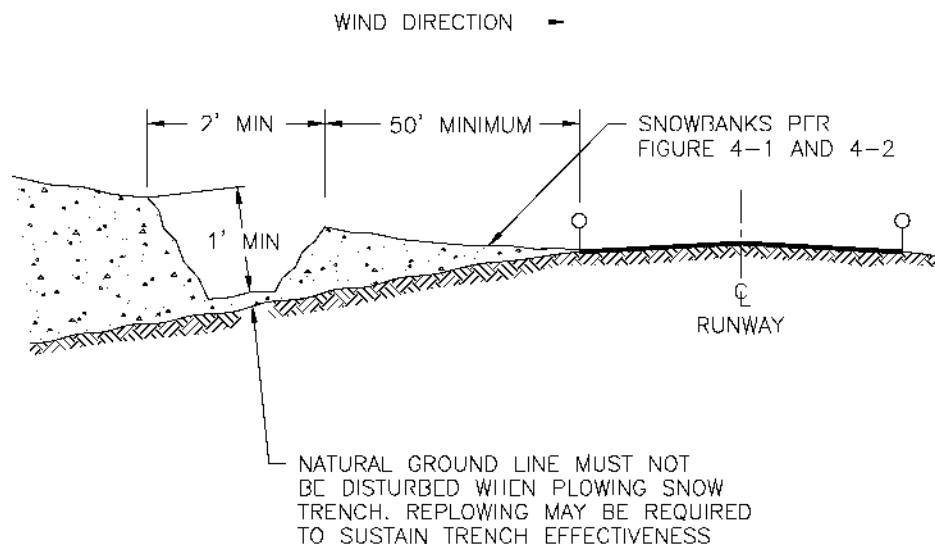

4.4 **Snow Disposal.**

The SICP should also specify how and where large quantities of snow are to be disposed. Two common approaches are as follows:

4.4.1 Melting Pits or Portable Melters.

Various airports have been using snow and ice melters to deal with frequent large snow events and the environmental mitigation of deicer chemicals. The use of snow melters in lieu of hauling may be advantageous for certain airports given the frequency of heavy snowfalls and terminal area space constraints. Use of snow melters is mostly appropriate in the terminal area. It is not necessary to melt Priority 1 area snow located on taxiways and runways. Because the objective is to remove the snow from the

Priority 1 apron area, it is prudent that sponsors considering the use of snow melters conduct an equivalency comparison between hauling snow to other locations on the airport and melting the snow in place. Appropriate considerations for the comparison include:

1. Economy – cost of operating and maintaining snow melter equipment vs hauling operations
2. Safety – impact of snow melter operations working in AOA vs truck hauling operations through the AOA
3. Environment – comparison of water quality factors for onsite melting vs disposal remote from apron.
4. Airport operations – impact of personnel and equipment working in close proximity to parked and taxiing aircraft.

4.4.2 Identifying Disposal Sites.

If there is insufficient space for storing snow near areas to be cleared and no melting or flushing means are available, hauling to a disposal site may be necessary. If deemed necessary, the disposal site should be selected before winter sets in and identified in the SICP. The selection process should at least consider the following:

1. disposal sites do not compromise airplane operations, airport NAVAIDs, airport traffic, and ATCT operations such as ATCT line-of-sight requirements;
2. sites have adequate drainage capability; and
3. sites offer, if required, environmental mitigation of captured chemicals.

4.5 **Methods for Ice Control and Removal.**

4.5.1 Preventing a bond from occurring between ice and the pavement surface is always preferred over the mechanical removal or melting of the bonded ice. Appendix C provides the characteristics of ice and other forms of snow and other details as it relates to handling their removal. Paragraph 4.6 provides the FAA-recommended chemical specifications for approved airside pavement anti-icer and deicer products. Prevention is achieved by applying *approved* anti-icing chemicals to pavements with temperatures expected to go below 32° F (0° C). Fluid anti-icing products instead of solid anti-icing products are recommended since the liquid form is more effective in achieving uniform distributions and improved chemical-adhesion to the pavement surface. The primary drawback of solid chemicals on cold pavements is their inability to adhere properly to the surface, which can lead to their being windblown or scattered about.

4.5.2 Once the ice has bonded to the pavement surface, the airport operators may use approved deicers to melt through the ice pack to break up or weaken the ice bond; increase the frictional characteristics of the surface, for example, by applying heated sand; or use mechanical means, such as plowing with under-body scrapers or scarifying the ice surface to break the ice packs. The type of brooms used to remove a layer of ice is important since in some cases the broom may actually “polish” the ice, thus reducing

traction. Steel bristles are better than poly bristles since one “cuts” the ice surface while the other “flips” snow. Paragraph 4.7 provides guidance on methods to improve the frictional characteristics of surfaces, and Paragraph 4.8 provides the FAA sand gradation criteria for airfield usage.

4.6 **Approved Chemicals.**

4.6.1 Airside Chemicals.

The FAA either establishes approval specifications or, upon acceptance, references the specifications of professional associations, such as SAE Aerospace Material Specifications (AMS), and the U.S. military (MIL-SPEC). The approved airside chemicals for runway and taxiway applications are fluid and solid products meeting a generic SAE or MIL specification. These specifications require vendors to provide airport operators with a lab certification stating the chemical conformed to the applicable specification and a material safety data sheet (MSDS) for handling the product. With the increased accountability placed on airport operators to manage deicing/anti-icing chemical runoff, they should request vendors to provide certain environmental data. These data consist of information on pollutants the Environmental Protection Agency and the State Department of Natural Resources request of the airport operators in their discharge reporting requirements. Typically, the information includes percent product biodegradability, biochemical oxygen demand (BOD5), chemical oxygen demand (COD), pH, presence of toxic or hazardous components, if any, and remaining inert elements after application. MSDSs provide measures on how to secure large product spills and a 24-hour toll-free emergency phone number. While these fluid and solid specifications cover technical requirements for deicing/anti-icing products, they do not address the compatibility issue of combining products during operations. Airport operators, therefore, should query manufacturers about the safe and proper use of concurrently applying multiple deicers/anti-icers. The FAA-approved airside chemical specifications, which may be restricted by state or local environmental regulations, are as follows:

4.6.1.1 **Fluid Deicer/Anti-icers.**

The approved specification is the latest edition of SAE AMS 1435, *Fluid, Generic Deicing/Anti-icing, Runways and Taxiways*. Approved products include glycol-based fluids, potassium acetate base, and potassium formate-based fluids. The SAE specification is available for purchase at <http://www.sae.org>. Application rates for a specific product are based on manufacturer recommendations. In terms of material cost-savings, less product is used by anti-icing operations than by deicing operations.

4.6.1.2 **Solid Deicer/Anti-icer.**

4.6.1.2.1 Generic Solids.

The approved specification is the latest edition of SAE AMS 1431, *Compound, Solid Runway and Taxiway Deicing/Anti-icing*. Approved solid compounds include airside urea, sodium formate, and sodium acetate. It is

noted that, in comparison to airside urea, sodium formate and sodium acetate products continue to be effective for much colder pavement temperatures. The urea deicing function is practical only at temperatures above approximately 15° F (-10° C) because of the decreasing melting rates below this temperature value. The decreasing melting rate is a result of urea's eutectic temperature, defined in Paragraph 1.12.7, which is approximately 11° F (-12° C). However, the presence of solar radiation assists urea in the melting action. Pavement surface temperature and ice thickness determine the urea application rate. Application rates for a specific product are based on manufacturer recommendations.

4.6.1.2.2 Airside Urea (or "Carbamide").

The approved specifications are the latest edition of SAE AMS 1431, *Compound, Solid Runway and Taxiway Deicing/Anti-icing*, and MIL SPEC DOD-U10866D, *Urea-Technical*. Agricultural grade urea that meets any of these specifications, called airside urea, is acceptable. This nontoxic solid white chemical comes in either powder or "shotted" ("prilled") form. The latter form's shape is small spheres of about 1/16 inch (1.5 mm) in diameter. Both forms are primarily for deicing, where powdered urea is frequently mixed with sand. Hot mixtures of powder or "shotted" urea and sand are used by airport operators for two purposes: (1) immediate increase in braking action and (2) retention of chemical over the pavement area until it initially dissolves some of the ice and then melts the remainder. Table 4-1 provides guidance on application rates in relation to pavement temperature and ice thickness.

Table 4-1. Guidance for Airside Urea Application Rates

| Ice Thickness Inch (cm) | Temperature Degree F (°C) | | |
|---|---------------------------|--------------|--------------|
| | 30 (11) | 25 (-3.9) | 20 (-6.7) |
| Less than 1/32 (0.08) | 0.016 (0.078) | 0.023 (0.11) | 0.06 (0.29) |
| 1/32 up to but not including 1/8 (0.08 - 0.32) | 0.03 (0.15) | 0.06 (0.29) | 0.125 (0.61) |
| 1/8 (0.32) to 1/4 (0.32 - 0.64) | 0.125 (0.61) | 0.175 (0.86) | 0.275 (1.34) |

4.6.2 Landside Chemicals.

The most effective landside chemicals used for deicing/anti-icing in terms of both cost and freezing point depression are from the chloride family, e.g., sodium chloride (rock salt), calcium chloride, and lithium chloride. However, these chemicals are known to be corrosive to aircraft and therefore are prohibited for use on aircraft operational areas.

When any corrosive chemical is used, precautions should be taken to ensure that (1) vehicles do not track these products onto the aircraft operational areas and (2) chemical trucks used for transporting corrosive chemicals are cleaned prior to transporting airside chemicals or sand. It is noted that although the solids sodium acetate and sodium formate and the fluids potassium acetate and potassium formate products are classified as salts, those that contain corrosion inhibitor packages to comply with an SAE specification are approved for airside applications.

4.6.3 Environmental and Pavement Aspects of Anti-icing and Deicing Chemicals.

4.6.3.1 Deicing/anti-icing chemicals commonly used on airfields and for aircraft degrade rapidly due to chemical and biological processes. These processes often cause a large drop in the dissolved oxygen levels of receiving waters off the airport. It has been suggested that the resultant dissolved oxygen levels are too low to support healthy biotic communities occupying those water bodies. Although low temperatures and dilution from heavy snow runoff during periods of use minimize the effects of low dissolved oxygen, and the ammonia from decomposing urea quickly dissipates, it is wise to consult with an agency having expertise in water quality. This consultation should highlight best management practices or best available technology for effectively meeting storm water permit conditions established to protect the water quality of aquatic life in receiving waters.

4.6.3.2 All freezing point depressants can cause scaling of Portland cement concrete (PCC) by physical action related to the chemical concentration gradient in the pavement. Deleterious effects on PCC can be reduced by ensuring sufficient cover over reinforcing steel (minimum of 2 inches (5 cm)), using air-entraining additives, and avoiding applications of chemicals for one year after placement. Concrete meeting the compressive strength outlined in ASTM C 672, *Scale Resistance of Concrete Surfaces Exposed to Deicing Chemicals*, will perform well when subjected to chemical deicers. Certain PCC runways may experience excessive alkali-silica reaction that causes accelerated deterioration and cracking. Proper selection of aggregates and the use of additives can mitigate this occurrence in new PCC runways. Coatings for existing PCC runways are being researched to determine their effectiveness in mitigating this occurrence. No surface degradation of asphalt concrete has been observed from approved chemicals.

4.7 **Runway Friction Improvements.**

Since snow and ice degrade the coefficient of friction between rubber tires and pavement and could pose an unsafe condition for aircraft, it is important to clear down to bare pavement whenever possible. There are situations where complete removal is difficult or impossible to achieve within a required span of time. At temperatures approaching the *eutectic temperature* of an anti-icing/deicing chemical, it may require an hour or more for the dry chemical to go into solution and melt the ice. There are two

techniques for modifying the frictional coefficient of a pavement covered with ice or compacted snow—one by building in a texture on the surface and the other by a surface treatment of the ice or snow. It is emphasized that heated sand is not a deicing chemical and will not remove ice or compacted snow. In fact, heavy applications of heated sand can insulate the ice and therefore prolong its presence.

4.7.1 Pavement Surface Modification.

Surface texture and surface treatment modifications by themselves will not increase the coefficient of friction of ice formed on the surface, but both will enhance the response of chemical treatment.

4.7.1.1 **Pavement Grooving.**

Grooves cut into the pavement will trap anti-icing/deicing chemicals, reduce loss, and prolong their actions. Grooves also assist in draining melt water and preventing refreezing. There is empirical evidence that grooves and porous friction courses modify the thermal characteristics of a pavement surface, probably by reducing the radiant heat loss, and delay the formation of ice. There do not appear to be any negative effects from grooving pavements.

4.7.1.2 **Porous Friction Course (PFC).**

PFC has generally the same benefits as grooving. Open graded asphalt concrete is less effective in improving coefficient of friction under icing conditions because the open spaces will fill with compacted snow and, to a lesser extent, with ice in the case of freezing rain. Most maintenance personnel have found that chemical treatment rates may need to be increased on this type of pavement compared to dense graded asphalt concrete because of drainage of the chemical. The drainage characteristics also change as sand accumulates in the voids and plugs them.

4.7.2 Surface Treatment.

This is the approach taken to rapidly increase the frictional coefficient of an ice surface. Two methods are generally used by airport operators, namely applying coarse granular material (heated sand) or scarifying or breaking up the ice surface with a serrated blade.

4.7.2.1 **Sand.**

Granular material provides a roughened surface on ice and thereby improves airplane directional control and braking performance. Use of sand should be controlled carefully on turbojet movement areas to reduce engine erosion. If the granules do not embed or adhere to the ice, they will likely be ingested into engines and/or blown away by wind or scattered by traffic action and thus serve no useful function. This is particularly the case when unheated sand is applied to ice or compacted snow is at temperatures below about 20° F (-6.7° C) since no water film exists on the surface to act as an adhesive. There are three approaches to reducing loss of sand: (1) it can be heated to enhance embedding into the cold surface; (2) the granules can be

coated with an approved deicing chemical in the stockpile or in the distributing truck hopper; or (3) diluted deicing chemical can be sprayed on the granules or the pavement at the time of spreading. If stockpiles are kept in a heated enclosure and spread promptly after truck loading, sufficient heat may remain for embedding without further treatment. Maintenance personnel should make a test on an unused pavement covered with ice or compacted snow to determine if bonding is adequate to prevent loss. When the slippery condition giving rise to the requirement for sand has passed, treated pavements should be swept as soon as air traffic volume allows removal of the residue to prevent engine damage. Other factors to consider when deciding to apply sand are pavement and air temperatures and frequency of operations. The use of other abrasives, such as slag, is not recommended since some metal-based slags may affect engine components.

Note: Upon applying sand, airport operators must ensure the application is monitored for effectiveness and remains in place for the intended location of the surface treated.

4.7.2.2 **Ice Scarifying.**

Directional control of vehicles on an ice or compacted snow surface can be improved dramatically by cutting longitudinal grooves in the ice. *However, no improvement in braking effectiveness results from grooving, so this approach should only be employed when very low temperatures prevent rapid chemical action or mechanical removal.* The grooves trap sand or chemicals and hence contribute to improving the surface friction characteristics and melting action.

4.8 **Sand.**

4.8.1 Material.

All sands do not perform the same. In general, the greater the quantity of sand applied, the greater the increase in traction. Fine sands show superior performance on warmer ice (>20° F (-7° C)), while coarser sands show superior performance on colder ice (<15° F (-9° C)). For the purpose of this AC, sand retained on a #30 sieve is considered “coarse”, and sand passing through a #30 sieve is considered “fine”. The FAA recommends that airport operators inform tenant airlines about the material used on the runways.

Note: Slag material is not recommended because engine manufacturers have reported problems with internal engine components, especially for certain types **of metal slags.**

4.8.1.1 **Standard Gradation.**

Table 4-2 provides the standard gradation for sand. Materials applied to aircraft movement surfaces must consist of washed granular mineral sand particles free of stone, clay, debris, slag, chloride salts, and other corrosive substances. The pH of the water solution containing the material must be

approximately neutral (pH 7). Material must meet the following gradation using a U.S.A. Standard Sieve conforming to *ASTM E 11-81*. The upper and lower sand gradations are in response to engine manufacturers input that finer sized sand from time to time produced hard snowballs while coarser sized sand damaged engine components. The latter case additionally causes damage to the fuselage.

Table 4-2. Standard Gradation for Sand

| Sieve Designation | Percent by Weight Passing |
|-------------------|---------------------------|
| 8 | 100 |
| 80 | 0-2 |

4.8.1.2 Optimum Gradation.

Table 4-3 provides an expanded sand gradation standard for optimum performance on both warm and cold ice conditions by balancing fine and coarse particles. For this reason, the inclusion of the #30 sieve beyond that required by the FAA standard gradation of Table 4-2 is recommended. Airport operators may modify these recommended gradation requirements to suit their needs, as long as the gradation meets the requirements of Table 4-2. The use of sand that does not meet the gradation requirements of Table 4-2 must be coordinated with the FAA Safety and Standards Branch.

Table 4-3. Expanded Sand Gradation Standard

| Sieve Designation | Percent by Weight Passing |
|-------------------|---------------------------|
| 8 | 100 |
| 30 | 20-50 |
| 80 | 0-2 |

4.8.2 Application.

Hard silica sand provides the greatest increase in traction and remains effective the longest when compared to softer materials because of its resistance to fracture. However, it is also very abrasive and, therefore, more potentially damaging to airplane engines. Limestone is softer and may be used where available if abrasion needs to be reduced. Tests have shown that application rates of 0.02 - 0.10 lb./ft² (0.1 - 0.5 kg/m²) of sand will substantially increase the runway friction coefficient. The greater quantity is required at temperatures approaching 32° F (0° C), the amount decreasing as the

temperatures drops. Fractured particles provide some advantage in traction enhancement but not enough to justify much of a difference in cost. In terms of color, darker sands are preferred over light-colored sands to offer visual verification where sand has been applied.

4.8.3 Chemically or Heat-treated Sand.

The FAA recommends that sand be heated or treated with approved chemicals to make it adhere better to ice or compacted snow, thereby minimizing the possibility of airplane engine ingestion and preventing loss of material (see § 139.313(b)(3)). At temperatures above 15° F (-9° C), a solution of airside urea may be used; below this temperature, other approved fluids may be more effective. Airport operators report that approximately 8 to 10 gallons (30-40 l) of fluid chemical are required to coat one ton of sand. The most effective method of applying the chemical is to spray it on granules as they drop onto the spinner mechanism of a material spreader since wetting is more thorough than pouring the chemicals onto the stockpile or the hopper load. Below 0° F (-18° C), heated sand can be more effective because of more rapid adhesion of the granules to ice. If sand will be heated, a coarser mixture (#30 sieve is considered “coarse”) should be used, as fine particles cool too rapidly on dispersal before hitting the ice. Sands heated to 80° F (27° C) or higher adhere well to ice.

CHAPTER 5. SURFACE ASSESSMENT AND REPORTING

5.1 Airport Operator Responsibility.

- 5.1.1 The Airport Operator should be aware of all paved surface conditions in order to plan and carry out appropriate maintenance actions in accordance with the Snow and Ice Control plan. Equipped with this information, the airport operator will be able to better determine when to close a *runway, taxiway, or apron* area to aircraft use. Assessing and reporting the surface condition of a runway poses a particular challenge for an airport operator and is of the utmost importance to airport users. Pilot braking action reports are the source of braking action information most accepted by pilots. However, they can vary significantly, even when reporting on the same contaminated surface conditions. Furthermore, they only apply to the portion of the runway where braking occurred. Assessments based solely on the values generated by friction measuring equipment do not provide a consistent and usable correlation between friction measurements and airplane braking performance. The use of a truck or automobile to estimate airplane braking action is also subjective.
- 5.1.2 Previous methods of determining runway slipperiness have been found to be inadequate and have either not prevented or have contributed to runway excursion incidents. A major contributing factor has been a contaminated (snow, ice, slush, water, etc.) runway being more slippery than pilots expected. This has been typically due to methods of estimating available runway friction levels not being timely, accurate, or able to be correlated to airplane stopping performance. As a result, runway excursions are the leading cause of accidents worldwide. The severity of these accidents varies from minor damage to significant equipment loss and fatalities. In response to this recurring safety concern, the FAA, in partnership with industry stakeholders (aircraft operators, aircraft manufacturers, airport operators, international civil aviation authorities and professional aviation organizations) developed more comprehensive and standardized methods of assessing and reporting surface conditions.
- 5.1.3 To comply with § 139.339, the airport operator must utilize the NOTAM system as the primary method for collection and dissemination of airport information to air carriers and other airport users. When disseminating airport condition information there are three methods available to airport operators. The first and preferred method is NOTAM Manager, a direct-entry system. The second alternative method is the ENII system. This system is similar to NOTAM Manager but lacks some of the direct entry functionality. The third method to issue a NOTAM is via telephone. This method is the least preferred due to the amount of time required to communicate airfield conditions to Flight Service, and the manual recording of notifications and disseminations in airport logs. When supplemental or secondary systems are used, the airport operator must ensure they are approved and consistent with part 139. A record of the dissemination (issuance and cancellation) of NOTAM information must be retained by the airport operator.

5.1.4 Conditions Acceptable to Use Decelerometers or Continuous Friction Measuring Equipment to Conduct Runway Friction Surveys on Frozen Contaminated Surfaces.

- 5.1.4.1 The data obtained from such runway friction surveys are considered to be reliable only when the surface is contaminated under any of the following conditions:
1. Ice or wet ice. Ice that is melting or ice with a layer of water (any depth) on top. The liquid water film depth of .04 inches (1 mm) or less is insufficient to cause hydroplaning.
 2. Compacted snow at any depth.
 3. Dry snow 1 inch (25.4 mm) or less.
 4. Wet snow or slush 1/8 inch (3.2 mm) or less.
- 5.1.4.2 It is not acceptable to use decelerometers or continuous friction measuring equipment to assess any contaminants outside of these parameters.

5.2 **Runway Friction Surveys.**

FAA-approved friction measuring equipment may be employed to help in determining the effects of friction-enhancing treatments, in that it can show the trend of a runway as to increasing or decreasing friction. Airport operators should not attempt to correlate friction readings (Mu numbers) to Good/Medium (previously known as Fair)/Poor or Nil runway surface conditions, as no consistent, usable correlation between Mu values and these terms has been shown to exist to the FAA's satisfaction. It is important to note that while manufacturers of the approved friction measuring equipment may provide a table that correlates braking action to Mu values, these correlations are not acceptable to the FAA. To ensure that data collected are accurate, qualified personnel should use FAA-approved equipment and follow the manufacturer's instructions for use. Further guidance on runway friction measurement may be found in AC 150/5320-12, *Measurement, Construction, and Maintenance of Skid-Resistant Airport Pavement Surfaces*.

Note: It is no longer acceptable to report or disseminate friction (Mu) values via NOTAMs. Friction (Mu) values have been replaced by Runway Condition Codes, which must be included in the Runway Condition NOTAM. See Paragraph 5.3.3.1.2.

5.2.1 When to Conduct Runway Friction Surveys on Contaminated Surfaces.

Conduct runway friction surveys whenever the conditions are within the limits of Paragraph 5.1.4 and the operator believes the information will be helpful in the overall snow/ice removal effort. Additionally, conduct runway friction assessments:

- 5.2.1.1 When the central portion of the runway, centered longitudinally along the runway centerline, is contaminated over a distance of 500 feet (152 m) or more.
- 5.2.1.2 Following all snow clearing, anti-icing, deicing, or sanding operations.

- 5.2.1.3 Immediately following any aircraft incident or accident on the runway, recognizing that responding ARFF or other circumstances may restrict an immediate response.

5.2.2 Friction Measuring Procedures.

5.2.2.1 **Calibration.**

The friction measuring equipment operator is responsible for ensuring that equipment is correctly calibrated in accordance with its operations manual. Some devices perform an automatic electronic calibration each time the power is turned on; others require the operator to initiate the calibration procedure. In the latter case, the electronic calibration should be performed before placing the equipment in operation for the day. The equipment operator should also check all ancillary systems (such as recording devices, tow vehicles, and two-way radios). Factory calibrations of a CFME should be performed as recommended by the manufacturer, or sooner if indicated by erroneous data. The operator responsible for the device should perform only adjustments recommended by the manufacturer. Factory calibration should be scheduled during the spring-summer season to ensure the equipment will be ready for the next winter's runway friction surveys.

5.2.2.2 **Advance Coordination.**

Runway friction surveys take time, and while the tests are being conducted, the runway may be closed to airplane operations. Airport operators should work closely with ATC, the airlines, and/or the fixed-base operators to minimize interruption to airplane operations. Proper coordination, communication, and cooperation among all parties concerned are vital to ensure personnel safety, efficient traffic management, and timely runway friction surveys. The airport operator should request from ATC an appropriate period of time to conduct a friction survey of the runway. At a high-activity airport, runway friction surveys may have to be conducted in segments. The airport operator should request ATC to plan a break in arrival and departure traffic to provide time to conduct a runway friction survey. With such planning, the friction survey team can position itself adjacent to the runway when ATC gives the clearance to proceed. This cooperative effort with ATC should result in minimal disruptions to airplane operations.

5.2.2.3 **Air Traffic Control Clearance When Conducting Runway Friction Surveys on Open Runways.**

Before proceeding with the friction survey at controlled airports, the airport operator responsible for conducting the friction survey must contact ATC for runway clearance according to standard procedures and remain in radio contact during the entire time it takes to complete the friction survey on an open runway. ATC will provide appropriate clearances on and off the runway to permit the airport operator access to conduct the friction survey.

At uncontrolled airports, airport operations personnel must be alert for aircraft and advise any air traffic on advisory frequencies before, during, and after completion of the runway friction survey. In this situation, coordination among the area ATC, the airport operator, and the airplane operators is particularly important to ensure that safe and efficient airplane operations are maintained at all times.

5.2.2.4 **Location and Direction to Conduct Runway Friction Surveys.**

5.2.2.4.1 Lateral Location.

On runways that serve primarily narrow-body airplanes, runway friction surveys should be conducted approximately 10 feet (3 m) from the runway centerline. On runways that serve primarily wide-body airplanes, runway friction surveys should be conducted approximately 20 feet (6 m) from the runway centerline. Unless surface conditions are noticeably different on the two sides of the runway centerline, only one survey is needed, and it may be conducted on either side.

5.2.2.4.2 Direction.

Friction measuring equipment is operated in the same direction that airplanes are landing.

5.2.2.4.3 Runway Survey Zones.

The runway length is divided into three equal zones: the touchdown, midpoint, and rollout zones. These zones are defined according to airplane landing direction. If possible, the entire survey should be completed in one pass. However, if ATC cannot schedule enough time to do a complete runway friction survey, the airport operator should request ATC to schedule each zone separately until all three zones have been completed.

5.2.2.5 **Conducting Runway Friction Surveys Using Decelerometers.**

To obtain an accurate friction assessment, a minimum of three braking tests are conducted and averaged for each zone. This will result in a minimum of nine tests for a complete runway friction survey. The vehicle speed for conducting the friction survey should be 20 mph (32 km/h).

Table 5-1. Friction Survey Example

| | |
|------------------------------------|--|
| Runway Zone 1 Touchdown | An airport operator obtains four Mu readings in the touchdown zone: 25, 27, 26, and 31. The average of these readings is 27.25, which would be rounded to 27. |
| Runway Zone 2 Midpoint | Four readings are obtained for the midpoint zone: 26, 28, 28, and 32. The average of 28.5, which would be rounded to 28. |
| Runway Zone 3 Rollout | After the minimum three readings (29, 30, and 31) are obtained for the rollout zone, ATC instructs the operator to clear the runway. It is not required that an equal number of readings be obtained for each zone, so the three readings are averaged to a reading of 30. |

5.2.2.6 **Conducting Runway Friction Surveys Using CFME.**

A runway friction survey is recommended for the full length of the runway to determine the average friction value for each runway third. The survey may be conducted at any speed up to 40 mph (65 km/h) as safety considerations allow. Some CFME should be operated at slower speeds due to handling characteristics that are a function of their weight, measuring method, etc. Operators should be trained in the use of CMFE, and such training should include information on handling characteristics and optimum testing speeds.

5.2.2.7 **Recording Runway Friction Survey Data.**

The equipment operator should record all data and observations obtained from runway friction surveys. Recorded data and observations can be used to assess the effectiveness of runway surface treatments and snow removal operations and can aid in accident or incident investigations. Current friction measurement technologies are not reliable in determining braking effectiveness of a contaminated surface condition above measurements of 40.

5.3 **Runway Condition Assessments.**

5.3.1 Runway Condition Assessment Matrix (RCAM).

The **RCAM** is the method by which an airport operator reports a runway surface assessment when contaminants are present. Use of the RCAM is only applicable to paved runway surfaces. Once an assessment has been performed, the RCAM defines the format for which the airport operator reports and receives a runway condition “Code” via the NOTAM System. The reported information allows a pilot to interpret the runway conditions in terms that relate to airplane performance. This approach is a less subjective means of assessing runway conditions by using defined objective criteria.

Aircraft manufacturers have determined that variances in contaminant type, depth, and air temperature can cause specific changes in aircraft braking performance. At the core of the RCAM is its ability to differentiate among the performance characteristics of given contaminants.

Table 5-2. Runway Condition Assessment Matrix (RCAM) (for Airport Operators' Use Only)

| Assessment Criteria | | Downgrade Assessment Criteria | | |
|--|------|-------------------------------|---|-------------------------------|
| Runway Condition Description | Code | Mu (μ) ¹ | Vehicle Deceleration or Directional Control Observation | Pilot Reported Braking Action |
| <ul style="list-style-type: none"> Dry | 6 | 40 or Higher | --- | --- |
| <ul style="list-style-type: none"> Frost Wet (Includes Damp and 1/8 inch depth or less of water) <p>1/8 inch (3mm) depth or less of:</p> <ul style="list-style-type: none"> Slush Dry Snow Wet Snow | 5 | | Braking deceleration is normal for the wheel braking effort applied AND directional control is normal. | Good |
| <p>5° F (-15°C) and Colder outside air temperature:</p> <ul style="list-style-type: none"> Compacted Snow | 4 | 39 | Braking deceleration OR directional control is between Good and Medium. | Good to Medium |
| <ul style="list-style-type: none"> Slippery When Wet (wet runway) Dry Snow or Wet Snow (Any depth) over Compacted Snow <p>Greater than 1/8 inch (3mm) depth of:</p> <ul style="list-style-type: none"> Dry Snow Wet Snow <p>Warmer than 5° F (-15°C) outside air temperature:</p> <ul style="list-style-type: none"> Compacted Snow | 3 | 30 | Braking deceleration is noticeably reduced for the wheel braking effort applied OR directional control is noticeably reduced. | Medium |
| <p>Greater than 1/8 (3mm) inch depth of:</p> <ul style="list-style-type: none"> Water Slush | 2 | 29 | Braking deceleration OR directional control is between Medium and Poor. | Medium to Poor |
| <ul style="list-style-type: none"> Ice² | 1 | 21 | Braking deceleration is significantly reduced for the wheel braking effort applied OR directional control is significantly reduced. | Poor |
| <ul style="list-style-type: none"> Wet Ice² Slush over Ice Water over Compacted Snow² Dry Snow or Wet Snow over Ice² | 0 | 20 or Lower | Braking deceleration is minimal to non-existent for the wheel braking effort applied OR directional control is uncertain. | Nil |

¹ The correlation of the Mu (μ) values with runway conditions and condition codes in the Matrix are only approximate ranges for a generic friction measuring device **and are intended to be used only to downgrade a runway condition code; with the exception of circumstances identified in Note 2.** Airport operators should use their best judgment when using friction measuring devices for downgrade assessments, including their experience with the specific measuring devices used.

² In some circumstances, these runway surface conditions may not be as slippery as the runway condition code assigned by the Matrix. The airport operator may issue a higher runway condition code (but no higher than code 3) for each third of the runway if the Mu value for that third of the runway is 40 or greater obtained by a properly operated and calibrated friction measuring device, **and all other observations, judgment, and vehicle braking action support the higher runway condition code. The decision to issue a higher runway condition code than would be called for by the Matrix cannot be based on Mu values alone; all available means of assessing runway slipperiness must be used and must support the higher runway condition code.** This ability to raise the reported runway condition code to a code 1, 2, or 3 can only be applied to those runway conditions listed under codes 0 and 1 in the Matrix.

The airport operator must also continually monitor the runway surface as long as the higher code is in effect to ensure that the runway surface condition does not deteriorate below the assigned code. The extent of monitoring must consider all variables that may affect the runway surface condition, including any precipitation conditions, changing temperatures, effects of wind, frequency of runway use, and type of aircraft using the runway. If sand or other approved runway treatments are used to satisfy the requirements for issuing this higher runway condition code, the continued monitoring program must confirm continued effectiveness of the treatment.

Caution: Temperatures near and above freezing (e.g., at 26.6° F (-3°C) and warmer) may cause contaminants to behave more slippery than indicated by the runway condition code given in the Matrix. At these temperatures, airport operators should exercise a heightened level of runway assessment, and should downgrade the runway condition code if appropriate.

5.3.2 Overview of the Basic RCAM Process.

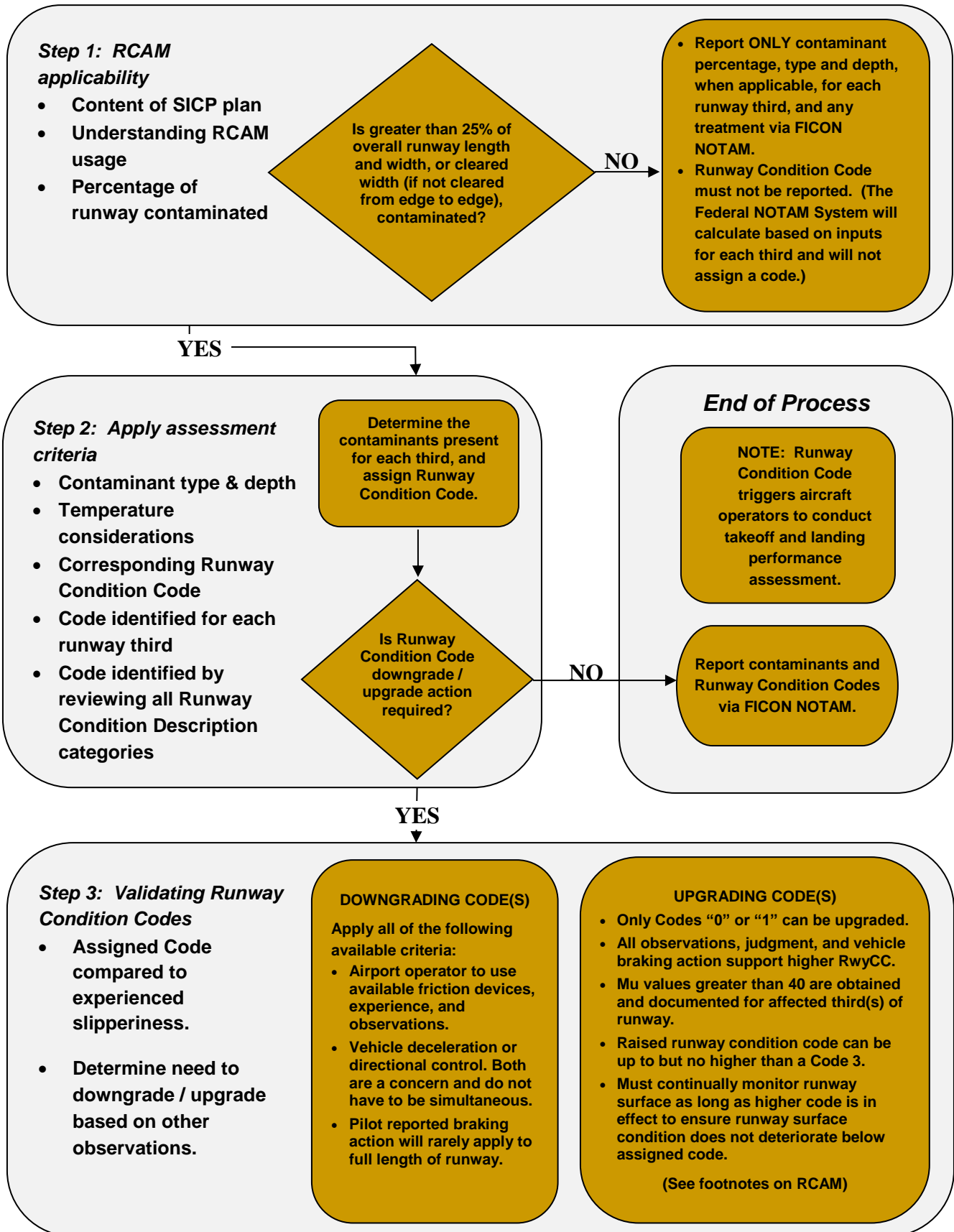

5.3.3 RCAM Components.

5.3.3.1 **Assessment Criteria.**

This section of the RCAM consists of a Runway Condition Description and a Runway Condition Code. This section includes contaminant type and depth categories which are objective assessments that have been determined by airplane manufacturers to cause specific changes in the airplane braking performance. These contaminants correspond to a reportable “shorthand” Runway Condition Code when applicable.

5.3.3.1.1 Runway Condition Description.

The Runway Condition Description column of the RCAM provides contaminants that are directly correlated to airplane takeoff and landing performance. The description sections, ranging in terms of slipperiness, are categorized based on type and depth of contaminant and temperature.

Figure 5-1. Runway Condition Description Column of the RCAM

| Assessment Criteria | |
|--|--|
| Runway Condition Description | |
| <ul style="list-style-type: none"> • Dry | |
| <ul style="list-style-type: none"> • Frost • Wet (Includes Damp and 1/8 inch depth or less of water) <p><i>1/8 inch (3mm) depth or less of:</i></p> <ul style="list-style-type: none"> • Slush • Dry Snow • Wet Snow | |
| <p><i>5° F (-15°C) and Colder outside air temperature:</i></p> <ul style="list-style-type: none"> • Compacted Snow | |
| <ul style="list-style-type: none"> • Slippery When Wet (wet runway) • Dry Snow or Wet Snow (Any depth) over Compacted Snow <p><i>Greater than 1/8 inch (3mm) depth of:</i></p> <ul style="list-style-type: none"> • Dry Snow • Wet Snow <p><i>Warmer than 5° F (-15°C) outside air temperature:</i></p> <ul style="list-style-type: none"> • Compacted Snow | |
| <p><i>Greater than 1/8 (3mm) inch depth of:</i></p> <ul style="list-style-type: none"> • Water • Slush | |
| <ul style="list-style-type: none"> • Ice ² | |
| <ul style="list-style-type: none"> • Wet Ice ² • Slush over Ice • Water over Compacted Snow ² • Dry Snow or Wet Snow over Ice ² | |

5.3.3.1.2 Code (Runway Condition Code – RwyCC).

Runway Condition Codes (Format: X/X/X) represent the runway condition description based on defined terms and increments. Use of these codes harmonizes with ICAO Annex 14, providing a standardized “shorthand” format for reporting RwyCC (which replaces Mu values), and are used by pilots to determine landing performance parameters when applicable. Runway Condition Codes are disseminated via the following methods:

1. Federal NOTAM System, preferably through NOTAM Manager or equivalent system(s);
2. Airport Traffic Control Tower (ATCT) (as applicable);
3. Flight Service Station (FSS) (as applicable); and
4. Directly from airport operator via Common Traffic Advisory Frequency (as applicable).

Figure 5-2. Runway Condition Code (RwyCC) Column of the RCAM

| Assessment Criteria | |
|--|------|
| Runway Condition Description | Code |
| <ul style="list-style-type: none"> • Dry | 6 |
| <ul style="list-style-type: none"> • Frost • Wet (Includes Damp and 1/8 inch depth or less of water) <p>1/8 inch (3mm) depth or less of:</p> <ul style="list-style-type: none"> • Slush • Dry Snow • Wet Snow | 5 |
| <p>5° F (-15°C) and Colder outside air temperature:</p> <ul style="list-style-type: none"> • Compacted Snow | 4 |
| <ul style="list-style-type: none"> • Slippery When Wet (wet runway) • Dry Snow or Wet Snow (Any depth) over Compacted Snow <p>Greater than 1/8 inch (3mm) depth of:</p> <ul style="list-style-type: none"> • Dry Snow • Wet Snow <p>Warmer than 5° F (-15°C) outside air temperature:</p> <ul style="list-style-type: none"> • Compacted Snow | 3 |
| <p>Greater than 1/8 (3mm) inch depth of:</p> <ul style="list-style-type: none"> • Water • Slush | 2 |
| <ul style="list-style-type: none"> • Ice ² | 1 |
| <ul style="list-style-type: none"> • Wet Ice ² • Slush over Ice • Water over Compacted Snow ² • Dry Snow or Wet Snow over Ice ² | 0 |

5.3.3.2 **Downgrade Assessment Criteria.**

When data from the shaded area in the RCAM (i.e., CFME/deceleration devices, pilot reports, or observations) suggest conditions are worse than indicated by the present contaminant, the airport operator should exercise good judgment and, if warranted, report lower runway condition codes than the contamination type and depth would indicate in the RCAM. While pilot reports (PIREPs) of braking action provide valuable information, these reports rarely apply to the full length of the runway as such evaluations are limited to the specific sections of the runway surface in which wheel braking was utilized. It is not appropriate to use downgrade assessment criteria to upgrade contaminant based assessments of condition codes (e.g., from 2 to 3). There are specific rules and perimeters governing when the RwyCC may be upgraded from Code 0 or 1 to Code 3. See Note 2 for Table 5-2.

5.3.3.2.1 Mu (μ) (Friction Assessment).

The correlation of the Mu (μ) values with runway conditions and condition codes in the RCAM are only approximate ranges for a generic friction measuring device and are intended to be used for an upgrade or downgrade of a runway condition code. Airport operators should use their best judgment when using friction measuring devices for downgrade assessments, including their experience with the specific measuring devices used.

Figure 5-3. Friction Assessment Column of the RCAM

| Assessment Criteria | | Downgrade Assessment Criteria | |
|--|------|-------------------------------|----|
| Runway Condition Description | Code | Mu (μ) ¹ | |
| <ul style="list-style-type: none"> Dry | 6 | 40 or Higher | |
| <ul style="list-style-type: none"> Frost Wet (Includes Damp and 1/8 inch depth or less of water) <p>1/8 inch (3mm) depth or less of:</p> <ul style="list-style-type: none"> Slush Dry Snow Wet Snow | 5 | | |
| <p>5° F (-15°C) and Colder outside air temperature:</p> <ul style="list-style-type: none"> Compacted Snow | 4 | 39 | |
| <ul style="list-style-type: none"> Slippery When Wet (wet runway) Dry Snow or Wet Snow (Any depth) over Compacted Snow <p>Greater than 1/8 inch (3mm) depth of:</p> <ul style="list-style-type: none"> Dry Snow Wet Snow <p>Warmer than 5° F (-15°C) outside air temperature:</p> <ul style="list-style-type: none"> Compacted Snow | 3 | 30 to | |
| <p>Greater than 1/8 (3mm) inch depth of:</p> <ul style="list-style-type: none"> Water Slush | 2 | 29 | |
| <ul style="list-style-type: none"> Ice² | 1 | to | 21 |
| <ul style="list-style-type: none"> Wet Ice² Slush over Ice Water over Compacted Snow² Dry Snow or Wet Snow over Ice² | 0 | 20 or Lower | |

5.3.3.2.2 Vehicle Deceleration or Directional Control Observation.

This column is used to correlate estimated vehicle braking experienced on a given contaminant.

Figure 5-4. Vehicle Deceleration or Directional Control Observation Column of the RCAM

| Assessment Criteria | | Downgrade Assessment Criteria | |
|--|------|-------------------------------|---|
| Runway Condition Description | Code | Mu (μ) ¹ | Vehicle Deceleration or Directional Control Observation |
| <ul style="list-style-type: none"> Dry | 6 | 40 or Higher | --- |
| <ul style="list-style-type: none"> Frost Wet (Includes Damp and 1/8 inch depth or less of water) <p>1/8 inch (3mm) depth or less of:</p> <ul style="list-style-type: none"> Slush Dry Snow Wet Snow | 5 | | Braking deceleration is normal for the wheel braking effort applied AND directional control is normal. |
| <p>5° F (-15°C) and Colder outside air temperature:</p> <ul style="list-style-type: none"> Compacted Snow | 4 | 39 | Braking deceleration OR directional control is between Good and Medium. |
| <ul style="list-style-type: none"> Slippery When Wet (wet runway) Dry Snow or Wet Snow (Any depth) over Compacted Snow <p>Greater than 1/8 inch (3mm) depth of:</p> <ul style="list-style-type: none"> Dry Snow Wet Snow <p>Warmer than 5° F (-15°C) outside air temperature:</p> <ul style="list-style-type: none"> Compacted Snow | 3 | 30 | Braking deceleration is noticeably reduced for the wheel braking effort applied OR directional control is noticeably reduced. |
| <p>Greater than 1/8 (3mm) inch depth of:</p> <ul style="list-style-type: none"> Water Slush | 2 | 29 | Braking deceleration OR directional control is between Medium and Poor. |
| <ul style="list-style-type: none"> Ice² | 1 | 21 | Braking deceleration is significantly reduced for the wheel braking effort applied OR directional control is significantly reduced. |
| <ul style="list-style-type: none"> Wet Ice² Slush over Ice Water over Compacted Snow² Dry Snow or Wet Snow over Ice² | 0 | 20 or Lower | Braking deceleration is minimal to non-existent for the wheel braking effort applied OR directional control is uncertain. |

5.3.3.2.3 Pilot Reported Braking Action.

This is a report of braking action on the runway, by a pilot, providing other pilots with a degree/quality of expected braking. The braking action experienced is dependent on the type of aircraft, aircraft weight, touchdown point, and other factors.

1. **Good:** Braking deceleration is normal for the wheel braking effort applied, and directional control is normal.
2. **Good-to-Medium:** Braking deceleration or directional control is between good and medium braking action.
3. **Medium:** Braking deceleration is noticeably reduced for the wheel braking effort applied, or directional control is noticeably reduced.
4. **Medium-to-Poor:** Braking deceleration or directional control is between medium and poor.

5. **Poor:** Braking deceleration is significantly reduced for the wheel braking effort applied, or directional control is significantly reduced.
6. **Nil:** Braking deceleration is minimal to non-existent for the wheel braking effort applied, or directional control is uncertain.

Figure 5-5. Pilot Reported Breaking Action Column of the RCAM

| Assessment Criteria | | Downgrade Assessment Criteria | | |
|--|------|-------------------------------|---|-------------------------------|
| Runway Condition Description | Code | Mu (μ) ¹ | Vehicle Deceleration or Directional Control Observation | Pilot Reported Braking Action |
| <ul style="list-style-type: none"> • Dry | 6 | 40 or Higher | --- | --- |
| <ul style="list-style-type: none"> • Frost • Wet (Includes Damp and 1/8 inch depth or less of water) <p>1/8 inch (3mm) depth or less of:</p> <ul style="list-style-type: none"> • Slush • Dry Snow • Wet Snow | 5 | | Braking deceleration is normal for the wheel braking effort applied AND directional control is normal. | Good |
| <p>5° F (-15°C) and Colder outside air temperature:</p> <ul style="list-style-type: none"> • Compacted Snow | 4 | 39 | Braking deceleration OR directional control is between Good and Medium. | Good to Medium |
| <ul style="list-style-type: none"> • Slippery When Wet (wet runway) • Dry Snow or Wet Snow (Any depth) over Compacted Snow <p>Greater than 1/8 inch (3mm) depth of:</p> <ul style="list-style-type: none"> • Dry Snow • Wet Snow <p>Warmer than 5° F (-15°C) outside air temperature:</p> <ul style="list-style-type: none"> • Compacted Snow | 3 | 30 | Braking deceleration is noticeably reduced for the wheel braking effort applied OR directional control is noticeably reduced. | Medium |
| <p>Greater than 1/8 (3mm) inch depth of:</p> <ul style="list-style-type: none"> • Water • Slush | 2 | 29 | Braking deceleration OR directional control is between Medium and Poor. | Medium to Poor |
| <ul style="list-style-type: none"> • Ice² | 1 | 21 | Braking deceleration is significantly reduced for the wheel braking effort applied OR directional control is significantly reduced. | Poor |
| <ul style="list-style-type: none"> • Wet Ice² • Slush over Ice • Water over Compacted Snow² • Dry Snow or Wet Snow over Ice² | 0 | 20 or Lower | Braking deceleration is minimal to non-existent for the wheel braking effort applied OR directional control is uncertain. | Nil |

5.4 Applying the RCAM to a Runway Assessment.

To use the RCAM, the airport operator will use the same runway condition assessment practices as they have used in the past. The airport operator will assess surfaces, report contaminants present, and the NOTAM system (NOTAM Manager or ENII) will generate the RwyCCs based on the RCAM when applicable. The RwyCCs may vary for each third of the runway if different contaminants are present. However, the same RwyCC may be applied when a uniform coverage of contaminants exists.

Note: A RwyCC of “0” denotes minimal or non-existent braking deceleration, which the FAA has determined to be an unsafe condition. The NOTAM system does not accept “0” for RwyCC and, if attempted, prompts the airport operator to close the surface and perform mitigating actions until the unsafe condition no longer exists.

5.4.1 Step 1: RCAM Applicability.

Operating with an understanding of the RCAM, the airport operator must first determine whether the overall runway length and width coverage or cleared width (if not cleared from edge to edge) is contaminated greater than 25 percent. This step in the assessment process will dictate whether a runway condition code will be applicable and included in the reported runway conditions. When submitting runway condition information through the Federal NOTAM System, this calculation will be automatically conducted by the NOTAM system, based on the reported contaminants for each third of the runway.

5.4.1.1 If 25 percent or less of the overall runway length and width coverage or cleared width is covered with contaminants, RwyCCs must not be applied, or reported. The airport operator in this case will simply report the contaminant percentage, type, and depth for each third of the runway, including any associated treatments or improvements.

Or

If the overall runway length and width coverage or cleared width is greater than 25 percent, RwyCCs must be assigned, and reported, informing airplane operators of the contaminant present and associated codes for each third of the runway. (The reported codes, will serve as a trigger for all airplane operators to conduct a takeoff and/or landing performance assessment).

5.4.2 Step 2: Apply Assessment Criteria

Based on the contaminants observed, the associated RwyCC from the RCAM for each third of the runway will be assigned. To reduce the potential for human error, the NOTAM system (NOTAM Manager or ENII) will determine the relevant RwyCC for each third of the runway as applicable.

5.4.3 Step 3: Validating RwyCCs.

With the contaminant assessment and code assignment completed, the airport operator may determine that the RwyCCs accurately reflect the runway condition. If so, no further assessment action is necessary, and the RwyCCs generated may be disseminated.

5.4.3.1 **Downgrade Assessment Criteria.**

However, the airport operator may determine a need exists to downgrade the RwyCC (assessment is indicating a more slippery condition than is generated by the RCAM) because of other observations related to runway

slipperiness. When necessary, use of the RCAM Downgrade Assessment Criteria (grey columns) may assist in making this determination.

Note: The criteria in the grey columns of the RCAM may only be used to downgrade the RwyCCs.

5.4.3.1.1 **Step 3A: Mu (μ).**

When conditions are acceptable for the airport operator to use available friction devices, the airport operator may utilize Mu readings as a means to assess runway slipperiness for downgrading or to validate the RwyCCs generated by the RCAM.

5.4.3.1.2 **Step 3B: Vehicle Control.**

Vehicle deceleration or directional control may cause concerns for the airport operator. These concerns could be for either deceleration or directional control issues. However, they need not occur simultaneously for concern to exist.

5.4.3.1.3 **Step 3C: Pilot Reported Braking Action.**

Pilot reports, which provide valuable information, rarely apply to the full length of the runway. As such, these reports are limited to the specific sections of the runway surface in which wheel braking was applied.

Note: Temperatures near and above freezing (e.g., at negative 26.6° F (-3° C) and warmer) may cause contaminants to behave more slippery than indicated by the runway condition code given in the RCAM. At these temperatures, airport operators should exercise a heightened awareness of airfield conditions, and should downgrade the RwyCC if appropriate.

5.4.3.2 **Upgrade Criteria Based on Friction Assessments.**

Given the friction variability of certain contaminants, there are circumstances when a RwyCC of '0' or '1' (Ice, Wet Ice, Slush over Ice, Water over Compacted Snow, or Dry or Wet Snow over Ice) may not be as slippery as the RwyCC generated by the RCAM. Only in these two specific circumstances, the airport operator may upgrade the RwyCC up to, but no higher than, a RwyCC of '3', only when all of the following requirements are met:

1. All observations, judgment, and vehicle braking action support the higher RwyCC.
2. Mu values of 40 or greater are obtained for the affected third(s) of the runway by a calibrated friction measuring device that is operated within allowable parameters.
3. This ability to raise the reported RwyCC to no higher than a code 3 is applied only to those runway conditions listed under code 0 and 1 in the RCAM. (See footnote 2 on the RCAM.)
4. The airport operator continually monitors the runway surface as long as the higher code is in effect to ensure the runway surface condition does not deteriorate below the assigned code.

- a. The extent of monitoring considers all variables that may affect the runway surface condition, including any precipitation conditions, changing temperatures, effects of wind, frequency of runway use, and type of aircraft using the runway.
- b. If sand or other approved runway treatments are used to satisfy the requirements for issuing the higher runway condition code, the monitoring program must confirm continued effectiveness of the treatment.

5.5 **Reportable Contaminants without Performance Data.**

Contaminants such as ash, mud, oil, and sand are treated differently in terms of reporting contaminants. A measured depth must be reported for mud. Ash, oil, sand, and rubber contaminants are reported without a measured depth. These contaminants do not generate a RwyCC. See AC 150/5200-28 and FAA Order JO 7930.2 for specific NOTAM examples.

5.6 **Condition Reporting.**

Personnel responsible for implementing the SICP should carefully monitor changing airfield conditions and disseminate information about those conditions in a timely manner to airport users. Section 139.339 requires that airport operators provide for the collection and dissemination of accurate airport condition information (movement areas or loading ramps and parking areas) to all airport users when any pavement condition is worse than bare and dry. Additionally, any condition that may affect the safe operations of aircraft must be reported to all users. Critical information to airplane operators for the purpose of takeoff and landing performance includes the contaminant type, depth, and associated RwyCCs when applicable. The determination of dry versus wet snow or slush is another key element in the report because of its potential for significant impact on airplane performance.

Note: A significant change to condition reporting includes the requirement and ability to report 'Wet' when visible dampness, or water that is 1/8-inch (3.3 mm) or less in depth exists on any surface (runways, taxiways, aprons, holding bays). This change is largely due to the airplane performance differences that exist between wet, dry, or runways with water greater than 1/8-inch (3.3 mm) in depth.

5.6.1 **Air Carriers and Other Airport Users.**

FICON and RwyCCs are also furnished to airlines, cargo, and fixed-base operators, and others operating at the airport. FICON and RwyCCs should be broadcast on the Unicom, Common Traffic Advisory Frequency, or Airport Advisory Service Frequency.

5.7 **Information Exchanged Between the Airport and Pilots.**

- 5.7.1 The goal in reporting surface conditions is to provide pilots with accurate and timely information to ensure safe operations. The RCAM is now the most objective method for performing condition assessments by airport operators. This validated method

replaces subjective judgments with objective assessments that are tied directly to contaminant type and depth categories. These categories have been determined by airplane manufacturers to cause specific changes in airplane braking performance.

- 5.7.2 Pilots and airplane operators are expected to use all available information, which should include runway condition reports as well as any available pilot braking action reports, to assess whether operations can be safely conducted. Although the FAA no longer permits airport operators to provide vehicle braking action or friction measurements for paved runways to pilots, airport operators are permitted to use vehicle braking and friction values for assessing and tracking the trend of changing runway conditions and in low speed area such as taxiway, aprons, and holding bays.

5.7.2.1 How to Report Runway Conditions.

Whenever a runway is contaminated by ice, snow, slush, or water, the airport operator is responsible for reporting current runway surface conditions. Report runway surface conditions in terms of contaminant types and depths. Do not report depths for compacted snow and ice. When reporting depth for standing water or slush, the depths are either 1/8 inch (3.3 mm) or less or greater than 1/8 inch (3.3 mm). When the cleared runway width is less than the full runway width, also report the conditions on the uncleared width (runway edges) if different from the cleared width. When the RCAM is properly utilized, specific runway condition codes will be generated for contaminants present based on the identified contaminant list in AC 150/5200-28 and FAA Order JO 7930.2. In the event the full width of the runway is not cleared, the runway condition code will be generated based on the contaminants present in the cleared portion of the runway (typically center 100 feet). Additionally, the airport operator must keep in mind that the entire width of the runway is still usable and available to the aircraft and must be safely maintained. This means that while contaminant depths may vary from the center cleared portion to the remaining portions or edges of the runway, the condition of the outlying portions must not present an operational hazard.

5.7.2.2 When to Issue New Runway Condition Reports.

Runway condition reports must be updated any time a change to the runway surface condition occurs. Changes that initiate updated reports include weather events, the application of chemicals or sand, or plowing or sweeping operations. Airport operators should not allow airplane operations on runways after such activities until a new runway condition assessment has been completed identifying the changed condition(s) and the effectiveness of mitigations and treatments and ensuring no new hazards have been inadvertently introduced. This assessment should be reported via the NOTAM system, reflecting the current surface condition(s) of affected runways. At certificated airports, such changes to the runway surface condition must be updated and appropriately disseminated so airplane operators are aware of the current conditions before continuing with their

operations. During active snow events or rapidly changing conditions (e.g., increasing snowfall, rapidly rising or falling temperatures) airport operators should maintain a vigilant runway inspection process to ensure accurate runway condition reports. While pilot braking action reports provide valuable information, these reports may not apply to the full length of the runway as such evaluations are limited to the specific sections of the runway surface in which the airplane wheel braking was used. In addition, runway condition reports should be updated at least at the beginning of each shift of operations personnel, when conditions are not changing but contaminants are present (e.g., following a snow event where frozen contaminants remain after an airport's mitigating actions).

5.8 Requirements for Runway, Taxiway, and Apron and Holding Bay Closures.

- 5.8.1 The previously accepted philosophy of the aviation industry was that the airport operator was obligated to provide an accurate description of the surface conditions, and it was solely up to the pilot to decide if a surface was safe for use. Accident data do not support such a philosophy, and the FAA has determined that operations on surfaces reported as having NIL braking are inherently unsafe. Admittedly, this is a conservative approach considering the variation in pilot braking action reporting. The NOTAM system does not accept a NIL braking action report, and if attempted, prompts the airport operator to close the surface and perform mitigating actions until the unsafe condition no longer exists.

Note: To clarify, the FAA has determined that a NIL condition (i.e., minimal or non-existent braking condition) is an unsafe condition. The NOTAM system does not accept a NIL braking action report, and if attempted, prompts the airport operator to close the surface and perform mitigating actions until the unsafe condition no longer exists.

- 5.8.2 Certificated and obligated airports are required to maintain available airport surfaces in a safe operating condition at all times and to provide prompt notification when areas normally available are less than satisfactorily cleared for safe operations. To that end, at a minimum, the following circumstances require action by the airport operator:

5.8.2.1 Runways.

- 5.8.2.1.1 A NIL pilot braking action report (PIREP), or NIL braking action assessment by the airport operator, indicates a potentially unsafe condition. An acceptable action is for the airport operator to promptly close the particular surface prior to the next flight operation (and NOTAM that closure) until it is satisfied that the NIL condition no longer exists.
- 5.8.2.1.2 When previous PIREPs have indicated GOOD or MEDIUM braking action, two consecutive POOR PIREPs indicates that surface conditions may be deteriorating. An acceptable action is for the airport operator to conduct a runway assessment prior to the next operation (unless the airport operator

has instituted its continuous monitoring procedures described in paragraph 5.9). If the airport operator is already continuously monitoring runway conditions, it is acceptable for it to conduct the assessment as soon as air traffic volume allows, in accordance with its SICP.

5.8.2.2 Taxiways, Aprons and Holding Bays.

A NIL pilot braking action report (PIREP), or NIL braking action assessment by the airport operator, requires that a surface, including taxiways and aprons be closed before the next flight operation. The surface must remain closed until the airport operator is satisfied that the NIL condition no longer exists.

5.8.2.3 Deteriorating Conditions.

Include but are not limited to:

1. Frozen or freezing precipitation.
2. Falling air or pavement temperatures that may cause a wet runway to freeze.
3. Rising air or pavement temperatures that may cause frozen contaminants to melt.
4. Removal of abrasives previously applied to the runway due to wind or airplane effects.
5. Frozen contaminants blown onto the runway by wind.

5.9 Continuous Monitoring.

5.9.1 Under the conditions noted in Paragraph 5.8.2.3, the airport operator should take all reasonable steps using available equipment and materials that are appropriate for the condition to improve the braking action. If the runway cannot be improved, the airport operator should continuously monitor the runway to ensure braking action does not become NIL. The airport operator's procedure for monitoring the runway should be detailed in the SICP.

5.9.2 "Continuous monitoring" procedures can vary from airport to airport. Acceptable procedures may include:

1. Observing which exit taxiways are being used.
2. Maintaining a regular program of friction testing to identify trends in runway traction.
3. Monitoring pavement physical conditions including air and surface temperatures, contaminant types and depths.
4. Monitoring air traffic and pilot communications as it relates to PIREPs for the portion of runway that was used.

5. Monitoring weather patterns.
6. Increased self-inspection frequency.

5.10 **Letter of Agreement (LOA) Between Airport Operator and Air Traffic Control Tower.**

- 5.10.1 To ensure that the airport operator receives needed information, Letters of Agreement (LOA) should be formalized between the airport operator and the air traffic control tower to identify the procedures and responsibilities for coordination and the reporting of runway surfaces conditions. LOA(s) should also specify how all pilot braking action reports (PIREPS) of “POOR” and “NIL” are to be immediately transmitted to the airport operator for action, as required by FAA Order 7110.65, *Air Traffic Control*. It should also include agreement on actions by Air Traffic personnel for immediate cessation of operations upon receipt of a “NIL” PIREP. FAA Order 7210.3, *Facility Operation and Administration*, addresses LOAs for Braking Action Reports between ATCT, FSS, and airport management.
- 5.10.2 Conversely, to ensure the ATCT receives necessary information from the airport operator, any letter of agreement should include procedures for how FICON and RwyCCs are transmitted. In the absence of an ATCT at the airport, the report should be supplied to the ATC facility that provides approach control service or to an appropriate flight service station (FSS).
- 5.10.3 The airport’s SICP should contain a reference to the signed LOA.

5.11 **Airport Records and Log Controls.**

The SICP should include procedures to keep and maintain a log of NOTAMs that the airport operator issues. Reviewing NOTAM status should be a checklist item any time the runway condition changes from that previously contained in the NOTAM and at the change of each shift of airport operations personnel. Also, retain a copy of the NOTAM as submitted and as transmitted for future reference and to demonstrate regulatory compliance. Users of NOTAM Manager can retrieve NOTAM log and summary information from the application. Users should download summaries of NOTAMs from NOTAM Manager regularly (monthly or quarterly) in the event of system data loss. The Sample Airport Condition Assessment Worksheet located at Appendix A is provided for the airport operator to utilize as a form of record for assessing and reporting RwyCCs and estimated braking actions for other airport surfaces that would typically coincide with NOTAM issuance. Additionally, to reduce human factors issues when issuing a runway condition information NOTAM, the system will assign the appropriate code based on an airport operator’s input of the contaminant(s) percentage, type, and depth for each runway third.

5.12 Using “Conditions Not Monitored” NOTAMs.

Airport operators should use “conditions-not-monitored” NOTAMs as a way to provide information to pilots related to the conditions not being monitored at the airport, perhaps due to operations hours or staffing. This standard has existed for airport operators to use over the years and provides the following guidance:

- 5.12.1 “For airports, particularly smaller airports, that do not monitor weather conditions between certain hours due to staffing limitations, the issued NOTAM should contain text indicating that “airfield surface conditions are not monitored between the hours of ‘X – ‘Y.” This additional text helps to avoid erroneous condition assessments by users of the information.”
- 5.12.2 Airport operators should avoid using “airport unattended” NOTAMs as a substitute for “conditions-not-monitored” because this type of NOTAM sends the wrong message that other services provided by the airport (e.g., ATC, ARFF, fuel) are not available or accessible when the conditions are not being monitored perhaps due to operations hours or staffing.
- 5.12.3 “Conditions-not-monitored” NOTAM is the preferred airport condition reporting for airport operators to use to address all airport surfaces or any individual surface as required. The period of applicability should be for both short- and long-term use. When airport operators use “conditions-not-monitored,” there may be times when the NOTAM will be issued with no recent observation or not be tied to any recent Pilot Report NOTAM. This may differ slightly from what is currently illustrated in FAA Order 7930.2 where: “When the field conditions will not be monitored, follow the most recent observation with the words ““CONDITIONS NOT MONITORED (date/time) (date/time).”” The time parameters specified must fall within the effective/expiration times. When it is determined that no surface condition reports will be taken for longer than a 24-hour period, issue a single NOTAM (Keyword AD) for the entire time-period. Use the phrase “SFC CONDITIONS NOT REPORTED”, as this differs from Conditions Not Monitored.

5.13 Winter NOTAM Abbreviations.

Snow-related NOTAMs should adhere to the format and abbreviations found in AC 150/5200-28, *Notices to Airmen (NOTAMs) for Airport Operators*, and FAA Orders 7930.2, *Notices to Airmen (NOTAMs)*, and 7340.1, *Contractions (ICAO only)*.

APPENDIX A. SAMPLE AIRPORT CONDITIONS ASSESSMENT WORKSHEET

Airport ID: _____ **Date:** _____ **Pilot Reported Braking Action**
(within 15 minutes of assessment when available): _____

Observed time (local): _____

Instructions

- Fill out a separate form for each runway.
- **Outside Air Temperature (OAT):** Only applicable to compacted snow. If the OAT is warmer than 5° F (-15 °C), the RCAM generates Code 3. If the OAT is 5° F (-15 °C) or colder, the RCAM generates Code 4.
- **Depth.** Report inches or feet, as directed by the current version of AC 150/5200-30.
- **Contaminants.** See the current version of AC 150/5200-30 for a list of approved contaminant entries.
- **Runway Condition Code:** See Table 5-2, Runway Condition Assessment Matrix (RCAM), in AC 150/5200-30. Only report if contaminant coverage is greater than 25 percent. Otherwise, leave blank.
- **Airport Operator Generated Condition Codes (Optional):** If you do not think the RCAM generated code accurately reflects conditions, use the optional table below to indicate the upgraded or downgraded codes that you intend to report in the NOTAM system. Upgrade Codes 0 or 1 only.

Airport Conditions Assessment

Runway direction in use: _____ **Is OAT warmer than 5° F (-15 °C)?** Yes No

| Coverage | | Depth | Contaminants | Runway Cond. Code |
|-----------|---|-------|--------------|-------------------|
| Location | % | | | |
| Touchdown | | | | |
| Midpoint | | | | |
| Rollout | | | | |

Optional Information

Use the table below if you intend to report a downgraded or upgraded code in the NOTAM system.

Airport Operator Generated Condition Codes Reported in NOTAM System

| Upgrade or Downgrade?* | Touchdown Code | Midpoint Code | Rollout Code |
|------------------------|----------------|---------------|--------------|
| | | | |

*For upgrades, the issuer certifies all upgrade requirements are met: Friction values ≥40 in affected third(s), friction equipment is calibrated; airport judgment, observations, and vehicle braking action support upgraded codes; continuously monitor conditions while the upgraded codes are in effect.

*For downgrades, the issuer certifies all downgrade requirements are met: Airport operator experience, Friction values <40 in affected third(s), deceleration and directional control observation(s), and/or Pilot reported braking action from landing aircraft.

Remarks, if applicable (Remainders, Treatments, Snowbanking, etc.):

ATCT: _____ ISSUER: _____

Taxiway/Holding Bay Condition

| Designation | Estimated Braking | Contaminants |
|-------------|-------------------|--------------|
| | | |
| | | |
| | | |
| | | |

Apron Condition

| Designation | Estimated Braking | Contaminants |
|-------------|-------------------|--------------|
| | | |
| | | |
| | | |
| | | |

ATCT: _____ ISSUER: _____

APPENDIX B. DEVELOPMENT OF RECOMMENDED SNOW BANK HEIGHT PROFILES

- B.1 Figure B-1 and Figure B-2 were used to develop the recommended snow bank profile limits for Figure 4-1. Location and height above a horizontal reference line of airplane wingtips and outer and inner engine nacelles' lower edges with airplane outer main gear on the pavement edge determined individual profiles. These individual profiles were then grouped according to airplane design groups to generate the recommendations.

Figure B-1. Individual Height Profiles of Airplane Wingtips and Outer and Inner Engine Nacelles' Lower Edges for Airplane Design Groups III and IV

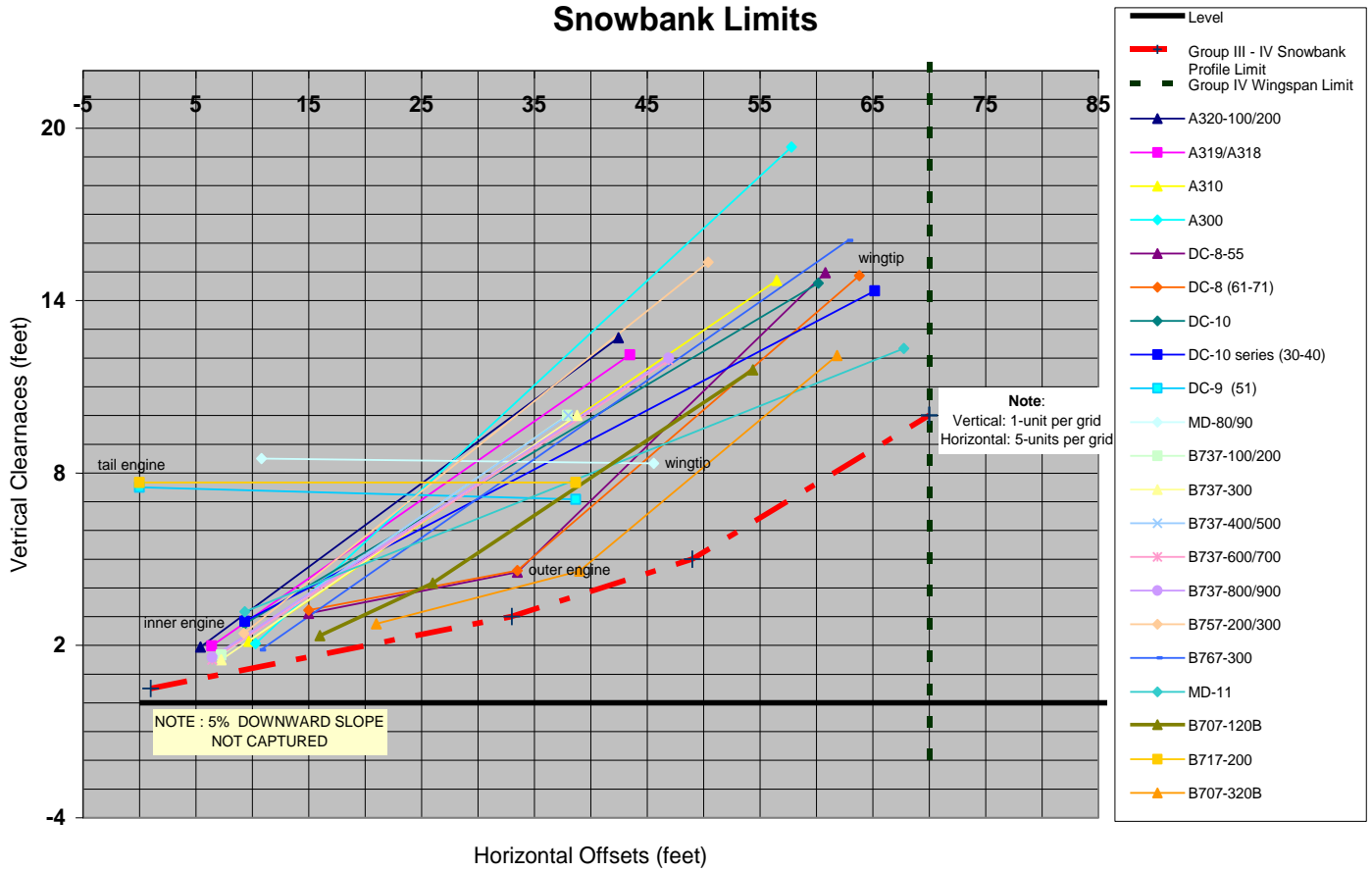
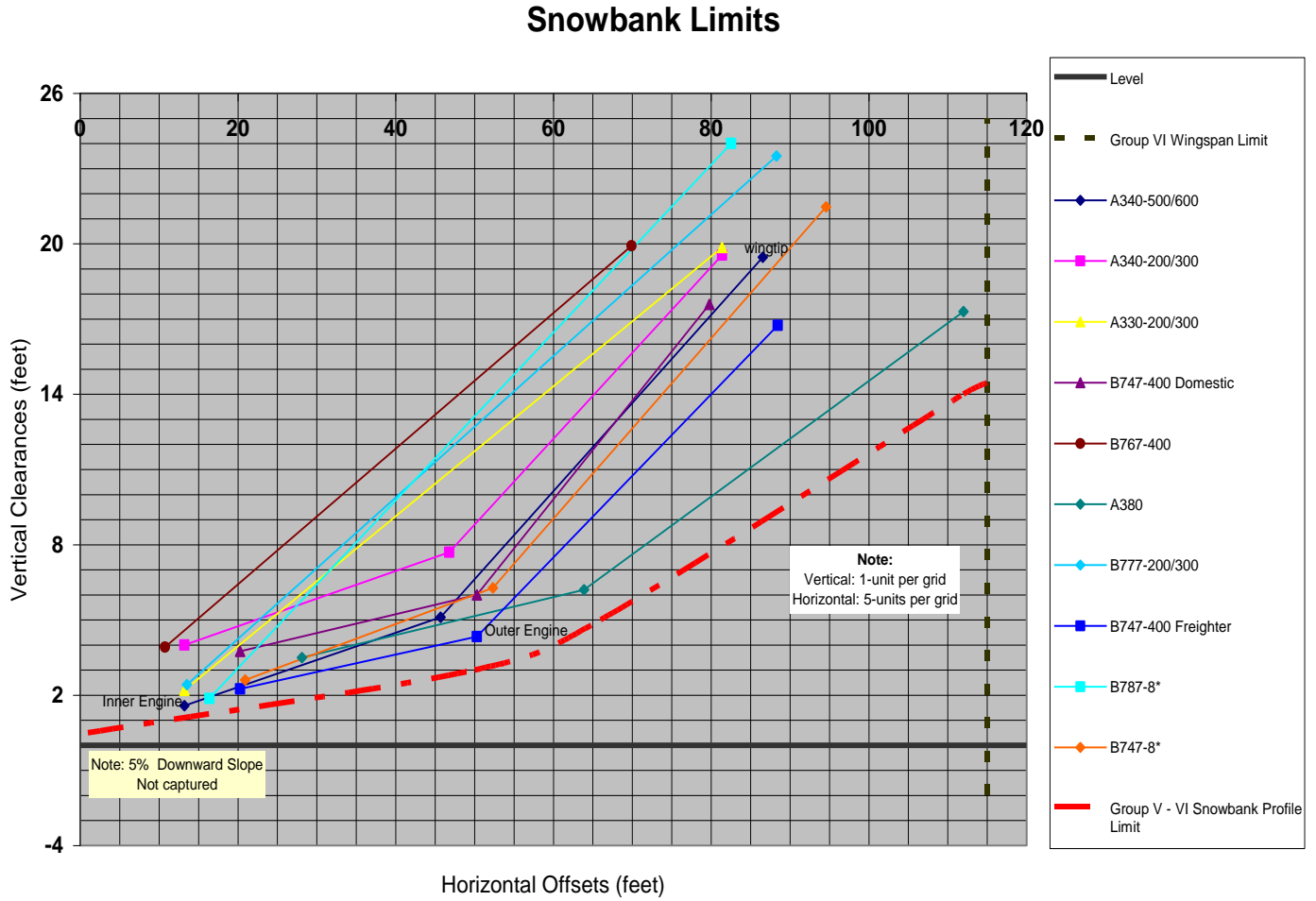

Figure B-2. Individual Height Profiles of Airplane Wingtips and Outer and Inner Engine Nacelles' Lower Edges for Airplane Design Groups V and VI (* indicates preliminary data)



This page intentionally left blank.

APPENDIX C. SNOW AND ICE CONTROL AS A MATERIALS-HANDLING PROBLEM

C.1 Introduction.

Snow and ice have many unique properties that distinguish them from other materials commonly handled by mechanized mobile equipment. Earthmoving equipment, for example, is generally not well-adapted to handling snow because the properties of snow are so different from earth and other minerals for which this equipment was designed. Typical of these properties is the unique density, hardness, thermal instability, cohesiveness, and metamorphism (age hardening) of snow under varying winter conditions.

C.2 Snow.

Snow is a porous, permeable aggregate of ice grains that can be predominantly single crystals or a close grouping of several crystals. For material handling purposes, the airport operator will typically encounter three identified types of snow. They are defined as follow:

1. **Dry Snow:** Snow that has insufficient free water to cause it to stick together. This generally occurs at temperatures well below 32° F (0° C). If when making a snowball, it falls apart, the snow is considered dry.
2. **Wet Snow:** Snow that has grains coated with liquid water, which bonds the mass together, but that has no excess water in the pore spaces. A well-compacted, solid snowball can be made, but water will not squeeze out. .
3. **Compacted Snow:** Snow that has been compressed and consolidated into a solid form that resists further compression such that an airplane will remain on its surface without displacing any of it. If a chunk of compressed snow can be picked up by hand, it will hold together or can be broken into smaller chunks rather than falling away as individual snow particles.

C.2.1 Density.

This is the weight per unit volume, a measure of how much material there is in a given volume. Values range from a very low 3 lb/ft³ (48 kg/m³) for low density, new snow to about 37 lb/ft³ (593 kg/m³) for older snow. Old snow that has not been compacted by vehicles or other loads normally will not exceed a density of 25 lb/ft³ (400 kg/m³). When density exceeds 50 lb/ft³ (801 kg/m³), the air passages become discontinuous and the material becomes impermeable; by convention, it is called ice. Un-compacted snow has little bearing capacity, so wheels readily sink into it and encounter rolling resistance. Snow increases in density either by deformation, such as trafficking, or by a natural aging process (see Paragraph C.2.5 below). Density is measured by weighing a sample of known volume. Though earth will compact to some extent, its density on handling will increase only a few percent. In contrast, snow will easily increase in density over 80 percent during plowing or trafficking.

C.2.2 Hardness.

Hardness or strength depends on the grain structure and temperature. Grain structure, in turn, is dependent on the density of the snow and the degree of bonding between adjacent grains. Snow when it first falls is cohesion less—i.e., individual grains do not stick to one another—but bonds quickly, forming and growing at grain contacts. As the temperature of the snow approaches the melting point, 32° F (0° C), liquid water begins to coat the snow grains. Although density remains the same, the strength will decrease. Conversely, the strength or hardness will increase as the temperature drops. Hard snow is difficult to penetrate with a bucket or a blade plow or to disaggregate with a rotary plow. Typical values for unconfined compressive strength of well-bonded snow range from less than 1 lb/in² (6.89 kPa) for new snow with a density of 6.2 lb/ft³ (100 kg/m³) to 30 lb/in² (207 kPa) for well-bonded snow with a density of 25 lb/ft³ (400 kg/m³).

Hardness is sometimes determined by measuring the resistance to penetration. However, since a very good correlation exists between compressive strength and density for cold snow, determination of the density might suffice to indicate the snow hardness. In contrast, the strength of dry, frozen ground is little different from thawed ground. It is only when soil contains water that the strength increases upon freezing; and depending upon the ice content, it will be much like hard, compacted snow or ice in its strength.

C.2.3 Thermal Instability.

Snow exists at temperatures relatively close to its melting point. Most snow properties are dependent on the temperature. Strength, for example, will decrease rapidly when the temperature approaches 32° F (0° C) and will increase, though at a slower rate, as the temperature is lowered. The thermal instability of snow is particularly important in the case of metamorphism (see Paragraph C.2.5 below).

C.2.4 Cohesiveness.

Individual snow grains will bond to one another to form a consolidated mass. Although cold, dry snow when initially deposited will lack cohesion, the age hardening process will quickly lead to bond formation and increasing cohesion (see Paragraph C.2.4 below). Fine particles of snow produced by a rotary snowplow will adhere to each other on contact and tend to clog cutting and blowing equipment.

C.2.5 Metamorphism.

Metamorphism is also called age hardening. The structure of a snow mass is continually changing by migration of water vapor from small to large grains. The number and extent of grain bonds increases with time even in an uncompacted mass, and, as a consequence, the density and the strength increase. The rate of change is increased when a natural snow cover is disturbed by wind drifting or by mechanical agitation, such as plowing; in either case, the snow is broken into smaller fragments, increasing the surface area and the potential for a greater number of grain contacts. The increase in strength or hardness can be very rapid following plowing, particularly after blowing with a rotary snowplow. Only 2 or 3 hours after plowing, snow may require three times the amount of work to reprocess it. For this reason, it is advisable to clear snow to its

final location as promptly as possible in order to minimize the amount of work involved.

C.3 **Ice.**

The solid form of frozen water to include ice that is textured (i.e., rough or scarified ice). Its strength and slipperiness distinguish it from snow both in the action of rubber tires trafficking on ice-covered pavement and in the effort involved in its removal.

C.3.1 Methods of Formation.

There are four common methods by which ice will form on a surface:

1. radiation cooling,
2. freezing of cold rain,
3. freeze-thaw of compacted snow, and
4. freezing of ponded or melt water.

C.3.1.1 **Radiation Cooling.**

A body will radiate energy to another body having a lower temperature. Pavement exposed to the night sky will radiate energy to that nearly perfect blackbody, and if the heat is not replaced as rapidly as it is lost, cooling will result. Pavement temperature can drop below freezing even when the air temperature is above freezing. Water vapor in the air deposits on the cold surface and freezes; the rate and quantity depend on the amount of moisture in the air and the rate at which the heat of condensation and fusion of the water vapor are dissipated. The ice forms in discrete particles and may not cover the pavement completely. Bonding is generally not very strong since particle contact area is small even when the pavement is completely covered, and therefore removal is not difficult. A term applied to this type of ice is surface hoar, or more commonly "hoarfrost." On occasion, dew will form and then freeze; because of its greater area of contact, bonding will be very strong. Since the layer of ice so formed will be very thin and nearly invisible, it is sometimes called "black ice." Clouds or fog will usually prevent cooling of pavement by outgoing radiation.

C.3.1.2 **Freezing of Cold Rain.**

Freezing rain is one of the most common methods of ice formation and one of the most difficult to remove. If the pavement is at or below 32° F (0° C), rain falling on it can freeze, depending on a number of factors. Conditions favoring formation of so-called glare ice or glaze, a homogeneous clear ice cover, are a slow rate of freezing, large droplet size, high precipitation rate, and no more than a slight degree of supercooling. The rain has an opportunity to flow over the surface before freezing, forming a smooth, tightly bonded cover. Glaze usually forms at air temperatures between 27° F and 32° F (-3° C to 0° C), though some cases have been reported as low as -

5° F (-20° C) or as high as 37° F (3° C). Because of its intimate contact with the pavement, glaze ice is difficult to remove by mechanical means.

C.3.1.3 Freeze-thaw of Compacted Snow.

At low temperatures compaction of cold dry snow by passage of wheels will not cause a strong bond to develop between snow and pavement. However, if the snow has a high water content or some melting takes place and the temperature subsequently drops, a bond as strong as that of glaze ice can develop.

C.3.1.4 Freezing of Ponded or Melt Water.

These are commonly called icings (or “glaciers” in some regions). Though the term was originally limited to ice formed from groundwater flowing onto a pavement, by extension it applies to water from any source other than directly from rain. Thus, melt water resulting from poor drainage or water impounded by snow windrows can cause icings. This type of ice is usually well bonded to the pavement and, in addition, its thickness may exceed that of the other types described above. This is the easiest kind of ice to avoid; proper maintenance practices will prevent accumulation of water leading to icings.

C.3.2 Adhesion to Surfaces.

The bond between ice and pavement when it is well developed will exceed the tensile strength of ice; and, therefore, when mechanical removal is attempted, failure will occur either within the ice or in the pavement itself.

C.3.3 Density.

Bubble-free ice has a density of 57 lb/ft³ (914 kg/m³), though by convention compacted snow that has become impermeable (there are no connected air passages) is called ice. This occurs at a density of about 50 lb/ft³ (801 kg/m³). Ice arising from compacted snow will not ordinarily densify beyond this value.

C.3.4 Strength.

C.3.4.1 Ultimate strengths of ice at 23° F (-5° C) are as follows:

| | | |
|--------------------------|------------------------|-------------------------|
| Tension | 15 kgf/cm ² | 210 lbf/in ² |
| Compression | 36 | 500 |
| Shear | 7 | 100 |
| Flexure (bending) | 17 | 240 |

C.3.4.2 Ice in the vicinity of the melting point has even lower flexural rigidity and, therefore, will not be fractured when a tire rolls over an ice-covered pavement. Ice becomes brittle with increasing rigidity at low temperatures

(below 20° F (-6.7° C)). The bond strength also increases as the temperature decreases.

C.4 **Slush.**

Snow that has water content exceeding a freely drained condition such that it takes on fluid properties (e.g., flowing and splashing). Water will drain from slush when a handful is picked up. This type of water-saturated snow will be displaced with a splatter by a heel and toe slap-down motion against the ground. Upon impacting a surface, such as the landing gear or underside of an airplane, the excess water will drain, and the snow will compact and frequently bond to the surface. Slush on a runway is a hazard because it—

1. Greatly increases drag during the takeoff roll.
2. Greatly reduces directional control.
3. Decreases braking effectiveness. Slush can be removed by use of displacement plows, which are preferably fitted with rubber or polymer cutting edges (see Paragraph 4.2.2).

This page intentionally left blank.

APPENDIX D. DECELEROMETERS THAT MEET FAA TECHNICAL SPECIFICATIONS

| Distributor | Decelerometer |
|--|--|
| BOWMONK USA Distributor Sherwin Industries, Inc. 2129 West Morgan Avenue Milwaukee, WI 53221 | BOWMONK DECELEROMETER (414) 281-6400 FAX (414) 281-6404 email: runway@sherwinindustries.com |
| TAPLEY SALES (CANADA) 241 Norseman Street Toronto, Ontario CANADA M8Z 2R5 | TAPLEY DECELEROMETER (416) 231-9216 FAX (416) 231-9121 |
| TES INSTRUMENTS 1 Stafford Road East Suite 303 Ottawa, Ontario CANADA K2H 1B9 | TES ERD MK3 DECELEROMETER (613) 832-2687 FAX (613) 832-2721 |
| VERICOM COMPUTERS, INC. 14320 James Road Suite 200 Rogers, MN 55374 | VERICOM VC4000 RFM DECELEROMETER (800) 533-5547 FAX (763) 428-4856 |
| NEUBERT AERO CORP. 14141 46th Street North Suite 1206 Clearwater, FL 33762 | NAC DYNAMIC FRICTION DECELEROMETER (DFD) (727) 538-8744 FAX (727) 538 8765 Email: info@airportnac.com |

See Advisory Circular 150/5320-12, *Measurement, Construction, and Maintenance of Skid-Resistant Airport Pavement Surfaces*, for approved Continuous Friction Measuring Equipment (CFME).

This page intentionally left blank.

APPENDIX E. PERFORMANCE SPECIFICATION FOR DECELEROMETERS

E.1 Scope.

This Appendix describes the procedures for establishing the reliability, performance, and consistency of decelerometers.

E.2 Certification (General).

The manufacturer will certify electronic or mechanical decelerometers are—

1. Portable, rugged, and reliable.
2. Capable of being fitted to vehicles qualified by the requirements given in this specification. Minimal vehicle modifications will be necessary to accommodate the mounting plates and electrical connections. Vehicles are qualified according to their size, braking and suspension system, shock absorber capabilities, and tire performance. The vehicles must have the following properties:
 - a. Be either large sedans, station wagons, intermediate or full-sized automobiles, or utility and passenger-cargo trucks. Vehicles can be powered by front-wheel, rear-wheel, or four-wheel drive.
 - b. Be equipped with either standard disc and/or drum brakes as long as they are maintained according to the manufacturer's performance requirements.
 - c. Accurately measure μ after taking into consideration the anti-lock braking system (ABS) of the host vehicle. The vendor will indicate whether the readings are conservative or not based on their equipment's functionality with the current host vehicle's ABS.

Note: The FAA is currently working with vendors to determine the effect of ABS on decelerometer readings and any reading adjustments that are to be made.
 - d. Be equipped with heavy-duty suspension and shock absorbers to minimize the rocking or pitching motion during the application of brakes. The weight should be distributed equally to the front and rear axle of the vehicle. Ballast can be added to achieve and maintain this distribution.
 - e. Have tires made from the same construction, composition, and tread configuration. Inflation pressure must be maintained according to the vehicle manufacturer's specifications. When tread wear is excessive on any one tire on the vehicle and/or exceeds 75 percent of the original tread, all four tires on the vehicle must be replaced with new tires.
3. Capable of measuring the deceleration of the vehicle from speeds greater than or equal to 15 mph (24 km/h) to an accuracy of 0.02 g.
4. Capable of providing deceleration values upon request of the operator.
5. Capable of consistently repeating friction averages throughout the friction range on all types of compacted snow and/or ice-covered runway pavement surfaces.

6. Not affected by changes in vehicle velocity.
7. Not affected by change in personnel or their performance in brake-applied decelerations.
8. Capable of providing the vehicle operator with a readily visible deceleration reading.

E.3 **Certification (Electronic Only).**

The manufacturer must certify electronic decelerometers are—

1. Capable of providing the deceleration values in recorded order, enabling the average friction value for any length of runway to be either electronically or manually calculated.
2. Capable of providing average deceleration values for touchdown, midpoint, and rollout zones of the runway and the average friction value for the entire runway tested. These averages must be automatically calculated by the decelerometers, thus eliminating potential human error when calculated manually.
3. Capable of storing a minimum of 21 deceleration values via the internal microprocessor memory.
4. Capable of providing a hard copy printout of stored deceleration values at the end of the testing period. The printout will record at minimum—
 - a. The date.
 - b. The time.
 - c. The runway designation or heading.
5. Capable of providing further information, which may be recorded at the manufacturer's discretion, e.g., make of decelerometer, ambient/pavement temperature, airport name and location, and operator identification.

E.4 **Decelerometer Calibration.**

The decelerometer must be calibrated by the manufacturer before shipping to the airport operator. The manufacturer must provide the airport operator with a certificate of calibration, including test results of the calibration. The manufacturer must provide a 1-year warranty for the decelerometer. The manufacturer must provide the airport operator with a recommended frequency for factory calibration of the decelerometer.

E.5 **Training.**

The manufacturer must provide the airport operator with training manuals and/or videos of all relevant data concerning friction measuring recording and reporting, including—

1. An outline of the principals involved in the operation of the decelerometer-type friction-measuring device.

2. Copies of pertinent ACs.
3. Procedures for reporting results of the friction tests in NOTAM format.

**APPENDIX F. RUNWAY CONDITION ASSESSMENT MATRIX (RCAM)
(FOR AIRPORT OPERATORS' USE ONLY)**

| Assessment Criteria | | Downgrade Assessment Criteria | | |
|--|----------|-------------------------------|---|-------------------------------|
| Runway Condition Description | Code | Mu (μ) ¹ | Vehicle Deceleration or Directional Control Observation | Pilot Reported Braking Action |
| <ul style="list-style-type: none"> Dry | 6 | 40 or Higher | --- | --- |
| <ul style="list-style-type: none"> Frost Wet (Includes Damp and 1/8 inch depth or less of water) <p>1/8 inch (3mm) depth or less of:</p> <ul style="list-style-type: none"> Slush Dry Snow Wet Snow | 5 | | Braking deceleration is normal for the wheel braking effort applied AND directional control is normal. | Good |
| <p>5° F (-15°C) and Colder outside air temperature:</p> <ul style="list-style-type: none"> Compacted Snow | 4 | 39 to 30 | Braking deceleration OR directional control is between Good and Medium. | Good to Medium |
| <ul style="list-style-type: none"> Slippery When Wet (wet runway) Dry Snow or Wet Snow (Any depth) over Compacted Snow <p>Greater than 1/8 inch (3mm) depth of:</p> <ul style="list-style-type: none"> Dry Snow Wet Snow <p>Warmer than 5° F (-15°C) outside air temperature:</p> <ul style="list-style-type: none"> Compacted Snow | 3 | | Braking deceleration is noticeably reduced for the wheel braking effort applied OR directional control is noticeably reduced. | Medium |
| <p>Greater than 1/8 (3mm) inch depth of:</p> <ul style="list-style-type: none"> Water Slush | 2 | 29 to 21 | Braking deceleration OR directional control is between Medium and Poor. | Medium to Poor |
| <ul style="list-style-type: none"> Ice² | 1 | | Braking deceleration is significantly reduced for the wheel braking effort applied OR directional control is significantly reduced. | Poor |
| <ul style="list-style-type: none"> Wet Ice² Slush over Ice Water over Compacted Snow² Dry Snow or Wet Snow over Ice² | 0 | 20 or Lower | Braking deceleration is minimal to non-existent for the wheel braking effort applied OR directional control is uncertain. | Nil |

¹ The correlation of the Mu (μ) values with runway conditions and condition codes in the Matrix are only approximate ranges for a generic friction measuring device **and are intended to be used only to downgrade a runway condition code; with the exception of circumstances identified in Note 2.** Airport operators should use their best judgment when using friction measuring devices for downgrade assessments, including their experience with the specific measuring devices used.

² In some circumstances, these runway surface conditions may not be as slippery as the runway condition code assigned by the Matrix. The airport operator may issue a higher runway condition code (but no higher than code 3) for each third of the runway if the Mu value for that third of the runway is 40 or greater obtained by a properly operated and calibrated friction measuring device, **and all other observations, judgment, and vehicle braking action support the higher runway condition code. The decision to issue a higher runway condition code than would be called for by the Matrix cannot be based on Mu values alone; all available means of assessing runway slipperiness must be used and must support the higher runway condition code.** This ability to raise the reported runway condition code to a code 1, 2, or 3 can only be applied to those runway conditions listed under codes 0 and 1 in the Matrix.

The airport operator must also continually monitor the runway surface as long as the higher code is in effect to ensure that the runway surface condition does not deteriorate below the assigned code. The extent of monitoring must consider all variables that may affect the runway surface condition, including any precipitation conditions, changing temperatures, effects of wind, frequency of runway use, and type of aircraft using the runway. If sand or other approved runway treatments are used to satisfy the requirements for issuing this higher runway condition code, the continued monitoring program must confirm continued effectiveness of the treatment.

Caution: Temperatures near and above freezing (e.g., at 26.6° F (-3°C) and warmer) may cause contaminants to behave more slippery than indicated by the runway condition code given in the Matrix. At these temperatures, airport operators should exercise a heightened level of runway assessment, and should downgrade the runway condition code if appropriate.

Advisory Circular Feedback

If you find an error in this AC, have recommendations for improving it, or have suggestions for new items/subjects to be added, you may let us know by (1) mailing this form to Manager, Airport Safety and Operations Division, Federal Aviation Administration ATTN: AAS-300, 800 Independence Avenue SW, Washington DC 20591 or (2) faxing it to the attention of the Office of Airport Safety and Standards at (202) 267-5383.

Subject: AC 150/5200-30D

Date: _____

Please check all appropriate line items:

- An error (procedural or typographical) has been noted in paragraph _____ on page _____.

- Recommend paragraph _____ on page _____ be changed as follows:

- In a future change to this AC, please cover the following subject:
(Briefly describe what you want added.)

- Other comments:

- I would like to discuss the above. Please contact me at (phone number, email address).

Submitted by: _____

Date: _____