

GOVERNMENT/INDUSTRY AERONAUTICAL CHARTING FORUM
Instrument Procedures Group
October 25, 2011
HISTORY RECORD

FAA Control # 11-02-297

Subject: Airway "NoPT" Notes on Instrument Approach Procedures

Background/Discussion: Some of the "NoPT" notes on IAP charts are confusing and allow two different interpretations of intent. For example, The note on the Chester, CT (SNC) VOR-A approach states "NoPT for arrival on MAD VOR/DME airway radials 235 CW 317". The note specifies airway radials and Air Traffic expects that aircraft arriving on V-34, V-475, or V-1 from the west comply with the NoPT note and execute a straight in approach. However, the note results in about half of the pilots thinking that it applies to all radials from 235 clockwise to 317. This misinterpretation has been noted in both newly rated and highly experienced pilots.

Recommendations: On the Chester approach note and any other location where ATC wants to apply NoPT only to specific airways, the note must list the specific airway(s) and direction of flight; e.g., "**NoPT for arrival at MAD VOR/DME on V-1 northeast bound, V475 northeast bound, and V-34 southeast bound.**" Additionally enhanced guidance should be placed in the AIM and IPH.

Comments: This recommendation affects FAA Order 8260.19, the Aeronautical Information Manual (AIM), and the Instrument Procedures Handbook.

Submitted by: Bruce McGray

Organization: FAA AFS-410

Phone: 202 385 4937

FAX:

E-mail: Bruce.McGray@faa.gov

Date: 6 October 2011

CHESTER, CONNECTICUT

AL-6356 (FAA)

VOR/DME MAD 110.4 Chan 41	APP CRS 076°	Rwy Idg TDZE Apt Elev N/A N/A 416
--	------------------------	---

VOR-A
CHESTER(SNC)

Procedure NA at night except by prior arrangement for runway lights.
When local altimeter setting not received, use Meriden altimeter setting and increase all MDA 100 feet.

MISSED APPROACH: Climbing right turn to 2100 direct MAD VOR/DME and hold.

AWOS-3 118.325	NEW YORK APP CON 124.075 343.65	UNICOM 122.725 (CTAF)
--------------------------	---	---------------------------------

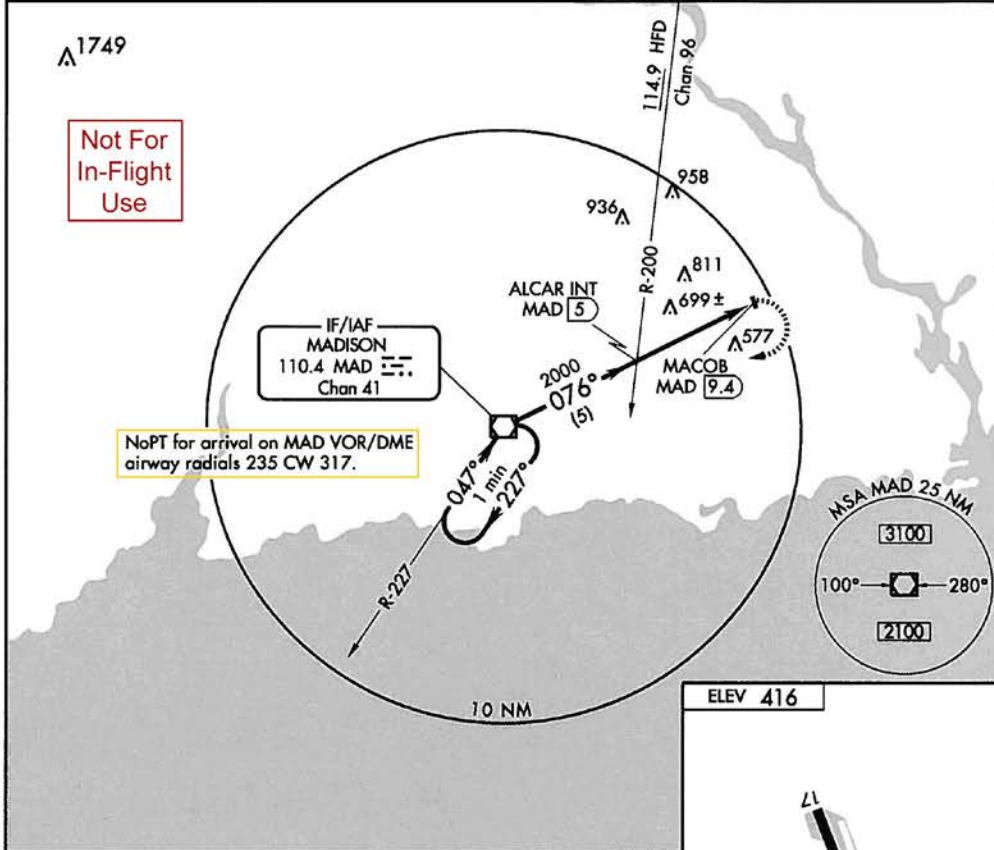

NE-1, 22 SEP 2011 to 20 OCT 2011

NE-1, 22 SEP 2011 to 20 OCT 2011

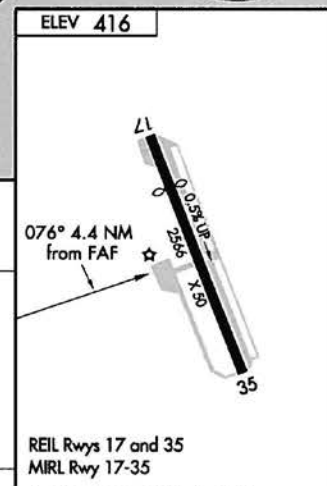
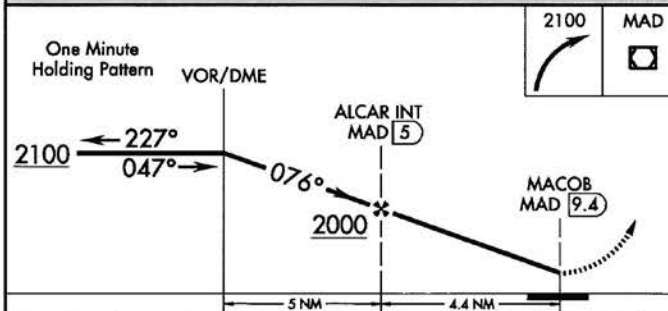

CATEGORY	A	B	C	D	FAF to MAP 4.4 NM					
CIRCLING	960-1	544 (600-1)		NA	Knots	60	90	120	150	180
					Min:Sec	4:24	2:56	2:12	1:46	1:28

CHESTER, CONNECTICUT
Amdt 4 10322

41° 23'N-72° 30'W

CHESTER (SNC)
VOR-A

KSNC
CHESTER

JEPPESEN
21 AUG 09 (13-1) Eff 27 Aug CAT A & B

CHESTER, CONN
VOR-A

AWOS-3 118.32		NEW YORK Approach (R) 124.07		CHESTER UNICOM CTAF 122.72	
VOR MAD 110.4	Final Apch Crs 076°	Minimum Alt ALCAR 2000' (1584')	MDA(H) Refer to Minimums	Apt Elev 416'	
MISSED APCH: Climbing RIGHT turn to 2100' direct MAD VOR and hold. Alt Set: INCHES Trans level: FL 180 Trans alt: 18000' 1. Use local altimeter setting; if not received, use Meridan altimeter setting. 2. Procedure not authorized at night except by prior arrangement for runway lights.					3100' 100° ← → 280° 2100' MSA MAD VOR

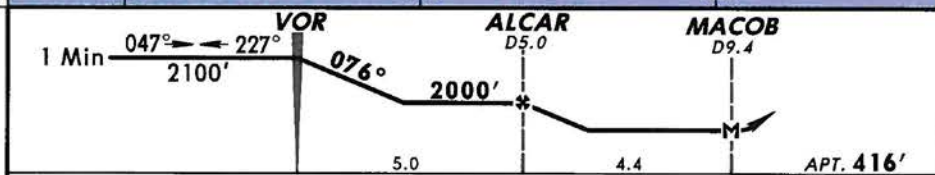
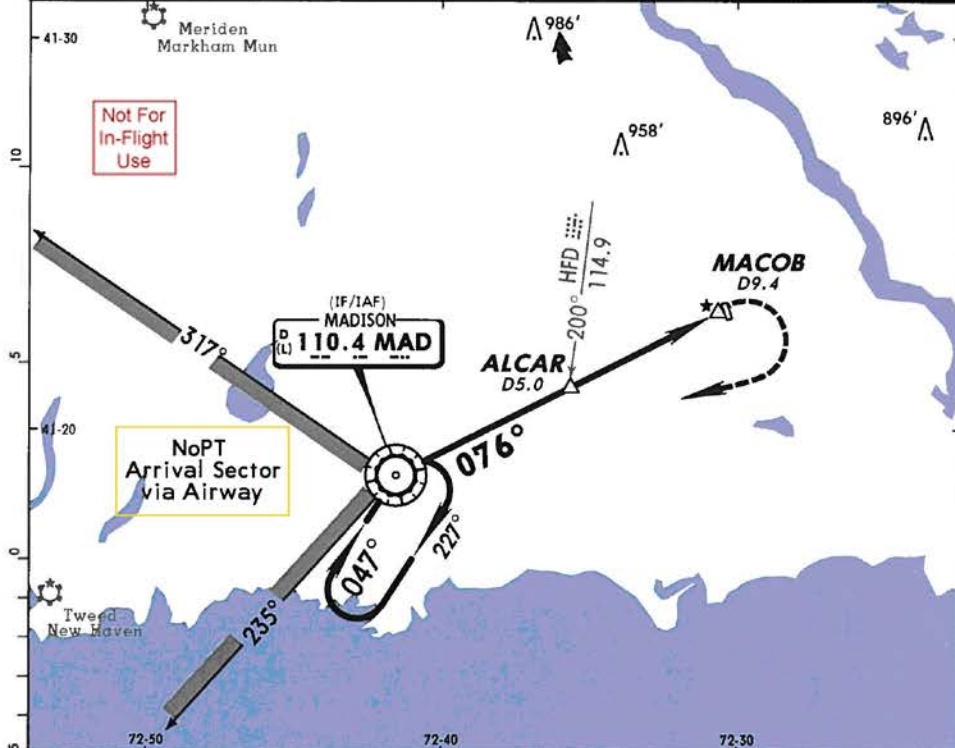

Gnd speed-Kts	70	90	100	120	140	160	Lighting - Refer to Airport Chart	2100'	RT	MAD 110.4
MAP at MACOB or ALCAR to MAP	4.4	3:46	2:56	2:38	2:12	1:53				

		CIRCLE-TO-LAND	
		With Local Altimeter Setting	With Meridan Altimeter Setting
TERPS 4 02-20-24	Max Kts	MDA(H)	MDA(H)
	A 90	960' (544')-1	1060' (644')-1
	B 120		
	C	NA	NA
	D		

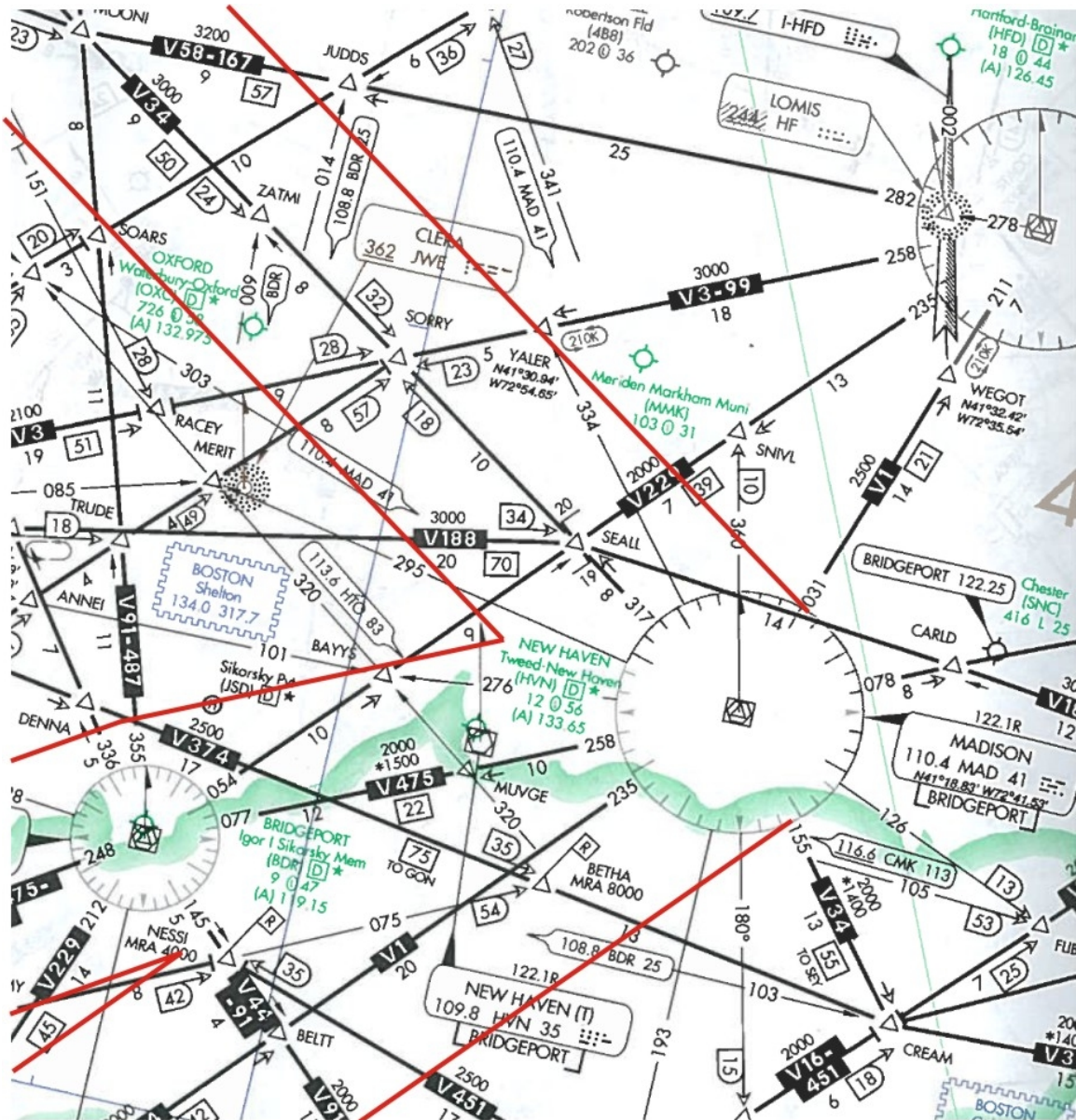

INITIAL DISCUSSION (Meeting 11-02): New issue presented by Bruce McGray, AFS-410. The issue asserts that the current note used by the FAA to allow a NoPT routing when arriving at an IAF via airways is confusing. Some pilots correctly interpret the note as requiring the aircraft to be navigating via an airway. Other pilots interpret the note as NoPT is allowed from anywhere within the sector described by the applicable airway radials. A copy of Bruce's briefing slides is attached here (). A good discussion ensued. Bill Hammett, AFS-420 (ISI) stated that the current note; e.g., "NoPT for arrival on ABC VOR airway radials 235 CW 317" has been the standard since the early 1980s. He believes it odd that the note is only causing confusion now; perhaps pilot education could address the issue better than making changes to charts. Bill added that if a note change is made, it will

take years to revise all the current charted notes. Paul Eure, AJE-31, stated that with the current proposal to allow ATC to clear aircraft direct to an IAF or IF and for a straight-in approach, the note may be a moot point. Ted Thompson, Jeppesen, stated that back in the early '80s, Jeppesen established one standard for charting these notes. The crux of the discussion is that the current note using the terms "radials" and "clockwise" as well as the Jeppesen depiction tend to support a sector interpretation. If the intent is to be via the airway, then the airway should be specified and not the associated radials, e.g., V1, V475, and V34. Bill Hammett, AFS-420 (ISI) stated that if the airway is specified, then the direction of flight must also be specified to ensure TERPS turn angle requirements are not exceeded; e.g., "V1 northeast bound". Brad noted that some VORs have as many as 8 airways that qualify for NoPT arrivals and specifying a large number of airways and direction of flight could cause some lengthy notes. John Moore, AJV-3B, recommended that the AFS-400 Human Factors Specialist assess the issue. Bruce McGray took the IOU to accomplish this coordination. **ACTION AFS-410.**

MEETING 12-01: Bruce McGray, AFS-410, briefed that he had presented the issue to FAA Human Factors, ANG-C1 who conducted some studies using the Chester, CT VOR-A approach. Based on the currently charted NoPT note, 50% of the pilots queried were correct in understanding that being on the airway was required to take advantage of the NoPT route. The other 50% incorrectly understood the radials could be interpreted as defining a NoPT "sector". Several verbiage changes were again discussed; "*NoPT for arrivals on MAD Victor Airway radials 235, 258, and 317*"; "*NoPT for arrivals on airways V-1, V-475 and V-34 on MAD VOR radials 235, 258, and 317*". Gary Fiske, representing AJT-2A3, suggested the note just state the applicable airways. Bill Hammett, AFS-420 (ISI), responded that if this is done, since many airways are bi-directional over a facility/fix, the direction must be included to ensure maximum turn limitations were not exceeded. He referred to the verbiage in the original Recommendation Document, which, although lengthy, cannot be confused. Gary then stated that imbedded in the guidance in Order JO 7110.65, paragraph 4-8-1, controllers may clear aircraft on unpublished routes direct to an IAF or IF, if within 90 degrees, and specifically state "straight-in" in the approach clearance. John Collins, GA Pilot, stated that it is a good idea for controllers to assume that pilots will not conduct a course reversal maneuver if on an obvious route for a straight-in approach, even though one is required under Part 91. No consensus on preferred language was reached and AFS-410 will continue to work the issue. **ACTION AFS-410.**

MEETING 12-02: Bruce McGray, AFS-410, briefed that his office is pursuing a "pop-up" research project for a human factors assessment on the issue. He mentioned the possibility of involving Volpe NTSC in writing the testing standards to determine whether pilots are interpreting the NoPT note as applicable to airway radials only or to an entire sector. **ACTION AFS-410.**

MEETING 13-01: Bruce McGray, AFS-410, reviewed the issue for new participants and provided a recommended solution that should clarify the intent of the note. A copy of Bruce's slides is included here (). The recommended chart note will specify the airway radials; e.g., "**NoPT for arrival on MAD VOR/DME airway radials R-235, R-258 and R-317**". AFS believes the designation of specific airway radials and elimination of the terms "clockwise" (CW) and "counter-clockwise" (CCW), should eliminate human factors concerns

for pilots, controllers, and cartographers alike. Tom Schneider, AFS-420, agreed to include the revised verbiage in the next iteration of FAA Order 8260.19. The issue will be tracked in an "Open - pending publication" status.

MEETING 13-02: Tom Schneider, AFS-420, briefed that, as noted at the last meeting, the change to resolve this issue has been included Order 8260.19F, which is just completing the formal coordination process and is still on target for publication in early 2014. AFS-420 will track the change to Order 8260.19. **ACTION AFS-420.**

MEETING 14-01: Tom Schneider, AFS-420, advised that Order 8260.19F has been published. This item can be closed.

Status: **Issue CLOSED**