

Wilbur and Orville Wright

★ ★ ★ ★ ★ ★ ★ ★ ★ ★
★ ACTIVITY BOOK

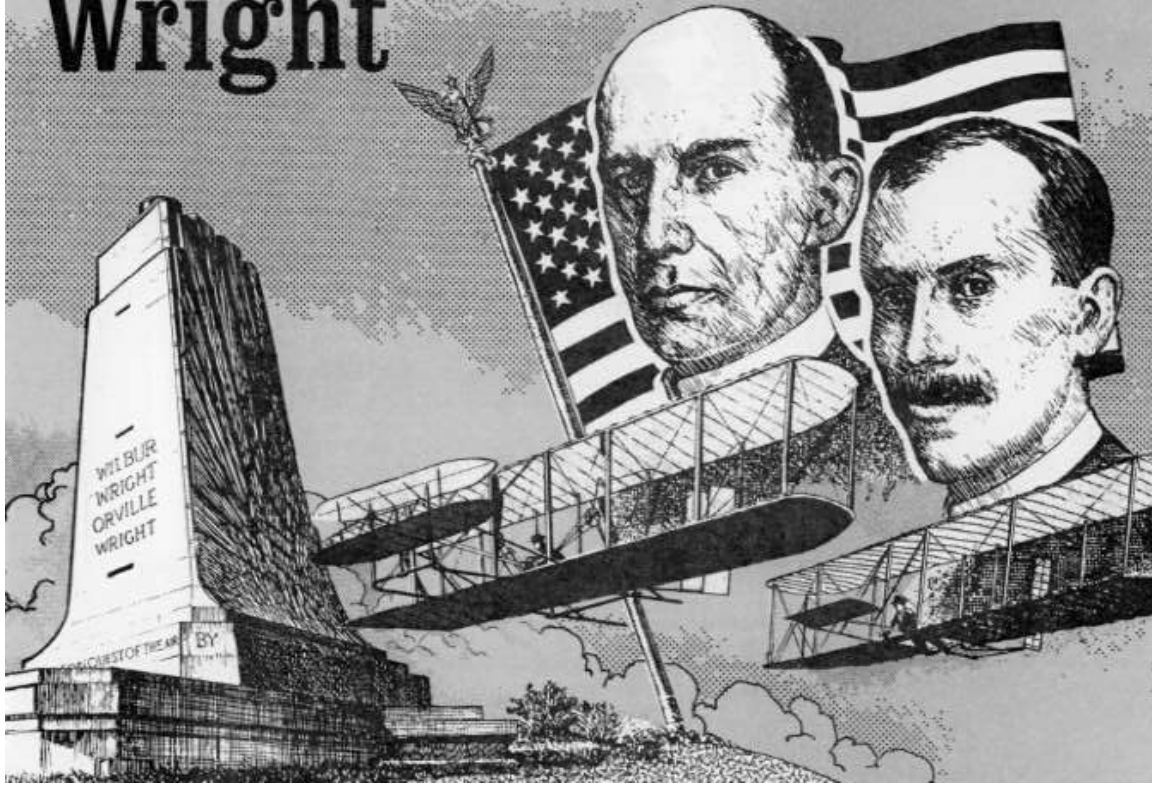

ORVILLE and WILBUR WRIGHT'S EARLY LIFE



THEIR FATHER'S NAME WAS MILTON WRIGHT. HE WAS A MINISTER.

WILBUR WAS BORN IN 1867.

THEIR MOTHER'S NAME WAS SUSAN CATHERINE KOERNER WRIGHT.

ORVILLE WAS BORN IN 1871.

THEY FIRST BECAME INTERESTED IN FLYING AFTER THEIR FATHER GAVE THEM A TOY HELICOPTER.

AS YOUNG BOYS, THE WRIGHT BROTHERS WATCHED BIRDS AND BUILT AND FLEW KITES.

O
H
I
O

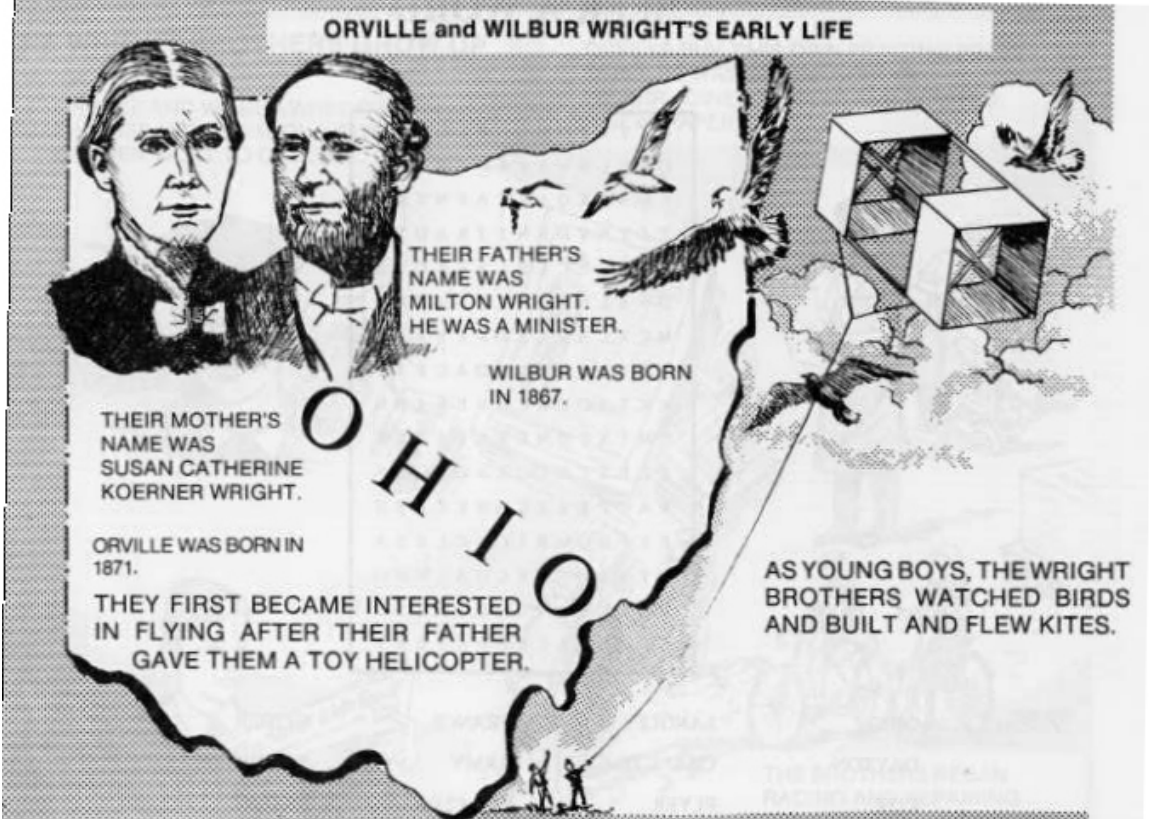

SEEK A WORD

Find the words in the puzzle that were important to the Wright brothers.

C	K	T	X	P	D	M	C	G	F	L	Q	S	Z	G
Q	H	U	L	N	W	A	Z	F	O	E	R	P	B	L
L	M	A	A	K	Q	I	E	S	A	F	N	T	K	I
T	I	Y	N	V	D	F	N	T	J	R	A	U	T	D
B	N	S	G	U	C	E	F	L	Y	E	R	C	Y	E
O	W	B	L	C	T	H	R	I	R	S	M	K	F	R
M	C	X	E	A	I	E	A	U	R	P	Y	T	A	E
A	E	F	Y	P	U	W	N	T	Q	A	C	F	J	T
X	K	T	J	D	C	G	C	H	U	E	R	I	H	N
V	M	I	X	P	D	N	E	W	S	P	A	P	E	R
P	D	L	T	C	B	L	Q	X	A	O	V	G	C	T
P	A	C	P	E	R	S	C	O	H	K	Z	E	B	H
E	Y	P	N	Q	M	B	I	C	Y	C	L	E	S	A
S	T	X	I	U	C	H	E	C	Q	A	J	M	W	O
U	O	I	C	Z	O	M	O	K	D	G	H	Z	Y	O
J	N	X	L	T	A	C	R	Z	P	A	T	E	N	T

OHIO
DAYTON
KITE

LANGLEY
CHANUTE
FLYER

FRANCE
ARMY
BICYCLES

GLIDER
NEWSPAPER
PATENT

THE WRIGHT BROTHERS GROW UP

ORVILLE AND WILBUR WRIGHT BOTH FINISHED HIGH SCHOOL. NEITHER OF THEM WENT TO COLLEGE.

ORVILLE BUILT HIS OWN PRINTING PRESS WHILE HE WAS IN HIGH SCHOOL. WILBUR JOINED ORVILLE AND PRINTED A NEWSPAPER.



THE BROTHERS BEGAN RACING AND REPAIRING BICYCLES.

MATH TREASURE HUNT

Follow the directions to find the answer to the Treasure Question - How long did the Wright Flyer stay in the air on its first flight?

WRITE THE NUMERALS

(1) The year of the first flight

ADD

(2) The number of letters of the town where that flight took place.

SUBTRACT

(3) The year Wilbur was born.

DIVIDE BY

(4) Five

MULTIPLY BY

(5) The number of words in the state where the first flight took place.

ADD

(6) The day of the month of the first flight.

MULTIPLY BY

(7) The number of letters in the first name of the oldest brother.

SUBTRACT

(8) The number that stands for bicentennial

ADD

(9) The number of wings on the Flyer

DO YOUR WORK HERE!

ANSWER: _____seconds

1892 THE WRIGHT BROTHERS OPENED A BICYCLE SHOP.
THEY BEGAN TO BUILD AND REPAIR BICYCLES.

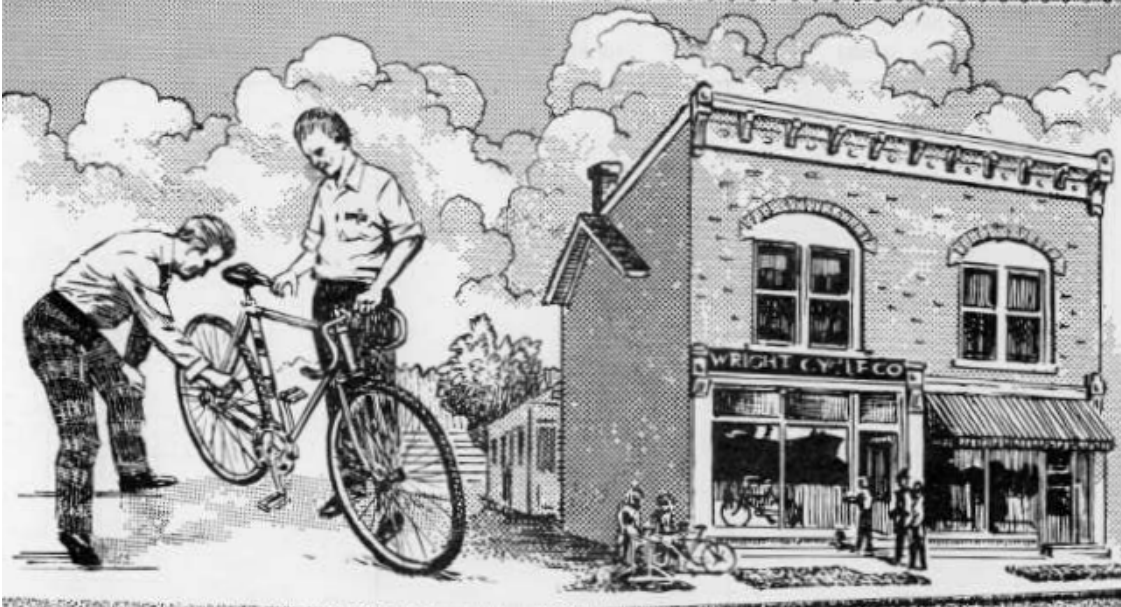

LATER ON, THE BICYCLE SHOP WAS USED TO WORK ON THEIR GLIDERS
AND AIRPLANES.

How many words can you make from WILBUR and ORVILLE WRIGHT?

Nouns (naming words)	Verbs (doing words)	Adjectives & Adverbs (describing words)

1899

THE WRIGHT BROTHERS DECIDED TO
STUDY FLYING.

THEY RECEIVED INFORMATION WRITTEN BY...

Samuel Pierpont Langley and Octave Chanute

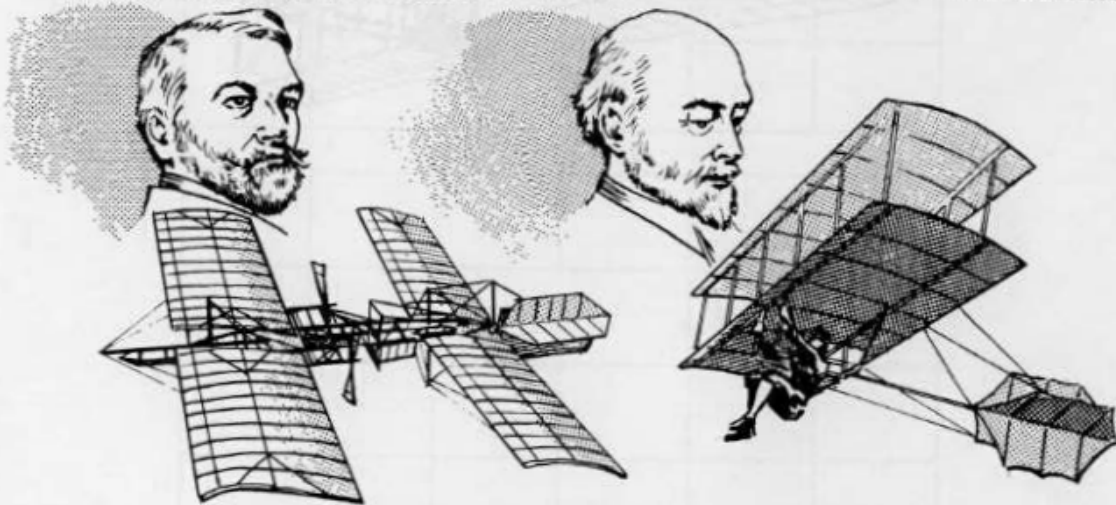

AFTER READING ALL THEY COULD FIND ABOUT FLIGHT,
THE WRIGHT BROTHERS DECIDED TO BUILD A GLIDER.

COPY THE WRIGHT GLIDER

Use the blank grid to draw your own Wright glider.

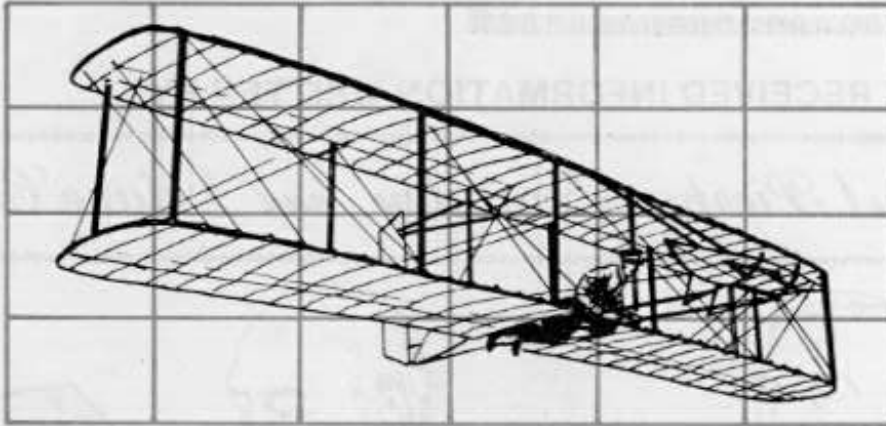

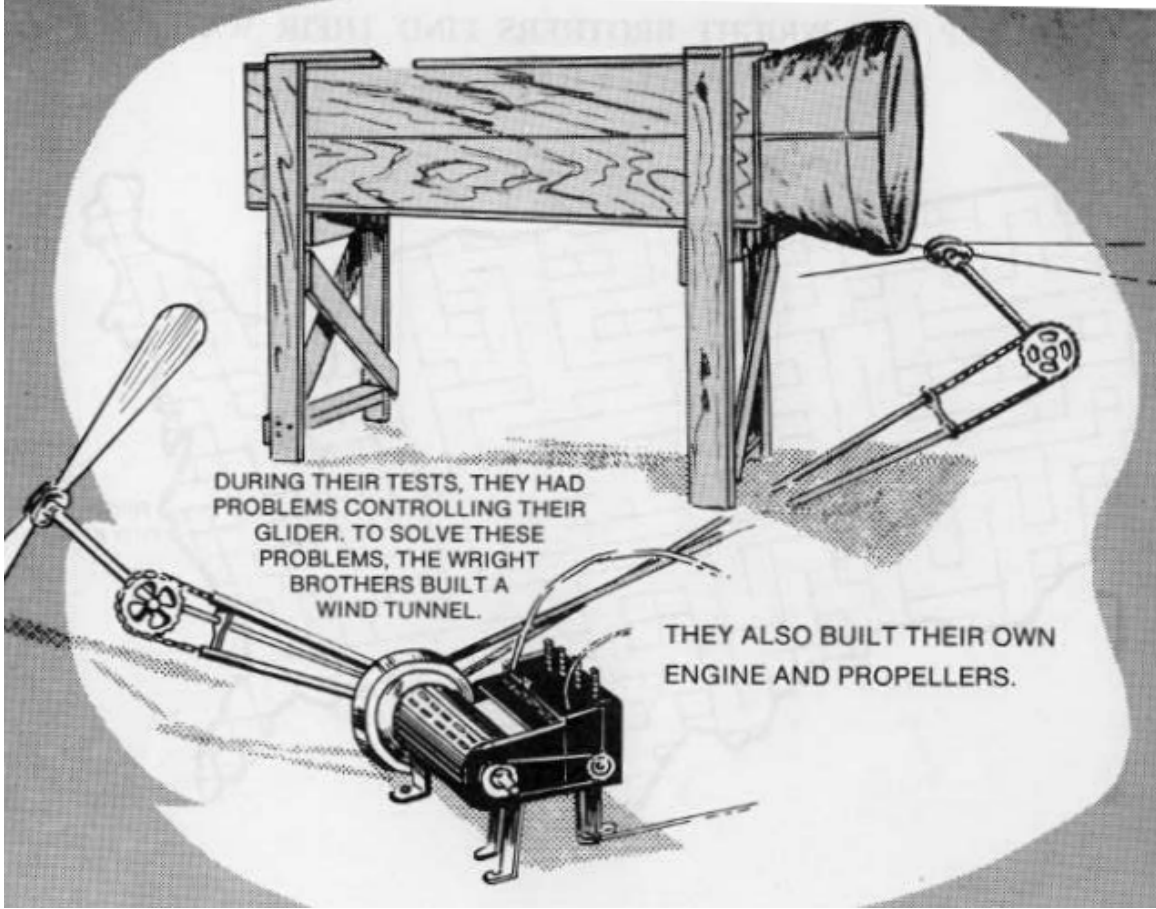

DURING THEIR TESTS, THEY HAD PROBLEMS CONTROLLING THEIR GLIDER. TO SOLVE THESE PROBLEMS, THE WRIGHT BROTHERS BUILT A WIND TUNNEL.

THEY ALSO BUILT THEIR OWN ENGINE AND PROPELLERS.

**HELP THE WRIGHT BROTHERS FIND THEIR WAY TO
KITTY HAWK**

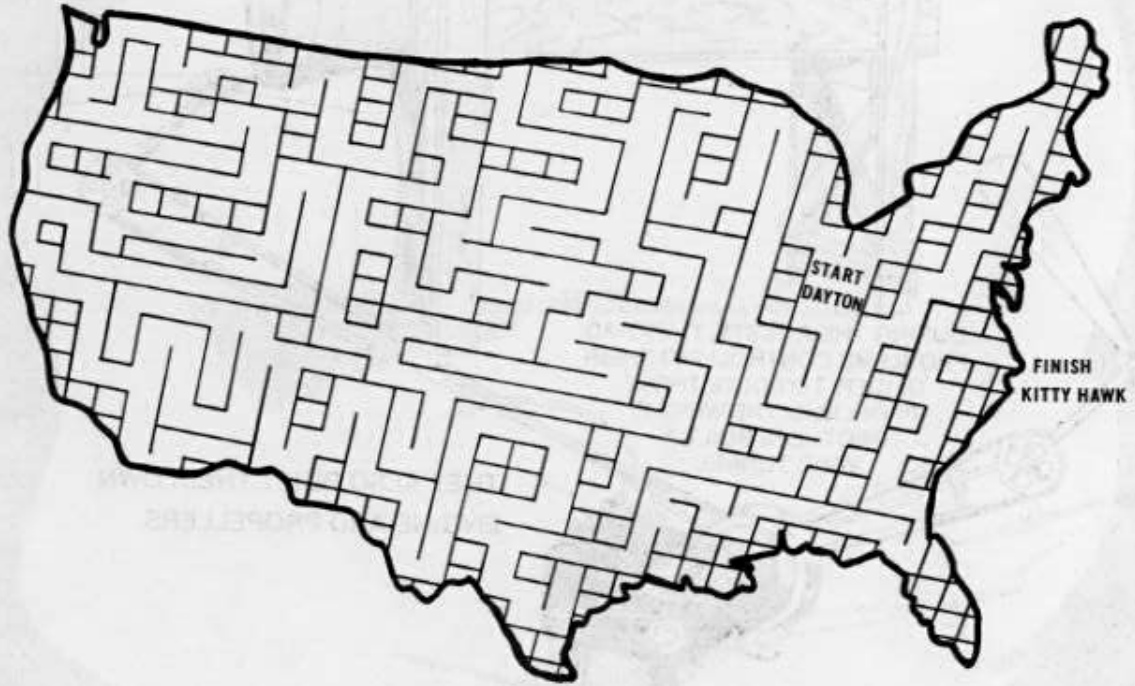

THEY NEEDED A PLACE WHERE THE WIND WAS STRONG AND STEADY TO TEST THEIR GLIDER. THE WEATHER BUREAU SUGGESTED THE SAND DUNES AROUND KITTY HAWK, NORTH CAROLINA.

1901

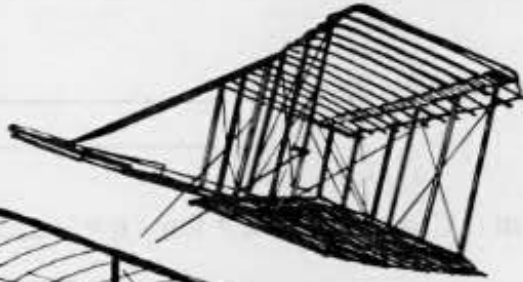

1902

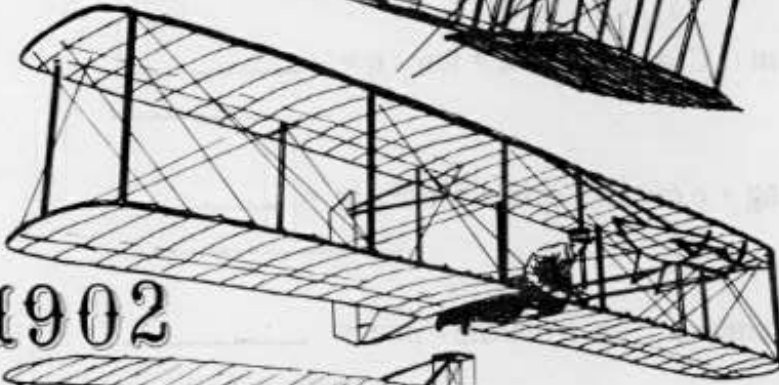

1903

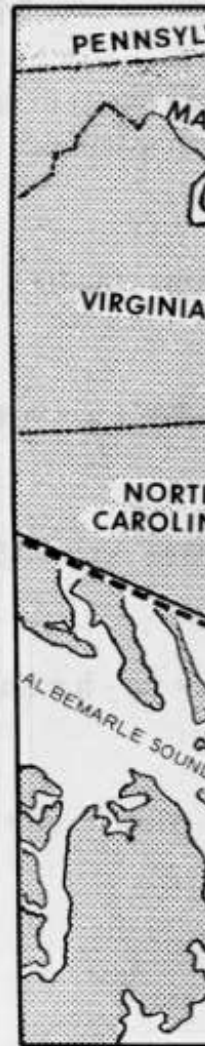
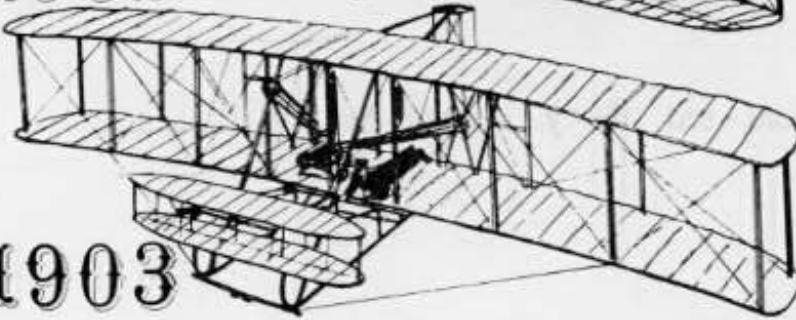

MAKE A WORD

Add and subtract letters to discover important things and people in the Wright brothers' work in aviation.

1. window - ow tundra - dra + nellie - lie = _____

2. October - ober + a + vent - nt Chanel - el + u + ten - n = _____

3. biology - ology + cycling - ing + e cream - eam + maze - m = _____

4. grass - r - s + oh - h + line english - lish + marine - mar = _____

5. pow wow - wow + ere + deed - eed fly - y + mighty - m - y = _____

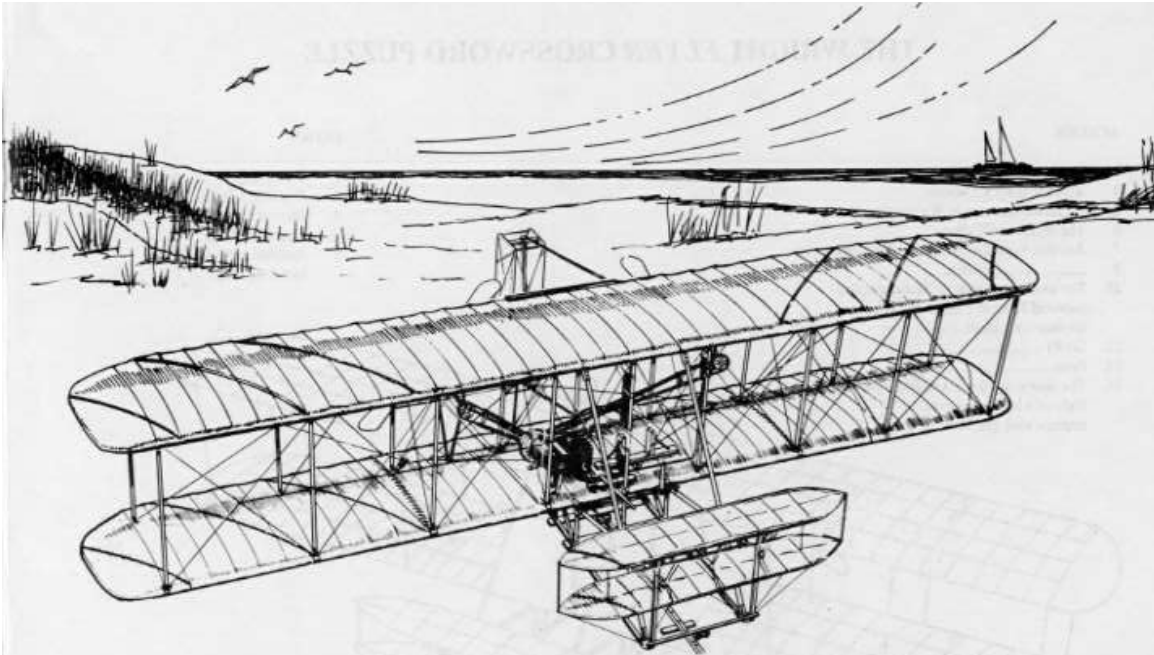

IN THE WINTER OF 1903, THE WRIGHT BROTHERS RETURNED TO NORTH CAROLINA WITH THEIR AIRPLANE WHICH THEY NAMED THE *FLYER*.

The 1903 Wright *Flyer*

ON DECEMBER 17, 1903, THE *FLYER* FLEW SUCCESSFULLY.

THIS WAS THE FIRST CONTROLLED POWERED FLIGHT OF A HEAVIER-THAN-AIR AIRPLANE IN HISTORY.

THE WRIGHT FLYER CROSSWORD PUZZLE

ACROSS

1. The last name of Wilbur.
3. Another word for breezy.
5. A famous museum in Washington, DC.
6. The brother of Wilbur.
7. Another word for creation or discovery.
9. _____ Carolina.
10. The month in which the first controlled powered flight of a heavier-than-air airplane took place.
12. Go fly a _____
13. Paris, _____
14. The season the first controlled powered flight of a heavier-than-air airplane took place.
15. The state where Kitty Hawk is located.
16. Samuel Pierpont _____
17. Octave _____

Down

2. One, _____ three, etc.
4. Opposite of no.
6. Dayton, _____
7. Opposite of out.
8. Another name for a hotel, motel, or lodge.
11. Another name for a bicycle.
14. The lifting part of an airplane.

ANSWERS ON PAGE 20.

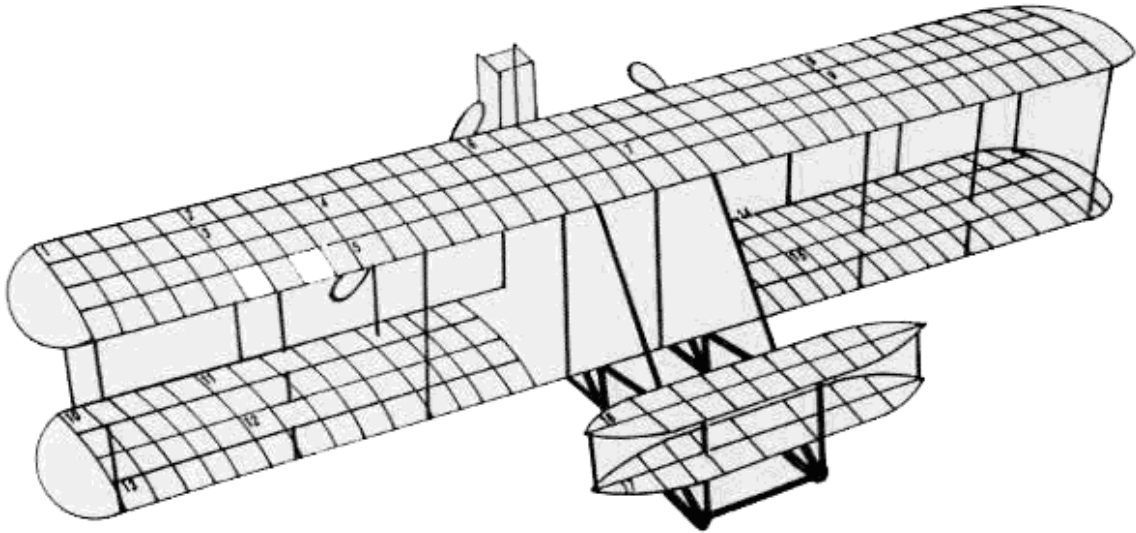

In 1908, the Wrights signed a contract to conduct flight tests for the U.S. Army. The tests were successful and the Army bought one of their airplanes.

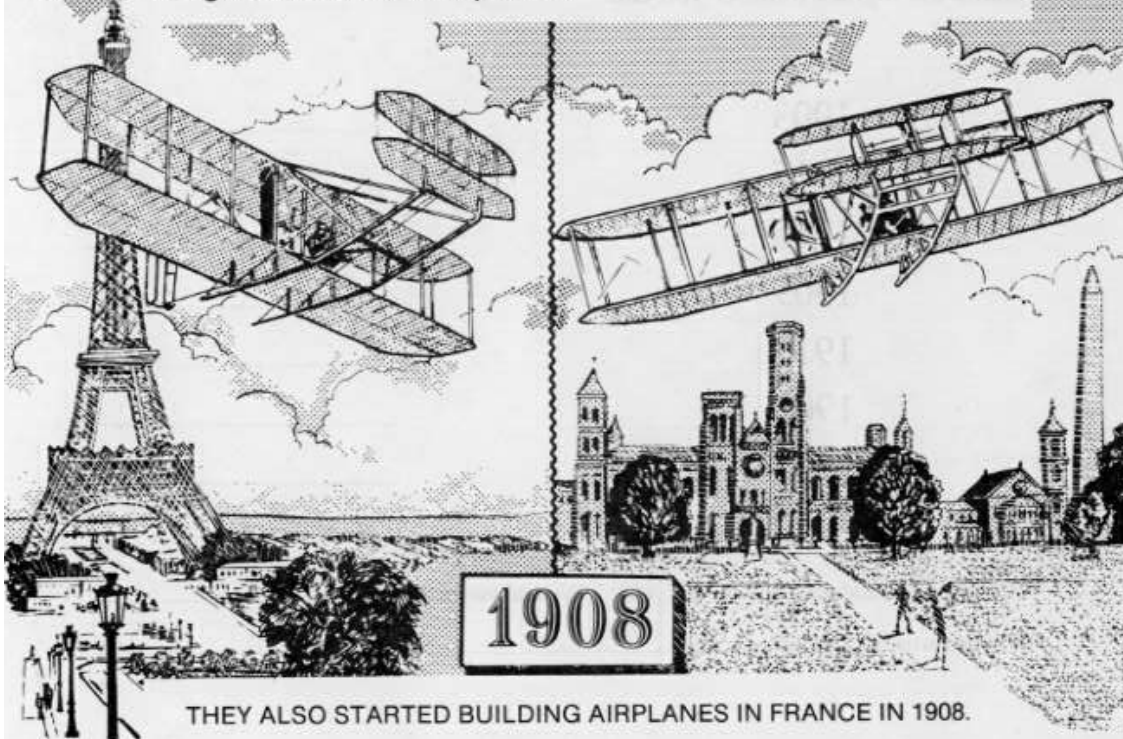

THEY ALSO STARTED BUILDING AIRPLANES IN FRANCE IN 1908.

NUMBER CHALLENGE

Using important dates in the Wright brother's lives, reorganize each number to make the highest number you can.

1903

1917

1915

1909

1910

1908

1907

For added fun, add them all up. Now what is the total number? _____

Can you write it in words? _____

THE WRIGHT BROTHERS
STARTED A NEW APPROACH
TO AVIATION.

WILBUR DIED IN MAY 1912.

ORVILLE WORKED IN HIS PRIVATE
LABORATORY UNTIL HE DIED IN
JANUARY 1948.

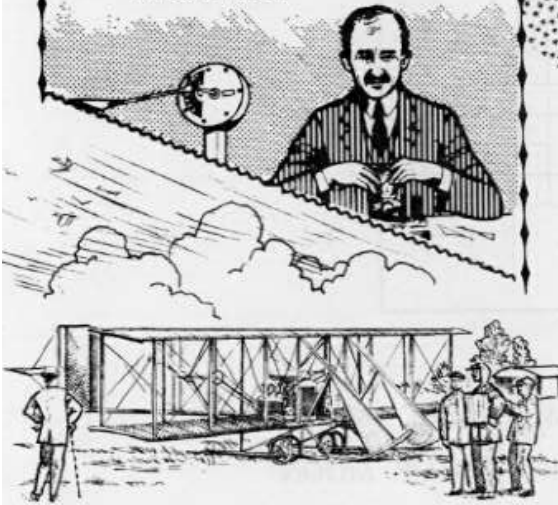

WRIGHTS' 1909 IMPROVED VERSION HAD A
30-HORSEPOWER ENGINE.



POSTER SHOWING THE
FIRST INTERNATIONAL AVIATION
MEET IN THE UNITED STATES.

WRIGHTS' MEMORIAL

Fill in the puzzle with the things shown in the picture.

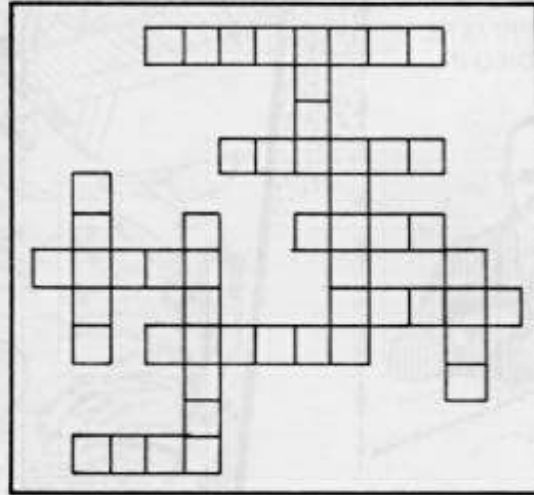

ORVILLE EAGLE KITE HANGAR CLOUD MONUMENT
WILBUR WING FLAG GLIDER MOTOR MOON

ANSWERS TO ACTIVITIES

Pg. 2 SEEK A WORD

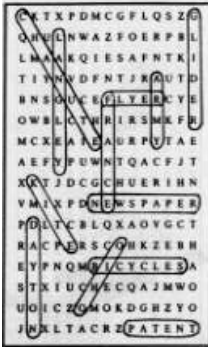

Pg. 4 MATH TREASURE HUNT

$1903 + 9$ (Kitty Hawk) = 1912 - 1867 = 45 ÷ 5 = 9 × 2 (North Carolina)
 $= 18 + 17 = 35 × 6$ (Wilbur) = 210 - 200 = 10 + 2 = 12
 Answer — 12 Seconds

Pg. 12 MAKE A WORD

- 1) wind tunnel
- 2) Octave Chanute
- 3) bicycle craze
- 4) gasoline engine
- 5) powered flight

Pg. 10 HELP THE WRIGHT BROTHERS FIND THEIR WAY TO KITTY HAWK

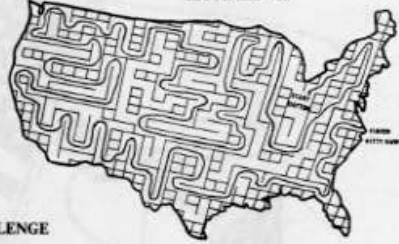

Pg. 16 NUMBER CHALLENGE

9310, 9711, 9511, 9910, 9110, 9810, 9710
 Total = 67,072 — sixty-seven thousand and seventy-two

Pg. 14 THE WRIGHT FLYER CROSSWORD PUZZLE

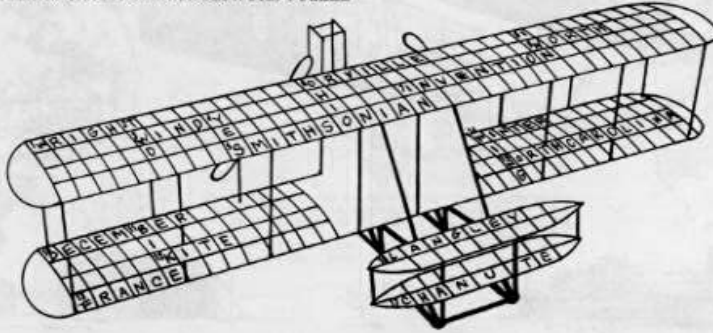

Pg. 18 WRIGHTS' MEMORIAL

